

**OWNER'S INSTRUCTIONS
 MANUAL DE INSTRUCCIONES
 MANUEL D'UTILISATION
 MANUAL DE INSTRUÇÕES
 ISTRUZIONI PER L'USO**

AW06FNAA	AW06A(G)BNAA
AW07FNAA/AB/BA/DA/EA	AW07A(G)BNAA/AB/BA/DA/EA
AW08FNAA/AB	AW08A(G)BNAA/AB
AW09FNAA/BA/CA/DA/EA/EB	AW09A(G)BNAA/BA/CA/DA/EA/EB
AW10FDAA/BA/CA	AW10A(G)BDAA/BA/CA
AW12FDAA/BA/BC/CA/DA/EA/EB/EC	AW12A(G)BDAA/BA/BC/CA/DA/EA/EB/EC
AW14FBMAA/AB/BA/CA/DA/EA	AW14A(G)BMAA/AB/BA/CA/DA/EA
AW18FBMBA/BB/BC/BD/BE/DA/EA/EB	AW18A(G)BMBA/BB/BC/BD/BE/DA/EA/EB
AW18FBMCA/CB/CC	AW18A(G)BMCA/CB/CC
AWT18FBMBA/BB/DA/EA/EB	AWT18A(G)BMBA/BB/DA/EA/EB
AWT19FBMBA/BB/EA/EB	AWT19A(G)BMBA/BB/EA/EB
AWT20FBMBA/BB	AWT20A(G)BMBA/BB
AW22FBMBA/BB/EA/EB	AW22A(G)BMBA/BB/EA/EB
AW24FBMBA/BB/BC/BD/EA/EB	AW24A(G)BMBA/BB/BC/BD/EA/EB
AW24FBMCA/CB/CC/CD	AW24A(G)BMCA/CB/CC/CD
AWT24FBMBA/BB/EA/EB/EC	AWT24A(G)BMBA/BB/EA/EB/EC

Window-type Room Air Conditioner (Cool)
Acondicionador de aire doméstico sistema de tipo ventana (Refrigeración)
Climatiseur de type Fenêtre (Refroidissement)
O ar Condicionado de Window-Type (Refrigeração)
Condizionatore d'aria per ambienti da finestra (Raffreddamento)

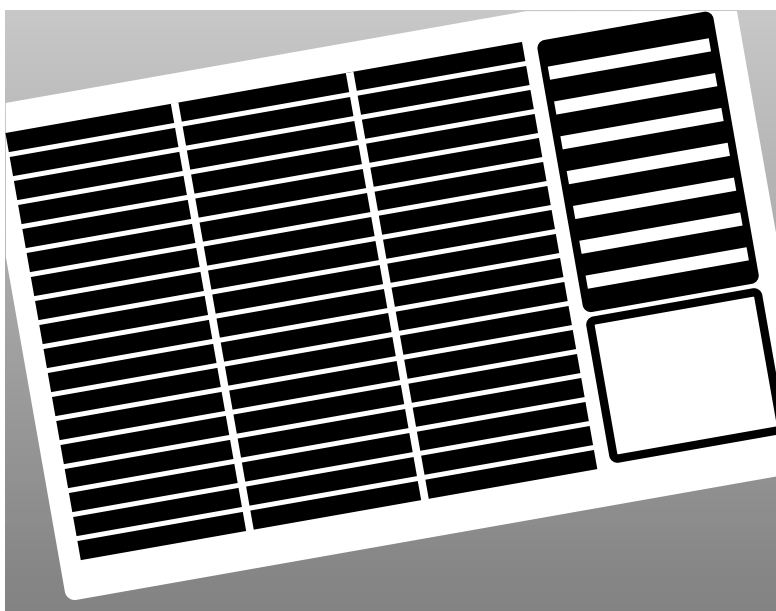

Safety Precautions

The following safety precautions must be taken when installing and using your air conditioner.

1 The air conditioner must be plugged into its own specific power source, which must be installed in compliance with national wiring, earthing and safety regulations.

Depending on national regulations and your specific installation, you may need to install:

- ◆ A circuit breaker

For further information on electrical requirements, contact a professional electrician.

This device must be installed according to the national electrical rules.

2 Make sure that the unit is correctly ventilated at all times; do NOT place clothing or other materials over it.

3 NEVER spill liquids of any kind into the unit. Should this happen, unplug the unit and contact your installation specialist.

4 Do NOT insert anything between the air outlet blades, as it may damage the inner fan and you may be hurt. Keep children away from the unit.

5 ALWAYS ensure that the power cable is in good condition. If the power cord is damaged in any way, it must be replaced by the manufacturer or its service agent or a similarly qualified person in order to avoid a hazard.

6 Do NOT attempt to repair the unit yourself. If it is damaged in any way, contact:
◆ An authorized service center
◆ The dealer from whom you purchased the air conditioner.

7 Do NOT place any blocking objects in front of the unit.

8 If the remote control will not be used for a long time, remove the batteries.

9 Before throwing out the device, it is necessary to pull back the battery cells and get rid of them safely.

CAUTION

The manufacturer does not assume responsibility for accidents or injury caused by an incorrectly installed air conditioner. If you are unsure about installation, contact an installation specialist.

Contents

◆ PREPARING YOUR AIR CONDITIONER	
■ Safety Precautions	2
■ Air Conditioning Unit - Main Parts, Buttons and Display	4
■ Remote Control Buttons	5
■ Getting Started	6
■ Inserting the Remote Control Batteries	7
◆ OPERATING YOUR AIR CONDITIONER	
■ Cooling Your Room	8
■ Airing Your Room	9
■ Adjusting the Air Flow Direction Horizontally	10
■ Adjusting the Air Flow Direction Vertically	10
◆ PROGRAMMING YOUR AIR CONDITIONER	
■ Setting the On Timer	11
■ Setting the Off Timer	12
■ Setting the Sleep Timer	13
■ Selecting Energy Saving mode	14
◆ RECOMMENDATIONS FOR USE	
■ Operating Recommendation	14
■ Temperature and Humidity Ranges	14
■ Cleaning Your Air Conditioner	15
■ Solving Common Problems	17
■ Technical Specifications	18
◆ INSTALLATION	19

CAUTION

" The high inrush current of the starting compressor motor can have adverse effects to the operation of other equipment under unfavorable mains conditions. This equipment does not comply with the relevant technical standards for the limitation of voltage fluctuations and flicker."

Before connecting this equipment to the power supply system, please report to your supply authority and obtain the consent.

Do not connect other electric appliances to the same supply lines.

AW18**

The maximum permissible system impedance at the power junction box is 0.24 ohms. Usually, the maximum permissible mains impedance will not be exceeded when the branch to the power outlet is fed from a junction box with a rated current of 32A.

Air Conditioning Unit - Main Parts, Buttons and Display

- * The design and shape are subject to change according to the model.
- * If a power failure occurs when the air conditioner is operating, the unit is switched off. Then the power returns, the air conditioner starts up again automatically.

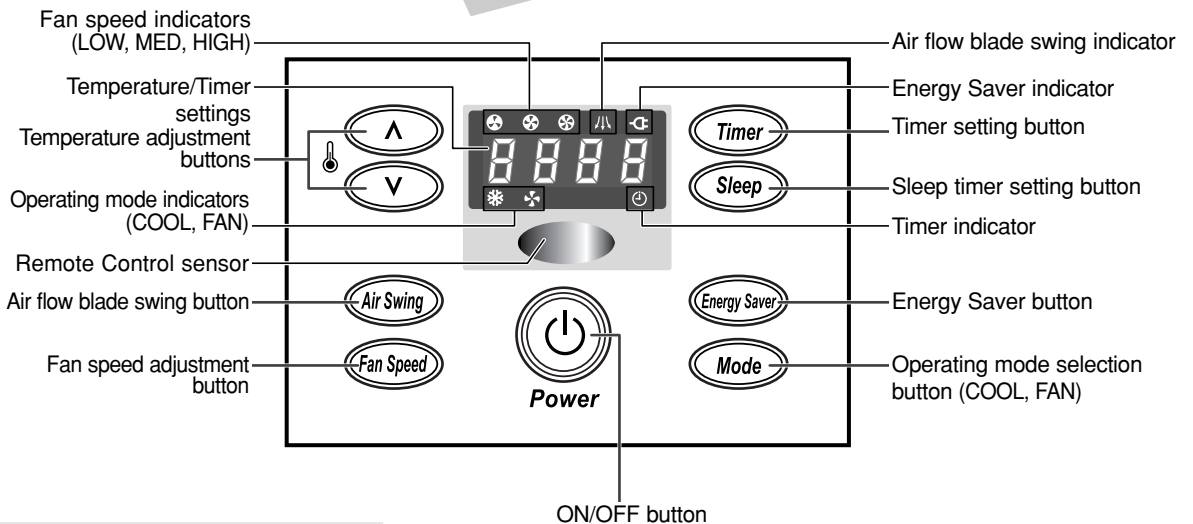
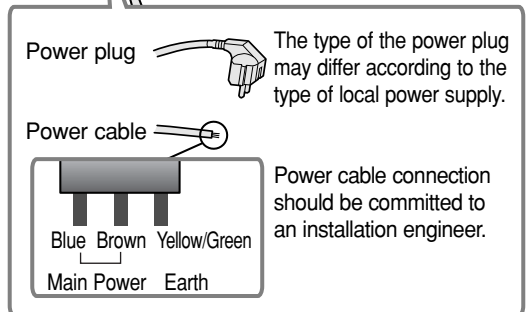
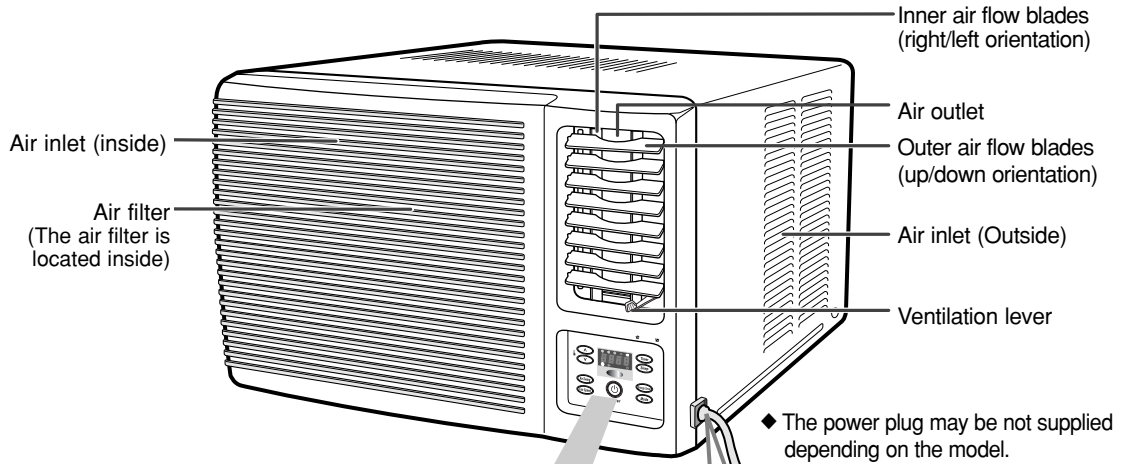

Remote Control - Buttons

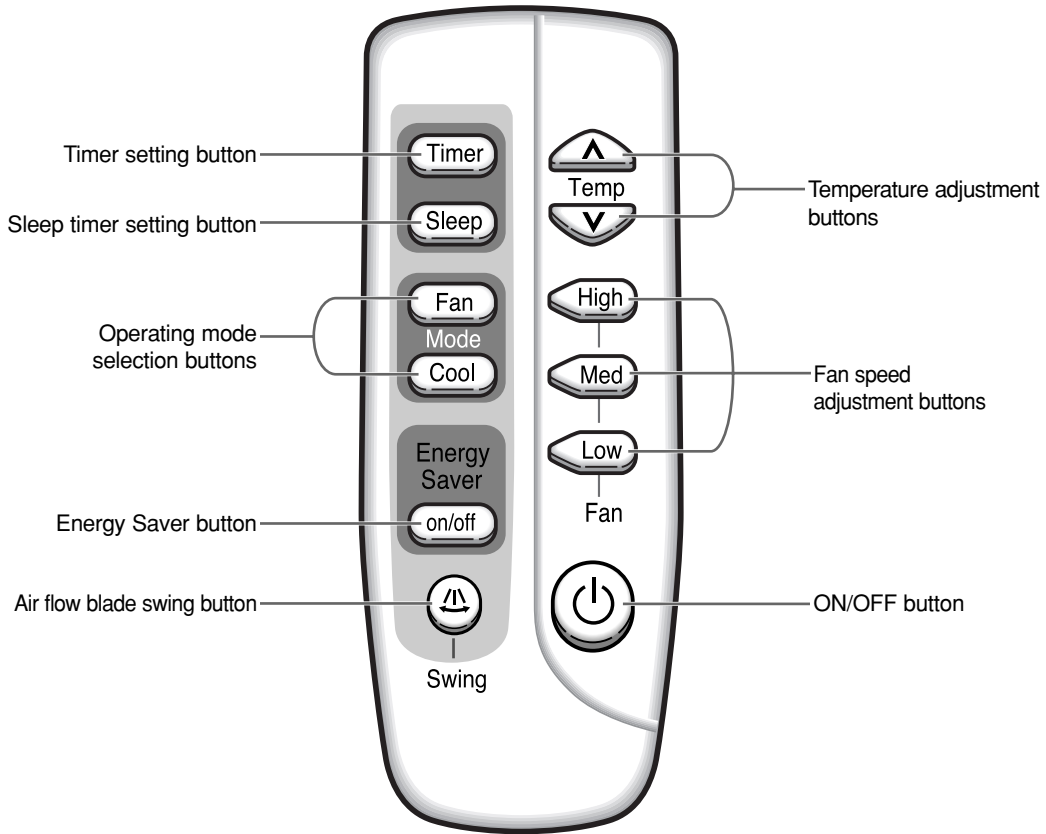

Getting Started

You have just purchased a window-type room air conditioner and it has been installed by your installation specialist.

Your Owner's Instructions contain valuable information on using your air conditioner. Please take the time to read them as they will help you take full advantage of the unit's functions.

This Owner's Instructions is just for using your air conditioner correctly. Thus, the illustrations shown in this manual may not exactly match your air conditioners.

The booklet is organized as follows.



- ◆ **The following figures are shown on pages 4 and 5:**
 - **Air conditioning unit (main parts, buttons and display)**
 - **Remote control (buttons)**

They will help you find the buttons and understand the symbols displayed.
- ◆ **In the main part of the document, you will find a series of step-by-step procedures for each function available.**

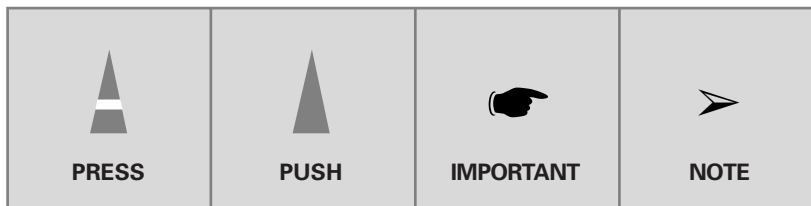
The illustrations in the step-by-step procedures use four different symbols:



Moreover, applicable, wherever the illustrations show the positions of the buttons on both the remote control and the unit itself.

For the...	The illustrations have a...
Remote control	Gray background. Example: 
Unit itself	White background. Example: 

Inserting the Remote Control Batteries

You must insert or replace the remote control batteries when:

- ◆ **You purchase the air conditioner**
- ◆ **The remote control does not work correctly**



Use two AAA, LR03 1.5 V batteries. Do not use old batteries or different kinds of batteries together.

Batteries may be completely discharged after 12 months, even if they have not actually been used.

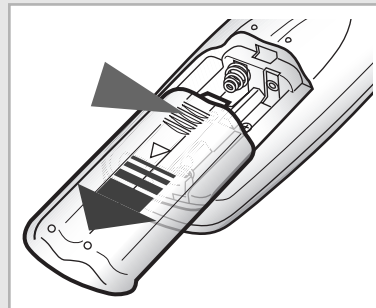

1 Push the battery cover on the rear of the remote control with your thumb in the direction of the arrow and remove it.

2 Insert the two batteries, taking care to respect the polarities:

- ◆ + on the battery with + on the remote control
- ◆ - on the battery with - on the remote control

3 Close the cover by sliding it back until it clicks into place.

Result: You can control all the functions on your air conditioning unit directly from your seat, using the remote control.

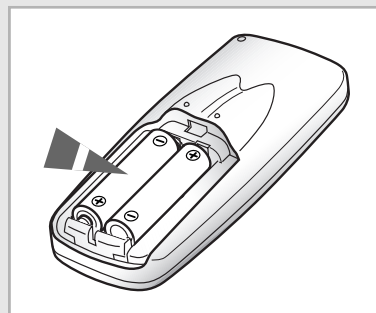

Cooling Your Room

Remote Control

Control Panel

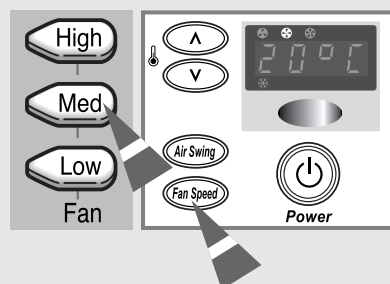
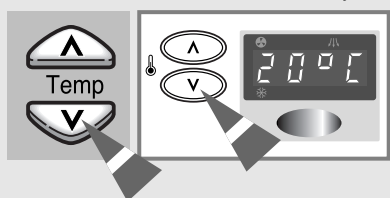
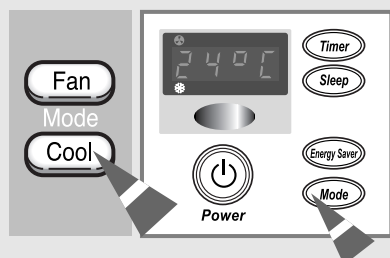

You must select the Cool mode if you wish to lower the temperature in your room. You can also set the fan speed.

- 1 If necessary, press the (On/Off) button.
Result:
 - ◆ The operating mode indicator (COOL or FAN) on the unit comes on.
 - ◆ The air conditioner starts up in the mode selected when the unit was last used.
 - ◆ The unit beeps twice.

The air conditioner is fitted with a protection mechanism to prevent the unit from being damaged when it is started immediately after being:

- ◆ Plugged in
- ◆ Stopped

It will start up automatically after about three minutes.

- 2 If the COOL indicator is not lit up on the unit:
 - ◆ Press the button on the remote control
 - or
 - ◆ Press the MODE button on the unit one or more times until the COOL indicator lights upResult:
 - ◆ The unit beeps each time you press MODE.
 - ◆ The air conditioner starts up in Cool mode.

➤ You can change modes at any time.

- 3 To adjust the temperature, press the or button on the remote control one or more times until the required temperature is displayed. To adjust the temperature, press the or button on the unit one or more times until the required temperature is displayed.
 Possible temperatures are between 18°C and 30°C inclusive.
Result:
 - ◆ Each time you press the temperature buttons:
 - The temperature is adjusted by 1°C and displayed on the control panel
 - The unit beeps
 - ◆ The air conditioner starts cooling if the room temperature is higher than the selected temperature.

4 To set the fan speed to... Then...

- | | |
|------|---|
| High | <ul style="list-style-type: none"> ◆ Press the button on the remote control. or ◆ Press the on the unit until the indicator lights up |
| Med | <ul style="list-style-type: none"> ◆ Press the button on the remote control. or ◆ Press the on the unit until the indicator lights up |
| Low | <ul style="list-style-type: none"> ◆ Press the button on the remote control. or ◆ Press the on the unit until the indicator lights up |

Result: Each time you press a button, the unit beeps.

- 5 To control the direction of the air flow, refer to page 10.

Airing Your Room

If the atmosphere in your room is stale, you can air it using the Fan feature and if necessary, evacuate the stale air outside.

- 1 If you wish to evacuate stale air outside, push the ventilation lever on the front of the unit to the right and the open position ().

Result: The air inside the room circulates and stale air is evacuated outside.

Otherwise, push the ventilation lever to the left and the closed position ().

Result: The air simply circulates inside the room.

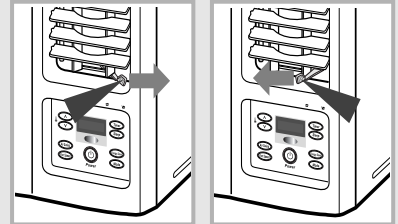

Remote Control

Control Panel



- 2 If necessary, press the  (On/Off) button.

- Result:**
- ◆ The operating mode indicator (COOL or FAN) on the unit comes on.
 - ◆ The air conditioner starts up in the mode selected when the unit was last used.
 - ◆ The unit beeps twice.

- 3 If the FAN indicator is not lit up on the unit:



- ◆ Press the  button on the remote control
- or
- ◆ Press the MODE button on the unit one or more times until the FAN indicator lights up

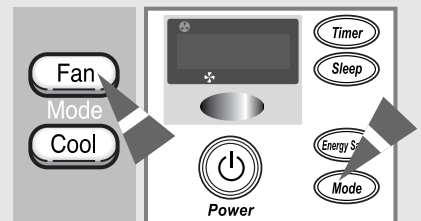

- Result:**
- ◆ The unit beeps each time you press MODE.
 - ◆ The air conditioner starts up in Fan mode.



-
- ◆ You can change modes at any time.
 - ◆ When the air conditioner is in Fan mode, the temperature is not displayed; in this case, you do not need to set the temperature.



- 4 **To set the fan speed to... Then...**

- High
- ◆ Press the  button on the remote control.
 - or
 - ◆ Press the  on the unit until the  indicator lights up

- Med
- ◆ Press the  button on the remote control.
 - or
 - ◆ Press the  on the unit until the  indicator lights up

- Low
- ◆ Press the  button on the remote control.
 - or
 - ◆ Press the  on the unit until the  indicator lights up

Result: Each time you press a button, the unit beeps.

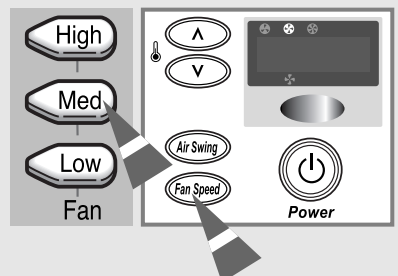



- 5 To control the direction of the air flow, refer to page 10.

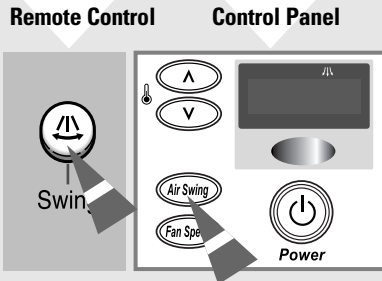

Adjusting the Air Flow Direction Horizontally





Depending on the position of the unit in your room, you can adjust the orientation of the inner air flow blades on the right-hand side of the unit, thus increasing the efficiency of the air conditioner.

- 1 Press the  (or  on the unit) button on the remote control.

Result: The inner blades swing automatically left and right.

- 2 To stop the blades moving left and right, press the  (or  on the unit) button on the remote control.

- To stop the blades in a specific position and orient the air flow in the corresponding direction, simply press the  (or  on the unit) button on the remote control when the blades are in the desired position.

Adjusting the Air Flow Direction Vertically

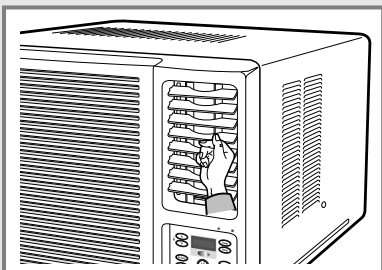

Again depending on the position of the unit in your room, you can adjust the orientation of the outer air flow blades on the right-hand side of the unit.



RECOMMENDATION	When...	Adjust the blades to face...
	Cooling	Upwards.

Adjust the air flow blades to the desired position, by pushing them upwards or downwards.

- If you orient the air flow blades downwards and the unit operates in Cool mode for a long period of time, dew may:
 - ◆ Form on the surface of the blades
 - ◆ Drip from the blades

Setting the On timer

The On Timer enables you to switch on the air conditioner automatically after a given period time. You can set the period of time from 1 hour to 24 hours. You can select the On timer only when the air conditioner is off.

- 1 Check that the air conditioner has been switched off; if necessary, press the  (On/Off) button.
- 2 Set the required mode by pressing the appropriate button:
 - ◆  or  on the remote control
 - ◆ Mode button on the unit (press it one or more times until the appropriate operating mode indicator lights up)

- 3 Set the operating time by pressing:
 - ◆ Timer on the remote control.
 - or
 - ◆ Timer on the unit one or more times.

Possible time is between 1 hour and 24 hour inclusive.

- Result:**
- ◆ The remaining time is displayed and decreased by 1 hour automatically to indicate the remaining time.
 - ◆ The air conditioner switches on automatically when the operating time reaches zero.

- You can change the setting mode, fan speed, and air flow direction after setting the On timer.

Remote Control



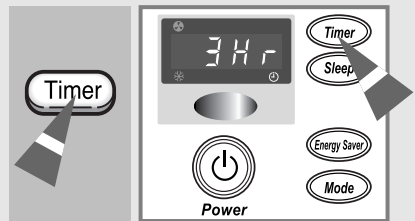
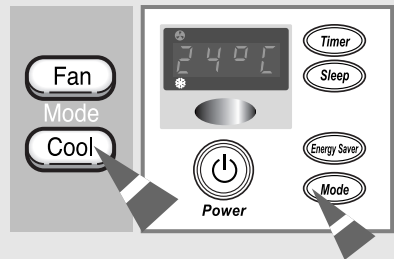
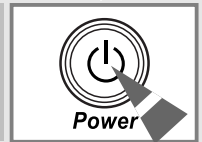

Control Panel



To Cancel the On Timer

To cancel the timer, press:

- ◆ Timer on the remote control or unit one or more times until "  " is displayed.
- or
- ◆  on the remote control or unit (The air conditioner operates in the mode selected when the unit was last used.)

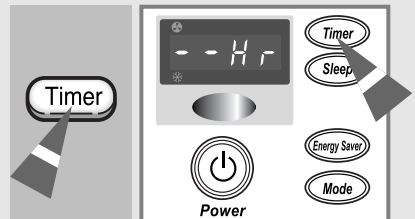

Setting the Off Timer

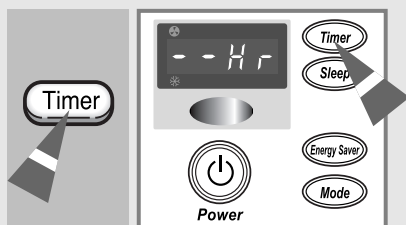
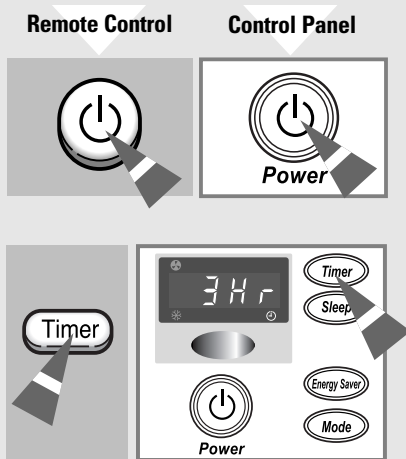

The Off Timer enables you to switch off the air conditioner automatically after a given period of time. You can set the period of time from 1 hour to 24 hours.

You can select the Off timer only when the air conditioner is on.

- 1 Check that the air conditioner has been switched on; if necessary, press the  (On/Off) button.

- 2 Set the operating time by pressing:
 - ◆ Timer on the remote control
 - or
 - ◆ Timer on the unit one or more times.



Possible times are between 1 hour and 24 hour inclusive.

- Result:**
- ◆ The remaining time is displayed and decreased by 1 hour automatically to indicate the remaining time.
 - ◆ The air conditioner switches off automatically when the operating time reaches zero.

- You can change the setting mode, fan speed, and air flow direction after setting the Off timer.

To Cancel the Off Timer

To cancel the timer, press:



- ◆ Timer on the remote control or unit one or more times until "  " is displayed.
- or
- ◆  on the remote control or unit (The air conditioner operates in the mode selected when the unit was last used.)

Setting the Sleep timer

The Sleep Timer can be used when you are cooling your room to switch the air conditioner off automatically after a period of 8 hours.

➤ If you wish to switch the unit off at a specific time, refer to page 12.

1 Make sure that you have selected either COOL mode.

2 Press the  button on the remote control
or
Press the  button on the unit.

- Result:**
- ◆ Each time you press a button, the unit beeps.
 - ◆ The "SLEEP" passes through the control panel for about 15 seconds and the "8 H 8" will be displayed.
 - ◆ The remaining time is displayed and decreased by 1 hour automatically to indicate the remaining time.
 - ◆ The air conditioner will be controlled as illustration below.

Cooling When the temperature has been increased by 1°C (after 1 hour), it is maintained for 7 hours.

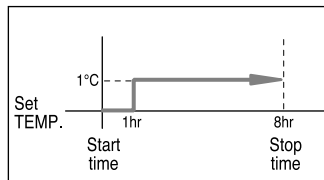

Remote Control



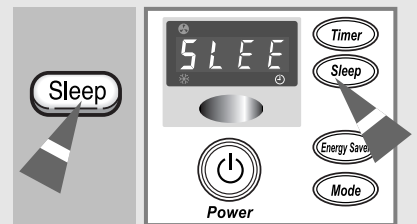
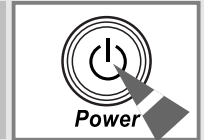

Control Panel



To Cancel the Sleep Timer

To cancel the timer, press:

- ◆  on the remote control.
- or
- ◆  on the unit.

- Result:**
- ◆ The unit beeps.
 - ◆ The SLEEP indicator is no longer displayed.
 - ◆ The air conditioner operates in the mode selected last.

➤ If you select the Energy Saving mode in the Sleep Timer mode, the Sleep Timer will be cancelled and the air conditioner will start up in the Energy Saving mode.

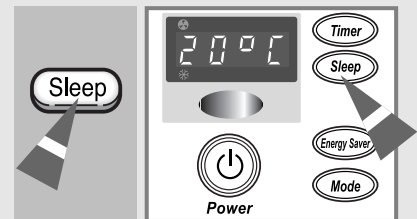

Selecting Energy Saving mode

Remote Control

Control Panel

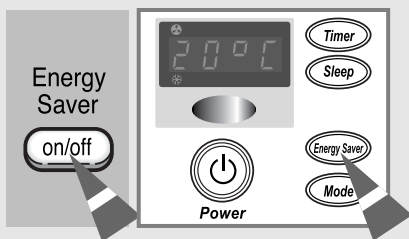
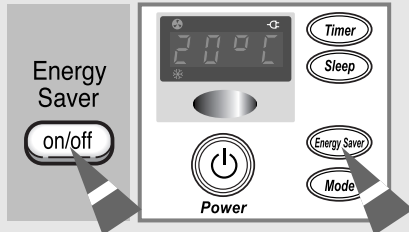

If you wish to save energy when using your air conditioner, select the energy saving mode with the Energy Saver button.

- 1 To select the energy saving mode, press the Energy Saver button on the remote control or unit one or more times until the Energy Saver indicator lights up.

Result:

- ◆ The fan and compressor cycle on and off together.
- ◆ The fan will continue to run for a short time after the compressor cycles off.

➤ If you would like the air conditioner to run in Fan mode, do not press the Energy Saver button. You cannot use the Fan mode in the energy saving mode.

- 2 To stop the energy saving mode, press the Energy Saver button on the remote control or unit again.

Result: The fan runs at all times, while the compressor cycles on and off.

➤ If you select the Sleep Timer in the Energy Saving mode, the Energy Saving will be cancelled and the air conditioner will start up in the Sleep Timer mode.

Operating Recommendations

Here are a few recommendations that you should follow when using your air conditioner.

Topic	Recommendation
Power failure	If a power failure occurs when the air conditioner is operating, the unit is switched off. When the power returns, the air conditioner starts up again automatically.

Temperature and Humidity Ranges

The following table indicates the temperature and humidity ranges within which the air conditioner can be used.

Mode	Indoor Temperature	Outdoor Temperature	Indoor Humidity
Cooling	21°C to 32°C approx.	21°C to 43°C approx. 21°C to 54°C approx.(Middle East)	80% or less

If the air conditioner is used at...	Then...
Higher temperatures	The automatic protection feature may be triggered and the air conditioner stopped.
Lower temperatures	A water leakage or some other malfunction may happen if the heat exchanger freezes.
Higher humidity levels	Water may condense on and drip from the surface of the unit if it is used for long periods.

Cleaning Your Air Conditioner (****FB**** models)

Be sure to clean the air filter periodically to maintain the air conditioner in the best condition for a long period of time.

IMPORTANT When cleaning the air conditioner, turn it off and pull out the power plug.

1 Hold the air filter handle, slightly pull it to the left side and open the front grille.

- The removal of the front grille makes it easier to clean the air conditioner. Open the grille as much as possible.

CAUTION

Removal and Reassembly of the Front Grille

For user's safety, a safety clip has been installed in the front grille.

- 1 Grasp the lower part of the front grille and the air filter handle, then open the grille.
- 2 Remove the safety clip and the front grille.
- 3 When reassembling the front grille, you should install the safety clip again.

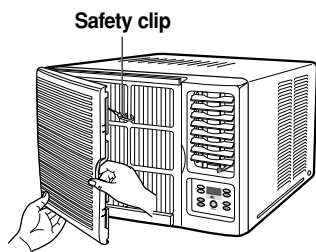

2 Pull the air filter to the right side.

3 Remove all dust on the air filter with a vacuum cleaner or brush.

4 When you have finished, insert the air filter back into its original position.

5 Wipe the surface of the unit with a neutral detergent and then wipe it again with dry cloth.
(Be sure not to use benzene, solvent or other chemical products.)

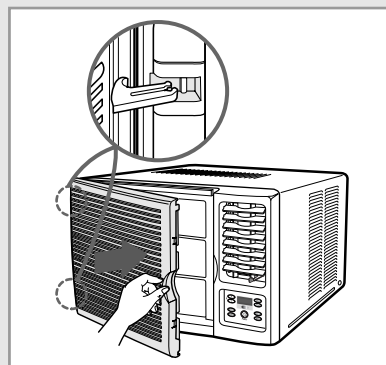
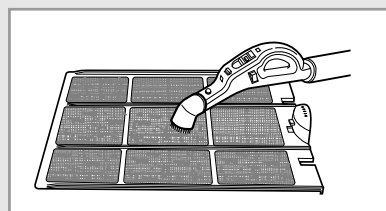
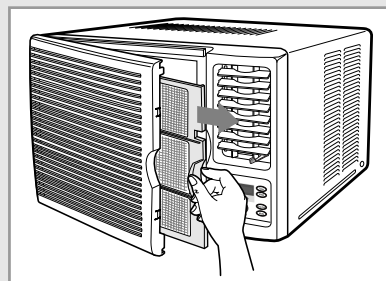

The air conditioner has two or three grille grooves depending on the model.

If you...	Then...
Will not be using the air conditioner for a long period of time	<ul style="list-style-type: none"> ◆ Set the fan going for a few hours to dry the inside of the air conditioner thoroughly. ◆ Switch the air conditioner off and unplug it from the wall socket. ◆ Clean the filter and outer surfaces.
Have not used the air conditioner for a long period of time	Set the fan going for a few hours to dry the inside of the air conditioner thoroughly.

Cleaning Your Air Conditioner (***AB/GB*** models)

Be sure to clean the air filter periodically to maintain the air conditioner in the best condition for a long period of time.

 **When cleaning the air conditioner, turn it off and pull out the power plug.**

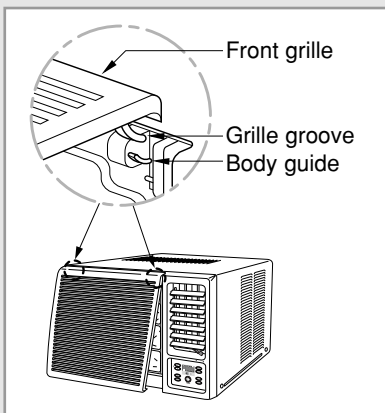
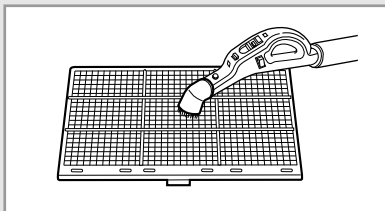
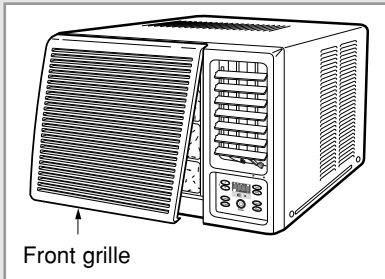





- 1 Open the front grille by pulling on the tabs of the unit.
 - The removal of the front grille makes it easier to clean the air conditioner. After opening the front grille, lift it up as much as possible, then pull down to release it.
- 2 Grasp the handle on the air filter and lift it slightly and then out to the front.
- 3 Remove all dust on the air filter with a vacuum cleaner or brush.
- 4 When you have finished, insert the air filter back into its original position.
- 5 Wipe the surface of the unit with a neutral detergent and then wipe it again with dry cloth.
(Be sure not to use benzene, solvent or other chemical products.)

➤ If you...	Then...
Will not be using the air conditioner for a long period of time	<ul style="list-style-type: none"> ◆ Set the fan to "FAN" and let it for a few hours to dry the inside of the air conditioner thoroughly. ◆ Switch the air conditioner off and unplug it from the wall socket. ◆ Clean the filter and outer surfaces.
Have not used the air conditioner for a long period of time	Set the fan to "FAN" and let it run for a few hours to dry the inside of the air conditioner thoroughly.

Solving Common Problems

Before contacting the after-sales service, perform the following simple checks. They may save you the time and expense of an unnecessary service call.

Problem	Explanation/Solution
The air conditioner does not operate at all	<ul style="list-style-type: none"> ◆ Check that the circuit breaker used for the air conditioner has not been triggered. ◆ Check that the power cable is plugged into a wall socket and the socket is switched on, if necessary. ◆ Check that the operating mode indicator (COOL or FAN) on the unit is lit up; if necessary press  (On/Off) on the remote control or unit.
The air conditioner does not operate with the remote control	<ul style="list-style-type: none"> ◆ Check that there are no obstacles between you and the unit. ◆ Replace the remote control batteries if necessary. ◆ Check that you are close enough to the unit (seven metres/yards or less).
No beep is heard when you press  (On/Off) on the remote control	<ul style="list-style-type: none"> ◆ Check that you are pointing the remote control at the remote control sensor on the unit. ◆ Replace the remote control batteries if necessary.
The air conditioner does not cool	<ul style="list-style-type: none"> ◆ Check that the correct operating mode has been selected COOL. ◆ The room temperature may be too low. ◆ Dust may be blocking the air filter; refer to page 15 or 16 for cleaning instructions. ◆ Check that there is no obstacle blocking the air flow into or out of the unit.
The air flow direction does not change when you press the  (or  on the unit) button	<ul style="list-style-type: none"> ◆ Check that the air conditioner has been switched on; if necessary, press  (On/Off) on the remote control or unit.
The timer is not correctly triggered	<ul style="list-style-type: none"> ◆ Check that the timer has been programmed correctly; see page 11~13.
Odours are permeated in the room during air conditioning	<ul style="list-style-type: none"> ◆ Air the room.

Technical Specifications

Design and specifications are subject to change without notice.

Model	Power Supply
*****AA/AB	115V~, 60Hz
*****BA/BB/BC/BD/BE	220V~, 60Hz
*****CA/CB/CC/CD	230-208V~, 60Hz
*****DA	200-220V~, 50Hz
*****EA/EB/EC	220-240V~, 50Hz

Installation (for 60Hz)

1 Electrical Requirements

For personal safety:

- ◆ This appliance must be properly grounded.
- ◆ Do not, under any circumstances, cut or remove the third grounding prong from the power cord.
- ◆ We recommend that you do not use an extension cord or an adapter plug with this appliance.
- ◆ Do not change the plug on the power cord of this appliance.
- ◆ Follow national electrical codes or local codes and ordinances.

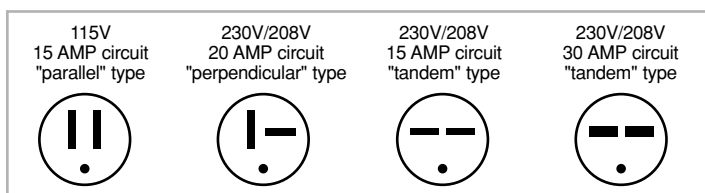

- ◆ If the electric supply provided does not meet the above specifications, call a licensed electrician.
- ◆ Aluminum house wiring may pose special problems - consult a qualified electrician.
- ◆ This unit requires a separate circuit, serving only this appliance.

Installation

Before installation, be sure to check the installation area or the air conditioner, and drain hose.

Checkpoints prior to installation

- 1 Check the cabinet and front grille of the unit for any harmful defects such as scratches.
- 2 Be sure to check the power supply.
 - Refer to the specifications on the label attached to the unit.

Installation Conditions

- 1 As the unit is heavy, the wall or window of the installation area should have sufficient strength and durability for operation of the air conditioner, and for prevention of any vibration or noise. If it is weak, reinforcement work should be performed separately.
- 2 It is advisable to install the air conditioner in the north or west side to prevent the effect of direct sunlight. When installing it in the south or east side due to unavoidable circumstances, it is advisable to install the sunshade to prevent the direct sunlight. In this case, take care not to cause any hindrance to the flow of outside air.
- 3 When installing the air conditioner, be sure to obtain sufficient space on the rear side of the unit for smooth flow of air. When operating the air conditioner in closed areas such as inner building with cooling operation, and result in trouble with the unit. See the illustration below.

◆ The appliance must be fixed well by screw or similar method.

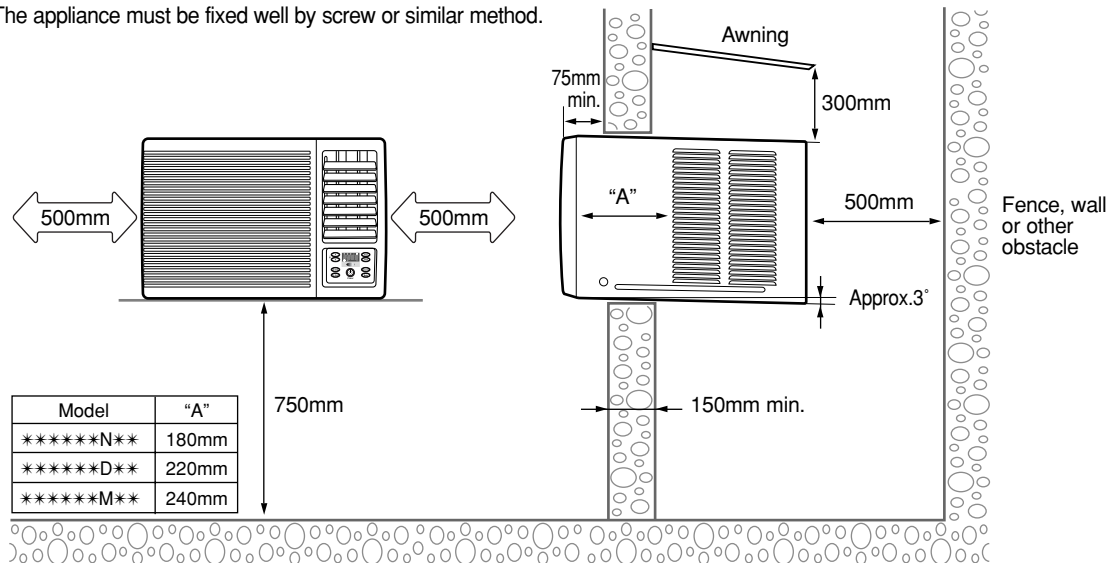

◆ If the wall is greater than 150mm thick, cut the wall back on a 45° angle if possible.

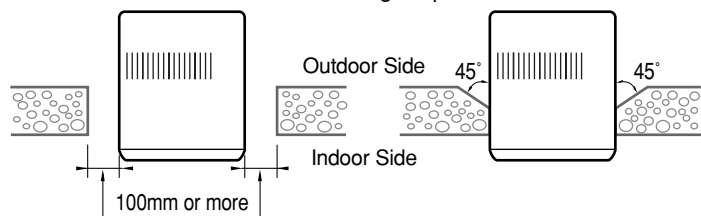

Installation of the Drain Tube

Fix the drain tube as shown in the figure.

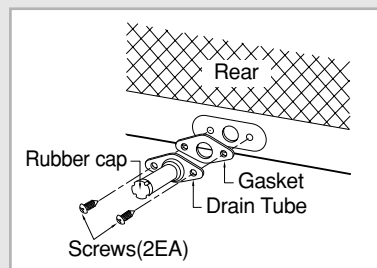

Installation of the Drain Pan

The procedure for installing the drain pan should be determined by the condition of the installing area.

◆ **In the case of an area where the drain pan can not be directly installed on the rear side of the unit after installing the air conditioner.**

Example: High storage

- 1 Open the front grille ; refer to page 15 or 16.
- 2 **Remove the screw located at the lower section of the front grille. It is secured in the  section depending on the model.**

- 3 Remove the front panel.

3-1 Press both sides of the cabinet in the direction of the arrow as shown in the figure.

3-2 Pull the lower part of the front panel slightly forward. (below three inches)

3-3 Lift the front panel upward.



Applying excessive force to remove the front panel may cause damage to the tab ; be sure not to use excessive force.

- 4 Remove two screws on the lower, right and left sides of the unit.

- 5 Remove the chassis from the cabinet.

- 6 Remove the rubber cap inserted into the basepan.

- 7 Fix the drain pan as shown in the figure, and then connect the drain hose. (You can use any commercially-available drain hose.)

- 8 Install the cabinet at the specified area after installing the drain pan, and then re-assemble it in the original condition.

➤ Secure the front panel to the case by replacing the screw removed in step 2. If a screw not removed in step 2, secure the panel with a supplied screw.

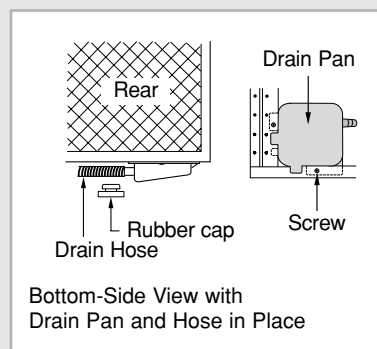
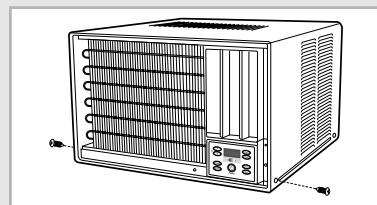
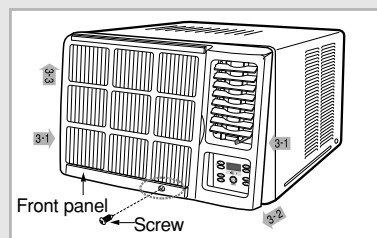

◆ **In the case of an area where the drain pan can be directly installed on the rear side of the unit after installing the air conditioner.**

- 1 Follow steps 6 and 7 only

**THIS AIR CONDITIONER IS MANUFACTURED BY:
ESTE ACONDICIONADOR DE AIRE HA SIDO FABRICADO POR:
CE CLIMATISEUR EST FABRIQUÉ PAR:
ESTE APARELHO DE AR CONDICIONADO É FABRICADO POR:
QUESTO CONDIZIONATORE D'ARIA È PRODOTTO DA:**



Printed in China

Free Manuals Download Website

<http://myh66.com>

<http://usermanuals.us>

<http://www.somanuals.com>

<http://www.4manuals.cc>

<http://www.manual-lib.com>

<http://www.404manual.com>

<http://www.luxmanual.com>

<http://aubethermostatmanual.com>

Golf course search by state

<http://golfingnear.com>

Email search by domain

<http://emailbydomain.com>

Auto manuals search

<http://auto.somanuals.com>

TV manuals search

<http://tv.somanuals.com>