

SAMSUNG

OWNER'S INSTRUCTIONS

AZ09F1KE

**WINDOW-TYPE
ROOM AIR CONDITIONER**
(Cool and Heat)

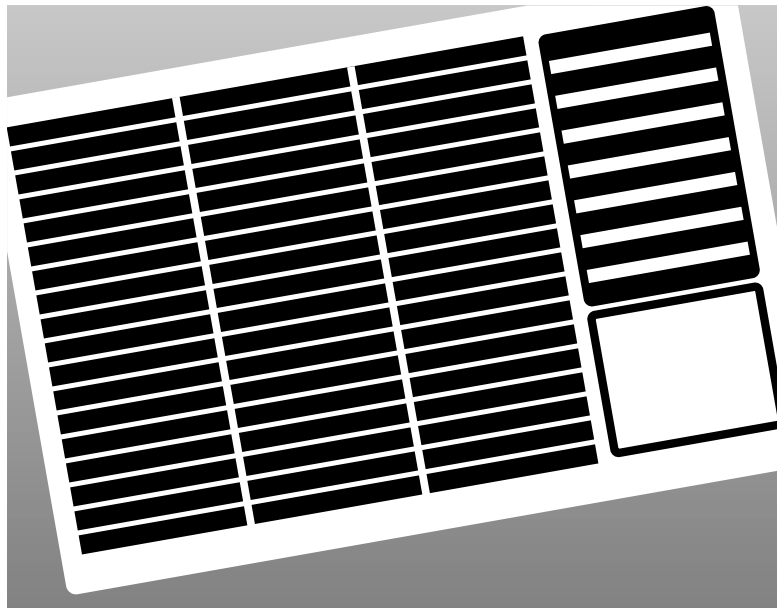

©® DB68-02037A(1)

Safety Precautions

The following safety precautions must be taken when installing and using your air conditioner.

1 *The air conditioner must be plugged into its own specific power source, which must be installed in compliance with national wiring, earthing and safety regulations.*

Depending on national regulations and your specific installation, you may need to install:

- ◆ *A circuit breaker*

For further information on electrical requirements, contact a professional electrician. This device must be installed according to the national electrical rules.

2 *Make sure that the unit is correctly ventilated at all times; do NOT place clothing or other materials over it.*

3 *NEVER spill liquids of any kind into the unit. Should this happen, unplug the unit and contact your installation specialist.*

4 *Do NOT insert anything between the air outlet blades, as the inner fan may be damaged and you may be hurt. Particularly, keep children away from the unit.*

5 *ALWAYS ensure that the power cable is in good condition. Make sure that it is not walked on or damaged by items placed on or against it.*

If the power cord is damaged in any way, it must be replaced by an approved power cord available from the manufacturer or its service agent.

6 *Do NOT attempt to repair the unit yourself. If it is damaged in any way, contact:*

- ◆ *An approved service center*
- ◆ *The outlet at which the air conditioner was purchased*

7 *Do NOT place any obstacles in front of the unit.*

8 *The appliance is not intended for use by young children or infirm person without supervision; young children should be supervised to ensure that they do not play with the appliance.*

CAUTION

The manufacturer do not take the responsibility of the accident happened because the air conditioner is not fixed firmly or installed securely, during installing or using the product. In case you have difficulty in installation, you must ask for an installation specialist help. The accident will be happened in case of installing improperly.

Contents

◆ PREPARING YOUR AIR CONDITIONER	
■ Safety Precautions	2
■ Air Conditioning Unit - Main Parts and Control Panel	4
■ Getting Started	5
◆ OPERATING YOUR AIR CONDITIONER	
■ Cooling Your Room	6
■ Heating Your Room	7
■ Airing Your Room	8
■ Switching the Air Conditioner Off	8
■ Adjusting the Air Flow Direction Horizontally	9
■ Adjusting the Air Flow Direction Vertically	9
◆ RECOMMENDATIONS FOR USE	
■ Operating Recommendations	10
■ Temperature and Humidity Ranges	10
■ Cleaning Your Air Conditioner	11
■ Solving Common Problems	12
■ Technical Specifications	13
◆ METHOD OF INSTALLATION	14

Air Conditioning Unit - Main Parts and Control Panel

* The design and shape are subject to change according to the model.

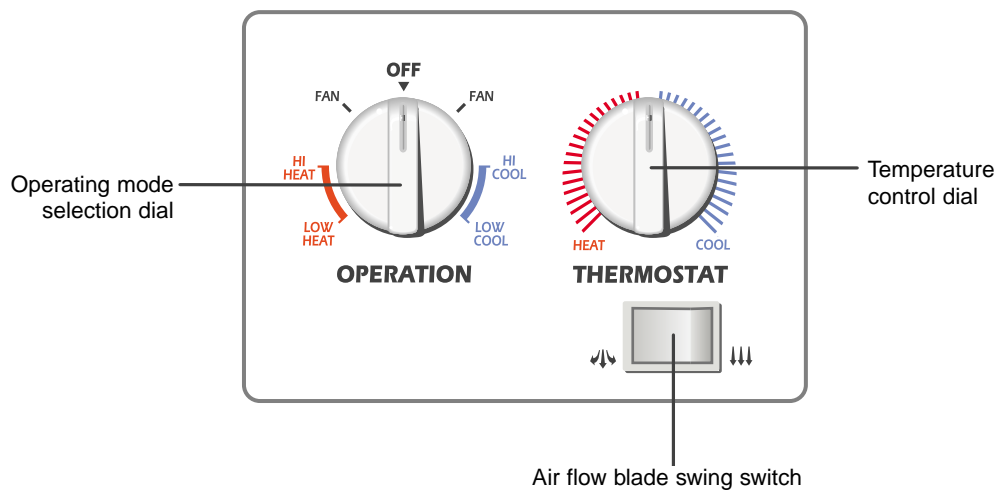
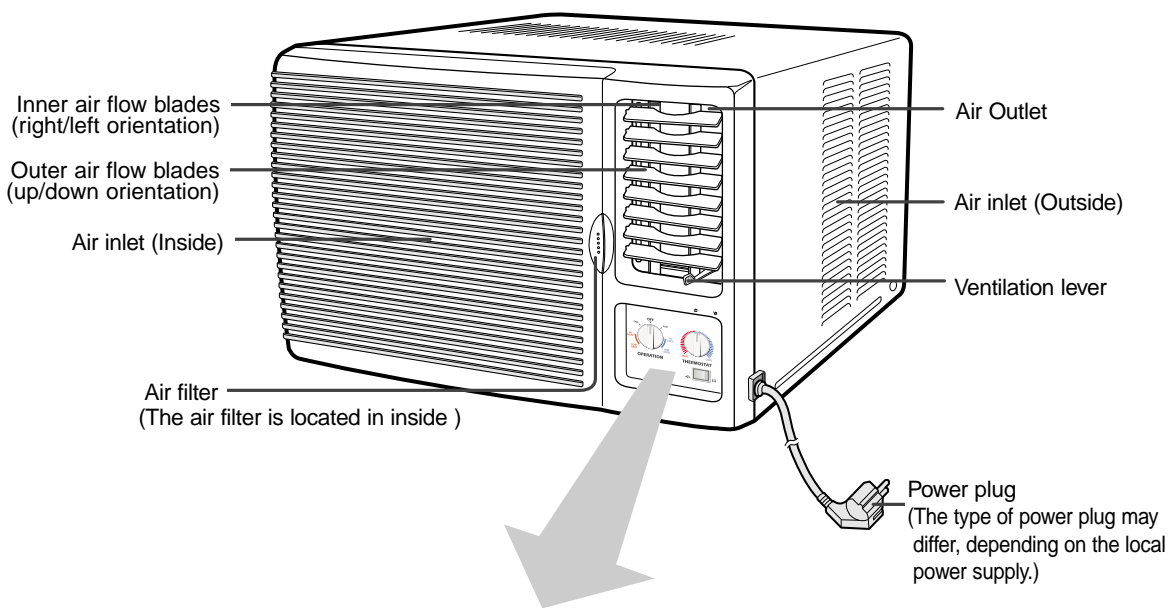

Getting Started

You have just purchased a window-type room air conditioner and it has been installed by your installation specialist.

Your Owner's Instructions contain much valuable information on using your air conditioner. Please take the time to read them as they will help you take full advantage of the unit's features.

The booklet is organised as follows.

- ◆ *The illustration on page 4 shows the air conditioning unit; it indicates the location and purpose of the main parts and controls on the unit.*
- ◆ *In the main part of the document, you will find a series of step-by-step procedures for each function available.*

The illustrations in the step-by-step procedures use four different symbols:

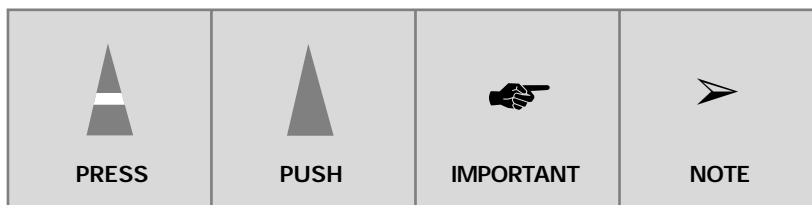

Cooling Your Room

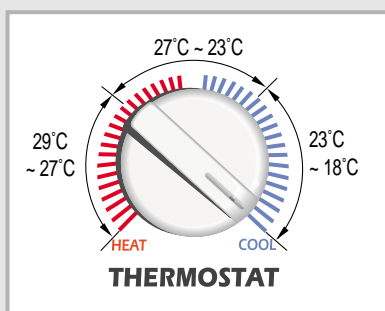
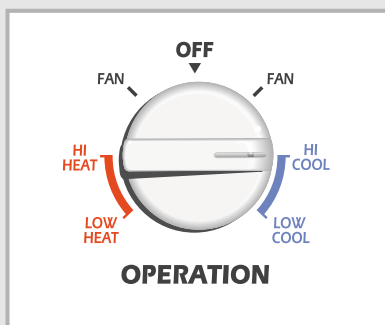

You must select the Cool mode if you wish to lower the temperature in your room. You can also set the fan speed.

- 1 Select the operating mode and fan speed.

To cool your room with a...	Set the operating mode selection dial to...
-----------------------------	---

High fan speed	HI COOL
Low fan speed	LOW COOL

Result:

- ◆ The air conditioner starts up in Cool mode.
- ◆ The fan starts up at the speed selected.

➤ You can change modes at any time.

- 2 To adjust the temperature, turn the temperature control dial towards the right and the blue position.

Possible temperatures: Between 18°C and 25°C inclusive.

Result: The air conditioner starts cooling if the room temperature is higher than the selected temperature.

- 3 To control the direction of the air flow, refer to page 9.

Heating Your Room

You must select the Heat mode if you wish to heat your room to a specific temperature. You can also select the fan speed.

- 1 Select the operating mode and fan speed.

To heat your room with a...	Set the operating mode selection dial to...
-----------------------------	---

High fan speed	HI HEAT
----------------	---------

Low fan speed	LOW HEAT
---------------	----------

Result:

- ◆ The air conditioner starts up in Heat mode.
- ◆ The fan starts up at the speed selected.

➤ You can change modes at any time.

- 2 To adjust the temperature, turn the temperature control dial towards the left and the red position.

Possible temperatures: Between 25°C and 29°C inclusive.

Result: The air conditioner starts heating if the room temperature is lower than the selected temperature.

- 3 To control the direction of the air flow, refer to page 9.

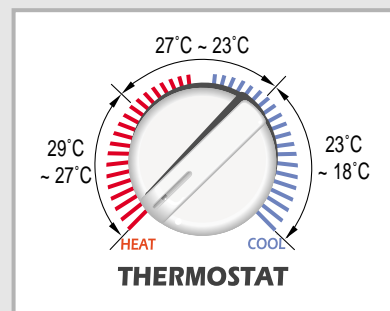
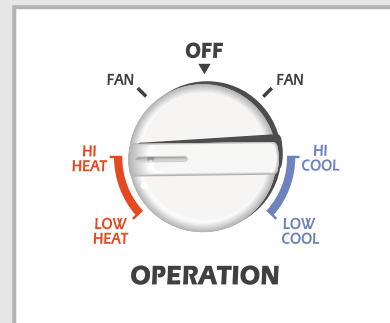

Airing Your Room

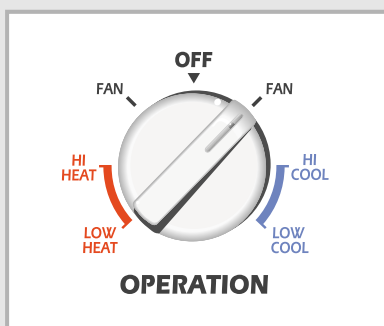
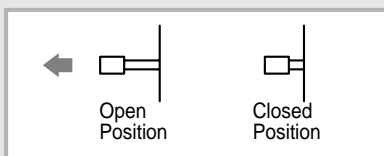
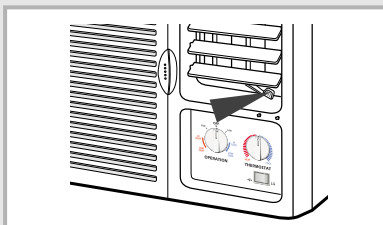

If the atmosphere in your room is stale, you can air it using the Fan feature and if necessary, evacuate the stale air outside.

- 1 If you wish to evacuate stale air outside, pull the ventilation lever on the front of the unit and the open position ().

Result: The air inside the room circulates and stale air is evacuated outside.

Otherwise, push the ventilation lever and the closed position ().

Result: The air simply circulates inside the room.

- 2 Set the operating mode selection dial to the FAN position.

➤ Both fan settings (left and right) have the same function.

Result: The air conditioner starts up in Fan mode.

- 3 To control the direction of the air flow, refer to page 9.

Switching the Air Conditioner Off

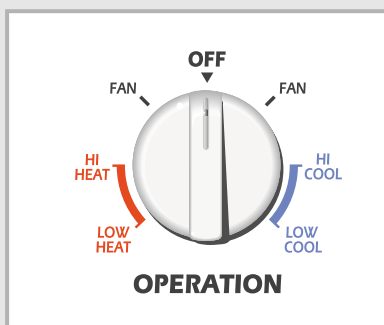

You can switch the air conditioner off whenever you want.

To switch the unit off, simply set the operating mode selection dial to the OFF position.

Result: The air conditioner stops operating.

Adjusting the Air Flow Direction Horizontally

Depending on the position of the unit in your room, you can adjust the orientation of the inner air flow blades on the right-hand side of the unit, thus increasing the efficiency of the air conditioner.

- 1 Set the air flow blade swing switch to the  position .

Result: The inner blades swing automatically left and right.

- The blades may stop swinging momentarily when the Deice function is activated (see page 10 for further details on this function). They will start swinging again automatically as soon as the Deice function stops.

- 2 To stop the blades moving left and right, set the air flow blade swing switch to the  position.

- To stop the blades in a specific position and orient the air flow in the corresponding direction, simply set the switch to the  position when the blades are in the required position.

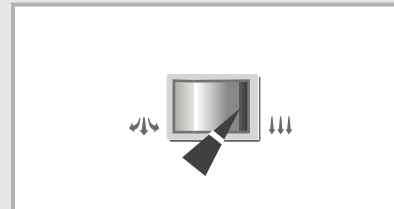
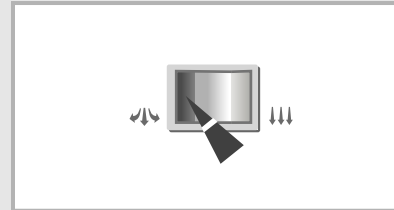

Adjusting the Air Flow Direction Vertically

Again depending on the position of the unit in your room, you can adjust the orientation of the outer air flow blades on the right-hand side of the unit.

RECOMMENDATION	When...	Adjust the blades to face...
	Cooling	Upwards.
	Heating	Downwards.

Adjust the air flow blades to the required position, by pushing them upwards or downwards.

- If you orient the air flow blades downwards and the unit operates in Cool mode for a long period of time, dew may:
 - ◆ Form on the surface of the blades
 - ◆ Drip from the blades

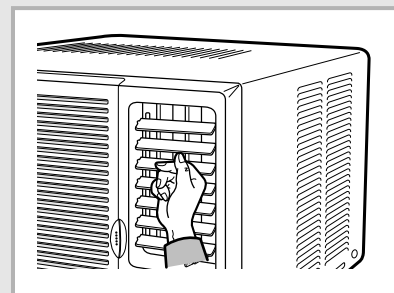

Operating Recommendations

Here are a few recommendations that you should follow when using your air conditioner.

Topic	Recommendation
Heating performances	The heat pump inside the air conditioner absorbs heat from outside air and brings it indoors. If the temperature of the outside air drops, the air conditioner will heat less. If you find that the room is not warm enough, use an additional heating appliance.
Warm air circulation	The air conditioner circulates warm air to heat your room; as a result, some time will be required after starting the air conditioner to warm the entire room. If necessary, set the air conditioner going a short time before you wish to use the room.
Frost	<p>When outside temperatures are low and humidity is high, frost may form in the unit's condenser when heating with your air conditioner.</p> <p>If this happens:</p> <ul style="list-style-type: none"> ◆ The unit stops heating ◆ The air flow blades stop swinging ◆ The Deice mode is triggered automatically for about five minutes. <p>No intervention is required from you; after about five minutes, the air conditioner starts operating again normally.</p>
High indoor and outdoor temperatures	If both the indoor and outdoor temperatures are high and you select the Heat mode, the fan and compressor in the unit may stop at times. This is normal; simply wait until the air conditioner switches on again.
Power failure	If a power failure occurs when the air conditioner is operating, the unit is switched off. When the power returns, the air conditioner starts up again automatically.

Temperature and Humidity Ranges

The following table indicates the temperature and humidity ranges, within which the air conditioner can be used.

Mode	Indoor Temperatures	Outdoor Temperature	Indoor Humidity
Heating	28°C or less	0°C to 21°C approx.	-
Cooling	21°C to 32°C approx.	21°C to 43°C approx.	80% or less

If the air conditioner is used at...	Then...
Higher temperature	The automatic protection feature may be triggered and the air conditioner stopped.
Lower temperature	A water leakage or some other malfunction may happen if the heat exchanger freezes.
Higher humidity levels	Water may condense on and drip from the surface of the unit if it is used for long periods.

Cleaning Your Air Conditioner

Be sure to clean the air filter periodically to maintain the air conditioner in the best condition for a long period of time.

IMPORTANT When cleaning the air conditioner, turn it off and pull out the power plug.

1 Hold the air filter handle, slightly pull it to the left side and open the front grille.

- The removal of the front grille makes it easier to clean the air conditioner. Open the grille as much as possible.

CAUTION

Removal and Reassembly of the Front Grille

For user's safety, a safety clip has been installed in the front grille.

- 1 Grasp the lower part of the front grille and the air filter handle, then open the grille.
- 2 Remove the safety clip and the front grille.
- 3 When reassembling the front grille, you should install the safety clip again.

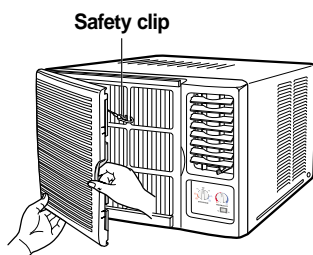

2 Pull the air filter to the right side.

3 Remove all dust on the air filter with a vacuum cleaner or brush.

4 When you have finished, insert the air filter back into its original position.

5 Wipe the surface of the unit with a neutral detergent and then wipe it again with dry cloth.
(Be sure not to use benzene, solvent or other chemical products.)

➤ If you...	Then...
Will not be using the air conditioner for a long period of time	<ul style="list-style-type: none">◆ Set the fan going for a few hours to dry the inside of the air conditioner thoroughly.◆ Switch the air conditioner off and unplug it from the wall socket.◆ Clean the filter and outer surfaces.
Have not used the air conditioner for a long period of time	Set the fan going for a few hours to dry the inside of the air conditioner thoroughly.

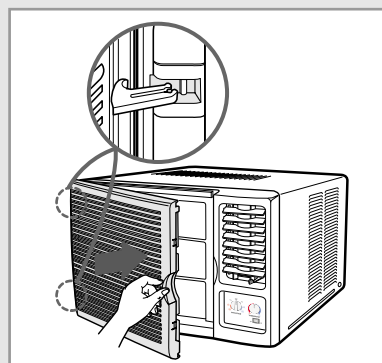
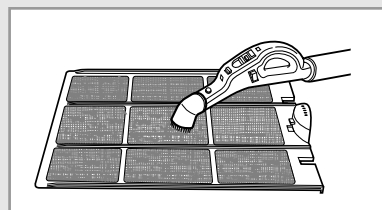
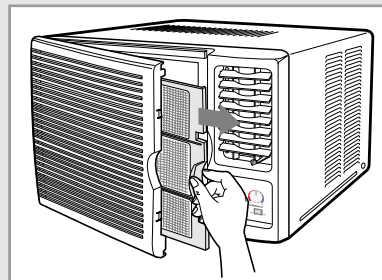

The air conditioner has two or three grille grooves depending on the model.

Solving Common Problems

Before contacting the after-sales service, perform the following simple checks. They may save you the time and expense of an unnecessary call.

PROBLEM	EXPLANATION / SOLUTION
The air conditioner does not operate at all	<ul style="list-style-type: none">◆ Check that the circuit breaker used for the air conditioner has not been triggered.◆ Check that the power cable is plugged into a wall socket and the socket is switched on, if necessary.◆ Check that the correct operating mode has been selected (cooling, heating or airing).
The air conditioner does not cool or heat	<ul style="list-style-type: none">◆ Check that the correct operating mode has been selected, COOL or HEAT.◆ The room temperature may be too low or too high.◆ Dust may be blocking the air filter; refer to page 11 for cleaning instructions.◆ Check that there is no obstacle blocking the air flow into or out of the unit.
When heating, the required room temperature is never reached and the air conditioner frequently stops	<ul style="list-style-type: none">◆ Check that the required temperature has been set correctly.◆ Increase the fan speed.◆ If the air flow is directed downwards, direct it upwards.
The air flow direction does not change when you set the air flow blade swing switch to the  position	<ul style="list-style-type: none">◆ Check that the air conditioner has been switched on; if necessary, turn the operating mode selection dial.
Odours are permeated in the room during air conditioning	<ul style="list-style-type: none">◆ Air the room.

Technical Specifications

Design and specifications are subject to change without notice.

Model	Power Supply
AZ09F1KE	220-240V~, 50Hz

Method of Installation

Before installation, be sure to check the installation area for the air conditioner, and installation method of the drain hose.

Checkpoints prior to installation

- 1 Check the cabinet and front grille of the unit for any harmful defects such as scratches.
- 2 Be sure to check the power supply.
 - Refer to the specifications on the label attached to the unit.

Installation Conditions

- 1 As the unit is heavy, the wall or window of the installation area should have sufficient strength and durability for operation of the air conditioner, and for prevention of any vibration or noise.
If it is weak, reinforcement work should be performed separately.
- 2 It is advisable to install the air conditioner in the north or west side to prevent the effect of direct sunlight.
When installing it in the south or east side due to unavoidable circumstances, it is advisable to install the sunshade to prevent the direct sunlight.
In this case, take care not to cause any hindrance to the flow of outside air.
- 3 When installing the air conditioner, be sure to obtain sufficient space on the rear side of the unit for smooth flow of air.
When operating the air conditioner in closed areas such as inner building with cooling operation, and result in trouble with the unit.
See the illustration below.

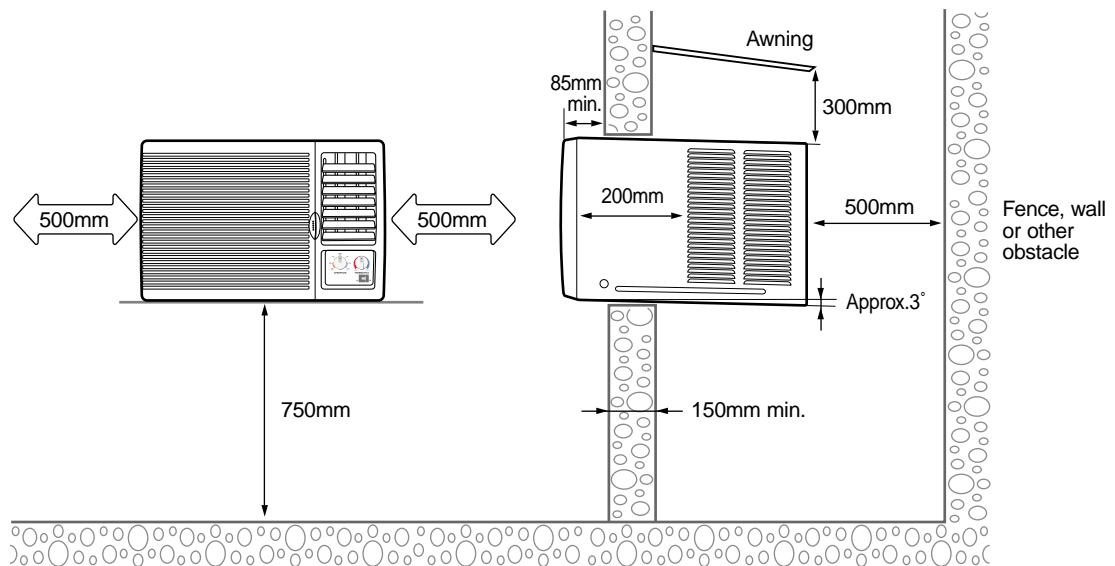

- ♦ If the wall is greater than 150mm thick, cut the wall back on a 45° angle if possible.

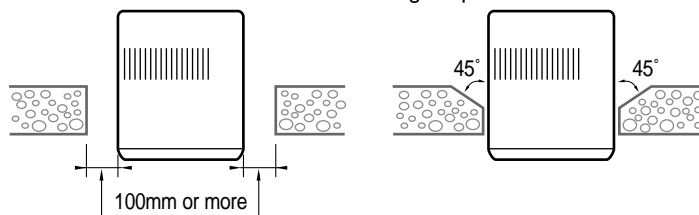

Installation of the Drain Tube

Fix the drain tube as shown in the figure.

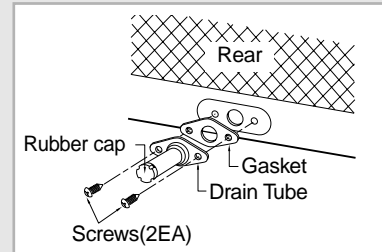

Installation of the Drain Pan

The procedure for installing the drain pan should be determined by the condition of the installing area.

- ◆ **In the case of an area where the drain pan can not be directly installed on the rear side of the unit after installing the air conditioner.**

Example: High storage

- 1 Open the front grille ; refer to page 11.
- 2 **Remove the screw located at the lower section of the front grille. It is secured in the  section depending on the model.**

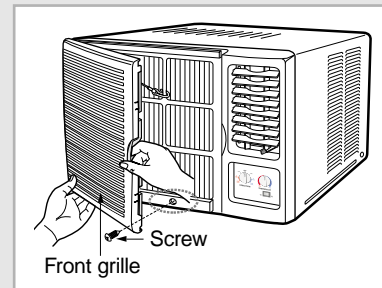

- 3 Remove the front panel.
 - 3-1 Press both sides of the cabinet in the direction of the arrow as shown in the figure.
 - 3-2 Pull the lower part of the front panel slightly forward. (below three inches/7cm)
 - 3-3 Lift the front panel upward.



Applying excessive force to remove the front panel may cause damage to the tab ; be sure not to use excessive force.

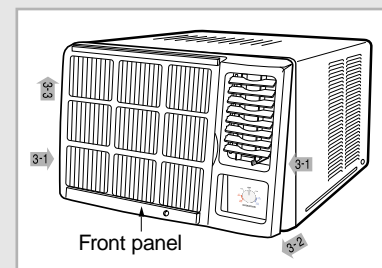

- 4 Remove two screws on the lower, right and left sides of the unit.
- 5 Remove the chassis from the cabinet.
- 6 Remove the rubber cap inserted into the basepan.
- 7 Fix the drain pan as shown in the figure, and then connect the drain hose. (You can use any commercially-available drain hose.)
- 8 Install the cabinet at the specified area after installing the drain pan, and then re-assemble it in the original condition.

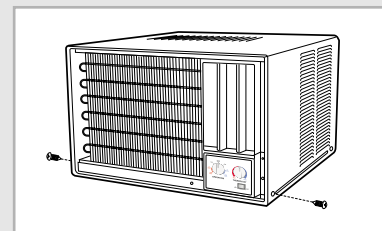

Secure the front panel to the case by replacing the screw removed in step 2. If a screw not removed in step 2, secure the panel with a supplied screw.

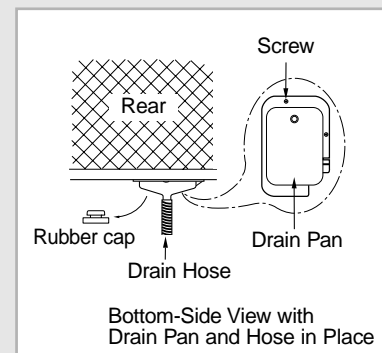

- ◆ **In the case of an area where the drain pan can be directly installed on the rear side of the unit after installing the air conditioner.**

- 1 Follow steps 6 and 7 only

THIS AIR CONDITIONER IS MANUFACTURED BY:



Printed in Korea

Free Manuals Download Website

<http://myh66.com>

<http://usermanuals.us>

<http://www.somanuals.com>

<http://www.4manuals.cc>

<http://www.manual-lib.com>

<http://www.404manual.com>

<http://www.luxmanual.com>

<http://aubethermostatmanual.com>

Golf course search by state

<http://golfingnear.com>

Email search by domain

<http://emailbydomain.com>

Auto manuals search

<http://auto.somanuals.com>

TV manuals search

<http://tv.somanuals.com>