

SAMSUNG



SAMSUNG LASER MFP User's Guide

SCX-4100

For UK customers:

To reorder your consumables

Call 0800 3164060

For Technical Assistance

Call 0870 2420303

About the User's Guides

Provides information you need for setting up your machine and installing the supplied software. It also provides all of the detailed instructions for using your machine as a printer, a scanner and a copier and information for maintaining and troubleshooting the machine.

Also, provides the basic description about using the multi-function application. Samsung SmarThru allows you to scan and edit images, and to scan for copying, and sending an e-mail on your computer.

This manual is provided for information purposes only. All information included herein is subject to change without notice. Samsung Electronics is not responsible for any changes, direct or indirect, arising from or related to the use of this manual.

© 2004 Samsung Electronics Co., Ltd. All rights reserved.

- SCX-4100 and Samsung logo are trademarks of Samsung Electronics Co., Ltd.
- PCL and PCL 6 are trademarks of Hewlett-Packard Company.
- Microsoft, Windows, Windows 9x, Window Me, Windows 2000, Windows NT 4.0 and Windows XP are registered trademarks of Microsoft Corporation.
- PostScript 3, Adobe Acrobat Reader, Adobe PhotoDeluxe and Adobe Photoshop are trademarks of Adobe System, Inc.
- All other brand or product names are trademarks of their respective companies or organizations.

CONTENTS

Chapter 1: GETTING STARTED

Unpacking	1.2
Selecting a Location	1.3
Understanding the Component Location	1.4
Front View	1.4
Rear View	1.4
Control Panel Functions	1.5
Installing the Toner Cartridge	1.6
Loading Paper	1.8
Changing the Paper Size in the Paper Tray	1.9
Making Connections	1.11
Turning the Machine On	1.13
About Samsung Software	1.14
Printer Driver Features	1.15
Installing Samsung Software in Windows	1.16
System Requirements	1.16
Installing Samsung Software	1.17
Installing Samsung SmarThru	1.20
Repairing Software	1.22
Removing Software	1.23
Uninstalling the MFP Driver	1.23
Uninstalling Samsung SmarThru	1.24
Changing the Display Language	1.25
Setting the Paper Size and Type	1.26
Using the Save Modes	1.27
Toner Save Mode	1.27
Power Save Mode	1.27

Chapter 2: PAPER HANDLING

Selecting Print Materials	2.2
Type, Input Sources and Capacities	2.2
Guidelines for Paper and Special Materials	2.3
Selecting an Output Location	2.4
Printing to the Front Output Tray (Face down)	2.5
Printing to the Rear Output Slot (Face up)	2.6
Loading Paper in the Paper Tray	2.8
Using the Manual Feeder	2.9
Setting the Paper Type and Size for the Manual Feeder	2.11

Chapter 3: PRINTING

Printing a Document in Windows	3.2
Canceling a Print Job	3.5
Using a Favorite Setting	3.6
Using Help	3.6
Setting Paper Properties	3.7
Setting Graphic Properties	3.8
Printing Multiple Pages on One Sheet of the Paper	3.10
Printing a Reduced or Enlarged Document	3.12
Fitting Your Document to a Selected Paper Size	3.13
Printing Posters	3.14
Using Watermarks	3.15
Using an Existing Watermark	3.15
Creating a Watermark	3.16
Editing a Watermark	3.17
Deleting a Watermark	3.17
Using Overlays	3.18
What is an Overlay?	3.18
Creating a New Page Overlay	3.18
Using a Page Overlay	3.20
Deleting a Page Overlay	3.21
Setting Up the Locally Shared Printer	3.22
In Windows 9x/Me	3.22
In Windows NT 4.0/2000/XP	3.23

Chapter 4: COPYING

Loading Paper for Copying	4.2
Preparing a Document	4.2
Making a Copy	4.3
Setting Copy Options	4.5
Darkness	4.5
Number of Copies	4.5
Reduced/Enlarged Copying	4.6
Original Type	4.7
Using Special Copy Features	4.8
Clone Copying	4.8
Auto Fit Copying	4.9
2 sided in 1 page Copying	4.10
2-up Copying	4.11
Poster Copying	4.12
Changing the Default Settings	4.13
Setting the Time Out Option	4.14

Chapter 5: SCANNING

Scanning Basics	5.2
Scanning Using Samsung SmarThru	5.2
To use on-line help file	5.5
Scanning Process with TWAIN-enabled Software	5.6

Chapter 6: USING YOUR PRINTER IN LINUX

Getting Started	6.2
Installing the MFP Driver	6.3
System Requirements	6.3
Installing the MFP Driver	6.4
Uninstalling the MFP Driver	6.6
Using the MFP Configurator	6.7
Opening the MFP Configurator	6.7
Printers Configuration	6.8
Scanners Configuration	6.9
MFP Ports Configuration	6.10
Configuring Printer Properties	6.11
Printing a Document	6.12
Printing from Applications	6.12
Printing Files	6.13
Scanning a Document	6.14
Using the Image Editor	6.18

Chapter 7: MAINTENANCE

Printing the System Data List	7.2
Clearing the Memory	7.2
Cleaning Your Machine	7.3
Cleaning the Outside	7.3
Cleaning the Inside	7.3
Cleaning the Document Glass	7.5
Maintaining the Toner Cartridge	7.6
Redistributing Toner	7.7
Replacing the Toner Cartridge	7.8
Cleaning the Drum	7.9
Consumables and Replacement Parts	7.9
Using the Remote Control Panel	7.10

Chapter 8: TROUBLESHOOTING

Clearing Paper Jams	8.2
In the Paper Tray	8.2
In the Paper Exit Area	8.3
In the Fuser Area or Around the Toner Cartridge	8.5
In the Manual Feeder	8.6
Tips for Avoiding Paper Jams	8.6
Clearing LCD Error Messages	8.8
Solving Problems	8.9
Paper Feeding Problems	8.9
Printing Problems	8.10
Printing Quality Problems	8.13
Copying Problems	8.18
Scanning Problems	8.19
Common Linux Problems	8.20

Appendix A: SPECIFICATIONS

General Specifications	A.2
Scanner and Copier Specifications	A.3
Printer Specifications	A.4
Paper Specifications	A.5
Overview	A.5
Supported Sizes of Paper	A.6
Guidelines for Using Paper	A.7
Paper Specifications	A.8
Paper Output Capacity	A.8
Paper Storage Environment	A.9
Envelopes	A.10
Labels	A.12
Transparencies	A.12

Important Precautions and Safety Information

When using this machine, these basic safety precautions should always be followed to reduce risk of fire, electric shock, and injury to people:

1. Read and understand all instructions.
2. Use common sense whenever operating electrical appliances.
3. Follow all warnings and instructions marked on the machine and in the literature accompanying the machine.
4. If an operating instruction appears to conflict with safety information, heed the safety information. You may have misunderstood the operating instruction. If you cannot resolve the conflict, contact your sales or service representative for assistance.
5. Unplug the machine from the AC wall socket before cleaning. Do not use liquid or aerosol cleaners. Use only a damp cloth for cleaning.
6. Do not place the machine on an unstable cart, stand or table. It may fall, causing serious damage.
7. Your machine should never be placed on, near or over a radiator, heater, air conditioner or ventilation duct.
8. Do not allow anything to rest on the power cable. Do not locate your machine where the cords will be abused by persons walking on them.
9. Do not overload wall outlets and extension cords. This can diminish performance, and may result in the risk of fire or electric shock.
10. Do not allow pets to chew on the AC power, or PC interface cords.
11. Never push objects of any kind into the machine through case or cabinet openings. They may touch dangerous voltage points, creating a risk of fire or shock. Never spill liquid of any kind onto or into the machine.
12. Your machine may have a heavy cover for optimal pressure on the document for the best scanning. In this case, replace the cover after placing document on the scan glass, by holding and moving it down slowly until it seats on its location.
13. To reduce the risk of electric shock, do not disassemble the machine. Take it to a qualified service technician when repair work is required. Opening or removing covers may expose you to dangerous voltages or other risks. Incorrect reassembly could cause electric shock when the unit is subsequently used.

14. Unplug the machine from the, PC and AC wall outlet, and refer servicing to qualified service personnel under the following conditions:
 - When any part of the power cord, plug, or connecting cable is damaged or frayed.
 - If liquid has been spilled into the machine.
 - If the machine has been exposed to rain or water.
 - If the machine does not operate properly after instructions have been followed.
 - If the machine has been dropped, or the cabinet appears damaged.
 - If the machine exhibits a sudden and distinct change in performance.
15. Adjust only those controls covered by the operating instructions. Improper adjustment of other controls may result in damage, and may require extensive work by a qualified service technician to restore the machine to normal operation.
16. Avoid using this machine during a lightning storm. There may be a remote risk of electric shock from lightning. If possible, unplug the AC power cord for the duration of the lightning storm.
17. If you print large amount of copies, the surface of the output tray may become hot. Be careful not to touch the surface, and keep children away from the surface.
18. SAVE THESE INSTRUCTIONS.

Laser Safety Statement

The printer is certified in the U.S. to conform to the requirements of DHHS 21 CFR, chapter 1 Subchapter J for Class I(1) laser products, and elsewhere is certified as a Class I laser product conforming to the requirements of IEC 825.

Class I laser products are not considered to be hazardous. The laser system and printer are designed so there is never any human access to laser radiation above a Class I level during normal operation, user maintenance, or prescribed service condition.

WARNING

Never operate or service the printer with the protective cover removed from Laser/Scanner assembly. The reflected beam, although invisible, can damage your eyes. When using this product, these basic safety precautions should always be followed to reduce risk of fire, electric shock, and injury to persons:

	<p>CAUTION - INVISIBLE LASER RADIATION WHEN THIS COVER OPEN. DO NOT OPEN THIS COVER.</p> <p>VORSICHT - UNSICHTBARE LASERSTRAHLUNG, WENN ABDECKUNG GEÖFFNET. NICHT DEM STRAHL AUSSETZEN.</p>
	<p>ATTENTION - RAYONNEMENT LASER INVISIBLE EN CAS D'OUVERTURE. EXPOSITION DANGEREUSE AU FAISCEAU.</p>
	<p>ATTENZIONE - RADIAZIONE LASER INVISIBILE IN CASO DI APERTURA. EVITARE L'ESPOSIZIONE AL FASCIO.</p>
	<p>PRECAUCIÓN - RADIACIÓN LASER INVISIBLE CUANDO SE ABRE. EVITAR EXPONERSE AL RAYO.</p>
	<p>PERIGO - RADIAÇÃO LASER INVISÍVEL AO ABRIR. EVITE EXPOSIÇÃO DIRECTA AO FEIXE.</p>
	<p>GEVAAR - ONZICHTBARE LASERSTRALEN BIJ GEOPENDE KLEP. DEZE KLEP NIET OPENEN.</p>
	<p>ADVARSEL - USYNLIG LASERSTRÅLNING VED ÅBNING, NÅR SIKKERHEDSBRYDERE ER UDE AF FUNKTION. UNDGÅ UDSAETTELSE FOR STRÅLNING.</p>
	<p>ADVARSEL - USYNLIG LASERSTRÅLNING NÅR DEKSEL ÅPNES. STIRR IKKE INN I STRÅLEN. UNNGÅ EKSPONERING FOR STRÅLEN.</p>
	<p>VARNING - OSYNLIG LASERSTRÅLNING NÅR DENNA DEL ÄR ÖPPEN OCH SPÄRREN ÄR URKOPPLAD. BETRAKTA EJ STRÅLEN. STRÅLEN ÄR FARLIG.</p>
	<p>VARO! - AVATTAESSA JA SUOJALUKITUS OHITETTAESSA OLET ALTTIINA NÄKYMÄTTÖMÄLLE LASER-SÄTEILYLLE ÄLÄ KATSO SÄTEESEEN.</p>
	<p>注 意 - 严禁揭开此盖, 以免激光泄露灼伤</p>
	<p>주 의 - 이 덮개를 열면 레이저광에 노출될 수 있으므로 주의하십시오.</p>

Ozone Safety



During normal operation, this machine produces ozone. The ozone produced does not present a hazard to the operator. However, it is advisable that the machine be operated in a well ventilated area.

If you need additional information about ozone, please request your nearest Samsung dealer.

Power Saver



This machine contains advanced energy conservation technology that reduces power consumption when it is not in active use.

When the machine does not receive data for an extended period of time, power consumption is automatically lowered.

The energy star emblem does not represent EPA endorsement of any machine or service.

Recycling



Please recycle or dispose of the packaging material for this product in an environmentally responsible manner.

Radio Frequency Emissions

FCC Information to the User

This equipment has been tested and found to comply with the limits for a Class B digital device, pursuant to Part 15 of the FCC Rules. These limits are designed to provide reasonable protection against harmful interference in a residential installation. This equipment generates, uses, and can radiate radio frequency energy and, if not installed and used in accordance with the instructions, may cause harmful interference to radio communications. However, there is no guarantee that interference will not occur in a particular installation. If this equipment does cause harmful interference to radio or television reception, which can be determined by turning the equipment off and on, the user is encouraged to try to correct the interference by one or more of the following measures:

- Reorient or relocate the receiving antenna.
- Increase the separation between the equipment and receiver.
- Connect the equipment into an outlet on a circuit different from that to which the receiver is connected.
- Consult the dealer or experienced radio/ TV technician for help.

CAUTION: Change or modifications not expressly approved by the manufacturer responsible for compliance could void the user's authority to operate the equipment.

Canadian Radio Interference Regulations

This digital apparatus does not exceed the Class B limits for radio noise emissions from digital apparatus as set out in the interference-causing equipment standard entitled "Digital Apparatus", ICES-003 of the Industry and Science Canada.

Cet appareil numérique respecte les limites de bruits radioélectriques applicables aux appareils numériques de Classe B prescrites dans la norme sur le matériel brouilleur: "Appareils Numériques", ICES-003 édictée par l'Industrie et Sciences Canada.

Declaration of Conformity (European Countries)

Approvals and Certifications



The CE marking applied to this product symbolizes Samsung Electronics Co., Ltd. Declaration of Conformity with the following applicable 93/68/EEC Directives of the European Union as of the dates indicated:

January 1, 1995: Council Directive 73/23/EEC Approximation of the laws of the member states related to low voltage equipment.

January 1, 1996: Council Directive 89/336/EEC (92/31/EEC), approximation of the laws of the Member States related to electromagnetic compatibility.

March 9, 1999: Council Directive 1999/5/EC on radio equipment and telecommunications terminal equipment and the mutual recognition of their conformity.

A full declaration, defining the relevant Directives and referenced standards can be obtained from your Samsung Electronics Co., Ltd. representative.

EC Certification

Certification to 1999/5/EC Radio Equipment & Telecommunications Terminal Equipment Directive (FAX)

This Samsung product has been self-certified by Samsung for pan-European single terminal connection to the analogue public switched telephone network (PSTN) in accordance with Directive 1999/5/EC. The product has been designed to work with the national PSTNs and compatible PBXs of European countries.

In the event of problems, you should contact the Euro QA Lab of Samsung Electronics Co., Ltd. in the first instance.

The product has been tested against TBR21 and/or TBR38. To assist in the use and application of terminal equipment which complies with this standard, the European Telecommunication Standards Institute (ETSI) has issued an advisory document (EG 201 121) which contains notes and additional requirements to ensure network compatibility of TBR21 terminals. The product has been designed against, and is fully compliant with, all of the relevant advisory notes contained in this document.

Replacing the Fitted Plug (for UK Only)

IMPORTANT

The mains lead for this machine is fitted with a standard (BS 1363) 13 amp plug and has a 13 amp fuse. When you change or examine the fuse, you must re-fit the correct 13 amp fuse. You then need to replace the fuse cover. If you have lost the fuse cover, do not use the plug until you have another fuse cover.

Please contact the company from where the machine was purchased.

The 13 amp plug is the most widely used type in the UK and should be suitable. However, some buildings (mainly old ones) do not have normal 13 amp plug sockets. You need to buy a suitable plug adaptor. Do not remove the moulded plug.

WARNING

If you cut off the moulded plug, get rid of it straight away.

You cannot rewire the plug and you may receive an electric shock if you plug it into a socket.

IMPORTANT WARNING: You must earth this machine.

The wires in the mains lead have the following color code:

- Green and Yellow: Earth
- Blue: Neutral
- Brown: Live

If the wires in the mains lead do not match the colors marked in your plug, do the following:

You must connect the green and yellow wire to the pin marked by the letter "E" or by the safety 'Earth symbol' or colored green and yellow or green.

You must connect the blue wire to the pin which is marked with the letter "N" or colored black.

You must connect the brown wire to the pin which is marked with the letter "L" or colored red.

You must have a 13 amp fuse in the plug, adaptor, or at the distribution board.

EU Declaration of Conformity (LVD,EMC)

For the following product :

Multi-function Printer

(Product name)

SCX-4100

(Model Number)

Manufactured at :

Samsung Electronics Co.,Ltd #259, GongDan-Dong,Gumi-Si, GyungBuk, KOREA 730-030

Shandong Samsung Telecommunications Co., Ltd. Sanxing Road, Weihai Hi-Tech, IDZ Shandong Province, 264 209, China

(factory name, address)

We hereby declare, that all major safety requirements, concerning to CE Marking Directive [93/68/EEC] and Low Voltage Directive [73/23/EEC], ElectroMagnetic Compatibility [89/336/EEC], amendments [92/31/EEC] are fulfilled, as laid out in the guideline set down by the member states of the EEC Commission.

This declaration is valid for all samples that are part of this declaration, which are manufactured according to the production charts appendix.

The standards relevant for the evaluation of safety & EMC requirements are as

LVD : EN 60950-1:2001

EMC : EN 55022:1998, EN 61000-3-2:2000

EN 61000-3-3:1995+A1:2001 ,EN 55024:1998+A1:2001

follows :

1. Certificate of conformity / Test report issued by :

LVD : SEMKO

EMC : SAMSUNG Electronics EURO Q.A. Lab. in the U.K.

2. Technical documentation kept at :

Samsung Electronics Co.,Ltd

**which will be made available upon request
(Manufacturer)**

Samsung Electronics co.,Ltd
259, KongDan-Dong, GuMi-City
KyungBuk, Korea 730-030

2004-05-13

(place and date of issue)



Whan-Soon Yim / Senior Manager

(name and signature of authorized person)

(Representative in the EU)

Samsung Electronics Euro QA Lab.
Blackbushe Business Park, Saxony Way,
Yateley, Hampshire, GU46 6GG, UK
2004-05-13

(place and date of issue)



In-Seop Lee / Senior Manager

(name and signature of authorized person)

Differences Between British and American English

British English	American English
Cancelling	Canceling
Favourite	Favorite
Colour	Color
Colours	Colors
Coloured	Colored
Centre	Center
Grey	Gray
Greyscale	Grayscale
Millimetres	Millimeters
Discolour	Discolor
Fibre	Fiber
Emphasise	Emphasize
Recognise	Recognize
Organise	Organize
Authorise	Authorize
Customise	Customize
Labelling	Labeling

1

GETTING STARTED

Thank you for purchasing this multifunctional product. Your machine provides you with printing, copying, and scanning functions!

This chapter gives you step-by-step instructions for setting up your machine.

This chapter includes:

- **Unpacking**
- **Understanding the Component Location**
- **Installing the Toner Cartridge**
- **Loading Paper**
- **Making Connections**
- **Turning the Machine On**

Installing Software

- **About Samsung Software**
- **Installing Samsung Software in Windows**
- **Repairing Software**
- **Removing Software**

Setting Up the Machine System

- **Changing the Display Language**
- **Setting the Paper Size and Type**
- **Using the Save Modes**

Unpacking

Remove the machine and all accessories from the packing carton. Make sure that the machine has been packed with the following items. If there is a missing item, contact the retailer where you bought the machine:



Starter Toner Cartridge*

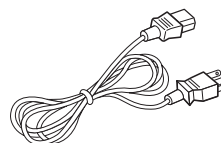

AC Power Cord**

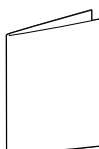

Quick Install Guide

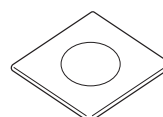

CD-ROM***

*The 1,000 pages and 3,000 pages toner cartridges have different shapes.

** The appearance of the power cord may differ according to your country's specifications.

*** The CD-ROM contains the MFP driver, SmarThru software, the user's guides and the Adobe Acrobat Reader program. SmarThru software provides the tools for scanning, copying, printing, and many other facilities.



NOTES:

- The power cord must be plugged into a grounded power socket.
 - Components may differ from one country to another.
-

Remove the packing tape from the front, back and sides of the machine.

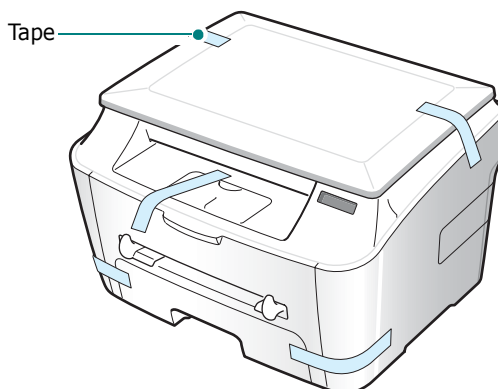

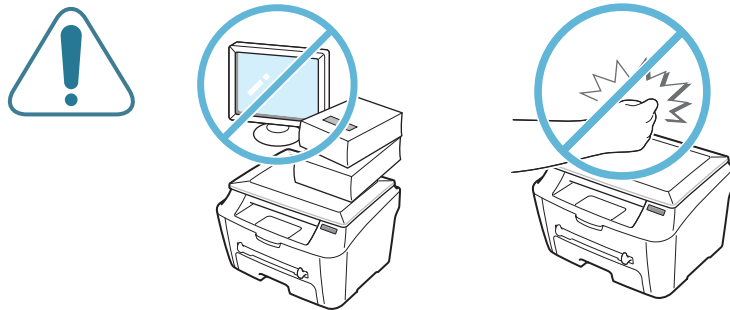

Selecting a Location

Select a level, stable place with adequate space for air circulation. Allow extra space for opening covers and trays.

The area should be well-ventilated and away from direct sunlight or sources of heat, cold and humidity. Do not set the machine close to the edge of your desk or table.

Clearance Space

- **Front:** 482.6 mm (enough space so that the paper trays can be removed)
- **Back:** 100 mm (enough space for ventilation)
- **Right:** 100 mm
- **Left:** 100 mm (enough space for ventilation)

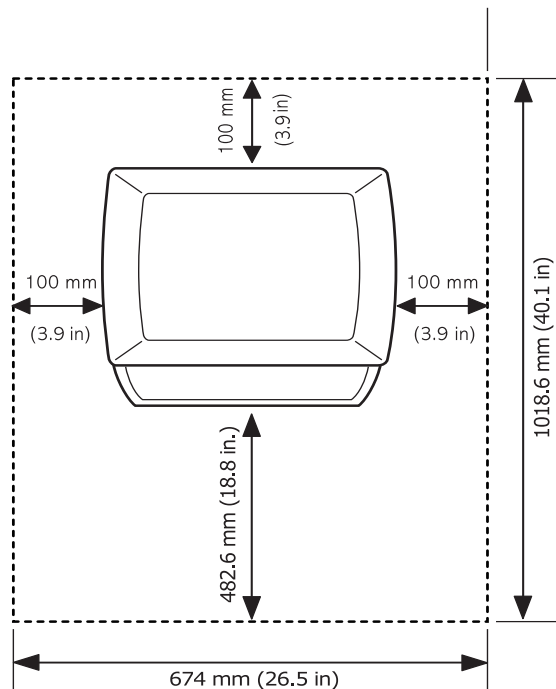

Understanding the Component Location

These are the main components of your machine:

Front View

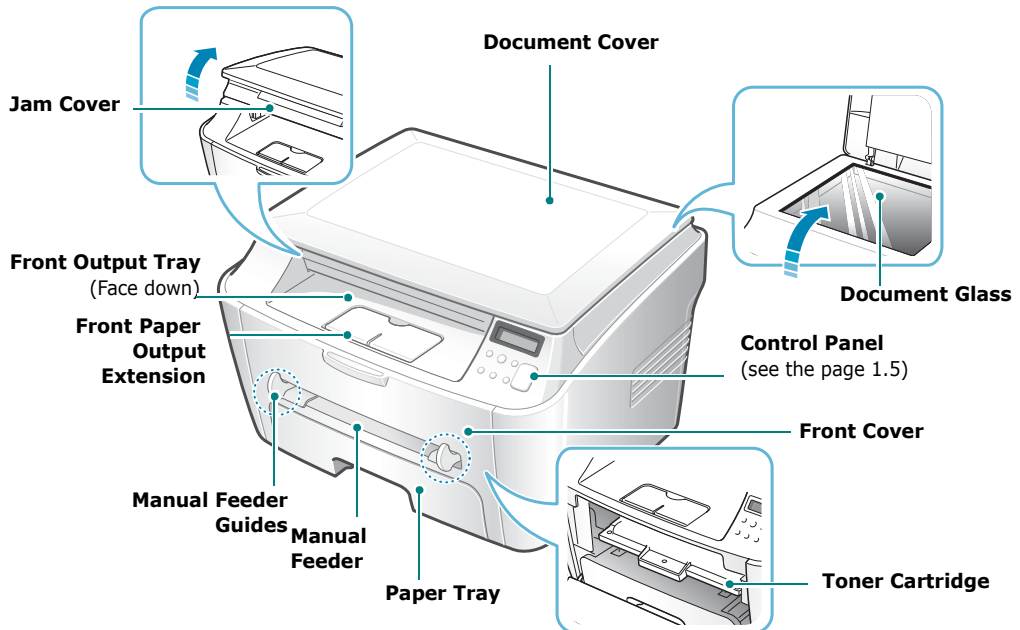



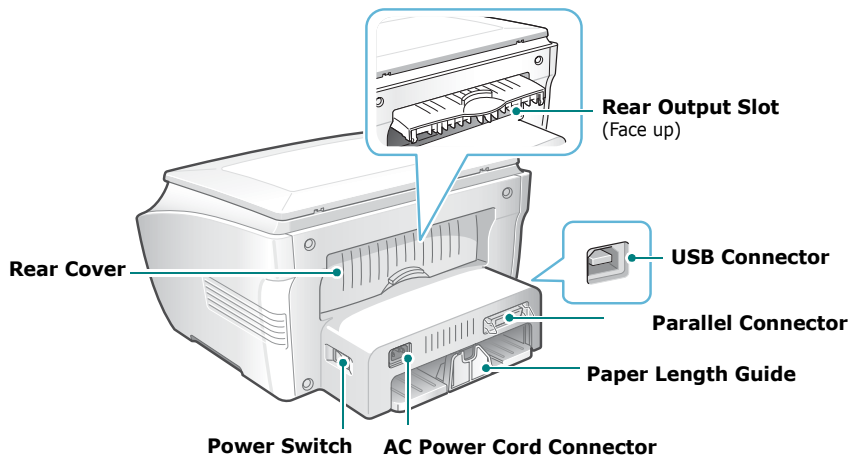

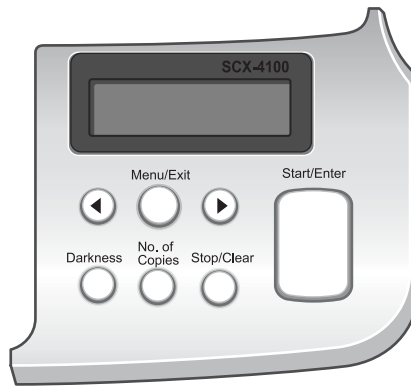

Rear View



Control Panel Functions



1 C O P Y	Darkness 	Adjusts the brightness of the documents for the current copy job.
	No. of Copies 	Selects the number of copies.
2		Displays the current status and prompts during an operation.
3		Scrolls through the options available for the selected menu item.
	Menu/Exit 	Enters Menu mode and scrolls through the menus available and sends you back to Standby mode.
4	Stop/Clear 	Stops an operation at any time. In Standby mode, clears/cancels the copy options, such as the darkness and the number of copies.
5	Start/Enter 	Confirms the selection on the display and starts a job.

Installing the Toner Cartridge

- 1 Open the front cover.

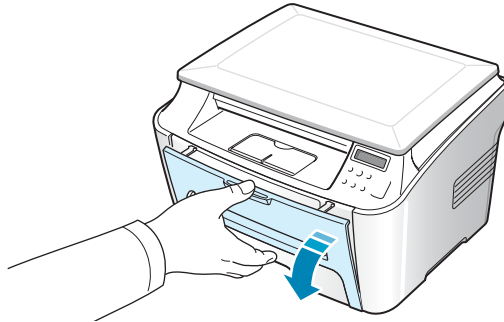

- 2 Remove the starter toner cartridge from its bag. Don't use a knife or other sharp object as it might scratch the drum of the cartridge.

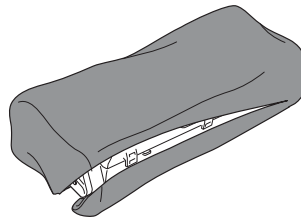

- 3 Gently roll the cartridge 5 or 6 times to distribute the toner evenly inside the cartridge.

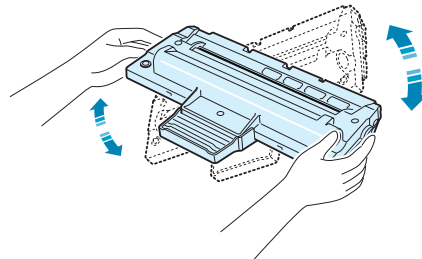

Thoroughly rolling the cartridge will assure the maximum copies per cartridge.



CAUTIONS:

- To prevent damage, do not expose the toner cartridge to light for more than a few minutes. Cover it with a piece of paper if left exposed for more than a few minutes, and keep it flat and clean place.
 - If toner gets on your clothing, wipe it off with a dry cloth and wash clothing in cold water. Hot water sets toner into the fabric.
-

- 4 Slide the toner cartridge into the machine until it locks into place completely.

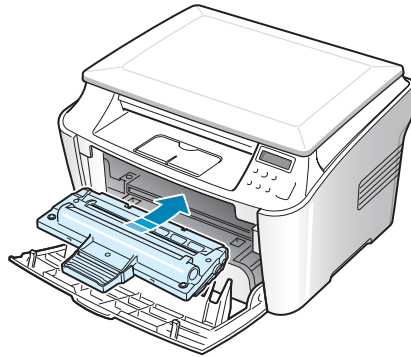

- 5 Close the front cover. Make sure that the cover is securely closed.

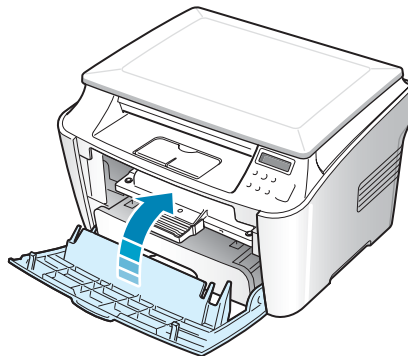

NOTE: When printing text at 5% coverage, you can expect a toner cartridge life of approximately 3,000 pages. (1,000 pages for the toner cartridge that is shipped with the printer.)

Loading Paper

You can load approximately 250 sheets.

To load a stack of Letter-sized paper:

- 1 Pull open the paper tray and remove it from the machine.

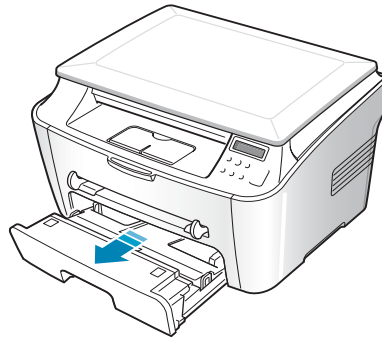

- 2 Fan the edges of the paper stack to separate the pages. Then tap the stack on a flat surface to even it up.

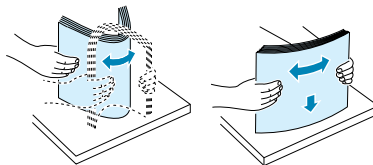

- 3 Insert the paper stack into the paper tray with the side you want to print on **facing down**.

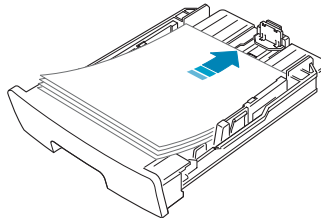

You can load previously printed paper. The printed side should be facing up with an uncurled edge on top. If you experience problems with paper feed, turn the paper around.

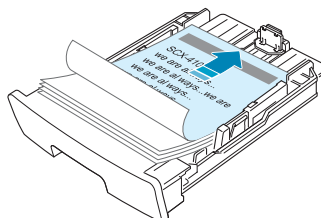

- 4 Pay attention to the paper limit mark on the left inside wall of the tray. Paper overloading may cause paper jams.

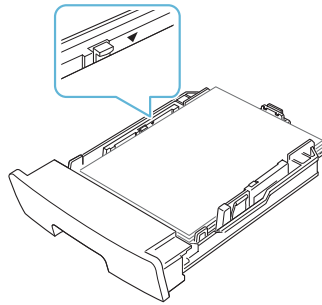

- 5 Insert and slide the paper tray back into the machine.

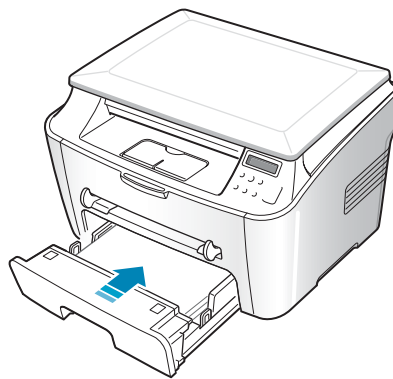

NOTE: After you load the paper, you need to set up your machine for the paper type and size you loaded. See page 1.26 for copying, or page 3.7 for PC-printing.

Changing the Paper Size in the Paper Tray

To load longer sizes of paper, such as Legal-sized paper, you need to adjust the paper guides to extend the paper tray.

- 1 After pressing and unlatching the guide lock, slide the paper length guide outward as far as it will go. This extends the length of the tray.

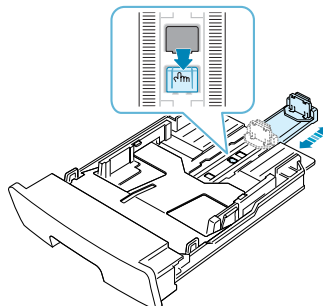

- 2 After inserting paper into the tray, slide in the guide until it lightly touches the end of the paper stack. For paper smaller than letter, adjust the paper length guide accordingly.

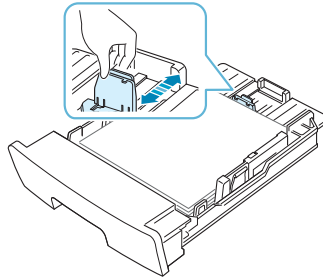

- 3 Pinching the paper width guide as shown, move it toward the stack of paper until it lightly touches the side of the stack.

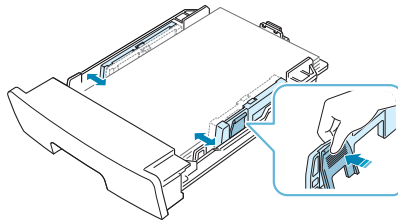

NOTES:

- Do not push the paper width guide far enough to cause the materials to warp.
- If you do not adjust the paper width guide, it may cause paper jams.

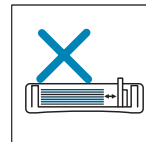
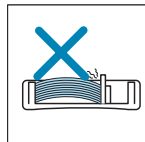
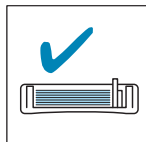

Making Connections

To print from your computer, you need to connect your printer to your computer with either a parallel interface cable or a Universal Serial Bus (USB) cable.

Using a Parallel Cable (Windows only)



NOTE: To connect the printer to the parallel port of the computer requires a certified parallel cable. You will need to buy a IEEE1284 compliant cable.

- 1 Make sure that both the printer and the computer are turned off.
- 2 Plug the parallel printer cable into the connector on the back of the printer.

Push the metal clips down to fit inside the notches on the cable plug.

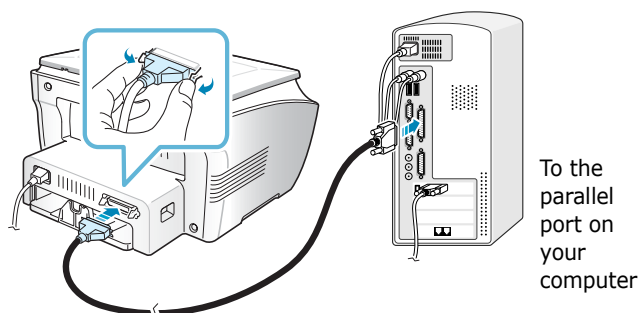

- 3 Connect the other end of the cable to the parallel interface port on your computer, and tighten the screws.

See your computer User's Guide if you need help.

Using a USB Cable



NOTE: Connecting the printer to the USB port of the computer requires a certified USB cable. You will need to buy a USB 1.1 compliant cable that is within 3m in length.

- 1 Make sure that both the printer and the computer are turned off.

- 2 Plug the USB printer cable into the connector on the back of the printer.

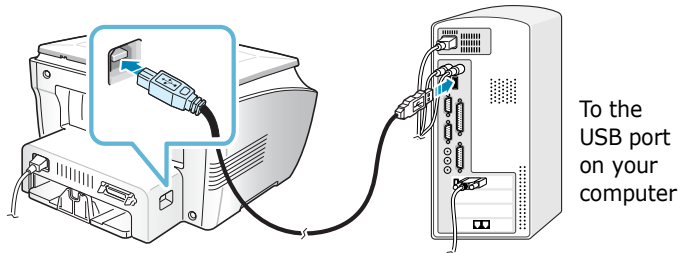

- 3 Connect the other end of the cable to the USB port on your computer.

See your computer User's Guide if you need help.



NOTES:

- For using a USB cable, you must be running Windows 98/Me/2000/XP.
 - When using the USB connection, your machine provides two USB modes; Fast and Slow. Fast is the default mode. Some PC users may experience poor USB function in the default mode. If this occurs, select the Slow mode to achieve successful results. For details about changing the USB mode, see page 8.12.
-

Turning the Machine On

- 1 Plug one end of the supplied three-pronged electrical type cord into the AC socket on the machine and the other end into a properly grounded AC outlet.
- 2 Press the power switch to turn the machine on. "Warming Up Please Wait" appears on the display indicating that the machine is now on.

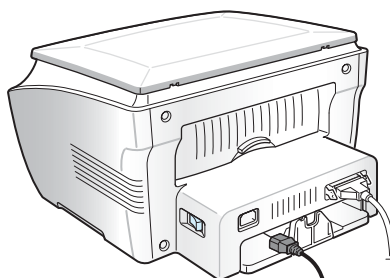

◀ To the AC outlet

To view your display text in another language, see page 1.25.



CAUTIONS:

- The fusing area inside the rear part of your machine becomes hot once the machine is turned on. Be careful when you access this area.
- Do not disassemble the machine when it is turned on as it may give you an electric shock.

Installing Software

About Samsung Software

You must install software using the supplied CD-ROM after you have set up your machine and connected it to your computer. The CD-ROM includes:

- Samsung software
- User's Guides
- Adobe Acrobat Reader

The CD-ROM provides you with the following software:

Windows GDI Driver

To use your machine as a printer and scanner in Windows, you must install the GDI driver. For information about installing the GDI driver in Windows, see page 1.16.

Linux Driver

You can print and scan in Linux using your machine. For information about installing the printer driver in Linux, see Chapter 6 "Using Your Printer in Linux".

SmarThru Software

SmarThru is the accompanying Windows-based software for your multifunctional machine. SmarThru contains a powerful image editor that allows you to edit images in many ways and also includes powerful Internet mail client software. With SmarThru, you can save the scanned images in a dedicated storage area for subsequent editing, sending via e-mail, printing and processing by other programs of your choice.

Remote Control Panel

This Window-based program is automatically installed when you install the GDI driver. For information about using the program, see page 7.10.

Printer Driver Features

Your printer drivers support the following standard features:

- Paper source selection
- Paper size, orientation and media type
- number of copies

The following table lists a general overview of features supported by your printer drivers.

Feature	Printer Driver			
	Win9x/Me	Win2000/XP	WinNT4.0	Linux
Toner Save	Y	Y	Y	Y
Print quality option	Y	Y	Y	Y
Poster printing	Y	Y	Y	N
Multiple pages per sheet (N-up)	Y	Y	Y	Y(2,4)
Fit to page printing	Y	Y	Y	Y
Scale printing	Y	Y	Y	Y
Watermark	Y	Y	Y	N
Overlay	Y	Y	Y	N

Installing Samsung Software in Windows

System Requirements

Before you begin, ensure that your system meets the minimum requirements.

Verify the following:

Item	Requirements	
Operating system	Windows 95/98/Me/NT 4.0/2000/XP	
CPU	95/98/Me/NT 4.0/2000	Pentium II 400 or higher
	XP	Pentium II 933 Ghz or higher
RAM	95/98/Me/NT 4.0/2000	64 MB or higher
	XP	128 MB or higher
Free disk space	95/98/Me/NT 4.0/2000	300 MB or higher
	XP	1 GB or higher
At least Internet Explorer 5.0		



NOTES:

- For Windows NT 4.0/2000/XP, the system administrator should install the software.
 - Windows 95 versions prior to OSR2 are not recommended due to incompatibility with OLE/COM libraries.
-

Installing Samsung Software



NOTES:

- Cancel the “**New Hardware Found**” window when your computer boots up.
- Make sure that your machine is turned on and connected to your computer’s parallel port or USB port **before installing software**. Windows 95 and Windows NT 4.0 do not support the USB connection.

1 Insert the supplied CD-ROM into your CD-ROM drive.

The CD-ROM should automatically run and an installation window appears.

If the installation window does not appear, click **Start** and then **Run**. Type **X:\Setup.exe**, replacing “**X**” with the letter of your drive and click **OK**.

2 When the following window opens, connect your machine to the computer and turn the printer on. Then click **Next**.

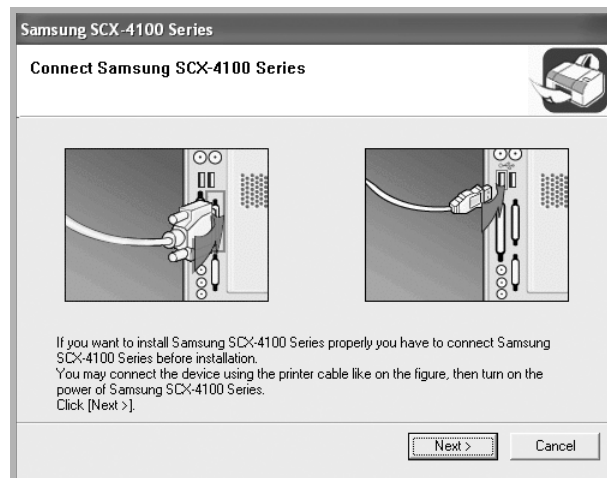

If the machine is already connected and turned on, this screen does not appear. Skip to the next step.



NOTE: If you click **Next** and the machine is not connected to the computer, an alert message window appears. After connecting the machine and turning it on, click **Yes**. Or, if you want to install the software without the machine, Click **No**.

3 Choose the installation type.



- **Typical:** Installs the common software for your printer, such as printer driver, Twain driver, Remote Control Panel. This is Recommended for most users.
- **Custom:** Allows you to choose the language of the software and the components you want to install. After selecting the language and the component(s), click **Next**.

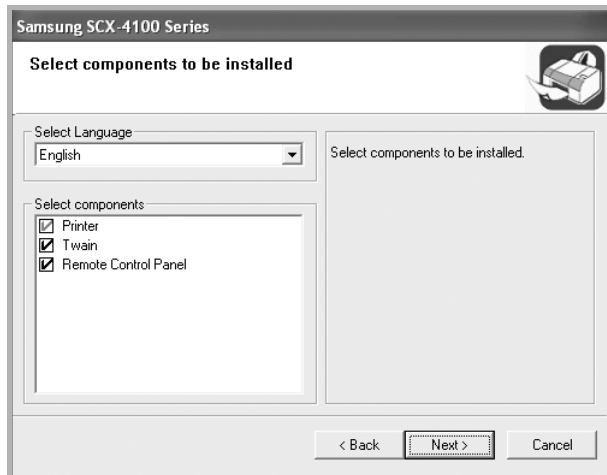

- **Install SmarThru:** Installs the SmarThru program. If you select to install SmarThru on this screen, follow from step 3 on page 1.20.
- **View User's Guide:** Allows you to view this User's Guide. If your computer doesn't have Adobe Acrobat, click on this option and it will automatically install Adobe Acrobat for you.

4 After the installation is finished, the window asking you to print a test page appears. If you choose to print a test page, select the check box and click **Next**. Otherwise, Skip to step 6.

5 When the test page prints out correctly, click **Yes**.

If not, click **No** to reprint it.

6 To register yourself as a user of Samsung Printers, select the check box and click **Finish**. You are now accessed to the Samsung web site.

Otherwise, just click **Finish**.



NOTES:

- When you want to use your machine with the parallel cable, remove the USB cable and connect the parallel cable. Then reinstall the printer driver; select **Start** → **Programs** → **Samsung SCX-4100 Series** → **Maintenance** → **Repair** → **Printer**. If you have replaced the parallel cable with the USB cable, do the same to reinstall the driver.
- If your printer doesn't work properly, reinstall the printer driver.

Installing Samsung SmarThru



NOTE: SmarThru 4 does not support Windows 95.

- 1 Insert the supplied CD-ROM into your CD-ROM drive.
- 2 Click **Install SmarThru**.

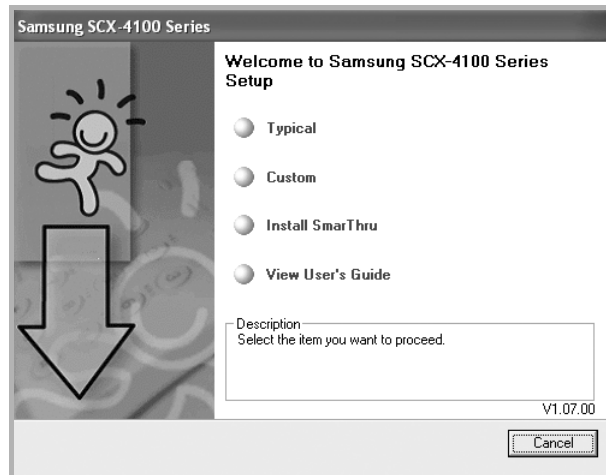

- 3 Click **Next**.
- 4 Follow the on-screen instructions and click **Next**.
- 5 Click **Next**.
- 6 Select the installation type and click **Next**.

The software installation supports two types of setup:

- **Typical:** Program will be installed with the most common options and is recommended for most users.
- **Custom:** You may choose the options you want to install.

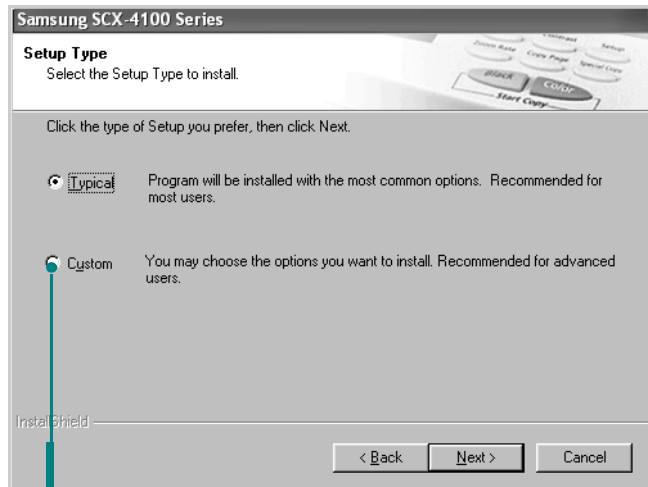

If you select the Custom installation, you may choose the components you want to install.

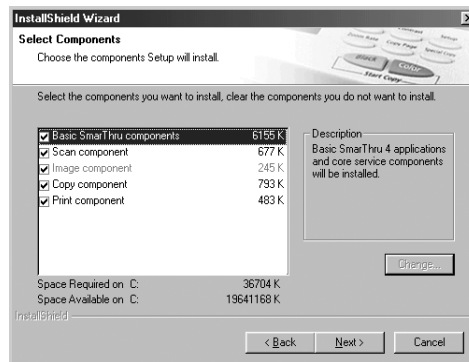

- **Basic SmarThru components:** to use the basic SmarThru 4 applications and core service.
- **Scan components:** to scan the original document and save it in an application or folder, email it, or publish it on a web site.
- **Image components:** to edit an images you have saved as a graphic file.
- **Copy components:** to produce professional quality copies.
- **Print components:** to print images you have saved.

7 Follow the on-screen instructions to complete the installation.

- 8 When the installation is finished, click **Finish**.

Repairing Software

Repairing is required if your installation fails or the software does not work properly. This Repairing procedure does not repair SmarThru software.

- 1 You can select **Start** → **Programs** → **Samsung SCX-4100 Series** → **Maintenance**.

Otherwise, Insert the supplied CD-ROM into your CD-ROM drive.

- 2 Click **Repair**.

NOTE: If your machine is not connected to the computer, the Connect Samsung SCX-4100 Series window opens. After connecting the machine, click **Next**.

- 3 Select the components you want to reinstall and click **Next**.

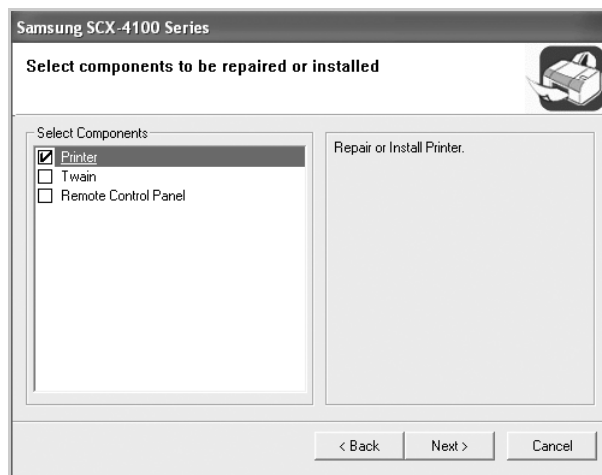

If you choose to repair the printer software, the window asking you to print a test page appears. Do as follows:

- a. To print a test page, select the check box and click **Next**.
- b. When the test page prints out correctly, click **Yes**. If not, click **No** to reprint it.

- 4 When the reinstallation is done, click **Finish**.

Removing Software

Uninstall is required if you are upgrading the software or if your installation fails. You can uninstall the item you want using the Windows uninstallShield.

Uninstalling the MFP Driver

- 1 You can select **Start** → **Programs** → **Samsung SCX-4100 Series** → **Maintenance**.

Otherwise, Insert the supplied CD-ROM into your CD-ROM drive.

- 2 Click **Remove**.

Then you will see a component list so that you can remove any of them individually.

If you want to uninstall the printer driver, check **Printer**.

If you want to uninstall the twain driver, check **Twain**.

If you want to uninstall the Remote Control Panel, check **Remote Control Panel**.

- 3 After selecting items you wish to remove, click **Next**.

- 4 When your computer asks you to confirm your selection, click **Yes**.

The selected driver and all of its components are removed from your computer.

- 5 When the uninstallation is done, click **Finish**.

Uninstalling Samsung SmarThru



NOTE: Before beginning uninstallation, ensure that all applications are closed on your computer. A system reboot is required after the software is uninstalled.

- 1** From the **Start** menu, select **Programs**.
- 2** Select **SmarThru 4**, and then select **Uninstall SmarThru 4**.
- 3** When your computer asks you to confirm, click **OK**.
- 4** Click **Finish**.

When your computer doesn't shut down and restart automatically, you must shut it down manually and restart it before the changes are saved.

Setting Up the Machine System

Changing the Display Language

To change the language that displays on the display of the control panel, follow these steps:

- 1** Press **Menu/Exit** until "Machine Setup" appears on the top line of the display.
- 2** Press the scroll button (◀ or ▶) until "Language" appears on the bottom line of the display.
- 3** Press **Start/Enter**. The current setting appears on the bottom line of the display.
- 4** Press the scroll button (◀ or ▶) until the language you want appears on the display.
- 5** Press **Start/Enter** to save the selection.
- 6** To return to Standby mode, press **Stop/Clear**.

Setting the Paper Size and Type

After loading paper in the paper tray, you need to set the paper type and size using the control panel buttons. These settings will apply to Copy modes. For PC-printing, you need to select the paper type and size in the application program you use.

To set the paper size for the paper tray:

- 1** Press **Menu/Exit** until "Paper Setting" appears on the top line.
The first menu item, "Paper Size", appears on the bottom line.
- 2** Press **Start/Enter** to access the menu item.
- 3** Press **Start/Enter** when "Tray Paper" displays on the bottom line.
- 4** Use the scroll button (◀ or ▶) to find the paper size you are using and press **Start/Enter** to save it.
- 5** To return to Standby mode, press **Stop/Clear**.

To set the paper type for the paper tray:

- 1** Press **Menu/Exit** until "Paper Setting" appears on the top line.
- 2** Press the ▶ button to display "Paper Type" on the bottom line and press **Start/Enter** to access the menu item.
- 3** Use the scroll button (◀ or ▶) to find the paper type you are using and press **Start/Enter** to save it.
- 4** To return to Standby mode, press **Stop/Clear**.

Using the Save Modes

Toner Save Mode

Toner Save mode allows your machine to use less toner on each page. Activating this mode extends the life of the toner cartridge longer than normal, but it reduces the print quality.

To turn the toner save mode on or off:

- 1 Press **Menu/Exit** until "Toner Save" appears on top line of the display.
- 2 Press the scroll button (◀ or ▶) to display "On" on the bottom line and press **Start/Enter**.

Selecting "Off" means that toner save mode turns off.



NOTE: For PC-printing, you can also turn toner save mode on or off, in the printer properties. See page 3.9.

Power Save Mode

Power Save mode allows your machine to reduce power consumption when it is not in actual use. You can turn this mode on by selecting the length of time for which the machine waits after a job is printed before it switches to a reduced power state.

- 1 Press **Menu/Exit** until "Machine Setup" appears on top line of the display.
- 2 Press the scroll button (◀ or ▶) until "Power Save" appears on the bottom line. Press **Start/Enter**.
- 3 Press the scroll button (◀ or ▶) to display "On" on the bottom line and press **Start/Enter**.

Selecting "Off" means that Power Save mode turns off.

- 4 Press the scroll button (◀ or ▶) until the time settings you want appears.

The available options are 5, 10, 15, 30 and 45 (minutes).

- 5 Press **Start/Enter** to save the selection.
- 6 To return to Standby mode, press **Stop/Clear**.

MEMO



2

PAPER HANDLING

This chapter introduces you to the basics of selecting print materials and loading them into your machine.

This chapter includes:

- **Selecting Print Materials**
- **Selecting an Output Location**
- **Loading Paper in the Paper Tray**
- **Using the Manual Feeder**

Selecting Print Materials

You can print on a variety of print materials, such as plain paper, envelopes, labels, transparencies, and so on. Always use print materials that meet the guidelines for use with this machine. See "Paper Specifications" on page A.5. To get the best possible print quality, use only high-quality copier-grade paper.

When you choose print materials, consider the following:

- **Desired outcome:** The paper you choose should be appropriate for your project.
- **Size:** You can use any size paper that fits easily within the paper adjusters of the paper tray.
- **Weight:** Your machine supports paper weights as follows:
 - 16 ~ 24 lbs (60 ~ 90 g/m²) bond for the paper tray
 - 16 ~ 43 lbs (60 ~ 163 g/m²) bond for the manual feeder
- **Brightness:** Some papers are whiter than others and produce sharper, more vibrant images.
- **Surface smoothness:** The smoothness of the paper affects how crisp the printing looks on the paper.



CAUTION: Using print materials that does not conform to the specifications listed "Paper Specifications" on page A.5 may cause problems that may require service. This service is not covered by the warranty or service agreements.

Type, Input Sources and Capacities

Paper Type	Input Source/Capacity*	
	Paper Tray	Manual Feeder
Plain paper	250	1
Envelopes	-	1
Labels**	-	1
Transparency films**	-	1
Card stocks**	-	1

* Maximum capacity may be reduced depending on the paper thickness.

** If you experience excessive jamming, load one sheet at a time through the manual feeder.

Guidelines for Paper and Special Materials

When selecting or loading paper, envelopes, or other special material, keep these guidelines in mind:

- Always use paper and other materials that conform with the specifications listed under "Paper Specifications" on page A.5.
- Attempting to print on damp, curled, wrinkled, or torn paper can cause paper jams and the poor print quality.
- Use only high quality copier grade paper for the best print quality.
- Avoid paper with embossed lettering, perforations, or a texture that is too smooth or too rough. Paper jams may occur.
- Store paper in its ream wrapper until you are ready to use. Place cartons on pallets or shelves, not on the floor. Do not place heavy objects on top of the paper, whether it is packaged or unpackaged. Keep it away from moisture, or other conditions that can cause it to wrinkle or curl.
- Store unused materials at temperatures between 15 °C and 30 °C (59 °F to 86 °F). The relative humidity should be between 10 % and 70 %.
- During storage, you should use moisture-proof wrap, such as any plastic container or bag, to prevent dust and moisture from contaminating your paper.
- Load special paper types one sheet at a time.
- Only use materials specifically recommended for use in laser printers.
- To prevent special materials, such as transparencies and label sheets from sticking together, remove them as they prints out.
- For envelopes:
 - Use only well-constructed envelopes with sharp, well creased folds.
 - Do not use envelopes with clasps and snaps.
 - Do not use envelopes with windows, coated lining, self-adhesive seals, or other synthetic materials.
 - Do not use damaged or poorly made envelopes.
- For transparencies:
 - Place them on a flat surface after removing them from the machine.
 - Do not leave them in the paper tray for long periods of time. Dust and dirt may accumulate on them resulting in spotty printing.

- To avoid smudging caused by fingerprints, handle them and coated paper carefully.
- To avoid fading, do not expose the printed transparencies to prolonged sunlight.
- For labels:
 - Verify that their adhesive material can tolerate fusing temperature of 208 °C (406.4° F) for 0.1 second.
 - Make sure that there is no exposed adhesive material between them. Exposed areas can cause labels to peel off during printing, which can cause paper jams. Exposed adhesive can also cause damage to machine components.
 - Do not load a sheet of them through the machine more than once. The adhesive backing is designed for one pass through the machine.
 - Do not use labels that are separating from the backing sheet or are wrinkled, bubbled, or otherwise damaged.
- Do not use **Carbonless** paper and **Tracing** paper. Use of these types of paper could result in chemical smells and could damage your printer.

Selecting an Output Location

The machine has two output locations; the rear output slot (face up) and the front output tray (face down).

To use the front output tray, make sure that the rear cover is closed. To use the rear output slot, open the rear cover.



NOTES:

- If paper coming out of the front output tray has problems, such as excessive curl, try printing to the rear output slot.
 - To avoid paper jams, do not open or close the rear cover while the machine is printing.
-

Printing to the Front Output Tray *(Face down)*

The front output tray collects printed paper face-down in the order in which it was printed. The tray should be used for most print jobs.

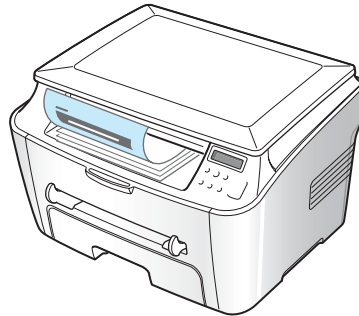

2

If you use paper which is not long enough to reach the front output tray, use the jam cover.

To use the jam cover:

- 1 Lift the jam cover. A tab automatically springs up to support the cover.

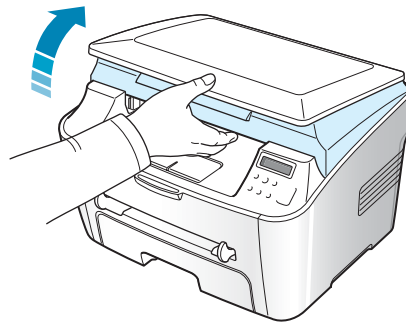

- 2 Take the paper out manually.

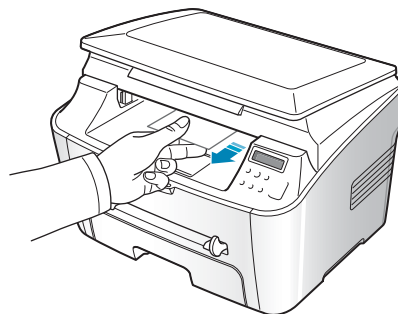

- 3** Close the jam cover. In order to close the cover, push the tab to the left and hold it down. Then lower the cover carefully until the cover is holding down the tab. Then you can move your hand and finish lowering the cover.

Be careful not to pinch your fingers!

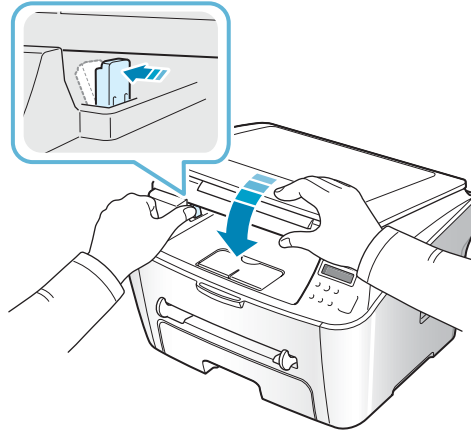

NOTE:

- If you continuously print many pages, the surface of the output tray may become hot. Be careful not to touch the surface, and especially keep children away from the surface.
- The front output tray can hold up to 50 sheets of paper. Remove the pages so that the tray is not overloaded.

Printing to the Rear Output Slot *(Face up)*

Using the rear output slot, paper comes out of the machine face up.

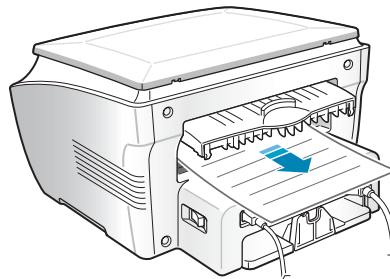

Printing from the manual feeder to the rear output slot provides a **straight paper path**. Using the rear output slot might improve the output quality with the following:

- envelopes
- labels
- small custom-sized paper
- postcards
- transparencies

To use the rear output slot:

- 1 Open the rear cover by pulling it upward.

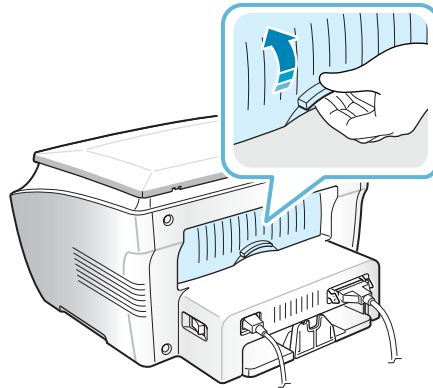

CAUTION: The fusing area inside the rear part of your machine becomes hot once the machine is turned on. Be careful when you access this area.

- 2 If you do not want to use the rear output slot, close the rear cover. The pages stack on the front output tray.

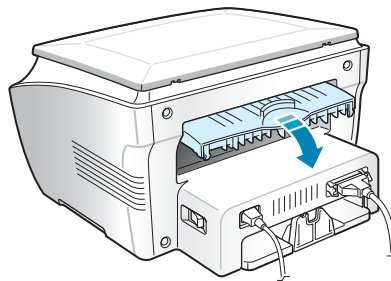

Loading Paper in the Paper Tray

The paper tray can hold a maximum of 250 sheets of 20 lb(75g/m²) plain paper. For copying, you can use A4-, Letter- or Legal-sized paper only. For PC-printing, you can use many different sizes of paper; see page A.6.

To load paper, pull open the paper tray and load paper with the print side **face down**.

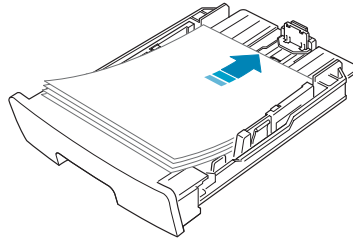

You can load letterhead paper with the design side face down. The top edge of the sheet with the logo should be placed at the front side of the tray.

For details about loading paper in the paper tray, see "Loading Paper" on page 1.8.



NOTES:

- If you experience problems with paper feed, place the paper in the manual feeder.
 - You can load previously printed paper. The printed side should be facing up with an uncurled edge on top. If you experience problems with paper feed, turn the paper around. Note that the print quality is not guaranteed.
-

Using the Manual Feeder

Use the manual feeder to print transparencies, labels, envelopes or postcards in addition to making quick runs of paper types or sizes that are not currently loaded in the paper tray.

Postcards, 3.5 by 5.83 in.(index) cards and other custom-sized materials can be printed with this printer. The minimum size is 76 by 127 mm (3.0 by 5.0 in.) and the maximum size is 216 by 356 mm (8.5 by 14 in.).

Acceptable print materials are plain paper with sizes ranging from 100 x 148 mm (3.9 x 5.8 in.) to Legal, 216 x 356 mm (8.5 x 14 in.), the largest size acceptable, and weighing between 16 lb and 32 lb.



NOTES:

- Always load only the print materials specified in the Specifications on page A.5 to avoid paper jams and print quality problems.
- Flatten any curl on postcards, envelopes and labels before loading them into the manual feeder.
- When you print on 76 mm X 127 mm (3 X 5 in.) sized media with loading into the tray, open the rear output tray.

- 1** Load a sheet of the print material with the print side **face up** into the center of the manual feeder.

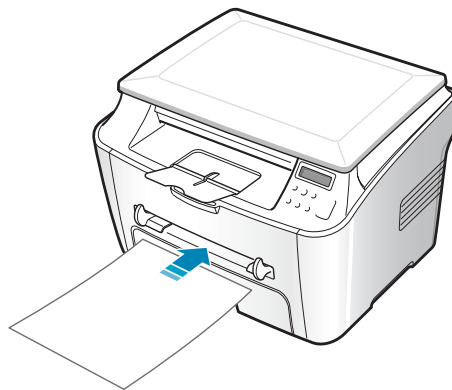

For envelopes, load a sheet with the flap side face down and with the stamp area on the top left side.

For transparencies, hold them by the edges and avoid touching the print side. Oils from your fingers can cause print quality problems.

For letterhead, load a sheet with the design face up, top edge towards the printer.



CAUTION: You must open the rear output slot when you print on transparencies. If not, they may tear while exiting the machine.

2 Adjust the paper guide to the width of the print material.

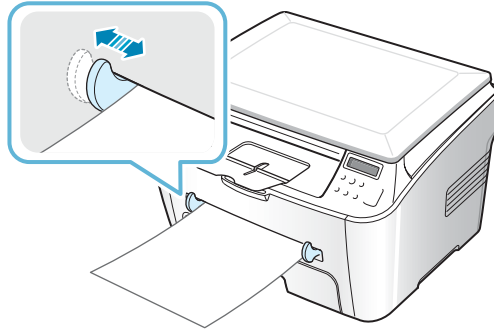

NOTE: When printing on previously printed paper from the manual feeder, the printed side should be facing down with an uncurled edge to the machine. If you experience problems with paper feed, turn the paper around.

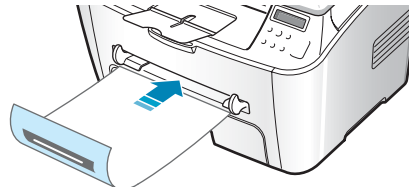

3 Open the rear cover to use the rear output slot.

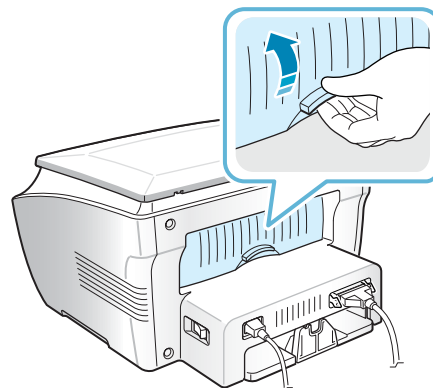

4 After printing, close the rear cover.

Setting the Paper Type and Size for the Manual Feeder

After loading paper in the manual feeder, you need to set the correct paper type and size using the control panel buttons. These settings will apply to Copy mode. For PC-printing, you need to select the paper size in the application program you use.

To set the paper size for the manual feeder:

- 1 Press **Menu/Exit** until "Paper Setting" appears on the top line of the display.

The first item, "Paper Size", displays on the bottom line.

- 2 Press **Start/Enter** to access the menu item.
- 3 Use the scroll button (◀ or ▶) to display "Manual Feed" on the bottom line. Press **Start/Enter** to access the menu item.
- 4 Use the scroll button (◀ or ▶) to find the paper size you are using and press **Start/Enter** to save it.
- 5 To return to Standby mode, press **Stop/Clear**.

To set the paper type for the manual feeder:

- 1 Press **Menu/Exit** until "Paper Setting" appears on the top line of the display.
- 2 Press the ▶ button to display "Paper Type" on the bottom line and press **Start/Enter** to access the menu item.
- 3 Use the scroll button (◀ or ▶) to find the paper type you are using and press **Start/Enter** to save it.
- 4 To return to Standby mode, press **Stop/Clear**.

MEMO



2.12 PAPER HANDLING

3

PRINTING

This chapter explains how to print your documents in Windows and how to use the print settings.

This chapter includes:

- **Printing a Document in Windows**
- **Setting Paper Properties**
- **Setting Graphic Properties**
- **Printing Multiple Pages on One Sheet of the Paper**
- **Printing a Reduced or Enlarged Document**
- **Fitting Your Document to a Selected Paper Size**
- **Printing Posters**
- **Using Watermarks**
- **Using Overlays**
- **Setting Up the Locally Shared Printer**

Printing a Document in Windows

The following procedure describes the general steps required for printing from various Windows applications. The exact steps for printing a document may vary depending on the application program you are using. Refer to your software application's user's guide for the exact printing procedure.

- 1 Open the document you want to print.
- 2 Select **Print** from the **File** menu.

The Print window opens. It may look slightly different depending on your application.

You can select the basic print settings within the Print window. These settings include the number of copies and the print range.

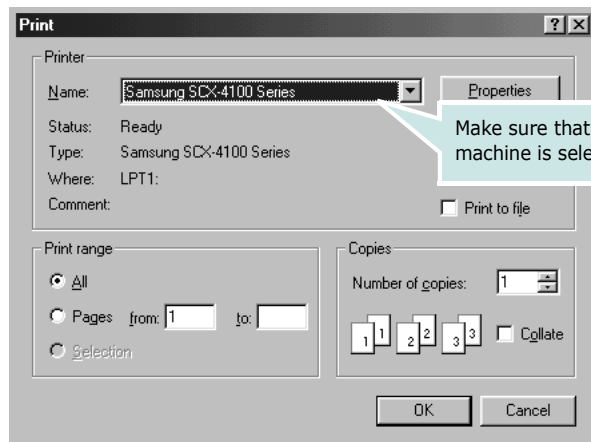

▲ Windows 98

- 3 To take advantage of the printer features provided by your machine, click **Properties** or **Preferences** in the application's print window and go to step 4.

If you see a **Setup**, **Printer** or **Options** button, click it instead. Then click **Properties** on the next screen.

- 4 Now you see the Samsung SCX-4100 Series Properties window, which allows you to access all of information you need when using your machine.

The **Layout** tab first displays.

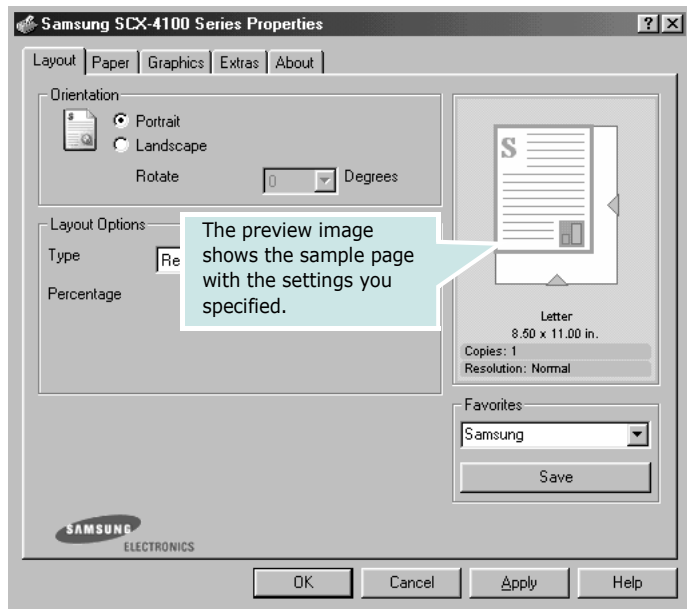

If necessary, select the **Orientation** option.

The **Orientation** option allows you to select the direction in which information is printed on a page.

- **Portrait** prints across the width of the page, letter style.
- **Landscape** prints across the length of the page, spreadsheet style.
- If you want to turn the page upside down, select **180** from the **Rotate** drop-down list.



▲ Landscape



▲ Portrait

- 5 From the **Paper** tab, select the paper source, size and type. For further details, see page 3.7.

- 6 If necessary, you can set the sequence for the pages to print from the **Extras** tab. Select the print order you want to use from the **Printer Order** drop-down list.
 - **Normal**: Your machine prints from the first page to the last page.
 - **Reverse All Pages**: Your machine prints from the last page to the first page.
 - **Print Odd Pages**: Your machine prints only the odd pages of the document.
 - **Print Even Pages**: Your machine prints only the even pages of the document.
- 7 Click other tabs on the top of the Samsung SCX-4100 Series Properties window to access other features, if needed.
- 8 When you finish setting the properties, click **OK** until the Print window displays.
- 9 Click **OK** to start printing.

The printer's Properties window may differ, depending on your operating system. This User's Guide shows the Properties window on windows 98.



NOTES:

- Most Windows applications overrides the settings you specified in the printer driver. Change all of the print settings available in the software application first, and change any remaining settings using the printer driver.
 - The settings you change remain in effect only while you are using the current program. To make your changes permanent, make them in the **Printers** folder. Follow these steps:
 1. Click the Windows **Start** menu.
 2. For Windows 95/98/Me/NT 4.0/2000, select **Settings** and then **Printers**.
For Windows XP, select **Printers and Faxes**.
 3. Select the **Samsung SCX-4100 Series** printer.
 4. Click the right mouse button on the printer icon and:
 - For Windows 95/98/Me, select **Properties**.
 - For Windows 2000/XP, select **Printing Preferences**.
 - For Windows NT 4.0, select **Document Default**.
 5. Change the settings on each tab and click **OK**.
-

Canceling a Print Job

There are two ways to cancel a print job:

To stop a print job from the control panel:

Press the **Stop/Clear** button.

Your machine finishes printing the page that is moving through the machine and deletes the rest of the print job. Pressing the button cancels only the current job. If more than one print job is in the machine's memory, you need to press the button once for each job.

To stop a print job from the Printers folder:

If the print job is waiting in a print queue or print spooler, such as the Printer group in Windows, delete the job as follows:

- 1 Click the Windows **Start** menu.
- 2 For Windows 9x/NT4.0/2000/Me, Select **Settings** and then **Printers**.

For Windows XP, select **Printers and Faxes**.

- 3 Double-click the **Samsung SCX-4100 Series** icon.

- 4 From the **Document** menu:

For Windows 9x/Me, select **Cancel Printing**.

For Windows NT4.0/2000/XP, select **Cancel**.

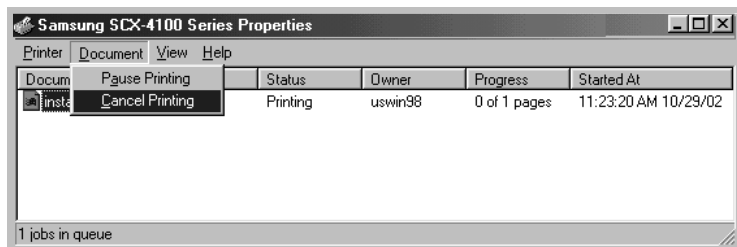

▲ Windows 98



NOTE: You can access this window simply by double-clicking the printer icon at the bottom right corner of the Windows desktop.

Using a Favorite Setting

The **Favorites** option, which is visible on each tab, allows you to save the current properties settings for future use.

To save a Favorites item:

- 1 Change the settings on each tab, as needed.
- 2 Enter a name for the item in the **Favorites** input box.

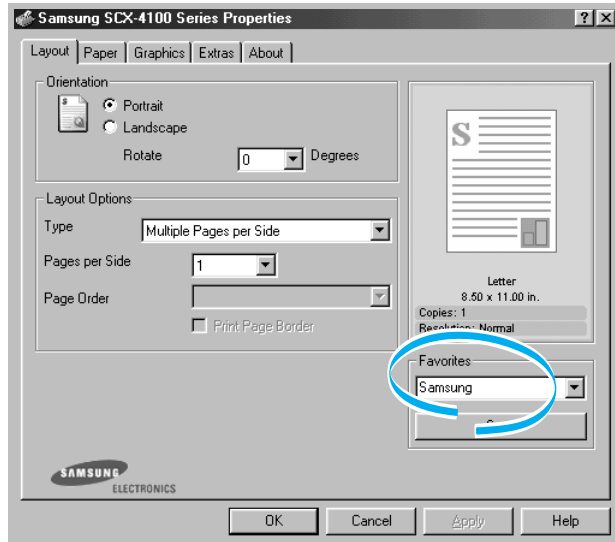

- 3 Click **Save**.

To use a saved setting, select it from the **Favorites** drop-down list.

To delete a favorite setting item, select it from the list and click **Delete**.

You can also restore the printer driver's default settings by selecting **<Printer Default>** from the list.

Using Help

Your machine has a help screen that can be activated using the **Help** button in the printer's Properties window. The help screen gives detailed information about the printer features provided by the printer driver.

You can also click **?** in the upper right hand corner, and then click on any setting.

Setting Paper Properties

Use the following options for paper handling. See page 3.2 for more information about accessing printer's Properties.

Click the **Paper** tab to access many paper properties.

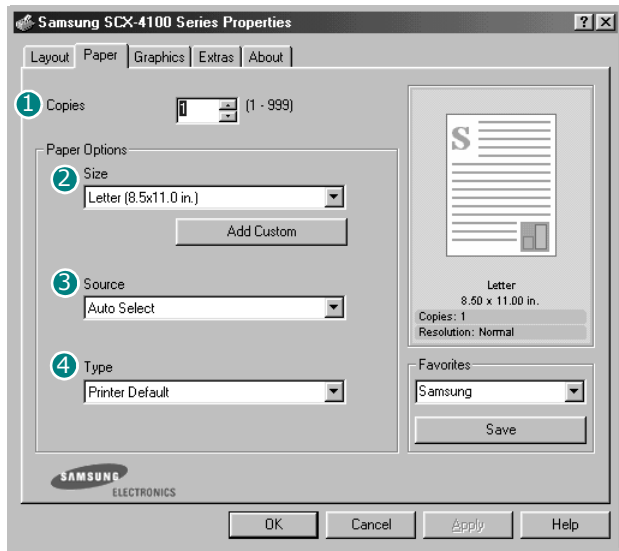

3

Property	Description
1 Copies	Copies allows you to choose the number of copies to be printed. You can enter up to 999.
2 Size	<p>Size allows you to choose the size of the paper loaded in the tray.</p> <p>If the required size is not listed in the Size box, click Add Custom. When the Custom Page Size window appears, set the size and click Ok. The setting appears on the list so that you can select it.</p>

Property	Description
3 Source	<p>Make sure that Source is set to the corresponding paper tray.</p> <p>Use the Manual Feed source when printing to special material. You need to load one sheet at a time into the manual feeder. See page 2.9.</p> <p>If the paper source is set to Auto Select, the machine automatically picks up print material in the following order: the manual feeder and the paper tray.</p>
4 Type	<p>Make sure that Type is set to Printer Default. If you load a different type of print material, select the corresponding paper type. For more information about print materials, see Chapter 2, Paper Handling.</p> <p>If you use cotton paper, set the paper type to Thick for the best printing.</p> <p>To use recycled paper, which weighs from 75g/m² to 90g/m² (20lb to 24lb), or colored paper, select Color Paper.</p>

Setting Graphic Properties

Use the following graphic options to adjust the print quality for your specific printing needs. See page 3.2 for more information about accessing printer properties.

Click the **Graphics** tab to display the properties shown below.

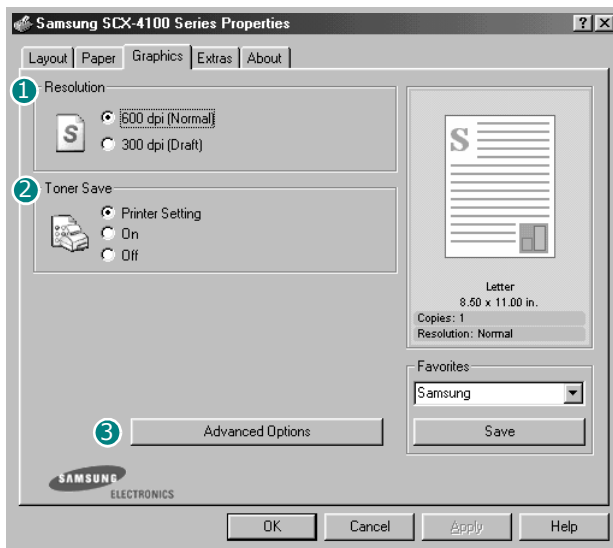

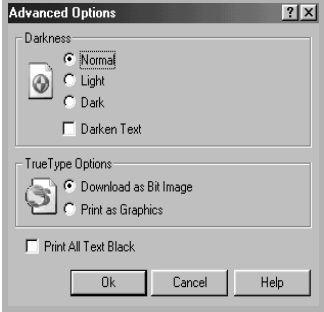
Property	Description
<p>1 Resolution</p>	<p>You can select the printing resolution by choosing from 600 dpi (Normal) or 300 dpi (Draft). The higher the setting, the sharper the printed characters and graphics. Higher settings may increase the time it takes to print a document.</p>
<p>2 Toner Save</p>	<p>Selecting this option extends the life of your toner cartridge and reduces your cost per page without a significant reduction in the print quality.</p> <ul style="list-style-type: none"> • Printer Setting: When you select this option, the Toner Save feature is determined by the setting you've made on the control panel of the machine. • On: Select this option to allow the machine to use less toner on each page. • Off: When you do not need to save toner to print a document, select this option.
<p>3 Advanced Options</p>	<p>You can make advanced settings by clicking the Advanced Options button.</p>  <p>Darkness</p> <p>Use this option to lighten or darken the image appearance in your print.</p> <ul style="list-style-type: none"> • Normal: This setting is for normal documents. • Light: This setting is for bolder line widths or darker grayscale images. • Dark: This setting is for finer line width, higher definition in graphics and lighter grayscale images. <p>When the Darken Text option is checked, all text in your document prints darker than normal.</p>

Property	Description
<p>3 Advanced Options (continued)</p>	<p>True Type Options</p> <p>This option determines what the driver tells the machine about how to image the text in your document. Select the appropriate setting according to the status of your document. This option is available only on Window 9x, Me.</p> <ul style="list-style-type: none"> • Download as Bit Image: When this option is selected, the driver downloads the font data as bitmap images. Documents with complicated fonts, such as Korean or Chinese, or various types of fonts print faster in this setting. • Print as Graphics: When this option is selected, the driver downloads any fonts as graphics. When printing documents with high graphic content and relatively few TrueType fonts, printing performance <p>Print All Text Black</p> <p>When the Print All Text Black option is checked, all text in your document prints in solid black, regardless of the color it appears on the screen. When it is not checked, colored text prints in shades of gray.</p>

Printing Multiple Pages on One Sheet of the Paper

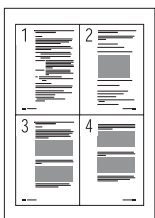

You can select the number of pages to print on a single sheet of paper. To print more than one page per sheet, the pages are smaller and arranged in the order you specified on the sheet. You can print up to 16 pages on one sheet.

- 1 To change the print settings from your software application, access the printer's Properties. See page 3.2.
- 2 From the **Layout** tab, choose **Multiple Pages per Side** from the **Type** drop-down list.

- 3 Select the number of pages you want to print per sheet (1, 2, 4, 9 or 16) on the **Pages per Side** drop-down list.

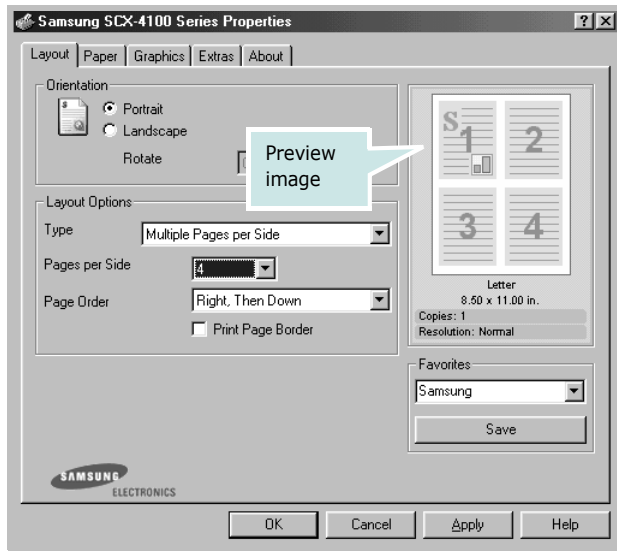

- 4 Select the page order on the **Page Order** drop-down list, if necessary.

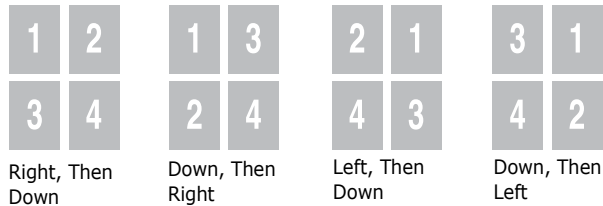

Check **Print Page Border** to print a border around each page on the sheet.



NOTE: Page Order and Print Page Border are enabled only when the number of pages per side is 2, 4, 9 or 16.

- 5 Click the **Paper** tab and select the paper source, size, and type.
- 6 Click **OK** and print the document.

Printing a Reduced or Enlarged Document

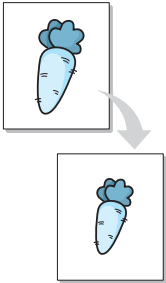

You can scale your print job on a page.

- 1 When you change the print settings from your software application, access the printer's Properties. See page 3.2.
- 2 From the **Layout** tab, select **Reduce/Enlarge** on the **Type** drop-down list.
- 3 Enter the scaling rate in the **Percentage** input box.

You can also click the ▲ or ▼ button.

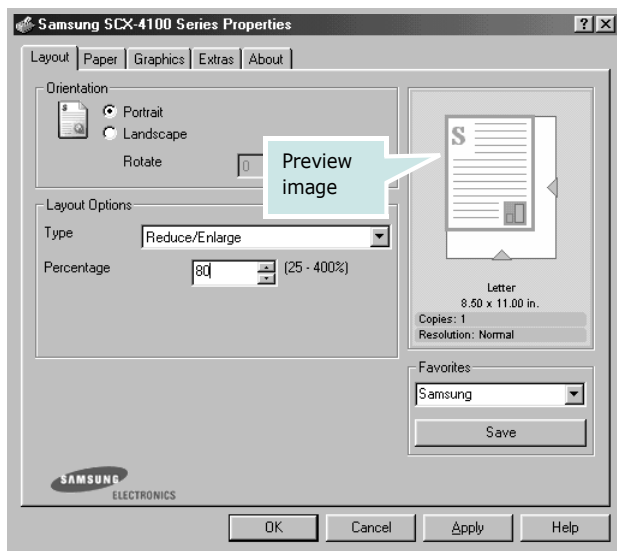

- 4 Click the **Paper** tab and select the paper source, size and type.
- 5 Click **OK** and print the document.

Fitting Your Document to a Selected Paper Size

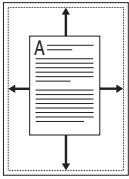

You can scale your print job to any paper size regardless of the digital document size. This can be useful when you want to check the fine details on a small document.

- 1 To change the print settings from your software application, access the printer's Properties. See page 3.2.
- 2 From the **Layout** tab, select **Fit to Page** on the **Type** drop-down list.
- 3 Select the correct size from the **Target Page** drop-down list.

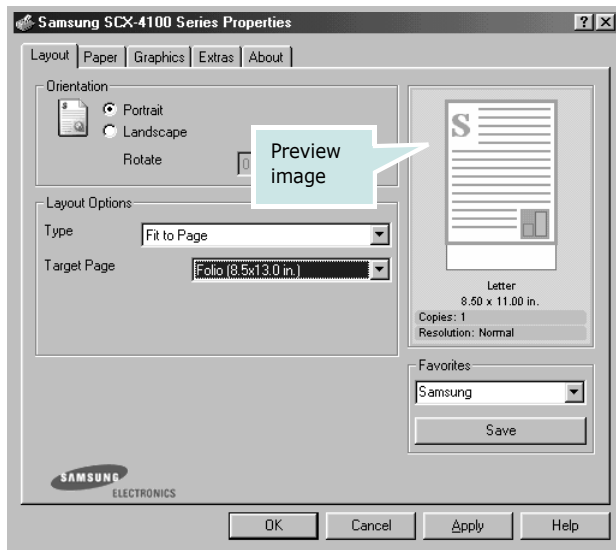

- 4 Click the **Paper** tab and select the paper source and type.
- 5 Click **OK** and print the document.

Printing Posters

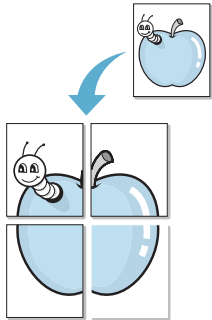

You can print a single-page document onto 4, 9 or 16 sheets of paper, for the purpose of pasting the sheets together to form one poster-sized document.

- 1 To change the print settings from your software application, access the printer's Properties. See page 3.2.
- 2 From the **Layout** tab, select **Poster** on the **Type** drop-down list.

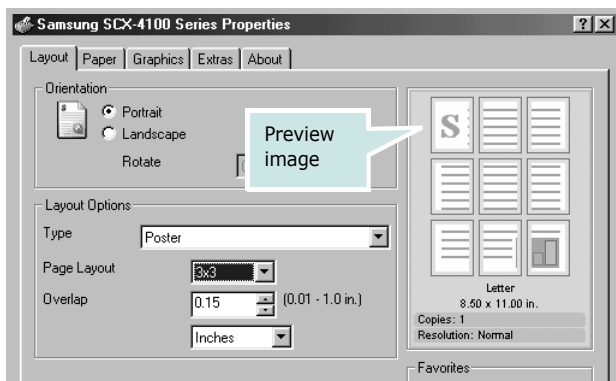

- 3 Configure the poster option:

You can select the page layout from **2x2**, **3x3** or **4x4**. If you select **2x2**, the image is automatically stretched to cover 4 physical pages.

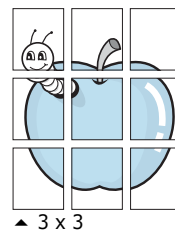
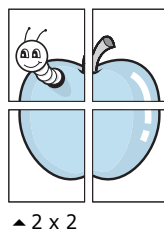

Specify an overlap in millimeters or inches to make it easier to reconstruct the resulting poster.

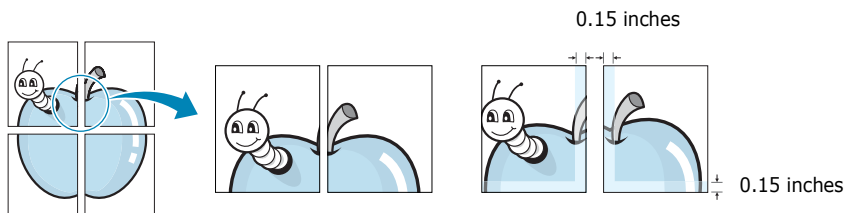

- 4 Click the **Paper** tab and select the paper source, size and type.
- 5 Click **OK** and print the document. You can complete the poster by posting the sheets together.

Using Watermarks



The Watermark option allows you to print text over an existing document. For example, you may want to have large gray letters reading "DRAFT" or "CONFIDENTIAL" printed diagonally across the first page or all of the pages of a document.

There are several predefined watermarks that come with your machine, and they can be modified or you can add new ones to the list.

Using an Existing Watermark

- 1 To change the print settings from your software application, access the printer's Properties. See page 3.2.
- 2 Click the **Extras** tab and select a watermark on the **Watermark** drop-down list. It appears in the preview image window.

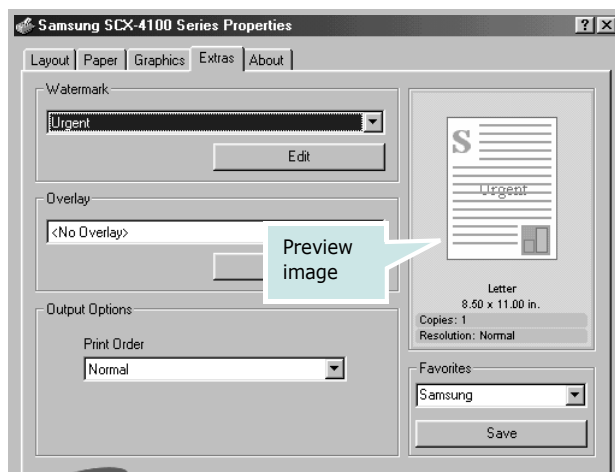

- 3 Click **Ok** and start printing.

Creating a Watermark

- 1 To change the print settings from your software application, access the printer's Properties. See page 3.2.
- 2 Click the **Extras** tab and click **Edit** in the **Watermark** section. The Edit Watermarks window appears.

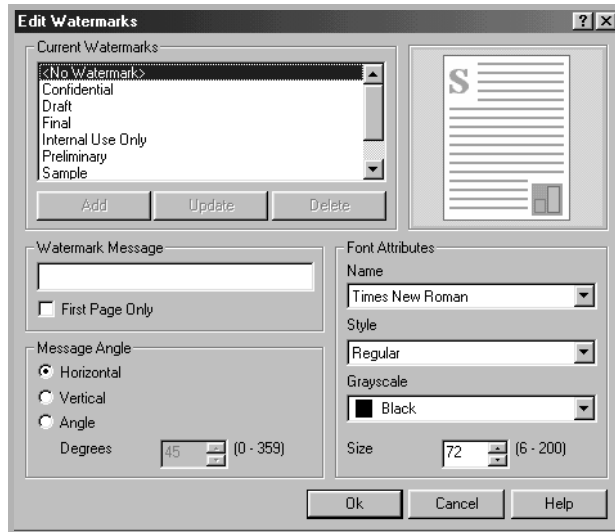

- 3 Enter text message you want to print in the **Watermark Message** box.

The message displays in the preview image window.

When the **First Page Only** box is checked, the watermark prints on the first page only.

- 4 Select the watermark options.

You can select the font name, style, and size, and gray scale level from the **Font Attributes** section and set the angle of the watermark from the **Message Angle** section.

- 5 Click **Add** to add a new watermark to the list.
- 6 When you finish creating, click **Ok** and start printing.

To stop printing the watermark, select **<No Watermark>** on the **Watermark** drop-down list.

Editing a Watermark

- 1 To change the print settings from your software application, access the printer properties. See page 3.2.
- 2 Click the **Extras** tab and click **Edit** in the **Watermark** section. The Edit Watermarks window appears.
- 3 Select the watermark you want to edit on the **Current Watermarks** list, to change the watermark message and the options. Refer to page 3.16.
- 4 Click **Update** to save the changes.
- 5 Click **Ok**.

Deleting a Watermark

- 1 To change the print settings from your software application, access the printer's Properties. See page 3.2.
- 2 From the **Extras** tab, click **Edit** in the **Watermark** section. The Edit Watermarks window appears.
- 3 Select the watermark you want to delete on the **Current Watermarks** list and click **Delete**.
- 4 When a confirming message window appears, click **Yes**.
- 5 Click **Ok**.

Using Overlays

What is an Overlay?

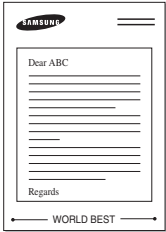

An overlay is text and/or images stored on the computer hard disk drive (HDD) as a special file format that can be printed on any document. Overlays are often used to take the place of pre-printed forms and letterhead paper. Rather than using preprinted letterhead, you can create an overlay containing the exact same information that is currently on your letterhead. To print a letter with your company's letterhead, you need only tell the machine to print the letterhead overlay on your document.

Creating a New Page Overlay

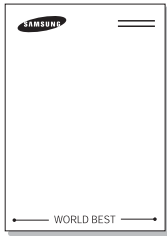

To use a page overlay, you must create a new page overlay containing your logo or image.

- 1 Create or open a document containing text or an image for use in a new page overlay. Position the items exactly as you wish them to appear when printed as an overlay. If needed, save the file for later use.
- 2 To change the print settings from your software application, access the printer's Properties. See page 3.2.
- 3 Click the **Extras** tab and click **Edit** in the **Overlay** section.

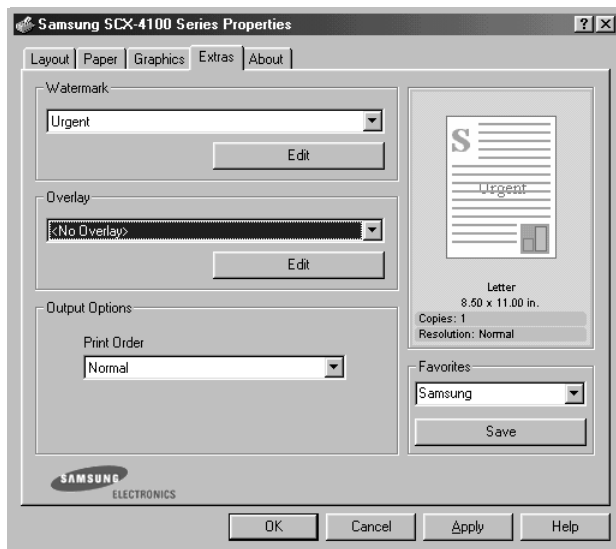

- 4 In the Edit Overlays window, click **Create Overlay**.

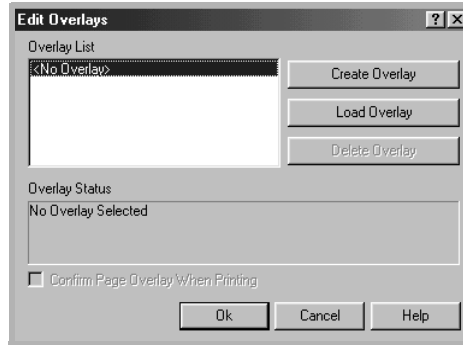

- 5 In the Create Overlay window, type a name of up to eight characters in the **File name** box. Select the destination path, if necessary. (The default is C:\Formover).

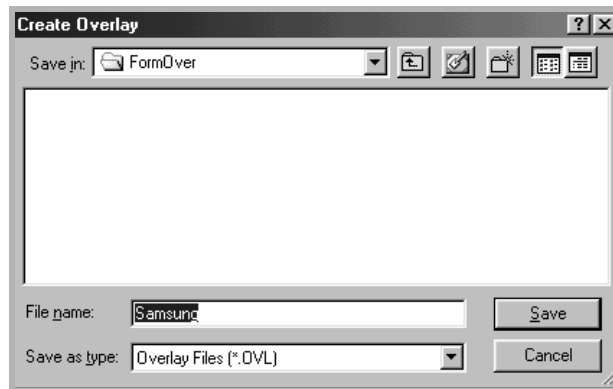

- 6 Click **Save**. The name appears on the Overlay List.
- 7 Click **Ok** or **Yes** to finish creating.

The file is not printed out. Instead it is stored in your computer HDD disk.



NOTE: The overlay document size must be the same as the documents you print with the overlay. Do not create an overlay with a watermark.

Using a Page Overlay

After an overlay has been created, it is ready to be printed with your document. To print an overlay with a document:

- 1 Create or open the document you want to print.
- 2 To change the print settings from your software application, access the printer's Properties. See page 3.2.
- 3 Click the **Extras** tab.
- 4 Select the overlay you want to print from the **Overlay** drop-down list box.
- 5 When the overlay file you want doesn't appear on the Overlay List, click **Edit** and **Load Overlay**, and select the overlay file.

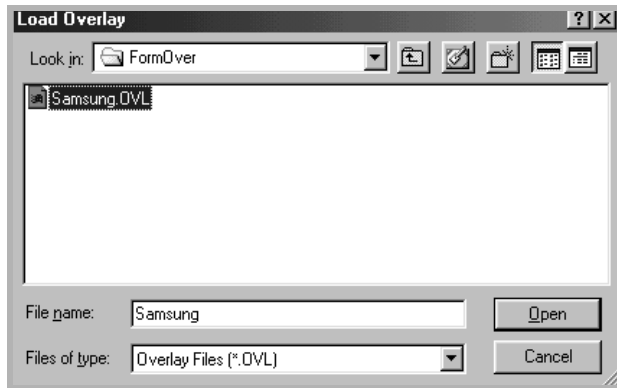

If you have stored the overlay file you want to use in an external source, you can also load the file when you access this Load Overlay window.

After you select the file, click **Open**. The file appears on the Overlay List and is available for printing. Select the overlay from the **Overlay List** box.

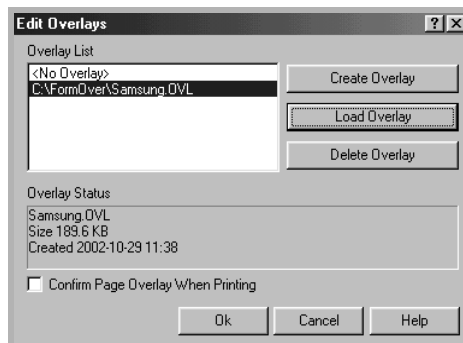

- 6 If necessary, click **Confirm Page Overlay When Printing**. When this box is checked, a message window appears each time you submit a document for printing, asking you to confirm your wish to print an overlay on your document.

Answering **Yes** to the window means that the selected overlay prints with your document. Answering **No** to the window cancels overlay printing.

If this box is empty and an overlay has been selected, the overlay will be automatically printed with your document.

- 7 Click **OK** or **Yes** until the printing starts.

The overlay downloads with your print job and prints on your document.



NOTE: The resolution of the overlay document must be the same as that of the document you will print with the overlay.

Deleting a Page Overlay

You can delete page overlays that you no longer use.

- 1 In the printer's properties window, click the **Extras** tab.
- 2 Click **Edit** in the Overlay section.
- 3 Select the overlay you want to delete from the Overlay List box.
- 4 Click **Delete Overlay**.
- 5 When a confirming message window appears, click **Yes**.
- 6 Click **OK** until you exit the Print window.

Setting Up the Locally Shared Printer

You can connect the machine directly to a selected computer, which is called "host computer," on the network. Your machine can be shared by other users on the network through a Windows 9x, Me, 2000, XP or NT 4.0 network printer connection.



NOTE: Whether the printer is locally connected or network-connected, you need to install the printer software on each computer that will print documents to the printer.

In Windows 9x/Me

Setting Up the Host Computer

- 1 Start Windows.
- 2 From the **Start** menu, select **Control Panel** and double-click on the **Network** icon.
- 3 Check the **File and Print Sharing** box and click **OK**.
- 4 Click **Start** and select **Printers** from **Settings**. Double-click your printer icon.
- 5 Select **Properties** in the **Printer** menu.
- 6 Click the **Sharing** tab and check the **Shared As** box. Fill in the **Share Name** field and then click **OK**.

Setting Up the Client Computer

- 1 Right-click **Start** and select **Explorer**.
- 2 Open your network folder in the left column.
- 3 Right-click the shared name and select **Capture Printer Port**.
- 4 Select the port you want, check the **Reconnect at log on** box and then click **OK**.
- 5 From the **Start** menu, select **Settings** and then **Printers**.
- 6 Double-click your printer icon.
- 7 From the **Printer** menu, select **Properties**.
- 8 From the **Details** tab, select the printer port and click **OK**.

In Windows NT 4.0/2000/XP

Setting Up the Host Computer

- 1 Start Windows.
- 2 For Windows NT 4.0/2000, from the **Start** menu, select **Settings** and then **Printers**.

For Windows XP, from the **Start** menu, select **Printers and Faxes**.
- 3 Double-click your printer icon.
- 4 From the **Printer** menu, select **Sharing**.
- 5 For Windows NT 4.0, check the **Shared** box.

For Windows 2000, check the **Shared As** box.

For Windows XP, check the **Share this printer** box.
- 6 For Windows NT 4.0, fill in the **Share Name** field and click **OK**.

For Windows 2000/XP, fill in the **Shared Name** field and click **OK**.

Setting Up the Client Computer

- 1 Right-click **Start** and select **Explorer**.
- 2 Open your network folder in the left column.
- 3 Click the shared name.
- 4 For Windows NT 4.0/2000, from the **Start** menu, select **Settings** and **Printers**.

For Windows XP, from the **Start** menu, select **Printers and Faxes**.

- 5 Double-click your printer icon.
- 6 From the **Printer** menu, select **Properties**.
- 7 Press the **Ports** tab and click **Add Port**.
- 8 Select **Local Port** and click **New Port**.
- 9 Fill in the **Enter a port name** field and enter the shared name.
- 10 Click **OK** and click **Close**.
- 11 For Windows NT 4.0, click **OK**.
For Windows 2000/XP, click **Apply** and click **OK**.



4

COPYING

This chapter gives you step-by-step instructions for copying documents.

This chapter includes:

- **Loading Paper for Copying**
- **Preparing a Document**
- **Making a Copy**
- **Setting Copy Options**
- **Using Special Copy Features**
- **Changing the Default Settings**
- **Setting the Time Out Option**

Loading Paper for Copying

The instructions for loading print materials are the same whether you are printing, or copying. For copying, you can use Letter-, A4-sized print materials. For further details, see page 1.8 for loading in the paper tray and page 2.9 for loading in the manual feeder.

Preparing a Document

You can use an original document for copying and scanning on the document glass.

Load booklet, pamphlet, or documents having unusual characteristics on the document glass one sheet at a time. On the document glass, you can load the following types of documents:

- Thick paper
- Document with uneven surface
- Photographs
- Small documents (e.g. business cards, postcards)
- Special types of paper

Making a Copy

- 1 Lift and open the document cover.

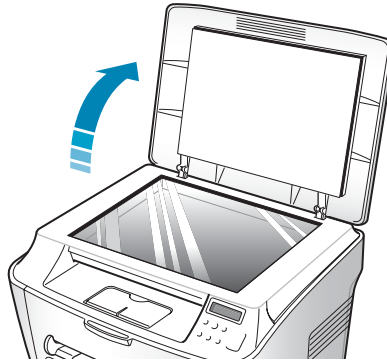

- 2 Place the document **face down** on the document glass.



- 3 Align it with the registration guide on the top left corner of the glass.

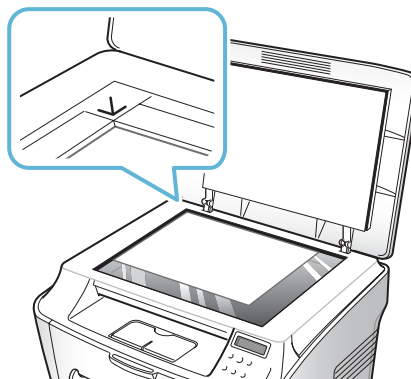

- 4 Close the document cover. Be careful not to move the document.



NOTES:

- Leaving the cover open while copying may affect the copy quality and toner consumption.
- If you are copying a page from a book or magazine which is thicker than 30 mm, start copying with the cover open.

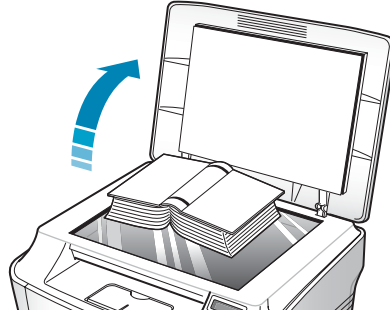

-
- 5** Customize the copy settings including number of copies, copy size, darkness and original type by using the control panel buttons. See "Setting Copy Options" on page 4.5.

To clear the settings, use the **Stop/Clear** button.

- 6** Press **Start/Enter** to begin copying. The display shows the copy processing.



NOTES:

- You can cancel the copy job during an operation. Press **Stop/Clear**, and the copying will stop.
 - Dust on the document glass may cause black spots on the printout. Keep it always clean.
-

Setting Copy Options

The buttons on the control panel let you make all the basic copy options; darkness, number of copies, copy size and document type. Set the following options for the current copy job before pressing **Start/Enter** to make copies.



NOTE: If you press **Stop/Clear** while you set the copy options, all of the options you have set for the current copy job will be canceled and return to their default status. Or, they will automatically return to their default status after the machine completes the copy.

Darkness

If you have an original document containing faint markings and dark images, you can adjust the brightness to make a copy that is easier to read.

To adjust the contrast, press **Darkness**.

You can choose from the following contrast modes:

- **Light:** works well with dark print.
- **Normal:** works well with standard typed or printed documents.
- **Dark:** works well with light print or faint pencil markings.

Number of Copies

Using the **No. of Copies** button, you can select the number of copies from 1 to 99.

- 1** Press **No. of Copies**.
- 2** Press the scroll button (◀ or ▶) until the number you want appears on the display.

Pressing and holding the buttons allows you to quickly increase and decrease in increments of 5.

- 3** Press **Start/Enter** to save the selection.

Reduced/Enlarged Copying



NOTE: When you set Original Type to Photo while using paper larger than A4 size and setting an enlargement rate of more than 100%, Text/Photo will be automatically selected.

You can reduce or enlarge the size of a copied image from 50% to 200%.

To select from the predefined copy sizes:

1 Press **Menu/Exit** on the control panel.

"Reduce/Enlarge" appears on the top line of the display.

2 Press the scroll button (◀ or ▶) to find the size setting you want.

3 Press **Start/Enter** to save the selection.

To fine-tune the size of copies:

1 Press **Menu/Exit** on the control panel.

"Reduce/Enlarge" appears on the top line of the display.

2 Press the scroll button (◀ or ▶) until "Custom:50-200%" displays on the bottom line. Press **Start/Enter**.

3 Press the scroll button (◀ or ▶) until the copy size you want appears on the display.

Pressing and holding the buttons allows you to quickly increase and decrease in increments of 5.

4 Press **Start/Enter** to save the selection.



NOTE: When you make a reduced copy, black lines may appear at the bottom of your copy.

Original Type

The Original Type setting is used to improve the copy quality by selecting the document for the current copy job.

To select the document type:

- 1** Press **Menu/Exit** on the control panel until "Original Type" appears on the top line of the display
- 2** Press **Start/Enter** to access the menu item.
- 3** Press the scroll button (◀ or ▶) to scroll through the document type.

You can choose from the following image modes:

- **Text:** Use for documents containing mostly text.
- **Text/Photo:** Use for documents with mixed text and graphics.
- **Photo:** Use when the originals are photographs.



NOTE: When you copy a document containing color on the background, such as a newspaper or a catalog, you can get the background on your copy. If you want to reduce the background, change the **Darkness** setting to **Light** and/or the **Original Type** setting to **Text**.

Using Special Copy Features



NOTE: When you set Original Type to Photo while using paper larger than A4 size, Text/Photo will be automatically selected.

You can use the following copy features using the "Special Copy" menu:

- **Off:** Prints in normal mode.
- **Clone:** Prints multiple image copies from the original document on a single page. The number of images is automatically determined by the original image and paper size. See page 4.8.
- **Auto Fit:** Automatically reduces or enlarges the original image to fit on the paper currently loaded in the machine. See page 4.9.
- **2 Sides in 1 pg:** Prints 2-sided original document on one sheet of paper. See page 4.10.
- **2 UP:** Prints 2 original images reduced to fit onto one sheet of paper. See page 4.11.
- **Poster:** Prints an image onto 9 sheets of paper (3x3). You can paste the printed pages together to make one poster-size document. See page 4.12.

Clone Copying

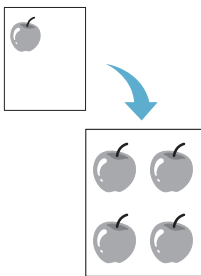

- 1** Load the document to be copied on the document glass, and close the cover.
- 2** Press **Menu/Exit** until "Special Copy" appears on the top line of the display.
- 3** Press the scroll button (◀ or ▶) until "Clone" displays on the bottom line.
- 4** Press **Start/Enter** to save the selection.
- 5** Customize the copy settings including number of copies, copy size, darkness and original type by using the control panel buttons. See "Setting Copy Options" on page 4.5.



NOTE: You cannot adjust the copy size using the "Reduce/Enlarge" feature while making a clone copy.

- 6** Press **Start/Enter** to begin copying.

Auto Fit Copying



NOTE: When the size of the document you want to copy is not same as the size of the paper loaded, this function automatically adjusts the size of the document to fit the paper. You can not adjust the copy size manually.

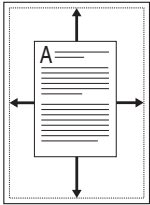

- 1 Load the document to be copied on the document glass, and close the cover.
- 2 Press **Menu/Exit** until "Special Copy" appears on the top line of the display.
- 3 Press the scroll button (◀ or ▶) until "Auto Fit" appears on the bottom line.
- 4 Press **Start/Enter** to save the selection.
- 5 Customize the copy settings including number of copies, copy size, darkness and original type by using the control panel buttons. See "Setting Copy Options" on page 4.5.



NOTE: You cannot adjust the copy size using the "Reduce/Enlarge" feature while the Auto Fit copying is enabled.

- 6 Press **Start/Enter** to begin copying.

2 sided in 1 page Copying

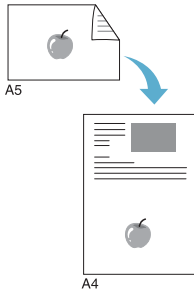

You can copy a 2-sided document on one page of A4, or Letter-sized paper.

When you copy using this feature, the machine prints one side on the upper half of the paper and the other side on the lower half. This feature is helpful for copying a small-sized document, such as a name card.

If the original document is larger than the printable area, some portions may not be printed.

- 1** Load the document to be copied on the document glass, and close the cover.
- 2** Press **Menu/Exit** until "Special Copy" appears on the top line of the display.
- 3** Press the scroll button (◀ or ▶) until "2 Sides in 1 pg" displays on the bottom line.
- 4** Press **Start/Enter** to save the selection.
- 5** Customize the copy settings including number of copies, copy size, darkness and original type by using the control panel buttons. See "Setting Copy Options" on page 4.5.
- 6** Press **Start/Enter** to begin copying.
Your machine begins scanning the front side.
- 7** When "Set Backside" displays on the bottom line, open the document cover and flip the document over. Close the cover.



NOTE: If you press the **Stop/Clear** button or if no buttons are pressed for about 30 seconds, the machine cancels the copy job and returns to Standby Mode.

- 8** Press **Start/Enter** again.



NOTE: You can adjust the copy size using the "Reduce/Enlarge" feature for making a 2-side Copying.

2-up Copying



NOTE: 2-up lets you copy two original documents on one sheet of paper. The documents are reduced 50 % to allow them to fit on paper the same size as the original documents. You can not adjust the copy size to fit on a different size of paper.

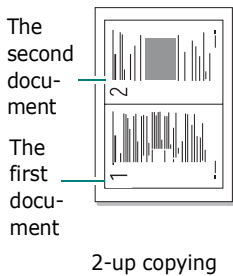

- 1 Load the document to be copied on the document glass, and close the cover.
- 2 Press **Menu/Exit** until "Special Copy" appears on the top line of the display.
- 3 Press the scroll button (◀ or ▶) until "2 UP" displays on the bottom line.
- 4 Press **Start/Enter** to save the selection.
- 5 Customize the copy settings including number of copies, copy size, darkness and original type by using the control panel buttons. See "Setting Copy Options" on page 4.5.



NOTE: You cannot adjust the copy size using the "Reduce/Enlarge" feature for making a 2-up copy.

- 6 Press **Start/Enter** to begin copying.
- 7 When "Set Next Page Press Start" displays, open the document cover and remove the first document.
- 8 Load the second document to be copied on the document glass, and close the cover.
- 9 Press **Start/Enter** to begin copying.



NOTE: 2-up copy reduces your original document by 50%.

Poster Copying

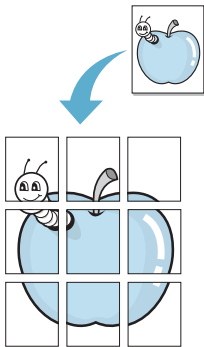

- 1 Load the documents to be copied on the document glass and close the cover.
- 2 Press **Menu/Exit** until "Special Copy" appears on the top line of the display.
- 3 Press the scroll button (◀ or ▶) until "Poster" displays on the bottom line.
- 4 Press **Start/Enter** to save the selection.
- 5 Customize the copy settings including number of copies, copy size, darkness and original type by using the control panel buttons. See "Setting Copy Options" on page 4.5.



NOTE: You cannot adjust the copy size using the "Reduce/Enlarge" feature for making a poster.

- 6 Press **Start/Enter** to begin copying.

Your original document is divided into 9 portions. Each portion is scanned and printed one by one in the following order:

1	2	3
4	5	6
7	8	9

Changing the Default Settings

Copy options, including darkness, original type, copy size and number of copies, can be set to the most frequently used modes. When you copy a document, the default settings are used unless they are changed by using the corresponding buttons on the control panel.

To create your own default settings:

- 1** Press **Menu/Exit** on the control panel until "Copy Setup" appears on the top line of the display.

The first menu item, "Default-Change", appears on the bottom line.

- 2** Press **Start/Enter** to access the menu item. The first setup option, "Darkness", appears on the bottom line.

- 3** Press the scroll button (◀ or ▶) to scroll through the setup options.

- 4** When the option you want to set appears, press **Start/Enter** to access the option.

- 5** Change the setting using the scroll button (◀ or ▶).

- 6** Press **Start/Enter** to save the selection.

- 7** Repeat steps 3 through 6, as needed.

- 8** To return to Standby mode, press **Stop/Clear**.



NOTE: While you set copy options, pressing **Stop/Clear** cancels the changed settings and restores their default status.

Setting the Time Out Option

You can set the time the machine waits before it restores the default copy settings, if you do not start copying after changing them on the control panel.

- 1** Press **Menu/Exit** on the control panel until "Copy Setup" appears on the top line of the display.
- 2** Press the scroll button (◀ or ▶) to display "Timeout" on the bottom line.
- 3** Press **Start/Enter** to access the menu item.
- 4** Press the scroll button (◀ or ▶) until the status you want appears on the display.

You can select from 15, 30, 60 and 180 (seconds).

Selecting "Off" means that the machine does not restore the default settings until you press **Start/Enter** to start copying, or **Stop/Clear** to cancel.

- 5** Press **Start/Enter** to save the selection.
- 6** To return to Standby mode, press **Stop/Clear**.



5

SCANNING

Scanning with your machine lets you turn pictures and text into digital files on your computer. Then you can e-mail the files, display them on your web site or use them to create projects that you can print using Samsung SmarThru software.

This chapter includes:

- **Scanning Basics**
- **Scanning Using Samsung SmarThru**
- **Scanning Process with TWAIN-enabled Software**

Scanning Basics

Your machine offers two ways to scan:

- From the Samsung SmartThru software: Launch Samsung SmartThru and open the Scan To to begin scanning. See below.
- From TWAIN-compliant software: You can use other software including Adobe PhotoDeluxe and Adobe Photoshop. See page 5.6.



NOTES:

- To scan with your machine, you must install the MFP driver.
 - Scanning is done through the same LPT or USB port currently assigned for your printer port.
-

Scanning Using Samsung SmartThru

Samsung SmartThru is the accompanying software for your machine. With the SmartThru, scanning becomes a pleasure.

Follow these steps to start scanning using the SmartThru:

- 1** Make sure that your machine and computer are turned on and properly connected to each other.
- 2** Lift the document cover.

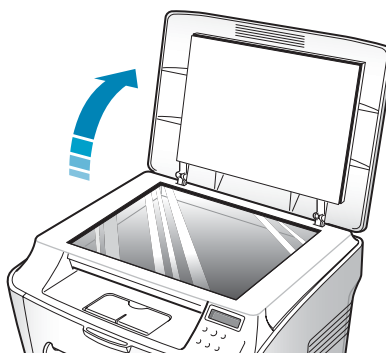

- 3 Load the document to be scanned **face down** on the glass and align it with document guides on the left top corner of the glass.

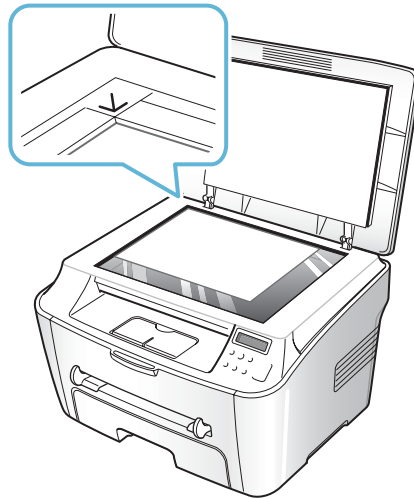

- 4 Close the document cover.
- 5 Once you have installed Samsung SmarThru, you will see the **SmarThru 4** icon on your desktop. Double-click the **SmarThru 4** icon.

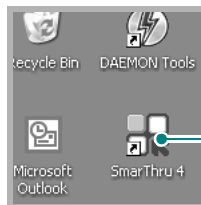

Double-click this icon.

The SmarThru 4 window opens.

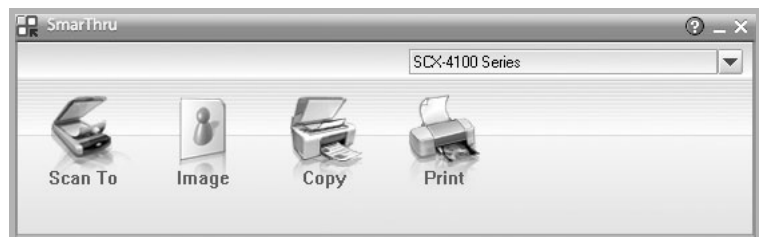

- **Scan To**

Allows you to scan an image and save it in an application or folder, email it, or publish it on a web site.

- **Image**

Allows you to edit an image you have saved as a graphic file and send it to a selected application or folder, email it, or publish it on a web site.

- **Copy**

Allows you to produce professional quality copies. You can make black and white or color copying of an image if your machine supports it, and customize the copy settings.

- **Print**

Allows you to print images you have saved. You can print images in black and white or color mode if your machine supports it, and customize the print settings.

6 Click **Scan To**. The **Scan To** menu bar appears on the SmarThru 4 window.

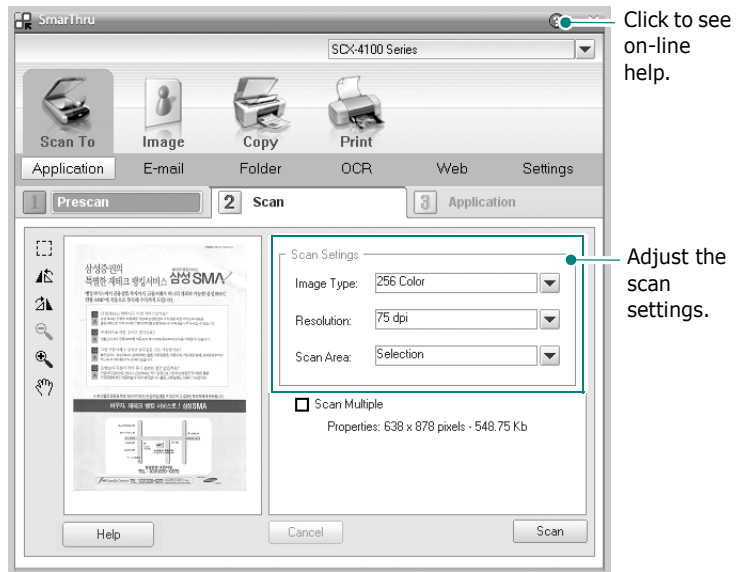

Scan To lets you use the following services:

- **Application**

Scanning an image and placing it in an application. Allows you to scan an image, preview it, and place it in an application you choose.

- **Email**

Scanning an image and emailing it. Allows you to scan an image, preview it, and email it.

- **Folder**

Scanning an image and saving it to a folder. Allows you to scan an image, preview it, and save to a folder you choose.

- **OCR**

Scanning an image and performing text recognition. Allows you to scan an image, preview it, and send it to the OCR program for text recognition.

- Recommended Scan Option for OCR
- Resolution: 200 or 300 dpi
- Image Type: Mono (Black & White)

- **Web**

Scanning an image, previewing it, and publish it on a web site using the specified file format for the picture you want to publish.

- **Setting**

Customizing settings of **Scan To** basic functions. Allows you to customize settings for **Application**, **Email**, **OCR**, and **Web** functions.

- 7 Click the service icon according to your job.
- 8 The SmarThru 4 opens for the selected service. Adjust the scan settings.
- 9 To start scanning, click **Scan**.



NOTE: If you want to cancel the scan job, press the **Stop/Clear** button on the control panel.

To use on-line help file

For more information about SmarThru, click the  button. SmarThru Help window opens and allows you to see on-line help.

Scanning Process with TWAIN-enabled Software

If you want to scan documents using other software, you will need to use TWAIN-compliant software, such as Adobe PhotoDeluxe or Adobe Photoshop. The first time you scan with your machine, select it as your TWAIN source in the application you use.

The basic scanning process involves a number of steps:

- Place your photograph or page on the document glass. See page 5.2.
- Open an application, such as PhotoDeluxe or Photoshop.
- Open the TWAIN window and set the scan options.
- Scan and save your scanned image.

You need to follow the program's instructions for acquiring an image. Please refer to the user's guide of the application.



6

USING YOUR PRINTER IN LINUX

This chapter gives you information about how to use your machine in the Linux system.

This chapter includes:

- **Getting Started**
- **Installing the MFP Driver**
- **Using the MFP Configurator**
- **Configuring Printer Properties**
- **Printing a Document**
- **Scanning a Document**

Getting Started

The supplied CD-ROM provides you with Samsung's MFP driver package for using your machine with a Linux computer.

Samsung's MFP driver package contains printer and scanner drivers, providing the ability to print documents and scan images. The package also delivers powerful applications for configuring your machine and further processing of the scanned documents.

After the driver is installed on your Linux system, the driver package allows you to monitor a number of MFP devices. The acquired documents can then be edited, printed on the same local MFP or network printers, sent by e-mail, uploaded to a FTP site or transferred to an external OCR system.

The MFP driver package is supplied with a smart and flexible installation program. You don't need to search for additional components that might be necessary for the MFP software: all required packages will be carried onto your system and installed automatically; this is possible on a wide set of the most popular Linux clones.

Installing the MFP Driver

System Requirements

Supported OS

Various Linux OS (via USB interface only)

- Redhat 7.1 and above
- Linux Mandrake 8.0 and above
- SuSE 7.1 and above
- Caldera OpenLinux 3.1 and above
- Turbo Linux 7.0 and above
- Slackware 8.1 and above

Recommended Hardware Requirements

- Pentium IV 1 GHz or higher
- RAM 256 MB or higher
- HDD 1GB or higher



NOTES:

- It's also necessary to claim swap partition of 300 MB or larger for working with large scanned images.
 - The Linux scanner driver supports the optional resolution at maximum. see "Scanner and Copier Specifications" on page A.3.
-

Software

- Linux Kernel 2.4 or higher
- Glibc 2.2 or higher
- CUPS
- SANE

Installing the MFP Driver

- 1 Make sure that you connect your machine to your computer. Turn both the computer and the machine on.
- 2 When the Administrator Login window appears, type in *root* in the Login field and enter the system password.



NOTE: You must log in as a super user (*root*) to install the printer software. If you are not a super user, ask your system administrator.

- 3 Insert the printer software CD-ROM. The CD-ROM will automatically run.

If the CD-ROM does not automatically run, click the  icon at the bottom of the desktop. When the Terminal screen appears, type in:

```
[root@localhost root]#cd /mnt/cdrom/Linux
```

```
[root@localhost root]#./install.sh
```



NOTE: The installation program runs automatically if you have an autorun software package installed and configured.

- 4 Click **Install**.
- 5 When the welcome screen appears, click **Next**.



6 When the installation is completed, click **Finish**.

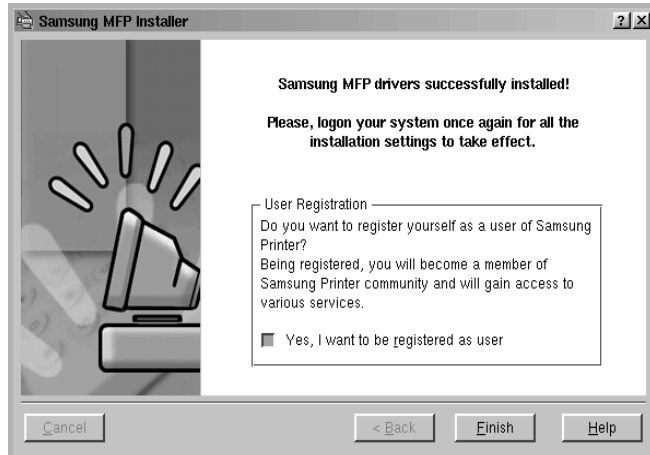

The installation program has added the MFP Configurator desktop icon and Samsung MFP group to the system menu for your convenience. If you have any difficulties, consult the on-line help that is available through your system menu or can otherwise be called from the driver package windows applications, such as MFP Configurator or Image Editor.

Uninstalling the MFP Driver

- 1 When the Administrator Login window appears, type in *root* in the Login field and enter the system password.



NOTE: You must log in as a super user (*root*) to install the printer software. If you are not a super user, ask your system administrator.

- 2 Insert the printer software CD-ROM. The CD-ROM will automatically run.

If the CD-ROM does not automatically run, click the  icon at the bottom of the desktop. When the Terminal screen appears, type in:

```
[root@localhost root]#cd /mnt/cdrom/Linux
```

```
[root@localhost root]#./install.sh
```



NOTE: The installation program runs automatically if you have an autorun software package installed and configured.

- 3 Click **Uninstall**.
- 4 Click **Next**.

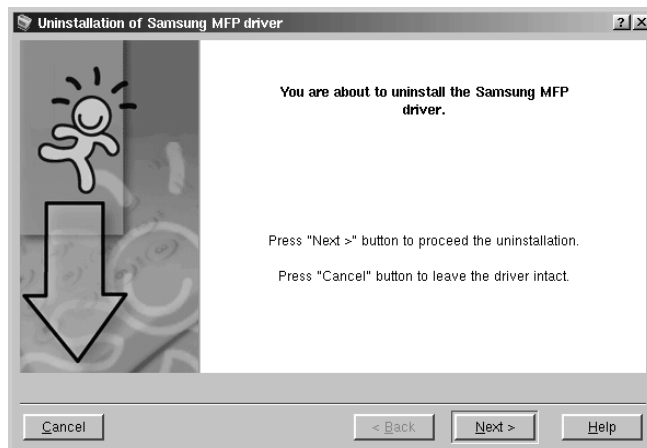

- 5 Click **Finish**.

Using the MFP Configurator

MFP Configurator is a tool primarily intended for configuring MFP devices. Since an MFP device combines the printer and scanner, the MFP Configurator provides options logically grouped for printer and scanner functions. There is also a special MFP port option responsible for the regulation of access to an MFP printer and scanner via a single I/O channel.

After installing the MFP driver (see page 6.3), the MFP Configurator icon will automatically be created on your desktop.

Opening the MFP Configurator

- 1 Double-click **MFP Configurator** on the desktop.

You can also click the Startup Menu icon and select **Samsung MFP** and then **MFP Configurator**.

- 2 Press each button on the Modules pane to switch to the corresponding configuration window.

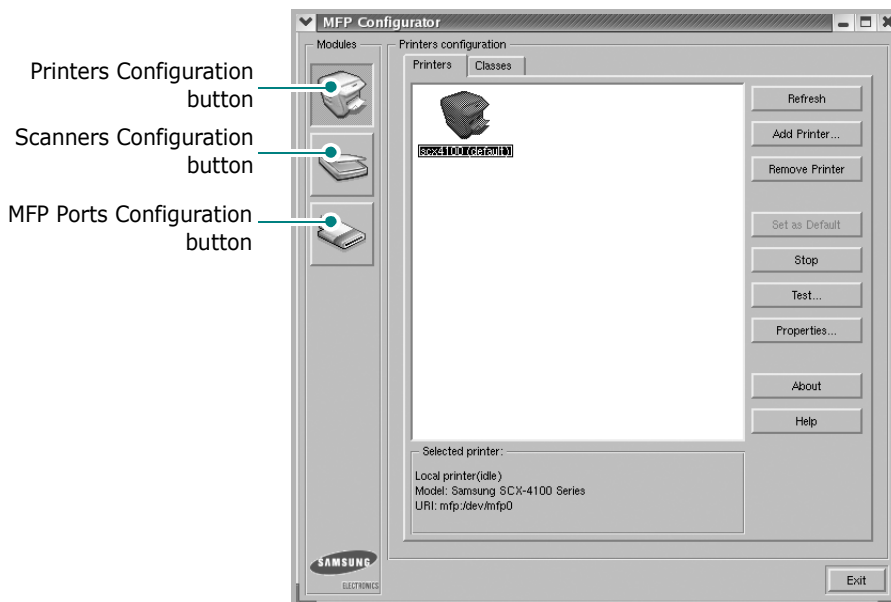

You can use the on-line help by clicking **Help**.

- 3 After changing the configurations, click **Exit** to close the MFP Configurator.

Printers Configuration

Printers Configuration has the two tabs; **Printers** and **Classes**.

Printers Tab

You can see the current system's printer configuration by clicking on the printer icon button on the left side of MFP Configurator window.

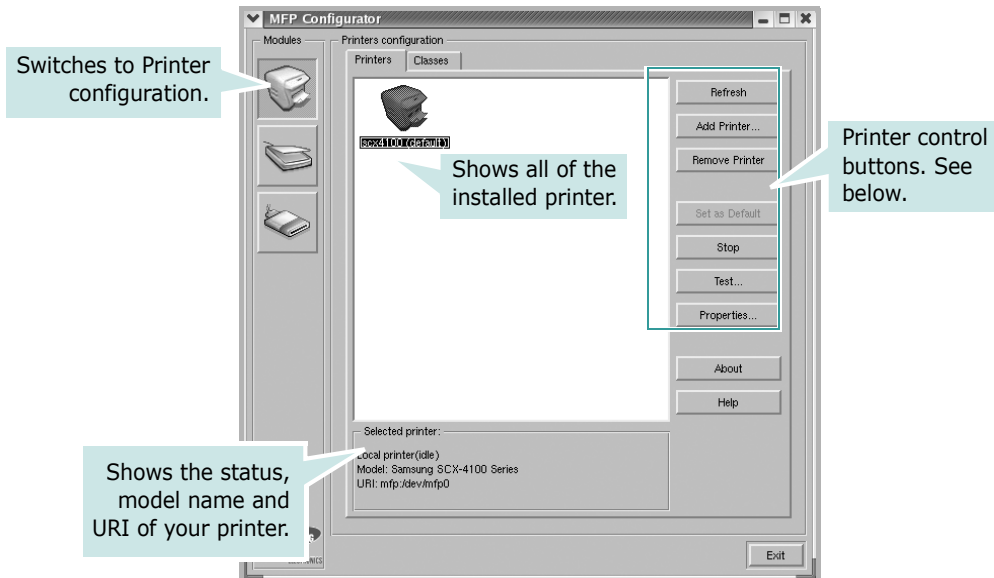

You can use the following printer control buttons:

- **Refresh:** renews the available printers list.
- **Add Printer:** allows you to add a new printer.
- **Remove Printer:** removes the selected printer.
- **Set as Default:** sets the current printer as a default printer.
- **Stop/Start:** stops/starts the printer.
- **Test:** allows you to print a test page to check if the machine is working properly.
- **Properties:** allows you to view and change the printer properties. For details, see page 6.11.

Classes Tab

The Classes tab shows the list of the available printer classes.

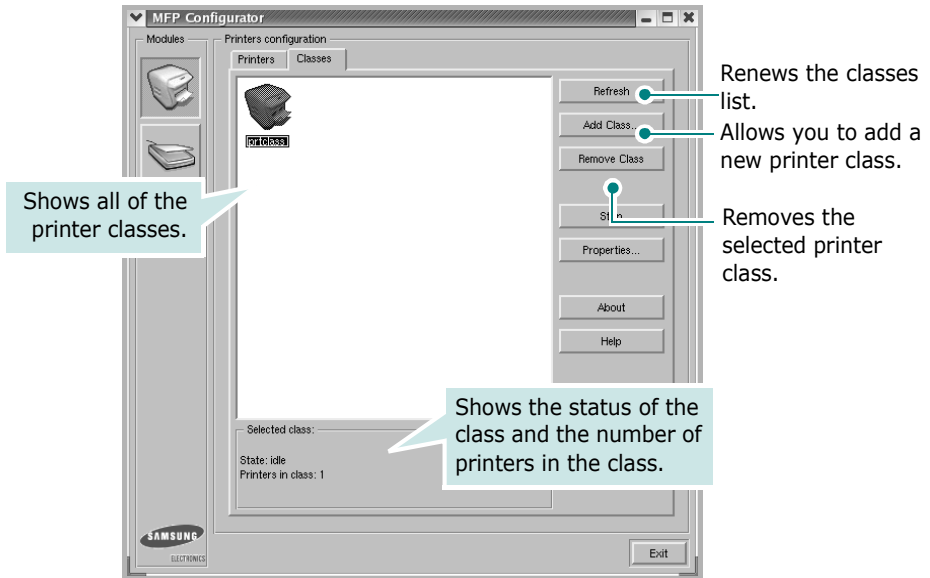

Scanners Configuration

In this window, you can monitor activity of scanner devices, view the list of installed Samsung MFP devices, change device properties, and scan images.

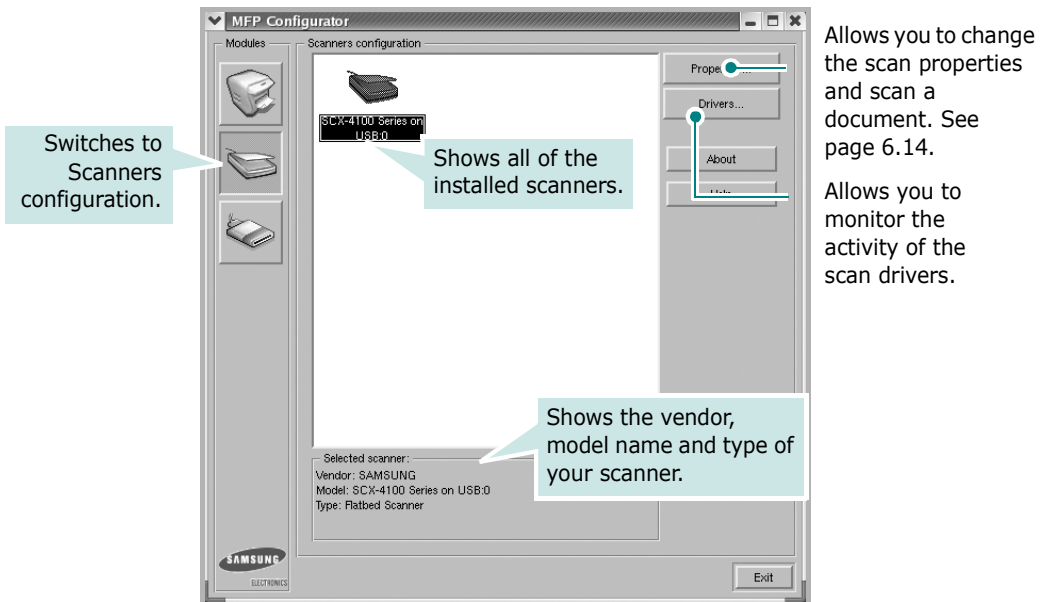

MFP Ports Configuration

In this window, you can view the list of available MFP ports, check the status of each port and release a port that is stalled in busy state when its owner is terminated for any reason.

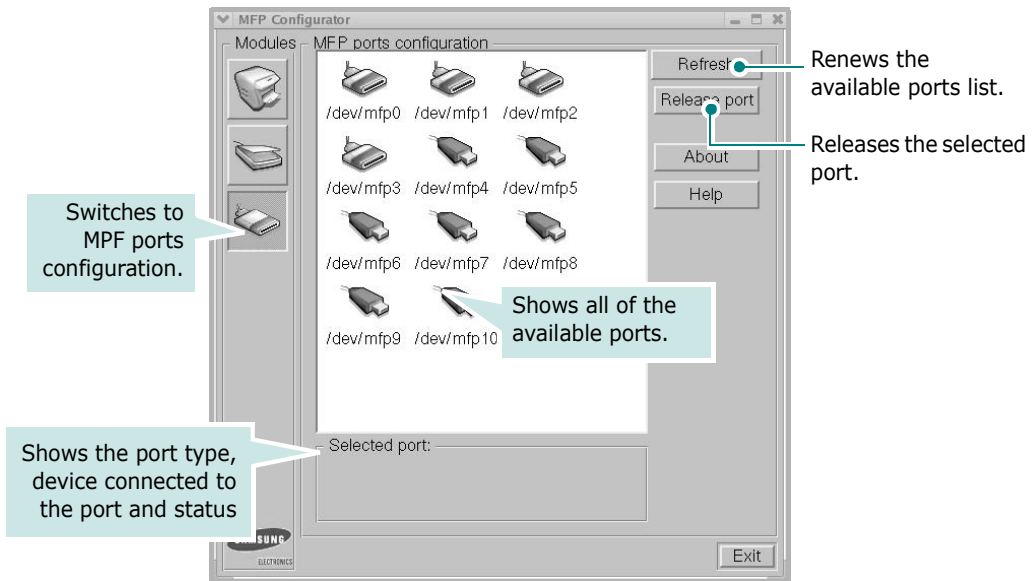

Sharing Ports Between Printers and Scanners

Your machine may be connected to a host computer via the USB port. Since the MFP device contains more than one device (printer and scanner), it is necessary to organize proper access of "consumer" applications to these devices via the single I/O port.

The Samsung MFP driver package provides an appropriate port sharing mechanism that is used by Samsung printer and scanner drivers. The drivers address their devices via so-called MFP ports. The current status of any MFP port can be viewed via the MFP Ports Configuration. The port sharing prevents you from accessing one functional block of the MFP device, while another block is in use.

When you install a new MFP printer onto your system, it is strongly recommended you do this with the assistance of an MFP Configurator. In this case you will be asked to choose I/O port for the new device. This choice will provide the most suitable configuration for MFP's functionality. For MFP scanners I/O ports are being chosen by scanner drivers automatically, so proper settings are applied by default.

Configuring Printer Properties

Using the properties window provided by the Printers configuration, you can change the various properties for your machine as a printer.

- 1 Open the MFP Configurator.
If necessary, switch to Printers configuration.
- 2 Select your machine on the available printers list and click **Properties**.
- 3 The Printer Properties window opens.

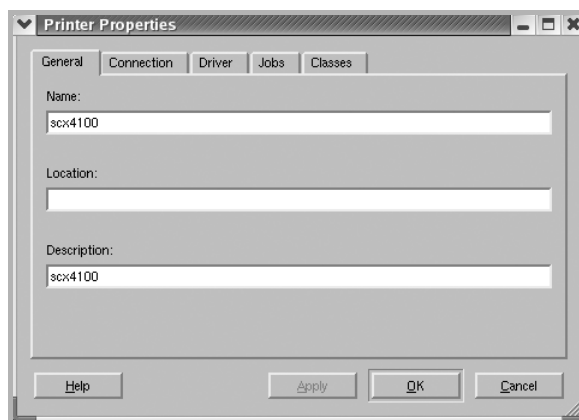

The following five tabs display at the top of the window:

- **General:** allows you to change the printer location and name. The name entered in this tab displays on the printer list in Printers configuration.
 - **Connection:** allows you to view or select another port.
 - **Driver:** allows you to view or select another printer driver. By clicking **Options**, you can set the default device options.
 - **Jobs:** shows the list of print jobs. Click **Cancel job** to cancel the selected job and select the **Show completed jobs** check box to see previous jobs on the job list.
 - **Classes:** shows the class that your printer is in. Click **Add to Class** to add your printer to a specific class or click **Remove from Class** to remove the printer from the selected class.
- 4 Click **OK** to apply the changes and close the Printer Properties Window.

Printing a Document

Printing from Applications

There are a lot of Linux applications that you are allowed to print from using Common UNIX Printing System(CUPS). You can print on your machine from any such application.

- 1 From the application you are using, select **Print** from the **File** menu.
- 2 Select **Print** directly using **lpr**.
- 3 In the Samsung LPR window, select the model name of your machine from the Printer list and click **Properties**.

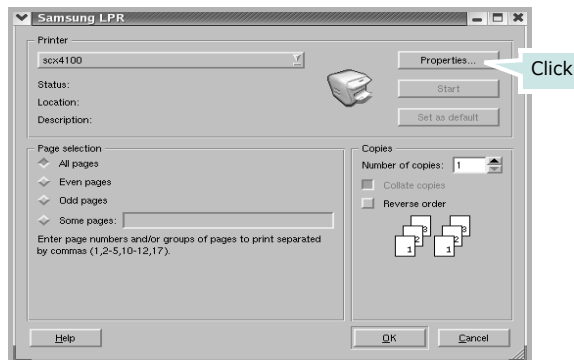

- 4 Change the printer and print job properties.

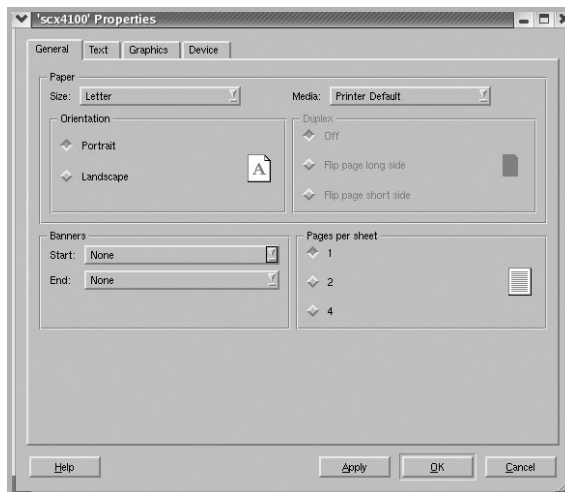

The following four tabs display at the top of the window.

- **General** - allows you to change the paper size, the paper type and the orientation of the documents, enables the duplex feature, adds start and end banners and changes the number of pages per sheet.
- **Text** - allows you to specify the page margins and set the text options, such as spacing or columns.
- **Graphics** - allows you to set image options that are used when printing images/files, such as color options, image size or image position.
- **Device**: allows you to set the print resolution, paper source and destination.

5 Click **OK** to apply the changes and close the SCX-4100 Properties window.

6 Click **OK** in the Samsung LPR window to start printing.

7 The Printing window appears to allow you to monitor the status of your print job.

To abort the current job, click **Cancel**.

Printing Files

You can print many different types of files on the Samsung MFP device using the standard CUPS way - directly from the command line interface. The CUPS `lpr` utility allows you do that. But the drivers package replaces the standard `lpr` tool by a much more user-friendly Samsung LPR program.

To print any document file:

1 Type `lpr <file_name>` from the Linux shell command line and press **Enter**. The Samsung LPR window appears.

When you type only `lpr` and press **Enter**, the Select file(s) to print window appears first. Just select any files you want to print and click **Open**.

2 In the Samsung LPR window, select your printer from the list, and change the printer and print job properties.

For details about the properties window, see page 6.12.

3 Click **OK** to start printing.

Scanning a Document

You can scan a document using the MFP Configurator window.

- 1 Double-click the MFP Configurator on your desktop.
- 2 Click the  button to switch to Scanners Configuration.
- 3 Select the scanner on the list.



When you have only one MFP device and it is connected to the computer and turned on, your scanner appears on the list and is automatically selected.

If you have two or more scanners attached to your computer, you can select any scanner to work at any time. For example, while acquisition is in progress on the first scanner, you may select the second scanner, set the device options and start the image acquisition simultaneously.



NOTE: The scanner name shown in Scanners configuration can be different from the device name.

- 4 Click **Properties**.

- 5 Load the document to be scanned **face down** on the document glass.

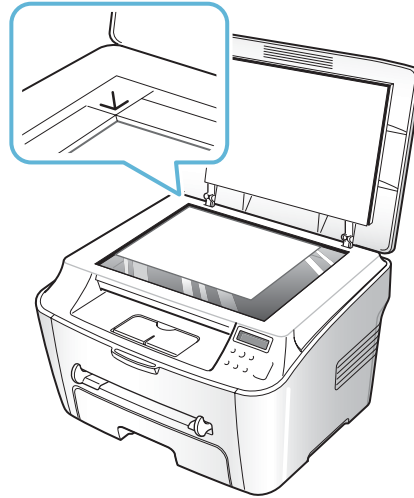

- 6 Click **Preview** in the Scanner Properties window.

The document is scanned and the image preview appears in the Preview Pane.

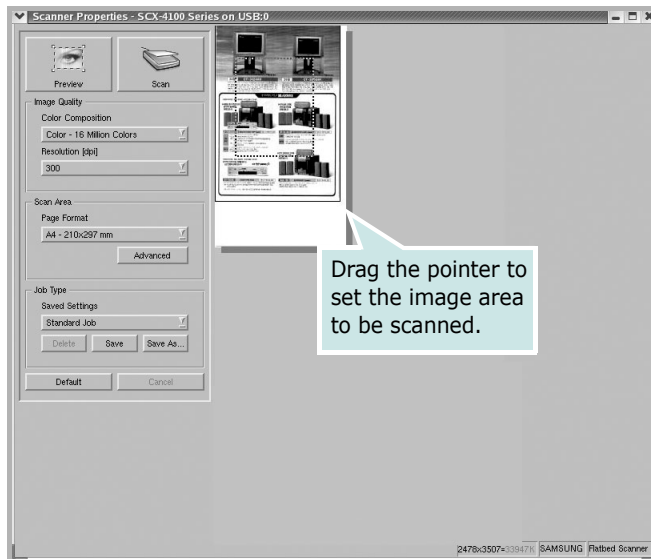

- 7 Change the scan options in the Image Quality and Scan Area sections.
 - **Image Quality**: allows you to select the color composition and the scan resolution for the image.
 - **Scan Area**: allows you to select the page size. The **Advanced** button enables you to set the page size manually.

If you want to use one of the preset scan option settings, select from the Job Type drop-down list. For details about the preset Job Type settings, see page 6.17.

You can restore the default setting for the scan options by clicking **Default**.

- 8 When you have finished, press **Scan** to start scanning.

The status bar appears on the bottom left of the window to show you the scanning progress. To cancel scanning, press **Cancel**.

- 9 The scanned image appears in the new Image Editor window.

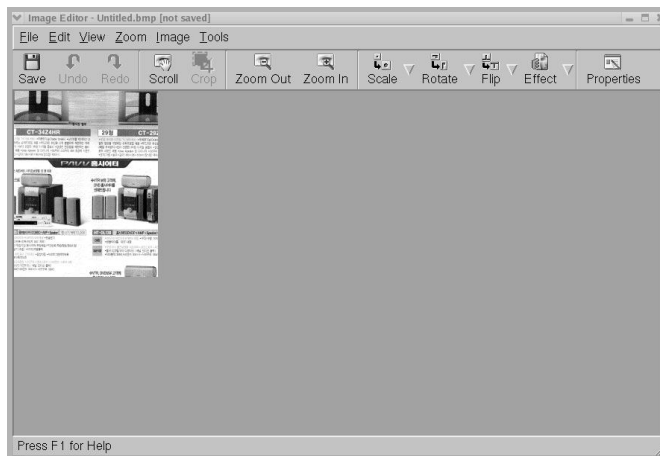

If you want to edit the scanned image, use the toolbar. For further details about editing the image, see page 6.18.

- 10 When you are finished, click **Save** on the toolbar.
- 11 Select the file directory where you want to save the image and enter the file name.
- 12 Click **Save**.

Using Preset Job Type Settings

You can save your scan option settings to retrieve for a later scanning.

To save a new Job Type setting:

- 1 Change the options from the Scanner Properties window.
- 2 Click **Save As**.
- 3 Enter the name for your setting.
- 4 Click **OK**.

Your setting is added to the Saved Settings drop-down list.

To save a Job Type setting for the next scan job:

- 1 Select the setting you want to use from the Job Type drop-down list.
- 2 Click **Save**.

The next time you open the Scanner Properties window, the saved setting is automatically selected for the scan job.

To delete a Job Type setting:

- 1 Select the setting you want to delete from the Job Type drop-down list.
- 2 Click **Delete**.





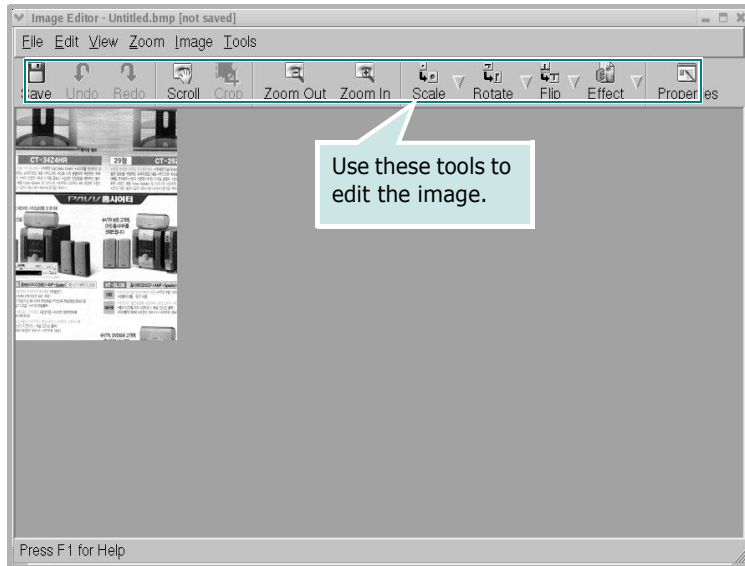

The setting is deleted from the list.





Using the Image Editor

The Image Editor window provides you with menu commands and tools to edit your scanned image.

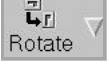

You can use the following tools to edit the image:

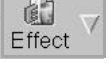
Tools	Function
	Saves the image.
	Cancels your last action.
	Restores the action you canceled.
	Allows you to scroll through the image.
	Crops the selected image area.
	Zooms the image out.
	Zooms the image in.

Tools	Function
 Scale	Allows you to scale the image size; you can enter the size manually, or set the rate to scale proportionally, vertically or horizontally.
 Rotate	Allows you to rotate the image; you can select the number of degrees from the drop-down list.
 Flip	Allows you to flip the image vertically or horizontally.
 Effect	Allows you to adjust the brightness or contrast of the image, or to invert the image.
 Properties	Shows the properties of the image.

For further details about the Image Editor program, refer to the on-line help.

MEMO



6.20 USING YOUR PRINTER IN LINUX

7

MAINTENANCE

This chapter provides information for maintaining your machine and the toner cartridge.

This chapter includes:

- **Printing the System Data List**
- **Clearing the Memory**
- **Cleaning Your Machine**
- **Maintaining the Toner Cartridge**
- **Consumables and Replacement Parts**
- **Using the Remote Control Panel**

Printing the System Data List

Your machine can print the system data report shows the status of the user-selectable options. You may print this list to confirm your changes after changing any settings.

To print the system data list:

- 1 Press **Menu/Exit** until "Report" appears on the top line of the display.

"System Data" appears on the bottom line.

- 2 Press **Start/Enter**.

The system data list prints out.

Clearing the Memory

You can selectively clear information stored in your machine's memory.

- 1 Press **Menu/Exit** on the control panel until "Maintenance" appears on the top line of the display.

- 2 Press the scroll button (◀ or ▶) until you see "Clear Settings" on the bottom line and press **Start/Enter**.

The first available menu item, "Paper Setting" displays on the bottom line.

- 3 Press the scroll button (◀ or ▶) until you see the item you want to clear.

- Paper Setting: Restores all of the Paper Setting options to the factory default.
- Copy Setup: Restores all of the Copy Setup options to the factory default.
- All Settings: Resets all of your settings to the factory default.
- Machine Setup: Resets all of the system settings, such as the display language and save modes, to the factory default.

- 4 Press **Start/Enter**. The selected memory is cleared and the display asks you to continue clearing the next item.

- 5 To clear another item, press **Start/Enter** and repeat steps 3 and 4. Or, to return to Standby mode, press **Stop/Clear**.

Cleaning Your Machine

To maintain print quality, follow the cleaning procedures below each time the toner cartridge is replaced or if print quality problems occur.



NOTES:

- While cleaning the inside of the machine, be careful not to touch the transfer roller, located underneath the toner cartridge. Oil from your fingers can cause print quality problems.
 - Cleaning the cabinet of your machine with products containing large amounts of alcohol, solvent, or other strong substances can discolor or crack the cabinet.
-

Cleaning the Outside

Clean the cabinet of the machine with a soft lint-free cloth. You can dampen the cloth slightly with water, but be careful not to let any water drip onto or inside the machine.

Cleaning the Inside

During the printing process, paper, toner and dust particles can accumulate inside the machine. This build-up can cause print quality problems, such as toner specks or smearing. Cleaning the inside of the machine clears or reduces these problems.

- 1** Turn the machine off and unplug the power cord. Wait for the machine to cool down.
- 2** Open the front cover and pull the toner cartridge out, lightly pushing it down.

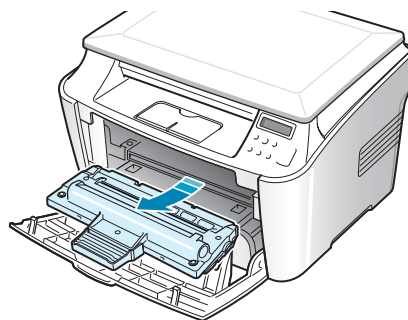

- 3 With a dry lint-free cloth, wipe away any dust and spilled toner from the toner cartridge area and the toner cartridge cavity.

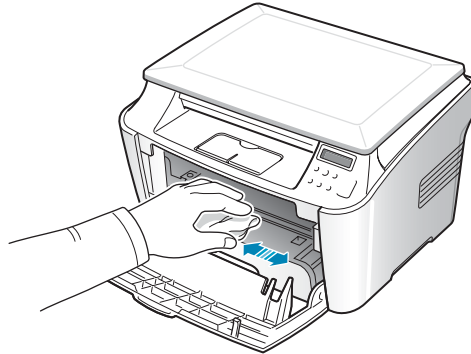

CAUTION: To prevent damage to the toner cartridge, do not expose it to light for more than a few minutes. Cover it with a piece of paper, if necessary. Do not touch the black transfer roller inside the machine.

- 4 Locate the long strip of glass (LSU) inside the top of the cartridge compartment, and gently swab the glass to see if dirt turns the white cotton black.

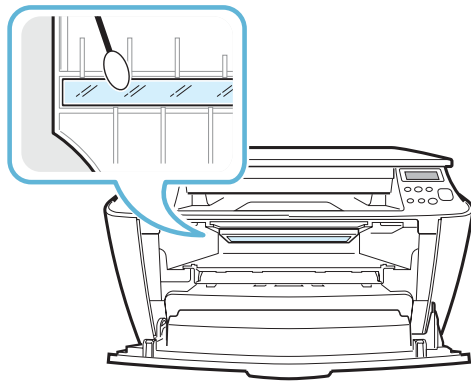

- 5 Reinsert the toner cartridge and close the cover.
- 6 Plug in the power cord and turn the machine on.

Cleaning the Document Glass

Keeping the document glass clean helps ensure the best possible copies. We suggest that you clean the document glass at the start of each day and during the day, as needed.

- 1 Slightly dampen a soft lint-free cloth or paper towel with water.
- 2 Lift the document glass.

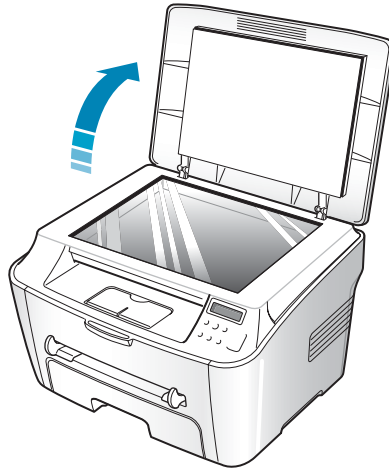

- 3 Wipe the surface of the document glass until it is clean and dry.

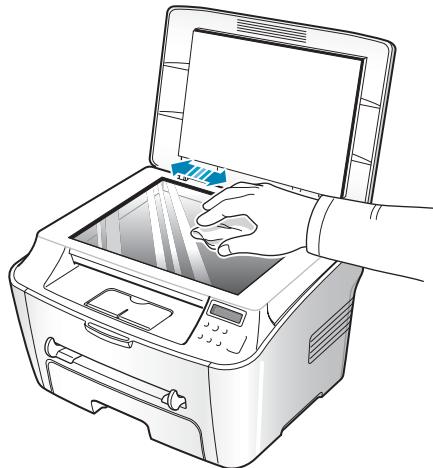

- 4 Wipe the underside of the white document cover until it is clean and dry.
- 5 Close the document cover.

Maintaining the Toner Cartridge

Toner Cartridge Storage

To get the most from the toner cartridge, keep the following guidelines in mind:

- Do not remove the toner cartridge from its package until ready for use.
- Do not refill the toner cartridge. **The machine warranty does not cover damage caused by using a refilled cartridge.**
- Store toner cartridges in the same environment as your machine.
- To prevent damage to the toner cartridge, do not expose it to light for more than a few minutes.

Saving Toner

To save toner, use the Toner Save feature; see page 1.27. Using this feature extends the life of the toner cartridge and reduces your cost per page, but it also reduces the print quality.

Expected Cartridge Life

The life of the toner cartridge depends on the amount of toner that print jobs require. When printing text at ISO 19752 5% coverage, a new toner cartridge lasts an average of 3,000 pages. (The original toner cartridge supplied with the machine lasts an average of 1,000 pages.) The actual number may be different depending on the print density of the page you print. If you print a lot of graphics, you may need to change the cartridge more often.



NOTE: The 1,000 pages and 3,000 pages toner cartridges have different shapes.

Redistributing Toner

When the toner cartridge is near the end of its life, white streaks or light print occurs. You can temporarily re-establish the print quality by redistributing the remaining toner in the cartridge.

- 1 Open the front cover.

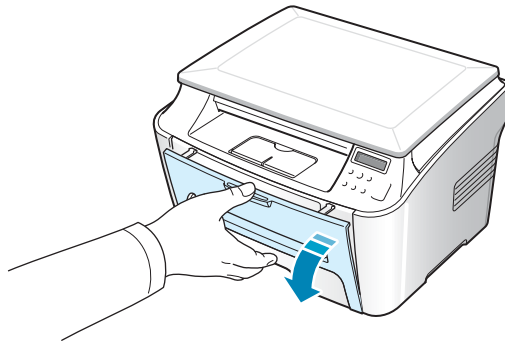

- 2 Pull the toner cartridge out and gently roll the cartridge 5 or 6 times to distribute the toner evenly inside the cartridge.

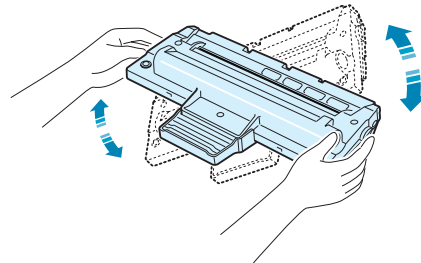

NOTE: If toner gets on your clothing, wipe it off with a dry cloth and wash clothing in cold water. Hot water sets the toner into fabric.

- 3 Reinstall the cartridge and close the front cover.

Replacing the Toner Cartridge

When the toner eventually runs out, only blank pages print when a print job is sent. At this stage, the toner cartridge needs to be replaced. The machine stops printing.

- 1 Open the front cover.
- 2 Lightly pushing the used cartridge down, pull it out.

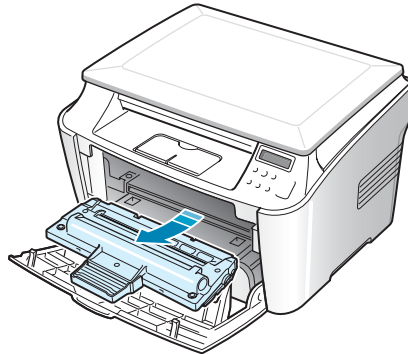

- 3 Unpack the new toner cartridge and gently roll it horizontally four or five times to distribute the toner evenly inside the cartridge.

Save the box and the Plastic bag for shipping.

- 4 Slide the new toner cartridge in until it locks into place.

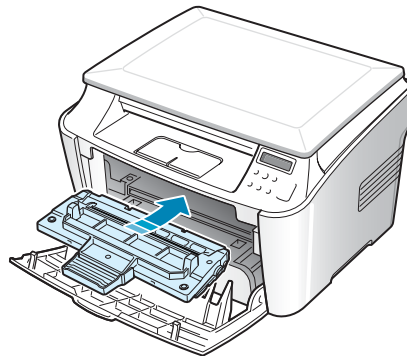

- 5 Close the front cover.

Cleaning the Drum

If there are streaks or spots on your print, the OPC drum of the cartridge may require cleaning.

- 1** Before setting the cleaning procedure, make sure that paper is loaded in the machine.
- 2** Press **Menu/Exit** on the control panel until "Maintenance" appears on the top line of the display.

The first available menu item, "Clean Drum", displays on the bottom line.
- 3** Press **Start/Enter**.
- 4** When the display asks you to confirm your selection, press **Start/Enter**.

The machine prints a cleaning page. Toner particles on the drum surface are affixed to the paper.
- 5** If the problem remains, repeat steps 1 through 4.

Consumables and Replacement Parts

From time to time, you need to replace the toner cartridge, roller, and fuser unit to maintain top performance and to avoid print quality problems and paper feed problems resulting from worn parts.

The following items should be replaced after you have printed a specified number of pages:

Items	Yield (Average)
Paper feeding roller	Approx. 60,000 pages
Transfer roller	Approx. 60,000 pages
Fuser unit	Approx. 60,000 pages

To purchase consumables and replacement parts, contact your Samsung dealer or the retailer where you bought your machine. We strongly recommend that items be installed by trained service professional, except for the toner cartridge.

Using the Remote Control Panel

Using the Remote Control Panel, you can update the firmware program of your machine on the desktop of your computer.

When you install the Samsung Software, the Remote Control Panel program is automatically installed.

To open the Remote Control Panel:

- 1 Start Windows.
- 2 From the **Start** menu, select **Programs**.
- 3 Select **Samsung SCX-4100 Series** and then **Remote Control Panel**.

The Remote Control Panel program is opened.

- 4 The Remote Control Panel window provides the **Firmware Update** tab.

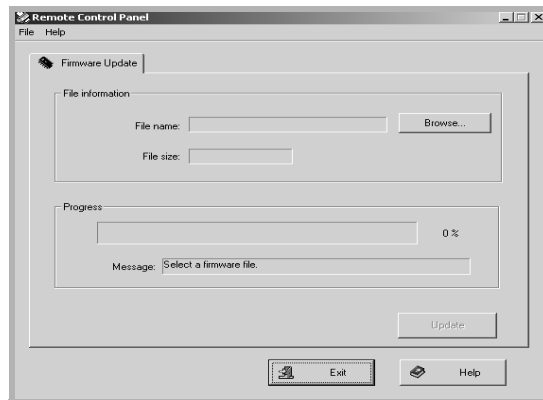

To exit, click the **Exit** button at the bottom of tab.

For further details, click the **Help** button at the bottom of tab.

This feature should be used by an authorized technician. Please consult with the purchase point.



8

TROUBLESHOOTING

This chapter gives helpful information for what to do if you encounter an error.

This chapter includes:

- **Clearing Paper Jams**
- **Clearing LCD Error Messages**
- **Solving Problems**

Clearing Paper Jams

When a paper jam occurs, "Paper Jam" appears on the display. Refer to the table below to locate and clear the paper jam.

Message	Location of Jam	Go to
Paper Jam 0 Open/Close Door	In the paper tray	page 8.2
Paper Jam 1 Open/Close Door	In the fuser area or around the toner cartridge	page 8.5
	In the Manual Feeder	page 8.6
Paper Jam 2 Check Inside	In the paper exit area	page 8.3

To avoid tearing the paper, pull the jammed paper out gently and slowly. Follow the steps on the next pages to clear the jam.

In the Paper Tray

- 1 Open and close the front cover. The jammed paper automatically exits the machine.
If the paper does not exit, continue to step 2.
- 2 Pull the paper tray open.
- 3 Remove the jammed paper by gently pulling it straight out.

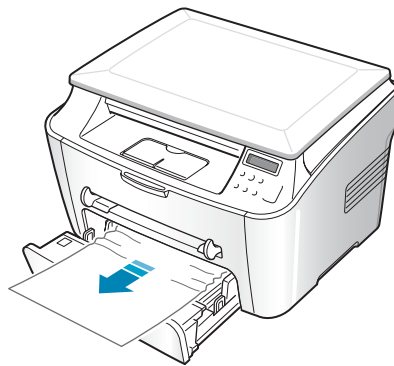

If there is any resistance and the paper does not move when you pull or if you cannot see the paper in this area, skip to the fuser area around the toner cartridge. See page 8.5.

- 4 Insert the paper tray into the machine until it snaps into place.
- 5 Open and close the front cover to resume printing.

In the Paper Exit Area

- 1 Open and close the front cover. The jammed paper automatically exits the machine.

If the paper does not exit, continue to step 2.

- 2 Gently pull the paper out of the front output tray. Skip to step 9.

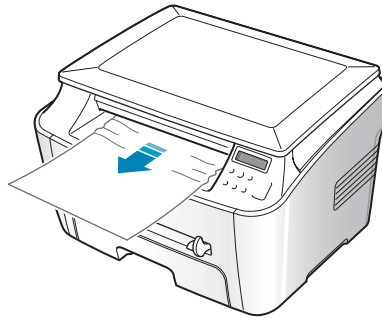

If you cannot see the jammed paper in the front output tray, continue to step 3.

- 3 Open the jam cover.
- 4 Pull the paper out gently.

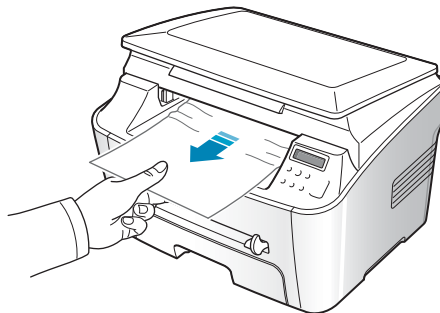

- 5 Close the jam cover by pushing a tab to the left and hold it down and lowering the cover carefully until the cover is holding down the tab.

If there is any resistance and the paper does not move when you pull or if you cannot see the paper in the jam cover, continue to step 6.

- 6 Open the rear cover.
- 7 Remove the jammed paper by gently pulling it straight out.

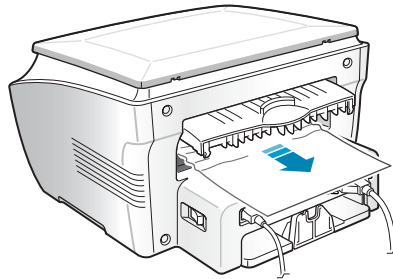

- 8 Close the rear cover.
- 9 Open and close the front cover to resume printing.

In the Fuser Area or Around the Toner Cartridge



NOTE: The fuser area is hot. Take care when removing paper from the machine.

- 1 Open the front cover and pull the toner cartridge out, lightly pushing it down.

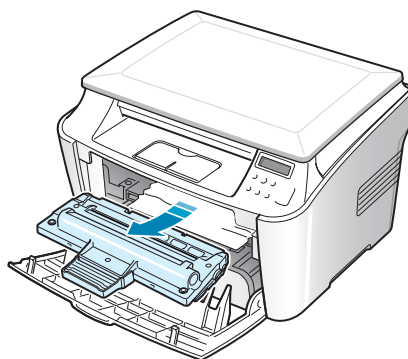

- 2 Remove the jammed paper by gently pulling it straight out.

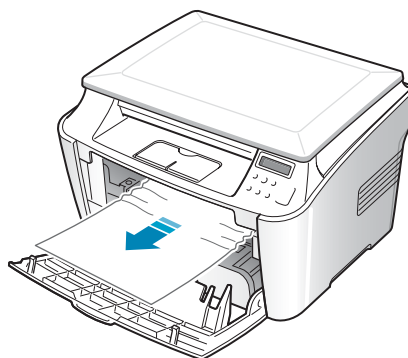

- 3 Replace the toner cartridge and close the front cover. Printing automatically resumes.

In the Manual Feeder

“Paper Jam 1 Open/Close Door” appears on the display when you try to print using the manual feeder and the machine does not detect paper, due to no paper or improper paper loading.

The error message may also occur when the paper is not properly fed into the machine through the manual feeder. In that case, pull the paper out of the machine.

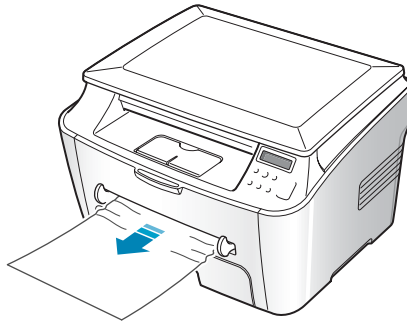

Tips for Avoiding Paper Jams

By selecting the correct paper types, most paper jams can be avoided. When a paper jam occurs, follow the steps outlined in page 8.2.

- Follow the procedures on page 1.8 when you load paper. Ensure that the adjustable guides are positioned correctly.
- Do not overload the paper tray. Ensure that the paper is below the paper capacity mark on the inside wall of the paper tray.
- Do not remove the paper from the tray while your machine is printing.
- Flex, fan, and straighten the paper before loading.
- Do not use creased, damp, or highly curled paper.
- Do not mix paper types in the paper tray.
- Use only recommended print materials. See “Paper Specifications” on page A.5.

- Ensure that the print side of print materials is facing down in the paper tray and facing up in the manual feeder.
- If paper jams frequently occur when you print on the A5-sized paper:
 - Load the paper into the tray as shown below.

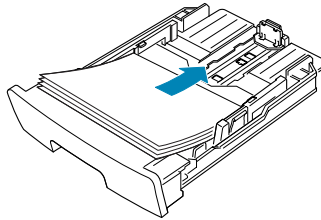

- Open the Samsung SCX-4100 Series Properties window, set the paper size to **A5(5.8x8.3 in.)** from the **Paper** tab.
- From the **Orientation** option of the **Layout** tab, set the **Rotate** option to **90°**.

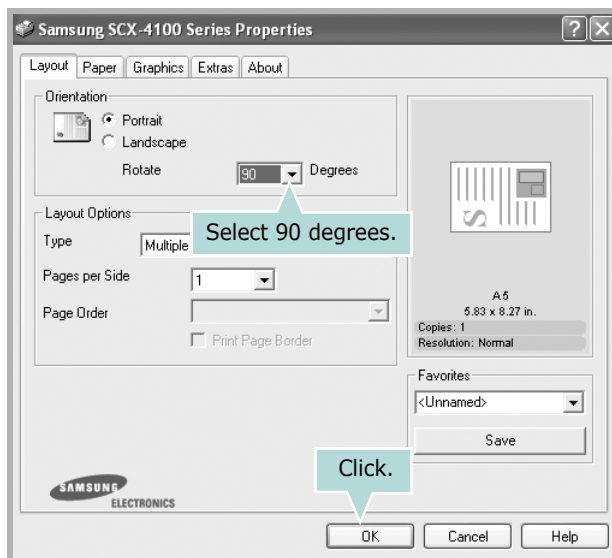

Clearing LCD Error Messages

Messages appears on the display to indicate the control panel to indicate the machine's status or errors. Refer to the following table to understand the message's meaning and correct the problem, if necessary. Messages and their meanings are listed in alphabetical order.

Display	Meaning	Suggested solutions
Door Open	The front or rear cover is not securely latched.	Close the cover until it locks into place.
[JAM 1] or [No Cartridge]	The toner cartridge is not installed.	Install the toner cartridge. See page 1.6.
Low Heat Error	There is a problem in the fuser unit.	Unplug the power cord and plug it back in. If the problem persists, please call for service.
Open Heat Error		
[Over Heat]		
[LSU Error]	A problem has occurred in the LSU (Laser Scanning Unit).	Unplug the power cord and plug it back in. If the problem persists, please call for service.
No Paper [Add Paper]	The paper tray has run out of paper.	Load paper in the paper tray. See page 1.8.
Paper Jam 0 Open/Close Door	Paper has jammed in the feeding area of the paper tray.	Clear the jam. See page 8.2.
Paper Jam 1 Open/Close Door	<ul style="list-style-type: none"> • Paper has jammed in the fuser area. • A paper jam has occurred in the manual feeder or the machine detects non-feeding from the manual feeder. 	<ul style="list-style-type: none"> • Clear the jam. See page 8.5. • Clear the jam. See page 8.6
Paper Jam 2 Check Inside	Paper has jammed in the paper exit area.	Clear the jam. See page 8.3.

Solving Problems

The following chart lists some conditions that may occur and the recommended solutions. Follow the suggested solutions until the problem is corrected. If the problem persists, please call for service.

Paper Feeding Problems

Condition	Suggested solutions
Paper is jammed during printing.	Clear the paper jam. See page 8.2.
Paper sticks together.	<ul style="list-style-type: none">• Ensure that there is not too much paper in the paper tray. The paper tray can hold up to 250 sheets of paper, depending on the thickness of your paper.• Make sure that you are using the correct type of paper. See "Paper Specifications" on page A.5.• Remove paper from the paper tray and flex or fan the paper.• Humid conditions may cause some paper to stick together.
Multiple sheets of paper do not feed.	<ul style="list-style-type: none">• Different types of paper may be stacked in the paper tray. Load the paper of only one type, size and weight.• If multiple sheets have caused a paper jam, clear the paper jam. See page 8.2.
Paper does not feed into the machine.	<ul style="list-style-type: none">• Remove any obstructions inside the machine.• Paper has not been loaded correctly. Remove paper from the tray and reload it correctly.• There is too much paper in the paper tray. Remove excess paper from the tray.• The paper is too thick. Use only paper that meets the specifications required by the machine. See "Paper Specifications" on page A.5.
The paper keeps jamming.	<ul style="list-style-type: none">• There is too much paper in the paper tray. Remove excess paper from the tray.• An incorrect type of paper is being used. Use only paper that meets the specifications required by the machine. See "Paper Specifications" on page A.5. If you are printing on special materials, use the manual feeder.• There may be debris inside the machine. Open the front cover and remove the debris.
Transparencies stick together in the paper exit.	Use only the transparencies specifically designed for a laser printer. Remove each transparency as it exits from the machine.
Envelopes skew or fail to feed correctly.	Ensure that the paper guides are against both sides of the envelopes.

Printing Problems

Condition	Possible cause	Suggested solutions
The machine does not print.	The machine is not receiving power.	Check the power cord connections. Check the power switch and the power source.
	The machine is not selected as the default printer.	Select Samsung SCX-4100 Series as your default printer in your Windows.
	Check the machine for the following: <ul style="list-style-type: none"> • The front or rear cover is not closed. • Paper is jammed. • No paper is loaded. • The toner cartridge is not installed. 	After locating the problem, clear it. <ul style="list-style-type: none"> • Close the cover. • Clear the paper jam. See page 8.2. • Load paper. See page 1.8. • Install the toner cartridge. See page 1.6. If a printer system error occurs, contact your service representative.
	The connection cable between the computer and the machine is not connected properly.	Disconnect the printer cable and reconnect it.
	The connection cable between the computer and the machine is defective.	If possible, attach the cable to another computer that is working properly and print a document. You can also try using a different printer cable.
	The port setting is incorrect.	Check the Windows printer setting to make sure that the print job is sent to the correct port, for example, LPT1. If the computer has more than one port, make sure that the machine is attached to the correct one.
	The machine may be configured incorrectly.	Check the printer properties to ensure that all of the print settings are correct.
	The printer driver may be incorrectly installed.	Remove the printer driver and then reinstall it; see page 1.16 and page 1.16 respectively.
	The machine is malfunctioning.	Check the display message on the control panel to see if the machine is indicating a system error.

Condition	Possible cause	Suggested solutions
The machine selects print materials from the wrong paper source.	The paper source selection in the printer properties may be incorrect.	For many software applications, the paper source selection is found under the Paper tab within the printer properties. Select the correct paper source. See page 3.8.
A print job is extremely slow.	The job may be very complex.	Reduce the complexity of the page or try adjusting the print quality settings. The maximum print speed of your machine is 15 PPM for Letter-sized paper 14 PPM for A4-sized paper.
	If you are using Windows 9x/Me, the Spooling Setting may be set incorrectly.	From the Start menu, choose Settings and Printers . Right-click the Samsung SCX-4100 Series printer icon, choose Properties , click the Details tab, and then choose the Spool Settings button. Select the spool setting you want.
Half the page is blank.	The page orientation setting may be incorrect.	Change the page orientation in your application. See page 3.3.
	The paper size and the paper size settings do not match.	Ensure that the paper size in the printer driver settings matches the paper in the tray.
The machine prints, but the text is wrong, garbled, or incomplete.	The printer cable is loose or defective.	Disconnect the printer cable and reconnect. Try a print job that you have already printed successfully. If possible, attach the cable and the machine to another computer and try a print job that you know works. Finally, try a new printer cable.
	The wrong printer driver was selected.	Check the application's printer selection menu to ensure that your machine is selected.
	The software application is malfunctioning.	Try printing a job from another application.
	The operating system is malfunctioning.	Exit Windows and reboot the computer. Turn the machine off and then back on again.

Condition	Possible cause	Suggested solutions
Pages print, but are blank.	The toner cartridge is defective or out of toner.	Redistribute the toner, if necessary. See "Redistributing Toner" on page 7.7. If necessary, replace the toner cartridge.
	The file may have blank pages.	Check the file to ensure that it does not contain blank pages.
	Some parts, such as the controller or the board, may be defective.	Contact a service representative.
The illustrations print incorrectly in Adobe Illustrator.	The setting in the software application is wrong.	Select Download as Bit Image in the Advanced Options window of the Graphic properties and print the document.
An error occurs repeatedly when you are printing with the USB connection.	When the USB mode is set to "Fast", some PC users may experience poor USB communication.	Change the USB mode to "Slow". To do so, follow these steps: 1. Press Menu/Exit on the control panel until "Machine Setup" appears on the top line of the display. 2. Press the scroll button (◀ or ▶) until "USB Mode" appears on the bottom line, and press Start/Enter . 3. Press the scroll button (◀ or ▶) to select "Slow". 4. Press Start/Enter to save the selection. 5. Press Stop/Clear to return to Standby Mode.

Printing Quality Problems

If the inside of the printer is dirty, or paper is improperly loaded, print quality may be reduced. See the table below to clear the problem.

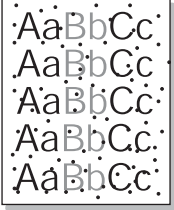
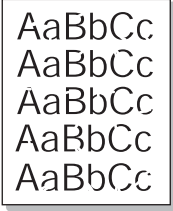
Condition	Suggested solutions
<p>Light or faded print</p> 	<p>If a vertical white streak or faded area appears on the page:</p> <ul style="list-style-type: none"> • The toner supply is low. You may be able to temporarily extend the toner cartridge life. See "Redistributing Toner" on page 7.7. If this does not improve the print quality, install a new toner cartridge. • The paper may not meet paper specifications; for example, the paper is too moist or too rough. See "Paper Specifications" on page A.5. • If the entire page is light, the print resolution setting is too low or Toner Save mode is on. Adjust the print resolution and turn Toner Save mode off. See page 3.8 and page 1.27 respectively. • A combination of faded or smeared defects may indicate that the toner cartridge needs cleaning. See "Cleaning the Drum" on page 7.9. • The surface of the document glass may be dirty. Clean the document glass. See page 7.5. • The surface of the LSU may be dirty. Clean the LSU. See page 7.4.
<p>Toner specks</p> 	<ul style="list-style-type: none"> • The paper may not meet specifications; for example, the paper is too moist or too rough. See "Paper Specifications" on page A.5. • The transfer roller or paper path may be dirty. Clean the inside of your machine and the drum. See page 7.3 and page 7.9.
<p>Dropouts</p> 	<p>If generally rounded faded areas, occur randomly on the page:</p> <ul style="list-style-type: none"> • A single sheet of paper may be defective. Try reprinting the job. • The moisture content of the paper is uneven or the paper has moist spots on its surface. Try a different brand of paper. See "Paper Specifications" on page A.5. • The paper lot is bad. The manufacturing process can cause some areas to reject toner. Try a different kind or brand of paper. • The toner cartridge may be defective. Vertical repetitive defects on the next page. • If these steps do not correct the problems, contact a service representative.

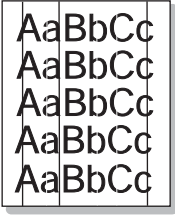
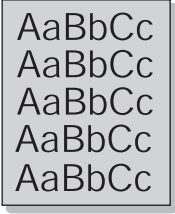
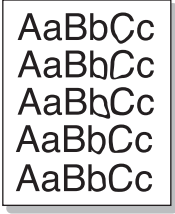
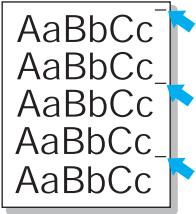
Condition	Suggested solutions
<p>Vertical lines</p> 	<p>If black vertical streaks appear on the page:</p> <ul style="list-style-type: none"> The drum inside the toner cartridge has probably been scratched. Remove the toner cartridge and install a new one. See "Replacing the Toner Cartridge" on page 7.8. <p>If white vertical streaks appear on the page:</p> <ul style="list-style-type: none"> The surface of the LSU part inside the machine may be dirty. Clean the LSU (Clean the LSU. See page 7.4).
<p>Gray background</p> 	<p>If the amount of background shading becomes unacceptable:</p> <ul style="list-style-type: none"> Change to a lighter weight pages. See "Paper Specifications" on page A.5. Check the machine's environment; very dry (low humidity) or high humidity (higher than 80% RH) conditions can increase the amount of background shading. Remove the old toner cartridge and install a new one. See "Replacing the Toner Cartridge" on page 7.8.
<p>Toner smear</p> 	<ul style="list-style-type: none"> Clean the inside of the machine. See page 7.3. Check the paper type and quality. See "Paper Specifications" on page A.5. Remove the toner cartridge and install a new one. See "Replacing the Toner Cartridge" on page 7.8.
<p>Vertical repetitive defects</p> 	<p>If marks repeatedly appear on the printed side of the page at even intervals:</p> <ul style="list-style-type: none"> The toner cartridge may be damaged. If a repetitive mark occurs on the page, print a cleaning sheet several times to clean the cartridge; see "Cleaning the Drum" on page 7.9. After the printout, if you still have the same problems, remove the toner cartridge and install a new one. See "Replacing the Toner Cartridge" on page 7.8. Parts of the machine may have toner on them. If the defects occur on the back of the page, the problem will likely correct itself after a few more pages. The fusing assembly may be damaged. Contact a service representative.

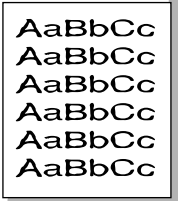
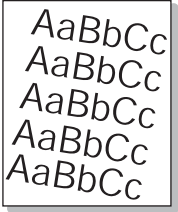
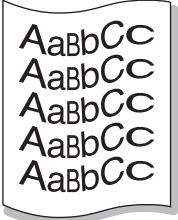
Condition	Suggested solutions
<p>Background scatter</p> 	<p>Background scatter results from bits of toner distributed on the printed page.</p> <ul style="list-style-type: none"> • The paper may be too damp. Try printing with a different batch of paper. Do not open packages of paper until necessary so that the paper does not absorb too much moisture. • If background scatter occurs on an envelope, change the printing layout to avoid printing over areas that have overlapping seams on the reverse side. Printing on seams can cause problems. • If background scatter covers the entire surface area of a printed page, adjust the print resolution through your software application or the printer properties.
<p>Miss-formed characters</p> 	<ul style="list-style-type: none"> • If characters are improperly formed and producing hollow images, the paper stock may be too slick. Try a different paper. See "Paper Specifications" on page A.5. • If characters are improperly formed and producing a wavy effect, the scanner unit may need service. For service, contact a service representative.
<p>Page skew</p> 	<ul style="list-style-type: none"> • Ensure that the paper is loaded properly. • Check the paper type and quality. See "Paper Specifications" on page A.5. • Ensure that the paper or other material is loaded correctly and the guides are not too tight or too loose against the paper stack.
<p>Curl or wave</p> 	<ul style="list-style-type: none"> • Ensure that the paper is loaded properly. • Check the paper type and quality. Both high temperature and humidity can cause paper curl. See "Paper Specifications" on page A.5. • Turn the stack of paper over in the paper tray. Also try rotating the paper 180° in the tray. • Try printing to the rear output slot.

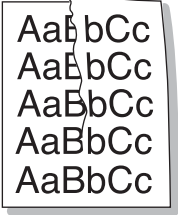
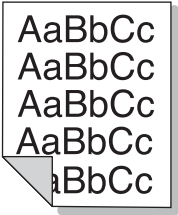
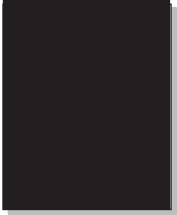
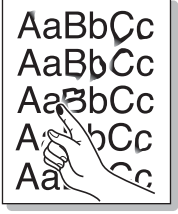
Condition	Suggested solutions
<p>Wrinkles or creases</p> 	<ul style="list-style-type: none"> • Ensure that the paper is loaded properly. • Check the paper type and quality. See "Paper Specifications" on page A.5. • Turn the stack of paper over in the paper tray. Also try rotating the paper 180° in the tray. • Try printing to the rear output slot.
<p>Back of printouts are dirty</p> 	<p>Check for leaking toner. Clean the inside of the machine. See page 7.3.</p>
<p>Black pages</p> 	<ul style="list-style-type: none"> • The toner cartridge may not be installed properly. Remove the cartridge and reinsert. • The toner cartridge may be defective and need replacing. Remove the toner cartridge and install a new one. See "Replacing the Toner Cartridge" on page 7.8. • The machine may require repair. Contact a service representative.
<p>Loose toner</p> 	<ul style="list-style-type: none"> • Clean the inside of the machine. See page 7.3. • Check the paper type and quality. See "Paper Specifications" on page A.5. • Remove the toner cartridge and install a new one. See "Replacing the Toner Cartridge" on page 7.8. • If the problem persists, the machine may require repair. Contact a service representative.

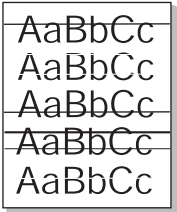
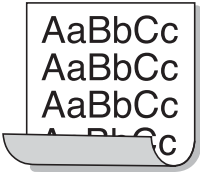
Condition	Suggested solutions
<p>Character Voids</p> 	<p>Character voids are white areas within the parts of characters that should be solid black:</p> <ul style="list-style-type: none"> • If you are using transparencies, try another type of transparency. Due to the composition of the transparency, some character voids are normal. • You may be printing on the wrong side of the paper. Remove the paper and turn it around. • The paper may not meet paper specifications. See "Paper Specifications" on page A.5.
<p>Horizontal stripes</p> 	<p>If horizontally aligned black streaks or smears appear:</p> <ul style="list-style-type: none"> • The toner cartridge may be installed improperly. Remove and reinsert the cartridge. • The toner cartridge may be defective. Remove the toner cartridge and install a new one. See "Replacing the Toner Cartridge" on page 7.8. • If the problem persists, the machine may require repair. Contact a service representative.
<p>Curl</p> 	<p>If the printed paper is curl or paper does not feed into the printer:</p> <ul style="list-style-type: none"> • Turn the stack of paper over in the paper tray. Also try rotating the paper 180° in the paper tray. • Try printing to the rear output slot.

Copying Problems

Condition	Suggested solutions
Copies are too light or too dark.	Use the "Darkness" feature to darken or lighten the background of the copies.
Smears, lines, marks or spots appears on copies.	<ul style="list-style-type: none"> • If defects are on the original document, use the "Darkness" feature to lighten the background of your copies. • If no defects are on the original document, clean the document glass and underside of the document cover. See page 7.5.
Copy image is skewed.	<ul style="list-style-type: none"> • Ensure that the original document is positioned correctly on the document glass. • Check that the copy paper is loaded correctly.
Blank copies print out.	Ensure that the original document is face down on the document glass.
Image rubs off the copy easily.	<ul style="list-style-type: none"> • Replace the paper in the paper tray with paper from a new package. • In high humidity areas, do not leave paper in the machine for the extended periods of time.
Frequent copy paper jams occurs.	<ul style="list-style-type: none"> • Fan the stack of paper, then turn it over in the paper tray. Replace the paper in the tray with a fresh supply. Check/adjust the paper guides, if necessary. • Ensure that the paper is the proper paper weight. 75g/m² (20 lb) bond paper is recommended. • Check for copy paper or pieces of copy paper remaining in the machine after a paper jam has been cleared.
Fewer copies from the toner cartridge than expected prints out.	<ul style="list-style-type: none"> • Your original documents may contain pictures, solids or heavy lines. For example, they may be forms, newsletters, books or other documents that use more toner. • The machine may be turned frequently on and off. • The document cover may be left open while copies are being made.

Scanning Problems

Condition	Suggested solutions
The scanner does not work.	<ul style="list-style-type: none"> • Make sure that you place the document to be scanned face down on the document glass. • There may not be enough available memory to hold the document you want to scan. Try the Prescan function to see if that works. Try lowering the scan resolution rate. • Check that the USB or parallel cable is connected properly. • Make sure that the USB or parallel cable is not defective. Switch the cable with a known good cable. If necessary, replace the cable. • If you are using a parallel cable, ensure that it is compliant with the IEEE 1284 standard. • Check that the scanner is configured correctly. Check scan setting in the SmarThru Configuration or the application you want to use to make certain that the scanner job is being sent to the correct port, for example, LPT1.
The unit scans very slowly.	<ul style="list-style-type: none"> • Check if the machine is printing received data. Scan the document after the current job is completed. • Graphics are scanned more slowly than text. • Communication speed becomes slow in scan mode because of the large amount of memory required to analyze and reproduce the scanned image. Set your computer to the ECP printer mode through BIOS setting. It will help to increase the speed. For details about how to set BIOS, refer to your computer user's guide.
<p>Message appears on your computer screen:</p> <ul style="list-style-type: none"> • "Device can't be set to the H/W mode you want." • "Port is being used by another program." • "Port is Disabled." • "Scanner is busy receiving or printing data. When the current job is completed, try again." • "Invalid handle." • "Scanning has failed." 	<ul style="list-style-type: none"> • There may be a copying or printing job in progress. When the current job is complete, try the job again. • The selected port is currently being used. Restart your computer and try again. • The printer cable may be improperly connected or the power may be off. You must use a USB 1.1 compliant cable or a parallel cable that supports IEEE-1284 bi-directional communications. • The scanner driver is not installed or an operating environment is not set up properly. • Ensure that port is properly connected and power is on, and then restart your computer. • Do not use the parallel and the USB cables at the same time.

Common Linux Problems

Problem	Possible Cause and Solution
The machine doesn't print	<ul style="list-style-type: none"> • Check if the printer driver is installed in your system. Open MFP configurator and switch to the Printers tab in Printers configuration window to look at the list of available printers. Make sure that your machine is displayed on the list. If not, please, invoke Add new printer wizard to set up your device. • Check if the printer is started. Open Printers configuration and select your machine on the printers list. Look at the description in the Selected printer pane. If its status contains "(stopped)" string, please, press the Start button. After that normal operation of the printer should be restored. The "stopped" status might be activated when some problems in printing occurred. For instance, this could be an attempt to print document when MFP port is claimed by a scanning application. • Check if the MFP port is not busy. Since functional components of MFP (printer and scanner) share the same I/O interface (MFP port), the situation of simultaneous access of different "consumer" application to the same MFP port is possible. To avoid possible conflicts, only one of them at a time is allowed to gain control over the device. The other "consumer" will encounter "device busy" response. You should open MFP ports configuration and select the port assigned to your printer. In the Selected port pane you can see if the port is occupied by some other application. If this is the case, you should wait for completion of the current job or should press Release port button, if you are sure that the present owner is not functioning properly. • Check if your application has special print option such as "-oraw". If "-oraw" is specified in the command line parameter then remove it to print properly. For Gimp front-end, select "print" -> "Setup printer" and edit command line parameter in the command item.
The machine does not appear on the scanners list	<ul style="list-style-type: none"> • Check if your machine is attached to your computer. Make sure that it is connected properly via the USB port and is turned on. • Check if the scanner driver for you machine is installed in your system. Open MFP Configurator, switch to Scanners configuration, then press Drivers. Make sure that driver with a name corresponding to your machine's name is listed in the window.

Problem	Possible Cause and Solution
The machine does not appear on the scanners list (continued)	<ul style="list-style-type: none"> • Check if the MFP port is not busy. Since functional components of MFP (printer and scanner) share the same I/O interface (MFP port), the situation of simultaneous access of different "consumer" application to the same MFP port is possible. To avoid possible conflicts, only one of them at a time is allowed to gain control over the device. The other "consumer" will encounter "device busy" response. This can usually happen while starting scan procedure, and appropriate message box displays. To identify the source of the problem, you should open MFP ports configuration and select the port assigned to your scanner. MFP port's symbol /dev/mfp0 corresponds to LP:0 designation displayed in the scanners' options, /dev/mfp1 relates to LP:1 and so on. USB ports start at /dev/mfp4, so scanner on USB:0 relates to /dev/mfp4 respectively and so forth sequentially. In the Selected port pane you can see if the port is occupied by some other application. If this is the case, you should wait for completion of the current job or should press Release port button, if you are sure that the present port's owner is not functioning properly.
The machine doesn't scan	<ul style="list-style-type: none"> • Check if a document is loaded into the machine. • Check if your machine is connected to the computer. Make sure if it is connected properly if I/O error is reported while scanning. • Check if MFP port is not busy. Since functional components of MFP (printer and scanner) share the same I/O interface (MFP port), the situation of simultaneous access of different "consumer" application to the same MFP port is possible. To avoid possible conflicts, only one of them at a time is allowed to gain control over the device. The other "consumer" will encounter "device busy" response. This can usually happen while starting scan procedure, and appropriate message box will be displayed. To identify the source of the problem, you should open MFP ports configuration and select the port assigned to your scanner. MFP port's symbol /dev/mfp0 corresponds to LP:0 designation displayed in the scanners' options, /dev/mfp1 relates to LP:1 and so on. USB ports start at /dev/mfp4, so scanner on USB:0 relates to /dev/mfp4 respectively and so forth sequentially. In the Selected port pane you can see if the port is occupied by some other application. If this is the case, you should wait for completion of the current job or should press Release port button, if you are sure that the present port's owner is not functioning properly.

Problem	Possible Cause and Solution
<p>I can't print when I installed both Linux Print Package (LPP) and MFP driver on the same machine simultaneously.</p>	<ul style="list-style-type: none"> • Since both Linux Printer Package and MFP driver make a symbolic link to "lpr" printing command, which is commonly used on Unix clones, it is not recommended to use both package on the same machine. • If you still want to use both packages simultaneously, please install the LPP first. • If you want to uninstall only one of them, please uninstall both packages and install that one you want to use again. • If you don't want to uninstall MFP driver and install it again, you may make the necessary symbolic link yourself. Please, log in as root user and invoke the following command: <pre>In -sf /usr/local/bin/samsung/slpr /usr/bin/lpr</pre>
<p>Can't scan via Gimp Front-end.</p>	<ul style="list-style-type: none"> • Check if Gimp Front-end has "Xsane:Device dialog.." on the "Acquire" menu. If not, you should install Xsane plug-in for Gimp on the your computer. You can find Xsane plug-in package for Gimp on Linux distribution CD or Gimp home page. For the detail information, refer to the Help for Linux distribution CD or Gimp Front-end application. <p>If you wish to use other kind of scan application, refer to the Help for application.</p>
<p>I encounter error "Cannot open MFP port device file" when printing a document.</p>	<ul style="list-style-type: none"> • Please avoid changing print job parameters (via SLPR utility, for example) while a print job is in progress. Known versions of CUPS server break the print job whenever print options are changed and then try to restart the job from the beginning. Since Linux MFP driver locks MFP port while printing, the abrupt termination of the driver keeps the port locked and therefore unavailable for subsequent print jobs. If this situation occurred, please, try to release the MFP port.





SPECIFICATIONS

This chapter includes:

- **General Specifications**
- **Scanner and Copier Specifications**
- **Printer Specifications**
- **Paper Specifications**

General Specifications

Item	Description
Paper input capacity	Paper tray: 250 sheets (weight: 75 g/m ² , 20 lb) Manual feeder: 1 sheet (weight: 75 g/m ² , 20 lb)
Paper output capacity	Front output tray: 50 sheets (face down) Rear output slot: 1 sheet (face up)
Paper type	Paper tray: Plain paper (60 ~ 90 g/m ² , 16 ~ 24 lb) Manual feeder: Plain paper, Transparencies, Labels, Card stock, Thick, Thin, Bond, Preprinted, Colored, Envelopes (60 ~ 163 g/m ² , 16 ~ 43 lb)
Power requirements	110 ~ 127 VAC, 50/60 Hz, 4.0 A 220 ~ 240 VAC, 50/60 Hz, 2.5 A
Power consumption	Sleep mode: 10W Standby mode: 85W Average: 300 W
Noise *	Warm-up: Less than 42 dB Standby mode: Less than 38 dB Scanning / Printing: Less than 49 dB
Warm-up Time	42 seconds
Operating conditions	Temperature: 50 °F to 89 °F (10 °C to 32 °C) Humidity: 20 % to 80 % RH
LCD	16 characters x 2 lines
Duty Cycle	Monthly: Up to 10,000 pages (Print) Monthly: Up to 2,000 pages (Scan)
Consumables	Single Cartridge
Toner cartridge life **	3,000 pages at ISO 19752 5 % coverage (Ships with 1,000 pages Starter Toner Cartridge)
SET dimension (W x D x H)	422 x 400 x 239 mm (16.6 x 15.8 x 9.4 inch)
Weight	Net: 8.85 Kg (including consumables) Gross: 12.05 Kg(26.55 lb) (including consumables, accessories and package)
Package Weight	Paper: 2.5 Kg Plastic: 0.7 Kg

Item	Description
Interface	USB 1.1 (Compatible with USB 2.0), IEEE 1284 Parallel(ECP Only)
OS Compatibility ***	<ul style="list-style-type: none"> Windows 95/98/Me/NT 4.0/2000/XP Various Linux OS (via USB interface only) including RedHat, Caldera, Mandrake, Slackware, SuSE and Turbo Linux

* Sound Pressure Level, ISO7779.

** May be affected by operating environment, printing interval, media type, media size and color/black.

*** Please visit www.samsungprinter.com to download the latest software version.

Scanner and Copier Specifications

Item	Description
Compatibility	TWAIN standard
Scan method	Color CIS
Scan resolution	600 X 600 dpi (optical)
Scan length	Maximum: 11.7 inches (297 mm)
Scan width	Maximum: 8.5 inches (216 mm) Effective: 8.2 inches (208 mm)
Color bit depth	8 bit, 24 bit
Mono bit depth	1 bit for Text mode 8 bit for Gray mode
Scan speed	27 seconds (Lineart) 72 seconds (Gray Scale) 150 seconds (Color 300dpi)
Copy speed *	Up to 14 cpm in A4 (15 cpm in Letter)
Copy resolution	600 x 600 dpi
Zoom rate	50 ~ 200 %
Multiple copies	99 pages
Halftone	256 levels

* Copy Speed is based on Single Document Multiple Copy.

Printer Specifications

Item	Description
Print method	Laser Beam Printing
Print speed *	Up to 14 ppm in A4 (15 ppm in Letter)
Paper size	Paper tray: Letter, A4, Legal, Folio, A5, A6, B5 Manual feeder: Letter, A4, Legal, Folio, Executive, A5, B5, Post Card 4x6, Envelope 10, Envelope DL, Envelope C5, Envelope C6, Envelope Monarch, Envelope B5 * Min.: 76 x 127 mm (3 x 5 in.) Max.: 216 x 356 mm (8.5 x 14 in.)
Print resolution	600 x 600 dpi
Emulation	SPL (Samsung Printer Language)
Memory	8MB (Max. 8MB)
First printing time	Standby mode: 12 seconds

* Print speed will be affected by Operating system used, computing performance, application software, connecting method, media type, media size and job complexity.

Paper Specifications

Overview

Your machine accepts a variety of print materials, such as cut-sheet paper, including up to 100% recycled fiber content paper, envelopes, labels, transparencies, and custom-size paper. Properties, such as weight, composition, grain, and moisture content, are important factors affecting the machine's performance and the output quality. Paper that does not meet the guidelines outlined in this user's guide can cause the following problems:

- Poor print quality
- Increased paper jams
- Premature wear on the machine.

NOTES:

- Some paper may meet all of the guidelines in this guide and still not produce satisfactory results. This may be the result of improper handling, unacceptable temperature and humidity levels or other variables over which Samsung has no control.
- Before purchasing large quantities of paper, insure the paper meets the requirements specified in this user's guide.

CAUTION: Using paper that does not meet these specifications may cause problems, requiring repairs. These repairs are not covered by the Samsung warranty or service agreements.

Supported Sizes of Paper

Size (mm/in.)	Weight	Capacity*
Plain paper Letter (216 x 279/8.5 x 11) Legal (216 x 356/8.5 x 14) Executive (184 x 267/7.2 x 10.5) A4 (210 x 297/8.3 x 11.7) A5 (148 x 210/5.8 x 8.3) A6 (105 x 148/4.1 x 5.8) Folio (216 x 330/8.5 x 13)	<ul style="list-style-type: none"> 60 to 90 g/m² bond (16 to 24 lb) for the paper tray 60 to 163 g/m² bond (16 to 43 lb) for the manual feeder 	<ul style="list-style-type: none"> 250 sheets of 75 g/m² bond (20 lb) paper for the paper tray 1 sheet of paper for the manual feeder
Envelopes JIS B5 (182 x 257/7.2 x 10.1) No.10 (105 x 241/4.1 x 9.5) DL (110 x 220/4.3 x 8.7) C5 (162 x 229/6.4 x 9) C6 (114 x 162/4.5 x 6.4) ISO B5 (176 x 250/6.9 x 9.8) Monarch (98 x 191/3.9 x 7.5)	75 to 90 g/m ²	1 sheet of paper for the manual feeder
Labels Letter (216 x 279/8.5 x 11) A4 (210 x 297/8.3 x 11.7)	120 to 150 g/m ²	1 sheet of paper for the manual feeder
Transparency films Letter (216 x 279/8.5 x 11) A4 (210 x 297/8.3 x 11.7)	138 to 146 g/m ²	
Card stocks Post Card (101.6 x 152.4/4 x 6)	90 to 163 g/m ²	
Minimum size (custom)	60 to 120 g/m ² bond (16 to 32 lb)	
Maximum size (Legal)		

* Capacity may vary depending on print materials' weight and thickness, and environmental conditions.

NOTE: You may experience jams when using print materials with a length of less than 127 mm (5 in.). For optimum performance, ensure that you are storing and handling the paper correctly. Please refer to "Paper Storage Environment" on page A.9.

Guidelines for Using Paper

For the best result, use conventional 75 g/m² (20 lb) paper. Ensure that the paper is of good quality, and free of cuts, nicks, tears, spots, loose particles, dust, wrinkles, voids, and curled or bent edges.

If you are unsure of what type of paper you are loading, such as bond or recycled paper, check the label on the package.

The following problems may cause print quality deviations, jamming, or even damage to the machine:

Symptom	Problem with Paper	Solution
Poor print quality or toner adhesion, problems with feeding	Too moist, too rough, too smooth, or embossed; faulty paper lot	Try another kind of paper, between 100 ~ 400 Sheffield, 4 ~ 5 % moisture content.
Dropout, jamming, curl	Stored improperly	Store paper flat in its moisture-proof wrapping.
Increased gray background shading/machine wear	Too heavy	Use lighter paper, use the rear output slot.
Excessive curl problems with feeding	Too moist, wrong grain direction, or short-grain construction	<ul style="list-style-type: none">• Use the rear output slot.• Use long-grain paper.
Jamming, damage to machine	Cut-outs or perforations	Do not use paper with cutouts or perforations.
Problems with feeding	Ragged edges	Use good quality paper.

NOTES:

- Do not use letterhead paper printed with low-temperature inks, such as those used in some types of thermography.
- Do not use raised or embossed letterhead.
- The machine uses heat and pressure to fuse toner to the paper. Insure that any colored paper or preprinted forms use inks that are compatible with this fusing temperature (189 °C or 372.2 °F for 0.1 second).

Paper Specifications

Category	Specifications
Acid Content	5.5 pH or lower
Caliper	0.094 ~ 0.18 mm (3.0 ~ 7.0 mils)
Curl in Ream	Flat within 5 mm (0.02 in.)
Cut Edge Conditions	Cut with sharp blades with no visible fray.
Fusing Compatibility	Must not scorch, melt, offset or release hazardous emissions when heated to 200 °C (392 °F) for 0.1 second.
Grain	Long Grain
Moisture Content	4 % ~ 6 % by weight
Smoothness	100 ~ 400 Sheffield

Paper Output Capacity

Output Location	Capacity
Face-down output tray	50 sheets of 75 g/m ² bond (20 lb) paper
Face-up output slot	1 sheet of 75 g/m ² bond (20 lb) paper

Paper Storage Environment

Paper storage environment conditions directly affect the feed operation.

Ideally, the machine and paper storage environment should be at or near room temperature, and not too dry or humid. Remember that paper is hygroscopic; it absorbs and loses moisture rapidly.

Heat works with humidity to damage paper. Heat causes the moisture in paper to evaporate, while cold causes it to condense on the sheets. Heating systems and air conditioners remove most of the humidity from a room. As paper is opened and used, it loses moisture, causing streaks and smudging. Humid weather or water coolers can cause the humidity to increase in a room. As paper is opened and used it absorbs any excess moisture, causing light print and dropouts. Also, as paper loses and gains moisture it can become distorted. This can cause paper jams.

Care should be taken not to purchase more paper than can be used in a short time (about 3 months). Paper stored for long periods may experience heat and moisture extremes, which can cause damage. Planning is important to prevent damage to large supplies of paper.

Unopened paper in sealed reams can remain stable for several months before use. Opened packages of paper have more potential for environment damage, especially if they are not wrapped with a moisture-proof barrier.

The paper storage environment should be properly maintained to ensure optimum performance. The optimum condition is 20 to 24 °C (68 to 75 °F), with a relative humidity of 45 % to 55 %. The following guidelines should be considered when evaluating the paper's storage environment:

- Paper should be stored at or near room temperature.
- The air should not be too dry or too humid.
- The best way to store an opened ream of paper is to rewrap it tightly in its moisture-proof wrapping. If the machine environment is subject to extremes, unwrap only the amount of paper to be used during the day's operation to prevent unwanted moisture changes.

Envelopes

Envelope construction is critical. Envelope fold lines can vary considerably, not only between manufacturers, but also within a box from the same manufacturer. Successful printing on envelopes depends upon the quality of the envelopes. When selecting envelopes, consider the following components:

- Weight: The weight of the envelope paper should not exceed 90g/m² (24lb) or jamming may occur.
- Construction: Prior to printing, envelopes should lie flat with less than 6mm (0.25in.) curl, and should not contain air.
- Condition: Envelopes should not be wrinkled, nicked or otherwise damaged.
- Temperature: You should use envelopes that are compatible with the heat and pressure of the machine.
- Size: You should only use envelopes within the following size ranges

NOTES:

- Use only the manual feeder to print envelopes.
 - You may experience some paper jams when using any media with a length less than 140 mm (5.5 in.). This may be caused by paper that has been affected by environmental conditions. For optimum performance, make sure you are storing and handling the paper correctly. Please refer to "Paper Storage Environment" on page A.9.
-

Envelopes with Double Side Seams

Double side-seam construction has vertical seams at both ends of the envelope rather than diagonal seams. This style may be more likely to wrinkle. Be sure the seam extends all the way to the corner of the envelope as illustrated below.

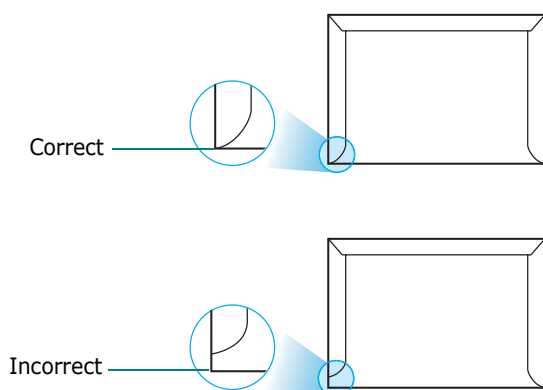

Envelopes with Adhesive Strips or Flaps

Envelopes with a peel-off adhesive strip or with more than one flap that folds over to seal must use adhesives compatible with the heat and pressure in the machine. The extra flaps and strips might cause wrinkling, creasing or even jams and may even damage the fuser.

Envelope Margins

The following gives typical address margins for a commercial #10 or DL envelope.

Type of Address	Minimum	Maximum
Return address	15 mm (0.6 in.)	51 mm (2 in.)
Delivery address	51 mm (2 in.)	90 mm (3.5 in.)

NOTES:

- For the best print quality, position margins no closer than 15 mm (0.6 in.) from the edges of the envelope.
 - Avoid printing over the area where the envelope's seams meet.
-

Envelope Storage

Proper storage of envelopes helps contribute to print quality. Envelopes should be stored flat. If air is trapped in an envelope, creating an air bubble, then the envelope may wrinkle during printing.

Labels

CAUTIONS:

- To avoid damaging the machine, use only labels recommended for laser printers.
 - To prevent serious jams, always use the manual feeder to print labels and always use the rear output tray.
 - Never print on the same sheet of labels more than once and never print on a partial sheet of labels.
-

When selecting labels, consider the quality of each component:

- Adhesives: The adhesive material should be stable at 208°C (406.4°F), the machine's fusing temperature.
- Arrangement: Only use labels with no exposed backing between them. Labels can peel off sheets with spaces between the labels, causing serious jams.
- Curl: Prior to printing, labels must lie flat with no more than 13mm (5in.) of curl in any direction.
- Condition: Do not use labels with wrinkles, bubbles or other indications of separation.

Transparencies

Transparencies used in the machine must be able to withstand 165°C (329°F), the machine's fusing temperature.

CAUTION: To avoid damaging the machine, use only transparencies recommended for use in laser printers.



INDEX

Numerics

2-side, special copy 4.10
2-up, special copy 4.11

A

auto fit, special copy 4.9

C

canceling
 copy 4.4
 print 3.5
 scan 5.5
cleaning
 document glass 7.5
 drum 7.9
 inside 7.3
 outside 7.3
clone, special copy 4.8
connect
 parallel cable 1.11
 USB cable 1.11
connection
 AC power 1.13
consumables 7.9
control panel 1.5
copying 4.3
 darkness, set 4.5
 default setting, change 4.13
 number of pages 4.5
 original type 4.7
 size 4.6
 special features 4.8
 time out, set 4.14

D

Darkness 4.5
display language, change 1.25
document
 loading 1.8
 preparing 4.2
document glass

 clean 7.5
 load 4.3
drum, clean 7.9

E

error messages 8.8

F

Favorite setting, use 3.6
fitting to page
 copy 4.9
 print 3.13
front output tray, use 2.5

G

Getting 6.2
graphic properties, set 3.8

H

help, use 3.6

I

installing
 Linux software 6.3
 SmarThru 1.20
 toner cartridge 1.6

J

jam, clear
 paper 8.2

L

Linux
 common problems 8.20
 driver, install 6.4
 printing 6.12
 scanning 6.14

M

memory, clear 7.2
MFP driver, install
Linux 6.4

N

network printer, set 3.22
n-up (multiple pages per sheet)
copy 4.11

O

orientation, print 3.3, 6.13
output location, select 2.4
overlay, use 3.18

P

paper guidelines 2.3
paper jam, clear 8.2
paper load
in manual feeder 2.9
in paper tray 1.8
paper load capacity 2.2
paper properties, set 3.7
paper size, set
manual feeder 2.11
paper tray 1.26
print 3.7, 6.13
paper source, set 3.8, 6.13
paper type 2.2
paper type, set
manual feeder 2.11
paper tray 1.26
print 3.8, 6.13
poster
copy 4.12
print 3.14
power save mode, use 1.27
print order, set 3.4
print resolution 3.9
print, system data 7.2
printer driver, install
Linux 6.4
printer properties
Linux 6.12
windows 3.2
printing
fitting to a selected paper size 3.13
from Linux 6.12
from Windows 3.2

multiple pages on one sheet 3.10
posters 3.14
reduced or enlarged document
3.12
using overlays 3.18
watermarks 3.15
problems, solve
copying 8.18
error messages 8.8
Linux 8.20
paper feeding 8.9
printing 8.10
printing quality 8.13
scanning 8.19

R

rear output slot, use 2.6
reduced/enlarged
copy 4.6
print 3.12
resolution
print 3.9

S

scanning
Linux 6.14
Windows 5.2
sharing printer, set 3.22
SmarThru
install 1.20
uninstall 1.24
specifications
general A.2
paper A.5
printer A.4
scanner and copier A.3
system requirements
Linux 6.3
Windows 1.16

T

toner cartridge
install 1.6
life 7.6
redistribute 7.7
replace 7.8
toner save mode, use 1.27
TWAIN, scan 5.6

U

uninstalling

 MFP driver

 Linux 6.6

 Windows 1.23

 Remote Control Panel 1.23

 SmarThru 1.24

USB

 mode, change 8.12

W

watermarks, use 3.15



Visit us at:

www.samsungprinter.com

Rev.1.00

Free Manuals Download Website

<http://myh66.com>

<http://usermanuals.us>

<http://www.somanuals.com>

<http://www.4manuals.cc>

<http://www.manual-lib.com>

<http://www.404manual.com>

<http://www.luxmanual.com>

<http://aubethermostatmanual.com>

Golf course search by state

<http://golfingnear.com>

Email search by domain

<http://emailbydomain.com>

Auto manuals search

<http://auto.somanuals.com>

TV manuals search

<http://tv.somanuals.com>