

# Blu-ray™ Disc Player

## user manual

imagine the possibilities



Thank you for purchasing this Samsung product.  
To receive more complete service,  
please register your product at  
[www.samsung.com/register](http://www.samsung.com/register)



# Safety Information

## Warning

TO REDUCE THE RISK OF ELECTRIC SHOCK, DO NOT REMOVE THE COVER (OR BACK). NO USER-SERVICEABLE PARTS ARE INSIDE. REFER SERVICING TO QUALIFIED SERVICE PERSONNEL.

	<b>CAUTION</b> RISK OF ELECTRIC SHOCK DO NOT OPEN	
The lightning flash and Arrowhead within the triangle is a warning sign alerting you of dangerous voltage inside the product.	<b>CAUTION:</b> TO REDUCE THE RISK OF ELECTRIC SHOCK, DO NOT REMOVE COVER (OR BACK) NO USER SERVICEABLE PARTS INSIDE. REFER SERVICING TO QUALIFIED SERVICE PERSONNEL.	The explanation point within the triangle is a warning sign alerting you of important instructions accompanying the product.

### WARNING

- To reduce the risk of fire or electric shock, do not expose this appliance to rain or moisture.

### FCC NOTE (for U.S.A)

This equipment has been tested and found to comply with the limits for a Class B digital device, pursuant to Part 15 of the FCC rules. These limits are designed to provide reasonable protection against harmful interference in a residential installation. This equipment generates, uses and can radiate radio frequency energy and, if not installed and used in accordance with the instructions, may cause harmful interference to radio or television reception, which can be determined by turning the equipment off and on.

The user is encouraged to try to correct the interference by one or more of the following measures.

- Reorient or relocate the receiving antenna.
- Increase the separation between the equipment and receiver.
- Connect this equipment into an outlet on a circuit different from that to which the receiver is connected.
- Consult the dealer or an experienced radio/TV technician for help.
- This class B digital product meets all requirements of the Canadian Interference - Causing Equipment Regulations.

### Note to CATV system installer

This reminder is provided to call CATV system installer's attention to Article 820-40 of the National Electrical Code (Section 54 of Canadian Electrical Code, Part I) that provides guidelines for proper grounding and, in particular, specifies that the cable ground shall be connected to the grounding system of the building as close to the point of cable entry as practical.

### CLASS 1 LASER PRODUCT

This Compact Disc player is classified as a CLASS 1 LASER product. Use of controls, adjustments or performance of procedures other than those specified herein may result in hazardous radiation exposure.

Complies with 21CFR 1040.10 except for deviations pursuant to Laser Notice No. 50, dated June 24, 2007.

#### DANGER :

- VISIBLE AND INVISIBLE LASER RADIATION WHEN OPEN. AVOID DIRECT EXPOSURE TO BEAM. (FDA 21 CFR)

#### CAUTION :

- CLASS 3B VISIBLE AND INVISIBLE LASER RADIATION WHEN OPEN. AVOID EXPOSURE TO THE BEAM. (IEC 60825-1)
- THIS PRODUCT UTILIZES A LASER. USE OF CONTROLS OR ADJUSTMENTS OR PERFORMANCE OF PROCEDURES OTHER THAN THOSE SPECIFIED HEREIN MAY RESULT IN HAZARDOUS RADIATION EXPOSURE. DO NOT OPEN COVER AND DO NOT REPAIR YOURSELF. REFER SERVICING TO QUALIFIED PERSONNEL.

<b>CLASS 1</b>	<b>LASER PRODUCT</b>
<b>KLASSE 1</b>	<b>LASER PRODUKT</b>
<b>LUOKAN 1</b>	<b>LASER LAITE</b>
<b>KLASS 1</b>	<b>LASER APPARAT</b>
<b>PRODUCTO</b>	<b>LÁSER CLASE 1</b>

#### NOTE

- ▶ If the Region number of a Blu-ray Disc/DVDs does not correspond to the Region number of this player, the player cannot play the disc.

## Precautions

### Important Safety Instructions

Read these operating instructions carefully before using the unit. Follow all the safety instructions listed below.

Keep these operating instructions handy for future reference.

1. Read these instructions.
2. Keep these instructions.
3. Heed all warnings.
4. Follow all instructions.
5. Do not use this apparatus near water.
6. Clean only with a dry cloth.
7. Do not block any ventilation openings. Install in accordance with the manufacturer's instructions.
8. Do not install near any heat sources such as radiators, heat registers, stoves, or other apparatus (including AV receivers) that produce heat.
9. Do not defeat the safety purpose of the polarized or grounding-type plug. A polarized plug has two blades with one wider than the other. A grounding type plug has two blades and a third grounding prong. The wide blade or the third prong are provided for your safety. If the provided plug does not fit into your outlet, consult an electrician for replacement of the obsolete outlet.
10. Protect the power cord from being walked on or pinched particularly at plugs, convenience receptacles, and the point where it exits the apparatus.
11. Only use attachments/accessories specified by the manufacturer.
12. Use only with the cart, stand, tripod, bracket, or table specified by the manufacturer, or sold with the apparatus. When a cart is used, use caution when moving the cart/apparatus combination to avoid injury from tip-over.



13. Unplug this apparatus during lightning storms or when unused for long periods of time.
14. Refer all servicing to qualified service personnel. Servicing is required when the apparatus has been damaged in any way, such as when the power-supply cord or plug is damaged, liquid has been spilled or objects have fallen into the apparatus, the apparatus has been exposed to rain or moisture, does not operate normally, or has been dropped.

## Disc Storage & Management

- Holding Discs
  - Fingerprints or scratches on a disc may reduce sound and picture quality or cause skipping
  - Avoid touching the surface of a disc where data has been recorded.
  - Hold the disc by the edges so that fingerprints will not get on the surface.
  - Do not stick paper or tape on the disc.
- Cleaning Discs
  - If you get fingerprints or dirt on a disc, clean it with a mild detergent diluted in water and wipe with a soft cloth.
  - When cleaning, wipe gently from the inside to the outside of the disc.
- Disc Storage
  - Do not keep in direct sunlight.
  - Keep in a cool ventilated area.
  - Keep in a clean protection jacket and store vertically.



## Handling Cautions

- Do not expose this apparatus to dripping or splashing. Do not put objects filled with liquids, such as vases on the apparatus.
- To turn this apparatus off completely, you must pull the power plug out of the wall socket. Consequently, the power plug must be easily and readily accessible at all times.

# Safety Information

- Do not plug multiple electric devices into the same wall socket. Overloading a socket can cause it to overheat, resulting in a fire.
- Maintenance of Cabinet.
  - Before connecting other components to this player, be sure to turn them off.
  - If you move your player suddenly from a cold place to a warm place, condensation may occur on the operating parts and lens and cause abnormal disc playback. If this occurs, unplug the player, wait for two hours, and then connect the plug to the power outlet. Then, insert the disc, and try to play back again.
- If the product makes an abnormal noise or produces a burning smell or smoke, turn off the power switch immediately and disconnect the power plug from the wall outlet. Then, contact the nearest customer service center for technical assistance. Do not use the product. Using the product as it is may cause a fire or an electric shock.
- Do not use the 3D function or 3D Active Glasses while walking or moving around. Using the 3D function or 3D Active Glasses while moving around may cause you to bump into objects, trip, and/or fall, and cause serious injury.
- If you want to enjoy 3D content, connect a 3D device (3D compliant AV receiver or TV) to the player's HDMI OUT port using a high-speed HDMI cable. Put on 3D glasses before playing the 3D content.
- The player outputs 3D signals only through HDMI cable connected to the HDMI OUT port.
- As the video resolution in 3D play mode is fixed according to the resolution of the original 3D video, you can not change the resolution to your preference.
- Some functions such as BD Wise, screen size adjustment, and resolution adjustment may not operate properly in 3D play mode.
- You must use a high-speed HDMI cable for proper output of the 3D signal.
- Stay at least three times the width of the screen from the TV when watching 3D images. For example, if you have a 46-inch screen, stay 138 inches (11.5 feet) from the screen.
- Place the 3D video screen at eye level for the best 3D picture.
- When the player is connected to some 3D devices, the 3D effect may not function properly.
- This player does not convert 2D content into 3D.
- "Blu-ray 3D" and "Blu-ray 3D" logo are trademarks of the Blu-ray Disc Association.

## Using the 3D function

### IMPORTANT HEALTH AND SAFETY INFORMATION FOR 3D PICTURES.

Read and understand the following safety information before using the 3D function.

- Some viewers may experience discomfort while viewing 3D TV such as dizziness, nausea, and headaches. If you experience any such symptom, stop viewing 3D TV, remove the 3D Active Glasses, and rest.
- Watching 3D images for an extended period of time may cause eye strain. If you feel eye strain, stop viewing 3D TV, remove your 3D Active Glasses, and rest.
- A responsible adult should frequently check on children who are using the 3D function. If there are any reports of tired eyes, headaches, dizziness, or nausea, have the child stop viewing 3D TV and rest.
- Do not use the 3D Active Glasses for other purposes (Such as general eyeglasses, sunglasses, protective goggles, etc.)

## Copyright

© 2012 Samsung Electronics Co.,Ltd.

All rights reserved; No part or whole of this user's manual may be reproduced or copied without the prior written permission of Samsung Electronics Co.,Ltd.

## SAFETY INFORMATION

- 2 **Warning**
- 3 **Precautions**
  - 3 Important Safety Instructions
- 3 **Disc Storage & Management**
- 3 **Handling Cautions**
- 4 **Using the 3D function**
- 4 **Copyright**

## GETTING STARTED

- 7 **Disc and Format Compatibility**
  - 7 Disc types and contents your player can play
  - 7 Disc types your player cannot play
  - 8 Region Code
- 8 **Logos of Discs the player can play**
  - 9 Supported Formats
- 11 **Accessories**
- 12 **Front Panel**
- 12 **Rear Panel**
- 13 **Remote Control**
  - 13 Tour of the Remote Control

## CONNECTIONS

- 14 **Connecting to a TV**
- 15 **Connecting to an Audio System**
  - 15 **Method 1** Connecting to an HDMI supported AV receiver
  - 15 **Method 2** Connecting to an AV receiver with Dolby Digital or DTS decoder
- 16 **Connecting to a Network Router**
  - 16 Wired Network
  - 16 Wireless Network

## SETTINGS

- 17 **The Initial Settings Procedure**
- 17 **The Home Screen**
- 18 **Accessing the Settings Screen**
  - 18 Buttons on the Remote Control Used for the Settings Menu
- 19 **Settings Menu Functions**
- 24 **Networks and the Internet**
  - 24 Configuring Your Network Connection
  - 26 Wi-Fi Direct
  - 27 Soft AP
  - 28 AllShare Settings
- 28 **Upgrading Software**
  - 28 By Online
  - 29 By USB
  - 29 By Disc
  - 29 By Downloaded
  - 30 Standby Mode Upgrade

## MEDIA PLAY

- 31 **Playing Commercial Video Discs**
- 31 **The AllShare Play Screen**
  - 31 Accessing the AllShare Play Screen
  - 31 The AllShare Play Screen at a Glance
- 31 **Playing Files on a USB Device or USB Compatible Mobile Phone**
- 32 **Playing Commercial Audio Discs**
  - 32 Music Screen Controls
- 33 **Playing a Disc with User Recorded Content**
- 33 **Using the AllShare Network Function**
  - 33 To Download the AllShare Software
  - 34 Playing Content Located on Your PC or DLNA Device through the Blu-ray Disc Player
  - 34 Controlling the Playback of Content Located on Your PC with Your Smart Phone

# Contents

35	<b>Controlling Video Playback</b>
35	Buttons on the Remote Control used for Video Playback
35	Using the Tools Menu
37	<b>Controlling Music Playback</b>
37	Buttons on the Remote Control used for Music Playback
37	Using the Tools Menu
37	Repeating Tracks on an Audio CD
37	Shuffling Tracks on an Audio CD
38	Creating a Playlist from a CD
38	Ripping
39	<b>Playing Photo Contents</b>
39	Using the Tools Menu
39	<b>Using the Tools Menu when a file is highlighted</b>

## NETWORK SERVICES

42	<b>Using Smart Hub</b>
42	Smart Hub at a Glance
43	Using the Web Browser
44	<b>BD-LIVE™</b>
44	<b>Using Disc to Digital</b>
45	Registering a DVD Movie in Disc to Digital
45	Playing a Registered Disc to Digital Movie

## APPENDIX

46	<b>Compliance and Compatibility Notice</b>
47	<b>Copy Protection</b>
47	<b>Network Service Disclaimer</b>
48	<b>License</b>
50	<b>Additional Information</b>
50	Note
52	Resolution according to the contents type
53	Digital Output Selection
54	<b>Troubleshooting</b>
56	Repairs
57	<b>Specifications</b>

## Disc and Format Compatibility

### Disc types and contents your player can play

Media	Disc Type	Details
VIDEO	Blu-ray Disc 3D Blu-ray Disc	BD-ROM or BD-RE/-R recorded in the BD-RE format.
	DVD-VIDEO DVD-RW DVD-R DVD+RW DVD+R	DVD-VIDEO, recorded DVD+RW/DVD-RW(V)/DVD-R/+R that have been recorded and finalized, or a USB storage media containing MKV, MP4 contents.
MUSIC	CD-RW/-R, DVD-RW/-R, BD-RE/-R	Music recorded on CD-RW/-R, DVD-RW/-R, BD-RE/-R or a USB storage media containing MP3 or WMA contents.
PHOTO	CD-RW/-R, DVD-RW/-R, BD-RE/-R	Photos recorded on CD-RW/-R, DVD-RW/-R, BD-RE/-R or a USB storage media containing JPEG contents.

#### NOTE

- ▶ The player may not play certain CD-RW/-R and DVD-R because of the disc type or recording conditions.
- ▶ If a DVD-RW/-R has not been recorded properly in DVD video format, it will not be playable.
- ▶ Your player will not play content that has been recorded on a DVD-R at a bit-rate that exceeds 10 Mbps.
- ▶ Your player will not play content that has been recorded on a BD-R or USB device at a bitrate that exceeds 25 Mbps.
- ▶ Playback may not work for some types of discs, or when you use specific functions, such as angle change and aspect ratio adjustment. Information about the discs is written in detail on the disc box. Please refer to this if necessary.
- ▶ When you play a BD-J title, loading may take longer than a normal title or some functions may perform slowly.

### Disc types your player cannot play









- HD DVD
- DVD-ROM/PD/MV, etc
- DVD-RAM
- Super Audio CD (except CD layer)
- DVD-RW(VR mode)
- CVD/CD-ROM/CDV/CD-G/CD-I/LD (CD-Gs play audio only, not graphics.)
- 3.9 GB DVD-R for Authoring.

# Getting Started

## Region Code

Both players and discs are coded by region. These regional codes must match for a disc to play. If the codes do not match, the disc will not play.

The Region Number for this player is displayed on the rear panel of the player.

Disc Type	Region Code	Area
Blu-ray Disc		North America, Central America, South America, Korea, Japan, Taiwan, Hong Kong and South East Asia.
		Europe, Greenland, French territories, Middle East, Africa, Australia and New Zealand.
		India, China, Russia, Central and South Asia.
DVD-VIDEO		The U.S., U.S. territories and Canada
		Europe, Japan, the Middle East, Egypt, South Africa, Greenland
		Taiwan, Korea, the Philippines, Indonesia, Hong Kong
		Mexico, South America, Central America, Australia, New Zealand, Pacific Islands, Caribbean
		Russia, Eastern Europe, India, most of Africa, North Korea, Mongolia
		China

## Logos of Discs the player can play

	
Blu-ray Disc	3D Blu-ray Disc
	
BD-LIVE	NTSC broadcast system in U.S.A, Canada, Korea, Japan



## Supported Formats

### Video File Support

File Extension	Container	Video Codec	Resolution	Frame rate (fps)	Bitrate (Mbps)	Audio Codec
*.avi	AVI MKV ASF MP4 3GP VRO VOB PS TS	MPEG4 SP/ASP	1920x1080	6~30	20	Dolby Digital LPCM AAC HE-AAC WMA DD+ MP3 DTS
*.mkv		H.264 BP/ MP/HP			25	
*.asf		H.263	720x480		10	
*.wmv				Window Media Video v9	1920x1080	
*.mp4		MPEG2	24/25/30			
*.3gp				MPEG1	352x288	
*.vro						
*.mpg						
*.mpeg						
*.ts						
*.tp						
*.trp						

#### ■ Limitations

- Even when a file is encoded by a supported codec listed above, the file might not be played if its content is defective or corrupted.
- Normal playback is not guaranteed if the file's container information is wrong or the file itself is corrupted.
- Files having higher bit or frame rates than standard may stutter when played back.
- The seek (skip) function is not available if the file's index table is damaged.
- When you playback a file remotely through a network connection, video playback may stutter depending on the network speed.
- Some USB/Digital camera devices may not be compatible with the player.

#### ■ Video decoder

- Supports up to H.264 Level 4.1
- Does not support GMC 2 or higher

#### ■ Audio decoder

- Supports WMA 7, 8, 9 and STD
- Does not support WMA 9 PRO multi-channel or lossless audio if the number of channels is more than 2.
- Does not support WMA sampling rate of 22050Hz mono.

# Getting Started

## ■ Comments

- MPEG4 : Supports up to GMC 1-Warping Point.
- H.264 : Supports up to BP/MP/HP Level 4.1.
- H.263 : Supports up to Profile3, restricted up to SD resolution.
- WMV : Supports V9, VC1 SP/MP/AP L3.
- MPEG1 : Does not support D-picture.
- MPEG2 : Supports up to Hight Profile High Level.

## I NOTE I

- ▶ Some MKV and MP4 format discs may not play, depending on their video resolution and frame rate.

## Music File Support

File Extension	Container	Audio Codec	Support Range
*.mp3	MP3	MP3	-
*.wma	WMA	WMA	* Sampling rates (in kHz) - 8, 11, 16, 22, 32, 44.1, 48 * Bitrates - All bit-rates in the range 5kbps to 384kbps

## Notes on the USB connection

- Your player supports USB storage media, MP3 players, digital cameras, and USB card readers.
- Some USB/digital camera devices may not be compatible with the player.
- Your player supports the FAT16, FAT32, and NTFS files systems.
- Connect USB devices directly to the player's USB port. Connecting through a USB cable may cause compatibility problems.
- Inserting more than one memory device into a multi-card reader may cause the reader to operate improperly.
- The player does not support the PTP protocol.
- Do not disconnect a USB device during a "loading" process.
- The bigger the image resolution, the longer the image takes to display.
- This player cannot play MP3 files with DRM (Digital Rights Management) downloaded from commercial sites.
- Your player only supports video that is under 30fps (frame rate).
- Your player only supports USB Mass Storage Class (MSC) devices such as thumb drives and USB HDD. (HUB is not supported.)
- Certain USB HDD Devices, multi-card readers and thumb drives may not be compatible with this player.
- If some USB devices require excessive power, they may be limited by the circuit safety device.
- If playback from a USB HDD is unstable, provide additional power by plugging the HDD into a wall socket. If the problem continues, contact the USB HDD manufacturer.
- You must remove the USB storage device safely. (by performing the "**Safely Remove USB**" function to prevent possible damage to the USB memory.)  
Press the **HOME** button to move to the home screen, press the **YELLOW (C)** button, and then press the  button.
- SAMSUNG is not responsible for any data file damage or data loss.
- Your player does not support compression file, sparse file and encryption file of NTFS.
  - Before disconnecting a USB device, please use USB Safety Removal.
  - If you don't use USB Safety Removal, your data on USB device can be corrupted or lost
  - You can repair or format a USB device on your Desktop PC. (MS-Windows OS only)

## AVCHD (Advanced Video Codec High Definition)

- This player can play back AVCHD format discs. These discs are normally recorded and used in camcorders.
- The AVCHD format is a high definition digital video camera format.
- The MPEG-4 AVC/H.264 format compresses images with greater efficiency than the conventional image compressing format.
- Some AVCHD discs use the "x.v.Color" format. This player can play back AVCHD discs that use "x.v.Color" format.
- "x.v.Color" is a trademark of Sony Corporation.
- "AVCHD" and the AVCHD logo are trademarks of Matsushita Electronic Industrial Co., Ltd. and Sony Corporation.

### NOTE

- ▶ Some AVCHD format discs may not play, depending on the recording conditions. AVCHD format discs need to be finalized.
- ▶ "x.v.Color" offers a wider color range than normal DVD camcorder discs.

## Accessories

Check for the supplied accessories shown below.



Batteries for Remote Control (AAA Size)  
(BN43-00004A)

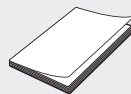

User Manual  
(AK68-02228A)

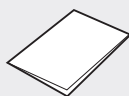

Quick Guide  
(AK68-02232C)



Remote Control  
(AK59-00145A)

# Getting Started

## Front Panel

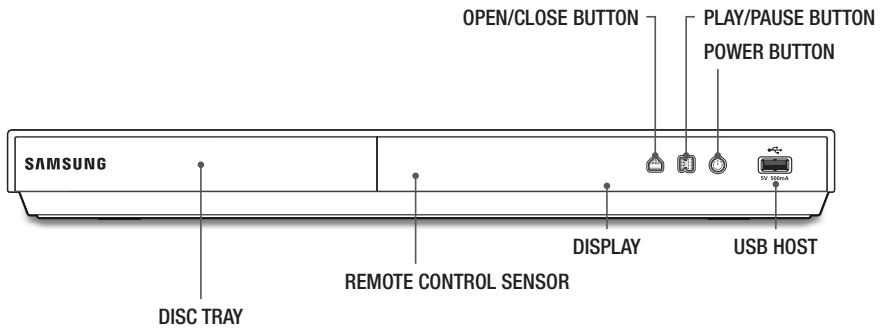

### | NOTE |

- ▶ To upgrade the player's software through the USB Host jack, you must use a USB memory stick.
- ▶ When the player displays the Blu-ray Disc menu, you cannot start the movie by pressing the Play button on the player or the remote. To play the movie, you must select Play Movie or Start in the disc menu, and then press the  button.

## Rear Panel

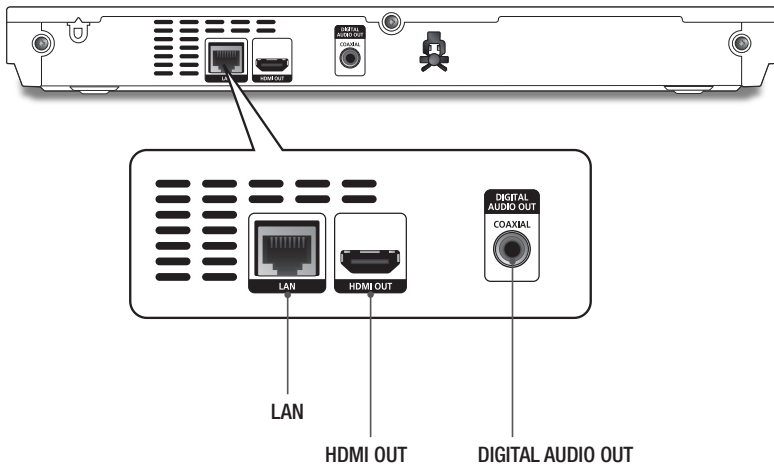

# Remote Control

## Tour of the Remote Control

After setup, allows you to set the input source on your TV. (This button is only available in Samsung TV.)

Turn the TV on and off. (This button is only available in Samsung TV.)

Turn the player on and off.

TV volume adjustment. (This button is only available in Samsung TV.)

Press to open and close the disc tray.

Press numeric buttons to operate options.

Use to enter the disc menu.

Use to enter the Popup menu/Title menu.

Press to skip backwards or forwards.

Press to search backwards or forwards.

Press to stop a disc.

Press to pause a disc.

Press to move to the home screen.

Press to use Smart Hub.

Press to use Netflix.

Use to display the playback information.

Press to use the Tools menu.

Use to select menu items and change menu values.

Return to the previous menu.

Press to exit the menu.

These buttons are used both for menus on the player and also several Blu-ray Disc functions.

Press to use Disc to Digital function.

Press to use full screen function.

Press to use Pandora.

Press to switch the Blu-ray Disc/DVD's subtitle language.

## Installing batteries

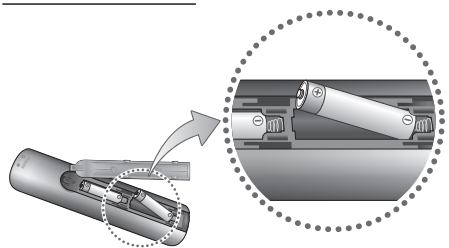

### NOTE

- ▶ If the remote does not operate properly:
  - Check the polarity +/- of the batteries.
  - Check if the batteries are drained.
  - Check if the remote sensor is blocked by obstacles.
  - Check if there is any fluorescent lighting nearby.

### CAUTION

- ▶ Dispose of batteries according to local environmental regulations. Do not put them in the household trash.

# Connections

## Connecting to a TV

Connect an HDMI cable (not supplied) from the HDMI OUT jack on the back of the product to the HDMI IN jack on your TV.

- Do not connect the power cord to the wall outlet until you have made all the other connections.
- When you change the connections, turn off all devices before you start.

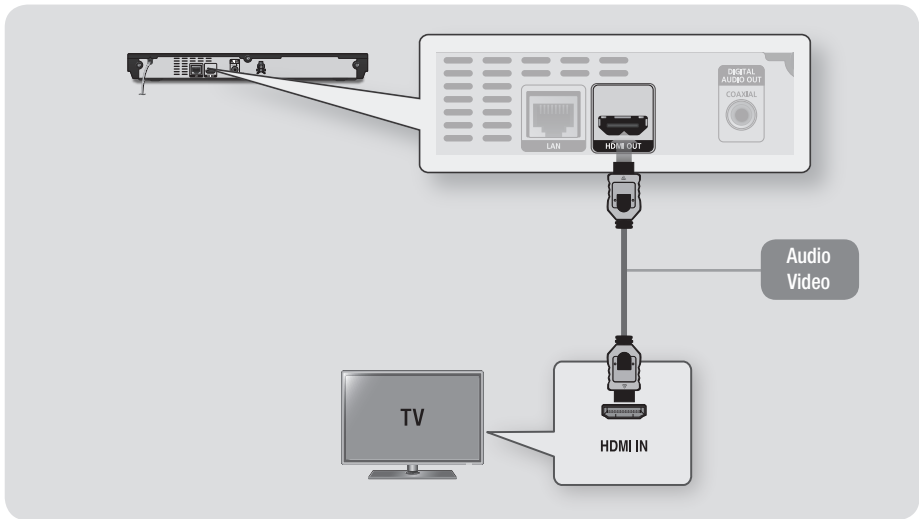

### | NOTE |

- ▶ If you use an HDMI-to-DVI cable to connect to your display device, you must also connect the Digital Audio Out on the player to an audio system to hear audio.
- ▶ An HDMI cable outputs digital video and audio, so you don't need to connect an audio cable.
- ▶ Depending on your TV, certain HDMI output resolutions may not work. Please refer to the user manual of your TV.
- ▶ When you connect the player to your TV using the HDMI cable or to a new TV, and then turn it on for the first time, the player automatically sets the HDMI output resolution to the highest supported by the TV.
- ▶ A long HDMI cable may cause screen noise. If this occurs, set HDMI Deep Color to Off in the menu.
- ▶ To view video in the HDMI 720p, 1080i, or 1080p output mode, you must use a High speed (category 2) HDMI cable.
- ▶ HDMI outputs only a pure digital signal to the TV.  
If your TV does not support HDCP (High-bandwidth Digital Content Protection), random noise appears on the screen.

## Connecting to an Audio System

You can connect the Blu-ray player to an the audio system using the method illustrated below.

- Do not connect the power cord to the wall outlet until you have made all the other connections.
- When you change the connections, turn off all devices before you start.

### Method 1 Connecting to an HDMI supported AV receiver

- Connect an HDMI cable (not supplied) from the HDMI OUT jack on the back of the product to the HDMI IN jack on your receiver.
- Best quality (Recommended)

### Method 2 Connecting to an AV receiver with Dolby Digital or DTS decoder

- Using a digital Coaxial cable (not supplied), connect the Coaxial Digital Audio Out jack on the product to the Digital Coaxial In jack of the receiver.
- Good quality
- You will hear sound only through the front two speakers with Digital Output set to PCM.

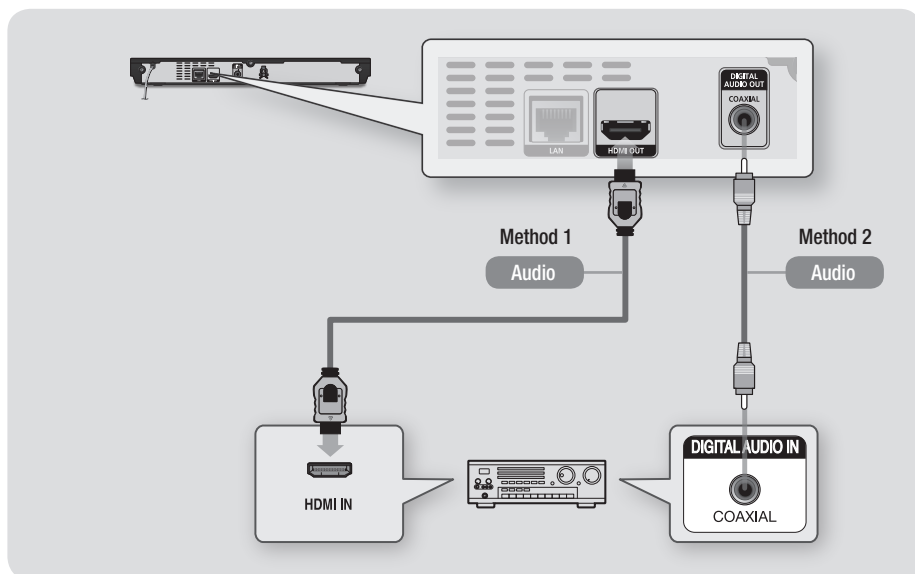

## Connecting to a Network Router

You can connect your player to your network router using one of the methods illustrated below. To use the AllShare network functionality, you must connect your PC to your network as shown in the illustrations. The connection can be wired or wireless.

### Wired Network

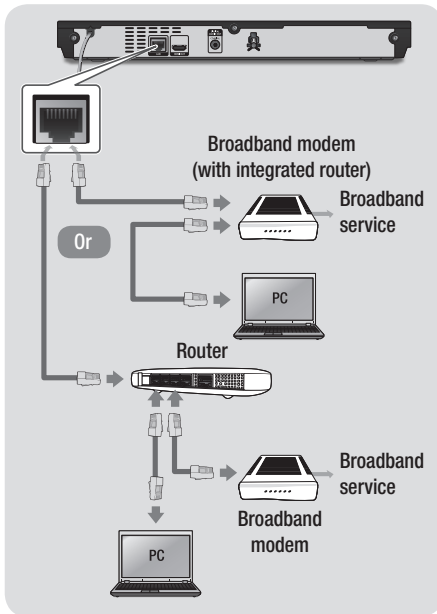

#### NOTE I

- ▶ Internet access to Samsung's software update server may not be allowed, depending on the router you use or your ISP's policy. For more information, contact your ISP (Internet Service Provider).
- ▶ DSL users, please use a router to make a network connection.

### Wireless Network

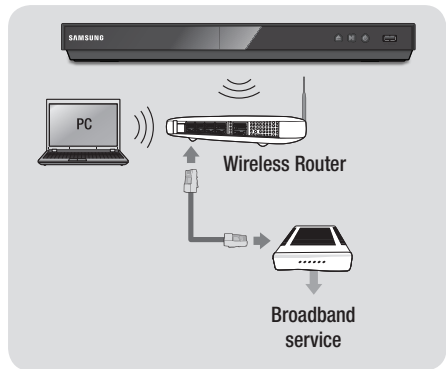

#### NOTE I

- ▶ If your wireless router supports DHCP, this player can use a DHCP or static IP address to connect to the wireless network.
- ▶ Set your wireless router to Infrastructure mode. Ad-hoc mode is not supported.
- ▶ The player supports only the following wireless security key protocols:
  - WEP (OPEN/SHARED), WPA-PSK (TKIP/AES), WPA2-PSK (TKIP/AES)
- ▶ Select a channel on the wireless router that is not currently being used. If the channel set for the wireless router is currently being used by another device nearby, it will result in interference and communication failure.
- ▶ If you select the Pure High-throughput (Greenfield) 802.11n mode and set the Encryption type on your router or router to WEP, TKIP or TKIP-AES (WPS2Mixed), the player will not support a connection in compliance with new Wi-Fi certification specifications.
- ▶ Wireless LAN, by its nature, may cause interference, depending on the operating conditions (router performance, distance, obstacles, interference by other radio devices, etc).



## The Initial Settings Procedure

- The Home screen will not appear if you do not configure the initial settings.
- The OSD (On Screen Display) may change in this player after you upgrade the software version.
- The access steps may differ depending on the menu you selected.

The Initial Settings Procedure lets you set the OSD and menu languages, configure the connection to your home network, choose the aspect ratio output (screen size and format) that is correct for your TV, and apply an upgrade to your player's software, if one is available. For complete Initial Settings instructions, see the Quick Start Guide.

### NOTE

- ▶ If you skip Network Setup during the Initial Settings procedure, you can configure your network settings later. See "Configuring Your Network Connection" on pages 24~26 for instructions.
- ▶ If you want to display the Initial Settings screen again and make changes, select Settings > System > Initial Settings in the Home screen or select the Reset option. (See pages 21 or 23)
- ▶ If you want to use an Anynet+(HDMI-CEC) function, please follow the instructions below.
  - 1) Connect the player to an Anynet+(HDMI-CEC)-compliant Samsung TV using HDMI Cable.
  - 2) Set the Anynet+(HDMI-CEC) feature to **On** in both the TV and the player.
  - 3) Set the TV to the Initial Settings Procedure.

## The Home Screen

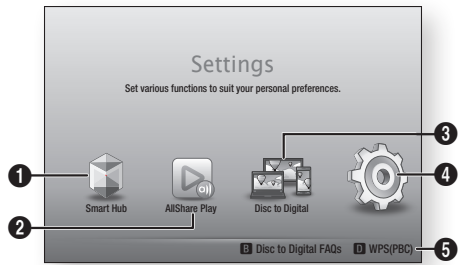

1	<b>Smart Hub</b> : Starts Smart Hub. From Smart Hub, you can access YouTube, games, and other apps.
2	<b>AllShare Play</b> : Play videos, photos or music content from Disc, USB, PC or mobile devices.
3	<b>Disc to Digital</b> : Upload DVD movies to your personal Internet Disc to Digital repository. Once movies are uploaded, they can be streamed to other devices connected to the Internet.
4	<b>Settings</b> : Set various functions to suit your personal preferences.
5	Displays the colored buttons on your remote that you can press to access or perform functions.

### ■ Selecting an Option on the Home Screen

4. To select an option on the Home screen, move the cursor using the ◀▶ buttons until it highlights the option of your choice, and then press the button.

### NOTE

- ▶ If you leave the player in the stop mode for more than 5 minutes without using it, a screen saver will appear on your TV. If the player is left in the screen saver mode for more than 20 minutes, the power will automatically turn off.

# Settings

## Accessing the Settings Screen

1. Select **Settings** on the Home screen, and then press **[Enter]** button. The Settings screen appears.

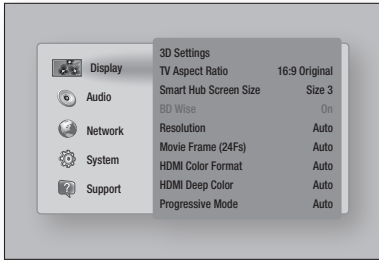

2. To access the menus, sub-menus, and options on the Settings screen, please refer to the remote control illustration below.

## Buttons on the Remote Control Used for the Settings Menu

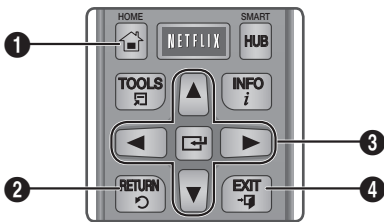

1	<b>HOME</b> Button : Press to move to the Home screen.
2	<b>RETURN</b> Button : Return to the previous menu.
3	<b>[Enter] / DIRECTION</b> Buttons : <ul style="list-style-type: none"><li>• Press <b>▲▼◀▶</b> to move the cursor or select an item.</li><li>• Press the <b>[Enter]</b> button to activate the currently selected item or confirm a setting.</li></ul>
4	<b>EXIT</b> Button : Press to exit the current menu.

## Detailed Function Information

Each Settings function, menu item, and individual option is explained in detail on-screen. To view an explanation, use the **▲▼◀▶** buttons to select the function, menu item, or option. The explanation will usually appear on the right side of the screen. A short description of each Settings function starts on the next page. Additional information on some of the functions is also in the Appendix of this manual.

## Settings Menu Functions

<b>Display</b>	<b>3D Settings</b>	Select whether to play a Blu-ray Disc with 3D contents in 3D Mode. <ul style="list-style-type: none"> <li>If you move to the Home or Smart Hub Home screen while in 3D mode, the player will switch to 2D automatically.</li> </ul>
	<b>TV Aspect Ratio</b>	Lets you adjust the output of the player to the screen size and screen format of your TV.
	<b>Smart Hub Screen Size</b>	Lets you select the optimal size for the Smart Hub Screen.
	<b>BD Wise</b>	BD Wise is Samsung's latest inter-connectivity feature. When you connect a Samsung player and a Samsung TV with BD Wise to each other via HDMI, and BD Wise is on in both the player and TV, the player outputs video at the video resolution and frame rate of the Blu-ray Disc/DVD.
	<b>Resolution</b>	Set the output resolution of the HDMI video signal to Auto, 1080p, 1080i, 720p or 480p. The number indicates the number of lines of video per frame. The i and p indicate interlaced and progressive scan, respectively. Generally, the higher quality.
	<b>Movie Frame (24Fs)</b>	If the player is connected to a 24Fs compatible TV, setting the Movie Frame (24Fs) feature to Auto lets the player adjust its HDMI output to 24 frames per second automatically for improved picture quality. <ul style="list-style-type: none"> <li>You can enjoy the Movie Frame (24Fs) feature only on a TV supporting this frame rate.</li> <li>Movie Frame is only available when the player is in the HDMI 1080i or 1080p output resolution modes.</li> </ul>
	<b>HDMI Color Format</b>	Lets you set the color space format for the HDMI output so that it matches the capabilities of the connected device (TV, monitor, etc). The screen goes black momentarily after you have selected a format.
	<b>HDMI Deep Color</b>	Lets you set the product to output HDMI video with Deep Color. Deep Color provides more accurate color reproduction with greater color depth.
	<b>Progressive Mode</b>	Lets you improve picture quality when viewing DVDs.

# Settings

<b>Audio</b>	<b>Digital Output</b>	Lets you select the digital audio output format that is suitable for your TV or AV Receiver. For more details, see the digital output selection table on page 53.
	<b>PCM Downsampling</b>	Lets you choose to have 96Khz PCM signals downsampled to 48Khz before they are outputted to an amplifier. Choose On if your amplifier or receiver is not compatible with a 96Khz signal.
	<b>Dynamic Range Control</b>	<p>Lets you apply dynamic range control to Dolby Digital, Dolby Digital Plus, and Dolby True HD audio.</p> <ul style="list-style-type: none"> <li>✓ <b>Auto</b> : Automatically controls the dynamic range of Dolby TrueHD audio, based on information in the Dolby TrueHD soundtrack. Also turns dynamic range control on for Dolby Digital and Dolby Digital Plus.</li> <li>✓ <b>Off</b> : Leaves the dynamic range uncompressed, letting you hear the original sound.</li> <li>✓ <b>On</b> : Turns dynamic range control on for all three Dolby formats. Quieter sounds are made louder and the volume of loud sounds is reduced.</li> </ul>
	<b>Downmixing Mode</b>	Lets you select the multi-channel downmix method that is compatible with your stereo system. You can choose to have the player downmix to normal stereo or to surround compatible stereo.
<b>Network</b>	<b>Network Settings</b>	Configure the network connection so you can enjoy various features such as Internet services or AllShare Wi-Fi functionality, and perform software upgrades.
	<b>Network Status</b>	Lets you check the current network and Internet status.
	<b>Wi-Fi Direct</b>	Lets you connect a Wi-Fi Direct device to the player using a peer-to-peer network, without the need for a wireless router. You can use the device to control the player. Note that if you set the Quick Start option to <b>On</b> (See page 21), that Wi-Fi devices connected to your player through Wi-Fi Direct and Soft AP (See page 21) will maintain their Wi-Fi connections even when the player is off.

<b>Network</b>	<b>Soft AP</b>	Lets you connect other types of Wi-Fi devices to the player wirelessly. Requires that you create a security key which you must enter into the other Wi-Fi devices when you are connecting them to the network.
	<b>AllShare Settings</b>	Lists network connected AllShare devices and lets you control whether each device (a smartphone, a tablet, etc.) can share content with or control the player.
	<b>Device Name</b>	Lets you input a name for the player that will identify it on your networks.
	<b>BD-Live Settings</b>	Set various BD-Live function. BD-Live allows you to access extra features available on some Blu-ray Discs if you are connected to the Internet. <ul style="list-style-type: none"> <li>✓ <b>BD-Live Internet Connection</b> : Lets you fully allow, partly allow, or prohibit a BD-Live Internet connection.</li> <li>✓ <b>BD Data Management</b> : Manage BD data downloaded from a BD-Live service or Blu-ray Disc.</li> </ul>
	<b>Disc to Digital App</b>	Lets you select your default Disc to Digital application after you have downloaded it. For more information about Disc to Digital, see pages 44~45.  <b>  NOTE  </b> <ul style="list-style-type: none"> <li>▶ Disc to Digital lets you upload DVD movies to your own personal, Internet Disc to Digital repository and then stream them in HD format to other Internet connected devices.</li> </ul>
<b>System</b>	<b>Initial Settings</b>	Lets you re-run the Initial Settings procedure. See the Quick Start Guide for details.
	<b>Quick Start</b>	Lets you set the player to turn on quickly by decreasing the boot time.  <b>  NOTE  </b> <ul style="list-style-type: none"> <li>▶ If this function set to <b>On</b>, Standby power consumption will be increased.</li> </ul>

# Settings

<b>System</b>	<b>Anynet+(HDMI-CEC)</b>	Anynet+ is a convenient function that offers linked operations with other Samsung players that have the Anynet+ feature and lets you control those products with one Samsung TV remote. To operate this function, you must connect this player to an Anynet+ Samsung TV using an HDMI cable.
	<b>Device Manager</b>	You can connect a wireless USB keyboard or mouse to the USB port on the front of the player. <b>✓ Keyboard Settings</b> : Lets you configure a wireless USB keyboard connected to the player. <b>  NOTE  </b> ▶ You can use the keyboard only when a <b>QWERTY</b> keyboard screen or window appears in the Web Browser. <b>✓ Mouse Settings</b> : Lets you configure a wireless USB mouse connected to the player. You can use the mouse in the player's menu in the same way you use a mouse on your PC. ▪ <b>To use a mouse with the player's menu:</b> <ol style="list-style-type: none"><li>1. Connect the USB mouse to the player.</li><li>2. Click the primary button you selected in Mouse Settings. The Simple Menu appears.</li><li>3. Click the menu options you want.</li></ol> <b>  NOTE  </b> ▶ For information about compatible USB HID keyboards and mouse, visit our website: <a href="http://www.samsung.com">www.samsung.com</a> . ▶ Some HID keyboard keys may not work. ▶ Wired USB keyboards are not supported. ▶ Some applications may not be supported. ▶ If a wireless HID Keyboard does not operate because of interference, move the keyboard closer to the player.
	<b>Language</b>	You can select the language you prefer for the On-screen menu, disc menu, subtitles, etc. <ul style="list-style-type: none"><li>• The language you select for the disc menu, disc audio, or subtitles will only appear if it is supported on the disc.</li></ul>

<b>System</b>	<b>Security</b>	<p>The default PIN is 0000. Enter the default PIN to access the security function if you haven't created your own PIN. After you have accessed the security function for the first time, change the PIN using the Change PIN function.</p> <ul style="list-style-type: none"> <li>✓ <b>BD Parental Rating</b> : Prevents playback of Blu-ray Discs with a rating equal to or above a specific age rating you enter unless the PIN is entered.</li> <li>✓ <b>DVD Parental Rating</b> : Prevents playback of DVDs with a rating above a specific numerical rating you select unless the PIN is entered.</li> <li>✓ <b>Change PIN</b> : Change the 4-digit PIN used to access security functions. <ul style="list-style-type: none"> <li>▪ <b>If you forget your PIN:</b> <ol style="list-style-type: none"> <li>1. Remove any disc or USB storage device.</li> <li>2. Press and hold the <b>▶  </b> button on the front panel for 5 seconds or more. All settings will revert to the factory settings.</li> </ol> </li> </ul> </li> </ul>
	<b>General</b>	<p>You can change the options listed below to match your preferences.</p> <ul style="list-style-type: none"> <li>✓ <b>Time Zone</b> : Select the time zone in which you live.</li> <li>✓ <b>Menu Transparency</b> : Adjust the transparency of the menu box.</li> </ul>
<b>Support</b>	<b>Software Upgrade</b>	For more information about the Software Upgrade function, see "Upgrading Software" on pages 28~30.
	<b>Contact Samsung</b>	Provides contact information for assistance with your player.
	<b>Remote Management</b>	<p>When activated, lets Samsung Call Center agents diagnose and fix problems with the product remotely. Requires an active Internet connection.</p> <p><b>  NOTE  </b></p> <ul style="list-style-type: none"> <li>▶ Remote Management service might not be available in some countries.</li> <li>▶ Contact your nearest service center for your PIN code and tell the code to the person in charge. It enables remote diagnosis of the product and required measures.</li> </ul>
	<b>Reset</b>	Resets all settings to their default settings except for the network and Smart Hub settings. The default security PIN is 0000.

## Networks and the Internet

When you connect this player to a network, you can use network based applications and functions such as Smart Hub and BD-LIVE, and upgrade the player's software through the network connection. For more information about accessing and using Internet services, see the Network Services chapter of this manual on pages 42~45. Instructions for configuring the network connection start below.



### Configuring Your Network Connection

Before you begin, contact your ISP to find out if your IP address is static or dynamic. If it is dynamic, and you have a wired or wireless network, we recommend using the Automatic configuration procedures described below.

If you are connecting to a wired network, connect the player to your router using a LAN cable before you start the configuration procedure.

If you are connecting to a wireless network, disconnect any wired network connection before you begin.

To begin configuring your network connection, follow these steps:

1. In the Home screen, select **Settings**, and then press the  button.
2. Select **Network**, and then press the  button.
3. Select **Network Settings**, and then press the  button.
4. Go to the instructions for Wired networks starting below or the instructions for Wireless networks starting on page 25.

### Wired Network

#### □ Wired - Automatic

After following Steps 1 to 3 above:

1. Select **Start** in the Network Settings screen, and then press the  button. The player detects the wired connection, verifies the network connection and then connects to the network.





#### □ Wired - Manual

If you have a static IP address or the Automatic procedure does not work, you'll need to set the Network Settings values manually.

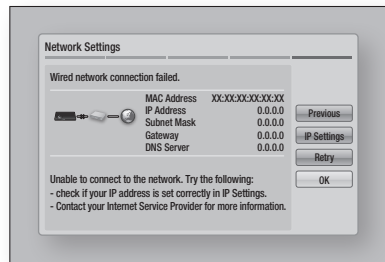
After following Steps 1 to 3 above:

1. Select **Start** in the Network Settings screen, and then press the  button. The Network Status screen appears. The player attempts to verify the network connection and fails.



2. Select **IP Settings** on the right of the screen, and press the  button. The IP Settings screen appears.
3. Select the **IP Mode** field, and then set it to Manual.
4. Use the number keypad on your remote to enter the Network values. Use the     buttons on the remote to move from entry field to entry field.

#### | NOTE |

- ▶ You can get these values from your Internet provider. You can also view these values on most Windows computers. For instructions, see "Getting the Network Settings Values." on page 25.
5. When done, highlight **OK**, and then press  button. The player verifies the network connection and then connects to the network.



## < Getting the Network Settings Values >

You can view your Network Settings values on most Windows computers. To view the Network Settings values, follow these steps:

- Windows XP
  1. Right click the Network icon on the bottom right of the Windows desktop.
  2. In the pop-up menu, click Status.
  3. On the dialog that appears, click the Support tab.
  4. On the Support tab, click the Details button. The Network settings are displayed.
- Windows 7
  1. Click the Network icon on the bottom right of the Windows desktop.
  2. In the pop-up menu, click Network and Sharing Center.
  3. On the dialog that appears, click the Local Area Connection or Wireless Network Connection depending on your network connection.
  4. On the Support tab, click the Details button. The Network settings are displayed.

### | NOTE |

- ▶ Depending on your Windows version, the information may differ.

## Wireless Network

You can setup a wireless network connection in three ways:

- Wireless Automatic
- Wireless Manual
- WPS(PBC)



When you configure the wireless network connection, any wireless network devices currently connected through the player or, if applicable, the player's current wired connection, will be disconnected.

## □ Wireless (General) - Automatic

After following Steps 1 to 3 in "Configuring Your Network Connection" on page 24.

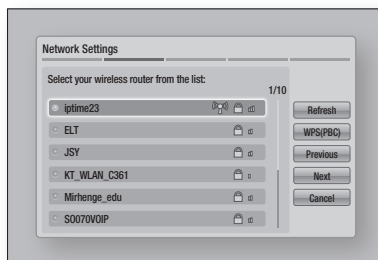
1. Select **Start** in the Network Settings screen, and then press the  button. The player searches for and then displays a list of the available networks.



2. Select the desired network, and then press the  button.
3. Select **Next**, and then press the  button again.
4. On the Security screen, enter your network's Security Code or Pass Phrase. Enter numbers directly using the number buttons on your remote control. Enter letters by selecting a letter with an arrow button, and then pressing  button.
5. When done, select **Next** at the right of the screen. The player verifies the network connection and then connects to the network.

### | NOTE |











- ▶ You should be able to find the Security Code or Pass Phrase on one of the set up screens you used to set up your router or modem.

## □ Wireless (General) - Manual

If you have a static IP address or the Automatic procedure does not work, you'll need to set the Network Settings values manually.

After following Steps 1 to 3 in "Configuring Your Network Connection" on page 24.

# Settings

1. Select **Start** in the Network Settings screen, and then press the  button. The player searches for and then displays a list of the available networks.
  2. Select the desired network, and then press the  button.
  3. Select **Next**, and then press the  button again.
  4. On the Security screen, enter your network's Security Code or Pass Phrase. Enter numbers directly using the number buttons on your remote control. Enter letters by selecting a letter with the  buttons, and then pressing the  button.
  5. When done, select **Next** at the right of the screen, and then press the  button.
  6. The Network Status screen appears. The player attempts to verify the network connection and fails.
  7. Select **IP Settings** on the right of the screen, and press the  button. The IP Settings screen appears.
  8. Select the **IP Mode** field, and then set it to Manual.
  9. Use the number keypad on your remote to enter the Network values. Use the  buttons on the remote to move from entry field to entry field.
- NOTE**
- ▶ You can get these values from your Internet provider. You can also view these values on most Windows computers. For instructions, see "Getting the Network Settings Values." on page 25.
10. When done, highlight **OK**, and then press  button. The Network Status screen appears. The product verifies the network connection and then connects to the network. When it is done, highlight **OK**, and then press  button.



## WPS(PBC)

One of the easiest ways to set up the wireless network connection is using the WPS(PBC) function. If your wireless router has a WPS(PBC) button, follow these steps:

1. Open the Home screen.
2. Press the **BLUE (D)** button on the remote control.
3. Press the **WPS(PBC)** button on your router within two minutes. Your player automatically acquires all the network settings values it needs and connects to your network. The Network Status screen appears. The player connects to the network after the network connection is verified.

## Wi-Fi Direct

The Wi-Fi Direct function allows you to connect Wi-Fi Direct devices to the player and each other using a peer-to-peer network, without a wireless router.

1. Turn on the Wi-Fi direct device and activate its Wi-Fi Direct function.
2. In the Home screen, select **Settings**, and then press the  button.
3. Select **Network**, and then press the  button.
4. Select **Wi-Fi Direct**, and then press the  button. The Wi-Fi Direct devices that you can connect appear.



- You have three ways to complete the Wi-Fi connection:



- Through the Wi-Fi device.
- Through the player using PBC.
- Through the player using a PIN.

Each is covered below.



### Through the Wi-Fi Device

- On the Wi-Fi device, follow the procedure on the device for connecting to another Wi-Fi Direct device. See the device's user manual for instructions.
- When you have completed the procedure, you should see a pop-up on your TV screen saying that a device that supports Wi-Fi Direct has requested to connect. Select **OK**, and then press the  button to accept.
- The Connecting pop-up appears, followed by the Connected pop-up. When it closes, you should see the device listed on the Wi-Fi Direct screen as connected.

### Through the Player Using PBC

- Select the Wi-Fi Direct device you want to connect to this player, and then press the  button. The PBC/PIN pop up appears.
- Select **PBC**, and then press the  button. The PBC pop-up appears.
- Press the **PBC** button on the Wi-Fi Direct device within 2 minutes.
- The Connecting pop-up appears, followed by the Connected pop-up. When it closes, you should see the device listed on the Wi-Fi Direct screen as connected.

### Through the Player Using a PIN

- Select the Wi-Fi Direct device you want to connect to this player, and then press the  button. The PBC/PIN pop up appears.
- Select **PIN**, and then press the  button. The PIN pop-up appears.
- Note the PIN code in the pop-up, and then enter it into the appropriate field in the Wi-Fi Direct device you want to connect.

- The Connecting pop-up appears, followed by the Connected pop-up. When it closes, you should see the device listed on the Wi-Fi Direct screen as connected.





#### NOTE

- The wired or wireless network connection will be disconnected when you use the Wi-Fi Direct function.











### Soft AP

Soft AP lets you connect other Wi-Fi devices to your network through the player and lets them access the Internet.

It requires that you create a security key which you must enter into the other Wi-Fi devices when you are connecting them to the network.

- In the Home screen, select **Settings**, and then press the  button.
- Select **Network**, and then press the  button.
- Select **Soft AP**, and then press the  button.
- Select **On** or **Off**, and then press the  button.

#### < To Set the Soft AP Security Key >





- On the Soft AP screen, select **Security Key**, and then press the  button. The Security Key screen appears.
- On the Security key screen, enter a security key. Enter numbers directly using the number buttons on your remote control. Enter letters by selecting a letter with the     buttons, and then pressing the  button.
- When done, use the the     buttons to move to **DONE** at the bottom of the screen, and then press the  button.

When you connect a Wi-Fi device through the connection procedure on the device, you must enter the security key you created here into the appropriate field.

# Settings

## AllShare Settings

The AllShare Settings screen lists your network connected AllShare devices and their IP addresses. Through this screen, you can allow a device to access the player, deny access, or delete the device from the AllShare list.



1. In the Home screen, select **Settings**, and then press the  button.
2. Select **Network**, and then press the  button.
3. Select **AllShare Settings**, and then press the  button.
4. Select a device, and then press the  button. The AllShare Settings pop-up appears.
5. Select **Allow**, **Deny**, or **Delete** from List, and then press the  button.

The AllShare Settings screen only displays devices if you have established networked connections to AllShare devices. For more information about AllShare networked devices, see page 31.

## Upgrading Software

The Software Upgrade menu allows you to upgrade the player's software for performance improvements or additional services.

- Never turn the player off or back on manually during the update process.

1. In the Home screen, select the **Settings**, and then press the  button.
2. Select **Support**, and then press the  button.
3. Select **Software Upgrade**, and then press the  button.

4. Select one of the following methods:
  - By Online
  - By USB
  - By Disc
  - By Downloaded
  - Standby Mode Upgrade
5. Press the  button.

### NOTE

- ▶ The upgrade is complete when the player turns off, and then turns on again by itself.
- ▶ Samsung Electronics shall takes no legal responsibility for player malfunction caused by an unstable Internet connection or consumer negligence during a software upgrade.
- ▶ If you want to cancel the upgrade while the upgrade software is downloading, press the  button.

## By Online

Your player must be connected to the Internet to use the By Online function.

1. Select **By Online**, and then press the  button. The Connecting to Server message appears.
2. If there is a download available, the Download pop-up appears with a progress bar and the download starts.
3. When the download is complete, the Upgrade Query window appears with three choices: Upgrade Now, Upgrade Later, or Don't Upgrade.
4. If you select Upgrade Now, the player upgrades the software, turns off, and then turns on automatically.
5. If you do not make a selection in one minute or select Upgrade Later, the player stores the new upgrade software. You can upgrade the software later using the By Downloaded function.
6. If you select Don't Upgrade, the player cancels the upgrade.

## By USB

---

1. Visit [www.samsung.com](http://www.samsung.com).
2. Click **SUPPORT** on the top right of the page.
3. Enter the product's model number into the search field, and then click **Find Product**.
4. Click **Get downloads** in the center of the page below the Downloads header.
5. Click **Firmware** in the center of the page.
6. Click the **ZIP** icon in the File column on the right side of the page.
7. Click **OK** in the pop-up that appears to download and save the firmware file to your PC.
8. Unzip the zip archive to your computer. You should have a single folder with the same name as the zip file.
9. Copy the folder to a USB flash drive.
10. Make sure no disc is inserted in the player, and then insert the USB flash drive into the USB port of the player.
11. In the player's menu, go to Settings > Support > Software Upgrade.
12. Select **By USB**.

### | NOTE |

- ▶ There should be no disc in the player when you upgrade the software using the USB Host jack.
- ▶ When the software upgrade is done, check the software details in the software Upgrade menu.
- ▶ Do not turn off the player during the software upgrade. It may cause the player to malfunction.
- ▶ Software upgrades using the USB Host jack must be performed with a USB flash memory stick only.

## By Disc

---

1. Follow Steps 1 through 7 in **By USB**.
2. Unzip the zip archive to your computer. You should have a single folder with the same name as the zip file.
3. Write the folder onto a disc. We recommend a CD-R or DVD-R.
4. Finalize the disc before you remove it from your computer.
5. Insert the disc into the player.
6. In the player's menu, go to Settings > Support > Software upgrade.
7. Select **By Disc**.

### | NOTE |

- ▶ When the system upgrade is done, check the software details in the software Upgrade menu.
- ▶ Do not turn off the player during the Software Upgrade. It may cause the player malfunction.

## By Downloaded

---

The By Downloaded option lets you upgrade using a file the player downloaded earlier but you decided not to install immediately or a file downloaded by the player in Standby Mode.

1. If upgrade software has been downloaded, you will see the software version number to the right of By Downloaded.
2. Select **By Downloaded**, and then press the  button.
3. The player displays a message asking if you want to upgrade. Select **Yes**. The player begins the upgrade.
4. When the update is complete, the player turns off automatically, and then turns on.

### | NOTE |

- ▶ When the system upgrade is done, check the software details in the software Upgrade menu.
- ▶ Do not turn off the player during the software Upgrade. It may cause the player to malfunction.

# Settings

## Standby Mode Upgrade

---

You can set the Standby Mode Upgrade function so that the player downloads new upgrade software when it is in Standby mode.

In Standby mode, the player is off, but its Internet connection is active. This allows the player to download upgrade software automatically, when you are not using it.

1. Press the ▲▼ buttons to select **Standby Mode Upgrade**, and then press the  button.
2. Select **On** or **Off**.  
If you select **On**, the player will automatically download new upgrade software when it is in Standby mode with the power off. If it downloads new upgrade software, the player will ask you if you want to install it when you turn the player on.

### | NOTE |

- ▶ To use Standby Mode Upgrade function, your player must be connected to the Internet.



# Media Play

Your Blu-ray Disc Player can play content located on Blu-ray/DVD/CD discs, USB devices, PCs, and DLNA compatible cell phones. To play content located on your PC or on a DLNA compatible cell phone, you must connect your PC and the player to your network and download and install the AllShare network software on your PC.

## Playing Commercial Video Discs

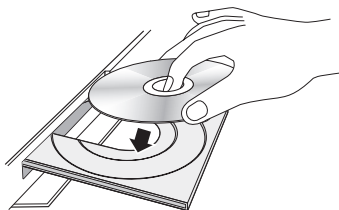
1. Press the  button to open the disc tray.
2. Push a disc gently into the disc tray with the disc's label facing up.



3. Press the  button to close the disc tray. Playback starts automatically.
4. If playback does not start automatically, press the  button on the remote or see "The AllShare Play Screen" below.

## The AllShare Play Screen

For all media, except for commercial video discs, the AllShare Play Main Screen or one of its subscreens is your primary means of accessing and selecting content to view or play. For example, if you connect a USB device to the player, the player will display the content located on the USB device on the AllShare Play USB screen.

### NOTE

- ▶ You can use the AllShare Play Screen to access a commercial video disc. For example, when you stop a movie, but leave the disc in the player, you can start it again using the AllShare Play Screen. However, unlike other media, when you insert a commercial video disc, it bypasses the AllShare Play Screen and starts playing automatically.

## Accessing the AllShare Play Screen

To access the AllShare Play Main screen, select AllShare Play on the Home screen, and then press the  button.

## The AllShare Play Screen at a Glance



1	<b>My List</b> : Lists recently played or viewed files. If the device or media containing files listed in My List is inserted into or connected to the player, you can use My List to play or view those files.
2	<b>Contents Type</b> : Lets you select the type of content to view or play: Videos, Photos, or Music.
3	<b>Device Type</b> : Lets you select the device or media where the content is located.
4	Displays the colored buttons on your remote that you can press to access or perform functions.

### NOTE

- ▶ If the player is not connected to the network, My List is not displayed.
- ▶ The AllShare Play screen will only display files of the Content Type you selected. For example, if you select Music, you will only be able to see music files. If you open folders labeled Photos or Videos, no files will be displayed. To view other types of files, select a different Content Type.

## Playing Files on a USB Device or USB Compatible Mobile Phone

There are two methods you can use to play or view multimedia files located on a USB device or USB compatible mobile phone through your player.

# Media Play

## Method 1

1. Turn the player on.
2. Connect the USB device or mobile phone to the USB port on the front panel of the player. The New Device Connected pop-up appears.



### NOTE

- ▶ If the pop-up does not appear, go to Method 2.
3. Use the ▲▼ buttons to select Videos, Photos, or Music, and then press the button. The AllShare Play screen appears listing the content of the device or phone. Depending on how the contents is arranged, you will see either folders, individual files, or both.
  4. Select a file to view or play, and then press the button.
  5. Press the **RETURN** button to exit a folder or to return to the Home screen.

## Method 2

1. Turn the player on.
2. Connect the USB device or mobile phone to the USB port on the front panel of the player.
3. Select **AllShare Play** on the Home screen, and then press the button.
4. On the left side, select Videos, Photos, or Music, and then press the button.
5. On the right side, select **USB Flash Memory**, and then press the button. The AllShare Play screen appears listing the contents of the device or phone. Depending on how the contents are arranged, you will see either folders, individual files, or both.

6. If necessary, use the the ▲▼◀▶ buttons to select a folder, and then press the button.
7. Use the ▲▼◀▶ buttons to select a file to view or play, and then press the button.
8. Press the **RETURN** button to exit a folder or to return to Home screen.

### NOTE

- ▶ To remove the USB storage device, you must use the "**Safely Remove USB**" function to prevent possible damage to the USB memory. Press the **HOME** button to move to the Home screen, press the **YELLOW (C)** button, and then press the button.
- ▶ If you insert a disc when playing a USB device or phone, the device mode changes to "Disc" automatically.
- ▶ If your mobile phone is DLNA compatible, you can play contents without connecting a USB cable. See "Using the AllShare Network Function" on pages 33~34.





## Playing Commercial Audio Discs

1. Place a pre-recorded, commercial audio disc into the disc tray with the disc's label facing up, and then close the tray. The AllShare Music screen appears listing the tracks. Playback of the first track starts automatically.
2. To play a particular track, use the ▲▼ buttons on the remote to select the track, and then press the button.

## Music Screen Controls





	Pause a track.
	Play a track.
	Repeat one track or all tracks.
	Play tracks in random order.

To access the controls, play a track, and then use the ◀▶ buttons to move to the control of your choice.

#### NOTE



- ▶ The Music Screen controls are only accessible when a track is playing.
- ▶ All controls do not appear at the same time.
- ▶ For more information about playing music, go to Controlling Music Playback on pages 37~38.



## Playing a Disc with User Recorded Content

You can play multimedia files you have recorded on DVD or CD discs.

1. Place a user recorded disc into the disc tray with the disc's label facing up, and then close the tray. The Device Connected pop-up appears.
2. Use the ▲▼ buttons to select the type of content you want to view or play - Videos, Photos, or Music - and then press the  button.

#### NOTE

- ▶ Even though the player will display folders for all content types, it will only display files of the Content Type you selected in Step 2. For example, if you selected music, you will only be able to see music files. You can change this selection on the AllShare Play main screen.
3. Use the ◀▶ buttons to select the folder containing the content type you chose in Step 2, and then press the  button.
  4. If you selected Music, the Allshare Music screen appears listing the music files on the disc. Use the ▲▼ buttons to select the file you want to play, and then press the  button.

5. If you selected Photos, the AllShare Photos screen appears listing the photos on the disc. Use the ▲▼◀▶ buttons to select the photo you want to view, and then press the  button.
6. If you selected Videos, the AllShare Videos screen appears listing the video files on the disc. Use the ▲▼◀▶ buttons to select the video you want to watch, and then press the  button.

#### NOTE

- ▶ For all folders, - Music, Photo, and Video - you can also push the **TOOLS** button on your remote, and then select Play Folder to play or view all the files in the folder automatically. Select the folder first before pushing the **TOOLS** button.

## Using the AllShare Network Function

AllShare lets you play Videos, Photos, or Music located on your PC or your DLNA compatible device through the player using a wireless network connection.

### To Download the AllShare Software

To use AllShare with your PC or DLNA device, you must install AllShare software on your PC. You can download the PC software and get detailed instructions for using AllShare from the Samsung.com website.

1. Go to [www.samsung.com](http://www.samsung.com).
2. Click Support at the top of the page.
3. On the Support page, enter the model number of your player into the Model Number field, and then press the  button.
4. On the page that appears, click Get downloads on the left side under Downloads. The Download Center appears.
5. On the Download Center page, click the Software tab.
6. On the software tab, click the File icon on the right side of the AllShare line.



# Media Play

7. In the pop-up that appears, click Save File.
8. Find the AllShare install file on your disk, and then double click the file.
9. In the pop-up that appears, click Run, and then follow the directions that appear on your screen.

Download the AllShare Installation/Instruction manual from the same Software Tab by clicking the corresponding PDF file symbol in the File column on the right. The file, in PDF format, will download and open. You can view and/or save the file.

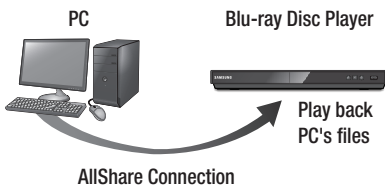
## Playing Content Located on Your PC or DLNA Device through the Blu-ray Disc Player



1. Connect the Blu-ray Disc Player, your PC, and/or your DLNA compatible cell phone to the same wireless network.
2. Follow the directions in the AllShare software Installation/Instruction manual to set up devices and files for playing or viewing.
3. Select **AllShare Play** in the player's Home screen, and then press the  button. The AllShare Play screen appears.
4. Select the connected DLNA compatible device or your PC, and then press the  button. A screen listing the available files appears.
5. Select the file you want to play or view, and then press the  button.

## Controlling the Playback of Content Located on Your PC with Your Smart Phone

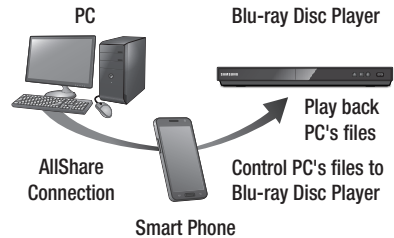

(Only available with Samsung phones supporting AllShare functionality.)

1. Connect the Blu-ray Disc Player, your PC, and your DLNA compatible cell phone to the same wireless network.
2. Follow the directions in the AllShare software Installation/Instruction manual to set up devices and files for playing or viewing.
3. On your computer, using the AllShare software, confirm your phone is connected.
4. On the phone, select the file you want to view or play, and then select the Blu-ray player as the playback device.
5. On the phone, start playback.

## Controlling Video Playback

You can control the playback of video content located on a DVD, USB, mobile device or PC. Depending on the disc or contents, some of the functions described in this manual may not be available.

### Buttons on the Remote Control used for Video Playback

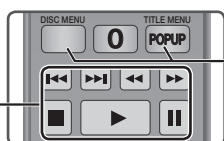

#### ■ Playback related buttons

The player does not play sound in Search, Slow or Step mode.

- To return to normal speed playback, press the button.

button	Starts playback.
button	Stops playback.
button	Pauses playback.
<b>Fast Motion Play</b>	During playback, press the  or  button. Each time you press the  or  button, the playback speed will change.
<b>Slow Motion Play</b>	In pause mode, press the  button. Each time you press the  button, the playback speed will change.
<b>Step Motion Play</b>	In pause mode, press the  button. Each time you press the  button, a new frame appears.
<b>Skip Motion Play</b>	During playback, press the  or  button. Each time you press  or  button, the disc moves to the previous or next chapter or file.

#### ■ Using the disc menu, title menu, popup menu, and title list

<b>DISC MENU button</b>	During playback, press this button to display the Disc menu.
<b>TITLE MENU button</b>	During playback, press this button to display the Title menu. <ul style="list-style-type: none"> <li>• If your disc has a playlist, press the <b>GREEN (B)</b> button to go to the playlist.</li> </ul>
<b>POPUP MENU button</b>	During playback, press this button to display the Popup menu.

### Using the Tools Menu

During playback, press the **TOOLS** button.

<b>Play from the Beginning</b>	Select to return to the beginning of the movie, and then press the  button.
<b>Title Search</b>	If there is more than one movie on the disc or device, select to start a different title. <ol style="list-style-type: none"> <li>1. Select Title Search, and then press the  button.</li> <li>2. Use the   buttons to select a title, and then press the  button.</li> </ol>
<b>Chapter Search</b>	Select to play the chapter of your choice. <ol style="list-style-type: none"> <li>1. Select Chapter Search, and then press the  button.</li> <li>2. Use the   buttons to select a chapter, and then press the  button.</li> </ol>

<b>Time Search</b>	<p>Select to play the movie from a selected time point.</p> <ol style="list-style-type: none"> <li>1. Select Time Search, and then press the <b>⏮</b> button.</li> <li>2. Using the number buttons, enter the time point you want to go to, and then press the <b>⏮</b> button.</li> </ol> <p><b>NOTE</b></p> <ul style="list-style-type: none"> <li>▶ You can also use the <b>◀▶</b> buttons to advance or rewind the movie. The movie advances or rewinds one minute each time you press the <b>◀▶</b> buttons.</li> </ul>
<b>Repeat Mode</b>	<p>Select to repeat a title, chapter, or specific section.</p> <ul style="list-style-type: none"> <li>- <b>Off</b> : Select to return to normal playback.</li> <li>- <b>Title</b> : Choose to repeat a selected title.</li> <li>- <b>Chapter</b> : Choose to repeat a specific chapter.</li> <li>- <b>Repeat A-B</b> : Choose to repeat a specific section.</li> </ul> <ol style="list-style-type: none"> <li>1. Press the <b>▲▼</b> buttons to select repeat A-B, and then press the <b>⏮</b> button.</li> <li>2. Press the <b>⏮</b> button at the point where you want repeat play to start (A). Let the movie play.</li> <li>3. Press the <b>⏮</b> button at the point where you want repeat play to stop (B).</li> </ol> <p><b>NOTE</b></p> <ul style="list-style-type: none"> <li>▶ You must set point (B) at least 5 seconds of playing time after point (A).</li> </ul>
<b>Full Screen</b>	<p>Select to change the full screen size.</p>

<b>Picture Mode</b>	<p>Select to set the picture mode.</p> <ul style="list-style-type: none"> <li>- <b>Dynamic</b> : Increases sharpness and brightness.</li> <li>- <b>Standard</b> : Choose this setting for most viewing applications.</li> <li>- <b>Movie</b> : The best setting for watching movies.</li> <li>- <b>User</b> : Lets you adjust the sharpness and noise reduction function respectively.</li> </ul> <p><b>NOTE</b></p> <ul style="list-style-type: none"> <li>▶ When you use the BD wise function, this menu will not appear.</li> </ul>
<b>Audio</b>	<p>Select to set the desired audio language.</p>
<b>Subtitle</b>	<p>Select to set the desired subtitle language.</p> <ul style="list-style-type: none"> <li>- You can also operate this function by pressing the <b>SUBTITLE</b> button on the remote control.</li> </ul>
<b>Angle</b>	<p>Select to view a scene from another angle. The Angle option displays the number of angles available to view. When a Blu-ray Disc/DVD contains multiple angles of a particular scene, you can change angle.</p>
<b>BONUSVIEW Video</b>	<p>Select to set the desired bonusview option.</p>
<b>BONUSVIEW Audio</b>	<p>Select to set the desired bonusview option.</p>
<b>Go to Videos List</b>	<p>Select to go to the list of videos on the current media.</p>
<b>Information</b>	<p>Select to view video file information.</p>

**NOTE**

- ▶ Depending on the disc or storage device, the Tools menu may differ. See pages 39~41 for additional options.
- ▶ Video files with high bitrates of 20Mbps or more strain the player's capabilities and may stop playing during playback.

## Controlling Music Playback

You can control the playback of music content located on a DVD, USB, mobile device or PC.

### Buttons on the Remote Control used for Music Playback

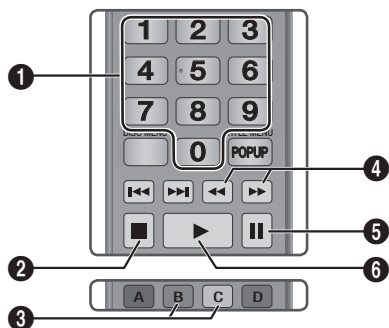

1	<b>NUMBER</b> buttons : Press the number of a track. The selected track is played.
2	<b>■</b> button : Stops a track.
3	<b>Skip</b> : During playback, press the <b>GREEN (B)</b> or <b>YELLOW (C)</b> button to move to the previous or next page of the playlist.
4	<b>Fast Play (Audio CD (CD-DA) only)</b> During playback, press the <b>◀▶</b> or <b>▶▶</b> button. Each time you press the <b>◀▶</b> or <b>▶▶</b> button, the playback speed will change.
5	<b>⏸</b> : Pauses a track.
6	<b>▶</b> button : Plays the currently selected track.

### Using the Tools Menu

During playback, press the **TOOLS** button.

<b>View</b>	See pages 39–41.
<b>Folder view</b>	See pages 39–41.
<b>Title</b>	See pages 39–41.
<b>Artist</b>	See pages 39–41.
<b>Album</b>	See pages 39–41.



<b>Genre</b>	See pages 39–41.
<b>Selection Play</b>	See pages 39–41.
<b>Go to Playlist</b>	See pages 39–41.
<b>Rip</b>	The Ripping function converts CD audio to the mp3 format and saves the converted files on a USB device connected to the player. See Ripping on page 38.
<b>Information</b>	Select to see the (Contents) information: File size, date created, etc.

#### NOTE I

- ▶ Depending on the disc or storage device, the Tools menu may differ. See pages 39–41 for additional options.

### Repeating Tracks on an Audio CD



You can set the product to repeat tracks on an audio CD (CD-DA/MP3).

1. During playback, use the **▶** button to select  in the lower right corner of the screen, and then press the  button.
2. Use the **▲▼** to select the repeat mode you want - Off, One Song, or All - and then press the  button.







### Shuffling Tracks on an Audio CD



You can set the product to play tracks on an audio CD (CD-DA/MP3) at random.

1. During playback, use the **▶** button to select  in the lower right corner of the screen, and then press the  button.
2. Use the **▲▼** to set the Shuffle mode **On** or **Off**, and then press the  button.







## Creating a Playlist from a CD

1. With the Playback screen displayed, press the **TOOLS** button. The Tools menu appears.
2. Use the ▲▼ buttons to select **Selection Play**, and then press the  button. The Selection Play screen appears.
3. Use the ▲▼ buttons to select a track, and then press the  button. A check appears to the left of the track.
4. Repeat Step 3 to select and check additional tracks.
5. To remove a track from the list, move to the track, and then press the  button again. The check on the track is removed.
6. When done, press the ► button to select **Play**, and then press the  button. The Music Playback screen reappears listing only the tracks you checked. The selected tracks play automatically.

### | NOTE |

- ▶ You can create a playlist with up to 99 tracks on Audio CDs (CD-DA).
- ▶ If you have created a playlist, Selection Play is replaced by Edit Playlist on the Tools menu.
- ▶ On the Selection Play screen, you can also choose Select All, Deselect All, and Cancel.
  - Use Select All to select all tracks. This cancels your individual track selections. When you press the **RETURN** button on your remote or select ► button, and then press the  button, all tracks will appear on the Music Playback screen, and the product will begin to play all tracks from Track 001.
  - Use Deselect All to deselect all selected tracks at once. Then, select individual tracks or use Select All to select all the tracks, and then press the **RETURN** button on your remote or select ► button, and then press the  button. If you do not use Select All or select individual tracks, the Playlist will not change.
  - Cancel cancels any changes you made on the Play Select screen. When you return to the Playback screen, the Playlist will be unchanged.

## Ripping

1. Insert a USB device into the USB jack on the front of the product.
2. With the Playback screen displayed, press the **TOOLS** button. The Tools menu appears.
3. Use the ▲▼ buttons to select Rip, and then press the  button. The **Rip** screen appears.
4. Use the ▲▼ buttons to select a track, and then press the  button. A check appears to the left of the track.
5. Repeat Step 3 to select and check additional tracks.
6. To remove a track from the list, move to the track, and then press the  button again. The check on the track is removed.
7. When done, press the ► button to select Rip, and then press the  button. The Rip pop-up appears.
8. Press the  button to begin the ripping process. The Ripping Completion Bar popup appears.
9. When ripping is complete, the "Ripping is completed" message appears. Press the  button.
10. Press the **RETURN** button to go back to the Playback screen.

## Playing Photo Contents

You can play photo contents located on a DVD, USB, mobile device or PC.

### Using the Tools Menu

During playback, press the **TOOLS** button.

<b>Go to Photos List</b>	Select to go to the list of photos on the current media.
<b>Start Slide Show</b>	Select to start the slide show.
<b>Slide Show Speed</b>	Select to set a slide show's speed.
<b>Slide Show Effect</b>	Select to set a slide show's special effects.
<b>Background Music On</b>	Select to listen to music while viewing a slide show.
<b>Background Music Setting</b>	Select to set the background music setting.
<b>Picture Mode</b>	<p>Select to set the picture settings.</p> <ul style="list-style-type: none"> <li>- <b>Dynamic</b> : Choose to increase Sharpness.</li> <li>- <b>Standard</b> : Choose for most viewing applications.</li> <li>- <b>Movie</b> : This is the best setting for watching movies.</li> <li>- <b>User</b> : Lets you adjust the sharpness and noise reduction function respectively.</li> </ul> <p><b>I NOTE I</b></p> <ul style="list-style-type: none"> <li>▶ When you use the BD wise function, this menu will not appear.</li> </ul>
<b>Zoom</b>	Select to enlarge the current picture. (Enlarge up to 4 times)
<b>Rotate</b>	Select to rotate the picture. (This will rotate the picture either clockwise or counter clockwise.)
<b>Selection Play</b>	See pages 39~40.
<b>Login/Out</b>	See pages 39~40.
<b>Information</b>	Shows the picture information.

### I NOTE I





- ▶ Depending on the disc or storage device, the Tools menu may differ. All options may not be displayed.
- ▶ To enable the background music function, the photo file must be in the same storage media as the music file. However, the sound quality can be affected by the bitrate of the MP3 file, the size of the photo, and the encoding method.
- ▶ You can't enlarge the subtitle and PG graphic in the full screen mode.







## Using the Tools Menu when a file is highlighted

When a file is highlighted, press the **TOOLS** button.







<b>View</b>	Select to access the sort options: Artist, Genre, Monthly, Latest Date, etc. The sort options that appear depend on the storage and media type.
<b>Folder view</b>	Appears in the View function screen. Select to display the folders on the storage device.
<b>Title</b>	Appears on the View function screen. Select to sort all photo or video files on a storage device by title.
<b>Artist</b>	Appears on the View function screen. Select Artist to sort and then display all music tracks on a storage device by artist.
<b>Album</b>	Appears on the View function screen. Select Album to sort and then display all music tracks on a storage device by album.
<b>Genre</b>	Appears on the View function screen. Select Genre to sort and then display all music tracks on a storage device by genre.
<b>Latest Date</b>	Appears on the View function screen. Select to sort and then display all photo or video files on a storage device from the latest to earliest date.

# Media Play

<b>Earliest Date</b>	Appears on the View function screen. Select to sort and then display all photo or video files on a storage device from the earliest to latest date.
<b>Monthly</b>	Appears on the View function screen. Select to sort all photo or video files on a storage device by the month created.
<b>Selection play</b>	<p>Selection Play lets you select specific music, video, and photo files to play. It works essentially the same for all media. The example below is for photos.</p> <ol style="list-style-type: none"> <li>1. On the selection screen, use the ▲▼◀▶ buttons to select a photo you want to view, and then press the  button. A check mark appears to the left of the picture.</li> <li>2. Repeat Step 1 for each photo you want to view.</li> <li>3. To de-select a photo, highlight it, and then press the  button.</li> <li>4. When done, use the ◀▶ buttons to select <b>Play</b>, and then press the  button. A slide show containing the photos you selected begins.</li> <li>5. To pause the slide show, press the  button once. To restart the slide show, press the  button again.</li> <li>6. To stop the slide show, press the <b>RETURN</b> button.</li> </ol> <p><b>  NOTE  </b></p> <ul style="list-style-type: none"> <li>▶ After the slide show begins, you can control the slide show by pressing the <b>TOOLS</b> button and displaying the Slide Show menu. See "Using the Tools Menu" page 39.</li> </ul>

<b>Send</b>	<p>Select Send to upload selected files to Picasa, Facebook, Cloud Storage, N Drive, or Family Story.</p> <p>To use Send, you need to establish an account with the on-line site, and then log in using the Log In function.</p> <ol style="list-style-type: none"> <li>1. Use the ▲▼◀▶ buttons to select a file, and then press the  button.</li> <li>2. Repeat for each track or file you want to upload.</li> </ol> <p><b>  NOTE  </b></p> <ul style="list-style-type: none"> <li>▶ You can also move to <b>Select All</b> on the right, and then press the  button to select all tracks or files.</li> </ul> <ol style="list-style-type: none"> <li>3. Select <b>Send</b> on the right side, and then press the  button.</li> <li>4. Use the ▲▼ buttons to select the on line site you want to upload the files or tracks to, and then press the  button.</li> </ol>
<b>Login / Out</b>	The Log In/Out function lets you log in to your online Samsung account.
<b>Add to Playlist</b>	<p>Select to create a playlist or add files or tracks to a playlist.</p> <ol style="list-style-type: none"> <li>1. Use the ▲▼◀▶ buttons to highlight a track or file, and then press the  button.</li> <li>2. Repeat for each track or file you want to add.</li> <li>3. Select <b>Add to Playlist</b> on the right, and then press the  button.</li> <li>4. On the screen that appears, perform one of the following actions:</li> </ol>



<b>Add to Playlist (continued)</b>	<ul style="list-style-type: none"> <li>• Select the Playlist to which you want to add the tracks or files and then press  button.</li> <li>• Select <b>Create New</b>, and then press the  button. On the keyboard pop-up that appears, create a name for the new playlist. Enter numbers using the numbers on the remote. Enter letters by using the ▲▼◀▶ buttons to move the cursor, and then pressing the  button. When finished, move to <b>DONE</b> at the bottom of the screen, and then press the  button.</li> </ul>
<b>Delete (Playlist)</b>	Depending on the screen you are viewing, select Delete to erase a file from erasable media (such as a USB device) or to delete a playlist.
<b>Edit Playlist</b>	<p>Select Edit Playlist to remove files or tracks from an existing playlist. The storage device containing the playlist must be inserted into or attached to the player.</p> <ol style="list-style-type: none"> <li>1. Use the ▲▼◀▶ buttons to select a file, and then press the  button.</li> <li>2. Repeat for each track or file you want to remove.</li> </ol> <p><b>NOTE</b></p> <ul style="list-style-type: none"> <li>▶ You can also move to Select All on the right, and then press the  button to select all tracks or files.</li> </ul> <ol style="list-style-type: none"> <li>3. Select <b>Remove</b> on the right side, and then press the  button.</li> </ol>
<b>Play Current Group</b>	After you have sorted by Artist, Genre, Album, Title, Latest Date, Earliest Date, or Monthly, select a group that is the result of the sort (for example, all pictures taken in August), and then select Play Current Group to play or view the files in that group only.

<b>Go to Playlist</b>	Select to go to the Playlist section of the Main AllShare screen.
<b>Encoding</b>	Encoding - which changes by language or by geographical area - modifies how the player sorts, arranges, and presents files or tracks, displays dates, etc. Select Encoding to change the encoding to match your language or geographical area.
<b>Information</b>	Displays media file and content information.

**NOTE**

- ▶ Depending on the disc or storage device, the Tools menu may differ. All options may not be displayed.

# Network Services

You can enjoy various network services such as Smart Hub or BD-LIVE by connecting the player to your network.

To use network services, you must first:

1. Connect the player to the network. (See page 16)
2. Configure the network settings. (See pages 24~26)

## Using Smart Hub

Using Smart Hub, you can download movies, videos, and music from the Internet, and access various for pay or free-of-charge applications and view them on your TV. Application content includes news, sports, weather forecasts, stock market quotes, maps, photos, and games.

For instructions that explain how to use Smart Hub, follow these steps:

1. Go to [www.samsung.com](http://www.samsung.com).
2. Click Support at the top of the page.
3. On the Support page, enter the model number of your player into the Model Number field, and then press the **Enter** button.
4. On the page that appears, click Get downloads on the left side under Downloads. The Download Center appears.
5. On the Download Center page, click the Manuals tab.
6. On the Manuals tab, click the file icon to the right of Smart Hub Users Manual. The manual downloads.

### NOTE

- ▶ The web location of the Smart Hub manual is subject to change without notice.
- ▶ If the home page is updated or revised, the content mentioned in the user manual may differ from the actual menus.

## Smart Hub at a Glance

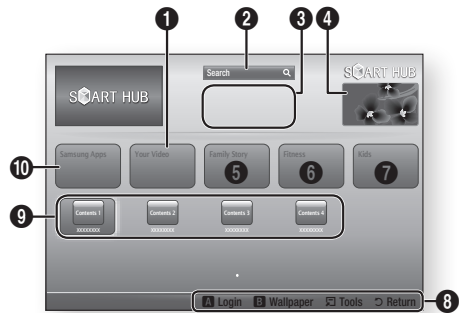

1	<b>Your Video</b> : Provides recommendations for videos based on your tastes.
2	<b>Search</b> : Provides an integrated search of your video providers and connected AllShare devices.
3	<b>Recommended</b> : Displays recommended contents managed by Samsung.
4	<b>Commercial</b> : Displays the Smart Hub Guide, an introduction to the player, and new application introductions.
5	<b>Family Story</b> : Effortless way to access family content. <ul style="list-style-type: none"> <li>• Provides access to family photos, messages, and events, anytime and anywhere.</li> </ul>
6	<b>Fitness</b> : Gateway to the Unified Self-Care Service. <ul style="list-style-type: none"> <li>• Presents fitness videos from various content partners with feedback on calories burned after every workout.</li> </ul>
7	<b>Kids</b> : Kids service gives kids an easy and safe way to enjoy their favorite content. <ul style="list-style-type: none"> <li>• Provides a wide variety of fun and safe content for children.</li> </ul>
8	<b>Navigation Help</b> : Displays the remote control buttons you can use to navigate in Smart Hub. <ul style="list-style-type: none"> <li>• <b>RED (A)</b> : To log in to Smart Hub.</li> <li>• <b>GREEN (B)</b> : To display the background screen.</li> <li>• <b>Tools</b> : To display the settings window.</li> <li>• <b>Return</b> : To return to the previous menu.</li> </ul>

9

**My Applications** : Displays your personal gallery of applications which you can add to, modify, and delete.

10

**Samsung Apps** : Open Samsung Apps to download various for pay or free-of-charge application services.

## Using the Web Browser

You can access the internet using the Web Browser application which is installed in the Smart Hub screen by default.

1. Select **Smart Hub** on the Home screen, and then press the  button.
2. Select the Web Browser application in Smart Hub, and then press the  button.













### NOTE

- ▶ When you run the Web Browser with the player connected by HDMI to a BD Wise compatible TV - and BD Wise is on - the browser is maximized to fill the screen and the TV's resolution is set to the optimal resolution automatically.
- ▶ The Web Browser is not compatible with Java applications.
- ▶ If you attempt to download a file, and the file can not be saved, an error message will appear.
- ▶ The playback of Flash videos is not supported.
- ▶ E-commerce, for purchasing products online, is not supported.
- ▶ ActiveX is not supported.

## Web Browser at a Glance



**Control Panel** : Displays the various Web Browser functions.

-  : Moves to the previous page.
-  : Moves to the last page before going back.
-  : Reloads the current page so that it is refreshed on the screen.
-  : Moves to the Home screen of the Web Browser.
-  : Allows you to zoom in or out of the screen at various percentages.
-  : Allows you to bookmark specific pages so that you can move to them easily.
-  : Allows you to view the history of your visited pages by date, name, or frequency.
-   : Allows you to enter a page address manually or select a page from the visited page list to move to that page.
-  : Allows you to switch easily between multiple, currently open Web Browser windows.
-  : Allows you to search for information by entering words.
-  : Lets you share the current site with your family group by sending a message.
-  : Allows you to configure all settings for using the Web Browser.

# Network Services







**Navigation Help** : Displays the remote control buttons you can use to navigate in Web Browser.

2

- **GREEN (B)** : To display the Control Panel.
- **YELLOW (C)** : To switch the pointer.
- **◀▶** : Scroll Up/Scroll Down the page.
- **Tools** : To display Tools window.
- **Return** : To return to the previous menu.

## BD-LIVE™

Once the player is connected to your network, you can enjoy various movie-related service contents available on BD-LIVE compliant discs.

1. Attach a USB memory stick to the USB jack on the front of the player, and then check its remaining memory. The memory device must have at least 1GB of free space to accommodate the BD-LIVE services.
2. Select **Settings** on the Home screen, and then press the  button.
3. Select **Network**, and then press the  button.
4. Select **BD Live Settings**, and then press the  button.
5. Select **BD Data management**, and then press the  button.
6. Select **Select Device**, and then press the  button.
7. Select **USB**, and then press the  button.
8. Insert a Blu-ray Disc that supports BD-LIVE.
9. Select an item from the list of BD-LIVE service contents provided by the disc manufacturer.



### NOTE

- ▶ The way you use BD-LIVE and the provided contents may differ, depending on the disc manufacturer.

## Using Disc to Digital

Disc to Digital lets you upload DVD movies to your own personal, Internet Disc to Digital repository and then stream them in HD format to other Internet connected devices including smart phones, tablet PCs, and Smart TVs.

To use Disc to Digital, you must first download the Disc to Digital application. To download the application, follow these steps.

1. Make sure the player is connected to the network. (see page 20.)
2. On the Home screen, select **SMART HUB**, and then press the  button.
3. Select **Samsung Apps**, and then press the  button.
4. In Samsung Apps, select and then download one of the Disc to Digital applications. There can be up to three.
5. Press the **HOME** button on the remote control to come back to the Home screen.
6. Select Settings > Network > Disc to Digital App, and then select an application to be the default application for Disc to Digital. (See page 21)

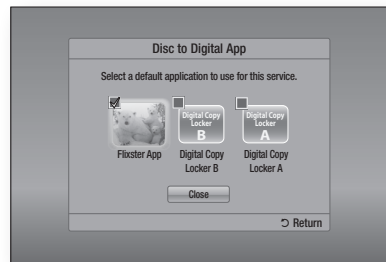

7. Go to [www.flixster.com](http://www.flixster.com) (or the home site for Disc to Digital application you downloaded) and create an account.

## Registering a DVD Movie in Disc to Digital

Before you can stream a DVD movie to other Internet connected devices, you must register the movie using your Disc to Digital software and purchase the right to stream it to other devices.

1. Insert the DVD movie you want to register with Disc to Digital.
2. On the Home screen, select **Disc to Digital**, and then press the  button.
3. Disc to Digital verifies the disc. Once the DVD's information is verified, the default application for Disc to Digital opens (in this example, Flixster).



### NOTE

- ▶ If you don't have a Flixster account, visit "www.flixster.com" to create your account.
4. In the Flixster application, find your movie and then click the Purchase button. The Activation Code appears.

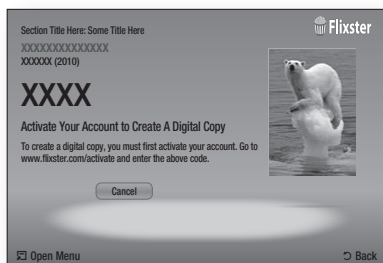

5. Record the activation code. You now have the right to stream your movie in HD quality resolution to most other Internet connected devices.

## Playing a Registered Disc to Digital Movie

1. On a PC or other Internet connected device, access the Flixster website, and then access your Flixster account. Enter your account PIN number as necessary.
2. Find your movie, and then enter the Activation Code.
3. If you see a play icon, click the play icon. The movie plays.

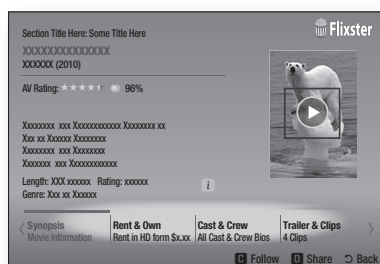

### NOTE

- ▶ You can also start the Disc to Digital function by pressing the **Disc2Digital** button on the remote control.
- ▶ If you've downloaded one or more Disc to Digital applications, you must set one of them as the default application. See "Disc to Digital App" on page 21.
- ▶ Disc to Digital only works with commercial DVD-VIDEOS. Blu-ray Discs, Audio-CD, and Data discs are not supported.
- ▶ Some commercial discs purchased outside of your region or that do not meet required specifications may not be supported by this function.

## Compliance and Compatibility Notice

NOT ALL discs are compatible

- Subject to the restrictions described below and those noted throughout this Manual, including the Disc Type and Characteristics section of this user manual, disc types that can be played are: pre-recorded commercial BD-ROM, DVD-VIDEO, and Audio CD (CD-DA); BD-RE/-R, DVD-RW/-R; and CD-RW/-R.
- Discs other than the above cannot and/or is not intended to be played by this player. And some of the above discs may not play due to one or more reasons provided below.
- Samsung cannot assure that this player will play every disc bearing the BD-ROM, BD-RE/-R, DVD-VIDEO, DVD-RW/-R, DVD+RW/+R and CD-RW/-R logos, and this player may not respond to all operating commands or operate all features of every disc. These and other disc compatibility and player operation issues with new and existing format discs are possible because:
  - Blu-ray is a new and evolving format and this player may not operate all features of Blu-ray Discs because some features may be optional, additional features may have been added to the Blu-ray Disc format after the production of this player, and certain available features may be subject to delayed availability;
  - not all new and existing disc format versions are supported by this player;
  - new and existing disc formats may be revised, changed, updated, improved and/or supplemented;
  - some discs are produced in a manner that allows specific or limited operation and feature during playback;
  - some features may be optional, additional features may have been added after the production of this player or certain available features may be subject to delayed availability;
  - some discs bearing the BD-ROM, BD-RE/-R, DVD-VIDEO, DVD-RW/-R, DVD+RW/+R and CD-RW/-R logos may still be non-standardized discs;
  - some discs may not be played depending on their physical state or recording conditions;
  - problems and errors can occur during the creation of Blu-ray Disc, DVD software and/or the manufacture of discs;
  - this player operates differently than a standard DVD player or other AV equipment; and/or
  - for reasons noted throughout this user manual and for other reason(s) discovered and posted by SAMSUNG customer care center.
- If you encounter disc compatibility or player operation problems, please contact SAMSUNG customer care center.  
You may also contact SAMSUNG customer care center for possible updates on this player.
- For additional information on playback restrictions and disc compatibility, refer to the Precautions, Before Reading the user manual, Disc Types and Characteristics, and Before Playing sections of this user manual.
- **For Blu-ray Disc Player progressive scan output** : CONSUMERS SHOULD NOTE THAT NOT ALL HIGH DEFINITION TELEVISION SETS ARE FULLY COMPATIBLE WITH THIS PRODUCT AND MAY CAUSE ARTIFACTS TO BE DISPLAYED IN THE PICTURE. IN CASE OF PROGRESSIVE SCAN PICTURE PROBLEMS, IT IS RECOMMENDED THAT THE USER SWITCH THE CONNECTION TO THE 'STANDARD DEFINITION' OUTPUT. IF THERE ARE QUESTIONS REGARDING OUR TV SET COMPATIBILITY WITH THIS PRODUCT, PLEASE CONTACT OUR CUSTOMER SERVICE CENTER.

## Copy Protection

- Because AACS (Advanced Access Content System) is approved as content protection system for Blu-ray Disc format, similar to use of CSS (Content Scramble System) for DVD format, certain restrictions are imposed on playback, analog signal output, etc., of AACS protected contents. The operation of this product and restrictions on this product may vary depending on your time of purchase as those restrictions may be adopted and/or changed by AACS after the production of this product. Furthermore, BD-ROM Mark and BD+ are additionally used as content protection system for Blu-ray Disc format, which imposes certain restrictions including playback restrictions for BD-ROM Mark and/or BD+ protected contents. To obtain additional information on AACS, BD-ROM Mark, BD+, or this product, please contact SAMSUNG customer care center.
- Many Blu-ray Disc/DVDs are encoded with copy protection. Because of this, you should only connect your Player directly to your TV, not to a VCR. Connecting to a VCR results in a distorted picture from copy-protected Blu-ray Disc/DVDs.
- Under the U.S. Copyright laws and Copyright laws of other countries, unauthorized recording, use, display, distribution, or revision of television programs, videotapes, Blu-ray Discs, DVDs, and other materials may subject you to civil and/or criminal liability.
- **Cinavia Notice** : This product uses Cinavia technology to limit the use of unauthorized copies of some commercially-produced film and videos and their soundtracks. When a prohibited use of an unauthorized copy is detected, a message will be displayed and playback or copying will be interrupted.

More information about Cinavia technology is provided at the Cinavia Online Consumer Information Center at <http://www.cinavia.com>. To request additional information about Cinavia by mail, send a postcard with your mailing address to: Cinavia Consumer Information Center, P.O. Box 86851, San Diego, CA, 92138, USA.

This product incorporates proprietary technology under license from Verance Corporation and is protected by U.S. Patent 7,369,677 and other U.S. and worldwide patents issued and pending as well as copyright and trade secret protection for certain aspects of such technology. Cinavia is a trademark of Verance Corporation. Copyright 2004-2010 Verance Corporation. All rights reserved by Verance. Reverse engineering or disassembly is prohibited.

## Network Service Disclaimer

All content and services accessible through this device belong to third parties and are protected by copyright, patent, trademark and/or other intellectual property laws. Such content and services are provided solely for your personal noncommercial use. You may not use any content or services in a manner that has not been authorized by the content owner or service provider. Without limiting the foregoing, unless expressly authorized by the applicable content owner or service provider, you may not modify, copy, republish, upload, post, transmit, translate, sell, create derivative works, exploit, or distribute in any manner or medium any content or services displayed through this device.

# Appendix

THIRD PARTY CONTENT AND SERVICES ARE PROVIDED "AS IS." SAMSUNG DOES NOT WARRANT CONTENT OR SERVICES SO PROVIDED, EITHER EXPRESSLY OR IMPLIEDLY, FOR ANY PURPOSE. SAMSUNG EXPRESSLY DISCLAIMS ANY IMPLIED WARRANTIES, INCLUDING BUT NOT LIMITED TO, WARRANTIES OF MERCHANTABILITY OR FITNESS FOR A PARTICULAR PURPOSE. SAMSUNG DOES NOT GUARANTEE THE ACCURACY, VALIDITY, TIMELINESS, LEGALITY, OR COMPLETENESS OF ANY CONTENT OR SERVICE MADE AVAILABLE THROUGH THIS DEVICE AND UNDER NO CIRCUMSTANCES, INCLUDING NEGLIGENCE, SHALL SAMSUNG BE LIABLE, WHETHER IN CONTRACT OR TORT, FOR ANY DIRECT, INDIRECT, INCIDENTAL, SPECIAL OR CONSEQUENTIAL DAMAGES, ATTORNEY FEES, EXPENSES, OR ANY OTHER DAMAGES ARISING OUT OF, OR IN CONNECTION WITH, ANY INFORMATION CONTAINED IN, OR AS A RESULT OF THE USE OF ANY CONTENT OR SERVICE BY YOU OR ANY THIRD PARTY, EVEN IF ADVISED OF THE POSSIBILITY OF SUCH DAMAGES.

Third party services may be terminated or interrupted at any time, and Samsung makes no representation or warranty that any content or service will remain available for any period of time. Content and services are transmitted by third parties by means of networks and transmission facilities over which Samsung has no control. Without limiting the generality of this disclaimer, Samsung expressly disclaims any responsibility or liability for any interruption or suspension of any content or service made available through this device.

Samsung is neither responsible nor liable for customer service related to the content and services. Any question or request for service relating to the content or services should be made directly to the respective content and service providers.

## License

- Dolby and the double-D symbol are registered trademarks of Dolby Laboratories.



- Manufactured under license under U.S. Patent Nos: 5,956,674; 5,974,380; 6,487,535 & other U.S. and worldwide patents issued & pending. DTS, the Symbol, & DTS and the Symbol together are registered trademarks & DTS 2.0+Digital Out is a trademark of DTS, Inc. Product includes software. © DTS, Inc. All Rights Reserved.



- HDMI, the HDMI Logo, and High-Definition Multimedia Interface are trademarks or registered trademarks of HDMI Licensing LLC in the United States and other countries.



- Oracle and Java are registered trademarks of Oracle and/or its affiliates. Other names may be trademarks of their respective owners.



- Open Source License Notice
  - In the case of using open source software, Open Source Licenses are available on the product menu.
- Blu-ray Disc™, Blu-ray™ and the logos are trademarks of the Blu-ray Disc Association.



- Rovi Flow-Down Licence Terms (Terms of Use)
  - This application incorporates software and technology of Rovi Corporation ("Rovi"). The Rovi software and technology (collectively, the "Rovi Technology") allows End Users to access music-related data ("Rovi Data") over the Internet and otherwise from proprietary Rovi databases (the "Rovi Databases") located on Rovi servers (the "Rovi Servers") and to perform other functions. You may access and use Rovi Data only by means of the intended End User functions of this application software.
  - You agree that you will use the Rovi Data, the Rovi Technology, and the Rovi Servers for your own personal non-commercial use only. You agree not to assign, copy, transfer or transmit the Rovi Data to any third party. You agree not to use or exploit Rovi Data, the Rovi Technology, the Rovi Databases, or the Rovi Servers, except as expressly permitted herein.
  - You agree that your non-exclusive licence to access the Rovi Databases and to use the Rovi Data, the Rovi Technology, and the Rovi Servers will terminate if you violate these restrictions. If your licence terminates, you agree to cease any and all use of the Rovi Data, the Rovi Technology, and the Rovi Servers. Rovi reserves all rights in Rovi Data, the Rovi Technology, and Rovi Servers, including all ownership rights. You agree that Rovi may enforce its rights under this Agreement against you directly in its own name.
  - Rovi reserves the right to delete data from the Rovi Databases or to change data categories for any cause that Rovi deems sufficient. No warranty is made that the Rovi Technology or Rovi Servers are error-free or that functioning of Rovi Technology or Rovi Servers will be uninterrupted. Rovi is not obligated to provide you with any new enhanced or additional data types or categories that Rovi may choose to provide in the future and is free to discontinue its online services at any time.
  - The data you submit to use will not be personal data or personally identifiable data, but rather only data respecting music albums and associated data that does not appear in the Rovi Lookup Database. You certify that to the best of its knowledge the album to which the submitted data corresponds is commercially available and that you End User are lawfully permitted to submit the data.
  - To the extent that you, the End User, provide any information or original works of authorship to be added to Rovi Databases, you represent and warrant that you are the sole author of such work(s) and further hereby assign to Rovi all rights of copyright therein, including the right to register the copyright in such work(s) as part of the Rovi Database.
  - THE ROVITECHNOLOGY AND EACH ITEM OF ROVI DATA ARE LICENSED TO YOU "AS IS." ROVI MAKES NO REPRESENTATIONS OR WARRANTIES, EXPRESS OR IMPLIED, REGARDING THE ACCURACY OF ANY ROVI DATA ON THE ROVI SERVERS. ROVI DISCLAIMS ALL WARRANTIES EXPRESS OR IMPLIED, INCLUDING, BUT NOT LIMITED TO, IMPLIED WARRANTIES OF MERCHANTABILITY, FITNESS FOR A PARTICULAR PURPOSE, TITLE AND NON-INFRINGEMENT. ROVI DOES NOT WARRANT THE RESULTS THAT WILL BE OBTAINED BY YOUR USE OF THE ROVI TECHNOLOGY OR ANY ROVI SERVER. IN NO CASE WILL ROVI BE LIABLE TO YOU OR ANY THIRD PARTY FOR ANY CONSEQUENTIAL OR INCIDENTAL DAMAGES OR FOR ANY LOST PROFITS OR LOST REVENUES RESULTING FROM YOUR USE OF ROVI DATA, THE ROVI TECHNOLOGY OR OTHERWISE.

## Additional Information

### Note

<b>Settings</b>	<b>3D Settings</b>
	<ul style="list-style-type: none"> <li>• For some 3D discs, to stop a movie during 3D playback, press the <b>■</b> button once. The movie stops and the 3D mode option is de-activated. To change a 3D option selection when you are playing a 3D movie, press the <b>■</b> button once. The Blu-ray menu appears. Press the <b>■</b> button again, then select 3D Settings in the Blu-ray menu.</li> <li>• Depending on the content and the position of the picture on your TV screen, you may see vertical black bars on the left side, right side, or both sides.</li> </ul>
	<b>TV Aspect Ratio</b>
	<ul style="list-style-type: none"> <li>• Depending on the disc type, some aspect ratios may not be available.</li> <li>• If you select an aspect ratio and option that is different than the aspect ratio of your TV screen, the picture might appear to be distorted.</li> <li>• If you select the 16:9 Original, your TV may display 4:3 Pillarbox (black bars on sides of picture).</li> </ul>
	<b>BD Wise (Samsung Players only)</b>
	<ul style="list-style-type: none"> <li>• When BD Wise is on, the Resolution setting automatically defaults to BD Wise and BD Wise appears in the Resolution menu.</li> <li>• If the player is connected to a device that does not support BD Wise, you can not use the BD Wise function.</li> <li>• For proper operation of BD Wise, set the BD Wise option of both the player and the TV to On.</li> </ul>
	<b>Digital Output</b>
<ul style="list-style-type: none"> <li>• Be sure to select the correct Digital Output or you will hear no sound or just loud noise.</li> <li>• If the HDMI device (AV receiver, TV) is not compatible with compressed formats (Dolby digital, DTS), the audio signal outputs as PCM.</li> <li>• Regular DVDs do not have BONUSVIEW audio and Navigation Sound Effects.</li> <li>• Some Blu-ray Discs do not have BONUSVIEW audio and Navigation Sound Effects.</li> <li>• This Digital Output setup does not affect the HDMI audio output to your TV. It affects the coaxial and HDMI audio output when your player is connected to an AV receiver.</li> <li>• If you play MPEG audio soundtracks, the audio signal outputs as PCM regardless of your Digital Output selections (PCM or Bitstream).</li> </ul>	
<b>PCM Downsampling</b>	
<ul style="list-style-type: none"> <li>• Even when PCM Downsampling is set to Off, some discs will only output downsampled audio through the coaxial digital outputs.</li> <li>• HDMI             <ul style="list-style-type: none"> <li>- If your TV is not compatible with compressed multi-channel formats (Dolby Digital, DTS), the player may output PCM 2ch downmixed audio even though you selected Bitstream (either Reencoded or Unprocessed) in the setup menu.</li> <li>- If your TV is not compatible with PCM sampling rates over 48kHz, the player may output 48kHz.</li> </ul> </li> </ul>	

Settings	<b>BD-LIVE Internet Connection</b>
	<ul style="list-style-type: none"> <li>• What is a valid certificate? When the player uses BD-LIVE to send the disc data and a request to the server to certify the disc, the server uses the transmitted data to check if the disc is valid and sends the certificate back to the player.</li> <li>• The Internet connection may be restricted while you are using BD-LIVE contents.</li> </ul>
	<b>BD Data Management</b>
	<ul style="list-style-type: none"> <li>• In the external memory mode, disc playback may be stopped if you disconnect the USB device in the middle of playback.</li> <li>• Only those USB devices formatted in the FAT file system (DOS 8.3 volume label) are supported. We recommend you use USB devices that support USB 2.0 protocol with 4 MB/sec or faster read/write speed.</li> <li>• The Resume Play function may not work after you format the storage device.</li> <li>• The total memory available to BD Data Management may differ, depending on conditions.</li> </ul>
Media Play	<b>Anynet+(HDMI-CEC)</b>
	<ul style="list-style-type: none"> <li>• Depending on your TV, certain HDMI output resolutions may not work. Please refer to the user manual of your TV.</li> <li>• This function is not available if the HDMI cable does not support CEC.</li> <li>• If your Samsung TV has an Anynet+ logo, then it supports the Anynet+ function.</li> </ul>
	<b>Selecting the Audio Language</b>
Media Play	<ul style="list-style-type: none"> <li>• The ◀▶ indicator will not appear on the screen if the BONUSVIEW section does not contain any BONUSVIEW audio settings.</li> <li>• The languages available through the Audio Language function depend on the languages that are encoded on the disc. This function or certain languages may not be available.</li> <li>• Some Blu-ray Discs may allow you to select either the PCM or Dolby digital audio soundtrack in English.</li> </ul>
	<b>Selecting the Subtitle Language</b>
	<ul style="list-style-type: none"> <li>• Depending on the Blu-ray Disc / DVD, you may be able to change the subtitle language in the Disc Menu. Press the <b>DISC MENU</b> button.</li> <li>• This function depends on the selection of subtitles that are encoded on the disc and may not be available on all Blu-ray Discs/DVDs.</li> <li>• Information about the main feature BONUSVIEW mode will also appear if the Blu-ray Disc has a BONUSVIEW section.</li> <li>• This function changes both the primary and secondary subtitles at the same time.</li> <li>• The total number of primary and secondary subtitles are displayed respectively.</li> <li>• If you press the <b>SUBTITLE</b> button on the remote control, the subtitle bar appears. Press the <b>RETURN</b> button to remove the subtitle bar.</li> </ul>

## Resolution according to the contents type

Setup \ Contents Type	Blu-ray Disc	E-contents/ Digital contents	DVD
BD Wise	Resolution of Blu-ray Disc	1080@60F	480i
Auto	Max. Resolution of TV input	Max. Resolution of TV input	Max. Resolution of TV input
1080p@60F (Movie Frame : Off)	1080@60F	1080@60F	1080@60F
Movie Frame : Auto (24Fs)	1080@24F	1080@24F	-
1080i	1080i	1080i	1080i
720p	720p	720p	720p
480p	480p	480p	480p

### NOTE

- ▶ If the TV you connected to the player does not support Movie Frame or the resolution you selected, the message "*If no pictures are shown after selecting 'Yes', please wait for 15 seconds to return to the previous resolution. Do you want to change the resolution?*" appears. If you select **Yes**, the TV's screen will go blank for 15 seconds, and then the resolution will revert to the previous resolution automatically.
- ▶ If the screen stays blank after you have changed the resolution, remove all discs, and then press and hold the **▶||** button on the front of the player for more than 5 seconds. All settings are restored to the factory default. Run the Initial Settings procedure again. Then, go to Settings > Display > Resolution in the Menu, and select the correct resolution for your TV.
- ▶ When you run the Initial Settings procedure, re-select the language and aspect ratio (screen size and format) only. Resetting does not affect your network settings, so you should be able to skip Network Setup and Software Upgrade.
- ▶ When the factory default settings are restored, all stored user BD data will be deleted.
- ▶ The Blu-ray Disc must have the 24 frame feature for the player to use the Movie Frame (24Fs) mode.

## Digital Output Selection

Setup		PCM		Bitstream (Unprocessed)		Bitstream (Re-encoded DTS)	Bitstream (Re-encoded Dolby D)
		HDMI Receiver	Coaxial	HDMI Receiver	Coaxial	HDMI Receiver or Coaxial	HDMI supported AV receiver or Coaxial
Audio Stream on Blu-ray Disc	PCM	Up to 7.1ch	PCM 2ch	PCM	PCM 2ch	Re-encoded DTS	Re-encoded Dolby Digital *
	Dolby Digital	PCM 2ch	PCM 2ch	Dolby Digital	Dolby Digital	Re-encoded DTS	Re-encoded Dolby Digital *
	Dolby Digital Plus	PCM 2ch	PCM 2ch	Dolby Digital Plus	Dolby Digital	Re-encoded DTS	Re-encoded Dolby Digital *
	Dolby TrueHD	PCM 2ch	PCM 2ch	Dolby TrueHD	Dolby Digital	Re-encoded DTS	Re-encoded Dolby Digital *
	DTS	PCM 2ch	PCM 2ch	DTS	DTS	Re-encoded DTS	Re-encoded Dolby Digital *
	DTS-HD High Resolution Audio	PCM 2ch	PCM 2ch	DTS-HD High Resolution Audio	DTS	Re-encoded DTS	Re-encoded Dolby Digital *
	DTS-HD Master Audio	PCM 2ch	PCM 2ch	DTS-HD Master Audio	DTS	Re-encoded DTS	Re-encoded Dolby Digital *
Audio Stream on DVD	PCM	PCM 2ch	PCM 2ch	PCM 2ch	PCM 2ch	PCM 2ch	PCM 2ch
	Dolby Digital	PCM 2ch	PCM 2ch	Dolby Digital	Dolby Digital	Dolby Digital	Dolby Digital
	DTS	PCM 2ch	PCM 2ch	DTS	DTS	DTS	DTS
Definition for Blu-ray Disc	Any	Decodes main feature audio and BONUSVIEW audio stream together into PCM audio and add Navigation Sound Effects.		Outputs only main feature audio stream so that your AV receiver can decode the audio bitstream. You will not hear BONUSVIEW audio and Navigation Sound Effects.		Decodes main feature audio and BONUSVIEW audio stream together into PCM audio and add Navigation Sound Effects, then re-encodes the PCM audio into DTS bitstream	Decodes main feature audio and BONUSVIEW audio stream together into PCM audio and add Navigation Sound Effects, then re-encodes the PCM audio into Dolby digital bitstream

\* If Source Stream is 2ch, "Re-encoded Dolby D" Settings are not applied.

Blu-ray Discs may include three audio streams :

- Main Feature Audio : The audio soundtrack of the main feature.
- BONUSVIEW audio : An additional soundtrack such as the director or actor's commentary.
- Navigation Sound Effects : When you choose some menu navigation, Navigation Sound Effects may sound. Navigation Sound Effects are different on each Blu-ray Disc.

## Troubleshooting

Before requesting service, please try the following solutions.

PROBLEM	SOLUTION
No operation can be performed with the remote control.	<ul style="list-style-type: none"> <li>• Check the batteries in the remote control. They may need replacing.</li> <li>• Operate the remote control at a distance of no more than 20 feet from the player.</li> <li>• Remove the batteries and hold down one or more buttons for several minutes to drain the microprocessor inside the remote control to reset it. Reinstall the batteries and try to operate the remote control again.</li> </ul>
The disc does not play.	<ul style="list-style-type: none"> <li>• Ensure that the disc is installed with the label side facing up.</li> <li>• Check the region number of the Blu-ray Disc/DVD.</li> </ul>
The disc Menu does not appear.	<ul style="list-style-type: none"> <li>• Ensure that the disc has disc menus.</li> </ul>
The prohibition message appears on the screen.	<ul style="list-style-type: none"> <li>• This message appears when an invalid button is pressed.</li> <li>• The Blu-ray Disc/DVD's software doesn't support the feature (e.g., angles).</li> <li>• You've requested a title or chapter number or search time that is out of range.</li> </ul>
Play mode differs from the Setup Menu selection.	<ul style="list-style-type: none"> <li>• Some of the functions selected in the Setup Menu may not work properly if the disc is not encoded with the corresponding function.</li> </ul>
The screen ratio cannot be changed.	<ul style="list-style-type: none"> <li>• The Screen Ratio is fixed on your Blu-ray Disc/DVD.</li> <li>• This is not a problem with the player.</li> </ul>
No audio.	<ul style="list-style-type: none"> <li>• Make sure you have selected the correct Digital Output in the Audio Options Menu.</li> </ul>
The screen is blank.	<ul style="list-style-type: none"> <li>• If the HDMI output is set to a resolution your TV cannot support (for example, 1080p), you may not see a picture on your TV.</li> <li>• Press the ►   button (on front panel) for more than 5 seconds with no disc inside. All settings will revert to the factory settings.</li> <li>• When the factory default settings are restored, all stored user BD data will be deleted.</li> </ul>
Forgot password	<ul style="list-style-type: none"> <li>• Press the ►   button (on front panel) for more than 5 seconds with no disc inside. All settings including the password will revert to the factory settings. Don't use this unless absolutely necessary.</li> <li>• When the factory default settings are restored, all stored user BD data will be deleted.</li> </ul>

PROBLEM	SOLUTION
If you experience other problems.	<ul style="list-style-type: none"> <li>Go to the contents and find the section of the user manual that contains the explanations regarding the current problem, and follow the procedure once again.</li> <li>If the problem still cannot be solved, please contact your nearest Samsung authorized service center.</li> </ul>
The picture is noisy or distorted	<ul style="list-style-type: none"> <li>Make sure that the disc is not dirty or scratched.</li> <li>Clean the disc.</li> </ul>
No HDMI output.	<ul style="list-style-type: none"> <li>Check the connection between the TV and the HDMI jack of the player.</li> <li>Check if your TV supports 480p, 720p, 1080i or 1080p HDMI input resolution.</li> </ul>
Abnormal HDMI output screen.	<ul style="list-style-type: none"> <li>If random noise appears on the screen, it means that TV does not support HDCP (High-bandwidth Digital Content Protection).</li> </ul>
AllShare function	
I can see folders shared through AllShare, but I cannot see the files.	<ul style="list-style-type: none"> <li>AllShare only shows Video, Photo, and Music files. Other types of files are not displayed.</li> </ul>
The video plays intermittently.	<ul style="list-style-type: none"> <li>Check if the network is stable.</li> <li>Check if the network cable is properly connected and if the network is not overloaded.</li> <li>The wireless connection between the DLNA compatible device and the player is unstable. Check the connection.</li> </ul>
The AllShare connection between the player and the PC is unstable.	<ul style="list-style-type: none"> <li>IP addresses within the same subnetwork should be unique. If they are not, IP interference can cause this phenomenon.</li> <li>Check if you have a firewall enabled. If so, disable the firewall function.</li> </ul>

PROBLEM	SOLUTION
<b>BD-LIVE</b>	
I cannot connect to the BD-LIVE server.	<ul style="list-style-type: none"> <li>• Test whether the network connection is successful using the Network Status function. (See page 20)</li> <li>• Check whether a USB memory device is connected to the player.</li> <li>• The memory device must have at least 1GB of free space to accommodate the BD-LIVE service. You can check the available size in BD Data Management. (See page 21)</li> <li>• See if the BD-LIVE Internet Connection option is set to Allow(All).</li> <li>• If all above fails, contact the contents provider or update to the player to the latest firmware.</li> </ul>
When using the BD-LIVE service, an error occurs.	<ul style="list-style-type: none"> <li>• The memory device must have at least 1GB of free space to accommodate the BD-LIVE service. You can check the available size in BD Data Management. (See page 21)</li> </ul>

#### | NOTE |

- ▶ When the factory default settings are restored, all stored user BD data will be deleted.

## Repairs

If you contact us to repair your player, an administration fee may be charged if either:

1. An engineer is called out to your home at your request and there is no defect in the product.
2. You bring the unit to a repair center and there is no defect in the product.

We will provide you with the amount of the administration fee before we make a home visit or begin any work on your player.

We recommend you read this manually thoroughly, search for a solution on line at [www.samsung.com](http://www.samsung.com), or contact Samsung Customer Care at 1-800-SAMSUNG (726-7864) before seeking to repair your player.



## Specifications

General	Power Requirements	AC 120V, 60Hz
	Power Consumption	17W
	Weight	2.7 lbs
	Dimensions	14.2 (W) X 7.7 (D) X 1.5 (H) inches
	Operating Temperature Range	+41°F to +95°F
	Operating Humidity Range	10 % to 75 %
USB	Type A	USB 2.0
	DC output	5V 500mA Max.
HDMI	Video	2D : 1080p, 1080i, 720p, 480p 3D : 1080p, 720p
	Audio	PCM, Bitstream
Audio Output	Digital Audio Output	Coaxial
Network	Ethernet	100BASE - TX Terminal
	Wireless LAN	Built-in
	Security	WEP (OPEN/SHARED) WPA-PSK (TKIP/AES) WPA2-PSK (TKIP/AES)
	WPS(PBC)	Supported

- Network speeds equal to or below 10Mbps are not supported.
- Design and specifications are subject to change without prior notice.
- Weight and dimensions are approximate.
- Dispose unwanted electronics through an approved recycler.  
To find the nearest recycling location, go to our website: [www.samsung.com/recyclingdirect](http://www.samsung.com/recyclingdirect) or call, (877) 278 - 0799.

## LIMITED WARRANTY TO ORIGINAL PURCHASER

This SAMSUNG brand product, as supplied and distributed by SAMSUNG and delivered new, in the original carton to the original consumer purchaser, is warranted by SAMSUNG against manufacturing defects in materials and workmanship for a limited warranty period of:

**One (1) Year Parts and Labor\***  
**(\*90 Days Parts and Labor for Commercial Use)**

This limited warranty begins on the original date of purchase, and is valid only on products purchased and used in the United States. To receive warranty service, the purchaser must contact SAMSUNG for problem determination and service procedures. Warranty service can only be performed by a SAMSUNG authorized service center. The original dated bill of sale must be presented upon request as proof of purchase to SAMSUNG or SAMSUNG's authorized service center. Transportation of the product to and from the service center is the responsibility of the purchaser.

SAMSUNG will repair or replace this product, at our option and at no charge as stipulated herein, with new or reconditioned parts or products if found to be defective during the limited warranty period specified above. All replaced parts and products become the property of SAMSUNG and must be returned to SAMSUNG. Replacement parts and products assume the remaining original warranty, or ninety (90) days, whichever is longer.

SAMSUNG's obligations with respect to software products distributed by SAMSUNG under the SAMSUNG brand name are set forth in the applicable end user license agreement. Non-SAMSUNG hardware and software products, if provided, are on an "AS IS" basis.

Non-SAMSUNG manufacturers, suppliers, publishers, and service providers may provide their own warranties.

This limited warranty covers manufacturing defects in materials and workmanship encountered in normal, and except to the extent otherwise expressly provided for in this statement, noncommercial use of this product, and shall not apply to the following, including, but not limited to: damage which occurs in shipment; delivery and installation; applications and uses for which this product was not intended; altered product or serial numbers; cosmetic damage or exterior finish; accidents, abuse, neglect, fire, water, lightning or other acts of nature; use of products, equipment, systems, utilities, services, parts, supplies, accessories, applications, installations, repairs, external wiring or connectors not supplied and authorized by SAMSUNG, or which damage this product or result in service problems; incorrect electrical line voltage, fluctuations and surges; customer adjustments and failure to follow operating instructions, cleaning, maintenance and environmental instructions that are covered and prescribed in the instruction book; product removal or reinstallation; reception problems and distortion related to noise, echo, interference or other signal transmission and delivery problems. SAMSUNG does not warrant uninterrupted or error-free operation of the product.

THERE ARE NO EXPRESS WARRANTIES OTHER THAN THOSE LISTED AND DESCRIBED ABOVE, AND NO WARRANTIES WHETHER EXPRESS OR IMPLIED, INCLUDING, BUT NOT LIMITED TO, ANY IMPLIED WARRANTIES OF MERCHANTABILITY OR FITNESS FOR A PARTICULAR PURPOSE, SHALL APPLY AFTER THE EXPRESS WARRANTY PERIODS STATED ABOVE, AND NO OTHER EXPRESS WARRANTY OR GUARANTY GIVEN BY ANY PERSON, FIRM OR CORPORATION WITH RESPECT TO THIS PRODUCT SHALL BE BINDING ON SAMSUNG. SAMSUNG SHALL NOT BE LIABLE FOR LOSS OF REVENUE OR PROFITS, FAILURE TO REALIZE SAVINGS OR OTHER BENEFITS, OR ANY OTHER SPECIAL, INCIDENTAL OR CONSEQUENTIAL DAMAGES CAUSED BY THE USE, MISUSE OR INABILITY TO USE THIS PRODUCT, REGARDLESS OF THE LEGAL THEORY ON WHICH THE CLAIM IS BASED, AND EVEN IF SAMSUNG HAS BEEN ADVISED OF THE POSSIBILITY OF SUCH DAMAGES. NOR SHALL RECOVERY OF ANY KIND AGAINST SAMSUNG BE GREATER IN AMOUNT THAN THE PURCHASE PRICE OF THE PRODUCT SOLD BY SAMSUNG AND CAUSING THE ALLEGED DAMAGE. WITHOUT LIMITING THE FOREGOING, PURCHASER ASSUMES ALL RISK AND LIABILITY FOR LOSS, DAMAGE OR INJURY TO PURCHASER AND PURCHASER'S PROPERTY AND TO OTHERS AND THEIR PROPERTY ARISING OUT OF THE USE, MISUSE OR INABILITY TO USE THIS PRODUCT SOLD BY SAMSUNG NOT CAUSED DIRECTLY BY THE NEGLIGENCE OF SAMSUNG. THIS LIMITED WARRANTY SHALL NOT EXTEND TO ANYONE OTHER THAN THE ORIGINAL PURCHASER OF THIS PRODUCT, IS NONTRANSFERABLE AND STATES YOUR EXCLUSIVE REMEDY.

Some states do not allow limitations on how long an implied warranty lasts, or the exclusion or limitation of incidental or consequential damages, so the above limitations or exclusions may not apply to you. This warranty gives you specific legal rights, and you may also have other rights which vary from state to state.

To obtain warranty service, please contact SAMSUNG customer care center.



QUESTIONS OR COMMENTS?

COUNTRY	CALL	OR VISIT US ONLINE AT	WRITE
IN THE US	1-800-SAMSUNG (726-7864)	<a href="http://www.samsung.com">www.samsung.com</a>	Samsung Electronics America, Inc. 85 Challenger Road Ridgefield Park, NJ 07660-2112



AK68-02228A-00

## Free Manuals Download Website

<http://myh66.com>

<http://usermanuals.us>

<http://www.somanuals.com>

<http://www.4manuals.cc>

<http://www.manual-lib.com>

<http://www.404manual.com>

<http://www.luxmanual.com>

<http://aubethermostatmanual.com>

Golf course search by state

<http://golfingnear.com>

Email search by domain

<http://emailbydomain.com>

Auto manuals search

<http://auto.somanuals.com>

TV manuals search

<http://tv.somanuals.com>