

HT-E3500

5.1 CH Blu-ray™
Home Entertainment System
user manual

imagine the possibilities



Thank you for purchasing this Samsung product.
To receive more complete service,
please register your product at
www.samsung.com/register



Safety Information

Warning

TO REDUCE THE RISK OF ELECTRIC SHOCK, DO NOT REMOVE THE COVER (OR BACK). NO USER-SERVICEABLE PARTS ARE INSIDE. REFER SERVICING TO QUALIFIED SERVICE PERSONNEL.

	<div style="border: 1px solid black; padding: 5px; text-align: center;"> CAUTION <small>RISK OF ELECTRIC SHOCK DO NOT OPEN</small> </div>	
<p>The lightning flash and Arrowhead within the triangle is a warning sign alerting you of dangerous voltage inside the product.</p>	<p>CAUTION: TO REDUCE THE RISK OF ELECTRIC SHOCK, DO NOT REMOVE COVER (OR BACK) NO USER SERVICEABLE PARTS INSIDE. REFER SERVICING TO QUALIFIED SERVICE PERSONNEL.</p>	<p>The explanation point within the triangle is a warning sign alerting you of important instructions accompanying the product.</p>

WARNING

- To reduce the risk of fire or electric shock, do not expose this appliance to rain or moisture.

FCC NOTE (for U.S.A)

This equipment has been tested and found to comply with the limits for a Class B digital device, pursuant to Part 15 of the FCC rules. These limits are designed to provide reasonable protection against harmful interference in a residential installation. This equipment generates, uses and can radiate radio frequency energy and, if not installed and used in accordance with the instructions, may cause harmful interference to radio or television reception, which can be determined by turning the equipment off and on.

The user is encouraged to try to correct the interference by one or more of the following measures.

- Reorient or relocate the receiving antenna.
- Increase the separation between the equipment and receiver.
- Connect this equipment into an outlet on a circuit different from that to which the receiver is connected.
- Consult the dealer or an experienced radio/TV technician for help.
- This class B digital product meets all requirements of the Canadian Interference - Causing Equipment Regulations.

CLASS 1 LASER PRODUCT

This Compact Disc player is classified as a CLASS 1 LASER product. Use of controls, adjustments or performance of procedures other than those specified herein may result in hazardous radiation exposure.

Complies with 21CFR 1040.10 except for deviations pursuant to Laser Notice No. 50, dated June 24, 2007.

DANGER :

- VISIBLE AND INVISIBLE LASER RADIATION WHEN OPEN. AVOID DIRECT EXPOSURE TO BEAM. (FDA 21 CFR)

CAUTION :

- CLASS 3B VISIBLE AND INVISIBLE LASER RADIATION WHEN OPEN. AVOID EXPOSURE TO THE BEAM (IEC 60825-1)
- THIS PRODUCT UTILIZES A LASER. USE OF CONTROLS OR ADJUSTMENTS OTHER THAN THOSE SPECIFIED HEREIN MAY RESULT IN HAZARDOUS RADIATION EXPOSURE. DO NOT OPEN COVER AND DO NOT REPAIR YOURSELF. REFER SERVICING TO QUALIFIED PERSONNEL.

CLASS 1	LASER PRODUCT
KLASSE 1	LASER PRODUKT
LUOKAN 1	LASER LAITE
KLASS 1	LASER APPARAT
PRODUCTO	LÁSER CLASE 1

Precautions

Important Safety Instructions

Read these operating instructions carefully before using the unit. Follow all the safety instructions listed below.

Keep these operating instructions handy for future reference.

- 1 . Read these instructions.
- 2 . Keep these instructions.
- 3 . Heed all warnings.
- 4 . Follow all instructions.
- 5 . Do not use this apparatus near water.
- 6 . Clean only with a dry cloth.
- 7 . Do not block any ventilation openings. Install in accordance with the manufacturer's instructions.
- 8 . Do not install near any heat sources such as radiators, heat registers, stoves, or other apparatus (including AV receivers) that produce heat.
- 9 . Do not defeat the safety purpose of the polarized or grounding-type plug. A polarized plug has two blades with one wider than the other. A grounding type plug has two blades and a third grounding prong. The wide blade or the third prong are provided for your safety. If the provided plug does not fit into your outlet, consult an electrician for replacement of the obsolete outlet.
- 10 . Protect the power cord from being walked on or pinched particularly at plugs, convenience receptacles, and the point where it exits the apparatus.
- 11 . Only use attachments/accessories specified by the manufacturer.
- 12 . Use only with the cart, stand, tripod, bracket, or table specified by the manufacturer, or sold with the apparatus. When a cart is used, use caution when moving the cart/apparatus combination to avoid injury from tip-over.
- 13 . Unplug this apparatus during lightning storms or when unused for long periods of time.



- 14 . Refer all servicing to qualified service personnel. Servicing is required when the apparatus has been damaged in any way, such as when the power-supply cord or plug is damaged, liquid has been spilled or objects have fallen into the apparatus, the apparatus has been exposed to rain or moisture, does not operate normally, or has been dropped.

Disc Storage & Management

- Holding Discs
 - Fingerprints or scratches on a disc may reduce sound and picture quality or cause skipping.
 - Avoid touching the surface of a disc where data has been recorded.
 - Hold the disc by the edges so that fingerprints will not get on the surface.
 - Do not stick paper or tape on the disc.
- Cleaning Discs
 - If you get fingerprints or dirt on a disc, clean it with a mild detergent diluted in water and wipe with a soft cloth.
 - When cleaning, wipe gently from the inside to the outside of the disc.
- Disc Storage
 - Do not keep in direct sunlight.
 - Keep in a cool ventilated area.
 - Keep in a clean protection jacket and store vertically.



Handling Cautions

- Do not expose this apparatus to dripping or splashing. Do not put objects filled with liquids, such as vases, on the apparatus.
- To turn this apparatus off completely, you must pull the power plug out of the wall socket. Consequently, the power plug must be easily and readily accessible at all times.
- Do not touch the power plug with a wet hand. It can cause an electric shock.
- Do not plug multiple electric devices into the same wall socket. Overloading a socket can cause it to overheat, resulting in a fire.

Safety Information

- Maintenance of the Cabinet
 - Before connecting other components to this product, be sure to turn them off.
 - If you move your product suddenly from a cold place to a warm place, condensation may occur on the operating parts and lens and cause abnormal disc playback. If this occurs, unplug the product, wait for two hours, and then connect the plug to the power outlet. Then, insert the disc, and try to play back again.
- If the product makes an abnormal noise or produces a burning smell or smoke, turn off the power switch immediately and disconnect the power plug from the wall outlet. Then, contact the nearest customer service center for technical assistance. Do not use the product. Using the product as it is may cause a fire or an electric shock.
- To turn this apparatus off completely, you must pull the power plug out of the wall socket. Consequently, the power plug must be easily and readily accessible at all times.

License



- Dolby and the double-D symbol are registered trademarks of Dolby Laboratories.



- Manufactured under license under U.S. Patent Nos: 5,956,674; 5,974,380; 6,226,616; 6,487,535; 7,392,195; 7,272,567; 7,333,929; 7,212,872 & other U.S. and worldwide patents issued & pending. DTS-HD, the Symbol, & DTS-HD and the Symbol together are registered trademarks & DTS-HD Master Audio | Essential is a trademark of DTS, Inc. Product includes software. © DTS, Inc. All Rights Reserved.



- The terms HDMI and HDMI High-Definition Multimedia Interface, and the HDMI Logo are trademarks or registered trademarks of HDMI Licensing LLC in the United States and other countries.

4 English



- Oracle and Java are registered trademarks of Oracle and/or its affiliates. Other names may be trademarks of their respective owners.
- This item incorporates copy protection technology that is protected by U.S. patents and other intellectual property rights of Rovi Corporation. Reverse engineering and disassembly are prohibited.
- Blu-ray Disc™, Blu-ray™, and the logos are trademarks of Blu-ray Disc Association.
- This product uses Cinavia technology to limit the use of unauthorized copies of some commercially-produced film and videos and their soundtracks. When a prohibited use of an unauthorized copy is detected, a message will be displayed and playback or copying will be interrupted. More information about Cinavia technology is provided at the Cinavia Online Consumer Information Center at <http://www.cinavia.com>. To request additional information about Cinavia by mail, send a postcard with your mailing address to: Cinavia Consumer Information Center, P.O. Box 86851, San Diego, CA, 92138, USA.”
This product incorporates proprietary technology under license from Verance Corporation and is protected by U.S. Patent 7,369,677 and other U.S. and worldwide patents issued and pending as well as copyright and trade secret protection for certain aspects of such technology. Cinavia is a trademark of Verance Corporation. Copyright 2004-2010 Verance Corporation. All rights reserved by Verance. Reverse engineering or disassembly is prohibited.
- Open Source License Notice
 - In the case of using open source software, Open Source Licenses are available on the product menu.

Copyright

© 2012 Samsung Electronics Co.,Ltd.
All rights reserved; No part or whole of this user's manual may be reproduced or copied without the prior written permission of Samsung Electronics Co.,Ltd.

Contents

SAFETY INFORMATION

- 2 **Warning**
- 3 **Precautions**
- 3 **Disc Storage & Management**
- 3 **Handling Cautions**
- 4 **License**
- 4 **Copyright**

GETTING STARTED

- 6 **Disk and Format Compatibility**
- 7 **Logos of Discs the product can play**
- 10 **Accessories**
- 11 **Front Panel**
- 11 **Rear Panel**
- 12 **Remote Control**

CONNECTIONS

- 13 **Connecting the Speakers**
 - 13 **Speaker Components**
 - 14 **Connecting The Speakers**
- 15 **Connecting to a TV**
 - 15 **Method 1** Connecting to a TV with an HDMI Cable - Best Quality (Recommended)
 - 15 **Method 2** Connecting to a TV with a Video Cable - Good Quality
- 15 **Attaching the Toroidal Ferrite Core to the Power Cord of the Main Unit**
- 16 **Connecting to External Devices**
 - 16 **Method 1** AUX IN : Connecting an External Analog Component
 - 16 **Method 2** OPTICAL : Connecting an External Digital Audio Component
- 17 **Connecting the FM Antenna**
- 17 **Connecting to a Network Router**

SETTINGS

- 18 **The Initial Settings Procedure**
- 19 **The Home Screen**
- 20 **Accessing the Settings Screen**
- 21 **Settings Menu Functions**
- 25 **Networks and the Internet**
- 26 **Upgrading Software**
- 28 **Setting Up AllShare**

MEDIA PLAY

- 29 **Using the Streaming Media Services**
- 29 **Playing Files on a USB Device**
- 30 **Playing a Disc with User Recorded Content**
- 30 **Playing a Commercial Video Disc**
- 30 **Playing a Pre-Recorded Commercial Audio Disc**
- 31 **Controlling Video Playback**
- 32 **Controlling Music Playback**
- 33 **Controlling Photo Playback**
- 34 **Listening to Radio**
- 34 **Using the Special Effects Remote Control Buttons**
- 35 **Using BD-LIVE™**
- 35 **Using AllShare**

APPENDIX

- 36 **Additional Information**
- 41 **Troubleshooting**
- 44 **Specifications**

Getting Started

Disk and Format Compatibility

Disc types and contents your product can play

Media	Disc Type	Details
VIDEO	Blu-ray Disc	BD-ROM or BD-RE/-R disc recorded in the BD-RE format.
	DVD-VIDEO, DVD-RW, DVD-R, DVD+RW, DVD+R	DVD-VIDEO, recorded DVD+RW/DVD-RW(V)/DVDR/+R discs that have been recorded and finalized, or a USB storage media containing MKV, MP4 contents.
MUSIC	CD-RW/-R, DVD-RW/-R, BD-RE/-R	Music recorded on CD-RW/-R, DVD-RW/-R, BD-RE/-R discs or a USB storage media containing MP3 or WMA contents.
PHOTO	CD-RW/-R, DVD-RW/-R, BD-RE/-R	Photos recorded on CD-RW/-R, DVD-RW/-R, BD-RE/-R discs or a USB storage media containing JPEG contents.

| NOTE |

- ▶ The product may not play certain CD-RW/-R and DVD-R because of the disc type or recording conditions.
- ▶ If a DVD-RW/-R disc has not been recorded properly in DVD video format, it will not be playable.
- ▶ Your product will not play content that has been recorded on a DVD-R at a bitrate that exceeds 10 Mbps.
- ▶ Your product will not play content that has been recorded on a BD-R or USB device at a bitrate that exceeds 30 Mbps.
- ▶ Playback may not work for some types of discs, or when you use specific operations, such as angle change and aspect ratio adjustment. Information about the discs is written in detail on the disc box. Please refer to this if necessary.
- ▶ When you play a BD-J title, loading may take longer than a normal title or some functions may perform slowly.

Disc types your product cannot play

- HD DVD
- DVD-ROM/PD/MV-Disc, etc
- DVD-RAM
- Super Audio CD (except CD layer)
- DVD-RW(VR mode)
- CVD/CD-ROM/CDV/CD-G/CD-I/LD (CD-Gs play audio only, not graphics.)
- 3.9 GB DVD-R Disc for Authoring.

| NOTE |

- ▶ This product may not respond to all operating commands because some Blu-ray Disc, DVD, and CD discs allow specific or limited operation and provide only certain features during playback. Please note that this is not a defect in the product.
- ▶ Samsung cannot guarantee that this product will play every disc bearing the Blu-ray Disc, DVD or CD logo because disc formats evolve, and problems and errors may occur during the creation of Blu-ray Disc, DVD, and CD software and/or the manufacture of discs.
- ▶ Please contact the SAMSUNG Customer Care Center at 1-800-726-7864 if you have questions or encounter difficulty when playing Blu-ray Disc, DVD, or CD discs in this product. Also, refer to rest of this user manual for additional information on playback restrictions.
- ▶ Some commercial discs and DVD discs purchased outside your region may not play on this product.

Region Code

Blu-ray players and discs are coded by region. These regional codes must match for a disc to play. If the codes do not match, the disc will not play.







The Region Number for this product is displayed on the rear panel of the product.

Disc Type	Region Code	Area
Blu-ray Disc		North America, Central America, South America, Korea, Japan, Taiwan, Hong Kong and South East Asia.
		Europe, Greenland, French territories, Middle East, Africa, Australia and New Zealand.
		India, China, Russia, Central and South Asia.
DVD-VIDEO		The U.S., U.S. territories and Canada
		Europe, Japan, the Middle East, Egypt, South Africa, Greenland
		Taiwan, Korea, the Philippines, Indonesia, Hong Kong
		Mexico, South America, Central America, Australia, New Zealand, Pacific Islands, Caribbean
		Russia, Eastern Europe, India, most of Africa, North Korea, Mongolia
		China

| NOTE |

- ▶ If the Region number of a Blu-ray Disc/DVDs does not correspond to the Region number of this product, the product cannot play the disc.

Logos of Discs the product can play

	
Blu-ray Disc	BD-LIVE
	
Dolby	DTS
	
NTSC broadcast system in U.S.A, Canada, Korea, Japan	Java

Supported Formats

Music File Support

File Extension	Container	Audio Codec	Support Range
*.mp3	MP3	MP3	-
*.wma	WMA	WMA	* Sampling rates (in kHz) - 8, 11, 16, 22, 32, 44.1, 48 * Bitrates - All bitrates from 5kbps to 384kbps

Getting Started

Video File Support

File Extension	Container	Video Codec	Audio Codec	Resolution
*.avi	AVI	MP4v3	MP3 Dolby Digital DTS	1920x1080
		H.264 BP/MP/HP	WMA PCM	1920x1080
*.mkv	MKV	VC-1 AP	MP3 Dolby Digital DTS	1920x1080
		H.264 BP/MP/HP		1920x1080
*.wmv	WMV (wmv9)	VC-1 AP	WMA	1920x1080
		VC-1 SM		1920x1080
*.mp4	MP4	MP4 (mp4v)	AAC	1920x1080
		H.264 BP/MP/HP		1920x1080
*.mpg *.mpeg	PS	MPEG1	MP1, 2 Dolby Digital DTS	1920x1080
		MPEG2		1920x1080
		H.264 BP/MP/HP		1920x1080

■ Limitations

- Even when the file is encoded by a supported codec mentioned above, a file might not be played if its content has a problem.
- Normal playback is not guaranteed if the file's container information is wrong or the file itself is corrupted.
- Files having a higher bit rate or frame rate than standard may stutter during sound/video playback.
- The Seek (skip) function is not available if the file's index table is damaged.

■ Video decoder

- Supports up to H.264 Level 4.1 and AVCHD
- Does not support H.264 FMO/ASO/RS and VC1 SP/MP/AP L4
- MPEG4 SP, ASP :
Below 1280 x 720 : 60 frames max
Above 1280 x 720 : 30 frames max
- Does not support GMC 2 or higher

■ Audio decoder

- Supports WMA 7, 8, 9 and STD
- Does not support WMA sampling rate of 22050Hz mono.

Notes on the USB connection

- Your product supports USB storage media, MP3 players, digital cameras, and USB card readers.
- The product does not support folder or file names longer than 128 characters.
- Some USB/External HDD/digital camera devices may not be compatible with the product.
- Your product supports the FAT 16, FAT 32, and NTFS files systems.
- Connect USB devices directly to the product's USB port. Connecting through a USB cable may cause compatibility problems.
- Inserting more than one memory device into a multi-card reader may cause the reader to operate improperly.
- The product does not support the PTP protocol.
- Do not disconnect a USB device during a "loading" process.
- The bigger the image resolution, the longer the image takes to display.
- This product cannot play MP3 files with DRM (Digital Rights Management) downloaded from commercial sites.
- Your product only supports video that is under 30fps (frame rate).
- You must remove the USB storage device safely (by performing the "**Safely Remove USB**" function) to prevent possible damage to the USB memory.
Press the **HOME** button to move to the home menu, press the **YELLOW (C)** button, and then press the  button.
- SAMSUNG is not responsible for any data file damage or data loss.

AVCHD (Advanced Video Codec High Definition)

- This product can play back AVCHD format discs. These discs are normally recorded and used in camcorders.
- The AVCHD format is a high definition digital video camera format.
- The MPEG-4 AVC/H.264 format compresses images with greater efficiency than the conventional image compressing format.
- Some AVCHD discs use the "x.v.Color" format. This product can play back AVCHD discs that use "x.v.Color" format.
- "x.v.Color" is a trademark of Sony Corporation.
- "AVCHD" and the AVCHD logo are trademarks of Matsushita Electronic Industrial Co., Ltd. and Sony Corporation.





| NOTE |

- ▶ Some AVCHD format discs may not play, depending on the recording conditions.
- ▶ AVCHD format discs need to be finalized.
- ▶ "x.v.Color" offers a wider color range than normal DVD camcorder discs.
- ▶ Some MKV and MP4 format discs may not play, depending on their video resolution and frame rate.

Getting Started

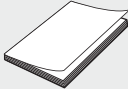
Accessories

Check for the supplied accessories below.

		
Video Cable (AH39-40001V)	User Manual (AH68-02476A)	
	 (For Power cord)	
FM Antenna (AH42-00021A)	Toroidal Ferrite Core (3301-000144)	
		Remote Control (AH59-02411A)/ Batteries (AAA size) (4301-000116)

- Figures and illustrations in this User Manual are provided for reference only and may differ from actual product appearance.

Front Panel

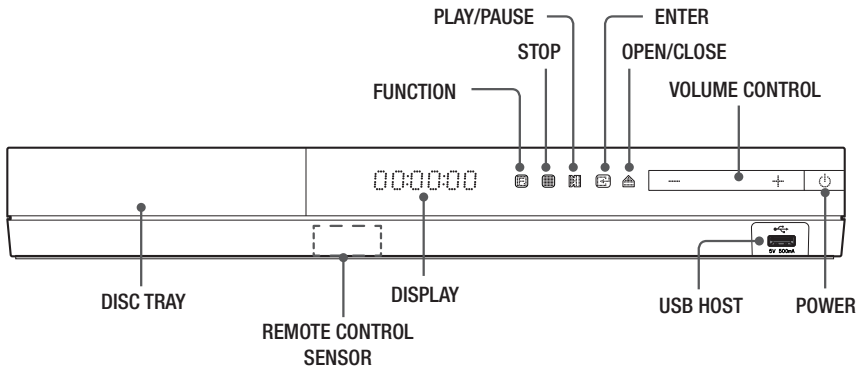

| NOTE |

- ▶ To upgrade the product's software through the USB Host jack, you must use a USB memory stick.
- ▶ When the product displays the Blu-ray Disc menu, you cannot start the movie by pressing the button on the product or the remote. To play the movie, you must select Play Movie or Start in the disc menu, and then press the button.

Rear Panel

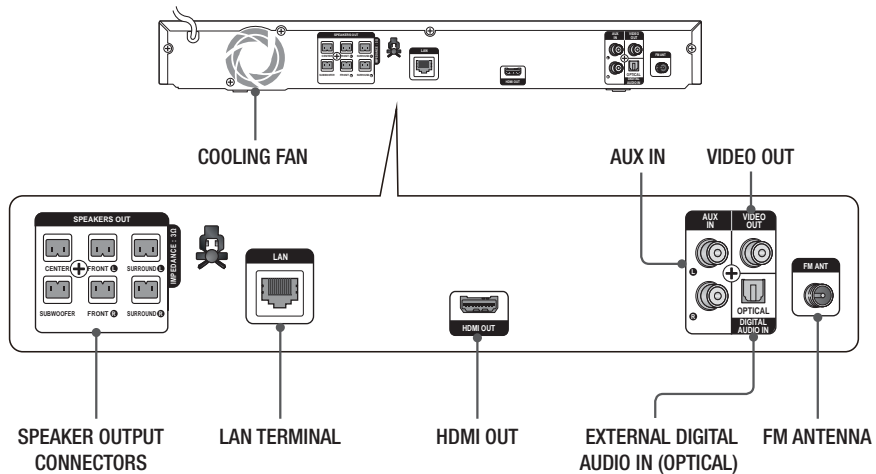

| NOTE |

- ▶ Ensure a minimum of 4 inches of clear space on all sides of the home theater to ensure adequate ventilation. Do not obstruct the cooling fan or ventilation holes.

Getting Started

Remote Control

Tour of the Remote Control

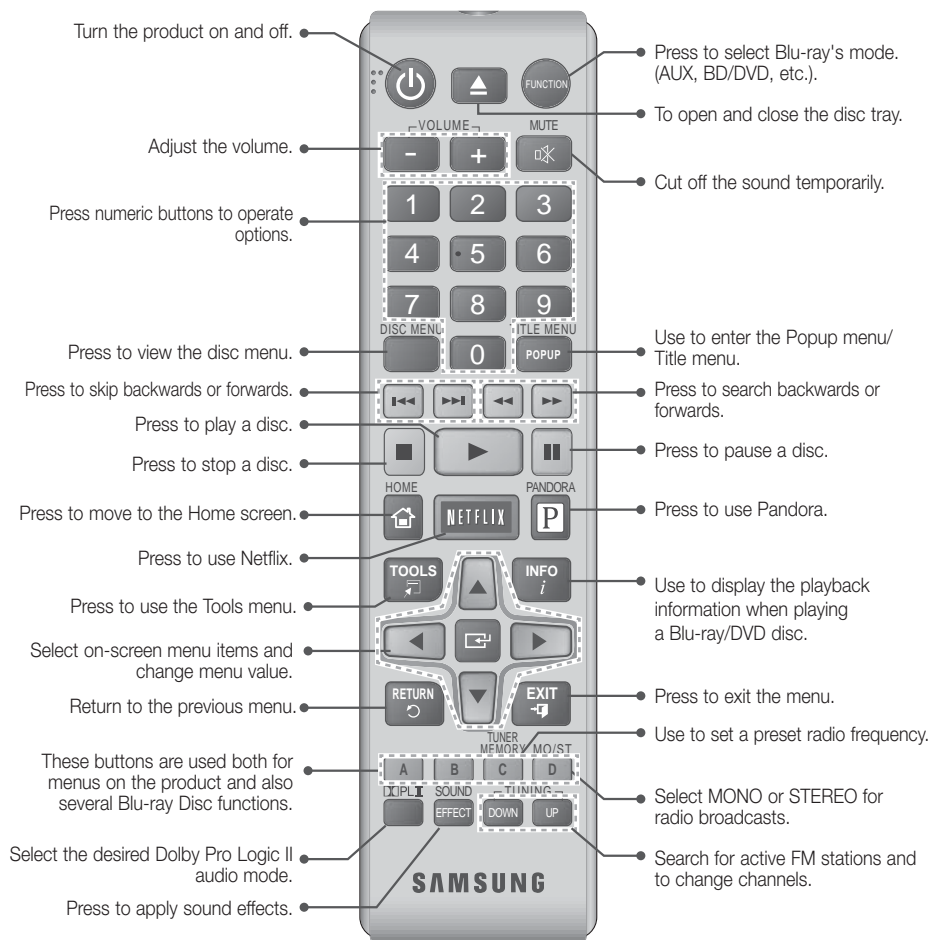

Installing batteries in the Remote Control

- ▶ Make sure to match the "+" and "-" ends of the batteries with the diagram inside the compartment.
- ▶ Assuming typical TV usage, the batteries last for about one year.
- ▶ The remote control can be used up to approximately 23 feet (7 meters) from the product in a straight line.

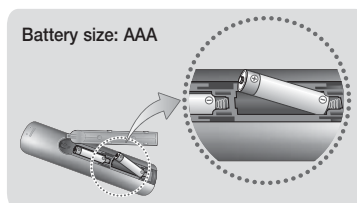

Connections

This section describes various methods of connecting the product to other external components. Before moving or installing the product, be sure to turn off the power and disconnect the power cord.

Connecting the Speakers

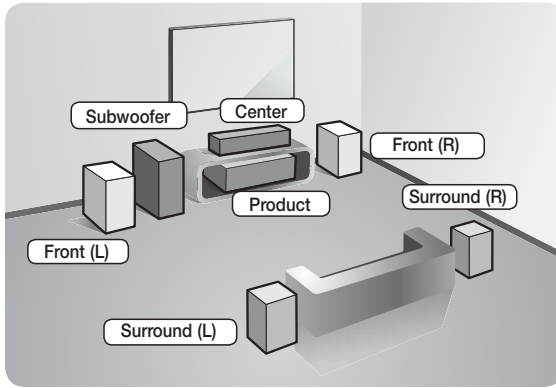

Position of the product

Place it on a stand or cabinet shelf, or under the TV stand.

Selecting the Listening Position

The listening position should be located about 2.5 to 3 times the size of the TV's screen from the TV. For example, if you have a 46 inch screen, locate the listening position 115 to 138 inches (9.6 to 11.5 feet) from the screen.

Front Speakers	Place these speakers in front of your listening position, facing inwards (about 45°) toward you. Place the front speakers so that their tweeters will be at the same height as your ear. Align the front face of the front speakers with the front face of the center speaker or place them slightly in front of the center speakers.
Center Speaker	It is best to install the Center Speaker at the same height as the front speakers. You can also install it directly over or under the TV.
Surround Speakers	Place these speakers to the side of your listening position. If there isn't enough room, place these speakers so they face each other. Position them about 2 to 3 feet (60 to 90cm) above your ear, facing slightly downward. ★ Unlike the front and center speakers, the surround speakers are used mainly for sound effects. Sound will not come from them all the time.
Subwoofer	The position of the subwoofer is not so critical. Place it anywhere you like.

Speaker Components

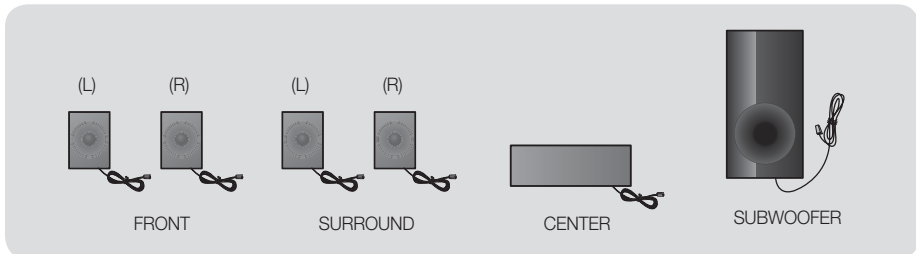

Connections

Connecting The Speakers

1. Connect the speaker wire plugs from each speaker to the back of the product by matching the colors of the speaker plugs to the colors of the speaker jacks.

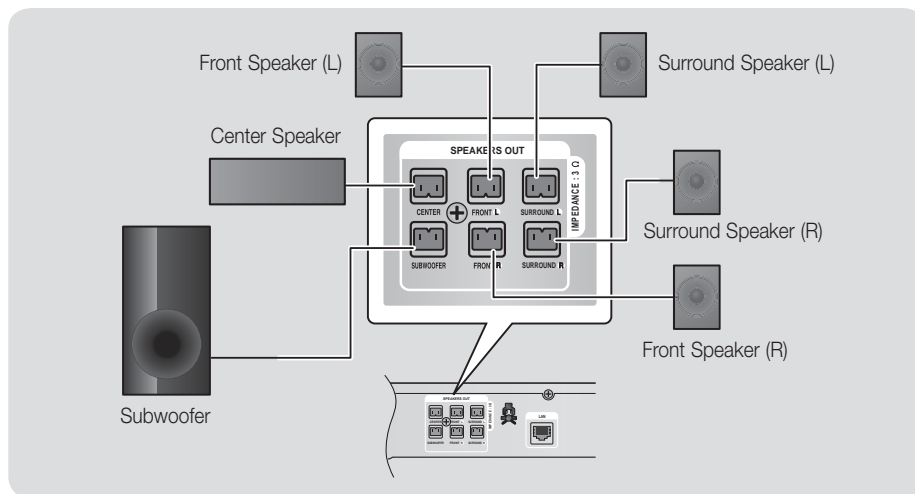

| CAUTION |

- ▶ If you want to install the product on the wall, fasten the screws or nails on the wall firmly and use the holes on the rear of speaker to install. However, when you install it, accessories (nails or screws) and installation is not provided by the company.
- ▶ Do not let children play with or near the speakers. They could get hurt if a speaker falls.
- ▶ Keep the subwoofer speaker out of reach of children to prevent children from inserting their hands or alien substances into the duct (hole) of the subwoofer speaker.
- ▶ Do not hang the subwoofer on the wall through the duct (hole).

| NOTE |

- ▶ If you place a speaker near your TV set, the screen color may be distorted because of the magnetic field.

Connecting to a TV

Select either Method 1 or Method 2.

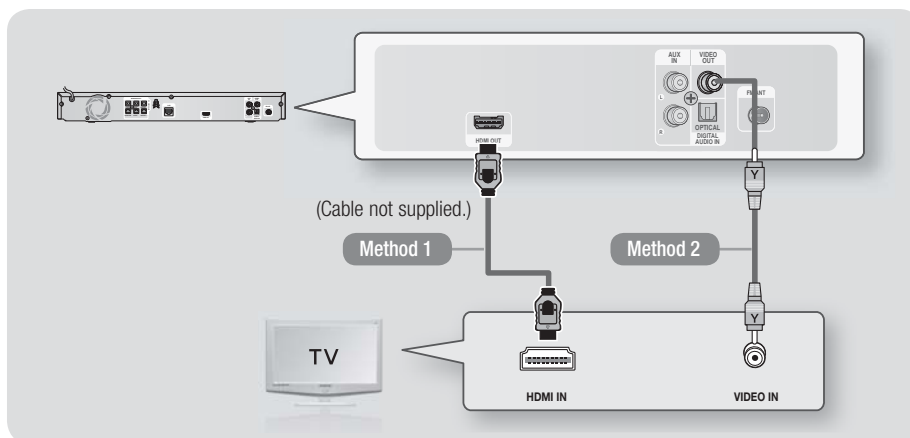

Method 1 Connecting to a TV with an HDMI Cable - Best Quality (Recommended)

Connect an HDMI cable (not supplied) from the HDMI OUT jack on the back of the product to the HDMI IN jack on your TV.

If the TV supports ARC, you can hear TV sound from home theater with only connect this cable.

Method 2 Connecting to a TV with a Video Cable - Good Quality

Connect the supplied Video cable from the VIDEO OUT jack on the back of the product to the VIDEO IN jack on your TV.

| NOTE |

- ▶ The VIDEO Out jack always outputs in the 480i resolution regardless of the resolution set in the Setup menu.
- ▶ Do not connect the unit through a VCR. Video signals fed through VCRs may be affected by copyright protection systems and the picture will be distorted on the television.

Attaching the Toroidal Ferrite Core to the Power Cord of the Main Unit

If you attach a Toroidal ferrite core to the power cord of the main unit, it will help to prevent RF interference from radio signals.

1. Pull the fixing tab of the Toroidal ferrite core to open it.
2. Make a loop twice in the main unit power cord.
3. Attach the Toroidal ferrite core to the main unit power cord as the figure shows and press it until it clicks.

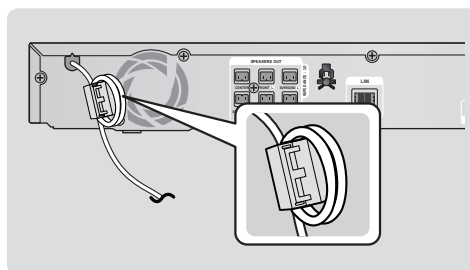

Connections

Connecting to External Devices

To select the correct mode for an external device, press the **FUNCTION** button. Each time you press the button, the mode changes in this order : **BD/DVD** → **D. IN** → **AUX** → **FM**

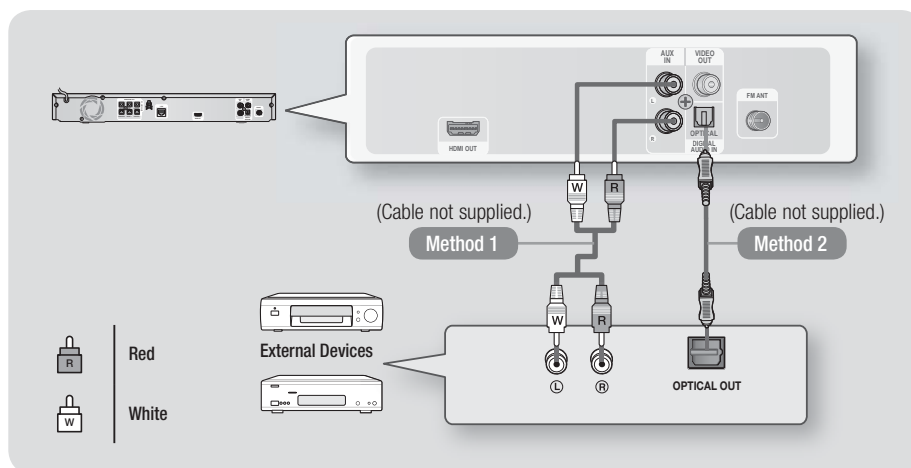

Method 1 AUX IN : Connecting an External Analog Component

Using an RCA audio cable (not supplied), connect the AUDIO In jack on the product to the AUDIO Out jack on the external analog component. ⇒ Select the **AUX** mode.

- Be sure to match the colors on the cable plugs to the colors on the input and output jacks.

Method 2 OPTICAL : Connecting an External Digital Audio Component

To connect the digital audio output of digital signal components such as Cable Boxes and Satellite Receivers (Set-Top-Boxes).

Using a digital optical cable (not supplied), connect the Optical Digital Audio In jack on the product to the Digital Optical Out jack of the external digital device using a digital optical cable.

⇒ Select the **D. IN** mode.

| NOTE |

- ▶ To see video from your Cable Box/Satellite receiver, you must connect its video output directly to your TV.
- ▶ This system supports Digital sampling frequencies of 32 kHz or higher from external digital components.
- ▶ This system supports only DTS and Dolby Digital audio. MPEG audio, a bitstream format, is not supported.

Connecting the FM Antenna

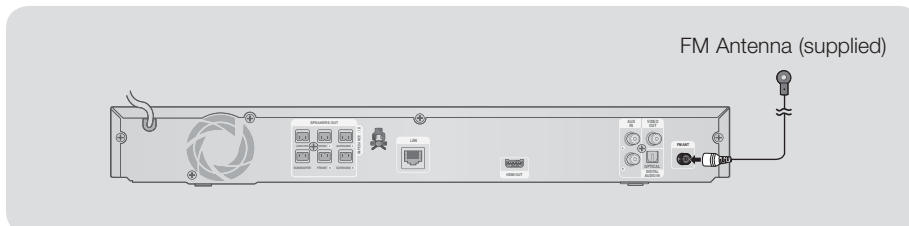

1. Connect the FM antenna supplied to the FM ANTENNA Jack.
2. Slowly move the antenna wire around until you find a location where reception is good, then fasten it to a wall or other rigid surface.

| NOTE |

- ▶ This product does not receive AM broadcasts.

Connecting to a Network Router

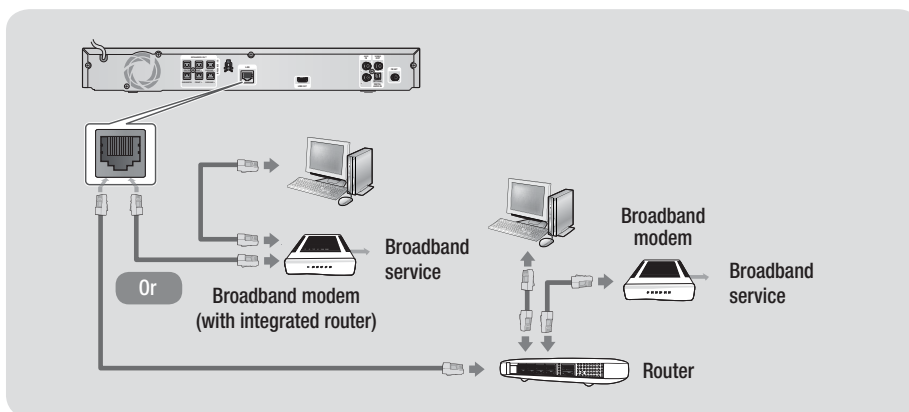

| NOTE |

- ▶ Internet access to Samsung's software update server may not be allowed, depending on the router you use or your ISP's policy. For more information, contact your ISP (Internet Service Provider).
- ▶ DSL users, please use a router to make a network connection.
- ▶ For the AllShare function, a PC must be connected in the network as shown in the figure.

Settings

The Initial Settings Procedure

- The Home menu will not appear if you do not configure the initial settings.
- The OSD (On Screen Display) may change in this product after you upgrade the software version.
- The access steps may differ depending on the menu you selected.

1. Turn on your TV after connecting the product, and then turn on the product. When you turn on the product for the first time, the product automatically displays the Initial Settings Language screen.



2. Press the ▲▼ buttons to select the desired language, and then press the [Select] button.
3. Press the [Start] button to start function setup.

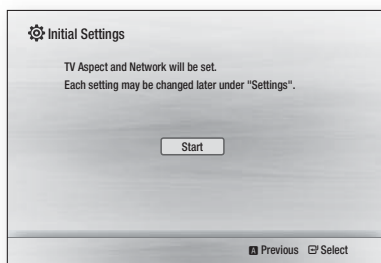

4. The TV Aspect screen appears. Press the ▲▼ buttons to select desired a TV Aspect ratio, and then press the [Select] button.

You have four choices:

16:9 Original - For widescreen TVs. Displays widescreen pictures in their original 16:9 format and 4:3 pictures (the old, standard format) in 4:3 pillar box format with black bars on the left and right.

16:9 Full - For widescreen TVs. Displays widescreen pictures in their original 16:9 format and expands 4:3 pictures to fill the 16:9 screen.

4:3 Letter Box - For older, standard screen analog TVs. Displays 4:3 pictures in full screen and 16:9 pictures in letter box format that retains the 16:9 aspect ratio but puts black bars above and below the picture.

4:3 Pan-Scan - For older, standard screen analog TVs. Displays 4:3 pictures in full screen and 16:9 pictures in Pan-Scan format that fills the screen, but cuts off the left and right sides of the picture and enlarges the middle vertically.

5. The **Network - Wired** screen appears.

- If you have a network with dynamic IP addresses - and most people do - select **Auto**, press the [Select] button, and then go to Step 6.

- If you have a network with static IP addresses, we suggest you select **Skip** by pressing the **BLUE (D)** button, and then go to "Configuring Your Network Connection" on page 25 after you have completed the initial setup. "Configuring Your Network Connection" provides a full explanation of how to configure your network connection manually.

- If you have no network, select **Skip** by pressing the **BLUE (D)** button. The Initial Settings Complete screen appears, and then the Home screen appears.

| NOTE |

- ▶ If you skip network setup here or the setup does not work correctly, you can go to "Configuring Your Network Connection" on page 25 to set up the product's network connection later.

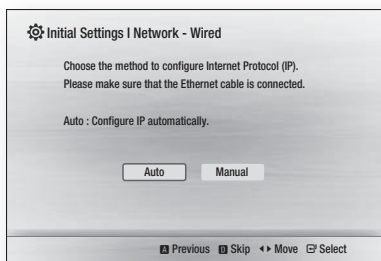

6. The product verifies the network connection and then connects to the network. When it is done, press the button. The Initial Settings Complete screen appears, and then the Home screen appears.

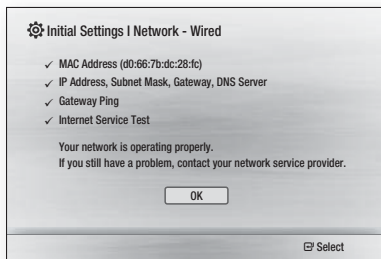

| NOTE |

- ▶ If you want to display the Initial Setting screen again and make changes, select the Reset option. (See page 24)
- ▶ If you use an HDMI cable to connect the product to an AnyNet+(HDMI-CEC)-compliant Samsung TV and 1.) You have set the AnyNet+(HDMI-CEC) feature to ON in both the TV and the product and 2.) You have set the TV to a language supported by the product, the product will select that language as the preferred language automatically.

The Home Screen



1	Videos. Play videos located on discs, USB devices, or your PC.
2	Photos. View photos located on discs, USB devices, or your PC.
3	Network Services. Select a network service: Netflix, Vudu, CinemaNow, Pandora, or YouTube.
4	Music. Play music located on discs, USB devices, or your PC.
5	Settings. Set various functions to suit your personal preferences.
6	Displays the colored buttons on your remote that you can press to access or perform functions.

■ Selecting an Option on the Home Screen

1. To select an option on the Home screen, move the cursor using the ◀▶ buttons until it highlights the option of your choice, and then press the button.

| NOTE |

- ▶ To play or view video, music, or photo files located on your PC, you must connect your home theater and PC to a home network and you must download, install, and configure the AllShare software on your PC. (See page 28.)

Settings

Accessing the Settings Screen

1. Select **Settings** on the Home screen, and then press . The Settings screen appears.

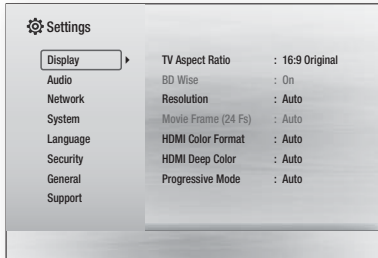





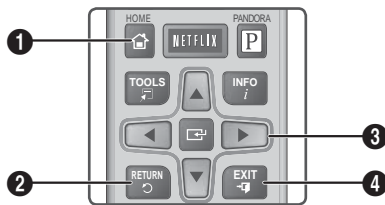

2. To access the menus, sub-menus, and options on the Settings screen, please refer to the remote control illustration below.

| NOTE |

- ▶ If you leave the product in the stop mode for more than 5 minutes without using it, a screen saver will appear on your TV. If the product is left in the screen saver mode for more than 20 minutes, the power will automatically turn off.

Buttons on the Remote Control Used for the Settings Menu







1	HOME Button : Press to move to the Home screen.
2	RETURN (↶) Button : Return to the previous menu.
3	 (Enter) / DIRECTION Button : <ul style="list-style-type: none"> • Press     to move the cursor or select an item. • Press the  button to activate the currently selected item or confirm a setting.
4	EXIT Button : Press to exit the current menu.

| NOTE |

- ▶ The  button on the product's front panel can be used for same purpose as the  button on the remote control.

Detailed Function Information

Each Settings function, menu item, and individual option is explained in detail on-screen. To view an explanation, use the     buttons to select the function, menu item, or option.

The explanation will usually appear on the bottom of the screen. A short description of each Settings function starts on next page. Additional information on some of the functions is also in the Appendix of this manual.

Settings Menu Functions

Display	TV Aspect Ratio	Lets you adjust the output of the product to the screen size of your TV. See page 18, Step 4 for a description of the screen size options.
	BD Wise	BD Wise is Samsung's latest inter-connectivity feature. When you connect a Samsung product and a Samsung TV with BD Wise to each other via HDMI, and BD Wise is on in both the product and TV, the product outputs video at the video resolution and frame rate of the Blu-ray/DVD Disc.
	Resolution	Lets you set the output resolution of the HDMI video signal to Auto, 1080p, 1080i, 720p, 480p . If Composite is connected, the resolution supports only 480i . The number indicates the number of lines of video per frame. The i and p indicate interlaced and progressive scan, respectively. The more lines, the higher quality.
	Movie Frame (24 Fs)	Setting the Movie Frame (24 Fs) feature to Auto lets the product adjust its HDMI output to 24 frames per second automatically for improved picture quality if attached to a 24Fs compatible TV. <ul style="list-style-type: none"> You can enjoy the Movie Frame (24 Fs) feature only on a TV supporting this frame rate. Movie Frame is only available when the product is in the HDMI 1080i or 1080p output resolution modes.
	HDMI Color Format	Lets you set the color space format for the HDMI output to match the capabilities of the connected device (TV, monitor, etc).
	HDMI Deep Color	Lets you set the product to output video from the HDMI OUT jack with Deep Color. Deep Color provides more accurate color reproduction with greater color depth.
	Progressive Mode	Lets you improve picture quality when viewing DVDs.

Settings

Audio	Speaker Setting	You can set the speaker options.
	Speaker Selection	Lets you select which speakers you want active, either the TV's speakers or the Home Theaters's speakers.
	Audio Return Channel	Lets you direct the sound from the TV to the Home Theater speakers. Requires an HDMI connection and an Audio Return Channel (ARC) compatible TV. <ul style="list-style-type: none"> When Audio Return Channel is set to Auto, the home theater automatically selects either ARC or optical input as the audio source, depending on your connections. If Audio Return Channel is active, optical input does not work.
	Digital Output	Lets you set the Digital Output to match the capabilities of the AV receiver you've connected to the product. For more details, please refer to the digital output selection table. (See page 40)
	Dynamic Range Control	Lets you apply dynamic range control to Dolby Digital, Dolby Digital Plus, and Dolby True HD audio. <ul style="list-style-type: none"> ✓ Auto: Automatically controls the dynamic range of Dolby TrueHD audio, based on information in the Dolby TrueHD soundtrack. Also turns dynamic range control on for Dolby Digital and Dolby Digital Plus. ✓ Off: Leaves the dynamic range uncompressed, letting you hear the original sound. ✓ On: Turns dynamic range control on for all three Dolby formats. Quieter sounds are made louder and the volume of loud sounds is reduced.
	Audio Sync	When the product is attached to a digital TV, lets you adjust the audio delay so that the audio syncs with the video. You can set the delay between 0 and 300 milliseconds.

Network	Wired Network Settings	For more information about Network Settings and network functions, see "Networks and the Internet" starting on page 25.
	Network Test	Lets you test the Internet Protocol setup to see if it is working correctly.
	Network Status	Lets you check whether a connection to the network and the Internet have been established.
	BD-Live Internet Connection	Lets you allow or prohibit an Internet connection for the BD-Live service.
System	Initial Settings	Lets you re-run the Initial Settings procedure. See page 18 for details.
	Anynet+ (HDMI-CEC)	Anynet+ is a convenient function that offers linked operations with other Samsung products that have the Anynet+ feature and lets you control those products with one Samsung TV remote. To operate this function, you must connect this product to an Anynet+ Samsung TV using an HDMI cable.
	BD Data Management	Lets you manage the contents you downloaded through a Blu-ray disc that supports the BD-Live service. You can view the information about the USB device you are using for BD Live data storage including the storage space. You can also delete BD Live data and change the device.
Language	<p>You can select the language you prefer for the On-Screen Menu, disc menu, etc.</p> <ul style="list-style-type: none"> The selected language will only appear if it is supported on the disc. 	

Settings

Security	The default PIN is 0000. Enter the default PIN to access the security function if you haven't created your own PIN.	
	BD Parental Rating	Prevents playback of Blu-ray Discs with a rating equal to or above a specific age ratings unless the PIN is entered.
	DVD Parental Rating	Prevents playback of DVDs with a rating above a specific numerical ratings unless the PIN is entered.
	CinemaNow Lock Netflix Lock Vudu Lock Pandora Lock YouTube Lock	If the lock set to On, you must enter the PIN to use the service.
	Change PIN	Change the 4-digit PIN used to access security functions.
General	Time Zone	You can specify the time zone that is applicable to your area.
Support	Software Upgrade	For more information about the Software Upgrade function, see "Upgrading Software" on page 26.
	Contact Samsung	Provides contact information for assistance with your product.
	Terms of Service Agreement	View the general disclaimer regarding third party contents and services.
	Reset	All settings will revert to the default except for the network settings. The default security password is 0000.

Networks and the Internet

When you connect this product to a network, you can use network based applications and functions such as BD-LIVE and upgrade the product's software through the network connection.

Configuring Your Network Connection

Before you begin, contact your ISP to find out if your IP address is static or dynamic. If it is dynamic, we recommend you use the Automatic procedure below. If it is static, you must use the Manual procedure that follows.

- Before you begin, confirm that the product is connected to your router with a network cable.

Automatic

To start the configuration process, follow these steps:

1. In the Home menu, select **Settings**, and then press the **Enter** button.
2. Select **Network**, and then press the **Enter** button.
3. Select **Wired Network Settings**, and then press the **Enter** button.
The Wired Network Settings screen appears.
4. Press the **Right** button on the Internet Protocol Setup menu.
Use **Up/Down** button to select **Auto**, and then press the **Enter** button.

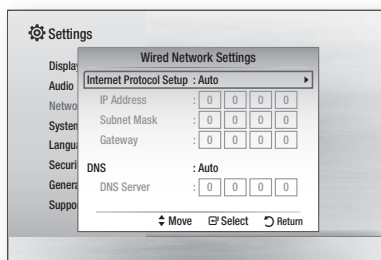

5. The Network function acquires and fills in the values for IP Address, Subnet Mask, etc., automatically.

6. After the Network function has acquired the network values, press the **RETURN** button.
7. Select **Network Test**, and then press **Enter**.
The home theater validates the network connection. When it is done, press the **RETURN** button.



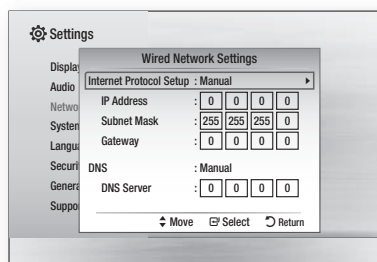

Manual

If you have a static IP address or the Automatic procedure does not work, you'll need to set the Network Settings values manually.



1. Follow the first four steps in the Automatic procedure, but select **Manual** instead of Auto in Step 4.
2. Press the **Down** button to go to the first entry field (IP Address).
3. Use the number buttons on your remote to enter numbers.
4. When done with each field, use the **Right** button to move successively to the next field. You can also use the other arrow buttons to move up, down, and back.
5. Enter the **IP Address**, **Subnet Mask**, and **Gateway** values.
6. Press the **Down** button to go to **DNS**.
7. Press the **Down** button to go to the first DNS entry field. Enter the numbers as above.
8. Press the **RETURN** button on your remote.

Settings

9. Select **Network Test**, and then press .
When the test is completed, press **RETURN** () button to exit to the previous screen.
10. Select **Network Status**, and then press .
11. The Network Status screen appears.
The product verifies the network connection and then connects to the network. When it is done, highlight **OK**, and then press .

| NOTE |

- ▶ You can get the Network values from your Internet provider. You can also view these values on most Windows computers. For instructions, see "Getting the Network Setting Values" on this page.

< Getting the Network Settings Values >

You can view your Network Settings values on most Windows computers. To view the Network Settings values, follow these steps:

- Windows XP
 1. Right click the Network icon on the bottom right of the Windows desktop.
 2. In the pop-up menu, click Status.
 3. On the dialog that appears, click the Support tab.
 4. On the Support tab, click the Details button.
The Network settings are displayed.
- Windows 7
 1. Click the Network icon on the bottom right of the Windows desktop.
 2. In the pop-up menu, click Network and Sharing Center.
 3. On the dialog that appears, click the Local Area Connection.
 4. On the Support tab, click the Details button.
The Network settings are displayed.





| NOTE |

- ▶ Depending on your Windows version, the information may differ.

Upgrading Software

The Software Upgrade menu allows you to upgrade the product's software for performance improvements or additional services.

- Never turn the product off or back on manually during the update process.

1. In the Home menu, select **Settings**, and then press the .
2. Select **Support**, and then press the .
3. Select **Software Upgrade**, and then press the .
4. Select one of the following methods:
 - **By Online**
 - **By USB**
 - **Auto Upgrade Notification**
5. Press the  button.
Directions for each method begin below.

| NOTE |

- ▶ The update is complete when the product turns off after restarting. Press the **POWER** button to turn on the updated product for your use. Never turn the product on or off manually during the update process.
- ▶ Samsung Electronics takes no legal responsibility for product malfunction caused by an unstable Internet connection or consumer negligence during a software upgrade.
- ▶ If you want to cancel the upgrade while the upgrade software is downloading, press the .

By Online

Your product must be connected to the Internet to use the By Online function. Remove all discs before you begin.

1. Select **By Online**, and then press the  button. The Connecting to Server message appears.
2. If an update is available, a popup message appears asking if you want to upgrade. If you select **Yes**, the product turns off automatically, turns on, and then begins the upgrade.

| IMPORTANT |

- ▶ Never turn the home theater on or off manually during a software upgrade.
- 3 · The update progress popup appears. When the update is completed, the product turns off automatically again.
 - 4 · Press the **POWER** button to turn on the product.

| NOTE |

- ▶ The update is complete when the product turns off after restarting. Press the **POWER** button to turn on the updated product for your use.
- ▶ Never turn the product off or on manually during the update process.
- ▶ Samsung Electronics takes no legal responsibility for a product malfunction caused by an unstable internet connection or consumer negligence during software upgrade.

By USB

- 1 · Visit www.samsung.com.
- 2 · Click **SUPPORT** on the top right of the page.
- 3 · Enter the product's model number into the search field, and then click **Find Product**.
- 4 · Click **Get downloads** in the center of the page below the Downloads header.
- 5 · Click **Firmware** in the center of the page.
- 6 · Click the **ZIP** icon in the File column on the right side of the page.
- 7 · Click **OK** in the pop-up that appears to download and save the firmware file to your PC.
- 8 · Unzip the zip archive to your computer. You should have a single folder with the same name as the zip file.
- 9 · Copy the folder to a USB flash drive.
- 10 · Make sure no disc is inserted in the product, and then insert the USB flash drive into the USB port of the product.
- 11 · In the product's menu, go to **Settings > Support > Software Upgrade**.
- 12 · Select **By USB**.

| NOTE |

- ▶ There should be no disc in the product when you upgrade the software using the USB Host jack.
- ▶ Never turn the product off or on manually during the update process.
- ▶ When the software upgrade is done, check the software details in the **Software Upgrade** menu.

Auto Upgrade Notification

If your product is connected to the network and you set Auto Upgrade Notification on, the product will notify you if a new software version is available with a pop-up message.

- 1 · Turn on the product.
- 2 · In the Software Upgrade menu, set **Auto Upgrade Notification to On**.
If there is a new software version available, the product will notify you with a pop-up message.
- 3 · To upgrade the firmware, select **Yes**. The product turns off automatically, turns on, and then begins the upgrade.
- 4 · The update progress popup will appear. When the update is complete, the product will turn off automatically again.
- 5 · Press the **POWER** button to turn on the product.

| NOTE |

- ▶ The update is complete when the product turns off after restarting. Press the **POWER** button to turn on the updated product for your use. Never turn the product on or off manually during the update process.
- ▶ Samsung Electronics shall take no legal responsibility for product malfunction caused by unstable of internet connection or consumer negligence during software upgrade.

Setting Up AllShare

AllShare enables you to play music, video and photo files in your PC using the product. To use AllShare, you must connect the product to your PC via the network (See page 17) and install the SAMSUNG PC Share Manager on the PC.

To Download the AllShare Software

To use AllShare with your PC, you must install AllShare software on your PC. You can download the PC software and get detailed instructions for using AllShare from the Samsung.com website.

- 1 · Go to www.samsung.com.
- 2 · Click **SUPPORT** at the top of the page.
- 3 · On the Support page, enter the model number of your product into the **Model Number** field, and then press the  button.
- 4 · On the page that appears, click **Get downloads** on the left side under **Downloads**. The **Download Center** appears.
- 5 · On the **Download Center** page, click the **Software** tab.
- 6 · On the software tab, click the **File icon** on the right side of the AllShare line.
- 7 · In the pop-up that appears, click **Save File**.
- 8 · Find the AllShare install file on your disk, and then double click the file.
- 9 · In the pop-up that appears, click **Run**, and then follow the directions that appear on your screen.

Download the AllShare Installation/Instruction manual from the same Software Tab by clicking the corresponding PDF file symbol in the File column on the right. The file, in PDF format, will download and open. Follow the directions to install and setup AllShare. You can view and/or save the file.





| NOTE |

- ▶ To use AllShare with your smartphone, you need to connect your set & smartphone to the same router.

Using the Streaming Media Services

- To use the Streaming Media Services, your home theater must be connected to the Internet. You also may need a vendor account for some services.

Use the ▲▼◀▶ buttons in the Home menu to move to the desired service, and then press the  button.

	Netflix. You can view movies streamed by Netflix.
	Vudu. You can view HD movies streamed by Vudu.
	CinemaNow. You can view movies streamed by CinemaNow.
	Pandora. You can listen to Internet radio.
	YouTube. You can view video streamed by YouTube.





Playing Files on a USB Device

You can play multimedia files located on a connected USB device.

- Move to the Home menu.
- In Stop mode, connect the USB storage device to the USB port on the front panel of the product. The message “Do you want to access the device?” will be displayed.
- Press the ◀▶ button to select **Yes**, then press the  button.

- Press the **RED (A)** button.







- Press the ▲▼ buttons to select USB Flash Mem or Disk, then press the  button.
- Press the ◀▶ buttons to select **Videos**, **Music** or **Photos**, then press the  button.
- If files appear on the screen go to Step 8. If file folders appear on the screen, use the ▲▼◀▶ buttons to select a folder, press , and then go to Step 8.
- Use the ▲▼◀▶ buttons to select a file to play or view, and then press the  button.

OR

- Press the **BLUE (D)** button.



- Press the ◀▶ buttons to select USB Flash Mem or Disk, then press the  button.
- Press the ▲▼ buttons to select **Videos**, **Music** or **Photos**, then press the  button.
- If files appear on the screen go to Step 8¹. If file folders appear on the screen, use the ▲▼◀▶ buttons to select a folder, press , and then go to Step 8¹.
- Use the ▲▼◀▶ buttons to select a file to play or view, and then press the  button.





Media Play

| NOTE |





- ▶ To prevent possible damage to the USB memory, you must remove the USB storage device safely using the "Safely Remove USB" function. Press the **HOME** button to move to the Home menu, select the **YELLOW (C)** button, and then press the  button.
- ▶ To listen to your music files with 5.1 channel sound, you must set the Dolby Pro Logic II mode to MATRIX. (See page 34)

Playing a Disc with User Recorded Content

You can play multimedia files you have recorded on DVD or CD discs.

- 1 · Turn on the home theater.
- 2 · Open the disc tray, place a user recorded disc into the disc tray with the disc's label facing up, and then close the tray.
- 3 · After the disc loads, press the **RED (A)** button.
- 4 · Press the **▲▼** buttons to select **CD** or **DVD**, and then press the  button.
- 5 · Press the **◀▶** buttons to select **Videos**, **Music**, or **Photos**, then press the  button.
- 6 · If files appear on the screen, go to Step 7. If file folders appear on the screen, use the **◀▶** buttons to select a folder, press , and then go to Step 7.
- 7 · Use the **◀▶** buttons to select a file to play or view, and then press the  button.

OR

- 3¹ · After the disc loads, press the **BLUE (D)** button.
- 4¹ · Press the **◀▶** buttons to select **CD** or **DVD**, and then press the  button.
- 5¹ · Press the **▲▼** buttons to select **Videos**, **Music**, or **Photos**, and then press the  button.
- 6¹ · If files appear on the screen go to Step 7¹. If file folders appear on the screen, use the **▲▼** buttons to select a folder, press , and then go to Step 7¹.
- 7¹ · Use the **▲▼** buttons to select a file to play or view, and then press the  button.

Playing a Commercial Video Disc

Place a disc into the disc tray with the disc's label facing up and then close the disc tray. Playback starts automatically. If it does not playback automatically, move to **Videos** in the Home menu and press the  button.

In most cases, commercial videos will display a disc menu. To play the movie on the disc, select **Play** on the disc menu, and then press .

| NOTE |

- ▶ For more information about playing videos, go to "Controlling Video Playback" on page 31.

Playing a Pre-Recorded Commercial Audio Disc

- 1 · Insert an Audio CD (CD-DA) or an MP3 Disc into the disc tray.
 - For an Audio CD (CD-DA), the first track will be played automatically. Tracks on a disc are played in the order in which they were recorded on the disc.
 - For an MP3 disc, press the **◀▶** buttons to select **Music**, then press the  button.

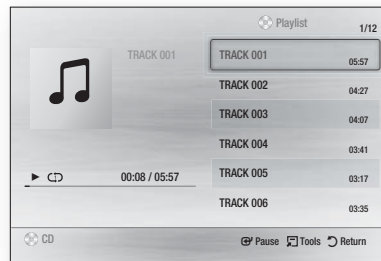

- 2 · To play a particular track, use the **▲▼** buttons on the remote to select the track, and then press the  button.

| NOTE |

- ▶ For more information about playing music, go to "Controlling Music Playback" on page 32.

Controlling Video Playback

You can control the playback of video files located on Blu-ray, DVD, and CD discs, and on USB storage devices. Depending on the media, some of the functions described in this manual may not be available.

Buttons on the Remote Control used for Video Playback



■ Playback related buttons

The product does not play sound in Search, Slow, or Step mode.

	Starts playback.
	Stops playback.
	Pauses playback.
Fast Motion Play	During playback, press the or button. Each time you press the or button, the playback speed will change.
Slow Motion Play	In pause mode, press the button. Each time you press the button, the playback speed will change.
Step Motion Play	In pause mode, press the button. Each time you press the button, a new frame appears.
Skip Motion Play	During playback, press the or button. Each time you press or button, the disc moves to the previous or next chapter or file.

■ Using the disc menu, title menu, popup menu and title list

DISC MENU	During playback, press this button to display the Disc menu.
TITLE MENU	During playback, press this button to display the Title menu. <ul style="list-style-type: none"> If your disc has a playlist, press the GREEN (B) button to go to the playlist.
POPUP MENU	During playback, press this button to display the Pop-up menu.
DISC MENU or TITLE MENU	During playback, press this button to display the title list.

Media Play

Using the TOOLS Menu

During playback, press the **TOOLS** button.

Title	If the movie or video have more than one title, move to or select a desired title.
Playing Time	Select to move to the specific playback point. Use the numeric buttons to input the playback point.
Full Screen	Select to set the desired full screen size. You can select Original, Mode1 (larger), and Mode2 (largest).
Picture Setting	Select to set the picture mode. - Picture Mode <ul style="list-style-type: none"> ▪ Normal : Choose this setting for most viewing applications. ▪ Movie : This is the best setting for watching movies. ▪ User : Lets you adjust the sharpness and noise reduction function respectively. ▪ Dynamic : Choose this setting to increase Sharpness.

Menu that appears only when a BD/DVD disc plays

Chapter	Select to move to a chapter that you desire to watch.
Repeat	Select to repeat a specific title, chapter (BD/DVD discs only) or marked section.
Audio	Select to set the desired audio language.
Subtitle	Select to set the desired subtitle language.
Angle	To view a scene from another angle. The Angle option displays the number of angles available to view (1/1, 1/2, 1/3, etc.).
BONUSVIEW Video / BONUSVIEW Audio	Select to set the desired bonusview option.

| NOTE |

- ▶ Depending on the disc or storage device, the Tools menu may differ. All options may not be displayed.

Creating a Video Playlist

You can create a playlist of video files in a way that is nearly identical to the way you create a playlist of music files. For instructions, see "Creating a Music Playlist" on page 33.

Controlling Music Playback

You can control the playback of music content located on DVDs, CDs, and USB storage devices.

Buttons on the Remote Control used for Music Playback

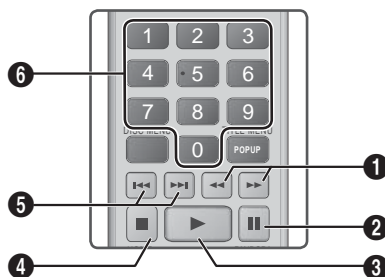

	Fast Play (Audio CD (CD-DA) only)
1	During playback, press the ◀◀ or ▶▶ button. Each time you press the ◀◀ or ▶▶ button, the playback speed will change.
2	⏸ button : Pause a track.
3	▶ button : Plays the currently selected track.
4	⏹ button : Stops a track.
5	Skip : During playback, press the ◀◀ or ▶▶ button to move to the previous or next music of listed.
6	NUMBER buttons : During Playlist playback, press the desired track number. The selected track is played.

Repeating Tracks



You can set the product to repeat tracks.

- 1 · During music playback, press the **TOOLS** button.
- 2 · Use ◀▶ button to select **Off**, **Track** or **One**, **All** or **Shuffle** in **Repeat Mode**, and then press the  button.

Creating a Music Playlist

- 1 · If playing music from a commercial CD or DVD, press the  or **RETURN** (⏪) button. The Music List Screen appears. If you are creating a playlist from music on a user created disk or USB device, access the Music list as described in "Playing Files on a USB Device" on page 29 or "Playing a Disc with User Recorded Content" on page 30.
- 2 · Press the ▲▼◀▶ buttons to move to the desired file, and then press the **YELLOW (C)** button to select it. Repeat this procedure to select additional files.



- 3 · To remove a file from the Playlist, move to the file, and then press the **YELLOW (C)** button.
- 4 · Press the  button to play the selected files. The Playlist screen appears.
- 5 · To go to the Music List, press the  or **RETURN** (⏪) button.
- 6 · To go back to the Playlist, press the  button.

| NOTE |

- ▶ You can create a playlist with up to 99 tracks on Audio CDs (CD-DA).

- ▶ If you go to the Music List from the Playlist, and then return to the Playlist, the Playlist will start playing again from the beginning.

Controlling Photo Playback

You can control the playback of photos located on DVDs, CDs, and USB storage devices.

Using the Tools Menu

During playback, press the **TOOLS** button.

Start Slide Show	Select to start a slide show.
Slide Show Speed	Select to adjust the slide show speed.
Background Music	Select to listen to music while viewing a slide show.
Zoom	Select to enlarge the current picture. (Enlarge up to 4 times)
Rotate	Select to rotate a picture. (This will rotate the picture either clockwise or counter clockwise.)
Information	Shows the picture information including the name and size, etc.

| NOTE |

- ▶ Depending on the disc or storage device, the Tools menu may differ. All options may not be displayed.
- ▶ To enable the background music function, the photo file must be in the same storage media as the music file. However, the sound quality can be affected by the bitrate of the MP3 file, the size of the photo, and the encoding method.



Creating a Photo Playlist

You can create a playlist of photos in a way that is nearly identical to the way you create a playlist of music files. For instructions, see "Creating a Music Playlist" on this page.

Media Play

Listening to Radio

Using Buttons on the Remote Control

1. Press the **FUNCTION** button to select **FM**.
2. Tune in to the desired station.
 - Preset Tuning 1 : Press the  button to select **PRESET** and then press the **TUNING UP, DOWN** button to select the preset station.
 - Before you can tune to preset stations, you must add preset stations to the product's memory.
 - Manual Tuning : Press the  button to select **MANUAL** and then press the **TUNING UP, DOWN** button to tune in to a lower or higher frequency.
 - Automatic Tuning : Press the  button to select **MANUAL** and then press and hold the **TUNING UP, DOWN** button to automatically search the band.

Setting Mono/Stereo

Press the **MO/ST** button.

- Each time the button is pressed, the sound switches between **STEREO** and **MONO**.
- In a poor reception area, select **MONO** for a clear, interference-free broadcast.

Presetting Stations

Example : Presetting FM 89.10 into memory.

1. Press the **FUNCTION** button to select **FM**.
2. Press the **TUNING UP, DOWN** button to select <89.10>.
3. Press the **TUNER MEMORY** button.
 - **NUMBER** flashes on the display.
4. Press the **TUNER MEMORY** button again.
 - Press the **TUNER MEMORY** button before **NUMBER** disappears from the display on its own.
 - After you press the **TUNER MEMORY** button, **NUMBER** disappears from the display and the station is stored in memory.

5. To preset another station, repeat steps 2 to 4.
 - To tune in to a preset station, press the **TUNING UP, DOWN** button.

Using the Special Effects Remote Control Buttons

SOUND EFFECT Function

SOUND
EFFECT

Lets you select a mode that optimizes the sound.

MP3 ENHANCER → SMART VOLUME → POWER BASS → OFF

- **MP3 ENHANCER** : Helps enhance your sound experience (ex. mp3 music). You can upscale your MP3 level sound (24 kHz, 8bit) to CD level sound (44.1 kHz, 16bit).
- **SMART VOLUME** : Regulates and stabilizes the volume level, preventing drastic volume changes when you change channels or during scene transitions.
- **POWER BASS** : Increases the volume level of bass tones and provides thudding sound effects.
- **OFF** : Select this for normal listening.

Dolby Pro Logic II Function

DOLBY
II





You can select the desired Dolby Pro Logic II audio mode.

- **MOVIE** : Adds realism to a movie soundtrack.
- **MUSIC** : When listening to music, you can experience sound effects as if you are listening to the actual performance.
- **MATRIX** : Select to hear multi channel surround sound.
- **PROLOG** : Select to listen to a 2CH sound source in 5.1CH surround sound with all speakers active.
 - A specific speaker(s) may not output depending on the input signal.

Using BD-LIVE™

- 1 · Connect the product to the network.
(See page 17)
- 2 · Configure the network settings.
(See pages 25–26)

Once the product is connected to your network, you can enjoy various movie-related service contents available on BD-LIVE compliant discs.

- 1 · Attach a USB memory stick to the USB jack on the front of the product, and then use BD Data Management to check its remaining memory. The memory device must have at least 1GB of free space to accommodate the BD-LIVE services.
- 2 · Select **Settings** on the Home screen, and then press the  button.
- 3 · Select **System**, and then press the  button.
- 4 · Select **BD Data management**, and then press the  button.
- 5 · Select **Change Device**, and then press the  button.
- 6 · Select **USB DISK**, and then press the  button.
- 7 · Insert a Blu-ray Disc that supports BD-LIVE.
- 8 · Select an item from the list of BD-LIVE service contents provided by the disc manufacturer.

| NOTE |





- ▶ The way you use BD-LIVE and the provided contents may differ, depending on the disc manufacturer.

Using AllShare

AllShare lets you access and play files located on your PC through your home theater.

Follow the directions in the AllShare user's guide to setup AllShare on your PC and to tag folders and files you want to share with the home theater.

To access and play files located on your PC after you have setup AllShare, follow these steps:

- 1 · Turn on your PC, your TV, and the home theater.
- 2 · Make sure the AllShare Shared server is running on your PC.
- 3 · On your home theater, press the **BLUE (D)** button (View Devices).
- 4 · Use the  button to select your PC in the Device List.
- 5 · Select the kind of file you want to view or play, Videos, Photos, or Music, and then press .
- 6 · Use the  button to select the folder with the kind of files you selected, and then press . The File List is displayed.
- 7 · Select the file you want to view or play, and then press .

| NOTE |

- ▶ You can create Playlists from files on your PC in the same way you create playlists from files on USB devices and discs.
- ▶ With a few exceptions, you can control the playback of files on your PC in the same fashion you control the playback of files on USB devices and discs.
- ▶ You can also access files on you PC by first selecting Videos, Photos, or Music on the Home screen, and then selecting your PC from the device list that appears.

Additional Information

Note

Connections	HDMI OUT
	<ul style="list-style-type: none"> • Certain HDMI output resolutions may not work, depending on your TV. • A long HDMI cable may cause screen noise. If this occurs, set HDMI Deep Color to Off in the menu.
Settings	TV Aspect
	<ul style="list-style-type: none"> • Depending on the disc type, some aspect ratios may not be available. • If you select an aspect ratio and option which is different than the aspect ratio of your TV screen, then the picture might appear to be distorted. • If you select the 16:9 Original, your TV may display 4:3 Pillarbox (black bars on sides of picture).
	BD Wise (Samsung Products only)
	<ul style="list-style-type: none"> • When BD Wise is on, the Resolution setting automatically defaults to BD Wise and BD Wise appears in the Resolution menu. • If the product is connected to a device that does not support BD Wise, you can not use the BD Wise function. • For proper operation of BD Wise, set the BD Wise option in both the product and the TV to On.
	Digital Output
	<ul style="list-style-type: none"> • Be sure to select the correct Digital Output or you will hear no sound or just loud noise. • If the HDMI device (AV receiver, TV) is not compatible with compressed formats (Dolby digital, DTS), the audio signal outputs as PCM. • Regular DVDs do not have BONUSVIEW audio and Navigation Sound Effects. • Some Blu-ray Discs do not have BONUSVIEW audio and Navigation Sound Effects. • This Digital Output setup does not affect the analog (L/R) audio or HDMI audio output to your TV. It affects the optical and HDMI audio output when your product is connected to an AV receiver. • If you play MPEG audio soundtracks, the audio signal outputs as PCM regardless of your Digital Output selections (PCM or Bitstream).
	BD-LIVE Internet Connection
	<ul style="list-style-type: none"> • The Internet connection may be restricted while you are using BD-LIVE contents.
	Anynet+(HDMI-CEC)
	<ul style="list-style-type: none"> • Depending on your TV, certain HDMI output resolutions may not work. Please refer to the user manual of your TV. • This function is not available if the HDMI cable does not support CEC. • If your Samsung TV has an Anynet+ logo, then it supports the Anynet+ function.

Settings	BD Data Management
	<ul style="list-style-type: none"> • In the external memory mode, disc playback may be stopped if you disconnect the USB device in the middle of playback. • Only those USB devices formatted in the FAT file system (DOS 8.3 volume label) are supported. We recommend you use USB devices that support USB 2.0 protocol with 4 MB/sec or faster read/write speed. • The Resume Play function may not work after you format the storage device. • The total memory available to BD Data Management may differ, depending on the conditions.
	Speaker Settings
	<ul style="list-style-type: none"> • When Speaker Selection is set to TV Speaker, audio is produced through the TV speakers.
	HDMI audio
	<ul style="list-style-type: none"> • When HDMI audio is outputted to the TV speaker, it is automatically down-mixed to 2 channels.
Playback	Audio Return Channel
	<ul style="list-style-type: none"> • When Anynet+ (HDMI-CEC) is Off, the Audio Return Channel function is not available. • Using an HDMI cable not certified for ARC (Audio Return Channel) may cause a compatibility problem. • The ARC function is only available if an ARC-compliant TV is connected.
	Digital Output
	<ul style="list-style-type: none"> • Digital Output can be activated when Speaker Selection is selected to TV Speaker.
	Playing a Video files
	<ul style="list-style-type: none"> • Video files with high bitrates of 20Mbps or more strain the product's capabilities and may stop playing during playback.
Playback	Selecting the Audio Language
	<ul style="list-style-type: none"> • The ◀▶ indicator will not appear on the screen if the BONUSVIEW section does not contain any BONUSVIEW audio settings. • The languages available through the Audio Language function depend on the languages that are encoded on the disc. This function or certain languages may not be available. • Some Blu-ray Discs may allow you to select either the PCM or Dolby digital audio soundtrack in English.
	Selecting the Subtitle Language
<ul style="list-style-type: none"> • Depending on the Blu-ray Disc / DVD, you may be able to change the subtitle language in the Disc Menu. Press the DISC MENU button. • This function depends on the selection of subtitles that are encoded on the disc and may not be available on all Blu-ray Discs/DVDs. • Information about the main feature BONUSVIEW mode will also appear if the Blu-ray Disc has a BONUSVIEW section. • This function changes both the primary and secondary subtitles at the same time. • The total number of primary and secondary subtitles are displayed respectively. 	

Appendix

Playback	Playing a JPEG files
	<ul style="list-style-type: none"> You can't enlarge the subtitle and PG graphic in the full screen mode.
Media Play	Dolby Pro Logic II Mode
	<ul style="list-style-type: none"> Before selecting Dolby Pro Logic II mode, connect your external device to the AUDIO INPUT jacks (L and R) on the product. If you connect to only one of the inputs (L or R), you cannot listen to surround sound.
	Using the TOOLS button while playing pictures
	<ul style="list-style-type: none"> If the system is connected to a BD Wise compliant TV that has set BD Wise to On, the Picture Settings menu will not appear. The Background Music function will not work unless the music file and the photo file are located on the same storage media. Also, sound quality can be impacted by the bitrate of the MP3 music file, the size of the photos, and the encoding method.
	Playing back a USB Storage Device
	<ul style="list-style-type: none"> You must remove the USB storage device safely (by performing the "Safely Remove USB" function) to prevent possible damage to the USB memory. Press the HOME button to move to the Home menu, select the YELLOW (C) button, and then press the  button.

Resolution according to the output mode

□ Blu-ray Disc/E-contents/Digital Contents playback

Setup \ Output	HDMI/connected			HDMI/not connected
	HDMI Mode		VIDEO Mode	VIDEO Mode
	Blu-ray Disc	E-contents/ Digital contents		
BD Wise	Resolution of Blu-ray Disc	1080p@60F	480i	-
Auto	Max. Resolution of TV input	Max. Resolution of TV input	480i	-
1080p@60F	1080p@60F	1080p@60F	480i	-
Movie Frame : Auto (24Fs)	1080p@24F	1080p@24F	480i	-
1080i	1080i	1080i	480i	480i
720p	720p	720p	480i	480i
480p	480p	480p	480i	480i
480i	-	-	-	480i

□ DVD playback

Setup \ Output	HDMI/connected		HDMI/not connected
	HDMI Mode	VIDEO Mode	VIDEO Mode
BD Wise	480i	480i	-
Auto	Max. Resolution of TV input	480i	-
1080p@60F	1080p@60F	480i	-
1080i	1080i	480i	480i
720p	720p	480i	480i
480p	480p	480i	480i
480i	-	-	480i

Appendix

Digital Output Selection

Setup	PCM	Bitstream (Unprocessed)	Bitstream (Re-encoded DTS)	Bitstream (Re-encoded Dolby D)	
Connection	HDMI supported AV receiver				
Audio Stream on Blu-ray Disc	PCM	Up to PCM 7.1ch	PCM	DTS re-encoded	Re-encoded Dolby Digital *
	Dolby Digital	Up to PCM 7.1ch	Dolby Digital	DTS re-encoded	Re-encoded Dolby Digital *
	Dolby Digital Plus	Up to PCM 7.1ch	Dolby Digital Plus	DTS re-encoded	Re-encoded Dolby Digital *
	Dolby TrueHD	Up to PCM 7.1ch	Dolby TrueHD	DTS re-encoded	Re-encoded Dolby Digital *
	DTS	Up to PCM 6.1ch	DTS	DTS re-encoded	Re-encoded Dolby Digital *
	DTS-HD High Resolution Audio	Up to PCM 7.1ch	DTS-HD High Resolution Audio	DTS re-encoded	Re-encoded Dolby Digital *
	DTS-HD Master Audio	Up to PCM 7.1ch	DTS-HD Master Audio	DTS re-encoded	Re-encoded Dolby Digital *
Audio Stream on DVD	PCM	PCM 2ch	PCM 2ch	PCM 2ch	PCM 2ch
	Dolby Digital	Up to PCM 5.1ch	Dolby Digital	Dolby Digital	Dolby Digital
	DTS	Up to PCM 6.1ch	DTS	DTS	DTS
Definition for Blu-ray Disc	Any	Decodes the main feature audio and BONUSVIEW audio stream together into PCM audio and adds Navigation Sound Effects.	Outputs only the main feature audio stream so that your AV receiver can decode the audio bitstream. You will not hear BONUSVIEW audio or Navigation Sound Effects.	Decodes the main feature audio and BONUSVIEW audio stream together into PCM audio and adds Navigation Sound Effects, then re-encodes the PCM audio into DTS bitstream.	Decodes the main feature audio and BONUSVIEW audio stream together into PCM audio and adds Navigation Sound Effects, then re-encodes the PCM audio into Dolby digital bitstream or PCM.

* If the Source Stream is 2ch or mono, "Re-encoded Dolby D" Setting are not applied. Output will be PCM 2ch.

Blu-ray Discs may include three audio streams :

- Main Feature Audio : The audio soundtrack of the main feature.
- BONUSVIEW audio : An additional soundtrack such as the director or actor's commentary.
- Navigation Sound Effects: Sound effects that occur when you navigate the disc's or movie's menu. Navigation Sound Effects are different on each Blu-ray disc.

Troubleshooting

Refer to the table below when this product does not function properly. If the problem you are experiencing is not listed below or if the instructions below do not help, turn off the product, disconnect the power cord, and contact Samsung Electronics at 1-800-SAMSUNG (1-800-726-7864).

Symptom	Check/Remedy
I cannot eject the disc.	<ul style="list-style-type: none"> Is the power cord plugged securely into the outlet? Turn off the power and then turn it back on.
Playback does not start.	<ul style="list-style-type: none"> Check the region number of the Blu-ray/DVD disc. A Blu-ray/DVD disc purchased from abroad may not be playable. CD-ROMs and DVD-ROMs cannot be played on this product. Make sure that the rating level is correct.
Playback does not start immediately when the Play/Pause button is pressed.	<ul style="list-style-type: none"> Are you using a deformed disc or a disc with scratches on the surface? Wipe the disc clean.
Sound is not produced.	<ul style="list-style-type: none"> The home theater does not play sound during fast playback, slow playback, and step motion playback. Are the speakers connected properly? Is the speaker setup correctly customized? Is the disc severely damaged?
Sound can be heard only from a few speakers and not all 6.	<ul style="list-style-type: none"> On certain Blu-ray/DVD discs, sound is output from the front speakers only. Check if the speakers are connected properly. Adjust the volume. When listening to a CD, radio or TV, sound is output to the front speakers only.
Dolby Digital 5.1 CH Surround Sound is not produced.	<ul style="list-style-type: none"> Is there "Dolby Digital 5.1 CH" mark on the disc? Dolby Digital 5.1 CH Surround Sound is produced only if the disc is recorded with 5.1 channel sound. Is the audio language correctly set to Dolby Digital 5.1-CH in the information display?
The remote control does not work.	<ul style="list-style-type: none"> Are you operating the remote within its operational range and within the proper angle relative to the sensor? Are the batteries drained?
<ul style="list-style-type: none"> The disc is rotating but no picture is produced. Picture quality is poor and picture is shaking. 	<ul style="list-style-type: none"> Is the TV power on? Are the video cables connected properly? Is the disc dirty or damaged? A poorly manufactured disc may not be playable.
Audio language and subtitles do not work.	<ul style="list-style-type: none"> Audio language and subtitles will not work if the disc does not contain them.
The menu screen does not appear even when the menu function is selected.	<ul style="list-style-type: none"> Are you using a disc that does not contain menus?

Appendix

Symptom	Check/Remedy
The aspect ratio cannot be changed.	<ul style="list-style-type: none"> You can play 16:9 Blu-ray/DVD discs in 16:9 Full mode, 4:3 Letter Box mode, or 4:3 Pan-Scan mode, but 4:3 Blu-ray/DVD discs are played in 4:3 ratio only. Refer to the Blu-ray Disc jacket and then select the appropriate function.
• The product is not working.	<ul style="list-style-type: none"> Press and hold the remote control's RESET button for 5 seconds in NO DISC mode. <ul style="list-style-type: none"> - Using the RESET function will erase all stored settings. Do not use this unless necessary.
You have forgotten the rating level password.	<ul style="list-style-type: none"> With no disc in the product, press and hold the product's RESET button for longer than 5 seconds. INIT appears on the display and all settings will return to the default values. Then, press the POWER button. <ul style="list-style-type: none"> - Using the RESET function will erase all stored settings. Do not use this unless necessary.
Can't receive radio broadcasts.	<ul style="list-style-type: none"> Is the antenna connected properly? If the antenna's input signal is weak, install an external FM antenna in an area with good reception.
While listening to TV audio through the Product, no sound is heard.	<ul style="list-style-type: none"> If the OPEN/CLOSE button is pressed while listening to TV audio using the D. IN or AUX functions, the Blu-ray/DVD disc functions are turned on and the TV audio is muted.
"Not Available" appears on screen.	<ul style="list-style-type: none"> The features or action cannot be completed at this time because: <ol style="list-style-type: none"> The Blu-ray/DVD disc's software restricts it. The Blu-ray/DVD disc's software doesn't support the feature (e.g., angles) The feature is not available at the moment. You've requested a title or chapter number or search time that is out of range.
If the HDMI output is set to a resolution your TV cannot support (for example, 1080p), you may not see a picture on your TV.	<ul style="list-style-type: none"> Press and hold the RESET button on front panel for more than 5 seconds with no disc inserted. All settings will revert to the factory settings.
No HDMI output.	<ul style="list-style-type: none"> Check the connection between the TV and the HDMI jack of the product. Check if your TV supports 480p/720p/1080i/1080p HDMI input resolution.
Abnormal HDMI output screen.	<ul style="list-style-type: none"> If random noise appears on the screen, it means that TV does not support HDCP (High-bandwidth Digital Content Protection).

Symptom	Check/Remedy
AllShare Play function	
I can see folders shared through AllShare Play, but I cannot see the files.	<ul style="list-style-type: none"> AllShare Play shows only files corresponding to the Photo, Music, and Movie categories. Files that do not correspond to these categories may not be displayed.
Video is played intermittently.	<ul style="list-style-type: none"> Check if the network is stable. Check if the network cable is properly connected and if the network is not overloaded.
The AllShare Play connection between the TV and PC is unstable.	<ul style="list-style-type: none"> IP addresses under the same subnetwork should be unique, otherwise IP collision can result in such a phenomenon. Check if you have a firewall enabled. If so, disable the firewall function.
BD-LIVE	
I cannot connect to the BD-LIVE server.	<ul style="list-style-type: none"> Test whether the network connection is active by using the Network Status function. Check whether a USB memory device is connected to the product. The memory device must have at least 1GB of free space to accommodate the BD-LIVE service. You can check the available size in BD Data Management. (See page 37) See if the BD-LIVE Internet Connection option is set to Allow(All). If all above fails, contact the contents provider or update to the latest firmware.
When using the BD-LIVE service, an error occurs.	<ul style="list-style-type: none"> The memory device must have at least 1GB of free space to accommodate the BD-LIVE service. You can check the available size in BD Data Management. (See page 37)

| NOTE |

- ▶ When the factory default settings are restored, all stored user BD data will be deleted.

Repairs

If you contact us to repair your product, an administration fee may be charged if either:

1. An engineer is called out to your home at your request and there is no defect in the product.
2. You bring the unit to a repair center and there is no defect in the product.

We will provide you with the amount of the administration fee before we make a home visit or begin any work on your product.

We recommend you read this manually thoroughly, search for a solution on line at www.samsung.com, or contact Samsung Customer Care at 1-800-SAMSUNG (726-7864) before seeking to repair your product.

Speaker	Speaker system	5.1ch speaker system			
		Front	Surround	Center	Subwoofer
	Impedance	3 Ω	3 Ω	3 Ω	3 Ω
	Frequency range	140Hz~20kHz	140Hz~20kHz	140Hz~20kHz	40Hz ~ 160Hz
	Output sound pressure level	87dB/W/M	87dB/W/M	87dB/W/M	88dB/W/M
	Rated input	80W	80W	80W	100W
	Maximum input	160W	160W	160W	200W
	Dimensions (W x H x D)	Front : 3.03 x 4.25 x 2.75 inches Surround : 3.03 x 4.25 x 2.75 inches Center : 8.97 x 3.03 x 2.75 inches Subwoofer : 6.10 x 11.81 x 11.22 inches			
	Weights	Front : 0.78 lbs, Surround : 0.84 lbs Center : 1.08 lbs, Subwoofer : 6.36 lbs			

- Samsung Electronics Co., Ltd reserves the right to change the specifications without notice.
- Weight and dimensions are approximate.
- Design and specifications are subject to change without prior notice.
- Dispose of unwanted electronics through an approved recycler.
To find the nearest recycling location, go to our website: www.samsung.com/recyclingdirect or call, (877) 278 - 0799

LIMITED WARRANTY TO ORIGINAL PURCHASER

This SAMSUNG brand product, as supplied and distributed by SAMSUNG and delivered new, in the original carton to the original consumer purchaser, is warranted by SAMSUNG against manufacturing defects in materials and workmanship for a limited warranty period of:

One (1) Year Parts and Labor* **(*90 Days Parts and Labor for Commercial Use)**

This limited warranty begins on the original date of purchase, and is valid only on products purchased and used in the United States. To receive warranty service, the purchaser must contact SAMSUNG for problem determination and service procedures. Warranty service can only be performed by a SAMSUNG authorized service center. The original dated bill of sale must be presented upon request as proof of purchase to SAMSUNG or SAMSUNG's authorized service center. Transportation of the product to and from the service center is the responsibility of the purchaser.

SAMSUNG will repair or replace this product, at our option and at no charge as stipulated herein, with new or reconditioned parts or products if found to be defective during the limited warranty period specified above. All replaced parts and products become the property of SAMSUNG and must be returned to SAMSUNG. Replacement parts and products assume the remaining original warranty, or ninety (90) days, whichever is longer.

SAMSUNG's obligations with respect to software products distributed by SAMSUNG under the SAMSUNG brand name are set forth in the applicable end user license agreement. Non-SAMSUNG hardware and software products, if provided, are on an "AS IS" basis.

Non-SAMSUNG manufacturers, suppliers, publishers, and service providers may provide their own warranties.

This limited warranty covers manufacturing defects in materials and workmanship encountered in normal, and except to the extent otherwise expressly provided for in this statement, noncommercial use of this product, and shall not apply to the following, including, but not limited to: damage which occurs in shipment; delivery and installation; applications and uses for which this product was not intended; altered product or serial numbers; cosmetic damage or exterior finish; accidents, abuse, neglect, fire, water, lightning or other acts of nature; use of products, equipment, systems, utilities, services, parts, supplies, accessories, applications, installations, repairs, external wiring or connectors not supplied and authorized by SAMSUNG, or which damage this product or result in service problems; incorrect electrical line voltage, fluctuations and surges; customer adjustments and failure to follow operating instructions, cleaning, maintenance and environmental instructions that are covered and prescribed in the instruction book; product removal or reinstallation; reception problems and distortion related to noise, echo, interference or other signal transmission and delivery problems. SAMSUNG does not warrant uninterrupted or error-free operation of the product.

THERE ARE NO EXPRESS WARRANTIES OTHER THAN THOSE LISTED AND DESCRIBED ABOVE, AND NO WARRANTIES WHETHER EXPRESS OR IMPLIED, INCLUDING, BUT NOT LIMITED TO, ANY IMPLIED WARRANTIES OF MERCHANTABILITY OR FITNESS FOR A PARTICULAR PURPOSE, SHALL APPLY AFTER THE EXPRESS WARRANTY PERIODS STATED ABOVE, AND NO OTHER EXPRESS WARRANTY OR GUARANTY GIVEN BY ANY PERSON, FIRM OR CORPORATION WITH RESPECT TO THIS PRODUCT SHALL BE BINDING ON SAMSUNG. SAMSUNG SHALL NOT BE LIABLE FOR LOSS OF REVENUE OR PROFITS, FAILURE TO REALIZE SAVINGS OR OTHER BENEFITS, OR ANY OTHER SPECIAL, INCIDENTAL OR CONSEQUENTIAL DAMAGES CAUSED BY THE USE, MISUSE OR INABILITY TO USE THIS PRODUCT, REGARDLESS OF THE LEGAL THEORY ON WHICH THE CLAIM IS BASED, AND EVEN IF SAMSUNG HAS BEEN ADVISED OF THE POSSIBILITY OF SUCH DAMAGES. NOR SHALL RECOVERY OF ANY KIND AGAINST SAMSUNG BE GREATER IN AMOUNT THAN THE PURCHASE PRICE OF THE PRODUCT SOLD BY SAMSUNG AND CAUSING THE ALLEGED DAMAGE. WITHOUT LIMITING THE FOREGOING, PURCHASER ASSUMES ALL RISK AND LIABILITY FOR LOSS, DAMAGE OR INJURY TO PURCHASER AND PURCHASER'S PROPERTY AND TO OTHERS AND THEIR PROPERTY ARISING OUT OF THE USE, MISUSE OR INABILITY TO USE THIS PRODUCT SOLD BY SAMSUNG NOT CAUSED DIRECTLY BY THE NEGLIGENCE OF SAMSUNG. THIS LIMITED WARRANTY SHALL NOT EXTEND TO ANYONE OTHER THAN THE ORIGINAL PURCHASER OF THIS PRODUCT, IS NONTRANSFERABLE AND STATES YOUR EXCLUSIVE REMEDY.

Some states do not allow limitations on how long an implied warranty lasts, or the exclusion or limitation of incidental or consequential damages, so the above limitations or exclusions may not apply to you. This warranty gives you specific legal rights, and you may also have other rights which vary from state to state.

To obtain warranty service, please contact SAMSUNG customer care center.



QUESTIONS OR COMMENTS?

COUNTRY	CALL	OR VISIT US ONLINE AT	WRITE
IN THE US	1-800-SAMSUNG (726-7864)	www.samsung.com	Samsung Electronics America, Inc. 85 Challenger Road Ridgefield Park, NJ 07660-2112



AH68-02476A-01

Free Manuals Download Website

<http://myh66.com>

<http://usermanuals.us>

<http://www.somanuals.com>

<http://www.4manuals.cc>

<http://www.manual-lib.com>

<http://www.404manual.com>

<http://www.luxmanual.com>

<http://aubethermostatmanual.com>

Golf course search by state

<http://golfingnear.com>

Email search by domain

<http://emailbydomain.com>

Auto manuals search

<http://auto.somanuals.com>

TV manuals search

<http://tv.somanuals.com>