

SAMSUNG COLOR TELEVISION

CL21Z43/21Z45/21Z47/21Z50/
21Z55/21Z57/21Z58/21AE0/
21AF0/21AM0/21AJ0/21BH0

Owner's Instructions

Before operating, please read this manual thoroughly, and retain it for future reference.

Register your product at www.samsung.com/global/register.

Record your Model and Serial number.

• Model _____ • Serial No. _____

Control Panel (depending on the model)

➤ The product colour and shape may vary depending on the model.

Front (or Side) Panel

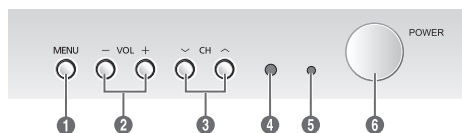

- 1 On-screen menu display
- 2 Volume adjustment
- 3 Channel selection
- 4 Remote control sensor
- 5 Standby indicator
- 6 Power on/off

- ◆ The 2 and 3 buttons also have the same function as the ◀/▶/▲/▼ buttons on the remote control.
- ◆ If the remote control no longer works or you have misplaced it, you can use the controls on the panel of the television.

Connection Panel (depending on the model)

➤ The product color and shape may vary depending on the model.

Rear Jack

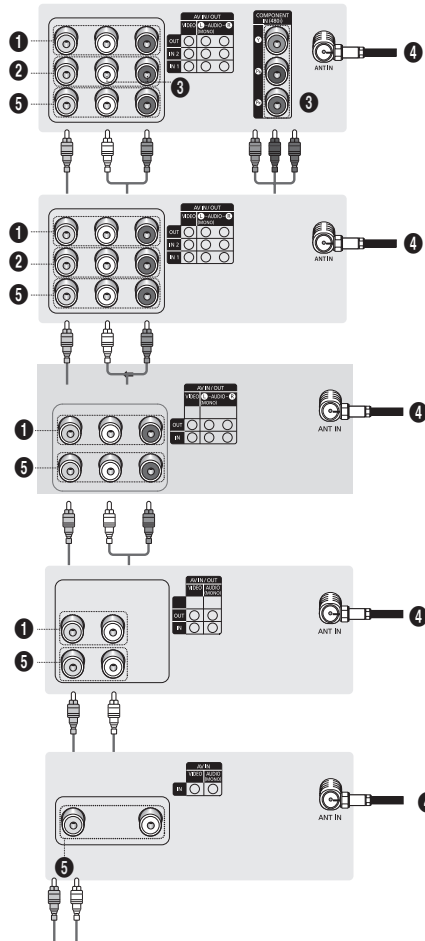

➤ Whenever you connect an audio or video system to your television, ensure that all elements are switched off. Please be sure to match the color coded input terminals and cable jacks.

1 Audio/Video Output Jacks

Connect to the audio/video input jacks of a recording VCR.

2, 5 Audio/Video Input Jacks

Connect to the audio/video output jacks of VCRs, DVD players and similar devices. when using the mono equipment, connect to the AUDIO-L of 2, 5 input connector

3 Component Video Input Jacks (Y, Pb, Pr)

Connect to the Component video outputs of a DVD or DTV set-top box. 480i video signal input is available. When using the Component Video input, connect audio jacks to "AV IN 2 (AUDIO-L/R)".

4 ANT IN

Connect to an antenna or to a cable TV system.

Front (or Side) Panel

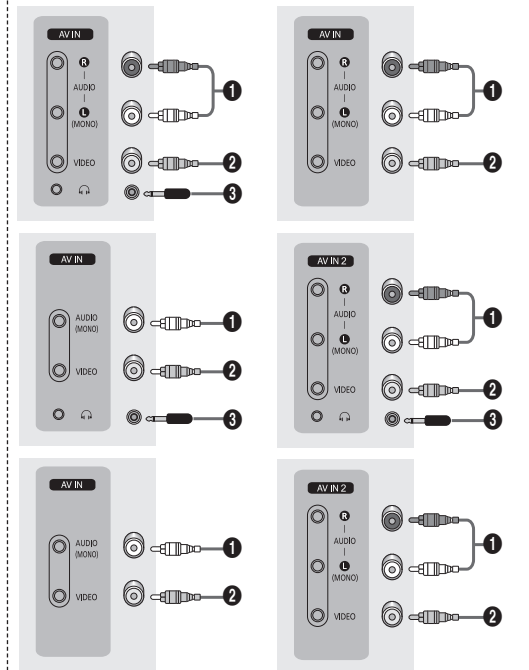

- 1 Audio input
- 2 Video input
- 3 Headphone jack

➤ Please be sure to match the colour coded input terminals and cable jacks.

Connecting to the RCA Input

The 1 (AUDIO-L/R) and 2 (VIDEO) connectors are used for equipment, such as a camcorder, video disc player, or video game device.

continued..



Connecting to the Headphones

The **3** (headphone) jack is used for watching a television programme without disturbing the other people in the room. Prolonged use of headphones at a high volume may damage your hearing.

- When both the front (or side) AV and rear connectors are connected to external equipment, the front (or side) AV receives priority.

Remote Control (depending on the model)

- Operation of remote control may be affected by bright artificial light near to the TV.

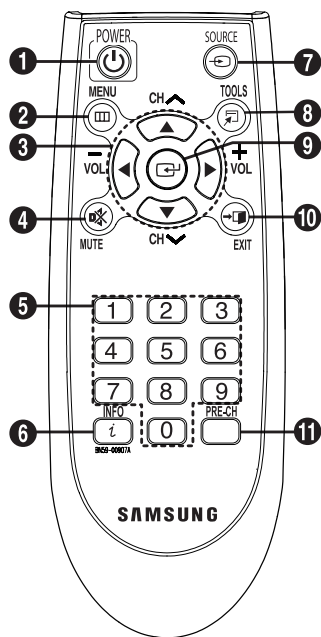

- 1. POWER**
Turns the TV on and off.
- 2. MENU**
Displays the main on-screen menu.
- 3. \blacktriangle / \blacktriangledown / \blacktriangleleft / \blacktriangleright**
Controls the cursor in the menu.
VOL +, VOL -
Press to increase or decrease the volume.
CH \wedge , CH \vee
Press to change channels.
- 4. MUTE**
Press to temporarily cut off the sound.
- 5. Number buttons**
Press to select channels directly on the TV.
- 6. INFO**
Press to display information on the TV screen.
- 7. SOURCE**
Press to display all of the available video sources.
- 8. TOOLS (depending on the model)**
You can check the following selection by pressing **TOOLS** button.
 - 1. Sleep Timer**
Press to select a preset time interval for automatic shut off.
 - 2. Picture Mode**
Used to select the picture effect.
 - 3. Sound Mode**
Used to select sound effect.
 - 4. MTS (Multi-channel Television Sound)**
Press to choose "Stereo" or "Mono".
 - 5. Turbo Sound**
Used to select the turbo sound option.
 - 6. R. SURF**
Press to automatically return to a preferred channel after a user preset time delay.
 - 7. Sound Adjust**
Used to display the sound adjust menu.
- 9. ENTER**
While using the on-screen menus, press **ENTER** to activate (or change) a particular item.
- 10. EXIT**
Press to exit the menu.
- 11. PRE-CH**
Tunes to the previous channel.

Installing Batteries

Remove the cover. Install two AAA size batteries, then replace the cover. When the remote control does not operate normally, check that the "+" and "-" ends of the batteries are inserted correctly or the batteries are drained.

- Do not mix battery types, i.e. alkaline and manganese.

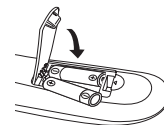

Turning the TV On and Off

Press the **POWER** button on the remote control. You can also use the **POWER** button on the TV.
➤ Caution: One pole switch is totally not off (one line still live) if power cord is not unplugged.

Viewing the Menus

- 1 Press the **MENU** button. The main menu is displayed on the screen. Its left side has five icons: "Input", "Picture", "Sound", "Channel", and "Setup".
- 2 Press the \blacktriangle or \blacktriangledown button to select one of the icons. Press the **ENTER** button to access the icon's sub-menu.
- 3 Press the \blacktriangle or \blacktriangledown button to move to items in the menu. Press the **ENTER** button to enter items in the menu.
- 4 Press the \blacktriangle / \blacktriangledown / \blacktriangleleft / \blacktriangleright button to change the selected items. Press the **MENU** button to return to the previous menu.
- 5 Press the **EXIT** button to exit from the menu.

Setup - Plug & Play (depending on the model)

When the TV is initially powered on, several basic customer settings proceed automatically and subsequently. The following settings are available.

- 1 Press the **POWER** button on the remote control.

The message "Start Plug & Play" is displayed. It flickers for a little while and then Language menu is automatically displayed.



- 2 Press the **▲** or **▼** button to select the language, then press the **ENTER** button. The message "Check antenna input" is displayed.

➤ If any language is not selected, the language menu will disappear about 30 seconds later.

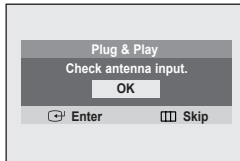

- 3 Make sure that the antenna is connected to the TV.

Press the **ENTER** button, then the "Auto Program" is displayed.

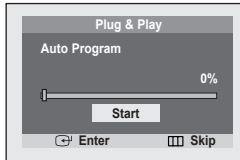

- 4 Press the **ENTER** button to select "Start". The TV will begin memorizing all of the available channels. Press the **ENTER** button to stop.

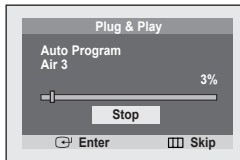

continued...

- 5 After all available channels are stored, the "Clock set" is displayed. Press the **ENTER** button. Press the **◀** or **▶** button to move to the hour or minute. Set the clock by pressing the **▲** or **▼** button.

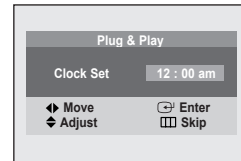

- 6 When you have finished, press the **MENU** button. The "Enjoy your watching." is displayed and then the channel which has been stored will be activated.

➤ Plug & Play feature doesn't work in the AV mode, and then the channel which has been stored will be activated.

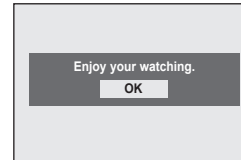

Re-setting the Plug & Play

Method:

MENU → **▲/▼** (Setup) → **ENTER** → **▲/▼** (Plug & Play) → **ENTER**

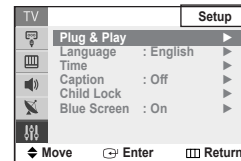

Input - Source List (depending on the model)

◆ Source List

You can switch between viewing signal from connected equipment, such as a VCR, DVD, set-top box, and the TV source (broadcast or cable).

- Press the **SOURCE** button on the remote control repeatedly to select the desired signal source.

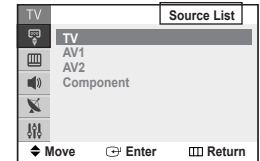

Channel - Memorizing the Channels

Your TV can memorize and store all of the available channels for both air (antenna) and cable channels. After the available channels are memorized, use the **CH** \wedge and **CH** \vee buttons to scan through the channels.

This eliminates the need to change channels by entering the channel digits. There are three steps for memorizing channels: "Air/Cable", "Auto Program" and "Add/Delete".

◆ Air/Cable

Before your TV can begin memorizing the available channels, you must specify the type of signal source that is connected to the TV (i.e., an antenna or a cable system).

Select "Air" or "Cable" by pressing the \blacktriangleleft or \blacktriangleright button.

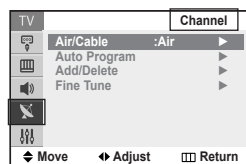

◆ Auto Program

All available channels are automatically stored in memory when channels are selected by the direct tuning function.

Press the **ENTER** button at any time to interrupt the memorization process.

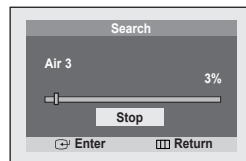

◆ Add/Delete

You can add or delete a channel to display the channels you want only. To use the "Add/Delete" function, first run Auto Program. Select "Deleted" or "Added" by pressing the **ENTER** button.

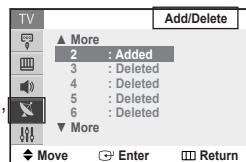

Channel - Fine Tune

The Fine Tuning function lets you manually adjust the TV's tuner if you have difficulty tuning channels.

Adjust the fine tuning by pressing the \blacktriangleleft or \blacktriangleright button.

To store the fine tuning setting in the TV's memory, press the **ENTER** button.

To reset the fine tuning to "0", select "Reset" by pressing the \blacktriangleup or \blacktriangledown button, then press the **ENTER** button.

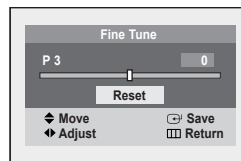

Setup - Time

◆ Clock

Setting the clock is necessary in order to use the various timer features of the TV. Also, you can check the time while watching the TV. (Just press the **INFO** button.)

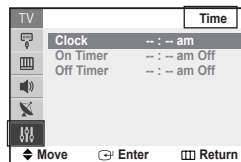

◆ On Timer / Off Timer

You can set the On/Off timers so that the TV will switch on or off automatically at the time you select.

➤ You must set the clock first.

☛ Auto Power Off

When you set the timer "On", the TV will eventually turn off, if no controls are operated for 3 hours after the TV was turned on by timer. This function is only available in timer "On" mode and prevents overheating or leakages, which may occur if a TV is on for too long.

Sleep Timer

You can select a time period of between 30 and 180 minutes after which the TV automatically switches to standby mode. Press the **TOOLS** button on the remote control to enter **Sleep Timer**. (any of the preset values from "30 Min." to "180 Min.").

Setup - Caption (depending on the model)

Your TV decodes and displays the closed captions that are broadcast with certain TV shows.

These captions are usually subtitles for the hearing impaired or foreign-language translations.

All VCRs record the closed caption signal from TV programs, so home-recorded video tapes also provide closed captions. Most pre-recorded commercial video tapes provide closed captions as well. Check for the closed caption symbol in your TV schedule and on the tape's packaging: .



◆ Caption: On/Off

You can activate or deactivate the "Caption" function.

☛ Misspellings and unusual characters sometimes occur during closed caption transmissions, especially those of live events. There may be a small delay before captions appear when you change channels. These are not malfunctions of the TV.

Setup - Child Lock

This feature allows you to prevent unauthorized users, such as children, from watching unsuitable programmes by muting out video and audio. Child Lock cannot be released using front (or side) panel buttons. Only remote control can release the Child Lock setting, so keep the remote control away from children.

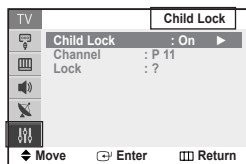

◆ Child Lock : On/Off

You can activate or deactivate the Child Lock function.

◆ Channel : Channel number to be locked.

◆ **Lock** : When press the **ENTER** button, the "Locked" is displayed.

➤ If any channel is locked, you can not access to the "Channel" and "Child Lock" menu by using the control buttons on the TV panel (the "Not Available" is displayed in the "Child Lock" menu). You can access by using the remote control only.

Setup - Language / Blue Screen

(depending on the model)

◆ Language

It is variable depending on the model. When you start using the television for the first time, you must select the language which will be used for displaying menus and indications.

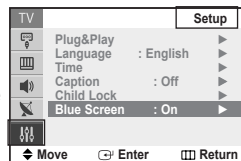

◆ Blue Screen

If no signal is being received or the signal is very weak, a blue screen automatically replaces the noisy picture background. If you wish to continue viewing the poor picture, you must set the Blue Screen to Off.

Picture - Mode

◆ Mode: Dynamic / Standard / Movie / Custom

You can select the type of picture which best corresponds to your viewing requirements.

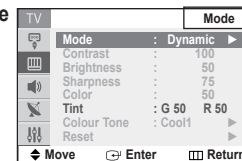

➤ You can select these options simply by pressing the **TOOLS** button on the remote control and enter **Picture Mode**.

◆ Contrast / Brightness / Sharpness / Color / Tint (NTSC only)

The TV has several settings which allow you to control the picture quality.

◆ Color Tone: Cool2 / Cool1 / Normal / Warm1 / Warm2

You can change the color of the entire screen according to your preference.

◆ Reset

You can return to the factory defaults.

The reset function is set for each mode (**Dynamic**, **Standard**, **Movie**, or **Custom**).

R.SURF Feature (depending on the model)

This feature allows you to set the TV to return to a particular channel after a certain amount of time. For example, you may be watching a channel when commercials start. You can press **TOOLS** button to enter **R.SURF** to set the **R.SURF** to "5 minutes", then switch channels. After minutes, the TV will return to the original channel.

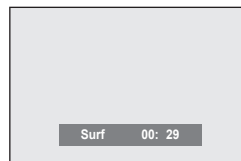

Press the **ENTER** button on the remote control to set the timer in thirty seconds intervals, up to five minutes.

Picture - Digital NR / DNle Jr

(depending on the model)

◆ Digital NR

If the signal received by the television is weak, you can activate this feature to reduce any static and ghosting that may appear on the screen.

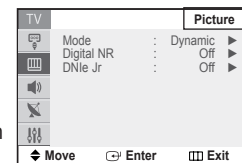

◆ DNle Jr

If the signal received by the television is weak, you can activate this feature to reduce any static and ghosting that may appear on the screen.

Sound - Mode / Adjust / Auto Volume / Turbo Sound (depending on the model)

◆ **Mode : Standard / Music / Movie / Speech / Custom**

You can select the type of special sound effect to be used when watching a given broadcast.

➤ You can select these options simply by pressing the **TOOLS** button on the remote control and enter **Sound Mode**.

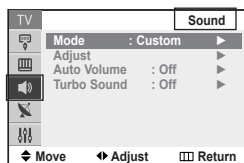

◆ **Adjust : Bass / Treble / Balance**

The television has several settings which allow you to control the sound quality.

➤ If you make any changes to these settings, the sound mode is automatically switched to "Custom".

➤ You can select these options simply by pressing the **TOOLS** button on the remote control and enter **Sound Adjust** to use this function.

◆ **Auto Volume**

Each broadcasting station has its own signal conditions, and so it is not easy to adjust the volume every time the channel is changed. This feature lets you automatically adjust the volume of the desired channel by lowering the sound output when the modulation signal is high or by raising the sound output when the modulation signal is low.

◆ **Turbo Sound**

This feature suitably emphasizes both higher and lower bands of sound (and includes other effects). You can enjoy more magnificent and dynamic sound when watching music, movie, or other channels.

➤ You can change the options simply by pressing the **TOOLS** button and enter **Turbo Sound**.

MTS (Multi-channel Television Sound) (depending on the model)

Depending on the particular program being broadcast, you cannot listen to "Mono" or "Stereo".

Only when the TV is set in AV mode, press the **TOOLS** button on the remote control to enter **MTS** to select "Stereo", "Mono".

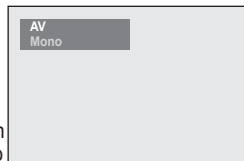

Troubleshooting

If the TV seems to have a problem, first try this list of possible problems and solutions. If none of these troubleshooting tips apply, then call your nearest Samsung authorized service center.

Poor picture.

- ◆ Try another channel.
- ◆ Adjust the antenna.
- ◆ Check all wire connections.

Poor sound quality.

- ◆ Try another channel.
- ◆ Adjust the antenna.

No picture or sound.

- ◆ Try another channel.
- ◆ Press the **SOURCE** button.
- ◆ Make sure the TV is plugged in.
- ◆ Check the antenna connections.
- ◆ Make sure the **MUTE** button is off.

No color, wrong colors or tints.

- ◆ Make sure the program is broadcast in color.
- ◆ Adjust the picture settings.

Picture rolls vertically.

- ◆ Adjust the antenna.
- ◆ Check all wire connections.
- ◆ If you are using a VCR, check the tracking.

The TV operates erratically.

- ◆ Unplug the TV for 30 seconds, then try operating it again.

Your remote control does not operate your TV.

- ◆ Make sure the remote has batteries.
- ◆ Check that the "+" and "-" ends of the batteries are inserted correctly.
- ◆ Check that the batteries are drained.

The TV won't turn on.

- ◆ Make sure the wall outlet is working.
- ◆ Make sure the TV is plugged in.
- ◆ Make sure the remote has batteries.

Remote control malfunctions

- ◆ Replace the remote control batteries.
- ◆ Clean the upper edge of the remote control (transmission window).
- ◆ Check that the "+" and "-" ends of the batteries are inserted correctly.
- ◆ Check that the batteries are drained.

A still image may cause color distortion, but with normal sound(white or highlight image).

- ◆ Switch to other channels with moving image, and check if the color turns normal after 5 minutes.
- ◆ Turn off the TV, and turn it on after 30 minutes to check the color

Cleaning and Maintaining Your TV

Please follow the guidelines to get the maximum performance from your TV.

Placement

- ◆ Do not Place the TV near extremely hot, cold, humid or dusty places.
- ◆ Do not place TV near appliances with electric motor that create magnetic fields, such as vacuum cleaners.
- ◆ Keep the ventilation openings clear; do not place TV on a soft surface, such as cloth or paper.
- ◆ Place the TV in a vertical position only.

Liquids

- ◆ Do not handle liquids near or on the TV. Liquid that spills into it can cause serious damage.

Cabinet

- ◆ Never open the cabinet or touch the parts inside.
- ◆ Wipe your TV with a clean, dry cloth. Never use water, cleaning fluids, wax or chemicals.
- ◆ Do not put heavy objects on top of the cabinet.

Temperature

- ◆ If your TV suddenly move from a cold to a warm place, unplug the power cord and allow at least two hours for moisture that may have formed inside the unit to dry completely.





Using Your TV in Another Country

- ◆ If you plan to take the TV with you to a foreign country please be aware of a different television systems that are in use around the world. A TV designed for one system may not work properly with another system due to differences in the TV channel frequencies.

➤ Note: Main plug serves as the disconnect device during servicing and shall be readily operable.

OSD Map

* : It is variable depending on the model.

 Input	- Source List *	- TV / AV1 / AV2 / Component
 Picture	- Mode	- Dynamic / Standard / Movie / Custom
		Contrast
		Brightness
		Sharpness
		Color
		Tint (NTSC only)
		Color Tone - Cool2 / Cool1 / Normal / Warm1 / Warm2
		Reset
	- Digital NR	- Off / On
	- DNIe Jr *	- Off / On
 Sound *	- Mode	- Standard / Music / Movie / Speech / Custom
	- Adjust	- Bass / Treble / Balance
	- Auto Volume	- Off/On
	- Turbo Sound	- Off / On
 Channel	- Air/Cable	- Air / Cable
	- Auto Program	
	- Add/Delete	- Added / Deleted
	- Fine Tune	
 Setup	- Plug & Play	
	- Language *	- English / Español / Portugues / Français
	- Time	- Clock
		- On Timer
		- Off Timer
	- Caption *	- Off/On
	- Child Lock	- Child Lock
		- Channel
		- Lock
	- Blue Screen	- Off / On

Important Warranty Information Regarding Television Format Viewing

Standard screen format televisions (4:3, the aspect ratio of the screen width to height) are primarily designed to view standard format full-motion video. The images displayed on them should primarily be in the standard 4:3 ratio format and constantly moving. Displaying stationary graphics and images on screen, such as the dark top and bottom letterbox bars (wide screen pictures), should be limited to no more than 15% of the total television viewing per week.

Wide screen format televisions (16:9, the aspect ratio of the screen width to height) are primarily designed to view wide screen format full-motion video. The images displayed on them should primarily be in the wide screen 16:9 ratio format, or expanded to fill the screen if your model offers this feature, and constantly moving. Displaying stationary graphics and images on screen, such as the dark side-bars on non-expanded standard format television video and programming, should be limited to no more than 15% of the total television viewing per week.

Additionally, viewing other stationary images and text such as stock market reports, video game displays, station logos, web sites or computer graphics and patterns, should be limited as described above for all televisions. **Displaying any stationary images that exceed the above guidelines can cause uneven aging of picture tubes (CRTs) that leave subtle, but permanent burned-in ghost images in the television picture. To avoid this, vary the programming and images, and primarily display full screen moving images, not stationary patterns or dark bars.** On television models that offer picture sizing features, use these controls to view the different formats as a full screen picture.

Be careful in the selection and duration of television formats used for viewing. Uneven CRT aging as a result of format selection and use, as well as other burned-in images, is not covered by your Samsung limited warranty.

Viewing screen size : 508mm

***This page is intentionally
left blank.***

Free Manuals Download Website

<http://myh66.com>

<http://usermanuals.us>

<http://www.somanuals.com>

<http://www.4manuals.cc>

<http://www.manual-lib.com>

<http://www.404manual.com>

<http://www.luxmanual.com>

<http://aubethermostatmanual.com>

Golf course search by state

<http://golfingnear.com>

Email search by domain

<http://emailbydomain.com>

Auto manuals search

<http://auto.somanuals.com>

TV manuals search

<http://tv.somanuals.com>