

SAMSUNG

**CL-29M30HS
CL-32M30HS
CL-34M30HS
CL-29Z30HS**

COLOR TELEVISION



**Owner's
Instructions**

Register your product at www.samsung.com/global/register

Download from Www.Somanuals.com. All Manuals Search And Download.

Important Warranty Information Regarding Television Format Viewing

Standard screen format televisions (4:3, the aspect ratio of the screen width to height) are primarily designed to view standard format full-motion video. The images displayed on them should primarily be in the standard 4:3 ratio format and constantly moving. Displaying stationary graphics and images on screen, such as the dark top and bottom letterbox bars (wide screen pictures), should be limited to no more than 15% of the total television viewing per week.

Wide screen format televisions (16:9, the aspect ratio of the screen width to height) are primarily designed to view wide screen format full-motion video. The images displayed on them should primarily be in the wide screen 16:9 ratio format, or expanded to fill the screen if your model offers this feature, and constantly moving. Displaying stationary graphics and images on screen, such as the dark side-bars on non-expanded standard format television video and programming, should be limited to no more than 15% of the total television viewing per week.

Additionally, viewing other stationary images and text such as stock market reports, video game displays, station logos, web sites or computer graphics and patterns, should be limited as described above for all televisions. *Displaying any stationary images that exceed the above guidelines can cause uneven aging of picture tubes (CRTs) that leave subtle, but permanent burned-in ghost images in the television picture. To avoid this, vary the programming and images, and primarily display full screen moving images, not stationary patterns or dark bars.* On television models that offer picture sizing features, use these controls to view the different formats as a full screen picture.

Be careful in the selection and duration of television formats used for viewing. Uneven CRT aging as a result of format selection and use, as well as other burned-in images, is not covered by your Samsung limited warranty.

Chapter 1: Your New TV 5

List of Features	5
Accessories	5
Familiarizing Yourself with The TV	6
Control Buttons	6
Connection Jacks (Side)	7
Connection Jacks (Rear)	8
Remote Control	9

Chapter 2: Installation 11

Connecting VHF and UHF Antennas	11
Antennas with 300-ohm Flat Twin Leads	11
Antennas with 75-ohm Round Leads	12
Separate VHF and UHF Antennas	12
Connecting Cable TV	12
Cable without a Cable Box	12
Connecting to a Cable Box that Descrambles All Channels	13
Connecting to a Cable Box that Descrambles Some Channels	13
Connecting a VCR	15
Connecting a Second VCR to Record from the TV	16
Connecting a DVD Player	17
Connecting to Y, PB, PR	17
Connecting to Regular Audio and Video Jacks	17
Connecting a Digital TV Set-Top Box	18
Connecting to Y, PB, PR	18
Connecting a Camcorder	19
Connecting to an Analog Amplifier	20
Installing Batteries in the Remote Control	21

Chapter 3: Operation 22

Turning the TV On and Off	22
Plug & Play Feature	22
Viewing the Menus and On-Screen Displays	24
Viewing the Menus	24
Viewing the Display	24
Selecting a Menu Language	25
Memorizing the Channels	26
Selecting the Video Signal-source	26
Storing Channels in Memory (Automatic Method)	27
Adding and Erasing Channels (Manual Method)	28
Changing Channels	29
Using the Channel Buttons	29
Using the Number Buttons	29
Using the PRE-CH Button to Select the Previous Channel	29
Labeling the Channels	30
Setting the Clock	31

Picture Control	32
Using Automatic Picture Settings	32
Customizing the Picture	33
Resetting the Picture Settings to the Factory Defaults	34
Sound Control	35
Adjusting the Volume	35
Using the Mute Button	35
Using Automatic Sound Settings	36
Customizing the Sound.	37
Viewing an External Signal Source	38
Setting the Signal Source.	38
Assigning Names to External input mode	39
Chapter 4: Special Features	40
Fine Tuning Channels	40
Changing the Screen Size (depending on the model).	41
Digital Noise Reduction	42
Tilt	43
Using the R.Surf Feature	44
Freezing the Picture	44
Choosing a Multi-Channel Sound (MTS) track	45
Auto Volume	46
Setting the Surround	47
Setting the Turbo Sound	48
Setting the On/Off Timer.	49
Setting the Sleep Timer	50
Setting the Preferred Volume Level and Channel	51
Viewing Closed Captions (On-Screen Text Messages)	52
Locking the Channel	53
Setting the On/Off Melody	54
Customizing Your Remote Control	55
Chapter 5: Troubleshooting	57
Identifying Problems.	57
Appendix	58
Cleaning and Maintaining Your TV	58
Using Your TV in Another Country.	58
Specifications	58

Chapter One

YOUR NEW TV

List of Features

Your TV is designed with the latest technology. This TV is a high-performance unit that includes the following special features:

- Full Flat Screen
- Easy-to-use remote control
- Easy-to-use on-screen menu system
- Automatic timer to turn the TV on and off
- Adjustable picture and sound settings that can be stored in the TV's memory
- Automatic channel tuning for up to 181 channels
- A special filter to reduce or eliminate reception problems
- A built-in multi-channel sound decoder for stereo and bilingual listening
- Built-in, dual channel speakers
- A special sleep timer

Accessories

Once you have unpacked your TV, check to make sure that you have all the parts shown here. If any piece is missing or broken, call your dealer.

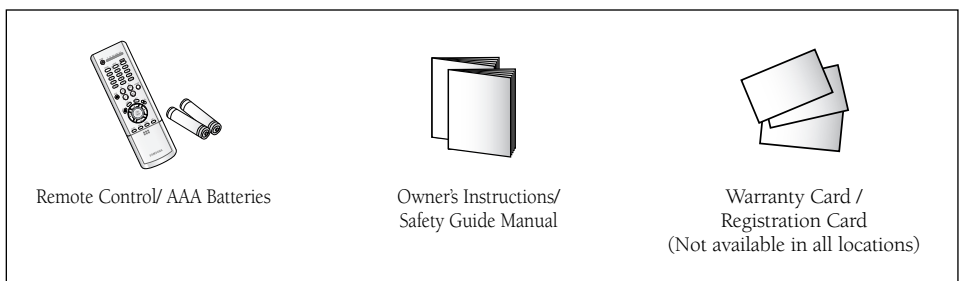

Familiarizing Yourself with The TV

Control Buttons

You can control your TV's basic features, including the on-screen menu. To use the more advanced features, you must use the remote control.

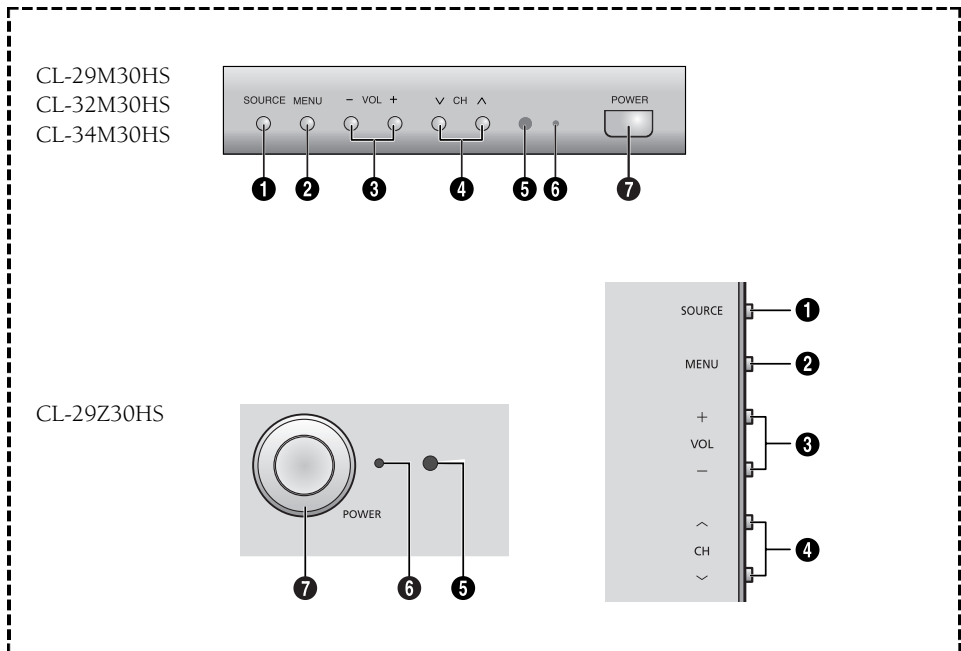

1 SOURCE

Press to change between viewing TV programs and signals from other devices.

2 MENU

Press to see an on-screen menu of your TV's features.

3 + VOL -

Press to increase or decrease the volume. Also used to select items on the on-screen menu.

4 \vee CH \wedge

Press to change channels. Also press to move between items on the on-screen menu.

5 Remote Control Sensor

Aim the remote control towards this spot on the TV.

6 Stand-By Indicator

Lights up when you turn the power off.

- Power Off ; Red

- Power On ; Off

7 POWER

Press to turn the TV on and off.

Connection Jacks (Side)

You can connect an A/V component that is used only occasionally, such as a camcorder or video game. (For information on connecting equipment, see page 19.)

When both the side inputs (**AV IN 1**) and rear inputs (**AV IN 1**) are connected to external equipment, the side inputs (**AV IN 1**) receive priority.

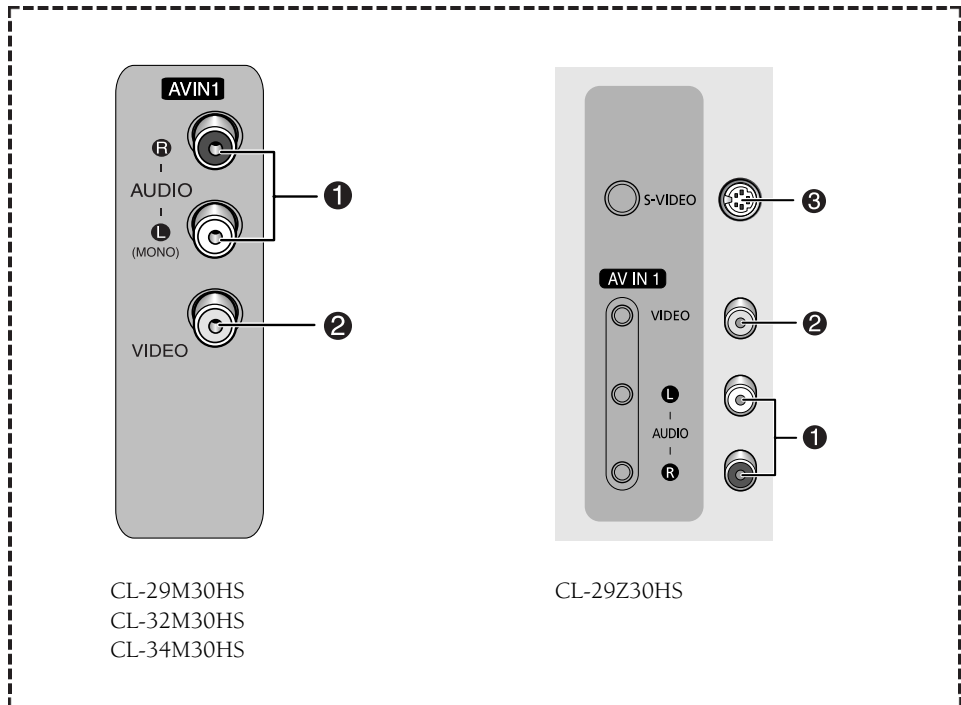

1 AUDIO Input

Connect audio signals from a camcorder or video game.

2 VIDEO Input

Connect a video signal from a camcorder or video game.

3 S-VIDEO Input

Connect an S-Video signal from a camcorder or video game.

- Please be sure to match the color coded input terminals and cable jacks.

Connection Jacks (Rear)

Use the rear panel jacks to connect an A/V component that will be connected continuously, such as a VCR or a DVD player.

For more information on connecting equipment, see pages 11~20.

CL29M30HS
CL32M30HS
CL34M30HS

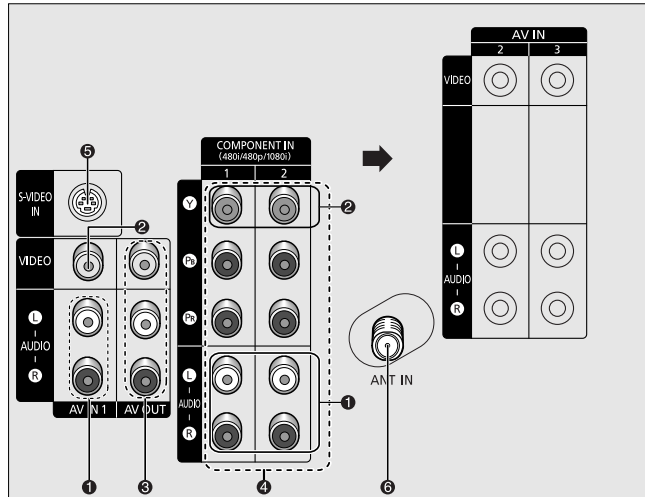

CL29Z30HS

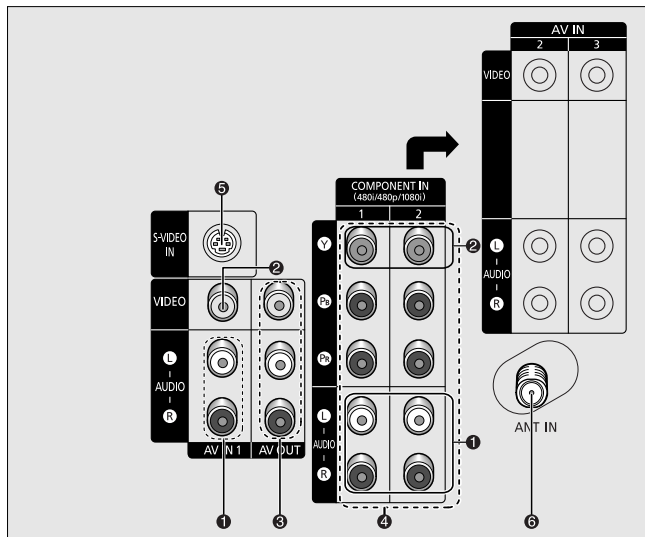

1 Audio Input jacks

Connect to the audio output jacks of VCRs, DVD players and similar devices.

- The component audio 1 and 2 input jacks also function as the audio 2 and 3 input jacks for regular (composite) video.

2 Video Input jack

Connect to the video output jack of VCRs, DVD players and similar devices.

- The Y Component video 1 and 2 input jacks also function as the regular (composite) video 2 and 3 input jacks.

3 Audio-Video Output jacks

Connect to the audio/video input jacks of a recording VCR.

4 Component Input jacks (Y, PB, PR, AUDIO-L/R)

Connect to the Component audio and video outputs of a DVD or DTV set-top box. 480i/480p/1080i Y, Pb and Pr video signal inputs are available. (In Argentina, 480i/480p/576i/576p/1080i are available only for CL29Z30HS model.)

5 S-Video Input jack

Connect to S-Video output jack of an S-VHS VCR or DVD player.

6 ANTENNA terminal

Connect to an antenna or a cable TV system.

Remote Control

You can use the remote control up to about 23 feet from the TV. When using the remote, always point it directly at the TV.

You can also use your remote control to operate your VCR, DVD, Cable box, and some Samsung Set-top boxes. See pages 55~56 for details.

- 1 POWER**
Turns the TV on and off.
- 2 S.MODE**
Adjust the TV sound by selecting one of the preset factory settings (or select your personal, customized sound settings). (Refer to page 36.)
- 3 P.MODE**
Adjust the TV picture by selecting one of the preset factory settings (or select your personal, customized picture settings). (Refer to page 32.)
- 4 Number buttons**
Press to select channels directly on the TV.
- 5 +100**
Press to select channels over 100. For example, to select channel 121, press "+100", then press "2" and "1".
- 6 VOL +, VOL -**
Press to increase or decrease the volume.
- 7 MUTE**
Press to temporarily cut off the sound.
- 8 SLEEP**
Press to select a preset time interval for automatic shut off.
- 9 MENU**
Displays the main on-screen menu.
- 10 P.SIZE**
Press to change the screen size. (Refer to page 41.)
- 11 R.SURF**
Press to automatically return to a preferred channel after a user-preset time delay.

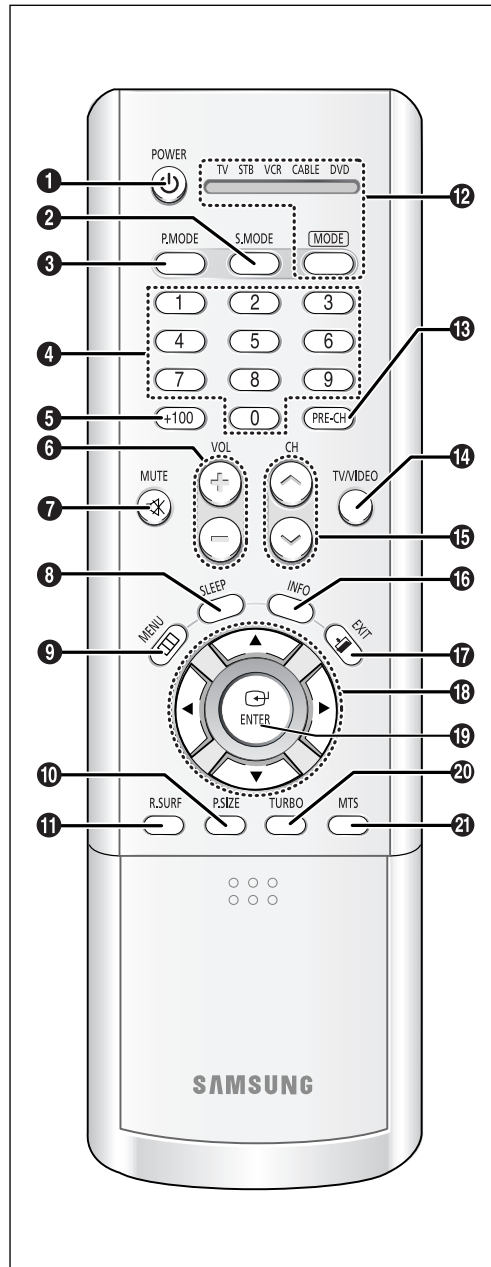

- 12 MODE**
Selects a target device to be controlled by this remote control (i.e., TV, Samsung STB, VCR, Cable box, or DVD).
- 13 PRE-CH**
Tunes to the previous channel.
- 14 TV/VIDEO**
Press to display all of the available video sources.
- 15 CH ^, CH v**
Press to change channels.
- 16 INFO**
Press to display information on the TV screen.
- 17 EXIT**
Press to exit the menu.
- 18 ▲/▼/◀/▶**
Controls the cursor in the menu.
- 19 ENTER**
While using the on-screen menus, press ENTER to activate (or change) a particular item.
- 20 TURBO**
Press to turn the TURBO sound On or Off.
- 21 MTS**
(Multi-channel Television Sound)
Press to choose "Stereo", "Mono", or "SAP" (Secondary Audio Program).

continued...

Remote Control

- 22 TV/COMPONENT**
Press to switch the TV between COMPONENT1 or 2 mode.
- 23 VCR/DVD Controls**
Controls VCR/DVD functions: Rewind, Stop, Play/Pause, Fast Forward.
- 24 SET**
Used during set up of this remote control, so that it will work compatibly with other devices (some Samsung Set-top boxes, VCR, Cable box, DVD, etc.)

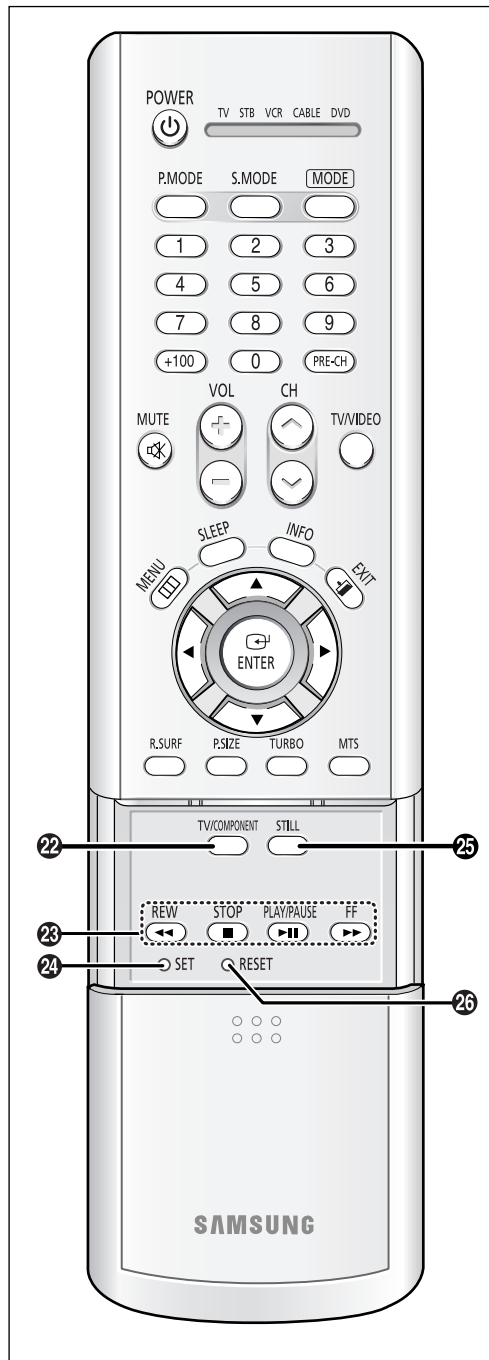

- 25 STILL**
Press to stop the action during a particular scene. Press again to resume normal video.
Note: The still function doesn't operate in Component 1, 2 mode.
- 26 RESET**
If your remote control is not functioning properly, take out the batteries and press the **RESET** button for about 2~3 seconds. Re-insert the batteries and try using the remote control again.

Chapter Two

INSTALLATION

Connecting VHF and UHF Antennas

If your antenna has a set of leads that look like this, see “Antennas with 300-ohm Flat Twin Leads” below.

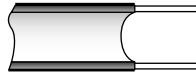

If your antenna has one lead that looks like this, see “Antennas with 75-ohm Round Leads” on the next page.



If you have two antennas, see “Separate VHF and UHF Antennas” on the next page.

Antennas with 300-ohm Flat Twin Leads

If you are using an off-air antenna (such as a roof antenna or “rabbit ears”) that has 300-ohm twin flat leads, follow the directions below.

1

Place the wires from the twin leads under the screws on the 300-75 ohm adaptor (not supplied). Use a screwdriver to tighten the screws.

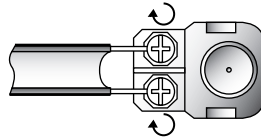

2

Plug the adaptor into the “ANT IN” terminal on the rear panel.

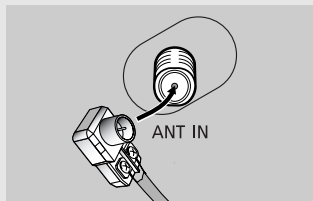

Antennas with 75-ohm Round Leads

1

Plug the antenna lead into the "ANT IN" terminal on the rear panel.

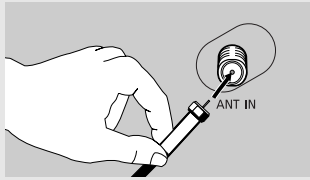

Separate VHF and UHF Antennas

If you have two separate antennas for your TV (one VHF and one UHF), you must combine the two antenna signals before connecting the antennas to the TV. This procedure requires an optional combiner-adaptor (available at most electronics shops).

1

Connect both antenna leads to the combiner.

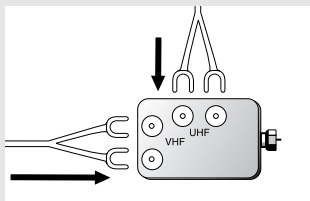

2

Plug the combiner into the "ANT IN" terminal on the rear panel.

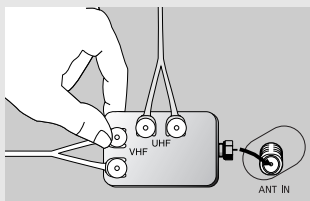

Connecting Cable TV

To connect to a cable TV system, follow the instructions below.

Cable without a Cable Box

1

Plug the incoming cable into the "ANT IN" terminal on the rear panel.

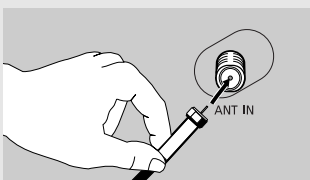

Connecting to a Cable Box that Descrambles All Channels

- 1**
Find the cable that is connected to the ANTENNA OUT terminal on your cable box.

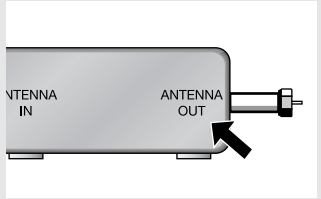

◀ This terminal might be labeled “ANT OUT”, “VHF OUT” or simply, “OUT”.

- 2**
Connect the other end of this cable to the “ANT IN” terminal on the rear panel.

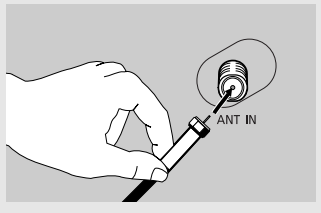

Connecting to a Cable Box that Descrambles Some Channels

If your cable box descrambles only some channels (such as premium channels), follow the instructions below. You will need a two-way splitter, an RF (A/B) switch, and four lengths of coaxial cable. (These items are available at most electronics stores.)

- 1**
Find and disconnect the cable that is connected to the ANTENNA IN terminal on your cable box.

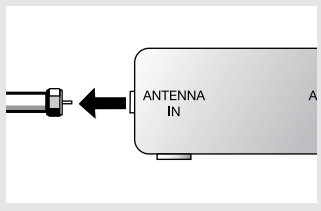

◀ This terminal might be labeled “ANT IN”, “VHF IN” or simply, “IN”.

- 2**
Connect this cable to a two-way splitter.

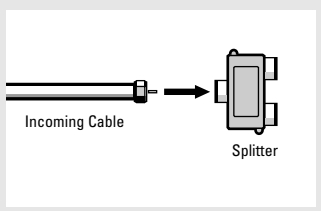

- 3**
Connect a coaxial cable between an OUTPUT terminal on the splitter and the IN terminal on the cable box.

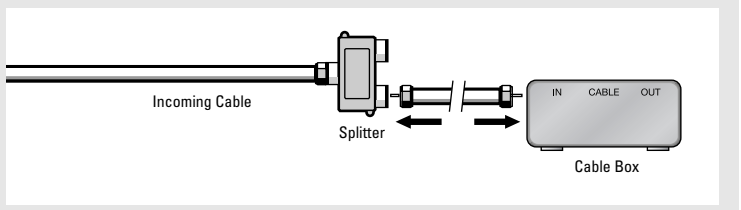

continued...

INSTALLATION

4

Connect a coaxial cable between the ANTENNA OUT terminal on the cable box and the B-IN terminal on the RF (A/B) switch.

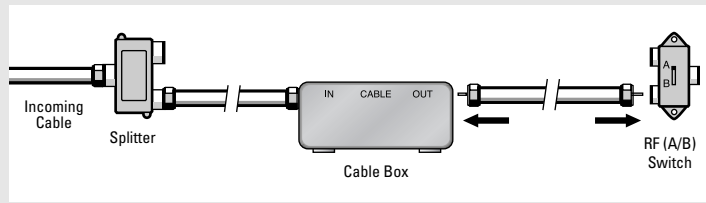

5

Connect another cable between the other OUT terminal on the splitter and the A-IN terminal on the RF (A/B) switch.

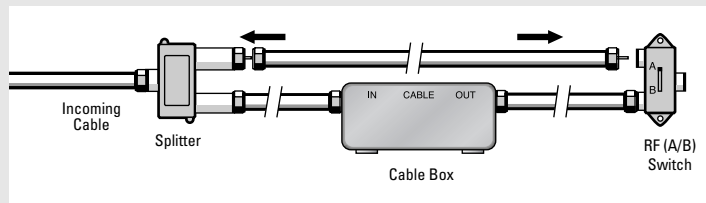

6

Connect the last coaxial cable between the OUT terminal on the RF (A/B) switch and the "ANT IN" terminal on the rear panel.

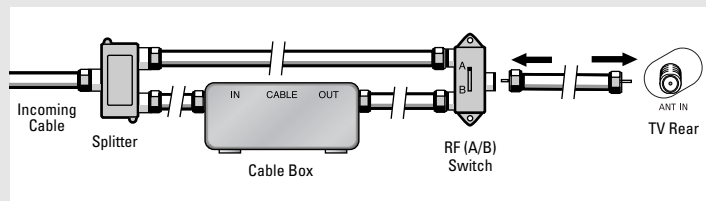

After you've made this connection, set the A/B switch to the "A" position for normal viewing. Set the A/B switch to the "B" position to view scrambled channels. (When you set the A/B switch to "B", you will need to tune your TV to the cable box's output channel, which is usually channel 3 or 4.)

Connecting a VCR

These instructions assume that you have already connected your TV to an antenna or a cable TV system (according to the instructions on pages 11~14).

- Please be sure to match the color coded input terminals and cable jacks.

1

Connect a coaxial cable between the "ANT IN" terminal on the TV and the antenna out terminal on the VCR.

A coaxial cable is usually included with a VCR. (If not, check your local electronics store).

2

Connect a set of audio cables between the "AV IN 1 (L, R)" (or "AV IN 2/3 (L, R)") jacks on the TV and AUDIO OUT jacks on the VCR.

If you have a mono VCR, connect L(mono) to VCR audio out using only one audio cable.

3

Connect a video or S-video cable between the "AV IN 1 (VIDEO)" ("AV IN 2/3 (VIDEO)" or "S-VIDEO IN") jack on the TV and the VIDEO OUT jack on the VCR.

Refer to your VCR's instructions for more information about how to view your VCR tape.

TV Rear Panel

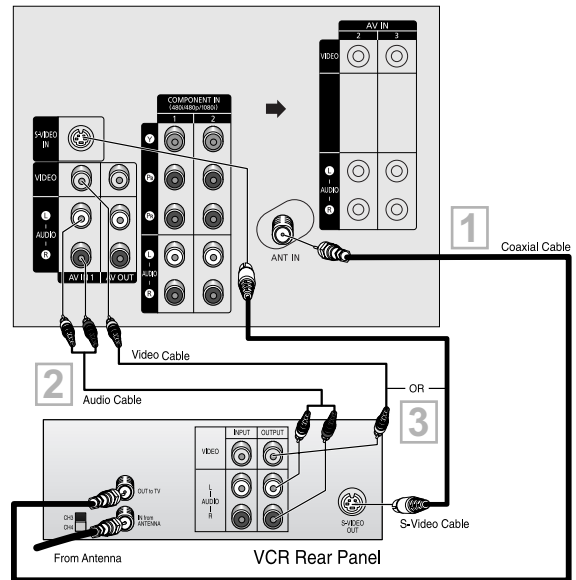

- Also, you can connect to "AV IN 1" on the side panel of TV.

Connecting a Second VCR to Record from the TV

Your TV can send out signals of its picture and sound to be recorded by a second VCR. To do this, connect your second VCR as follows:

1

Connect a set of audio cables between the AUDIO OUT jacks on the TV and the AUDIO IN jacks on the VCR. (The VCR input jacks might be either on the front or on back of the VCR.)

2

Connect a video cable between the VIDEO OUT jack on the TV and the VIDEO IN jack on the VCR.

Refer to your VCR's instructions for more information about how to record using this kind of connection.

TV Rear Panel

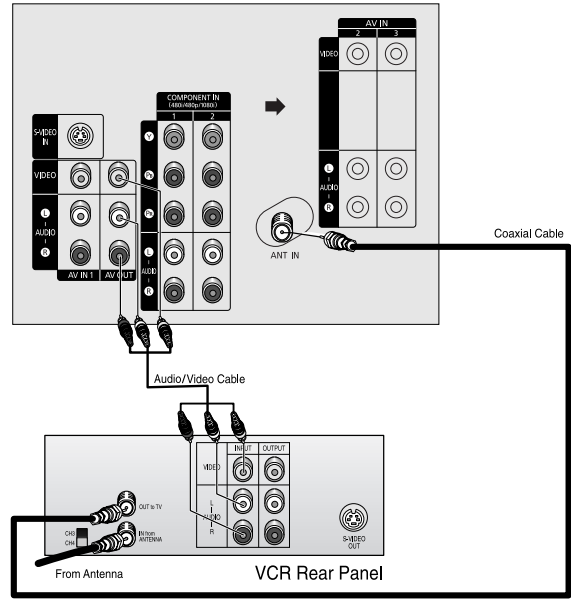

Connecting a DVD Player

The rear panel jacks on your TV make it easy to connect a DVD player to your TV.

- Please be sure to match the color coded input terminals and cable jacks.

Connecting to Y, P_B, P_R

1

Connect a set of audio cables between the "COMPONENT IN 1 (L, R)" (or "COMPONENT IN 2 (L, R)") jacks on the TV and the AUDIO OUT jacks on the DVD player.

2

Connect a set of video cables between the "COMPONENT IN 1 (Y, P_B, P_R)" (or "COMPONENT IN 2 (Y, P_B, P_R)") jacks on the TV and the VIDEO OUT (Y, P_B, P_R) jacks on the DVD player.

For an explanation of Component video, see your DVD player's owner's instruction.

TV Rear Panel

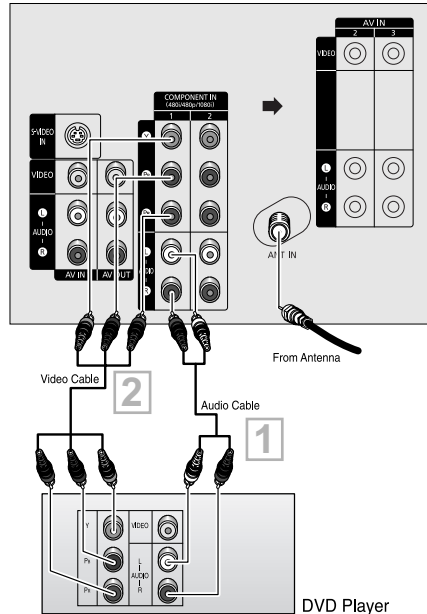

Connecting to Regular Audio and Video Jacks

1

Connect a set of audio cables between the "AV IN 1 (L, R)" (or "AV IN 2/3 (L, R)") jacks on the TV and the AUDIO OUT jacks on the DVD player.

2

Connect a video cable between the "AV IN 1 (VIDEO)" (or "AV IN 2/3 (VIDEO)") jack on the TV and the VIDEO OUT jack on the DVD player.

The Y Component video 1 and 2 input jacks also function as the regular (composite) video 2 and 3 input jacks.

The component audio 1 and 2 input jacks also function as the audio 2 and 3 input jacks for regular (composite) video.

TV Rear Panel

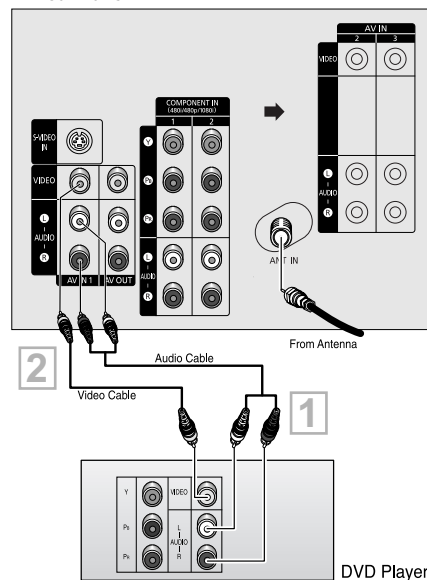

- Also, you can connect to "AV IN 1" on the side panel of TV.

Connecting a Digital TV Set-Top Box

The rear panel jacks on your TV make it easy to connect a set-top box to your TV.

- Please be sure to match the color coded input terminals and cable jacks.

Connecting to Y, P_B, P_R

1
Connect a coaxial cable to the ANTENNA IN terminal on the set-top box.

2
Connect a set of audio cables between the "COMPONENT IN 1 (L, R)" (or "COMPONENT IN 2 (L, R)") jacks on the TV and the AUDIO OUT jacks on the set-top box.

3
Connect a set of video cables between the "COMPONENT IN 1 (Y, P_B, P_R)" (or "COMPONENT IN 2 (Y, P_B, P_R)") jacks on the TV and the VIDEO OUT (Y, P_B, P_R) jacks on the set-top box.

The connections for a typical set-top box are shown.
For detailed information, refer to the set-top box instruction manual.

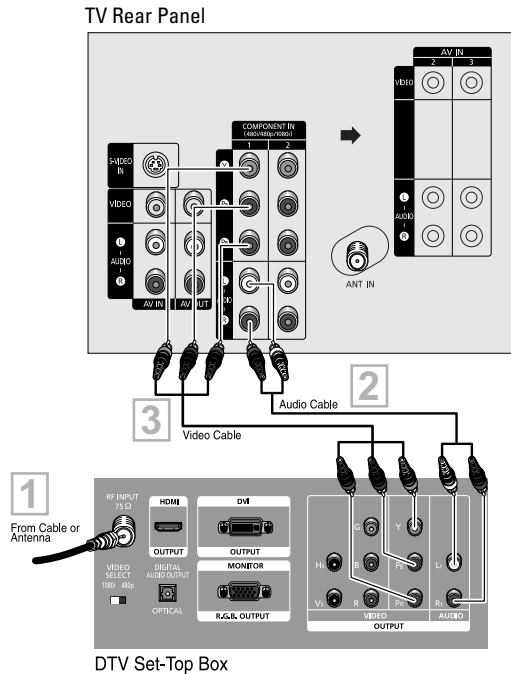

Connecting a Camcorder

The side panel jacks on your TV make it easy to connect a Camcorder to your TV. They allow you to view the Camcorder tapes without using a VCR.

- Please be sure to match the color coded input terminals and cable jacks.

1
Locate the A/V output jacks on the Camcorder. They are usually found on the side or rear of the Camcorder.

2
Connect a set of audio cables between the "AV IN1 (L, R)" jacks on the TV and the AUDIO OUT jacks on the Camcorder.

If you have mono Camcorder, connect L(mono) to Camcorder audio out using only one audio cable.

3
Connect a video cable between the "AV IN1 (VIDEO)" jack on the TV and the VIDEO OUT jacks on the Camcorder.

The audio-video cables shown here are usually included with a Camcorder. (If not, check your local electronics store.) If your Camcorder is stereo, you need to connect a set of two cables.

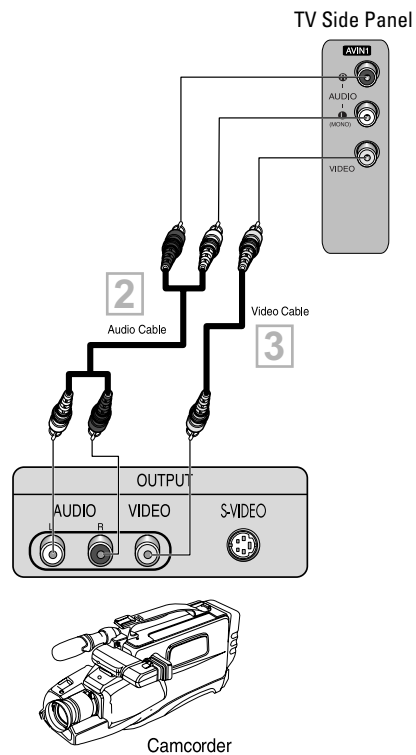

Connecting to an Analog Amplifier

- Please be sure to match the color coded input terminals and cable jacks.

The "AUDIO OUT (AUDIO-L/R)" terminals cannot be used for external speakers. You must hook them up to an amplifier.

When an audio amplifier is connected to the "AUDIO OUT (AUDIO-L/R)" terminals: Decrease the gain (volume) of the TV, and adjust the volume level with the Amplifier's volume control.

TV Rear Panel

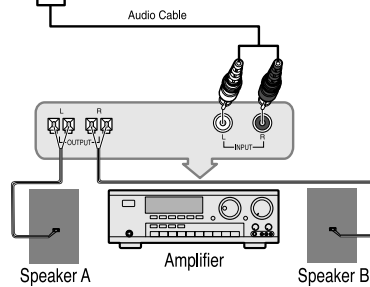
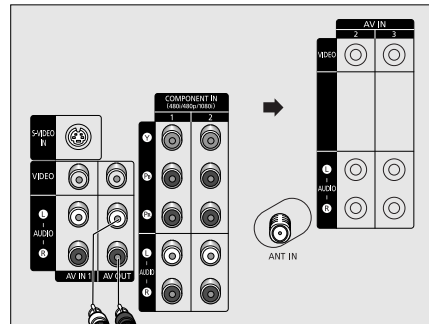

Installing Batteries in the Remote Control

- 1**
Slide the cover out completely.

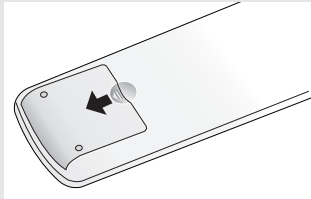

- 2**
Install two AAA size batteries.

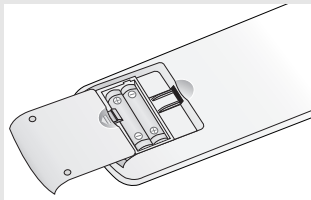

- ◀ Make sure to match the “+” and “-” ends of the batteries with the diagram inside the compartment.

- 3**
Replace the cover.

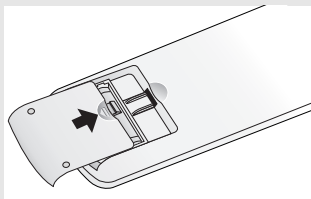

- ◀ Remove the batteries and store them in a cool, dry place if you won't be using the remote control for a long time.

The remote control can be used up to about 23 feet from the TV. (Assuming typical TV usage, the batteries last for about one year.)

Chapter Three

OPERATION

Turning the TV On and Off

Press the **POWER** button on the remote control.

You can also use the **POWER** button on the front panel.

Plug & Play Feature

When the TV is initially powered On, basic customer settings proceed automatically and subsequently: Setting the language, Antenna input check, Channel Memorize and Time Setting.

- The Plug & Play function operates after plugging in the TV for the first time.

1

Press the **POWER** button on the remote control.

The message "Plug & Play" is displayed. It flickers for a little while and then the "Language" menu is displayed.



◀ Plug & Play feature doesn't work in the AV mode.

2

Press the ◀ or ▶ button to select the desired language. Press the **MENU** button to enter the language, then the "Channel" menu is displayed.

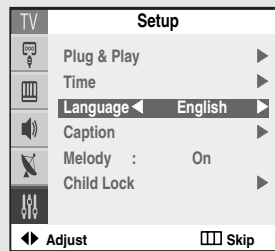

3

Press the ◀ or ▶ button to select the desired video signal source. Press the **MENU** button to enter the video signal source, then the "Check antenna input." is displayed.

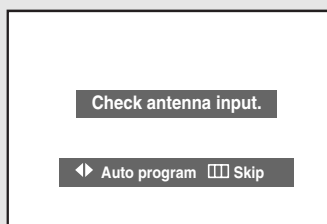
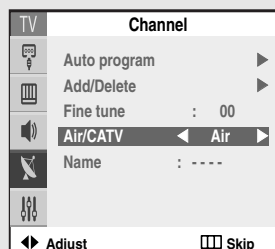

◀ STD, HRC, and IRC identify various types of cable TV systems. Contact your local cable company to identify the type of cable system that exists in your particular area.

continued...

4

Make sure that the antenna is connected to the TV. And then press the ◀ or ▶ button to activate “Auto Program” or press the **MENU** button to skip. (refer to “Auto program” on page 27.)

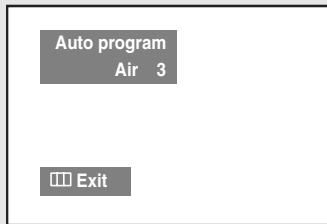

5

Press the ▶ button to move to the hour or minute. Set the hour or minute by pressing the ▲ or ▼ button. (refer to “Setting the Clock” on page 31.)

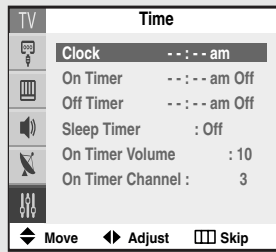

6

When you have finished, press the **MENU** button. The message “Enjoy your watching..” is displayed.

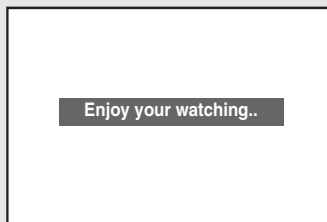

7

If you want to reset this feature

- (1) Press the **MENU** button.
- (2) Press the ▲ or ▼ button to select “Setup”, then press the **ENTER** button.
- (3) Press the **ENTER** button to select “Plug & Play”. The message “Plug & Play” is displayed.

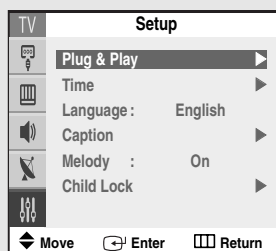

Viewing the Menus and On-Screen Displays

Viewing the Menus

1

With the power on, press the **MENU** button.

The "Input" menu appears on the screen. Its left side has five icons: Input, Picture, Sound, Channel, Setup.

Press the **▲** or **▼** button to select one of the five icons. Then press the **ENTER** button to access the icon's sub-menu.

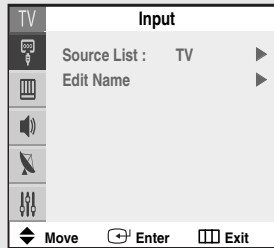

2

Press the **▲** or **▼** button to move to items in the menu. (The icon is selected.)

Press the **ENTER** or **▶** button to enter items in the menu.

Press the **▲/▼/◀/▶** button to change the selected items.

Press the **MENU** button to return to the previous menu.

3

Press the **EXIT** button to exit.

◀ You can also use the **MENU**, **VOL+/-** and **CH▲/▼** buttons on the control panel of the TV to make selections (refer to page 6).

Viewing the Display

The display identifies the current channel and the status of certain audio-video settings.

Press the **INFO** button on the remote control.

The TV displays the current channel, the channel label, signal, MTS and the current time.

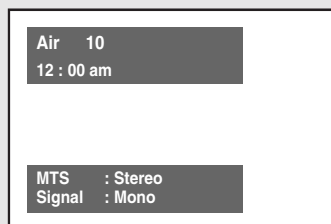

Selecting a Menu Language

1

Press the **MENU** button.

Press the **▲** or **▼** button to select "Setup", then press the **ENTER** button.

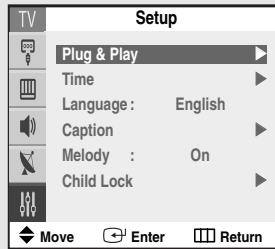

2

Press the **▲** or **▼** button to select "Language".

Press the **◀** or **▶** button to select "English", "Español" or "Français".

Press the **EXIT** button to exit.

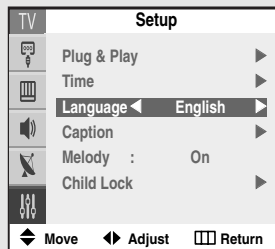

Memorizing the Channels

Your TV can memorize and store all of the available channels for both “off-air” (antenna) and cable channels. After the available channels are memorized, use the **CH** \wedge and **CH** \vee buttons to scan through the channels. This eliminates the need to change channels by entering the channel digits. There are three steps for memorizing channels: selecting a broadcast source, memorizing the channels (automatic) and adding and deleting channels (manual).

Selecting the Video Signal-source

Before your television can begin memorizing the available channels, you must specify the type of signal source that is connected to the TV (i.e., an antenna or a cable system).

1

Press the **MENU** button.

Press the \blacktriangle or \blacktriangledown button to select “Channel”, then press the **ENTER** button.

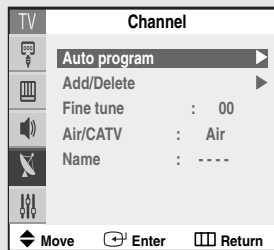

2

Press the \blacktriangle or \blacktriangledown button to select “Air/CATV”.

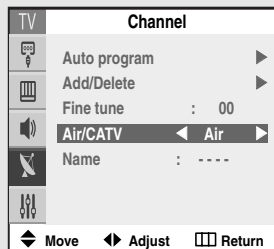

3

Press the \blacktriangleleft or \blacktriangleright button to select “Air” (antenna), “STD”, “HRC”, or “IRC” (all cable TV).

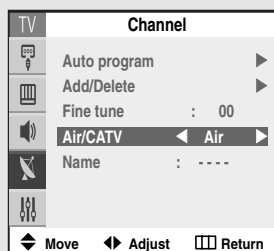

◀ STD, HRC and IRC identify various types of cable TV systems. Contact your local cable company to identify the type of cable system that exists in your particular area.

continued...

Storing Channels in Memory (Automatic Method)

4

Press the ▲ or ▼ button to select "Auto Program".

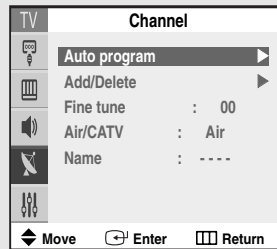

5

Press the **ENTER** button. The TV begin memorizing all available channels.

After all the available channels are stored, the channel menu reappears.

Press the **EXIT** button to exit.

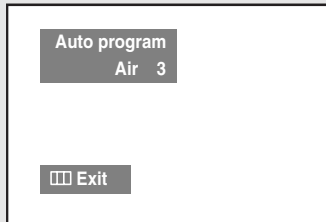

◀ The TV automatically cycles through all of the available channels and stores them in memory. This takes about one to two minutes.

Press the MENU button at any time to interrupt the memorization process and return to the Channel menu.

The TV must be connected to an antenna in order to receive digital TV signals. Even if a particular channel is deleted from the memory, you can always tune to that channel directly by using the number buttons on the remote control.

Adding and Erasing Channels (Manual Method)

To add channels that were not memorized (or to delete unwanted channels from memory):

1

Press the **MENU** button.

Press the **▲** or **▼** button to select "Channel", then press the **ENTER** button.

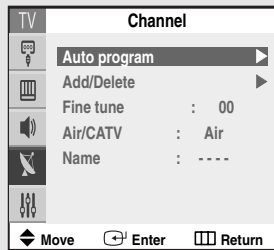

2

Press the **▲** or **▼** button to select "Add/Delete", then press the **ENTER** button.

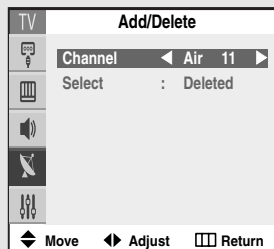

3

Press the **◀**, **▶**, or number button to select the channel you want to add or delete.



4

Press the **▲** or **▼** button to select "Select", then press the **◀** or **▶** button to select "Added" or "Deleted".

Press the **EXIT** button to exit.



Changing Channels

Using the Channel Buttons

Press the **CH** \wedge or **CH** \vee button to change channels.

When you press **CH** \wedge or **CH** \vee , the TV changes channels in sequence. You will see all the channels that the TV has memorized. (The TV must have memorized at least three channels.) You will not see channels that were either erased or not memorized.

Using the Number Buttons

Use the number buttons to quickly tune to any channel.

Press the number buttons to go directly to a channel.
For example, to select channel 27, press "2" then "7".
The TV will change channels when you press the second number.

When you use the number buttons, you can directly select channels that were either erased or not memorized.

To select a channel over 100, press the +100 button. (For channel 122, press "+100" then "2" then "2".)

To change to single-digit channels (0–9) faster, press "0" before the single digit. (For channel "4" press "0" then "4".)

Using the PRE-CH Button to Select the Previous Channel

Press the **PRE-CH** button.
The TV changes to the last channel you were watching.

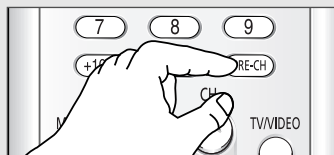

◀ To quickly switch between two channels that are far apart, tune to one channel, then use the number button to select the second channel. Then, use the **PRE-CH** button to quickly alternate between them.

Labeling the Channels

Use this feature to assign an easy-to-remember label to any channel (i.e., “CBS”, “ESPN”, “PBS2”, “CNN1”, etc.). A label consists of four fields, where each field is a letter, a number, “*”, or a blank. When the **INFO** button is pressed, the channel label will appear next to the channel number.

1

Press the **CH** \wedge or **CH** \vee button to tune to the channel that will be labeled.

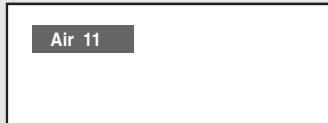

2

Press the **MENU** button.

Press the \blacktriangle or \blacktriangledown button to select “Channel”, then press the **ENTER** button.



◀ You cannot select “Name” in the AV mode.

3

Press the \blacktriangle or \blacktriangledown button to select “Name”, then press the \blacktriangleright button.

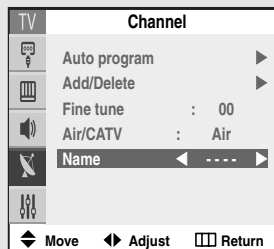

4

Press the \blacktriangle or \blacktriangledown button to select a letter, a number or a blank. (Results in this sequence: A...Z, *, blank, 0...9.)

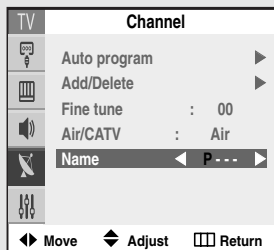

5

Press the \blacktriangleright button to switch to the next field, which will be selected. Select a second letter or digit by pressing the \blacktriangle or \blacktriangledown button, as above. Repeat the process to select the last two digits.

Press the **EXIT** button to exit.

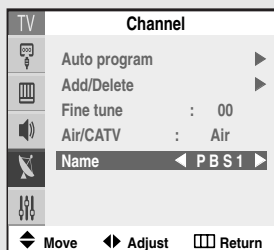

Setting the Clock

Setting the clock is necessary in order to use the various timer features of the TV. Also, you can check the time while watching the TV. (Just press the **INFO** button.)

1

Press the **MENU** button.

Press the **▲** or **▼** button to select "Setup", then press the **ENTER** button.

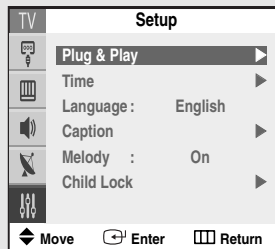

2

Press the **▲** or **▼** button to select "Time", then press the **ENTER** button.

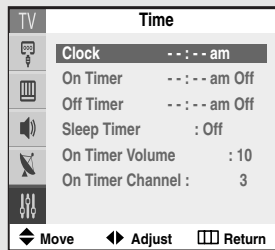

3

Press the **◀** or **▶** button to move to the hour or minute. Set the clock you want by pressing the **▲** or **▼** button, then press the **▶** button.

Press the **EXIT** button to exit.

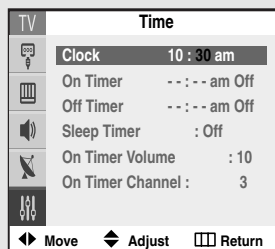

◀ When selecting the hours, be sure to select the proper time of day (am or pm).

The current time will appear every time you press the **INFO** button.

Picture Control

You can select the type of picture which best corresponds to your viewing requirements.

Using Automatic Picture Settings

Your TV has automatic picture settings (“Dynamic”, “Standard”, and “Movie”) that are preset at the factory. You can activate either Dynamic, Standard, or Movie by making a selection from the menu. Or, you can select “Custom” which automatically recalls your personalized picture settings.

1

Press the **MENU** button.

Press the **▲** or **▼** button to select “Picture”, then press the **ENTER** button.

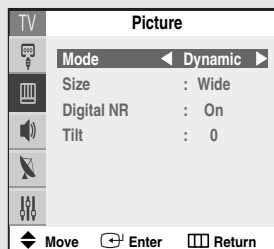

2

Press the **◀** or **▶** button to select a particular item.

Press the **EXIT** button to exit.

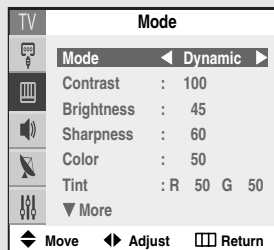

Alternate method:

Simply press the **P.MODE** button on the remote control repeatedly to select one of the standard picture settings.

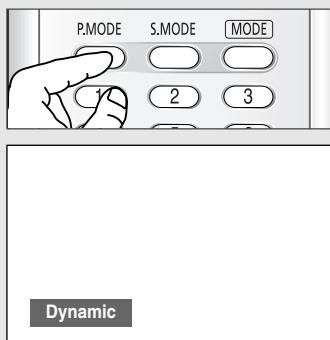

- Choose “Dynamic” for viewing the TV during the day or when there is bright light in the room.
- Choose “Standard” for the standard factory settings.
- Choose “Movie” when viewing the movie.
- Choose “Custom” if you want to adjust the settings according to personal preference.

Customizing the Picture

You can use the on-screen menus to change the “Contrast”, “Brightness”, “Sharpness”, “Color”, “Tint”, and “Color Tone” according to personal preference.

1

Press the **MENU** button.

Press the ▲ or ▼ button to select “Picture”, then press the **ENTER** button.

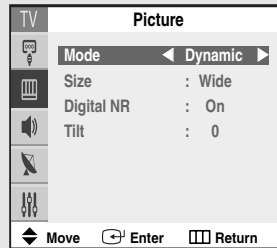

2

Press the ◀ or ▶ button to select “Mode”.

Press the ◀ or ▶ button to select a particular item (“Dynamic”, “Standard”, “Movie”, or “Custom”).

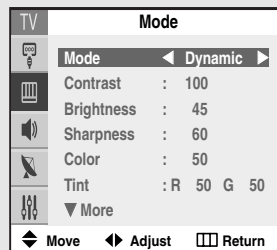

3

Press the ▲ or ▼ button to select a particular item (“Contrast”, “Brightness”, “Sharpness”, “Color”, or “Tint”).

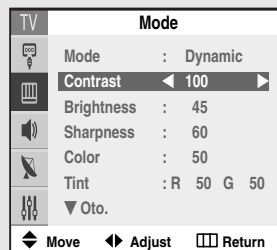

4

Press the ◀ or ▶ button to increase or decrease the value of a particular item.

Press the ▲ or ▼ button to select other items.

When you have finished, press the **MENU** button.

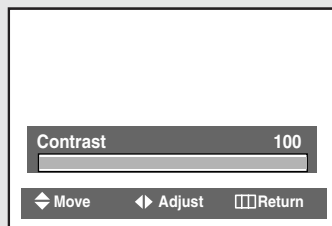

continued...

5

Press the ▲ or ▼ button to select "Color tone".

Press the ◀ or ▶ button to select a particular item ("Cool 2", "Cool 1", "Normal", "Warm 1", or "Warm 2").

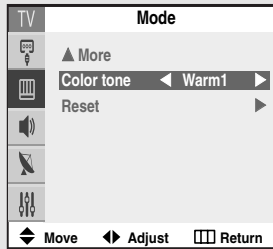

Resetting the Picture Settings to the Factory Defaults

6

Press the ▲ or ▼ button to select "Reset", then press the **ENTER** button.

The reset function is set for each mode ("Dynamic", "Standard", "Movie", or "Custom").

The previously adjusted settings will be reset to the factory defaults.

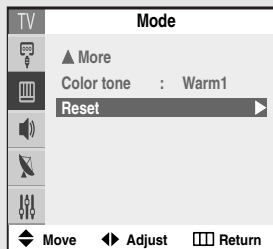

Sound Control

Adjusting the Volume

Press the **VOL +** or **VOL -** button to increase or decrease the volume.

Using the MUTE Button

At any time, you can temporarily cut off the sound using the **MUTE** button.

- 1** Press the **MUTE** button and the sound cuts off. "Mute" is displayed.

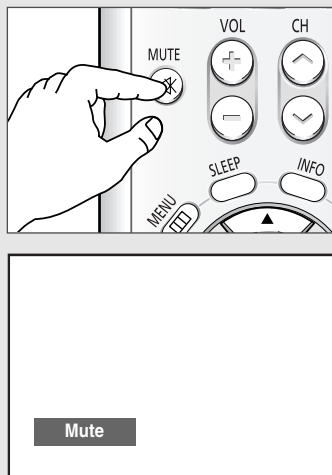

- 2** To turn MUTE off, press the **MUTE** button again, or press either the **VOL +** or **VOL -** button.

Using Automatic Sound Settings

Your TV has automatic sound settings (“Standard”, “Music”, “Movie”, and “Speech”) that are preset at the factory. You can activate either Standard, Music, Movie or Speech by making a selection from the menu. Or, you can select “Custom,” which automatically recalls your personalized sound settings.

1

Press the **MENU** button.

Press the **▲** or **▼** button to select “Sound”, then press the **ENTER** button.

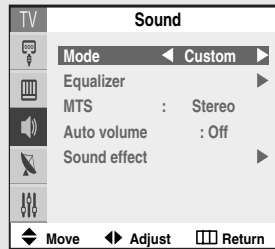

2

Press the **◀** or **▶** button to select a particular item.

Press the **EXIT** button to exit.

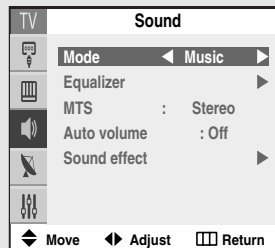

Alternate method:

Press the **S.MODE** button on the remote control repeatedly to select one of the standard sound settings.

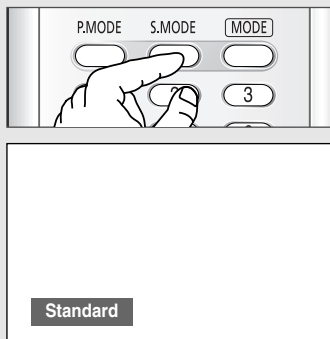

- Choose “Standard” for the standard factory settings.
- Choose “Music” when watching music videos or concerts.
- Choose “Movie” when watching movie.
- Choose “Speech” when watching a show that is mostly dialogue (i.e., news).
- Choose “Custom” to recall your personalized settings.

Customizing the Sound

The sound settings can be adjusted to suit your personal preferences. (Alternatively, you can use one of the “automatic” settings. See page 36.)

1

Press the **MENU** button.

Press the **▲** or **▼** button to select “Sound”, then press the **ENTER** button.

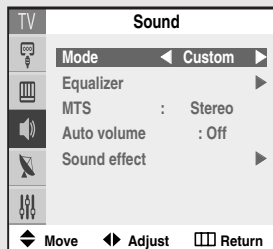

2

Press the **▲** or **▼** button to select “Equalizer”, then press the **ENTER** button.

Press the **◀** or **▶** button to select a particular item.

Press the **▲** or **▼** button to increase or decrease the value of a particular item.

Press the **EXIT** button to exit.

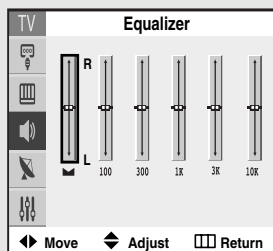

- If you make any changes to the equalizer settings, the sound mode is automatically switched to the “Custom” mode.
- “L/R” Sound Balance Adjustment
To adjust the sound balance of the L/R speakers.
- Bandwidth Adjustment (100, 300, 1K, 3K, 10K)
To adjust the level of different bandwidth frequencies.

Viewing an External Signal Source

Use the remote control to switch between viewing signals from connected equipment, such a VCR, DVD, set-top box and the TV source (broadcast or cable).

Setting the Signal Source

1

Press the **MENU** button.

Press the **ENTER** button to select "Input".

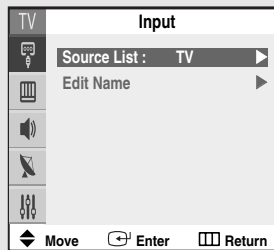

2

Press the **ENTER** button to select "Source List".

Press the **▲** or **▼** button to select the signal source, then press the **ENTER** button

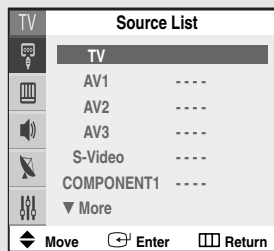

◀ When you connect equipment to the TV, you can choose between the following sets of jacks : AV1, AV2, AV3, S-Video COMPONENT1, or COMPONENT2 on the TV's rear panel, and AV1 on the TV's side panel.

Alternate method:
Press the **TV/VIDEO** button on the remote control to select an external signal source.

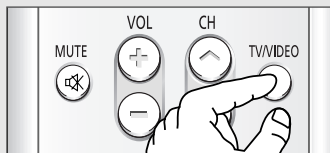

Assigning Names to External Input Mode

1

Press the **MENU** button.

Press the **ENTER** button to select "Input".

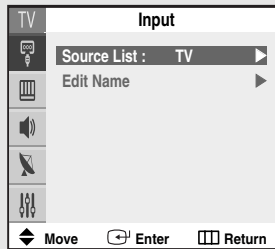

2

Press the **▲** or **▼** button to select "Edit Name", then press the **ENTER** button.

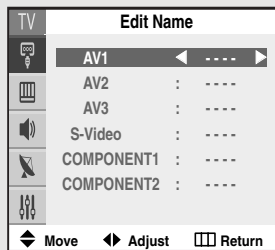

3

Press the **▲** or **▼** button to select the signal source to be edited.

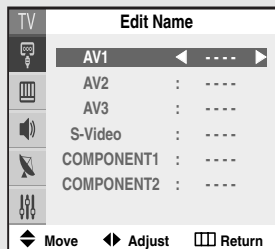

4

Press the **◀** or **▶** button to select the external device (VCR, DVD, Cable STB, Sat. STB, AV Recv., DVD Recv., Game, Camcorder, DVD Combo).

Set other signal sources (AV1, AV2, AV3, S-Video, COMPONENT1, COMPONENT2) using the same method as listed above.

Press the **EXIT** button to exit.

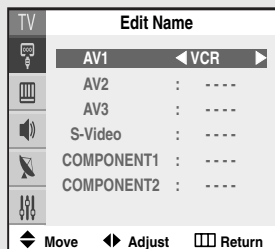

Chapter Four

SPECIAL FEATURES

Fine Tuning Channels

The Fine Tuning function lets you manually adjust the TV's tuner if you have difficulty tuning channels.

1

Press the **MENU** button.

Press the **▲** or **▼** button to select "Channel", then press the **ENTER** button.

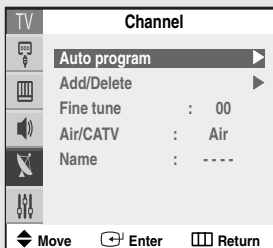

2

Press the **▲** or **▼** button to select "Fine tune".

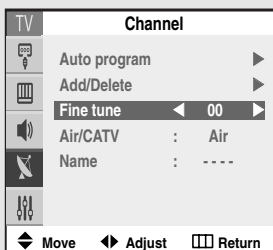

3

Press the **◀** or **▶** button to adjust the fine tuning.

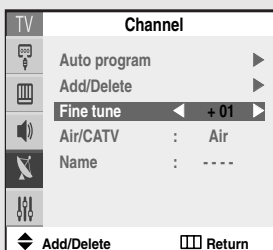

4

To store the fine tuning setting in the TV's memory, press the **▲** button. (The "*" is displayed.)

To reset the fine tuning to "00", press the **▼** button.

Press the **EXIT** button to exit.

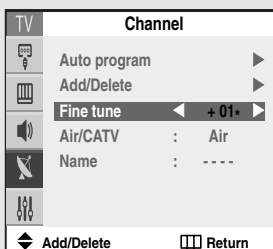

◀ After you adjust the fine tuning, the "*" will appear when you press the **INFO** button while watching this channel.

Changing the Screen Size (depending on the model)

1

Press the **MENU** button.

Press the **▲** or **▼** button to select "Picture", then press the **ENTER** button.

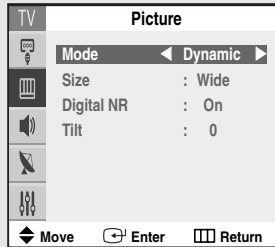

2

Press the **▲** or **▼** button to select "Size".

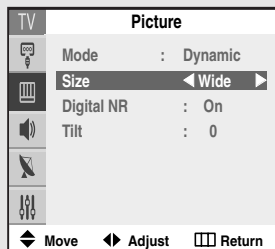

3

Press the **◀** or **▶** button to select the screen format you want.

Press the **EXIT** button to exit.

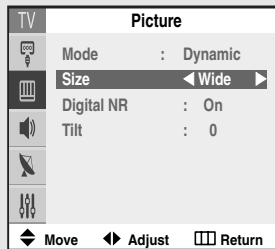

Alternate method:

Press the **P.SIZE** button on the remote control to screen formats you want.

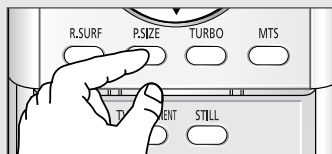

Wide

- **Wide:** Sets the picture to 16:9 wide mode.
- **Panorama:** Use this mode for the wide aspect ratio of a panoramic picture.
- **Zoom1:** Magnifies the size of the picture on screen.
You can also move the picture on screen by pressing the **▲** or **▼** button after pressing the **P.SIZE** button on the remote control.
- **Zoom2:** Magnifies the size of the picture more than Zoom1.
You can also move the picture on screen by pressing the **▲** or **▼** button after pressing the **P.SIZE** button on the remote control.
- **4:3(Normal):** Sets the picture to 4:3 normal mode.

Digital Noise Reduction

If the broadcast signal received by your TV is weak, you can activate the Digital Noise Reduction feature to help reduce any static and ghosting that may appear on the screen.

1

Press the **MENU** button.

Press the **▲** or **▼** button to select "Picture", then press the **ENTER** button.

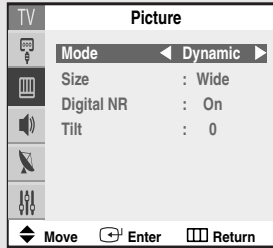

2

Press the **▲** or **▼** button to select "Digital NR".

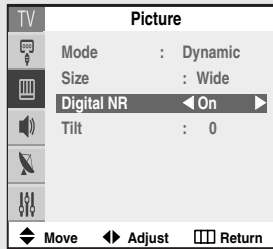

3

Press the **◀** or **▶** button to select "On" or "Off".

Press the **EXIT** button to exit.

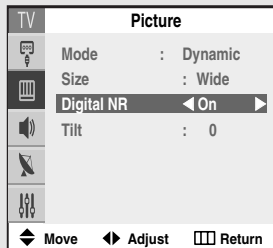

Tilt

Due to the Earth's magnetic field there may be some minor image tilt depending on the TV's location. When this occurs, follow the steps below.

1

Press the **MENU** button.

Press the **▲** or **▼** button to select "Picture", then press the **ENTER** button.

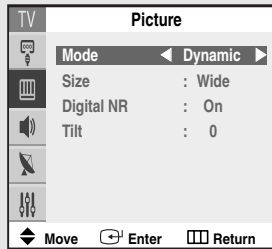

2

Press the **▲** or **▼** button to select "Tilt".

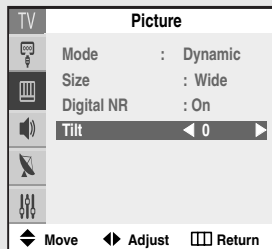

3

Press the **◀** or **▶** button to adjust the Tilt.

Press the **EXIT** button to exit.

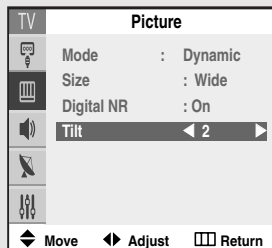

Using the R.Surf Feature

This feature allows you to set the TV to return to a particular channel after a certain amount of time. For example, you may be watching a channel when commercials start. You can set the R.Surf to “5 minutes”, then switch channels. After 5 minutes, the TV will return to the original channel. To use the R.Surf feature:

1

While you are watching the channel to which you want to return, press the **R.SURF** button. The on-screen display will read “Surf off”.

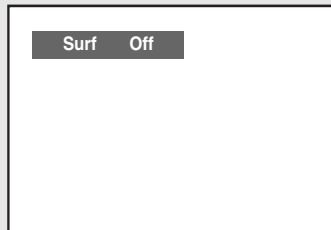
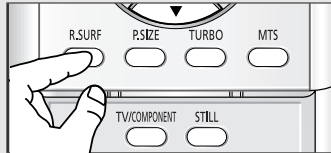

2

Press the **R.SURF** button again to set the timer in thirty second intervals, up to five minutes.



◀ The time will start decreasing while you are setting up the timer, and will reset after 5 minutes had passed or you turn it off.

3

The time you set will begin counting down on the screen. When the time runs out, the TV will return to the channel you were watching when you set the timer.

Freezing the Picture

Press the **STILL** button to freeze a moving picture. (normal sound will still be heard.)

Press again to cancel.

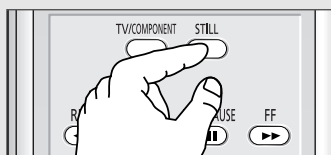

◀ The still function doesn't operate in the COMPONENT mode.

Choosing a Multi-Channel Sound (MTS) track

Depending on the particular program being broadcast, you can listen to Mono, Stereo, or SAP.

1

Press the **MENU** button.

Press the **▲** or **▼** button to select "Sound", then press the **ENTER** button.

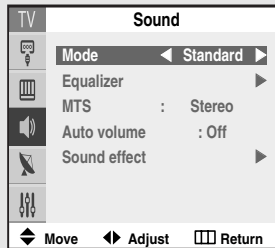

2

Press the **▲** or **▼** button to select "MTS".

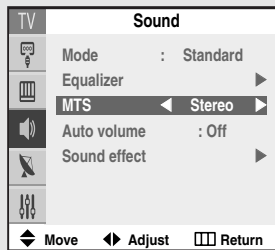

3

Press the **◀** or **▶** button to select a setting you want.

Press the **EXIT** button to exit.

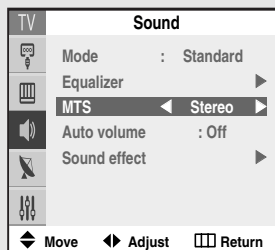

Alternate method:

Press the **MTS** button on the remote control to select one of the settings.

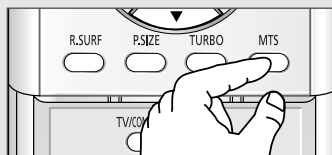

- Choose "Mono" for channels that are broadcasting in mono, or if you are having difficulty receiving a stereo signal.
- Choose "Stereo" for channels that are broadcasting in stereo.
- Choose "SAP" to listen to the Separate Audio Program, which is usually a foreign-language translation.

Auto Volume

Each broadcasting station has its own signal conditions, and it is inconvenient to adjust the volume every time the channel is changed. “Auto Volume” automatically adjusts the volume of the desired channel by lowering the sound output when the modulation signal is high or by raising the sound output when the modulation signal is low.

1

Press the **MENU** button.

Press the **▲** or **▼** button to select “Sound”, then press the **ENTER** button.

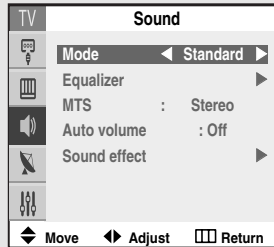

2

Press the **▲** or **▼** button to select “Auto volume”.

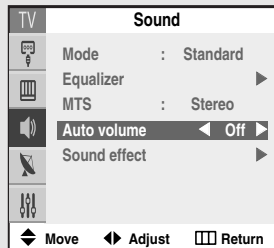

3

Press the **◀** or **▶** button to select “On” or “Off”.

Press the **EXIT** button to exit.

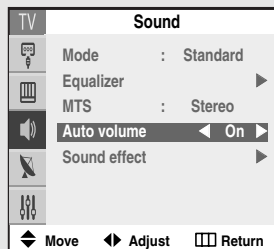

Setting the Surround

Your Samsung TV can create a “surround” effect such that the sound seems to come from all directions. Once the “Surround” is set to “On”, the setting applies to sound effects such as “Standard”, “Music”, “Movie”, and “Speech”.

1

Press the **MENU** button.

Press the **▲** or **▼** button to select “Sound”, then press the **ENTER** button.

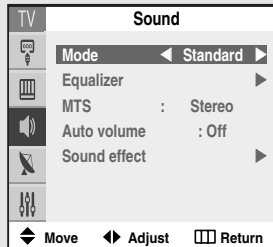

2

Press the **▲** or **▼** button to select “Sound effect”, then press the **ENTER** button.

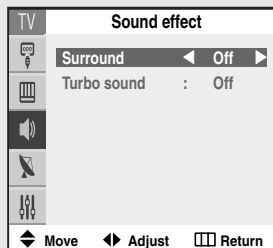

3

Press the **◀** or **▶** button to select “On” or “Off”.

Press the **EXIT** button to exit.

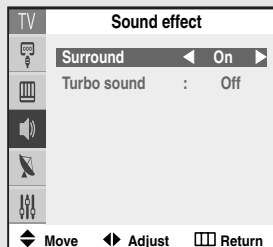

Setting the Turbo Sound

Turbo sound emphasizes the bass and treble frequencies to add fullness to the sound.

1

Press the **MENU** button.

Press the **▲** or **▼** button to select "Sound", then press the **ENTER** button.

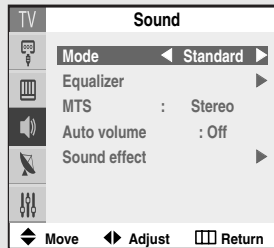

2

Press the **▲** or **▼** button to select "Sound effect", then press the **ENTER** button.

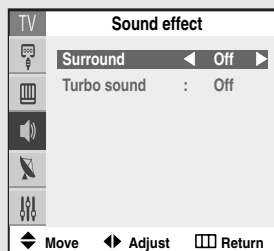

3

Press the **▲** or **▼** button to select "Turbo sound".

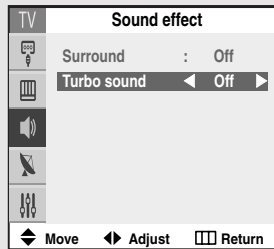

4

Press the **◀** or **▶** button to select "On" or "Off".

Press the **EXIT** button to exit.

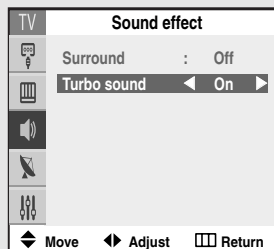

Alternate method:

Press the **TURBO** button on the remote control to select the Turbo sound setting.

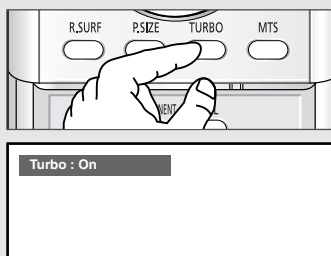

Setting the On/Off Timer

1

Press the **MENU** button.

Press the **▲** or **▼** button to select "Setup", then press the **ENTER** button.

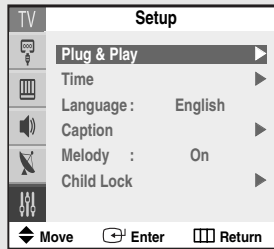

◀ Before using the timer, you must set the TV's clock. (See "Setting the Clock" on page 31).

2

Press the **▲** or **▼** button to select "Time", then press the **ENTER** button.

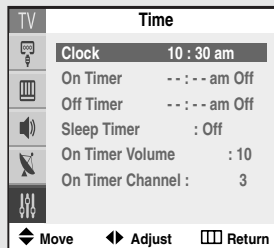

3

Press the **▲** or **▼** button to select "On Timer".

Press the **◀** or **▶** button to move the hour or minute.
Set the clock you want by pressing the **▲** or **▼** button.

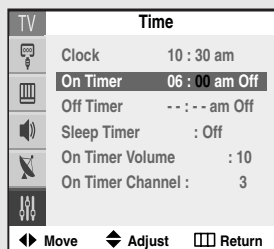

◀ The current time will appear every time you press the **INFO** button.

4

Press the **◀** or **▶** button to select "On" or "Off".

Press the **▲** or **▼** button to turn the on-timer "On". (To deactivate the "On Timer", select "Off".)
When finished, press the **▶** button.

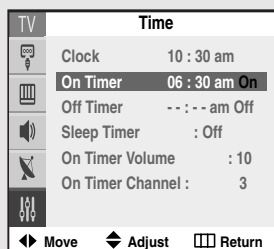

5

To set the Off Timer, press the **▲** or **▼** button to select "Off Timer".
Follow the same procedure as in steps 3-4 above.

Press the **EXIT** button to exit.

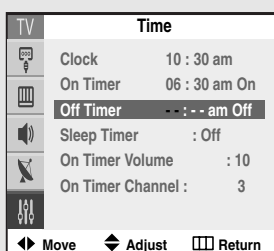

◀ **Auto Power Off**
When you set the timer "On", the television will eventually turn off, if no controls are operated for 3 hours after the TV was turned on by timer. This function is only available in timer "On" mode and prevents overheating or leakages, which may occur if a TV is on for too long (on holiday, for example).

Setting the Sleep Timer

The sleep timer automatically shuts off the TV after a preset time (from 30 to 180 minutes).

1

Press the **MENU** button.

Press the **▲** or **▼** button to select "Setup", then press the **ENTER** button.

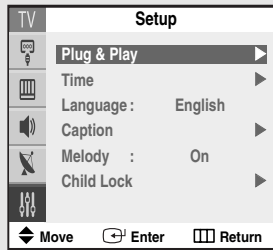

2

Press the **▲** or **▼** button to select "Time", then press the **ENTER** button.

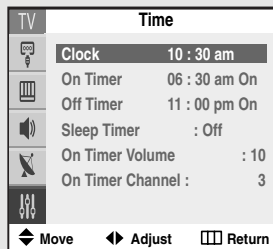

3

Press the **▲** or **▼** button to select "Sleep Timer".

Press the **◀** or **▶** button repeatedly until the appropriate time interval appears (any of the preset values from "Off" to "180").

Press the **EXIT** button to exit.

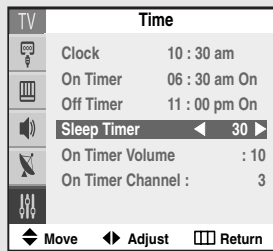

Alternate method:

Press the **SLEEP** button repeatedly until the appropriate time interval appears (any of the preset values from "Off" to "180").



◀ After about 5 seconds, the sleep display will disappear from the screen, and the time interval will be set.

Setting the Preferred Volume Level and Channel

The preferred volume and channel can be set for when the timer automatically turns on the TV.

1

Press the **MENU** button.

Press the **▲** or **▼** button to select "Setup", then press the **ENTER** button.

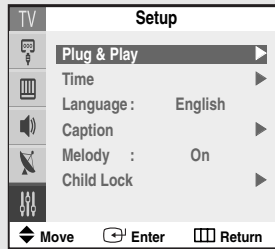

2

Press the **▲** or **▼** button to select "Time", then press the **ENTER** button.

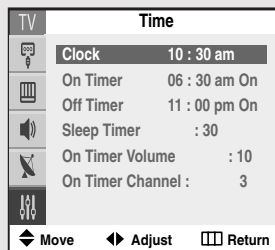

3

Press the **▲** or **▼** button to select "On Timer Volume".

Press the **◀** or **▶** button to adjust volume level.

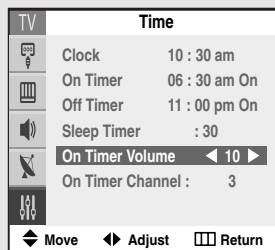

4

Press the **▲** or **▼** button to select "On Timer Channel".

Press the **◀** or **▶** button to select the channel you want.

Press the **EXIT** button to exit.

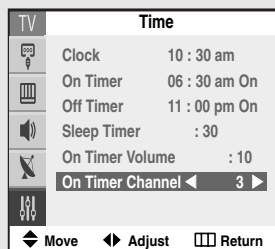

Viewing Closed Captions (On-Screen Text Messages)

Your TV decodes and displays the closed captions that are broadcast with certain TV shows. These captions are usually subtitles for the hearing impaired or foreign-language translations. All VCRs record the closed caption signal from television programs, so home-recorded video tapes also provide closed captions. Most pre-recorded commercial video tapes provide closed captions as well. Check for the closed caption symbol in your television schedule and on the tape's packaging: .

1
Press the **MENU** button.

Press the **▲** or **▼** button to select "Setup", then press the **ENTER** button.

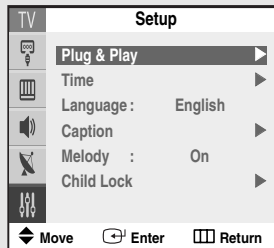

2
Press the **▲** or **▼** button to select "Caption", then press the **ENTER** button.

Press the **◀** or **▶** button to select "On".

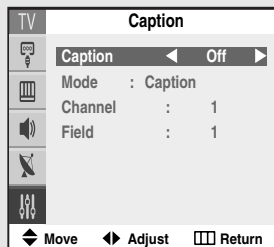

3
Press the **▲** or **▼** button to select "Mode".
Press the **◀** or **▶** button to select "Caption" or "Text".

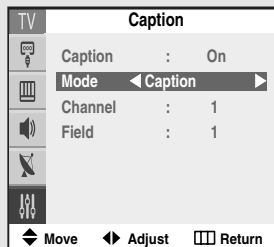

4
Press the **▲** or **▼** button to select "Channel" or "Field".
Press the **◀** or **▶** button to select "1" or "2".

Press the **EXIT** button to exit.

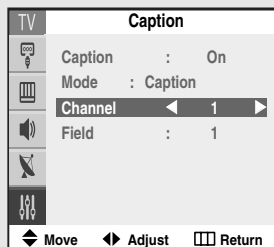

◀ Misspellings and unusual characters sometimes occur during closed caption transmissions, especially those of live events. There may be a small delay before captions appear when you change channels. These are not malfunctions of the TV.

◀ In "Caption" mode, captions appear at the bottom of the screen, and they usually cover only a small portion of the picture.

In "Text" mode, information unrelated to the program, such as news or weather, is displayed. Text often covers a large portion of the screen.

◀ Depending on the particular broadcast, it might be necessary to make changes to "Channel" and "Field".

◀ Different channels and fields display different information: "Field 2" carries additional information that supplements the information in "Field 1". (For example, "Channel 1" may have subtitles in English, while "Channel 2" has subtitles in Spanish.)

Locking the Channel

This feature allows you to prevent unauthorized users, such as children, from watching unsuitable programmes by muting out video and audio. Child Lock cannot be released using front (or side) panel buttons. Only remote control can release the Child Lock setting, so keep the remote control away from children.

1

Press the **MENU** button.

Press the **▲** or **▼** button to select "Setup", then press the **ENTER** button.

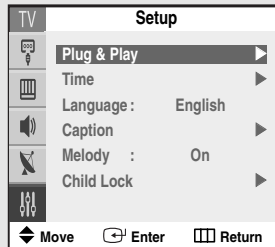

2

Press the **▲** or **▼** button to select "Child Lock", then press the **ENTER** button.

Press the **◀** or **▶** button to select "On".



◀ If you want to unlock a channel, set to "Off".

3

Press the **▲** or **▼** button to select "Channel".

Press the **◀** or **▶** button to select the channel to be locked.



4

Press the **▲** or **▼** button to select "Lock". Press the **◀** or **▶** button to select "Unlocked" or "Locked".

Press the **EXIT** button to exit.



◀ If any channel is locked, you can not access to the "Channel" and "Child Lock" menu by using the control buttons on the TV panel (the "Not Available" is displayed in the "Child Lock" menu). You can access by using the remote control only.

Setting the On/Off Melody

You can hear a melody sound when the TV is powered On or Off.

1

Press the **MENU** button.

Press the **▲** or **▼** button to select "Setup", then press the **ENTER** button.

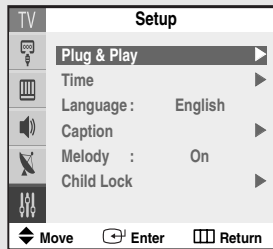

2

Press the **▲** or **▼** button to select "Melody".

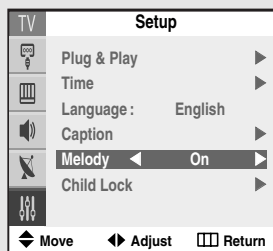

3

Press the **◀** or **▶** button to select "On" or "Off".

Press the **EXIT** button to exit.

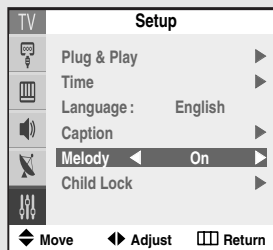

Customizing Your Remote Control

Your TV comes equipped with a universal remote control. In addition to controlling the TV, the universal remote control can also operate a VCR, Cable box, DVD, and some Samsung Set-top boxes (even if your VCR, Cable box and DVD are made by manufacturers other than Samsung).

Setting Up Your Remote Control to Operate Your VCR (Cable box or DVD player)

1

Turn off your VCR (Cable box or DVD player).

2

Press the **MODE** button to switch the remote control to the **VCR (CABLE or DVD)** mode.

◀ The remote control has five modes: **TV**, **STB**, **VCR**, **CABLE**, and **DVD**.

3

On your Samsung remote control, press the **SET** button.

4

Enter 3 digits of the VCR (Cable box or DVD player) code listed on next page for your brand of VCR (Cable box or DVD player).

◀ Make sure you enter 3 digits of the code, even if the first digit is a "0". (If more than one code listed, try the first one.)

5

Press the **POWER** button on the remote control. Your VCR (Cable box or DVD player) should turn on. If your VCR (Cable box or DVD player) turns on, your remote control is now set correctly.

◀ If your VCR (Cable box or DVD player) does not turn on, repeat steps 2, 3, and 4, but try one of the other codes listed for the brand of your particular VCR (Cable box or DVD player).

6

Once your remote control is set up, press the **MODE** button any time you want to use the remote to operate your VCR (Cable box or DVD player).

- When your remote is in the **TV** mode, the VCR (or DVD player) control buttons (**REW**, **STOP**, **PLAY/PAUSE**, and **FF**) will still operate your VCR (or DVD player).
- When your remote control is in the **STB**, **VCR**, **CABLE**, or **DVD** mode, the volume buttons still control your TV's volume.

SPECIAL FEATURES

Remote Control Codes

VCR Codes

Admiral	015,088	Hitachi	014,024,044,045	Quasar	017,053
Aiwa	024	Instant Replay	017	Radio Shack	011,015,017,018,021,024,028,036,052,062
Akai	026,031,032	JC Penny	011,014,016,017,023,025,039,044,060,062	RCA	009,014,016,017,037,044,046,063,078
Audio Dynamics	022,025	JCL	011,017,023,025,039,055	Realistic	011,015,017,018,021,024,028,036,052,062
Bell & Howell	011	Kenwood	011,023,025,039,055	Samsung	000,016,022,031,041,051
Broksonic	019	KLH	082	Sansui	025
Candle	016,018,022,054,055,061	LG(Goldstar)	001,002,007,018,023,055,069	Sonyo	011,021
Canon	017,062	Lloyd	024	Scott	022,050,058,077
Citizzen	016,018,022,054,055,061	Logik	040	Sears	011,014,018,021,027,028,044,052,057
ColorTyme	023	LXI	024	Sharp	015,036,048,054
Craig	016,021	Magnavox	017,038,062,065	Shintom	017,024,038,062,065
Curtis Mathes	009,016,017,023,024,055,062,073,076	Marantz	011,017,023,025,038,039,055,070	Signature	024
Daewoo	003,004,005,006,007,008,022,054,085	MTC	016,024	Sony	026,035,047
DB	023,025	Multitech	016,024,040,041	Sylvania	017,024,038,062,065
Dimensia	009	NEC	011,023,025,039,055,070,073	Symphonic	024
Dynatech	024	Optimus	015	Tandy	011,024
Electrohome	036	Panasonic	017,062,084,086	Tatung	039
Emerson	017,018,019,022,024,029,032,036,043,050,051,056,058,066,071,074,076,077,079	Pentax	014,044	Teac	024,039,078
Fisher	011,021,027,028,052,057,067	Pentax Research+	055	Technics	017
Funai	024	Philco	017,038,062,065	Teknika	017,018,024,030
General Electric	009,016,017,041,062	Philips	017,038	TMK	076
Go Video	016	Pioneer	014,025,042,059	Toshiba	014,022,028,057,058
Harman Kardon	023	Portland	053,054,061	Toshiko	018
		PROSCAN	009	Totevision	016,018
		Quartz	011		

Cable Box Codes

Anvision	015,016	Magnavox	015,016,027,029,034,036,037,040,041,048,049	Signature	054
Cable Star	015,016	Nawoo	001	Sprucer	035
Daehan	005	NSC	017	Starcom	054
DeaRyung	003	Oak	024,046	Stargate2000	066
DongKuk	004	Osk Sigma	024	Sylvania	019,067
Eagle	015,016	Panasonic	011,035,047,069	TaePyungYang	002
Eastern International	020	Philips	015,016,027,029,034,036,037,040,041,048,049	Texscan	019,067
General Instrument	054	Pioneer	026,028,052	Tocom	025,029,057,058,063
GI	012,013,023,031,032,033,038,044,075,076,077	Randtek	015,016	Unika	039,040,049
Hamlin	011,012,020,021,042,056	RCA	008,035,074	Universal	059,060
Hitachi	045,051,054	Regal	011,020,021	Viewstar	015,016,027,029,034,036,037,040,041,048,049
Jerrold	012,013,023,031,032,033,038,044,054,070,073	Regency	010,041	Warner Amex	052
LG(Goldstar)	006	Saewoo	007	Zenith	022,050,065,069
Macom	045,051	Samsung	000,011,030,052,071,072		

DVD Codes

Curtis Mathes	009	Philips	007	Sharp	005
JVC	003	PROSCAN	008	Sony	004
LG(Goldstar)	001	RCA	008	Toshiba	002
Panasonic	006	Samsung	000		

Chapter Five

TROUBLESHOOTING

If the TV seems to have a problem, first try this list of possible problems and solutions. If none of these troubleshooting tips apply, then call your nearest Samsung authorized service center.

Identifying Problems

Problem	Possible Solution
Poor picture.	Try another channel. Adjust the antenna. Check all wire connections.
Poor sound quality.	Try another channel. Adjust the antenna.
No picture or sound.	Try another channel. Press the TV/VIDEO button. Make sure the TV is plugged in. Check the antenna connections. Make sure the MUTE button is off.
No color, wrong colors or tints.	Make sure the program is broadcast in color. Adjust the picture settings.
Picture rolls vertically.	Adjust the antenna. Check all wire connections. If you are using a VCR, check the tracking.
The TV operates erratically.	Unplug the TV for 30 seconds, then try operating it again.
Your remote control does not operate your TV.	Press the MODE button to put your remote control in the "TV" mode. Make sure the remote has batteries. Check that the "+" and "-" ends of the batteries are inserted correctly. Check that the batteries are drained.
The TV won't turn on.	Make sure the wall outlet is working. Make sure the TV is plugged in. Make sure the remote has batteries.
The visual qualities of digital channels vary.	The visual qualities of digital channels may vary depending on the original production method (analog or digital). <ul style="list-style-type: none">• If the original production method is digital: High visual quality program.• If the original production method is analog: The digital program displayed on the screen is originally an analog program which has been converted to digital. The visual quality is of an SD grade visual quality.
Although the TV caption shows HD, the visual quality is not satisfactory.	The HD caption that appears when switching channels or when pressing the Information button on the remote control means the selected channel is a digital channel. If the broadcasting station converts an analog signal into digital and transmits the signal, the visual quality may not be perfect.

Appendix

APPENDIX

Cleaning and Maintaining Your TV

Please follow these guidelines to get the maximum performance from your TV.

Placement

- Do not place the TV near extremely hot, cold, humid or dusty places.
- Do not place the TV near appliances with electric motors that create magnetic fields, such as vacuum cleaners.
- Keep the ventilation openings clear; do not place the TV on a soft surface, such as cloth or paper.
- Place the TV in a vertical position only.

Liquids

- Do not handle liquids near or on the TV. Liquids that spill into it can cause serious damage.

Cabinet

- Never open the cabinet or touch the parts inside.
- Wipe your TV with a clean, dry cloth. Never use water, cleaning fluids, wax, or chemicals.
- Do not put heavy objects on top of the cabinet.

Temperature

- If your TV is suddenly moved from a cold to a warm place, unplug the power cord, and allow at least two hours for moisture that may have formed inside the unit to dry completely.

Using Your TV in Another Country

If you plan to take your TV with you to a foreign country, please be aware of the different television systems that are in use around the world. A TV designed for one system may not work properly with another system due to differences in the TV channel frequencies.

Specifications

Model	Voltage	Frequency of Operation	Power Consumption	Dimensions (mm/inches)	Weight (Kg/lbs)
CL-29M30HS	AC100-240V	50/60 Hz	105 Watts	776 x 505 x 575/ 30.6 x 19.9 x 22.6	42.5 / 93.7
CL-32M30HS	AC100-240V	50/60 Hz	105 Watts	920 x 562 x 560/ 36.2 x 22.1 x 22.0	53.8 / 118.6
CL-34M30HS	AC100-240V	50/60 Hz	105 Watts	920 x 562 x 685/ 36.2 x 22.1 x 27.0	64.0 / 141.1
CL-29Z30HS	AC100-240V	50/60 Hz	160 Watts	905 x 510 x 720/ 35.6 x 20.1 x 28.4	43 / 94.8

***This page is intentionally
left blank.***



Contact SAMSUNG WORLD-WIDE

If you have any questions or comments relating to Samsung products, please contact the SAMSUNG customer care center.

Country	Customer Care Center ☎	Web Site
ARGENTINE	0800-333-3733	www.samsung.com/ar
BRAZIL	0800-124-421	www.samsung.com/br
CHILE	800-726-7864 (SAMSUNG)	www.samsung.com/cl
COSTA RICA	0-800-507-7267	www.samsung.com/latin
ECUADOR	1-800-10-7267	www.samsung.com/latin
EL SALVADOR	800-6225	www.samsung.com/latin
GUATEMALA	1-800-299-0013	www.samsung.com/latin
JAMAICA	1-800-234-7267	www.samsung.com/latin
MEXICO	01-800-SAMSUNG (7267864)	www.samsung.com/mx
PANAMA	800-7267	www.samsung.com/latin
PUERTO RICO	1-800-682-3180	www.samsung.com/latin
REP. DOMINICA	1-800-751-2676	www.samsung.com/latin
TRINIDAD & TOBAGO	1-800-7267-864	www.samsung.com/latin
VENEZUELA	1-800-100-5303	www.samsung.com/latin

Free Manuals Download Website

<http://myh66.com>

<http://usermanuals.us>

<http://www.somanuals.com>

<http://www.4manuals.cc>

<http://www.manual-lib.com>

<http://www.404manual.com>

<http://www.luxmanual.com>

<http://aubethermostatmanual.com>

Golf course search by state

<http://golfingnear.com>

Email search by domain

<http://emailbydomain.com>

Auto manuals search

<http://auto.somanuals.com>

TV manuals search

<http://tv.somanuals.com>