



**CL15K5MN  
CL17M6MQ**

**COLOR TELEVISION**



# **Owner's Instructions**

## CONTENTS

<b>Chapter 1: Your New TV</b> . . . . .	<b>4</b>
List of Features . . . . .	4
Familiarizing Yourself with The TV . . . . .	5
Front Panel Buttons . . . . .	5
Side Panel Jacks . . . . .	6
Rear Panel Jacks . . . . .	7
Remote Control . . . . .	8
<b>Chapter 2: Installation</b> . . . . .	<b>9</b>
Connecting VHF and UHF Antennas . . . . .	9
Antennas with 300-ohm Flat Twin Leads . . . . .	9
Antennas with 75-ohm Round Leads . . . . .	10
Separate VHF and UHF Antennas . . . . .	10
Connecting Cable TV . . . . .	10
Cable without a Cable Box . . . . .	10
Connecting to a Cable Box that Descrambles All Channels . . . . .	11
Connecting to a Cable Box that Descrambles Some Channels . . . . .	11
Connecting a VCR . . . . .	13
Connecting a DVD Player . . . . .	14
Connecting a Camcorder . . . . .	15
Installing Batteries in the Remote Control . . . . .	16
<b>Chapter 3: Operation</b> . . . . .	<b>17</b>
Turning the TV On and Off . . . . .	17
Viewing the Menus and On-Screen Displays . . . . .	17
Viewing the Menu . . . . .	17
Viewing the Display . . . . .	17
Selecting a Menu Language . . . . .	18
Memorizing the Channels . . . . .	19
Selecting the Video Signal-source . . . . .	19
Storing Channels in Memory (Automatic Method) . . . . .	20
Adding and Erasing Channels (Manual Method) . . . . .	21
Changing Channels . . . . .	22
Using the Channel Buttons . . . . .	22
Directly Accessing Channels . . . . .	22
Using the PRE-CH Button to select the Previous Channel . . . . .	22
Channel Scan . . . . .	22
Customizing the Picture . . . . .	23
Using Automatic Picture Settings . . . . .	24
Adjusting the Volume . . . . .	25
Using Mute . . . . .	25
Customizing the Sound . . . . .	25
Using Automatic Sound Settings . . . . .	26
Setting the Clock . . . . .	27
Viewing a VCR or Camcorder Tape . . . . .	28

CONTENTS

- Chapter 4: Special Features . . . . . 29**
  - Fine Tuning Channels . . . . . 29
  - Selecting the Color Tone . . . . . 30
  - Changing the Screen Size . . . . . 31
  - Using the Surf Feature . . . . . 32
  - Choosing a Multi-Channel Sound (MTS) Soundtrack . . . . . 33
  - Extra Sound Settings . . . . . 34
  - Setting the On/Off Timer . . . . . 35
  - Setting the Sleep Timer . . . . . 36
  - Viewing Closed Captions . . . . . 37
  
- Chapter 5: Troubleshooting . . . . . 38**
  - Identifying Problems . . . . . 38
  
- Appendix . . . . . 39**
  - Cleaning and Maintaining Your TV . . . . . 39
  - Using Your TV in Another Country . . . . . 39
  - Specifications . . . . . 39

# Chapter One

## YOUR NEW TV

### List of Features

Your TV was designed with the latest technology. This TV is a high-performance unit that includes the following special features:

- Easy-to-use remote control
- Easy-to-use on-screen menu system
- Automatic timer to turn the TV on and off
- Adjustable picture and sound settings that can be stored in the TV's memory
- Automatic channel tuning for up to 181 channels
- A special filter to reduce or eliminate reception problems
- Fine tuning control for the sharpest picture possible
- Built-in, dual channel speakers
- A special sleep timer
- Surround, Turbo Sound, Auto Volume

## YOUR NEW TV

# Familiarizing Yourself with The TV

### Front Panel Buttons

The buttons on the front panel control your TV's basic features, including the on-screen menu. To use the more advanced features, you must use the remote control.

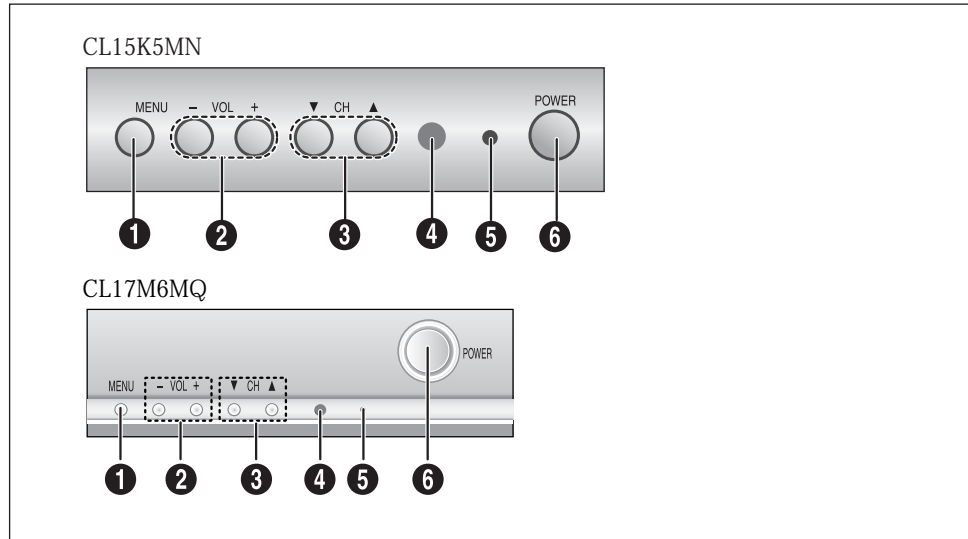

- ⌂ **MENU**  
Press to see an on-screen menu of your TV's features.
- ⏪ **VOL - , +**  
Press to increase or decrease the volume.  
Also used to select items on the on-screen menu.
- ⏩ **CH ▼ and CH ▲**  
Press to change channels. Also press to select various items on the on-screen menu.
- ⌂ **Remote Control Sensor**  
Aim the remote control towards this spot on the TV.
- ⏻ **STAND BY indicator**  
Lights up when you turn the power off.
- ⏻ **POWER**  
Press to turn the TV on and off.

## YOUR NEW TV

### Side Panel Jacks

You can use the Side panel jacks to connect an A/V component that is used only occasionally, such as a camcorder or video game. (For information on connecting equipment, see page 15.)

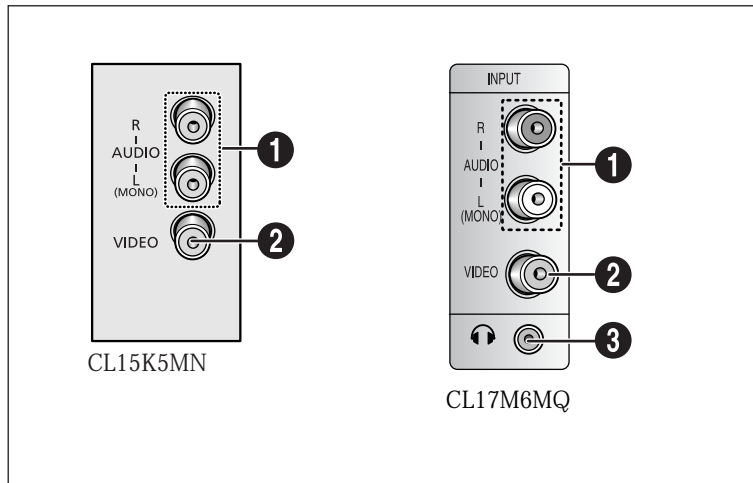

#### « AUDIO INPUTS

Audio signals from VCRs, DVD players and similar devices.

#### □ HEADPHONE

Connect a set of external headphones to this jack for private listening.

#### « VIDEO INPUT

Video signals from VCRs, DVD players and similar devices.

## YOUR NEW TV

### Rear Panel Jacks

Use the rear panel jacks to connect an A/V component that will be connected continuously, such as a VCR or a DVD player.

Because there are two sets of input jacks, you can connect two different A/V components (i.e., a VCR and a DVD, 2 VCRs, etc.)

For more information on connecting equipment, see pages 9-14.

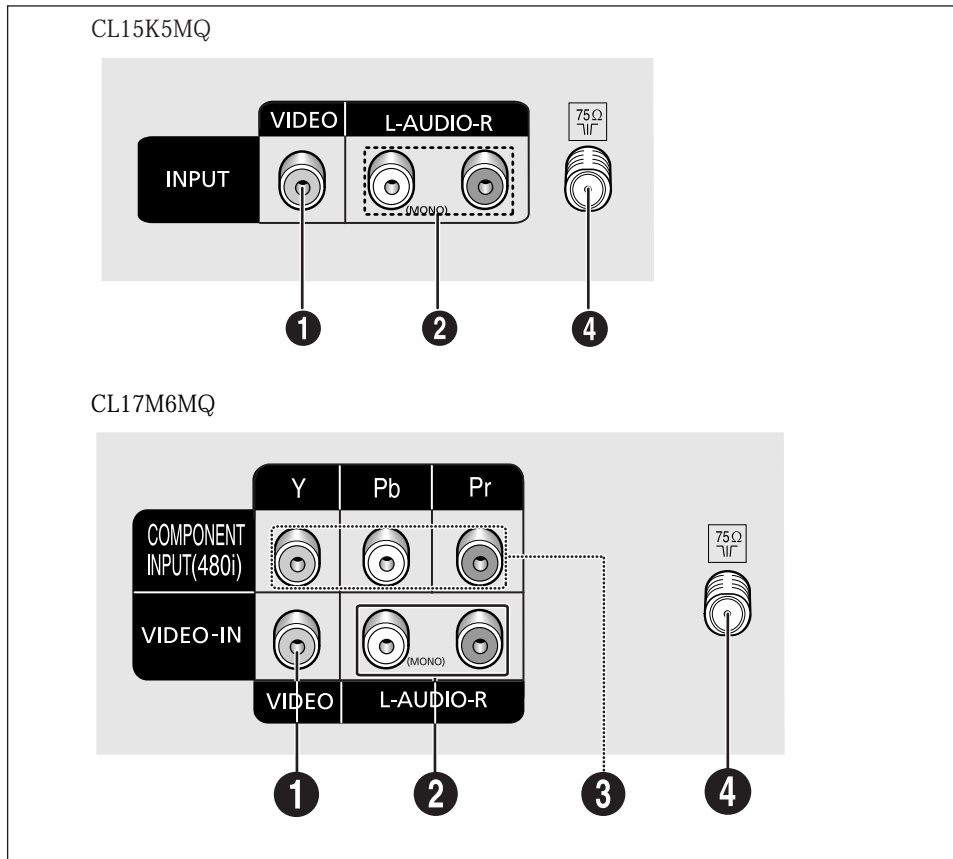

#### VIDEO INPUT

Video signals from VCRs, DVD players and similar devices.

#### AUDIO INPUTS

Audio signals from VCRs, DVD players and similar devices.

#### COMPONENT INPUTS

Connect video from a DVD player.

Note: Monitor Output doesn't operate in the DVD mode.

#### VHF/UHF

Connect to an antenna or to a cable TV system.

## YOUR NEW TV

### Remote Control

You can use the remote control up to about 23 feet from the TV. When using the remote, always point it directly at the TV.

- ⌂ **POWER**  
Turns the TV on and off.
- « **Number buttons**  
Press to select channels directly on the TV.
- **+100**  
Press to select channels over 100. For example, to select channel 121, press "+100," then press "2" and "1."
- ⌂ **MUTE**  
Press to temporarily cut off the sound.
- **VOL -, VOL +**  
Press to increase or decrease the volume.
- fi **SLEEP**  
Press to select a preset time interval for automatic shutoff.
- ⌂ **MENU**  
Displays the main on-screen menu.
- **MTS (Multichannel Television Stereo)**  
Press to choose stereo, mono or Separate Audio Program (SAP broadcast).
- **TURBO**  
Press to turn the TURBO sound On or Off.

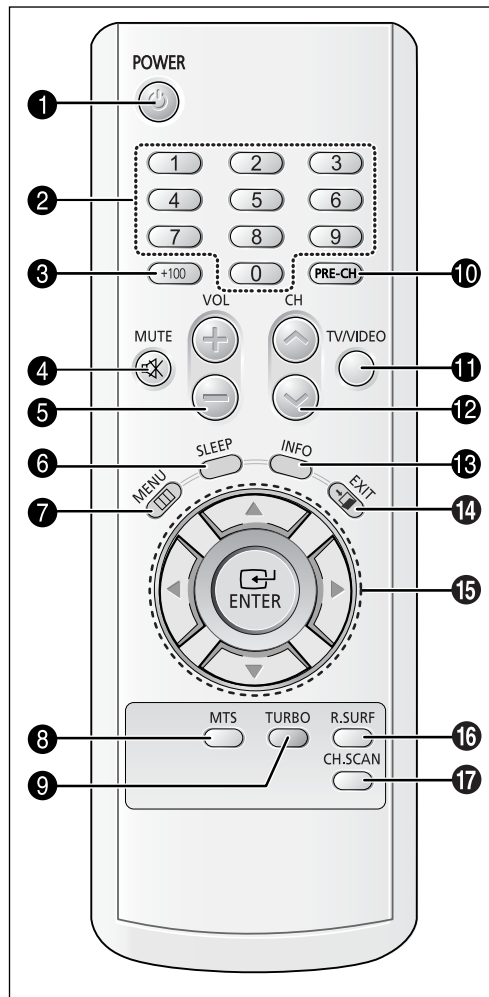

- **PRE-CH**  
Tunes to the previous channel.
- **TV/VIDEO**  
Press to display all of the available video sources (i.e., Antenna/Cable, VCR).
- **CH ^ and CH v (Channel Up/Down)**  
Press CH ^ or CH v to change channels.
- æ **INFO**  
Press to see the time, channel, etc., on-screen.
- **EXIT**  
Press to exit the menu.
- fi **Up, Down, Left, Right (▲, ▼, ◀, ▶) / ENTER**  
Press to select highlight up, down, left, or right. While using the on-screen menus, press the ENTER button to activate (or change) a particular item.
- 1 **R-SURF**  
Press the SURF button to automatically return to a preferred channel after a user-preset time delay.
- **CH.SCAN**  
Press to have the TV automatically scan all of the channels it has memorized.



# Chapter Two

## INSTALLATION

### Connecting VHF and UHF Antennas

If your antenna has a set of leads that look like this, see “Antennas with 300-ohm Flat Twin Leads” below.

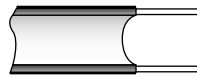

If your antenna has one lead that looks like this, see “Antennas with 75-ohm Round Leads” on next page.



If you have two antennas, see “Separate VHF and UHF Antennas” on next page.

#### Antennas with 300-ohm Flat Twin Leads

If you are using an off-air antenna (such as a roof antenna or “rabbit ears”) that has 300-ohm twin flat leads, follow the directions below.

**1**

Place the wires from the twin leads under the screws on the 300-75 ohm adaptor (not supplied). Use a screwdriver to tighten the screws.

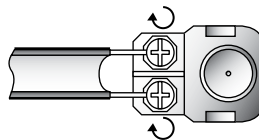

**2**

Plug the adaptor into the VHF/UHF terminal on the bottom of the back panel.

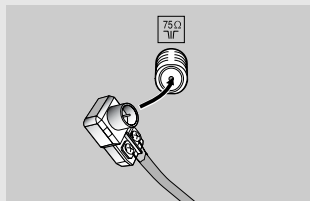

## INSTALLATION

### Antennas with 75-ohm Round Leads

- 1** Plug the antenna lead into the VHF/UHF terminal on the bottom of the back panel.

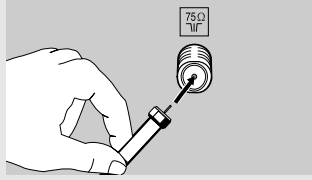

### Separate VHF and UHF Antennas

If you have two separate antennas for your TV (one VHF and one UHF), you must combine the two antenna signals before connecting the antennas to the TV. This procedure requires an optional combiner-adaptor (available at most electronics shops).

- 1** Connect both antenna leads to the combiner.

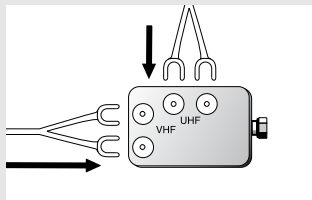

- 2** Plug the combiner into the VHF/UHF terminal on the bottom of the rear panel.

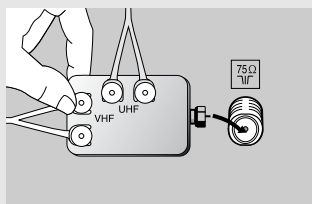

### Connecting Cable TV

To connect to a cable TV system, follow the instructions below.

#### Cable without a Cable Box

- 1** Plug the incoming cable into the VHF/UHF antenna terminal on back of the TV.

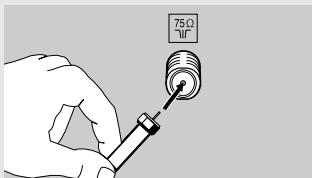

◀ Because this TV is cable-ready, you do not need a cable box to view unscrambled cable channels.

## INSTALLATION

### Connecting to a Cable Box that Descrambles All Channels

**1**

Find the cable that is connected to the ANTENNA OUT terminal on your cable box.

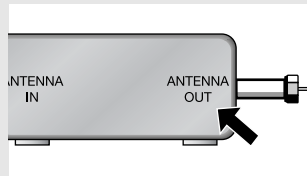

◀ This terminal might be labeled "ANT OUT", "VHF OUT" or simply "OUT".

**2**

Connect the other end of this cable to the VHF/UHF antenna terminal on the back of the TV.

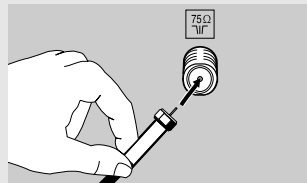

### Connecting to a Cable Box that Descrambles Some Channels

If your cable box descrambles only some channels (such as premium channels), follow the instructions below. You will need a two-way splitter, an RF (A/B) switch, and four lengths of coaxial cable. (These items are available at most electronics stores.)

**1**

Find and disconnect the cable that is connected to the ANTENNA IN terminal on your cable box.

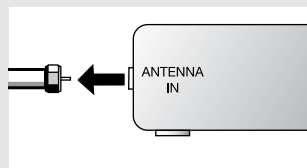

◀ This terminal might be labeled "ANT IN", "VHF IN" or simply "IN".

**2**

Connect this cable to a two-way splitter.

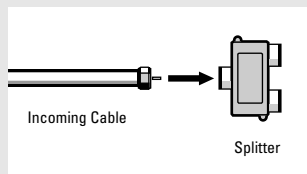

**3**

Connect a coaxial cable between an OUTPUT terminal on the splitter and the IN terminal on the cable box.

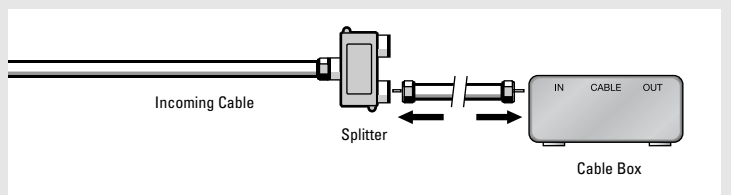

**4**

Connect a coaxial cable between the ANTENNA OUT terminal on the cable box and the B-IN terminal on the RF(A/B) switch.

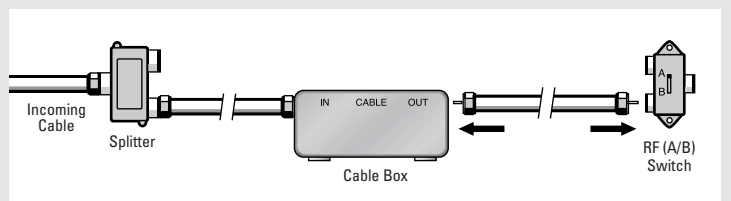

*Continued...*

## INSTALLATION

**5**

Connect another cable between the other OUT terminal on the splitter and the A-IN terminal on the RF (A/B) switch.

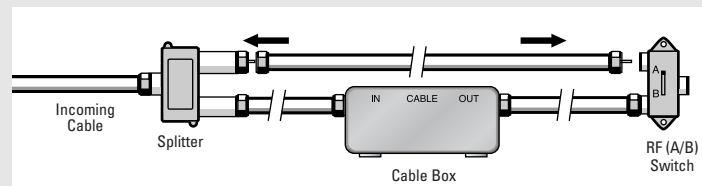

**6**

Connect the last coaxial cable between the OUT terminal on the RF (A/B) switch and the VHF/UHF terminal on the back of the TV.

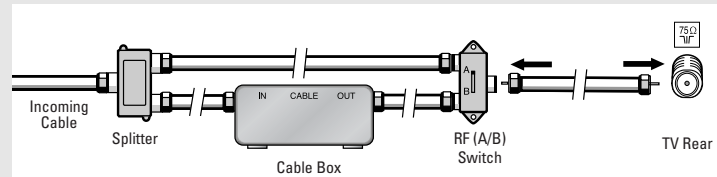

After you've made this connection, set the A/B switch to the "A" position for normal viewing. Set the A/B switch to the "B" position to view scrambled channels. (When you set the A/B switch to "B", you will need to tune your TV to the cable box's output channel, which is usually channel 3 or 4.)

## INSTALLATION

### Connecting a VCR

These instructions assume that you have already connected your TV to an antenna or a cable TV system (according to the instructions on pages 9-12). Skip step 1 if you have not yet connected to an antenna or a cable system.

- 1**  
Unplug the cable or antenna from the back of the TV.

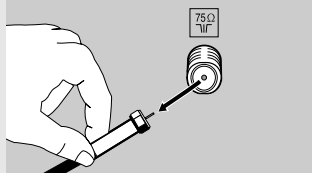

- 2**  
Connect the cable or antenna to the ANTENNA IN terminal on the back of the VCR.

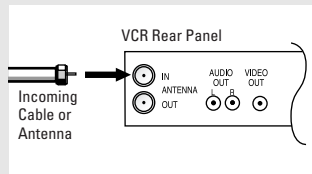

- 3**  
Connect a coaxial cable between the ANTENNA OUT terminal on the VCR and the antenna terminal on the TV.

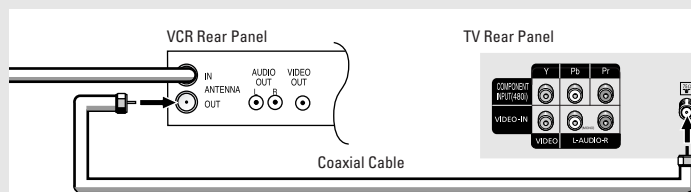

A coaxial cable is usually included with a VCR. (If not, check your local electronics store).

- 4**  
Connect a set of audio cables between the AUDIO OUT jacks on the VCR and the AUDIO jacks on the TV.

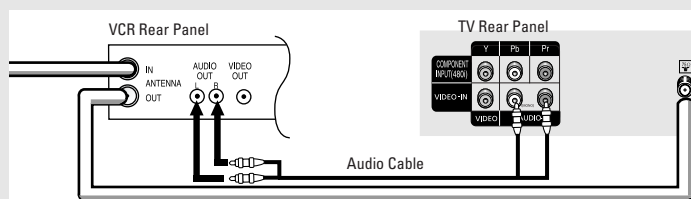

- 5**  
Connect a video cable between the VIDEO OUT jack on the VCR and the VIDEO jack on the TV.

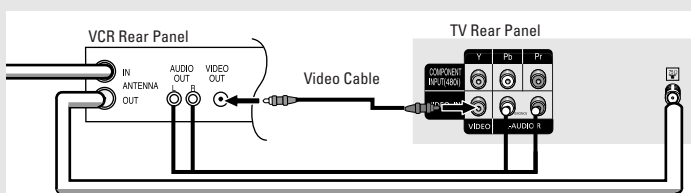

Follow the instructions in "Viewing a VCR or Camcorder Tape" to view your VCR tape.

*Note: This figure shows the Standard connector-jack panel. The actual configuration for your TV may be different.*

## INSTALLATION

### Connecting a DVD Player (480i) (Option)

The rear panel jacks on your TV make it easy to connect a DVD player to your TV.

**1**

Connect a set of audio cables between the AUDIO INPUT jacks on the TV and the AUDIO OUT jacks on the DVD player.

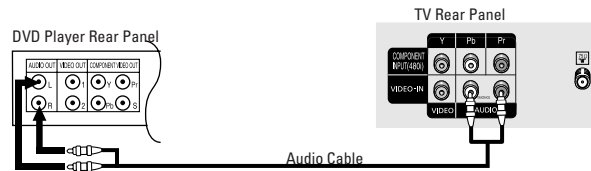

**2**

Connect a video cable between the COMPONENT INPUT (Y, Pb, Pr) jacks on the TV and the DVD-OUT (Y, Pb, Pr) jacks on the DVD player.

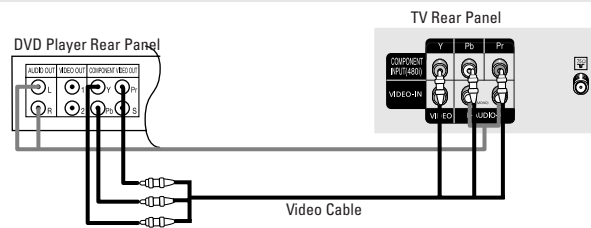

*Note: For an explanation of Component video, see your DVD player's owner's manual.*

## INSTALLATION

### Connecting a Camcorder

The side panel jacks on your TV make it easy to connect a camcorder to your TV. They allow you to view the camcorder tapes without using a VCR. (Also see "Viewing a VCR or Camcorder Tape" on page 28.)

**1**

Locate the A/V output jacks on the camcorder. They are usually found on the side or back of the camcorder.

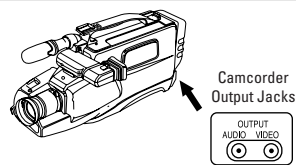

**2**

Connect an audio cable between the AUDIO OUTPUT jack on the camcorder and the AUDIO terminals on the side of the TV.

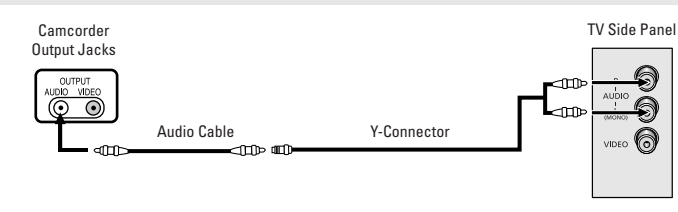

**3**

Connect a video cable between the VIDEO OUTPUT jack on the camcorder and the VIDEO terminal on the side of the TV.

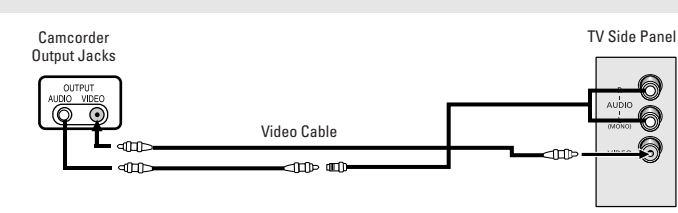

The audio-video cables shown here are usually included with a Camcorder. (If not, check your local electronics store.) If your camcorder is stereo, you need to connect a set of two cables.

*Note: This figure shows the Standard connector-jack panel. The actual configuration for your TV may be different.*

## INSTALLATION

### Installing Batteries in the Remote Control

**1**

Slide the cover out completely.

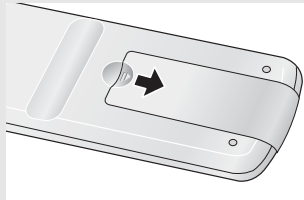

**2**

Install two AAA size batteries.

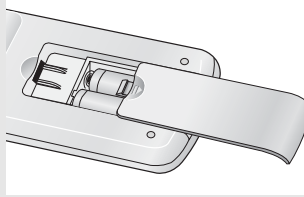

◀ Make sure to match the “+” and “-” ends of the batteries with the diagram inside the compartment.

**3**

Replace the cover.

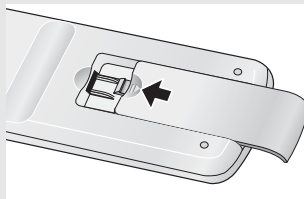

◀ Remove the batteries and store them in a cool, dry place if you won't be using the remote control for a long time.

The remote control can be used up to about 23 feet from the TV.

(Assuming typical TV usage, the batteries last for about one year.)



# Chapter Three

## OPERATION

### Turning the TV On and Off

Press the **POWER** button on the remote control.  
You can also use the **POWER** button on the front panel.

### Viewing the Menus and On-Screen Displays

#### Viewing the Menus

**1**

With the power on, press the **MENU** button.

The main menu appears on the screen. Its left side has four icons: Picture, Sound, Channel and Function.

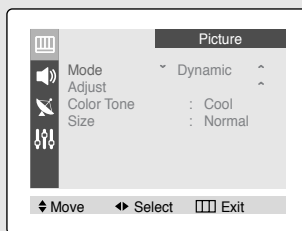

◀ The on-screen menu disappears from the screen after about two minutes.

**2**

Use the **▲** and **▼** buttons to highlight one of the 4 icons. Then press the **^** button to access the icon's sub-menu. Press the **EXIT** button to exit.

◀ You can also use the **MENU**, **CHANNEL** and **VOLUME** buttons on the control panel of the TV to make selections.

#### Viewing the Display

**1**

Press the **INFO** button on the remote control.

The on-screen display shows any or all of the following: Active channel, picture mode, audio mode, audio source and the time. ("\*" indicates a channel has been manually fine tuned.)

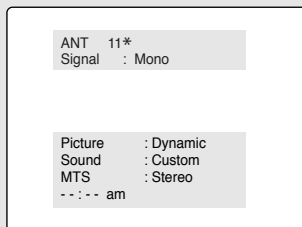

◀ The on-screen displays disappear after about ten seconds.

When Closed Caption has been set, the icon (CC) will appear by pressing the **INFO** button.

## OPERATION

### Selecting a Menu Language

**1**

Press the **MENU** button to display the menu.

Press the **▲** or **▼** button to select "Function", then press the **↵** or **^** button.

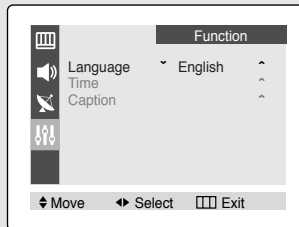

**2**

Press the **↵** or **^** button to select the appropriate language: English, Spanish or French.

Press the **EXIT** button to exit.

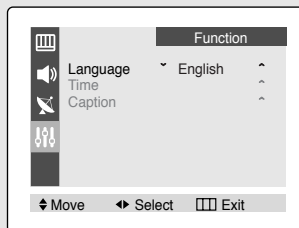

## Memorizing the Channels

Your TV can memorize and store all of the available channels for both “off-air” (antenna) and cable channels. After the available channels are memorized, use the CH  $\wedge$  and CH  $\vee$  buttons to scan through the channels. This eliminates the need to change channels by entering the channel digits. There are three steps for memorizing channels: selecting a broadcast source, memorizing the channels (automatic) and adding and deleting channels (manual).

### Selecting the Video Signal-source

Before your television can begin memorizing the available channels, you must specify the type of signal source that is connected to the TV (i.e., an antenna or a cable system).

#### 1

Press the **MENU** button to display the menu.

Press the  $\blacktriangle$  or  $\blacktriangledown$  button to select “Channel”, then press the  $\vee$  or  $\wedge$  button.

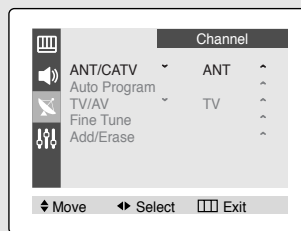

#### 2

Repeatedly press the  $\vee$  or  $\wedge$  button to cycle through these choices:

ANT (antenna), STD, HRC or IRC (all cable TV).

Press the **EXIT** button to exit.

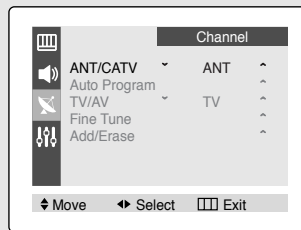

*Note: STD, HRC and IRC identify various types of cable TV systems. Contact your local cable company to identify the type of cable system that exists in your particular area.*

*At this point the signal source has been selected. Proceed to “Storing Channels in Memory” (next page).*

## OPERATION

### Storing Channels in Memory (Automatic Method)

**1**

First, select the correct signal source (ANT, STD, HRC, IRC). See steps 1~2 on previous page.

Press the **MENU** button, then press the **▲** or **▼** button to select "Channel" then press the **▼** or **▲** button.

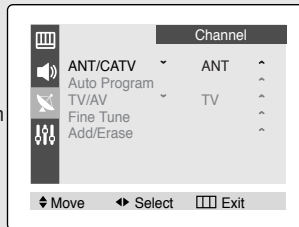

**2**

Press the **▲** or **▼** button to select "Auto Program".

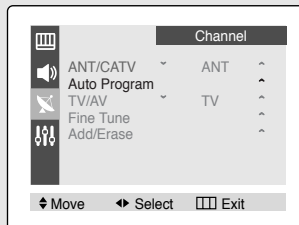

**3**

Press the **▼** or **▲** button. The TV will begin memorizing all of the available channels.

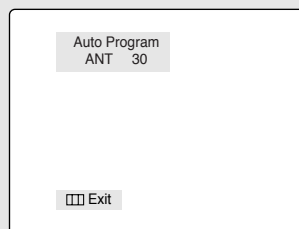

◀ The TV automatically cycles through all of the available channels and stores them in memory. This takes about one to two minutes.

Press the **MENU** button at any time to interrupt the memorization process and return to the Channel menu.

**4**

After all the available channels are stored, the Channel menu reappears. Press the **EXIT** button to exit.

## OPERATION

### Adding and Erasing Channels (Manual Method)

**1**

Press the **MENU** button to display the menu.

Press the **▲** or **▼** button to select "Channel", then press the **↵** or **^** button.

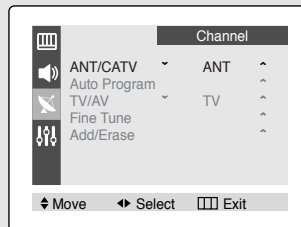

**2**

Press the **▲** or **▼** button to select "Add/Erase", then press the **↵** or **^** button.

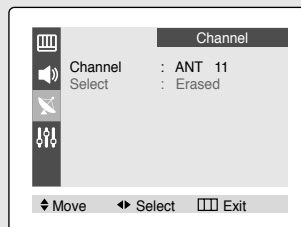

**3**

Press the **↵**, **^** or number buttons to select the channel you want added or erased.

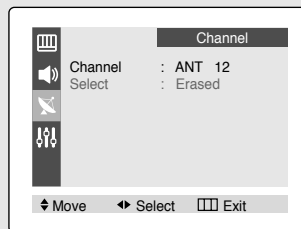

**4**

Press the **▲** or **▼** button to select "Select".

Press the **↵** or **^** button to select "Added" or "Erased".

Press the **EXIT** button to exit.

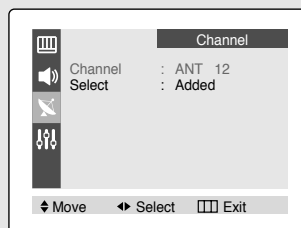

## Changing Channels

### Using the Channel Buttons

Press the **CH**  $\wedge$  or **CH**  $\vee$  button to change channels.

When you press **CH**  $\wedge$  or **CH**  $\vee$ , the TV changes channels in sequence. You will see all the channels that the TV has memorized. (The TV must have memorized at least three channels.) You will not see channels that were either erased or not memorized.

### Directly Accessing Channels

Use the number buttons to quickly tune to any channel.

Press the number buttons to go directly to a channel.  
For example, to select channel 27, press "2", then "7".  
The TV will change channels when you press the second number.

When you use the number buttons, you can directly select channels that were either erased or not memorized.

To select a channel over 100, press the **+100** button. (For channel 122, press "+100", then "2", then "2".)

To change to single-digit channels (0-9) faster, press "0" before the single digit. (For channel "4", press "0", then "4".)

### Using the PRE-CH Button to select the Previous Channel

Press the **PRE-CH** button.  
The TV will switch to the last channel viewed.

◀ To quickly switch between two channels that are far apart, tune to one channel, then use the number button to select the second channel. Then, use the **PRE-CH** button to quickly alternate between them.

### Channel Scan

Press the **CH.SCAN** button.  
The TV automatically scan all of the channels it has memorized.

## Customizing the Picture

You can use the on-screen menus to change the contrast, brightness, sharpness, color, and tint according to personal preference. (Alternatively, you can use one of the “automatic” settings. See next page.)

**1**

Press the **MENU** button to display menu.

Press the **▼** or **▲** button to select “Picture”.

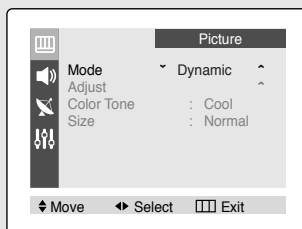

**2**

Press the **▲** or **▼** button to select “Adjust”, then press the **▼** or **▲** button. (The words Contrast, Brightness, Sharpness, Color and Tint will appear on the screen.)

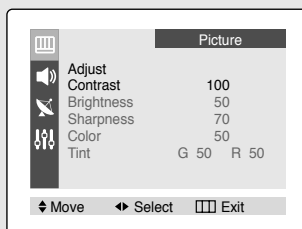

**3**

Press the **▲** or **▼** button to select a particular item, then press the **▼** or **▲** button to increase or decrease the value of a particular item.

Press the **EXIT** button to exit.

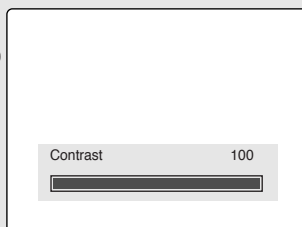

◀ After adjusting an item, the gauge will automatically disappear (after about 5 seconds).

## Using Automatic Picture Settings

Your TV has three automatic picture settings (“Dynamic”, “Standard” and “Movie”) that are preset at the factory. You can activate either Dynamic, Standard or Movie by making a selection from the menu. Or, you can select “Custom” which automatically recalls your personalized picture settings.

### 1

Press the **MENU** button to display menu.

Press the  $\downarrow$  or  $\uparrow$  button to select “Picture”.

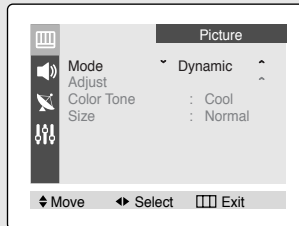

### 2

Press the  $\downarrow$  or  $\uparrow$  button to select the “Dynamic”, “Standard”, “Movie” or “Custom” picture setting.

Press the **EXIT** button to exit.

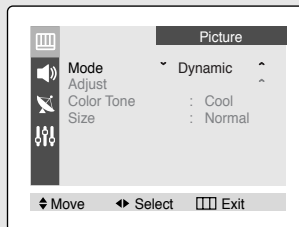

- Choose *Dynamic* for viewing the TV during the day or when there is brightlight in the room.
- Standard: Optimal indoor screen condition.
- Choose *Movie* when viewing the TV in low light, or when playing video games.
- Choose *Custom* if you want to adjust the settings according to personal preference (see “Customizing the Picture”, page 23).



## Adjusting the Volume

Press the **VOL +** or **VOL-** button to increase or decrease the volume.

### Using Mute

At any time, you can temporarily cut off the sound using the Mute button.

#### 1

Press the **MUTE** button and the sound cuts off.  
The word "Mute" will appear in the lower-left corner of the screen.

#### 2

To turn mute off, press the **MUTE** button again, or simply press either the **VOL -** or **VOL +** button.

## Customizing the Sound

You can use the on-screen menus to adjust the bass, treble, and balance according to individual preference. (Alternatively, you can use one of the "automatic" settings. See next page.)

#### 1

Press the **MENU** button to display the menu.

Press the **▲** or **▼** button to select "Sound" menu, then press the **◀** or **▶** button.

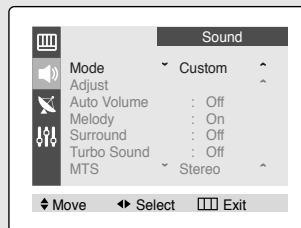

#### 2

Press the **◀** or **▶** button repeatedly, until the word "Custom" is selected. (When Custom is selected, the word "Adjust" will appear on the screen.)

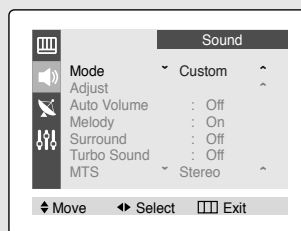

#### 3

Press the **▲** or **▼** button to select "Adjust", then press the **◀** or **▶** button. (The words Bass, Treble, and Balance will appear on the screen.)

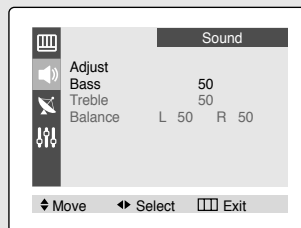

Continued...

## OPERATION

### 4

Press the ▲ or ▼ button to select a particular item to be changed.  
Press the ~ or ^ button to increase or decrease the value of a particular item.

Press the **EXIT** button to exit.

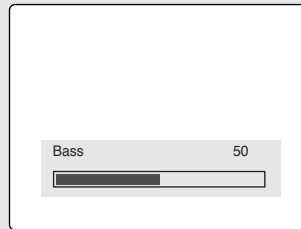

◀ After adjusting an item, the gauge will automatically disappear (after about 5 seconds).

## Using Automatic Sound Settings

Your TV has four automatic sound settings (“Standard”, “Music”, “Movie” and “Speech”) that are preset at the factory. You can activate any of them by making a selection from the on-screen menu. Or, you can select “Custom”, which automatically recalls your personalized sound settings.

### 1

Press the **MENU** button to display the menu.

Press the ▲ or ▼ button to select “Sound” menu, then press the ~ or ^ button.

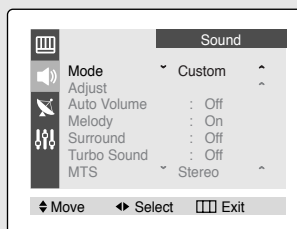

### 2

Press the ~ or ^ button repeatedly to select the “Standard”, “Music”, “Movie”, “Speech” or “Custom” sound settings.

Press the **EXIT** button to exit.

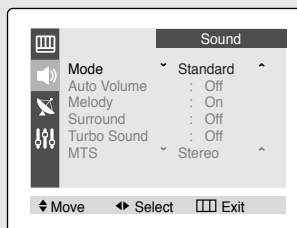

- Choose *Standard* for the standard factory settings.
- Choose *Music* when watching music videos or concerts.
- Choose *Movies* when watching movies.
- Choose *Speech* when watching a show that is mostly dialogue (i.e., news).
- Choose *Custom* to recall your personalized settings.

## OPERATION

### Setting the Clock

**1**

Press the **MENU** button to display the on-screen menu.

Press the **▲** or **▼** button to select "Function", then press the **∩** or **∪** button.

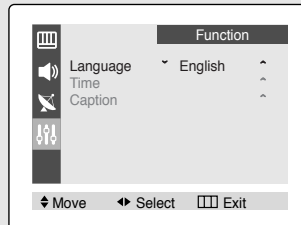

**2**

Press the **▲** or **▼** button to select "Time", then press the **∩** or **∪** button. The Time menu will appear on the screen, and "Clock" will be selected.

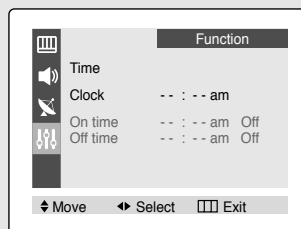

**3**

Press the **∩** or **∪** button again (the hours digits will be selected).

Press the **▲** or **▼** button repeatedly until the correct hour appears.

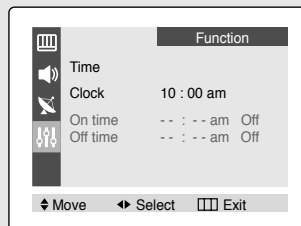

◀ When selecting the hours, be sure to select the proper time of day (AM or PM).

You can change the hours by pressing **▲** or **▼** repeatedly (or by holding down either of these buttons).

**4**

After the hour is entered, press the **∪** button. (at this point the minutes digits will be selected.)

Press the **▲** or **▼** button to select the correct minutes.

Press the **EXIT** button to exit.

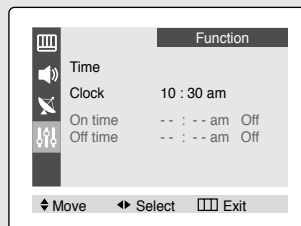

◀ The time will appear every time you press the INFO button.

## OPERATION

### Viewing a VCR or Camcorder Tape

You must select the appropriate mode in order to view the VCR or Camcorder signal on the TV.

**1**

Press the **MENU** button to display the menu.

Press the **▲** or **▼** button to select "Channel", then press the **▼** or **▲** button.

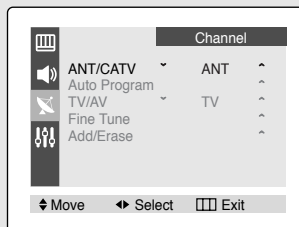

**2**

Press the **▲** or **▼** button to select the "TV/AV".

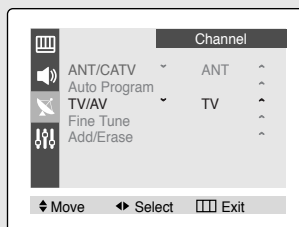

**3**

Press the **▼** or **▲** button. You will switch between viewing the signals coming from equipment connected to the TV's A/V jacks, and the TV signal.

Press the **EXIT** button to exit.

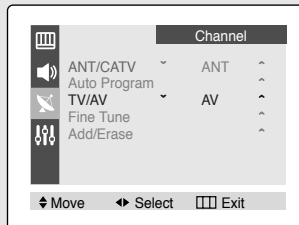

#### Alternate method:

Simply press the **TV/VIDEO** button on the remote control to select an External Signal Source.

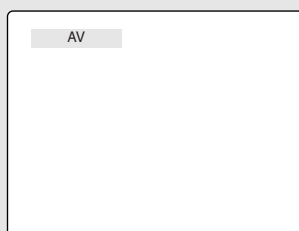

# Chapter Four

## SPECIAL FEATURES

### Fine Tuning Channels

Use fine tuning to manually adjust a particular channel for optimal reception.

**1**

Press the **MENU** button to display the menu.

Press the **▲** or **▼** button to select "Channel", then press the **↵** or **^** button.

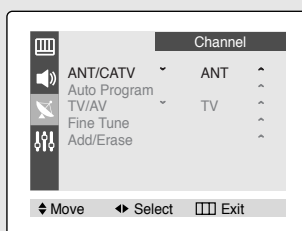

**2**

Press the **▲** or **▼** button to select "Fine tune", then press the **↵** or **^** button.

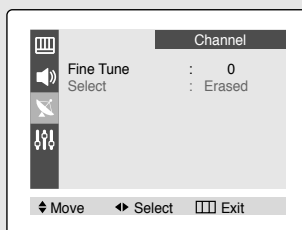

**3**

Press the **↵** and **^** buttons to adjust the fine tuning.

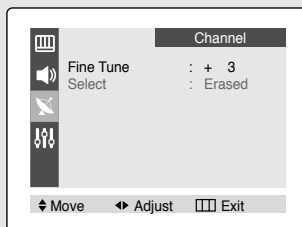

**4**

To store the fine tuning setting in the TV's memory, press the **▲** or **▼** button to select "Select". Press the **↵** or **^** button to select "Added".

To reset the fine tuning to "0", press the **↵** or **^** button to select "Erased".

Press the **EXIT** button to exit.



◀ After you adjust the fine tuning, "\*" will appear when you press the INFO button while watching this channel.

## SPECIAL FEATURES

### Selecting the Color Tone

**1**

Press the **MENU** button to display menu.

Press the  $\sim$  or  $\wedge$  button to select "Picture".

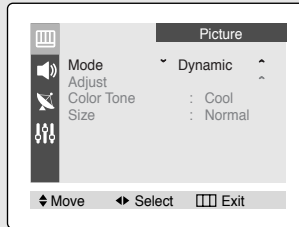

**2**

Press the  $\blacktriangle$  or  $\blacktriangledown$  button to select "Color Tone".

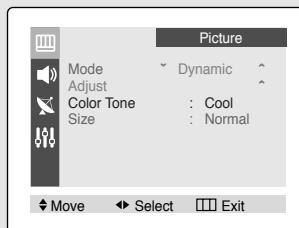

**3**

Press the  $\sim$  or  $\wedge$  button repeatedly to select "Cool", "Normal" or "Warm".

Press the **EXIT** button to exit.

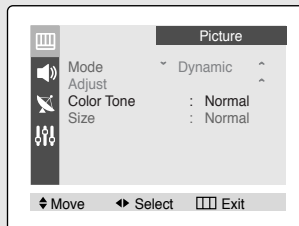

## Changing the Screen Size

**1**

Press the **MENU** button to display menu.

Press the  $\downarrow$  or  $\uparrow$  button to select "Picture".

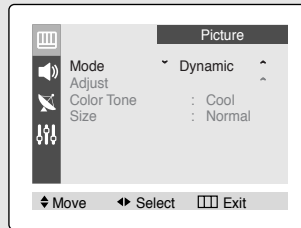

**2**

Press the  $\blacktriangle$  or  $\blacktriangledown$  button to select "Size".

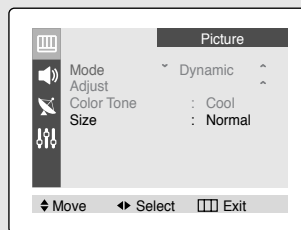

**3**

Press the  $\downarrow$  or  $\uparrow$  button repeatedly to select "Normal" or "Zoom".

Press the **EXIT** button to exit.

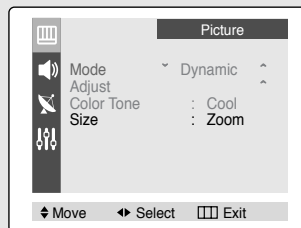

- Normal : Sets the picture to 4:3 normal mode. This is a standard TV screen size.
- Zoom : Magnifies the size of the picture on screen.

## Using the Surf Feature

This feature allows you to set the TV to return to a particular channel after a certain amount of time. For example, you may be watching a channel when commercials start. You can set the Surf to "5 minutes", then switch channels. After 5 minutes, the TV will return to the original channel. To use the Surf:

**1**

While you are watching the channel to which you want to return, press the **R.SURF** button. The on-screen display will read "Surf off".



Surf Off

**2**

Press the **R.SURF** button again to set the timer in thirty second intervals, up to five minutes.

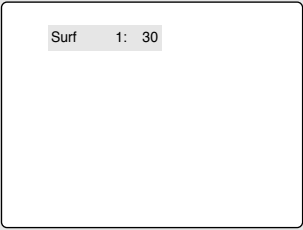

Surf 1: 30

◀ The time will be decreasing while you are setting up the timer. And you will reset it when you pass five minutes or turn it off.

**3**

The time you set will begin counting down on the screen. When the time runs out, the TV will return to the channel you were watching when you set the timer.



## Choosing a Multi-Channel Sound (MTS) Soundtrack

Depending on the particular program being broadcast, you can listen to stereo, mono or a Separate Audio Program. (SAP audio is usually a foreign-language translation. Sometimes SAP has unrelated information like news or weather.)

### 1

Press the **MENU** button to display the menu.

Press the **▲** or **▼** button to select "Sound" menu, then press the **▼** or **▲** button.

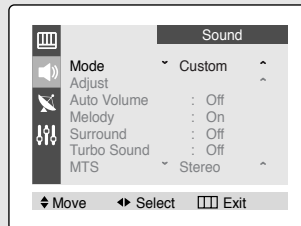

### 2

Press the **▲** or **▼** button to select "MTS".

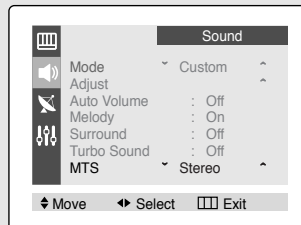

### 3

Press the **▼** or **▲** button to select "Mono", "SAP" or "Stereo".

Press the **EXIT** button to exit.

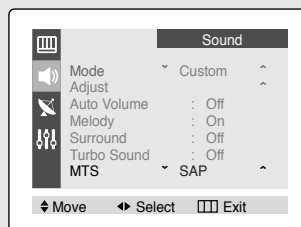

◀ The text at the bottom of the menu tells you if the incoming audio is stereo, SAP or mono.

#### Alternate method:

Simply press the **MTS** button on the remote control to change the MTS setting.

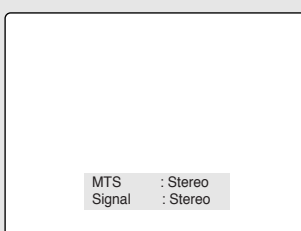

- Choose *Stereo* for channels that are broadcasting in stereo.
- Choose *Mono* for channels that are broadcasting in mono, or if you are having difficulty receiving a stereo signal.
- Choose *SAP* to listen to the Separate Audio Program, which is usually a foreign-language translation.

## Extra Sound Settings

- Auto Volume**  
 Each broadcasting station has its own signal conditions, and so it is not easy for you to adjust the volume every time the channel is changed. "Auto Volume" lets you automatically adjust the volume of the desired channel by lowering the sound output when the modulation signal is high or by raising the sound output when the modulation signal is low.
- Melody**  
 You can set a melody to sound when the TV is powered On or Off.
- Surround**  
 "Surround" converts a mono or stereo signal into simulated surround sound. Once the "Surround" is set to "On", the setting applies to sound effects such as Standard, Music, Movie and Speech.
- Turbo Sound**  
 Turbo Sound suitably emphasizes both higher and lower bands of sound (and includes other effects).

- 1**  
 Press the **MENU** button to display the menu.
- Press the **▲** or **▼** button to select "Sound" menu, then press the **▽** or **△** button.

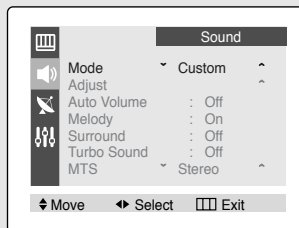

- 2**  
 Press the **▲** or **▼** button to select required item you want.

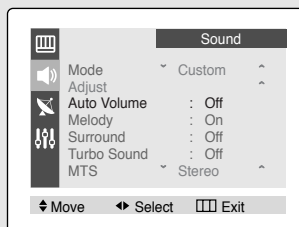

- 3**  
 Press the **▽** or **△** button to select "On" or "Off".
- Press the **EXIT** button to exit.

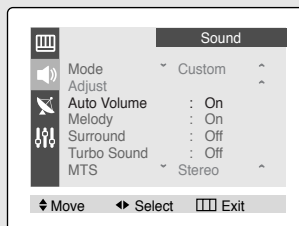

- Alternate method (Turbo Sound):**  
 Simply press the **TURBO** button on the remote control to change the turbo sound setting.

Turbo Sound : On

## Setting the On/Off Timer

**1**

Press the **MENU** button to display the on-screen menu.

Press the **▲** or **▼** button to select "Function", then press the **◀** or **▶** button.

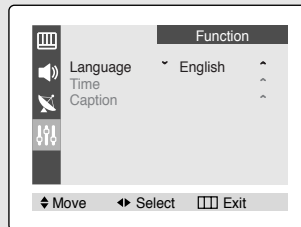

◀ Before using the timer, you must set the TV's clock. (See "Setting the Clock" on page 27).

**2**

Press the **▲** or **▼** button to select "Time" then press the **◀** or **▶** button. The Time menu will appear on the screen.

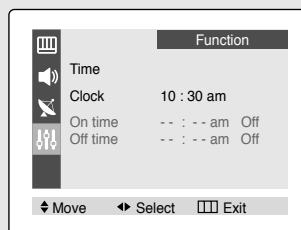

**3**

Press the **▲** or **▼** button to select "On time".

Press the **◀** or **▶** button to select the "On time" hours. (The hours digits will be highlighted.)

Press the **▲** or **▼** button repeatedly to select the appropriate hours (i.e., the hour when the TV will turn on.)

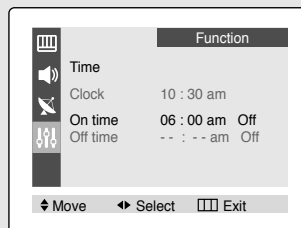

◀ When you set the hours, make sure the correct time of day (AM or PM) appears to the right of the hour.

**4**

Press the **▶** button to select the "On time" minutes. (The minutes digits will be highlighted.)

Press the **▲** or **▼** button to select the appropriate minutes.

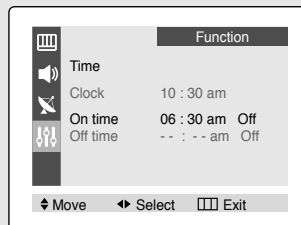

*Continued...*

## SPECIAL FEATURES

**5**

Press the **^** button to select "On/Off".

Press the **▲** or **▼** button to turn the on-timer "On". (Repeatedly pressing the **▲** or **▼** button will alternate between on and off.)

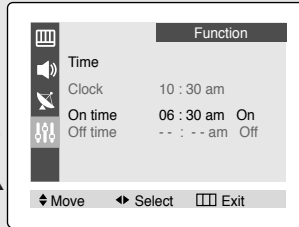

◀ To deactivate the "On time", select "Off" during this step.

**6**

When finished, press the **^** button .

**7**

To set the Off time, press the **▲** or **▼** button to select "Off time".

Press the **^** button and set the hours and minutes. (Follow the same procedure as in steps 3-6 above.)

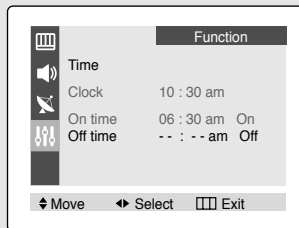

Press the **EXIT** button to exit.

## Setting the Sleep Timer

The sleep timer automatically shuts off the TV after a preset time (from 10 to 180 minutes).

Press the **SLEEP** button repeatedly until the appropriate time interval appears (any of the preset values from "Off" to "180").

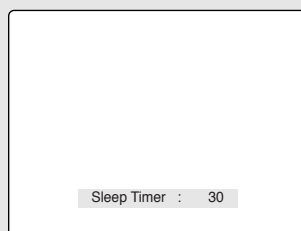

◀ After about 5 seconds, the sleep display will disappear from the screen, and the time interval will be set.

## Viewing Closed Captions

Your TV decodes and displays the closed captions that are broadcast with certain TV shows. These captions are usually subtitles for the hearing impaired or foreign-language translations. All VCRs record the closed caption signal from television programs, so home-recorded video tapes also provide closed captions. Most pre-recorded commercial video tapes provide closed captions as well. Check for the closed caption symbol in your television schedule and on the tape's packaging: .

**1**

Press the **MENU** button to display the on-screen menu.

Press the **▲** or **▼** button to select "Function", then press the **▽** or **△** button.

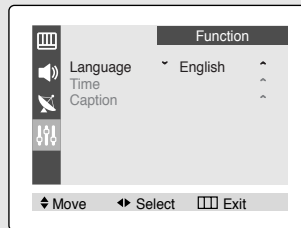

**2**

Press the **▲** or **▼** button to select the "Caption", then press the **▽** or **△** button.

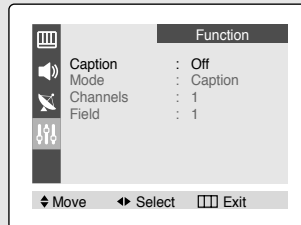

**3**

Press the **▽** or **△** button to turn closed captioning on/off.

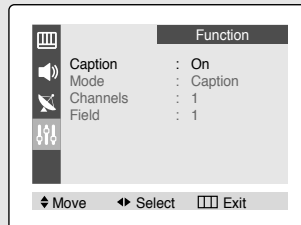

**4**

Press the **▲** or **▼** button to select "Mode".

Press the **▽** or **△** button to select "Caption" or "Text".

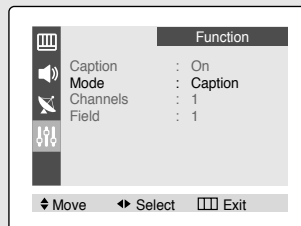

**5**

Depending on the particular broadcast, it might be necessary to make changes to "Channels" and "Field": Use the **▲**, **▼**, **▽** and **△** buttons to make the changes. (Follow the same procedure as in steps 3-4 above.)

Press the **EXIT** button to exit.

◀ Misspellings and unusual characters sometimes occur during closed caption transmissions, especially those of live events. There may be a small delay before captions appear when you change channels. These are not malfunctions of the TV.

◀ In **caption mode**, captions appear at the bottom of the screen, and they usually cover only a small portion of the picture.

In **text mode**, information unrelated to the program, such as news or weather, is displayed. Text often covers a large portion of the screen.

◀ Different channels and fields display different information: Field 2 carries additional information that supplements the information in Field 1. (For example, Channel 1 may have subtitles in English, while Channel 2 has subtitles in Spanish.)

# Chapter Five

## TROUBLESHOOTING

If the TV seems to have a problem, first try this list of possible problems and solutions. If none of these troubleshooting tips apply, then call your nearest service center.

### Identifying Problems

<b>Problem</b>	<b>Possible Solution</b>
Poor picture	Try another channel. Adjust the antenna. Check all wire connections.
Poor sound quality.	Try another channel. Adjust the antenna.
No picture or sound.	Try another channel. Press the TV/VIDEO button. Make sure the TV is plugged in. Check the antenna connections.
No color, wrong colors or tints.	Make sure the program is broadcast in color. Adjust the picture settings. If the set is moved or turned in a different direction, the power should be OFF for at least 30 minutes.
Picture rolls vertically.	Adjust the antenna. Check all wire connections.
The TV operates erratically	Unplug the TV for 30 seconds, then try operating it again.
The TV won't turn on.	Make sure the wall outlet is working.

## Cleaning and Maintaining Your TV

With proper care, your TV unit will give you many years of service. Please follow these guidelines to get the maximum performance from your TV.

### Placement

- Do not place the TV near extremely hot, cold, humid or dusty places.
- Do not place the TV near appliances with electric motors that create magnetic fields, such as vacuum cleaners.
- Keep the ventilation openings clear; do not place the TV on a soft surface, such as cloth or paper.
- Place the TV in a vertical position only.

### Liquids

- Do not handle liquids near or on the TV. Liquids that spill into it can cause serious damage.

### Cabinet

- Never open the cabinet or touch the parts inside.
- Wipe your TV with a clean, dry cloth. Never use water, cleaning fluids, wax, or chemicals.
- Do not put heavy objects on top of the cabinet.

### Temperature

- If your TV is suddenly moved from a cold to a warm place, unplug the power cord, and allow at least two hours for moisture that may have formed inside the unit to dry completely.

## Using Your TV in Another Country

If you plan to take your TV with you to a foreign country, please be aware of the different television systems that are in use around the world. A TV designed for one system may not work properly with another system due to differences in the TV channel frequencies.

## Specifications

Model	CL15K5MN / CL17M6MQ
Voltage	AC 100-240V
Frequency of Operation	50/60Hz



Printed in Mexico  
AA68-03590A (ENG)



## Free Manuals Download Website

<http://myh66.com>

<http://usermanuals.us>

<http://www.somanuals.com>

<http://www.4manuals.cc>

<http://www.manual-lib.com>

<http://www.404manual.com>

<http://www.luxmanual.com>

<http://aubethermostatmanual.com>

Golf course search by state

<http://golfingnear.com>

Email search by domain

<http://emailbydomain.com>

Auto manuals search

<http://auto.somanuals.com>

TV manuals search

<http://tv.somanuals.com>