



Specifications

Model Name		TX-T2082	TX-T2085	TX-T2782
Screen Size (Diagonal)		20 inches		27 inches
Sound Output		5W X 2		
Dimensions (WxHxD) Body		23.8 x 18.6 x 14.2 inches / 604 x 472 x 360.5 mm	23.8 x 18.6 x 13.4 inches / 604 x 473 x 340 mm	31.3 x 23.3 x 16.6 inches / 796 x 593 x 421 mm
Weight		44.1 lbs / 20 Kg	45.2 lbs / 20.5 Kg	94.79 lbs / 43 Kg
Environmental Considerations	Operating Temperature Operating Humidity Storage Temperature Storage Humidity	50 °F to 104 °F (10 °C to 40 °C) 10% to 80%, non-condensing -4 °F to 113 °F (-20 °C to 45 °C) 5% to 95%, non-condensing		

- ◆ Design and specifications are subject to change without prior notice.
- ◆ For the power supply and Power Consumption, refer to the label attached to the product.

Contact SAMSUNG WORLD-WIDE

If you have any questions or comments relating to Samsung products, please contact the SAMSUNG customer care center.

Country	Customer Care Center ☎	Web Site	Address
CANADA	1-800-SAMSUNG (7267864)	www.samsung.com/ca	Samsung Electronics Canada Inc., Customer Service 55 Standish Court Mississauga, Ontario L5R 4B2 Canada
			Samsung Electronique Canada Inc., Service à la Clientèle 55 Standish Court Mississauga, Ontario L5R 4B2 Canada
U.S.A	1-800-SAMSUNG (7267864)	www.samsung.com	Samsung Electronics America, Inc. 105 Challenger Road Ridgefield Park, NJ 07660-0511

SAMSUNG

**TX-T2082
TX-T2085
TX-T2782**

COLOR TELEVISION

→ **Owner's
Instructions**

Register your product at www.samsung.com/global/register
Record your Model and Serial number here for future reference.

▪ Model _____ ▪ Serial No. _____

Contents

General Information

- ◆ Accessories 3
- ◆ Viewing the Control Panel 3
- ◆ Viewing the Connection Panel 4
- ◆ Remote Control 5

Connection

- ◆ Connecting VHF and UHF Antennas 6
- ◆ Connecting Cable TV 6
- ◆ Connecting a VCR 7
- ◆ Connecting a Camcorder 7
- ◆ Connecting a DVD Player/Set-Top Box 8
- ◆ Connecting an Amplifier/DVD Home Theater - Analog 8

Operation

- ◆ Plug & Play Feature 9
- ◆ Memorizing the Channels 10
- ◆ To Select the Source 11
- ◆ To Edit the Input Source Name 11

Picture Control

- ◆ Using Automatic Picture Settings 11
- ◆ Changing the Screen Size 12
- ◆ Digital Noise Reduction 13
- ◆ Tilt (depending on the model) 13

Sound Control

- ◆ Using Automatic Sound Settings 13
- ◆ Customizing the Sound 14
- ◆ Choosing a Multi-Channel Sound (MTS) Track - Digital 14
- ◆ Choosing a Multi-Channel Sound (MTS) Track - Analog 14
- ◆ Automatic Volume Control 15
- ◆ Using Pseudo Stereo 15
- ◆ Using Turbo Plus 15

Channel Control

- ◆ Clearing Scrambled Channels - Digital 15
- ◆ Adding and Erasing Channels - Analog 16
- ◆ Adding and Erasing Channels - Digital 16
- ◆ Labeling Channels - Analog 16
- ◆ Checking the Digital-Signal Strength - Digital 17
- ◆ Using the R.Surf Feature 17

Function Description

- ◆ Selecting a Menu Language 17
- ◆ Setting the Time 18
- ◆ Viewing Closed Captions (On-Screen Text Messages) - Digital 19
- ◆ Viewing Closed Captions (On-Screen Text Messages) - Analog 19
- ◆ Setting the Blue Screen Mode 20
- ◆ Setting the On/Off Melody 20
- ◆ Using the V-Chip 20
- ◆ Upgrading the Software 23

Appendix

- ◆ Identifying Problems 23
- ◆ Specifications

Symbols



Press



Important



Note



One-Touch Button

Important Warranty Information Regarding Television Format Viewing

Standard screen format televisions(4:3, the aspect ratio of the screen width to height) are primarily designed to view standard format full-motion video. The images displayed on them should primarily be in the standard 4:3 ratio format and constantly moving. Displaying stationary graphics and images on screen, such as the dark top and bottom letterbox bars(wide screen pictures), should be limited to no more than 15% of the total television viewing per week.

Wide screen format televisions(16:9, the aspect ratio of the screen width to height) are primarily designed to view wide screen format full-motion video. The images displayed on them should primarily be in the wide screen 16:9 ratio format, or expanded to fill the screen if your model offers this feature, and constantly moving. Displaying stationary graphics and images on screen, such as the dark side-bars on non-expanded standard format television video and programming, should be limited to no more than 15% of the total television viewing per week.

Additionally, viewing other stationary images and text such as stock market reports, video game displays, station logos, web sites or computer graphics and patterns, should be limited as described above for all televisions. **Displaying any stationary images that exceed the above guidelines can cause uneven aging of picture tubes(CRTs) that leave subtle, but permanent burned-in ghost images in the television picture. To avoid this, vary the programming and images, and primarily display full screen moving images, not stationary patterns or dark bars.** On television models that offer picture sizing features, use these controls to view the different formats as a full screen picture.

Be careful in the selection and duration of television formats used for viewing. Uneven CRT aging as a result of format selection and use, as well as other burned-in images, is not covered by your Samsung limited warranty.

General Information

Accessories

Please make sure the following items are included with your TV.
If any items are missing, contact your dealer.



Remote Control (AA59-00405B)/
AAA Batteries



Owner's Instructions/
Safety Guide Manual



Warranty Cards/
Registration Card

Viewing the Control Panel

You can control your TV's basic features, including the on-screen menu.
To use the more advanced features, you must use the remote control.

TX-T2782

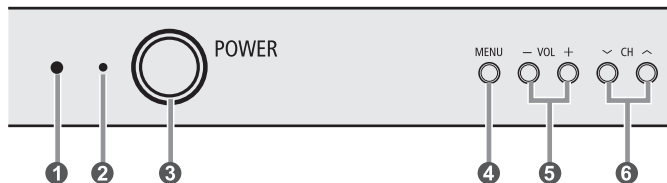

TX-T2082/TX-T2085

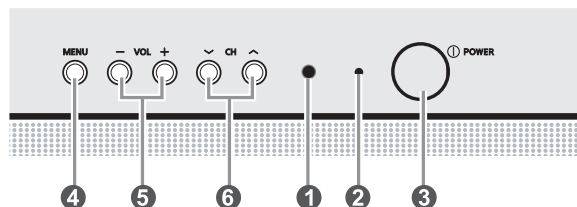

➤ The product color and shape may vary depending on the model.

1 Remote Control Sensor

Aim the remote control towards this spot on the TV.

2 Power Indicator

Lights up when you turn the power off.

- Power Off: Red
- Power On: Off

3 POWER

Press to turn the TV on and off.

4 MENU

Press to see an on-screen menu of your TV's features.

5 + VOL -

Press to increase or decrease the volume.

In the on-screen menu, use the **+ VOL -** buttons as you would use the ◀ and ▶ buttons on the remote control.

6 ^ CH v

Press to change channels.

In the on-screen menu, use the **^ CH v** buttons as you would use the ▲ and ▼ buttons on the remote control.

Viewing the Connection Panel

Use the rear panel jacks to connect A/V components that will be connected continuously, such as VCR or DVD players.

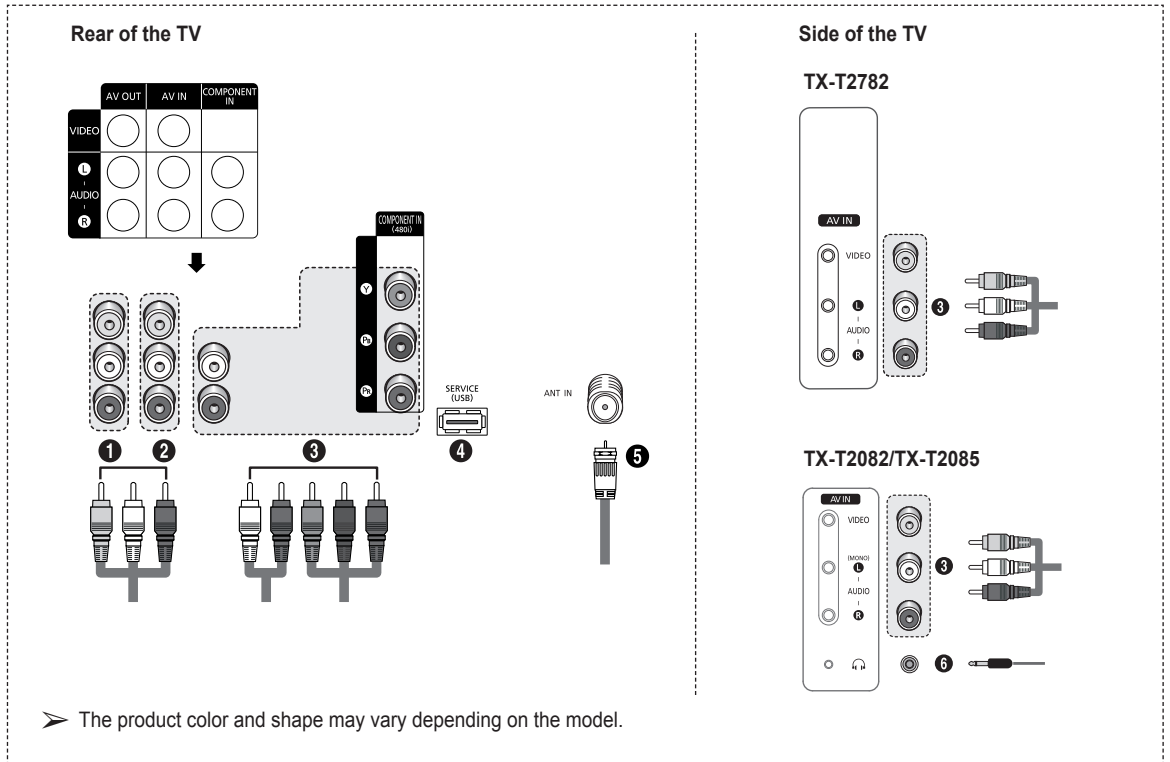

- 1 AV OUT**
Connect to the audio/video input jacks of a recording VCR.
- 2 AV IN**
Video and audio inputs for external devices, such as a camcorder or VCR.
➤ When both the side and rear jacks (AV IN) are connected to external equipment, the side receives priority.
- 3 COMPONENT IN**
Connect Component video/audio.
- 4 SERVICE (USB)**
Connect for service and software upgrade.
- 5 ANT IN**
Connect to an antenna(air) or cable TV system.
- 6 Headphone**
Connect a set of external headphones to this jack for private listening.

Remote Control

You can use the remote control up to a distance of about 23 feet from the TV. When using the remote control, always point it directly at the TV.

- ◆ This is a special remote control for the visually impaired, and has Braille points on the POWER, Channel, and Volume buttons.
 - ◆ The performance of the remote control may be affected by bright light.

- | | |
|--|---|
| <p>1 POWER
Turns the TV on and off.</p> <p>2 NUMERIC BUTTONS
Press to directly select a channel.</p> <p>3 -
Press to select additional channels being broadcast by the same station. For example, to select channel "54-3", press "54", then press "-" and "3".</p> <p>4 VOL +, VOL -
Press to increase or decrease the volume.</p> <p>5 MENU
Displays the main on-screen menu.</p> <p>6 UP ▲/DOWN ▼/LEFT ◀/RIGHT ▶/ENTER
Use to select on-screen menu items and change menu values.</p> <p>7 S.MODE
Press to select the sound mode.</p> <p>8 P.MODE
Press to select the picture mode.</p> <p>9 AUTO PROG.
Press to automatically store selected Air/Cable channels.</p> <p>10 ADD/DEL
Use to store and delete channels to/from memory.</p> <p>11 PRE-CH
Tunes to the previous channel.</p> | <p>12 SOURCE
Press to display all of the available video sources.</p> <p>13 INFO
Press to display information on the TV screen.</p> <p>14 TV/DTV
Press to switch between TV (Analog) and DTV (Digital) mode.</p> <p>15 CH ▲, CH ▼
Press to change channels.</p> <p>16 EXIT
Press to exit from the menu.</p> <p>17 MUTE
Press to temporarily cut off the sound.</p> <p>18 P.SIZE
Press to change the screen size.</p> <p>19 SLEEP
Press to select a preset time interval for automatic shut off.</p> <p>20 MTS
Press to choose stereo, mono or Separate Audio Program(SAP broadcast).</p> <p>21 CAPTION
Controls the caption decoder.</p> <p>22 R.SURF
Press to automatically return to a preferred channel after a user-preset time delay.</p> <p>23 TURBO
Press to select Turbo sound.</p> |
|--|---|

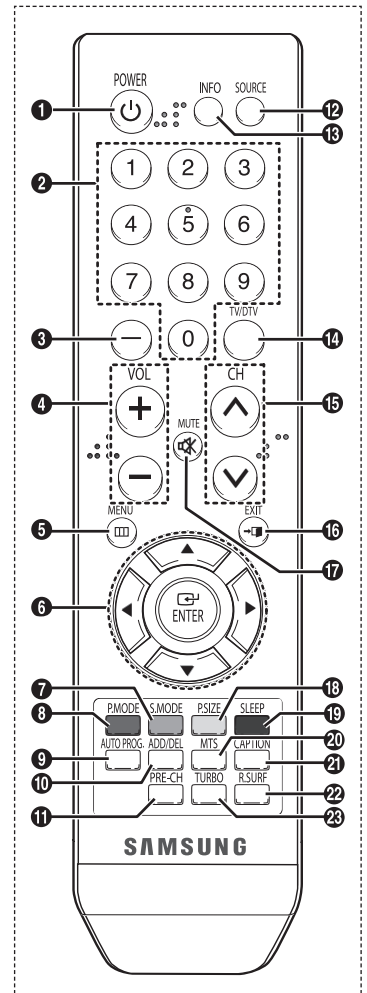

Installing Batteries in the Remote Control

- 1 Lift the cover at the back of the remote control upward as shown in the figure.
- 2 Install two AAA size batteries.
 - ◆ Make sure to match the + and - ends of the batteries with the diagram inside the compartment.
 - ◆ Do not mix battery types, i.e. alkaline and manganese.
- 3 Replace the cover.
 - Remove the batteries and store them in a cool and dry place if you won't be using the remote control for a long time. The remote control can be used up to about 23 feet from the TV. (Assuming typical TV usage, the batteries last for about one year.)

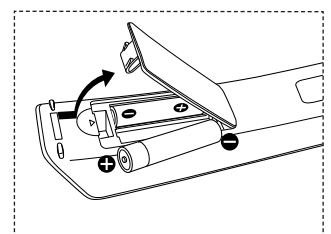

Connection

Connecting VHF and UHF Antennas

Antennas with 300 Ω Flat Twin Leads

If you are using an off-air antenna (such as a roof antenna or "rabbit ears") that has 300 Ω twin flat leads, follow the directions below.

- 1 Place the wires from the twin leads under the screws on a 300-75 Ω adaptor (not supplied). Use a screwdriver to tighten the screws.
- 2 Plug the adaptor into the ANT IN terminal on the back of the TV.

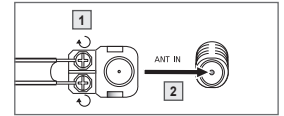

Antennas with 75 Ω Round Leads

- 1 Plug the antenna lead into the ANT IN terminal on the back of the TV.

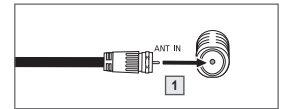

Separate VHF and UHF Antennas

If you have two separate antennas for your TV (one VHF and one UHF), you must combine the two antenna signals before connecting the antennas to the TV. This procedure requires an optional combiner-adaptor (available at most electronics shops).

- 1 Connect both antenna leads to the combiner.
- 2 Plug the combiner into the ANT IN terminal on the back of the TV.

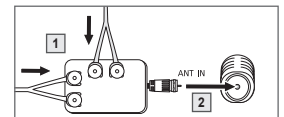

Connecting Cable TV

Cable without a Cable Box

- 1 Plug the incoming cable into the ANT IN terminal on the back of the TV.
 - Because this TV is cable-ready, you do not need a cable box to view unscrambled cable channels.

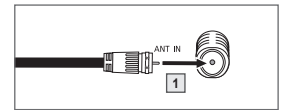

Connecting to a Cable Box that Descrambles All Channels

- 1 Find the cable that is connected to the ANT OUT terminal on your cable box.
 - This terminal might be labeled "ANT OUT", "VHF OUT" or simply, "OUT".
- 2 Connect the other end of this cable to the ANT IN terminal on the back of the TV.

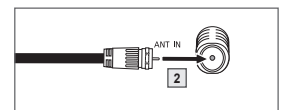
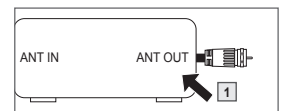

Connecting to a Cable Box that Descrambles Some Channels

If your cable box descrambles only some channels (such as premium channels), follow the instructions below. You will need a two-way splitter, an RF (A/B) switch, and four lengths of Antenna cable. (These items are available at most electronics stores.)

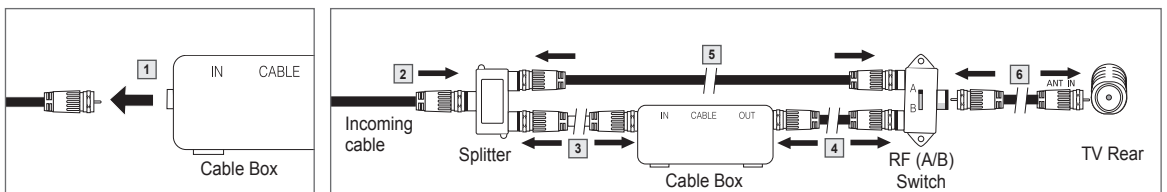

- 1 Find and disconnect the cable that is connected to the ANT IN terminal on your cable box.
 - This terminal might be labeled "ANT IN", "VHF IN" or simply, "IN".
- 2 Connect this cable to a two-way splitter.
- 3 Connect an Antenna cable between an OUT terminal on the splitter and the IN terminal on the cable box.
- 4 Connect an Antenna cable between the ANT OUT terminal on the cable box and the B-IN terminal on the RF (A/B) switch.
- 5 Connect another cable between the other OUT terminal on the splitter and the A-IN terminal on the RF (A/B) switch.
- 6 Connect the last Antenna cable between the OUT terminal on the RF (A/B) switch and the ANT IN terminal on the back of the TV.

After you have made this connection, set the A/B switch to the "A" position for normal viewing. Set the A/B switch to the "B" position to view scrambled channels. (When you set the A/B switch to "B", you will need to tune your TV to the cable box's output channel, which is usually channel 3 or 4.)

Connecting a VCR

Video Connection

These instructions assume that you have already connected your TV to an antenna or a cable TV system (according to the instructions on page 6). Skip step 1 if you have not yet connected to an antenna or a cable system.

- ◆ Each VCR has a different back panel configuration.
- ◆ When connecting a VCR, match the color of the connection terminal to the cable.

- 1 Unplug the cable or antenna from the back of the TV.
- 2 Connect the cable or antenna to the ANT IN terminal on the back of the VCR.
- 3 Connect an Antenna cable between the ANT OUT terminal on the VCR and the ANT IN terminal on the TV.
- 4 Connect a Video Cable between the VIDEO OUT jack on the VCR and the AV IN [VIDEO] jack on the TV.
- 5 Connect Audio Cables between the AUDIO OUT jacks on the VCR and the AV IN [L-AUDIO-R] jacks on the TV.
 - If you have a "mono" (non-stereo) VCR, use a Y-connector (not supplied) to hook up to the right and left audio input jacks of the TV. If your VCR is stereo, you must connect two cables.

- Also, you can connect to AV IN on the side panel of TV.
- When both the side and rear jacks (AV IN) are connected to external equipment, the side receives priority.

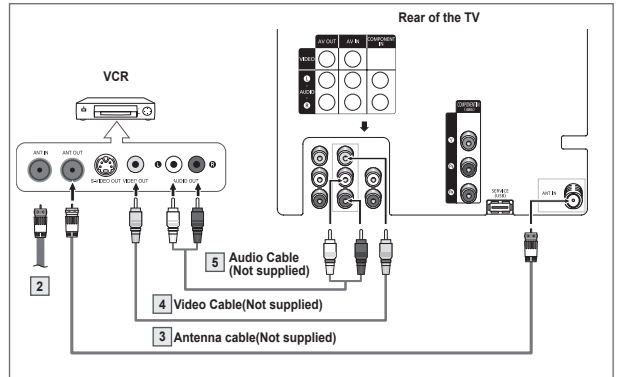

Connecting a Camcorder

The side panel jacks on your TV make it easy to connect a camcorder to your TV. They allow you to view the camcorder tapes without using a VCR.

- ◆ Each Camcorder has a different back panel configuration.
- ◆ When connecting a Camcorder, match the color of the connection terminal to the cable.

- 1 Connect a Video Cable between the AV IN [VIDEO] jack on the TV and the VIDEO OUT jack on the camcorder.
- 2 Connect Audio Cables between the AV IN [L-AUDIO-R] jacks on the TV and the AUDIO OUT jacks on the camcorder.

- When both the side and rear jacks (AV IN) are connected to external equipment, the side receives priority.

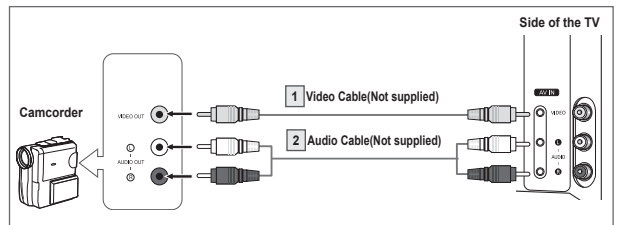

Connecting a DVD Player/Set-Top Box

The rear panel jacks on your TV make it easy to connect a DVD player/Set-Top Box.

- ◆ Each DVD Player/Set-Top Box has a different back panel configuration.
- ◆ When connecting a DVD Player/Set-Top Box, match the color of the connection terminal to the cable.

- 1 Connect Component Cables between the COMPONENT IN [Y, P_B, P_R] jacks on the TV and the COMPONENT OUT [Y, P_B, P_R] jacks on the DVD Player/Set-Top Box.
- 2 Connect Audio Cables between the COMPONENT IN [L-AUDIO-R] jacks on the TV and the AUDIO OUT jacks on the DVD Player/Set-Top Box.

- Component video separates the video into Y(Luminance (brightness)), P_B(Blue), and P_R(Red) for enhanced video quality. Be sure to match the component video and audio connections.

For example, if connecting the video cable to COMPONENT IN, connect the audio cable to COMPONENT IN also.

- This product is an SD-grade DTV and must be connected in the resolution of 480i.
- If this product is connected in the resolution of 480p, 720p or 1080i, the screen may be displayed abnormally or may not be displayed at all.

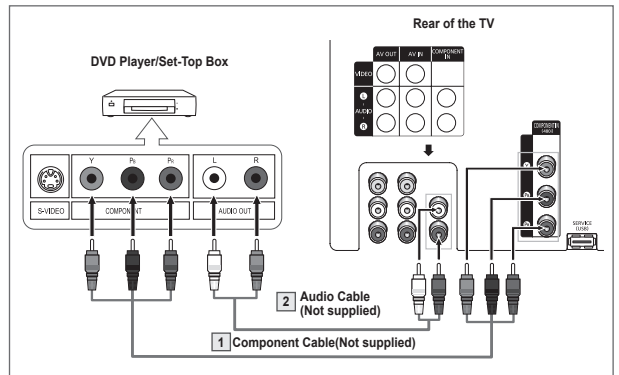

Connecting an Amplifier/DVD Home Theater - Analog

- ◆ Each Amplifier/DVD Home Theater has a different back panel configuration.
- ◆ When connecting an Amplifier/DVD Home Theater, match the color of the connection terminal to the cable.

- 1 Connect Audio Cables between the AV OUT [L-AUDIO-R] on the TV and AUDIO IN on the Amplifier/ DVD Home Theater.

When an audio amplifier is connected to the AUDIO OUT [L-AUDIO-R] terminals: Decrease the volume of the TV, and adjust the volume level with the Amplifier's volume control.

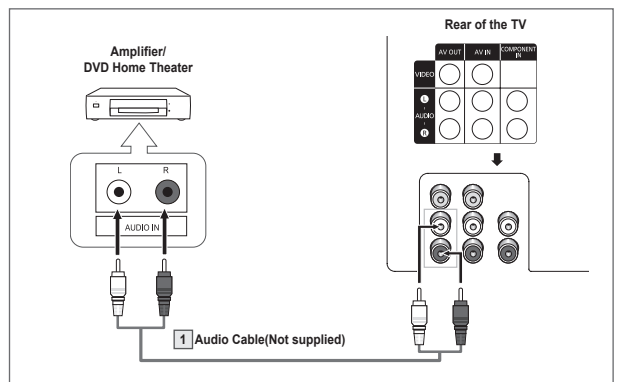

Plug & Play Feature

When the TV is initially powered on, basic settings proceed automatically and subsequently:

- 1 Press the **POWER** button on the remote control.
The message **Start Plug & Play** is displayed.
Press the **ENTER** button, then the **Language** menu is displayed.
- 2 Press the **▲** or **▼** button to select the desired language, then press the **ENTER** button.
The message **Select Home Mode when installing this TV at home.** is displayed.
- 3 Press the **◀** or **▶** button to select **Shop** or **Home**, then press the **ENTER** button.
The **Check antenna input.** menu is displayed.
 - ◆ The default selection is Home.
 - ◆ We recommend setting the TV to Home mode for the best picture in your home environment.
 - ◆ Shop mode is only intended for use in retail environments.
 - ◆ If the unit is accidentally set to Shop mode and you want to return to Dynamic (Home) mode, press the Volume button and then hold down the **MENU** button for five seconds on the TV panel.

- 4 Make sure that an antenna is connected to the TV.
Press the **ENTER** button, then the **Antenna** menu is displayed.
- 5 Press the **▲** or **▼** button to select the desired connection.
Press the **ENTER** button to memorize the channels of the selected connection.
- 6 Press the **ENTER** button to start.
First analog, then digital channels will be memorized.

When selecting Cable TV:

- 7 Press the **▲** or **▼** button to select **Cable**, then press the **ENTER** button.
The **Cable System** menu is displayed.
- 8 Press the **▲/▼/◀/▶** buttons to select the cable system for analog and digital channels respectively, then press the **ENTER** button.
- 9 Press the **ENTER** button to start. The TV begins memorizing all available channels.
Press the **ENTER** button to stop.
After all available channels are stored, the **Clock Set** menu is displayed.
 - When you select **Cable** or **Air+Cable**, it also executes "Clearing Scrambled Channels" simultaneously. See page 15.
- 10 Press the **◀** or **▶** button to move to the hour or minute.
Set the clock by pressing the **▲** or **▼** button, then press the **ENTER** button.
- 11 The message **Enjoy your watching.** is displayed.
When you have finished, press the **ENTER** button.
 - Even if the **ENTER** button is not pressed, the message will automatically disappear after several seconds.

If you want to reset this feature...

- 1 Press the **MENU** button to display the menu.
Press the **▲** or **▼** button to select **Setup**, then press the **ENTER** button.
- 2 Press the **ENTER** button to select **Plug & Play**.
For further details on setting up options, refer to the top of this page.
 - The Plug & Play feature is only available in TV and DTV mode.

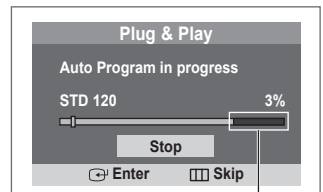
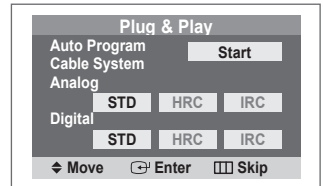
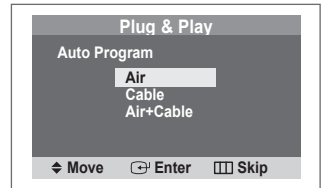
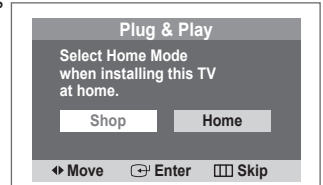

Scrambled Channels Searched

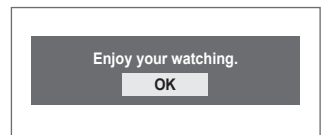
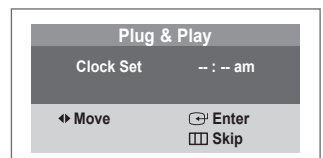

Memorizing the Channels

Your TV can memorize and store all of the available channels for both air and cable channels. After the available channels are memorized, use the CH ^ and CH v button to scan through the channels. This eliminates the need to change channels by entering the channel digits. There are three steps for memorizing channels: selecting a broadcast source, memorizing the channels(automatic) and adding or deleting channels(manual).

Selecting the Video Signal-source

Before your television can begin memorizing the available channels, you must specify the type of signal source that is connected to the TV(i.e. an air or a cable system).

- 1 Press the **MENU** button to display the menu.
Press the **▲** or **▼** button to select **Channel**, then press the **ENTER** button.
- 2 Press the **ENTER** button select **Antenna**.
Press the **▲** or **▼** button to select **Air** or **Cable**, then press the **ENTER** button.

Storing Channels in Memory (Automatic Method)

- 3 Press the **▲** or **▼** button to select **Auto Program**, then press the **ENTER** button.
- 4 Press the **▲** or **▼** button to select the antenna connection, then press the **ENTER** button.
- 5 Press the **ENTER** button to start.
First analog, then digital channels will be memorized.

When selecting Cable TV:

- 7 Press the **▲** or **▼** button to select **Cable**, then press the **ENTER** button.
The **Cable System** menu is displayed.
 - 8 Press the **▲/▼/◀/▶** buttons to select the cable system for analog and digital channels respectively, then press the **ENTER** button.
 - STD, HRC, and IRC identify various types of cable TV systems. Contact your local cable company to identify the type of cable system that exists in your particular area. At this point the signal source has been selected.
 - 9 Press the **ENTER** button to start.
The TV begins memorizing all available channels.
Press the **ENTER** button to stop.
 - When you select **Cable** or **Air+Cable** it also executes "Clearing Scrambled Channels" simultaneously. See page 15.
- This TV can receive Digital HD (High Definition) signals, but converts them to SD (Standard Definition) for viewing.



You can also press the **AUTO PROG.** button on the remote control to bring up the **Auto Program** menu.

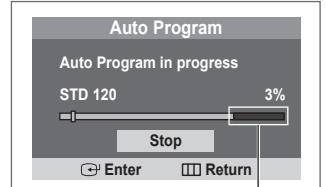
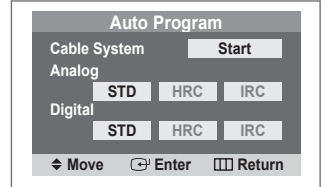
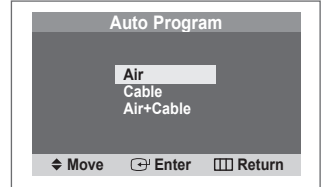
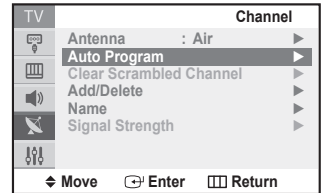
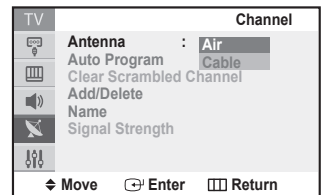

Scrambled Channels Searched

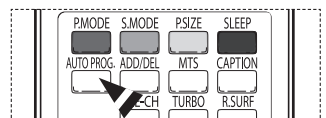

To Select the Source

Use to select TV or other external input sources such as DVD players, VCRs, etc. connected to the TV.

- 1 Press the **MENU** button to display the menu.
Press the **ENTER** button to select **Input**.
- 2 Press the **ENTER** button to select **Source List**.
Press the **▲** or **▼** button to select signal source, then press the **ENTER** button.
 - You can choose between the following sets of jacks: **TV**, **AV**, or **Component** on the TV's rear panel and **AV** on the TV's side panel.



Press the **SOURCE** button on the remote control to view an external signal source.

- ◆ In TV(Analog) mode: **TV** → **AV** → **Component**
- ◆ In DTV(Digital) mode: **DTV** → **AV** → **Component**

- To check the input signals displayed, press the **INFO** button on the remote control.

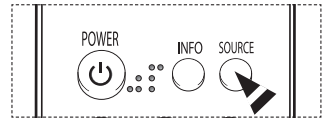
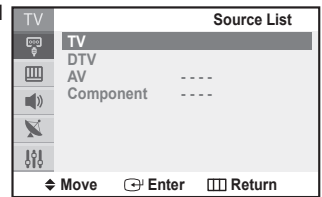

To Edit the Input Source Name

Name the external device connected to the input jacks to make your input source selection easier.

- 1 Press the **MENU** button to display the menu.
Press the **ENTER** button to select **Input**. Press the **▲** or **▼** button to select **Edit Name**, then press the **ENTER** button.
- 2 Press the **▲** or **▼** button to select **AV** or **Component** input jack, then press the **ENTER** button.
- 3 Press the **▲** or **▼** button to select **VCR**, **DVD**, **Cable STB**, **Sat. STB**, **AV Recv.**, **DVD Recv.**, **Game**, **Camcorder**, or **DVD Combo** input source, then press the **ENTER** button.
Press the **EXIT** button to exit.

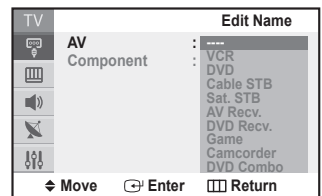

Picture Control

Using Automatic Picture Settings

Your TV has four automatic picture settings ("Dynamic", "Standard", "Movie", "Custom") that are preset at the factory.

You can activate a Picture Setting by making a selection from the menu.

- 1 Press the **MENU** button to display the menu.
Press the **▲** or **▼** button to select **Picture**, then press the **ENTER** button.
- 2 Press the **ENTER** button to select **Mode**.
Press the **ENTER** button again. Press the **▲** or **▼** button to select the **Dynamic**, **Standard**, **Movie**, or **Custom** picture setting, then press the **ENTER** button.

- ◆ Choose **Dynamic** for viewing the TV during the day or when there is bright light in the room.
- ◆ Choose **Standard** for general TV watching mode.
- ◆ Choose **Movie** when watching movies.
- ◆ Choose **Custom** if you want to adjust the settings according to personal preference.



Press the **P.MODE** button on the remote control to select one of the standard picture settings.

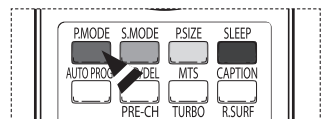
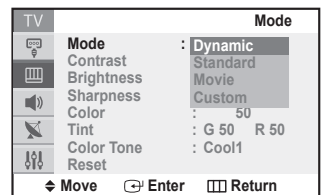

Continued...

- 3 Press the ▲ or ▼ button to select **Contrast, Brightness, Sharpness, Color, or Tint**, then press the **ENTER** button.
- 4 Press the ◀ or ▶ button to decrease or increase the value of a particular item.
➤ You can not adjust the **Tint** in DTV or Component mode.
- 5 Press the **ENTER** button to return to **Mode**.
- 6 Press the ▲ or ▼ button to select **Color Tone**, then press the **ENTER** button.
- 7 Press the ▲ or ▼ button to select **Cool2, Cool1, Normal, Warm1, or Warm2**, then press the **ENTER** button.

Resetting the Picture Settings to the Factory Defaults

- 8 Press the ▲ or ▼ button to select **Reset**, then press the **ENTER** button.
Press the **EXIT** button to exit.

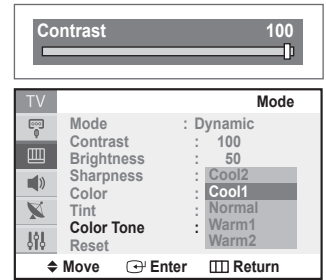

Changing the Screen Size

You can select the picture size which best corresponds to your viewing requirements.

- 1 Press the **MENU** button to display the menu.
Press the ▲ or ▼ button to select **Picture**, then press the **ENTER** button.
- 2 Press the ▲ or ▼ button to select **Size**, then press the **ENTER** button.
- 3 Press the ▲ or ▼ button to select the screen format you want, then press the **ENTER** button.
Press the **EXIT** button to exit.

- ◆ **Normal:** Sets the picture to 4:3 normal mode.
- ◆ **Zoom:** Magnifies the size of the picture on the screen.
- ◆ **Wide:** Sets the picture to 16:9 wide mode.



Press the **P.SIZE** button on the remote control repeatedly to change the picture size.

- Changing the screen size is determined by the TV signal type being viewed. Analog and Digital signals display different screen sizes.
 - ◆ **Analog TV Mode:** Switching between **Normal** and **Zoom** is possible. The TV must be connected to Analog Air/Cable, or to an external device via Composite or Component to view these screen sizes.
 - ◆ **Digital TV Mode:** Switching between **Normal** and **Wide** is possible. The TV must be connected to Digital Air/Cable to view these screen sizes.
- To identify whether the current mode is TV Mode or DTV Mode, press the **INFO** button on the remote control. To switch between Analog and Digital Air/Cable mode, press the **TV/DTV** button on the remote.

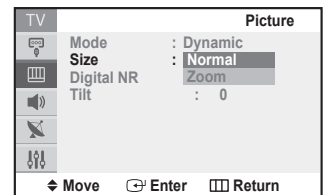

<TV Mode>

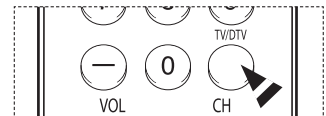
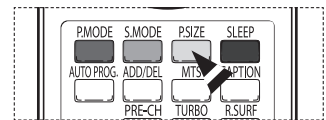

Analog TV Mode



Digital TV Mode

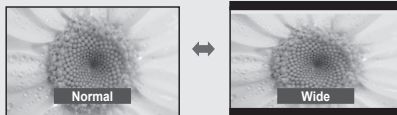

Digital Noise Reduction

If the signal received by the television is weak, you can activate this feature to reduce any static and ghosting that may appear on the screen.

- 1 Press the **MENU** button to display the menu.
Press the **▲** or **▼** button to select **Picture**, then press the **ENTER** button.
- 2 Press the **▲** or **▼** button to select **Digital NR**, then press the **ENTER** button.
- 3 Press the **▲** or **▼** button to select **Off** or **On**, then press the **ENTER** button.
Press the **EXIT** button to exit.

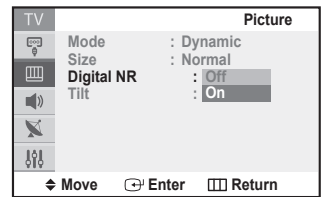

Tilt (depending on the model)

Due to the Earth's magnetic field there may be some minor image tilt depending on the TV's location. When this occurs, follow the steps below.

- 1 Press the **MENU** button to display the menu.
Press the **▲** or **▼** button to select **Picture**, then press the **ENTER** button.
- 2 Press the **▲** or **▼** button to select **Tilt**, then press the **ENTER** button.
- 3 Press the **◀** or **▶** button to adjust screen tilt.
Press the **EXIT** button to exit.

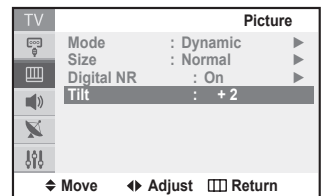

Sound Control

Using Automatic Sound Settings

Your TV has automatic sound settings ("Standard", "Music", "Movie", "Speech", and "Custom") that are preset at the factory. Or, you can select "Custom", which automatically recalls your personalized sound settings.

- 1 Press the **MENU** button to display the menu.
Press the **▲** or **▼** button to select **Sound**, then press the **ENTER** button.
- 2 Press the **ENTER** button to select **Mode**. Press the **▲** or **▼** button to select **Standard**, **Music**, **Movie**, **Speech**, or **Custom** sound setting, then press the **ENTER** button.
Press the **EXIT** button to exit.

- ◆ Choose **Standard** for the standard factory settings.
- ◆ Choose **Music** when watching music videos or concerts.
- ◆ Choose **Movie** when watching movies.
- ◆ Choose **Speech** when watching a show that is mostly dialog (i.e., news).
- ◆ Choose **Custom** to recall your personalized settings (see "Customizing the Sound").



Press the **S.MODE** button on the remote control repeatedly to select one of the standard sound settings.

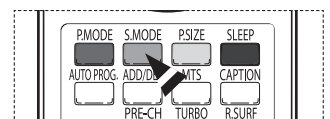
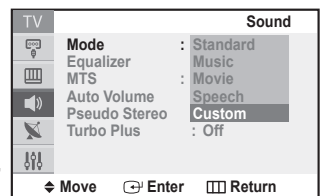

Customizing the Sound

The sound settings can be adjusted to suit your personal preference. (Alternatively, you can use one of the "automatic" settings.)

- 1 Press the **MENU** button to display the menu.
Press the **▲** or **▼** button to select **Sound**, then press the **ENTER** button.
- 2 Press the **▲** or **▼** button to select **Equalizer**, then press the **ENTER** button.
- 3 Press the **◀** or **▶** button to select a particular frequency to adjust.
Press the **▲** or **▼** button to increase or decrease the level of the particular frequency, then press the **ENTER** button.

Press the **EXIT** button to exit.

- ◆ **L/R Sound Balance Adjustment:**
To adjust the sound balance of the L/R speakers.
- ◆ **Bandwidth Adjustment(100, 300, 1K, 3K, 10K):**
To adjust the level of different bandwidth frequencies.
- If you make any changes to the equalizer settings, the sound mode is automatically switched to the **Custom**.

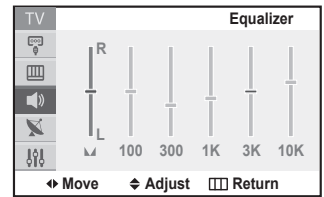

Choosing a Multi-Channel Sound (MTS) Track - Digital

The digital-TV transmission system is capable of simultaneous transmission of many audio tracks (for example, simultaneous translations of the program into foreign languages). The availability of these additional "multitracks" depends upon the program.

- 1 Press the **MENU** button to display the menu.
Press the **▲** or **▼** button to select **Sound**, then press the **ENTER** button.
- 2 Press the **▲** or **▼** button to select **Pref. lang.**, then press the **ENTER** button.
- 3 Press the **▲** or **▼** button to choose the language (**English, Spanish, or French**) you want, then press the **ENTER** button.

Press the **EXIT** button to exit.

-  Press the **MTS** button on the remote control to listen in a language other than the preferred language.

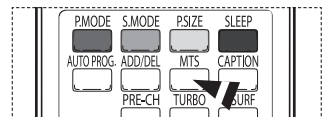
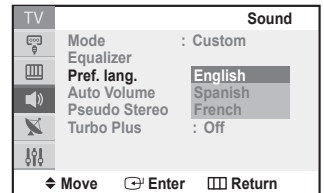

Choosing a Multi-Channel Sound (MTS) Track - Analog

- 1 Press the **MENU** button to display the menu.
Press the **▲** or **▼** button to select **Sound**, then press the **ENTER** button.
- 2 Press the **▲** or **▼** button to select **MTS**, then press the **ENTER** button.
- 3 Press the **▲** or **▼** button to select a setting you want, then press the **ENTER** button.

Press the **EXIT** button to exit.

- ◆ Choose **Mono** for channels that are broadcasting in mono, or if you are having difficulty receiving a stereo signal.
- ◆ Choose **Stereo** for channels that are broadcasting in stereo.
- ◆ Choose **SAP** to listen to the Separate Audio Program, which is usually a foreign language translation.

-  Press the **MTS** button on the remote control repeatedly to select **Mono**, **Stereo**, or **SAP**.

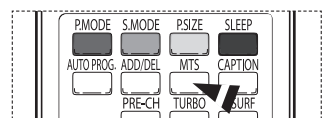
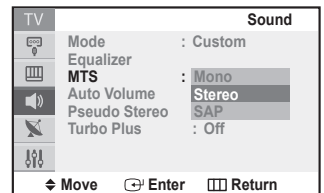

Automatic Volume Control

Reduces the differences in volume level among broadcasters.

- 1 Press the **MENU** button to display the menu.
Press the **▲** or **▼** button to select **Sound**, then press the **ENTER** button.
- 2 Press the **▲** or **▼** button to select **Auto Volume**, then press the **ENTER** button.
- 3 Press the **▲** or **▼** button to select **On** or **Off**, then press the **ENTER** button.
Press the **EXIT** button to exit.

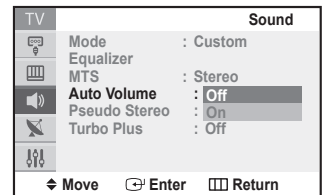

Using Pseudo Stereo

“Pseudo Stereo” converts a mono sound signal into two identical left and right channels. Once the “Pseudo Stereo” is set to “On” or “Off”, the setting is applied to sound effects such as “Standard”, “Music”, “Movie”, and “Speech”.

- 1 Press the **MENU** button to display the menu.
Press the **▲** or **▼** button to select **Sound**, then press the **ENTER** button.
- 2 Press the **▲** or **▼** button to select **Pseudo Stereo**, then press the **ENTER** button.
- 3 Press the **▲** or **▼** button to select **On** or **Off**, then press the **ENTER** button.
Press the **EXIT** button to exit.

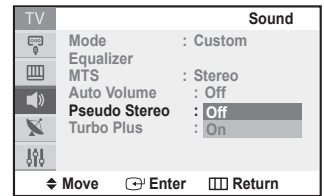

Using Turbo Plus

“Turbo Plus” emphasizes the bass and treble frequencies to add fullness to the sound.

- 1 Press the **MENU** button to display the menu.
Press the **▲** or **▼** button to select **Sound**, then press the **ENTER** button.
- 2 Press the **▲** or **▼** button to select **Turbo Plus**, then press the **ENTER** button.
- 3 Press the **▲** or **▼** button to select **On** or **Off**, then press the **ENTER** button.
Press the **EXIT** button to exit.

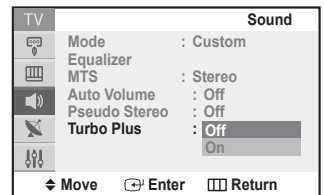

Press the **TURBO** button on the remote control repeatedly to select **On** or **Off**.

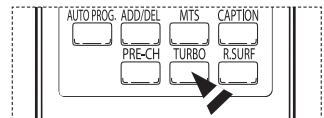

Channel Control

Clearing Scrambled Channels - Digital

The **Clear Scrambled Channel** function is used to filter out scrambled channels after **Auto Program** is completed.

It removes the scrambled channels from the list by tuning the digital cable channels. This process may take up to 20~30 minutes.

- 1 Press the **MENU** button to display the menu.
Press the **▲** or **▼** button to select **Channel**, then press the **ENTER** button.
- 2 Press the **▲** or **▼** button to select **Clear Scrambled Channel**, then press the **ENTER** button. It searches scrambled channels, which are to be removed from the list.
To stop searching scrambled channels;
Press the **▼** button to select **Stop**, then press the **ENTER** button.
Press the **◀** button to select **Yes**, then press the **ENTER** button.
- 3 When the scrambled channel searching is completed, press the **ENTER** button.
Press the **EXIT** button to exit.

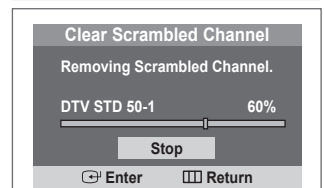
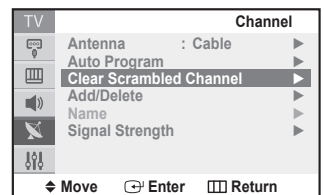

Adding and Erasing Channels - Analog

You can add or delete a channel to display the channels you want.

- 1 Press the **MENU** button to display the menu.
Press the **▲** or **▼** button to select **Channel**, then press the **ENTER** button.
- 2 Press the **▲** or **▼** button to select **Add/Delete**, then press the **ENTER** button.
- 3 Press the **▲** or **▼** button to select the desired channel, then press the **ENTER** button.
- 4 Press the **▲** or **▼** button to select **Deleted** or **Added**, then press the **ENTER** button.
Press the **EXIT** button to exit.



Press the **ADD/DEL** button on the remote control. Press the **CH ▲** and **CH ▼** button to select the channel to be added or deleted, then press the **ENTER** button.

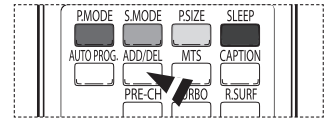
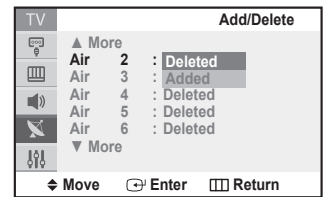

Adding and Erasing Channels - Digital

You can add or delete a DTV channel to display the DTV channels you want.

- 1 Press the **MENU** button to display the menu.
Press the **▲** or **▼** button to select **Channel**, then press the **ENTER** button.
- 2 Press the **▲** or **▼** button to select **Add/Delete**, then press the **ENTER** button.
- 3 Press the **CH ▲** or **CH ▼** button to select the desired channel, then press the **ENTER** button and select **Delete** or **Add**.
Press the **EXIT** button to exit.



Press the **ADD/DEL** button on the remote control. Press the **CH ▲** and **CH ▼** button to select the channel to be added or deleted, then press the **ENTER** button.

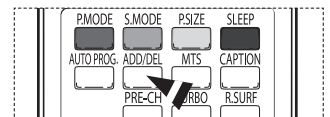
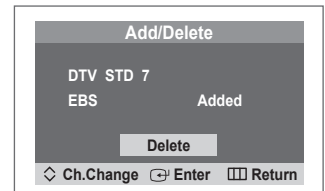

Labeling Channels - Analog

Channels can be labeled so that their call letters appear whenever the channel is selected.

- 1 Press the **MENU** button to display the menu.
Press the **▲** or **▼** button to select **Channel**, then press the **ENTER** button.
Press the **▲** or **▼** button to select **Name**, then press the **ENTER** button.
- 2 Press the **▲** or **▼** button to select the channel to be assigned a new name, then press the **ENTER** button.
- 3 Press the **▲** or **▼** button to select a letter, a number or a blank (Results in this sequence: A~Z, 0~9, blank, *, -). Press the **▶** button to switch to the next field, which will be selected. Select a second letter or digit by pressing the **▲** or **▼** button, as above. Repeat the process to select the last two digits. When you have finished, press the **ENTER** button to assign the new name.
Press the **EXIT** button to exit.

- ◆ The names of digital broadcasting channels are automatically assigned and thus cannot be assigned by users.
- ◆ If you add or delete the TV channel, the corresponding label information will also be added or deleted.

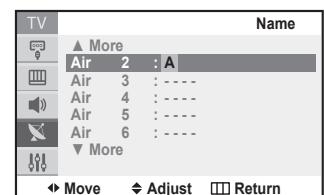

Checking the Digital-Signal Strength - Digital

Unlike analog channels, which can vary in reception quality from “snowy” to clear, digital(HDTV) channels have either perfect reception quality or you will not receive them at all. So, unlike analog channels, you cannot fine tune a digital channel. You can, however, adjust your antenna to improve the reception of available digital channels.

- 1 Press the **MENU** button to display the menu.
Press the **▲** or **▼** button to select **Channel**, then press the **ENTER** button.
- 2 Press the **▲** or **▼** button to select **Signal Strength**, then press the **ENTER** button.
If the signal strength meter indicates that the signal is weak, physically adjust your antenna to increase the signal strength. Continue to adjust the antenna until you find the best position with the strongest signal.

Press the **EXIT** button to exit.

You can also press the **ENTER** button to select **OK**, then press the **EXIT** button to exit.

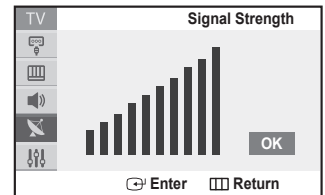

Using the R.Surf Feature

This feature allows you to set the TV to return to a particular channel after a certain amount of time. For example, you may be watching a channel when commercials start. You can set the R.Surf to “5 minutes”, then switch channels. After 5 minutes, the TV will return to the original channel. To use the R.Surf feature:

- 1 While you are watching the channel to which you want to return, press the **R.SURF** button.
The **Surf Off** is displayed.
- 2 Press the **R.SURF** button again to set the timer in thirty second intervals, up to five minutes.
 - The time will start decreasing while you are setting up the timer, and will reset after 5 minutes has passed or you turn it off.
- 3 The time you set will begin counting down on the screen.
When the time runs out, the TV will return to the channel you were watching when you set the timer.

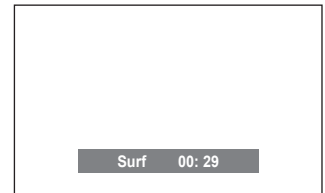
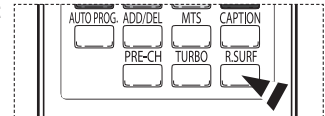

Function Description

Selecting a Menu Language

- 1 Press the **MENU** button to display the menu.
Press the **▲** or **▼** button to select **Setup**, then press the **ENTER** button.
- 2 Press the **▲** or **▼** button to select **Language**, then press the **ENTER** button.
- 3 Press the **▲** or **▼** button to select the appropriate language: **English**, **Español** or **Français**, then press the **ENTER** button.

Press the **EXIT** button to exit.

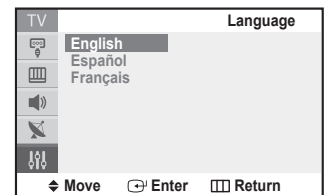

Setting the Time

Setting the clock is necessary in order to use the various timer features of the TV. Also, you can check the time while watching the TV. (Just press the INFO button.)

- 1 Press the **MENU** button to display the menu. Press the **▲** or **▼** button to select **Setup**, then press the **ENTER** button. Press the **▲** or **▼** button to select **Time**, then press the **ENTER** button.
- 2 Press the **ENTER** button to select **Clock**.
- 3 Press the **◀** or **▶** button to move to the hour or minute. Set the clock by pressing the **▲** or **▼** button, then press the **ENTER** button.

Press the **EXIT** button to exit.

- The current time will appear every time you press the **INFO** button.

Setting the Sleep Timer

The Sleep Timer automatically shuts off the TV after a preset time (from 30 to 180 minutes).

- 1 Press the **MENU** button to display the menu. Press the **▲** or **▼** button to select **Setup**, then press the **ENTER** button. Press the **▲** or **▼** button to select **Time**, then press the **ENTER** button.
- 2 Press the **▲** or **▼** button to select **Sleep Timer**, then press the **ENTER** button.
- 3 Press the **▲** or **▼** button to select the minutes.

To cancel the set sleep timer:

Press the **▲** or **▼** button to select **Off**, then press the **ENTER** button.

Press the **EXIT** button to exit.



Press the **SLEEP** button on the remote control until the appropriate time interval appears (any of the preset values from **30 min** to **180 min**).

Setting the On/Off Timer

Use this feature to set the TV to turn on or off at a desired time.

You must set the clock first.

- 1 Press the **MENU** button to display the menu. Press the **▲** or **▼** button to select **Setup**, then press the **ENTER** button. Press the **▲** or **▼** button to select **Time**, then press the **ENTER** button.
- 2 Press the **▲** or **▼** button to select **On Timer**, then press the **ENTER** button.
- 3 Press the **▲** or **▼** button to set the hour, then press the **▶** button to move to the next step. Set other items using the same method as above.
 - When finished, press the **MENU** button to return.
- 4 Press the **▲** or **▼** button to select **Off Timer**, then press the **ENTER** button.
- 5 Press the **▲** or **▼** button to set the hour, then press the **▶** button to move to the next step. Set other items using the same method as above.
 - When finished, press the **MENU** button to return.

➤ Auto Power Off

When you set the timer "On", the TV will eventually turn off if no controls are operated for 3 hours after the TV was turned on by timer. This function is only available in timer "On" mode and prevents overheating, which may occur if a TV is on for too long time.

Setting the Preferred Option

The preferred TV source, antenna, channel and volume can be set for when the timer automatically turns on the TV.

- 6 Press the **▲** or **▼** button to select **On Timer Source**, then press the **ENTER** button. Press the **▲** or **▼** button to select **TV** or **DTV**, then press the **ENTER** button.
- 7 Press the **▲** or **▼** button to select **On Timer Antenna**, then press the **ENTER** button. Press the **▲** or **▼** button to select **Air** or **Cable**, then press the **ENTER** button.
- 8 Press the **▲** or **▼** button to select **On Timer Channel** or **On Timer Volume**. Press the **◀** or **▶** button to select the desired channel or adjust volume level.

Press the **EXIT** button to exit.

TV	Time
Clock	12 : 00 am
Sleep Timer	: Off ▶
On Timer	-- : -- am Off ▶
Off Timer	-- : -- am Off ▶
On Timer Source	: TV ▶
On Timer Antenna	: Air ▶
On Timer Channel	: 3
On Timer Volume	: 10
◀ Move ▶ Adjust □ Return	

TV	Time
Clock	09 : 30 am
Sleep Timer	: Off
On Timer	-- : 30
Off Timer	-- : 60
On Timer Source	: 90
On Timer Antenna	: 120
On Timer Channel	: 150
On Timer Volume	: 180
▶ Move ◀ Enter □ Return	

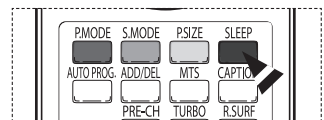

TV	Time
Clock	09 : 30 am
Sleep Timer	: Off ▶
On Timer	12 : 00 am Off ▶
Off Timer	-- : -- am Off ▶
On Timer Source	: TV ▶
On Timer Antenna	: Air ▶
On Timer Channel	: 3
On Timer Volume	: 10
◀ Move ▶ Adjust □ Return	

TV	Time
Clock	09 : 30 am
Sleep Timer	: Off ▶
On Timer	06 : 30 am On ▶
Off Timer	11 : 00 pm On ▶
On Timer Source	: TV ▶
On Timer Antenna	: Air ▶
On Timer Channel	: 3
On Timer Volume	: 10
◀ Move ▶ Adjust □ Return	

TV	Time
Clock	09 : 30 am
Sleep Timer	: Off ▶
On Timer	06 : 30 am On ▶
Off Timer	11 : 00 pm On ▶
On Timer Source	: TV ▶
On Timer Antenna	: DTV ▶
On Timer Channel	: 3
On Timer Volume	: 10
▶ Move ◀ Enter □ Return	

Viewing Closed Captions(On-Screen Text Messages) - Digital

The Digital Captions function operates on digital channels.

- 1 Press the **MENU** button to display the menu.
Press the **▲** or **▼** button to select **Setup**, then press the **ENTER** button.
- 2 Press the **▲** or **▼** button to select **Caption**, then press the **ENTER** button.
- 3 Press the **ENTER** button to select **Caption**. Press the **▲** or **▼** button to select **On**, then press the **ENTER** button.
- 4 Press the **▲** or **▼** button to select **Mode**, then press the **ENTER** button.
Press the **▲** or **▼** button to select the submenu (**Default**, **Service1~Service6**, **CC1~CC4**, or **Text1~Text4**) you want, then press the **ENTER** button.
- 5 Press the **▲** or **▼** button to select **Options**, then press the **ENTER** button.
- 6 Press the **ENTER** button to select **Size**. Press the **▲** or **▼** button to select the desired caption option, then press the **ENTER** button. Press the **▲** or **▼** button to select the desired submenu options(see options below), then press the **ENTER** button.

Press the **EXIT** button to exit.

- ◆ The availability of captions depends on the program being broadcast.
- ◆ **Default** means to follow the standard set by the broadcaster.
- ◆ Fore(Foreground) and Back cannot be set to have the same color.
- ◆ Fore Opacity and Back Opacity cannot be both set to **Transparent**.

- ◆ **Size**: This option consists of **Default**, **Small**, **Standard**, and **Large**. The default is **Standard**.
- ◆ **Font Style**: This option consists of **Default**, **Style0 ~ Style7**. You can change the font you want. The default is **Style0**.
- ◆ **Fore Color**: This option consists of **Default**, **White**, **Black**, **Red**, **Green**, **Blue**, **Yellow**, **Magenta**, and **Cyan**. You can change the color of the letter. The default is **White**.
- ◆ **Back Color**: This option consists of **Default**, **White**, **Black**, **Red**, **Green**, **Blue**, **Yellow**, **Magenta**, and **Cyan**. You can change the background color of the caption. The default is **Black**.
- ◆ **Fore Opacity**: This option consists of **Default**, **Transparent**, **Translucent**, **Solid**, and **Flashing**. You can change the opacity of the letter.
- ◆ **Back Opacity**: This option consists of **Default**, **Transparent**, **Translucent**, **Solid**, and **Flashing**. You can change the background opacity of the caption.
- ◆ **Return to Default**: This option sets each of **Size**, **Font Style**, **Fore Color**, **Back Color**, **Fore Opacity**, and **Back Opacity** to its factory default.

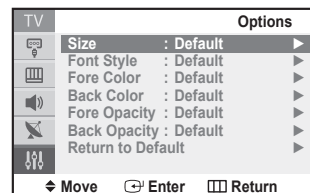
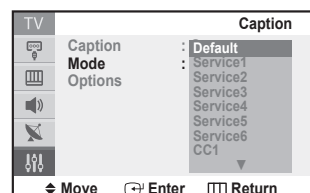

You can also press the **CAPTION** button on the remote control to select Captions **On** or **Off**.

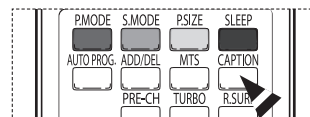

Viewing Closed Captions(On-Screen Text Messages) - Analog

The Analog Caption function operates in either analog TV channel mode or external signal mode. (Depending on the broadcasting signal, the Analog Caption function may operate on digital channels.)

- 1 Press the **MENU** button to display the menu.
Press the **▲** or **▼** button to select **Setup**, then press the **ENTER** button.
- 2 Press the **▲** or **▼** button to select **Caption**, then press the **ENTER** button.
- 3 Press the **ENTER** button to select **Caption**.
Press the **▲** or **▼** button to select **On**, then press the **ENTER** button.
 - Misspellings and unusual characters sometimes occur during closed caption transmissions, especially those of live events. There may be a small delay before captions appear when you change channels. These are not malfunctions of the TV.
- 4 Press the **▲** or **▼** button to select **Mode**, then press the **ENTER** button.
Press the **▲** or **▼** button to select the **Caption** or **Text**, then press the **ENTER** button.
 - In **Caption** mode, captions appear at the bottom of the screen, and they usually cover only a small portion of the picture.
 - In **Text** mode, information unrelated to the program, such as news or weather, is displayed. Text often covers a large portion of the screen.

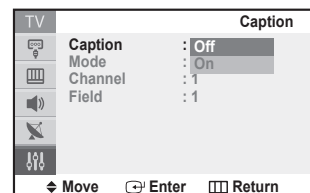

Continued...

- 5 Depending on the particular broadcast, it might be necessary to make changes to **Channel** and **Field**. Press the **▲** or **▼** button to select **Channel** or **Field**, then press the **ENTER** button. Press the **▲** or **▼** button to select **1** or **2**, then press the **ENTER** button.
- Different channels and fields display different information:
Field 2 carries additional information that supplements the information in Field 1.
(For example, Channel 1 may have subtitles in English, while Channel 2 has subtitles in Spanish.)

Press the **EXIT** button to exit.



You can also press the **CAPTION** button on the remote control to select Captions **On** or **Off**.

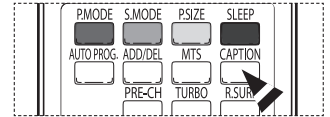

Setting the Blue Screen Mode

If no signal is being received or the signal is very weak, a blue screen automatically replaces the noisy picture background. If you wish to continue viewing the poor picture, you must set the "Blue Screen" mode to "Off".

- 1 Press the **MENU** button to display the menu.
Press the **▲** or **▼** button to select **Setup**, then press the **ENTER** button.
- 2 Press the **▲** or **▼** button to select **Blue Screen**, then press the **ENTER** button.
Press the **▲** or **▼** button to select **On** or **Off**, then press the **ENTER** button.

Press the **EXIT** button to exit.

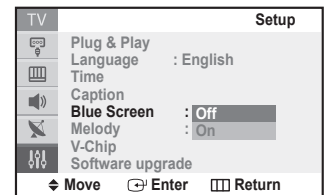

Setting the On/Off Melody

A melody sound can be set to come on when the TV is powered On or Off.

- 1 Press the **MENU** button to display the menu.
Press the **▲** or **▼** button to select **Setup**, then press the **ENTER** button.
- 2 Press the **▲** or **▼** button to select **Melody**, then press the **ENTER** button.
Press the **▲** or **▼** button to select **On** or **Off**, then press the **ENTER** button.

Press the **EXIT** button to exit.

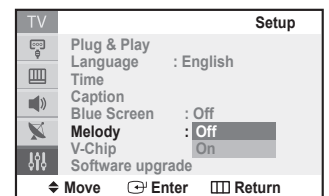

TRADEMARK & LABEL LICENSE NOTICE



Manufactured under license from Dolby Laboratories. Dolby and the double-D DIGITAL symbol are trademarks of Dolby Laboratories.

Using the V-Chip

U.S.A Only

This product is covered by the following U.S. patents : US4,930,158 US4,930,160

The **V-Chip** feature automatically locks out programs that are deemed inappropriate for children. The user must enter a PIN(Personal ID number) before any of the V-Chip restrictions are set up or changed.

How to Enable/Disable the V-Chip

- 1 Press the **MENU** button to display the menu.
Press the **▲** or **▼** button to select **Setup**, then press the **ENTER** button.
- 2 Press the **▲** or **▼** button to select **V-Chip**, then press the **ENTER** button.
The message **Enter PIN** will appear. Enter your 4 digit PIN.
➤ The default PIN of a new TV set is "0-0-0-0".
- 3 The V-Chip screen will appear. To enable the V-Chip feature, press the **ENTER** button so that the **V-Chip Lock** field is **On**. (Pressing the **▲** or **▼** button will alternate between **On** and **Off**.)

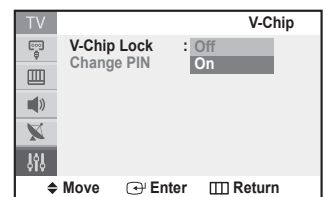

Continued...

Setting Up Your Personal ID Number(PIN)

- 4 Press the ▲ or ▼ button to select **Change PIN**, then press the **ENTER** button.
 - 5 The **Enter New PIN** screen will appear. Choose any 4 digits for your PIN and enter them. As soon as the 4 digits are entered, the **Confirm New PIN** screen appears. Re-enter the same 4 digits. When the Confirm screen disappears, your PIN has been memorized.
- If you forget the PIN, press the remote control buttons in the following sequence, which resets the pin to 0-0-0-0 : Power Off → MUTE → 8 → 2 → 4 → Power On.

How to Set up Restrictions Using the 'TV Parental Guidelines'

First, set up a personal identification number(PIN), and enable the V-Chip. (See previous section.)

Parental restrictions can be set up using either of two methods:
The TV guidelines or the MPAA rating.

- 6 Press the ▲ or ▼ button to select **TV Parental Guidelines**, then press the **ENTER** button.
- 7 Press the ▲ or ▼ button to select one of the six aged based categories:

- | | |
|--------------------------------------|--------------------------------------|
| ♦ TV-Y: Young children. | ♦ TV-PG: Parental guidance. |
| ♦ TV-Y7: Children 7 and over. | ♦ TV-14: Viewers 14 and over. |
| ♦ TV-G: General audience. | ♦ TV-MA: Mature audience. |

- 8 Press the ► button. Press the ▲ or ▼ button to select **B** or **U**. (U: Unblocked, B: Blocked) Press the **MENU** button to save. To select a different TV-Rating, press the ▲ or ▼ button and then repeat the process.

➤ The TV-Y, TV-Y7, TV-G, TV-PG, TV-14 and TV-MA have additional options. See the next step to change any of the following sub-ratings.

- | | |
|---|-------------------------------|
| ♦ FV: Fantasy violence. | ♦ L: Adult language. |
| ♦ D: Sexually suggestive dialog. | ♦ S: Sexual situation. |
| | ♦ V: Violence. |

➤ The V-Chip will automatically block certain categories that are "more restrictive". For example, if you block TV-Y category, then TV-Y7 will automatically be blocked. Similarly, if you block the TV-G category, then all the categories in the "young adult" group will be blocked (TV-G, TV-PG, TV-14, and TV-MA). The sub-ratings (D, L, S, V) work together similarly. (See next section.)

- 9 How to set the FV, V, S, L, and D sub-ratings. First, select one of these TV-Ratings: TV-Y, TV-Y7, TV-G, TV-PG, TV-14, or TV-MA (See Step 7), and press the ► button. The **B** will be displayed for each sub-rating. While **B** is selected, press the ► button to go to a sub rating. Press the ▲ or ▼ to block the sub rating. Press the **MENU** button to save. To select a different TV-Rating, press the ▲ or ▼ button and then repeat the process.

➤ The V-chip will automatically block certain categories that are "more restrictive".

For example, if you block L sub-rating in TV-PG, then the L sub-ratings in TV-14 and TV-MA will automatically be blocked.

➤ These categories consist of two separate groups: TV-Y and TV-Y7 (young children through age 7), and TV-G through TV-MA (everybody else). The restrictions for these two groups work independently: If a household includes very young children as well as young adults, the TV guidelines must be set up separately for each age group.

How to Set up Restrictions Using the MPAA Ratings: G, PG, PG-13, R, NC-17, X, NR

The MPAA rating system uses the Motion Picture Association of America (MPAA) system, and its main application is for movies. When the V-Chip lock is on, the TV will automatically block any programs that are coded with objectionable ratings (either MPAA or TV-Ratings).

- 10 Press the ▲ or ▼ button to select **MPAA Rating**, then press the **ENTER** button.
- 11 Press the ▲ or ▼ button to select an appropriate restriction. Press the ► button, then press the ▲ or ▼ button to select **B** or **U** (U: Unblocked, B: Blocked). Press the **MENU** button to save.

- | |
|--|
| ♦ G: General audience(no restriction). |
| ♦ PG: Parental guidance suggested. |
| ♦ PG-13: Parents strongly cautioned. |
| ♦ R: Restricted. Children under 17 should be accompanied by an adult. |
| ♦ NC-17: No children under age 17. |
| ♦ X: Adults only. |
| ♦ NR: Not rated. |

➤ The V-Chip will automatically block any category that is "more restrictive". For example, if you block the PG-13 category, then R, NC-17, and X will automatically be blocked also.

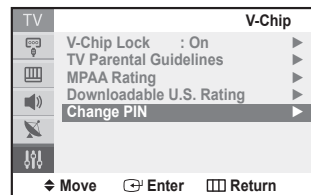

<for USA models only >

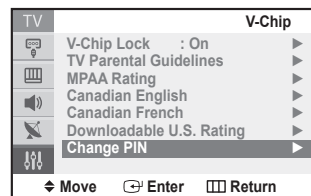

<for Canada models only >

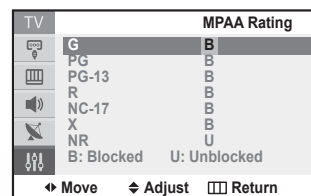
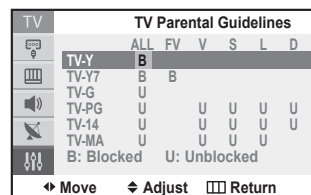

Continued...

How to Set up Restrictions Using the 'Canadian English' (for Canada Models)

12 Press the ▲ or ▼ button to select **Canadian English**, then press the **ENTER** button.

13 Press the ▲ or ▼ button to select an appropriate restriction. Press the ► button. Press the ▲ or ▼ button to select **B** or **U** (U: Unblocked, B: Blocked). Press the **MENU** button to save.

- ◆ **E**: Exempt programming includes...news, sports, documentaries and other information programming, talk shows, music videos, and variety programming.
- ◆ **C**: Programming intended for children under age 8.
- ◆ **C8+**: Programming generally considered acceptable for children 8 years and over to watch on their own.
- ◆ **G**: General programming, suitable for all audiences.
- ◆ **PG**: Parental guidance.
- ◆ **14+**: Programming contains themes or content which may not be suitable for viewers under the age of 14.
- ◆ **18+**: Adult programming.

➤ The V-Chip will automatically block any category that is "more restrictive". For example, if you block G category, then PG, 14+, and 18+ will automatically be blocked also.

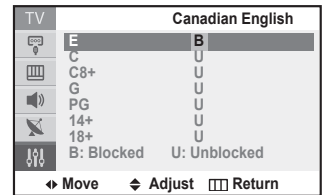

How to Set up Restrictions Using the 'Canadian French' (for Canada Models)

14 Press the ▲ or ▼ button to select **Canadian French**, then press the **ENTER** button.

15 Press the ▲ or ▼ button to select a appropriate restriction. Press the ► button. Press the ▲ or ▼ button to select **B** or **U** (U: Unblocked, B: Blocked). Press the **MENU** button to save.

- ◆ **E**: Exempt programming includes...news, sports, documentaries and other information programming, talk shows, music videos, and variety programming.
- ◆ **G**: General.
- ◆ **8 ans+**: Not recommended for young children.
- ◆ **13 ans+**: Programming may not be suitable for children under the age of 13.
- ◆ **16 ans+**: Programming is not suitable for children under the age of 16.
- ◆ **18 ans+**: Programming restricted to adults.

➤ The V-Chip will automatically block any category that is "more restrictive". For example, if you block 8 ans+ category, then 13 ans+, 16 ans+, and 18 ans+ will automatically be blocked also.

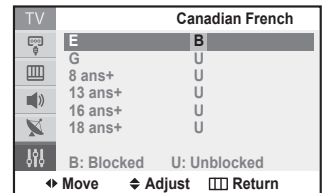

Using the V-Chip for Digital channels

Parental restriction information can be used while watching DTV channels.

16 Press the ▲ or ▼ button to select **Downloadable U.S. Rating**, then press the **ENTER** button.

- ◆ If information is not downloaded from the broadcasting station, the **Downloadable U.S. Rating** menu is deactivated.
- ◆ Parental restriction information is automatically downloaded while watching DTV channels. It may take several seconds.
- ◆ The **Downloadable U.S. Rating** menu is available for use after information is downloaded from the broadcasting station. However, depending on the information from the broadcasting station, it may not be available for use.

17 Press the ▲ or ▼ button to select an appropriate restriction. Press the **ENTER** button to activate the restriction selected. The **Lock** symbol is indicated.

Press the **EXIT** button to exit.

- ◆ **Allow All**: Press to unlock all TV ratings.
- ◆ **Block All**: Press to lock all TV ratings.
- ◆ Parental restriction levels differ depending on the broadcasting station.
- ◆ The default menu name and Downloadable US rating changes depending on the downloaded information.
- ◆ Even if you set the On-screen display to your desired language, the **Downloadable U.S. Rating** menu will appear in English only.
- ◆ The rating will automatically block certain categories that are more restrictive.
- ◆ The rating titles (for example: Humor Level..etc) and TV ratings (for example: NV, MV, V...etc) may differ depending on the broadcasting station.

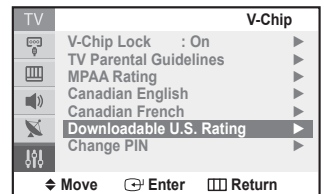

Rating title

The number of current rating title

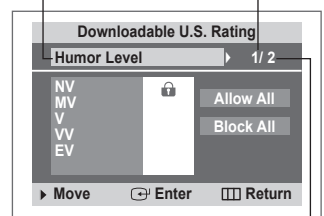

The number of all rating title

Upgrading the Software

Samsung may offer upgrades for your TV's firmware in the future. Please contact the Samsung call center at 1-800-SAMSUNG to receive information about downloading upgrades and using a USB drive. Upgrades will be possible by connecting a USB drive to the USB port located on the back of your TV.

- 1 Insert a USB drive containing the firmware upgrade into the USB Upgrade Port on the back of the TV.
- 2 Press the **MENU** button to display the menu.
Press the **▲** or **▼** button to select **Setup**, then press the **ENTER** button.
- 3 Press the **▲** or **▼** button to select **Software upgrade**, then press the **ENTER** button.
- 4 Press the **▲** or **▼** button to select **USB Upgrade**, then press the **ENTER** button.
The message **Scanning for USB... It may take up to 30 seconds.** is displayed.
Please be careful to not disconnect the power or remove the USB drive while upgrades are being applied.
The TV will shut off and turn on automatically after completing the firmware upgrade.
Please check the firmware version after the upgrades are complete.

➤ The firmware and upgrade process may be different by country and region.

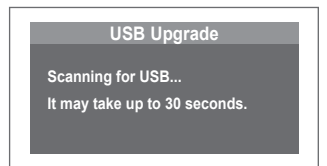
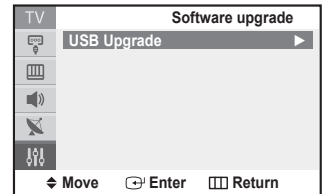
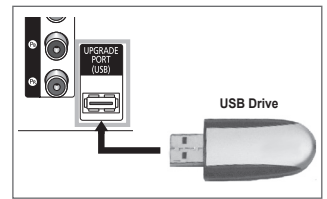

Appendix

Identifying Problems

If the TV seems to have a problem, first try this list of possible problems and solutions. If none of these troubleshooting tips apply, call your nearest Samsung service center.

Problem	Possible Solution
Poor picture quality.	Try another channel. Adjust the antenna. Check all wire connections.
Poor sound quality.	Try another channel. Adjust the antenna.
No picture or sound.	Try another channel. Press the SOURCE button. Make sure the TV is plugged in. Check the antenna connections. Make sure the MUTE button is off.
No sound or sound is too low at maximum volume.	First, check the volume of units connected to your TV (digital broadcasting receiver, DVD, cable broadcasting receiver, VCR, etc.). Then, adjust the TV volume accordingly.
Picture rolls vertically.	Check all connections.
The TV operates erratically.	Unplug the TV for 30 seconds, then try operating it again.
The TV won't turn on.	Make sure the wall outlet is working.
Remote control malfunctions	Replace the remote control batteries. Clean the upper edge of the remote control(transmission window). Check the battery terminals. Press the TV/DTV button to put your remote control in the "TV" mode. Make sure the remote has batteries. Check that the "+" and "-" ends of the batteries are inserted correctly.
Digital broadcasting screen problem.	Please check the digital signal strength and input antenna.
The image is too light or too dark.	Adjust the Brightness and Contrast. Adjust the Fine tuning.
The visual qualities of digital channels vary.	The visual qualities of digital channels may vary depending on the original production method(analog or digital). - If the original production method is digital: High visual quality program. - If the original production method is analog: The digital program displayed on the screen is originally an analog program which has been converted to digital. The visual quality is of an SD(Standard Definition) grade.
Although the TV caption shows HD, the visual quality is not satisfactory.	The HD(High Definition) caption that appears when switching channels or when pressing the Information button on the remote control means the selected channel is a digital channel. If the broadcasting station converts an analog signal into digital and transmits the signal, the visual quality may not be perfect.

Free Manuals Download Website

<http://myh66.com>

<http://usermanuals.us>

<http://www.somanuals.com>

<http://www.4manuals.cc>

<http://www.manual-lib.com>

<http://www.404manual.com>

<http://www.luxmanual.com>

<http://aubethermostatmanual.com>

Golf course search by state

<http://golfingnear.com>

Email search by domain

<http://emailbydomain.com>

Auto manuals search

<http://auto.somanuals.com>

TV manuals search

<http://tv.somanuals.com>