



TXN2734F / TXN2434F / TXN2034F
TXN2036F / TXN2730F / TXN2030F
TXN2726

COLOR TELEVISION



Owner's
Instructions

Printed in Mexico
AA68-02821A (ENG)

Warning! Important Safety Instructions



CAUTION: TO REDUCE THE RISK OF ELECTRIC SHOCK, DO NOT REMOVE COVER (OR BACK). NO USER SERVICEABLE PARTS INSIDE. REFER SERVICING TO QUALIFIED SERVICE PERSONNEL.

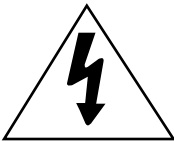

This symbol indicates high voltage is present inside. It is dangerous to make any kind of contact with any inside part of this product.



This symbol alerts you that important literature concerning operation and maintenance has been included with this product.

Note to CATV system installer: This reminder is provided to call CATV system installer's attention to Article 820-40 of the National Electrical Code (Section 54 of Canadian Electrical Code, Part I), that provides guidelines for proper grounding and, in particular, specifies that the cable ground shall be connected to the grounding system of the building as close to the point of cable entry as practical.

Caution: *FCC/CSA regulations state that any unauthorized changes or modifications to this equipment may void the user's authority to operate it.*

Caution: *To prevent electric shock, match the wide blade of plug to the wide slot, and fully insert the plug.*

Attention: *pour éviter les chocs électriques, introduire la lame le plus large de la fiche dans la borne correspondante de la prise et pousser jusqu'au fond.*

Important: One Federal Court has held that unauthorized recording of copyrighted TV programs is an infringement of U.S. copyright laws. Certain Canadian programs may also be copyrighted and any unauthorized recording in whole or in part may be in violation of these rights.

To prevent damage which may result in fire or electric shock hazard, do not expose this appliance to rain or moisture.

As an ENERGY STAR Partner,
Samsung Electronics America, Inc. has determined that this product or product model meets the ENERGY STAR guidelines for energy efficiency.

Thank You for Choosing Samsung

Thank you for choosing Samsung! Your new Samsung TV receiver represents the latest in television technology. It has easy-to-use, on-screen menus and closed-captioning capabilities, making this TV one of the best products in its class. This product will provide convenient, dependable service and enjoyment for years to come.

Important Safety Information

 To reduce the risk of fire, electrical shock, and other injuries, keep these safety precautions in mind when installing, using, and maintaining your machine.

- Read all safety and operating instructions before operating the TV receiver.
- Retain the safety and operating instructions for future reference.
- Heed all warnings on the TV receiver and in the operating instructions.
- Follow all operating instructions.
- Unplug the TV receiver from the wall outlet before cleaning. Use a damp cloth. Do not use liquid or aerosol cleaners.
- Never add any attachments and/or equipment without approval of the manufacturer. Such additions may cause risk of fire, electric shock, or other personal injury.
- Do not use the TV receiver where contact with or immersion in water is a possibility, such as near bath tubs, sinks, washing machines, swimming pools, etc.
- Do not place the TV receiver on an unstable cart, stand, tripod, bracket, or table. The TV receiver may fall, causing injury to people and/or damage to the TV. Use only with a cart, stand, tripod, bracket, or table recommended by the manufacturer or sold with the TV receiver.
- Follow the manufacturer's instructions when mounting the unit, and use a mounting accessory recommended by the manufacturer. Move the TV receiver and its cart with care. Quick stops, excessive force, and uneven surfaces may cause the unit and cart to overturn.
- Provide ventilation for the TV receiver. The unit is designed with slots in the cabinet for ventilation to protect it from overheating. Do not block these openings with any object, and do not place the TV receiver on a bed, sofa, rug, or other similar surface. Do not place it near a radiator or heat register. If you place the TV receiver on a rack or bookcase, ensure that there is adequate ventilation and that you've followed the manufacturer's instructions for mounting.
- Operate your TV receiver only from the type of power source indicated on the marking label. If you are not sure of the type of power supplied to your home, consult your appliance dealer or local power company.
- Use only a grounded or polarized outlet. For your safety, this TV is equipped with a polarized alternating-current line plug having one blade wider than the other. This plug will fit into the power outlet only one way. If you are unable to insert the plug fully into the outlet, try reversing the plug. If the plug still does not fit, contact your electrician to replace your outlet.



- Protect the power cord. Power supply cords should be routed so that they will not be walked on or pinched by items placed on or against them. Pay particular attention to cord placement at plugs, convenience receptacles, and at the point where they exit from the unit.
- Unplug the TV receiver from the wall outlet and disconnect the antenna or cable system during a lightning storm or when left unattended and unused for long periods of time. This will prevent damage to the unit due to lightning and power-line surges.
- An outside antenna system should not be placed in the vicinity of overhead power lines or other electric light or power circuits or where it can fall into such power lines or circuits. Avoid overhead power lines: When installing an outside antenna system, be extremely careful to keep from touching the power lines or circuits. Contact with such lines might be fatal.
- Do not overload the wall outlet or extension cords. Overloading can result in fire or electric shock.

- Do not insert foreign objects through openings in the unit, as they may touch dangerous voltages or cause damage. Never spill liquid of any kind on the TV receiver.

- Ground outdoor antennas. If an outside antenna or cable system is connected to the TV receiver, be sure the antenna or cable system is grounded so as to provide some protection against voltage surges and built-up static charges. Read information with respect to proper grounding of the mast and supporting structure, grounding of the lead-in wire to an antenna discharge unit, size of grounding conductors, location of antenna-discharge unit, connection to grounding electrodes, and requirements for the grounding electrode.

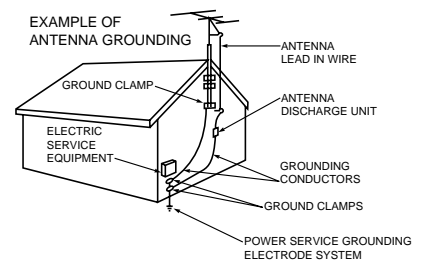

- Do not attempt to service the TV receiver yourself. Refer all servicing to qualified service personnel. Unplug the unit from the wall outlet and refer servicing to qualified service personnel under the following conditions:
 - When the power-supply cord or plug is damaged
 - If liquid has been spilled on the unit or if objects have fallen into the TV
 - If the TV receiver has been exposed to rain or water
 - If the TV receiver does not operate normally by following the operating instructions
 - If the TV receiver has been dropped or the cabinet has been damaged
 - When the TV receiver exhibits a distinct degradation in performance
- If you make adjustments yourself, adjust only those controls that are covered by the operating instructions. Adjusting other controls may result in damage and will often require extensive work by a qualified technician to restore the TV receiver to normal.
- When replacement parts are required, be sure the service technician uses replacement parts specified by the manufacturer or those that have the same characteristics as the original part. Unauthorized substitutions may result in additional damage to the unit.
- Upon completion of any service or repairs to this TV receiver, ask the service technician to perform safety checks to determine that the TV receiver is in a safe operating condition.

This device complies with part 15 of the FCC Rules. Operation is subject to the following two conditions:

- (1) This device may not cause harmful interference, and**
- (2) This device must accept any interference that may cause undesired operation.**

This television receiver provides display of television closed captioning in accordance with §15.119 of the FCC rules.

- 1) Read these instructions.
- 2) Keep these instructions.
- 3) Heed all warnings.
- 4) Follow all instructions.
- 5) Do not use this apparatus near water.
- 6) Clean only with dry cloth.
- 7) Do not block any ventilation openings. Install in accordance with the manufacturer's instructions.
- 8) Do not install near any heat sources such as radiators, heat registers, or other apparatus (including amplifiers) that produce heat.
- 9) Do not defeat the safety purpose of the polarized or grounding-type plug. A polarized plug has two blades with one wider than the other. A grounding type plug has two blades and a third grounding prong. The wide blade or the third prong are provided for your safety. If the provided plug does not fit into your outlet, consult an electrician for replacement of the obsolete outlet.
- 10) Protect the power cord from being from being walked on or pinched particularly at plugs, convenience receptacles, and the point where they exit from the apparatus.
- 11) Only use attachments/accessories specified by the manufacturer.
- 12) Use only with cart, stand, tripod, bracket, or table specified by the manufacturer, or sold with the apparatus. When a used, caution when moving the cart/apparatus combination to avoid injury from tip-over.
- 13) Unplug this apparatus. When a cart is used, use caution when moving the cart/apparatus combination to avoid injury from tip-over.
- 14) Refer all servicing to qualified service personnel. Servicing is required when the apparatus has been damaged in any way, such as power-supply cord or plug is damaged, liquid has been spilled or objects have fallen into the apparatus, the apparatus has been exposed to rain or moisture, does not operate normally, or has been dropped.



DOUBLE INSULATED - When servicing use only identical replacement parts.

Chapter 1: Your New TV	1.1
List of Features	1.1
Familiarizing Yourself with The TV	1.2
Front Panel Buttons	1.2
Side Panel Jacks	1.3
Rear Panel Jacks	1.4
Remote Control	1.5
Chapter 2: Installation	2.1
Connecting VHF and UHF Antennas	2.1
Antennas with 300-ohm Flat Twin Leads	2.1
Antennas with 75-ohm Round Leads	2.2
Separate VHF and UHF Antennas	2.2
Connecting Cable TV	2.2
Cable without a Cable Box	2.2
Connecting to a Cable Box that Descrambles All Channels	2.3
Connecting to a Cable Box that Descrambles Some Channels	2.3
Connecting a VCR	2.4
Connecting an S-VHS VCR (Option)	2.6
Connecting a Second VCR to Record from the TV	2.7
Connecting a DVD Player (Option)	2.7
Connecting a Camcorder	2.8
Installing Batteries in the Remote Control	2.9
Chapter 3: Operation	3.1
Turning the TV On and Off	3.1
Plug & Play Feature	3.1
Viewing the Menus and On-Screen Displays	3.3
Viewing the Menus	3.3
Viewing the Display	3.3
Selecting a Menu Language	3.4
Memorizing the Channels	3.5
Selecting the Video Signal-source	3.5
Storing Channels in Memory (Automatic Method)	3.6
Adding and Erasing Channels (Manual Method)	3.7
Changing Channels	3.8
Using the Channel Buttons	3.8
Directly Accessing Channels	3.8
Using the PRE-CH Button to select the Previous Channel	3.8
Adjusting the Volume	3.8
Using Mute	3.8
Labeling the Channels	3.9
Setting the Clock	3.10
Customizing the Picture	3.11
Using Automatic Picture Settings	3.12
Customizing the Sound	3.13
Using Automatic Sound Settings	3.14
Setting The On/Off Melody	3.15
Viewing a VCR or Camcorder Tape	3.16

CONTENTS

Chapter 4: Special Features 4.1

Customizing Your Remote Control 4.1
 Setting Up Your Remote Control to Operate Your
 VCR or DVD 4.1
 Setting Up Your Remote Control to Operate Your Cable Box. . 4.3
Fine Tuning Channels. 4.4
Changing the Screen Size 4.5
Digital Noise Reduction 4.6
Tilt 4.7
Using the Surf Feature 4.8
Setting the On/Off Timer 4.9
Setting the Sleep Timer. 4.10
Sound Features. 4.11
 Choosing a Multi-Channel Sound (MTS) Soundtrack. 4.11
 Extra Sound Settings
 (Turbo Sound, Surround, or Auto Volume) 4.12
Viewing Closed Captions 4.13
Using the V-Chip 4.14
 Setting Up Your Personal ID Number (PIN) 4.14
 How to Enable/Disable the V-Chip. 4.15
 How to Set up Restrictions Using the "TV guidelines" 4.15
 How to Set up Restrictions Using the MPAA Ratings:
 G, PG, PG-13, R, NC-17, X 4.17
 How to Reset the TV after the V-Chip
 Blocks a Channel ("Emergency Escape"). 4.18

Chapter 5: Troubleshooting 5.1

Identifying Problems 5.1

Appendix A.1

Cleaning and Maintaining Your TV. A.1
Using Your TV in Another Country A.1
Specifications A.1

Chapter One

YOUR NEW TV

List of Features

Your TV was designed with the latest technology. This TV is a high-performance unit that includes the following special features:

- Easy-to-use remote control
- Easy-to-use on-screen menu system
- Automatic timer to turn the TV on and off
- Adjustable picture and sound settings that can be stored in the TV's memory
- Automatic channel tuning for up to 181 channels
- A special filter to reduce or eliminate reception problems
- Fine tuning control for the sharpest picture possible
- Built-in, dual channel speakers
- A special sleep timer

Familiarizing Yourself with The TV

Front Panel Buttons

The buttons on the front panel control your TV's basic features, including the on-screen menu. To use the more advanced features, you must use the remote control.

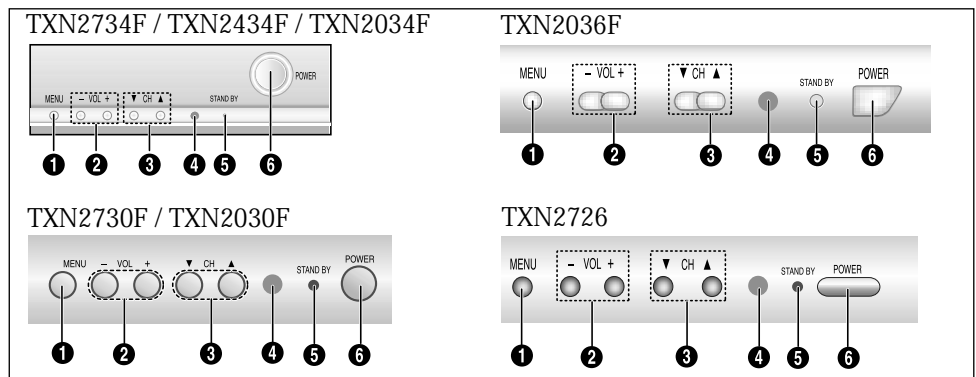

1 MENU

Press to see an on-screen menu of your TV's features.

2 VOL - , +

Press to increase or decrease the volume. Also used to select items on the on-screen menu.

3 CH ▼ and CH ▲

Press to change channels. Also press to select various items on the on-screen menu.

4 Remote Control Sensor

Aim the remote control towards this spot on the TV.

5 STAND BY indicator

Lights up when you turn the power off.

6 POWER

Press to turn the TV on and off.

YOUR NEW TV

Side Panel Jacks

You can use the Side panel jacks to connect an A/V component that is used only occasionally, such as a camcorder or video game. (For information on connecting equipment, see pages 2.1 – 2.8.)

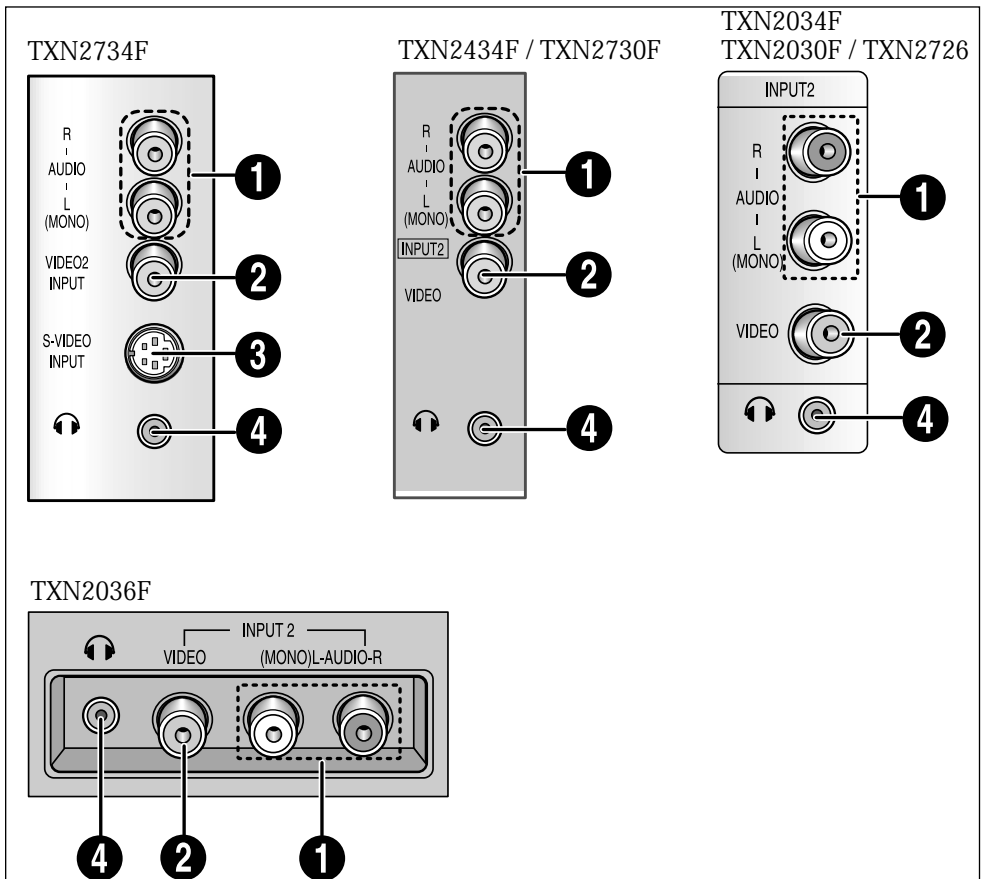

1 AUDIO INPUTS
Audio signals from VCRs, DVD players and similar devices.

2 VIDEO INPUT
Video signals from VCRs, DVD players and similar devices.

3 S-VIDEO INPUT (Option)
Connect to an S-VHS VCR or DVD player.

4 HEADPHONE
Connect a set of external headphones to this jack for private listening.

YOUR NEW TV

Rear Panel Jacks

Use the rear panel jacks to connect an A/V component that will be connected continuously, such as a VCR or a DVD player. Because there are two sets of input jacks, you can connect two different A/V components (i.e., a VCR and a DVD, 2 VCRs, etc.)

For more information on connecting equipment, see pages 2.1 – 2.8.

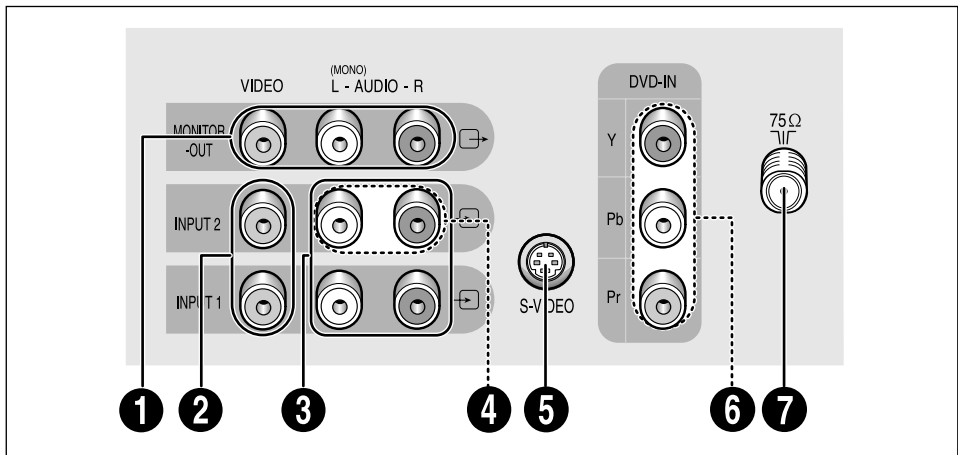

❶ AUDIO-VIDEO MONITOR OUTPUTS

These audio-video signals are identical to A/V signals being displayed on the big screen. (Typically used as the input signals for a recording VCR.)

❷ VIDEO INPUT

Video signals from VCRs, DVD players and similar devices.

❸ AUDIO INPUTS

Audio signals from VCRs, DVD players and similar devices.

❹ DVD AUDIO INPUTS (INPUT 2)

Use these jacks to connect the audio signals from a DVD player when using the DVD video input jacks. When not using the DVD jacks, these audio jacks function as audio for Video 2 or S-VIDEO.

❺ S-VIDEO INPUT (Option)

Connect to an S-VHS VCR or DVD player.

❻ DVD VIDEO INPUT (Option)

Connect video from a DVD player.

Note: Monitor Output doesn't operate in the DVD mode.

❼ VHF/UHF

Connect to an antenna or to a cable TV system.

YOUR NEW TV

Remote Control

You can use the remote control up to about 23 feet from the TV. When using the remote, always point it directly at the TV.

You can also use your remote control to operate your VCR, DVD and cable box. See page 4.1 for details.

1 POWER

Turns the TV on and off.

2 Number buttons

Press to select channels directly on the TV.

+100

Press to select channels over 100. For example, to select channel 121, press "+100", then press "2" and "1".

3 P.SIZE

Press to change the screen size. Your choices are Normal screen or Zoom screen.

4 R.SURF

Press the R.SURF button to automatically return to a preferred channel after a user-preset time delay.

5 SET

Use this button when you are setting up your remote control to operate your VCR, DVD or cable box.

6 TURBO

Press to turn the TURBO sound On or Off.

7 MUTE

Press to temporarily cut off the sound.

8 CH▲ and CH▼ (Channel Up/Down)

Press CH▲ or CH▼ to change channels. (Also used to highlight selections on the on-screen menus.)

9 P.STD

Adjust the TV picture by selecting one of the preset factory settings (or select your personal, customized picture settings).

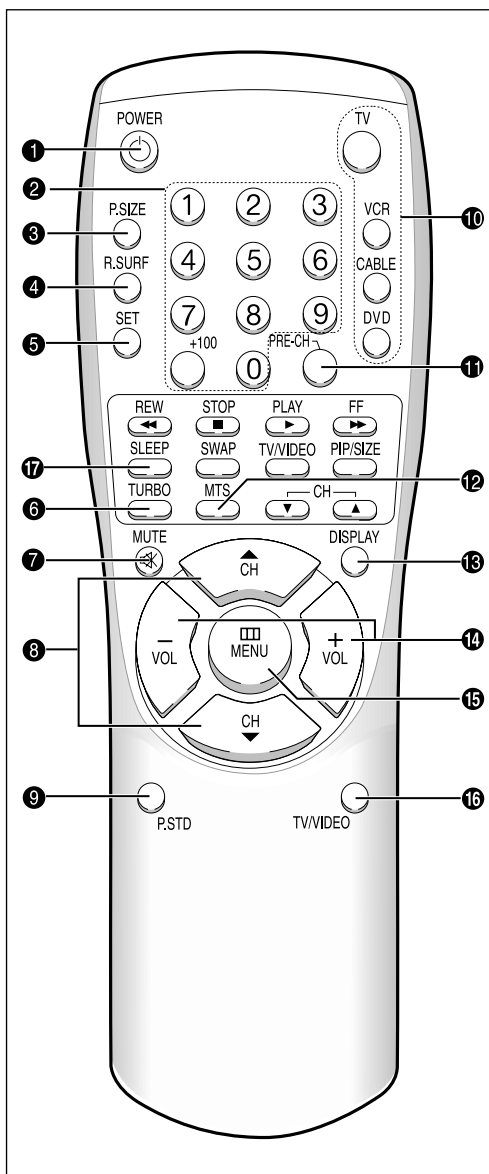

10 TV

Press to use your remote control to operate your TV.

VCR

Press to use your remote control to operate your VCR.

CABLE

Press to use your remote control to operate a cable box.

DVD

Press to use your remote control to operate your DVD.

11 PRE-CH

Tunes to the previous channel.

12 MTS (Multichannel Television Stereo)

Press to choose stereo, mono or Separate Audio Program (SAP broadcast).

13 DISPLAY

Press to see the time, channel, etc., on-screen. Also press to exit (quit) the menu system.

14 VOL -, VOL +

Press to increase or decrease the volume. (Also used to make selections on the on-screen menus.)

15 MENU

Displays the main on-screen menu.

16 TV/VIDEO

Press to display all of the available video sources (i.e., Antenna/cable, VCR).

17 SLEEP

Press to select a preset time interval for automatic shutoff.

TXN2734F / TXN2036F / TXN2730F
TXN2726

YOUR NEW TV

Remote Control

18 VCR Controls

- **REW (Rewind)**
Press to rewind a tape in your VCR.
- **STOP**
Press this button to stop a tape during play, record, rewind or fast forward. If the button is pressed during Full-Automatic play, the function will be cancelled.
- **PLAY**
Press the PLAY button to play back prerecorded tapes.
- **F.F**
Press to fast forward the tape in your VCR.

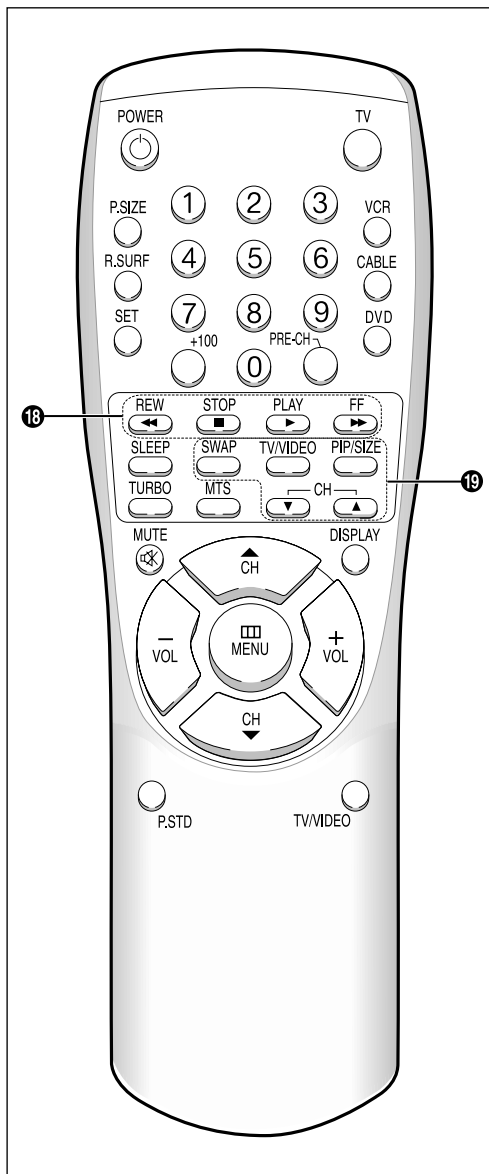

19 PIP Controls (Not available)

SWAP

Exchanges the video signal that is currently displayed on the main screen with the signal in the PIP window.

TV/VIDEO

Press to select one of the available signal sources for the PIP window.

PIP/SIZE

Press this button to control the PIP window. Press repeatedly to cycle through this sequence: PIP ON with large window, PIP ON with small window, and PIP OFF.

CH

Not available.

TXN2734F / TXN2036F / TXN2730F
TXN2726

YOUR NEW TV

Remote Control

- 1 POWER**
Turns the TV on and off.
- 2 Number buttons**
Press to select channels directly on the TV.
- 3 +100**
Press to select channels over 100. For example, to select channel 121, press "+100," then press "2" and "1."
- 4 MUTE**
Press to temporarily cut off the sound.
- 5 CH▲ and CH▼ (Channel Up/Down)**
Press CH▲ or CH▼ to change channels. (Also used to highlight selections on the on-screen menus.)

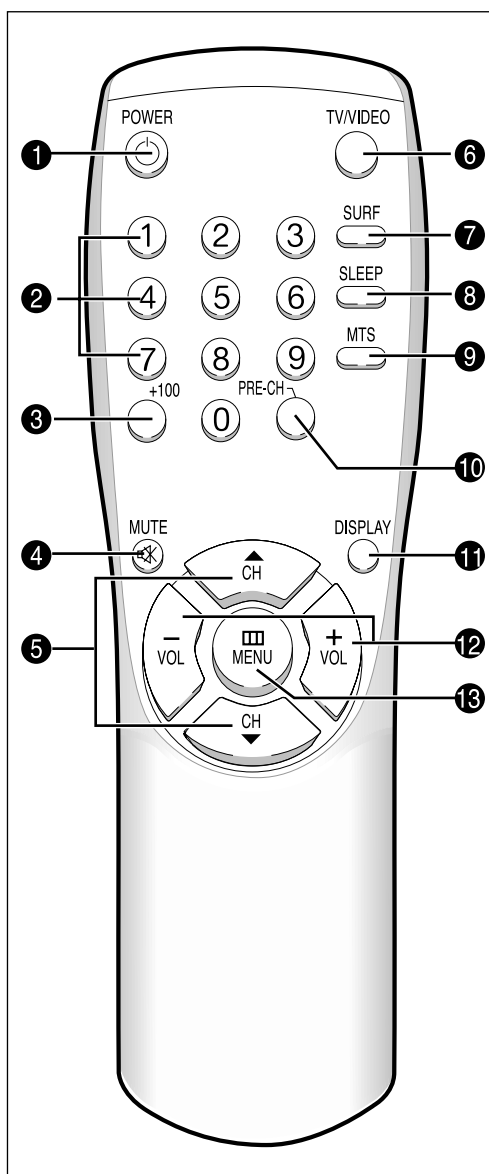

- 6 TV/VIDEO**
Press to display all of the available video sources (i.e., Antenna/cable, VCR)
- 7 SURF**
Press the SURF button to automatically return to a preferred channel after a user-preset time delay.
- 8 SLEEP**
Press to select a preset time interval for automatic shutoff.
- 9 MTS (Multichannel Television Stereo)**
Press to choose stereo, mono or Separate Audio Program (SAP broadcast).
- 10 PRE-CH**
Tunes to the previous channel.
- 11 DISPLAY**
Press to see the time, channel, etc., on-screen. Also press to exit (quit) the menu system.
- 12 VOL -, VOL +**
Press increase or decrease the volume. (Also used to make selections on the on-screen menus.)
- 13 MENU**
Displays the main on-screen menu.

TXN2434F / TXN2034F / TXN2030F

Chapter Two

INSTALLATION

Connecting VHF and UHF Antennas

If your antenna has a set of leads that look like this, see "Antennas with 300-ohm Flat Twin Leads" below.

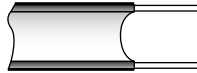

If your antenna has one lead that looks like this, see "Antennas with 75-ohm Round Leads" on page 2.2.



If you have two antennas, see "Separate VHF and UHF Antennas" on page 2.2.

Antennas with 300-ohm Flat Twin Leads

If you are using an off-air antenna (such as a roof antenna or "rabbit ears") that has 300-ohm twin flat leads, follow the directions below.

1

Place the wires from the twin leads under the screws on the 300-75 ohm adaptor (not supplied). Use a screwdriver to tighten the screws.

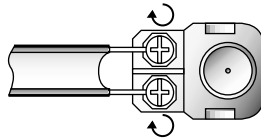

2

Plug the adaptor into the VHF/UHF terminal on the bottom of the back panel.

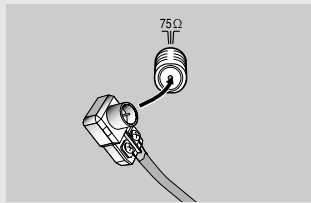

INSTALLATION

Antennas with 75-ohm Round Leads

1

Plug the antenna lead into the VHF/UHF terminal on the bottom of the back panel.

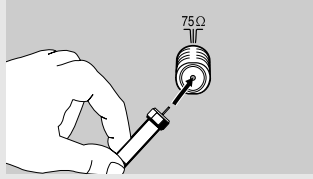

Separate VHF and UHF Antennas

If you have two separate antennas for your TV (one VHF and one UHF), you must combine the two antenna signals before connecting the antennas to the TV. This procedure requires an optional combiner-adaptor (available at most electronics shops).

1

Connect both antenna leads to the combiner.

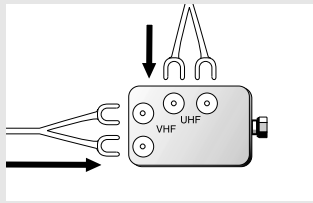

2

Plug the combiner into the VHF/UHF terminal on the bottom of the rear panel.

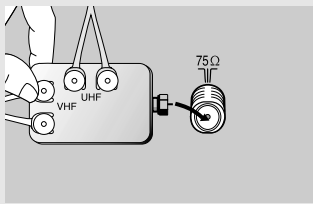

Connecting Cable TV

To connect to a cable TV system, follow the instructions below.

Cable without a Cable Box

1

Plug the incoming cable into the VHF/UHF antenna terminal on back of the TV.

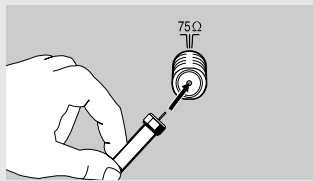

◀ Because this TV is cable-ready, you do not need a cable box to view unscrambled cable channels.

INSTALLATION

Connecting to a Cable Box that Descrambles All Channels

1

Find the cable that is connected to the ANTENNA OUT terminal on your cable box.

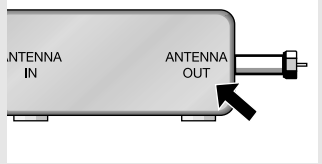

◀ This terminal might be labeled “ANT OUT”, “VHF OUT” or simply, “OUT”.

2

Connect the other end of this cable to the VHF/UHF antenna terminal on the back of the TV.

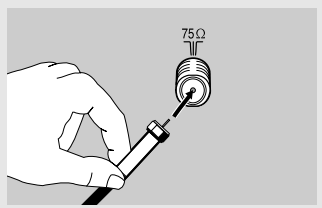

Connecting to a Cable Box that Descrambles Some Channels

If your cable box descrambles only some channels (such as premium channels), follow the instructions below. You will need a two-way splitter, an RF (A/B) switch, and four lengths of coaxial cable. (These items are available at most electronics stores.)

1

Find and disconnect the cable that is connected to the ANTENNA IN terminal on your cable box.

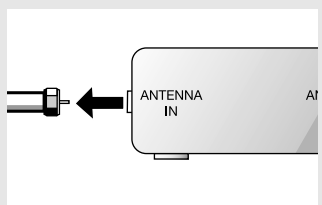

◀ This terminal might be labeled “ANT IN”, “VHF IN” or simply, “IN”.

2

Connect this cable to a two-way splitter.

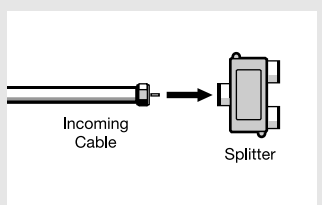

3

Connect a coaxial cable between an OUTPUT terminal on the splitter and the IN terminal on the cable box.

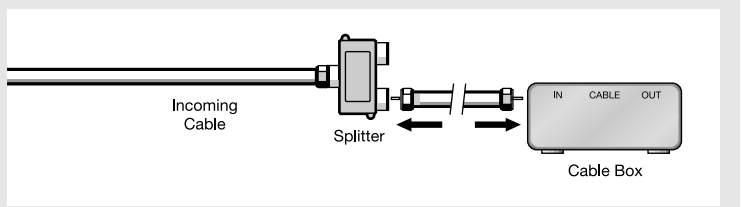

INSTALLATION

4

Connect a coaxial cable between the ANTENNA OUT terminal on the cable box and the B-IN terminal on the A/B switch.

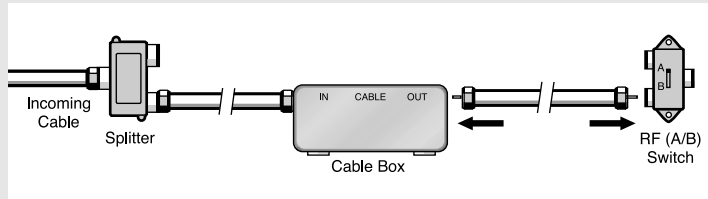

5

Connect another cable between the other OUT terminal on the splitter and the A-IN terminal on the RF (A/B) switch.

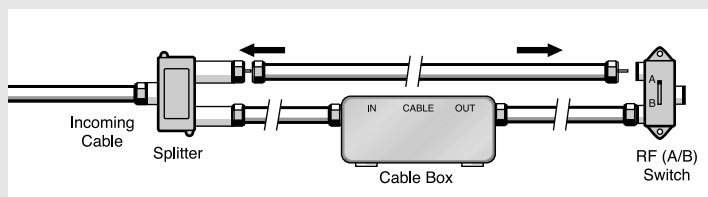

6

Connect the last coaxial cable between the OUT terminal on the RF (A/B) switch and the VHF/UHF terminal on the rear of the TV.

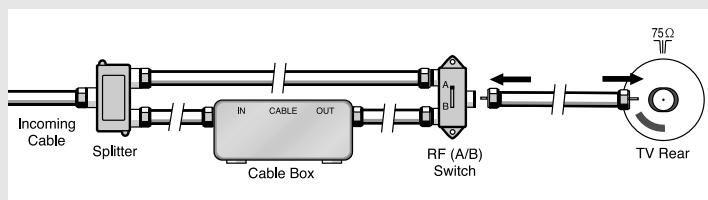

After you've made this connection, set the A/B switch to the "A" position for normal viewing. Set the A/B switch to the "B" position to view scrambled channels. (When you set the A/B switch to "B", you will need to tune your TV to the cable box's output channel, which is usually channel 3 or 4.)

Connecting a VCR

These instructions assume that you have already connected your TV to an antenna or a cable TV system (according to the instructions on pages 2.1-2.3). Skip step 1 if you have not yet connected to an antenna or a cable system.

1

Unplug the cable or antenna from the back of the TV.

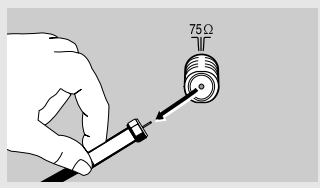

2

Connect the cable or antenna to the ANTENNA IN terminal on the back of the VCR.

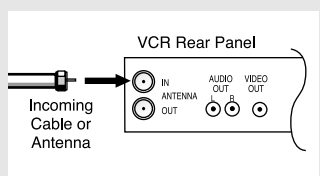

INSTALLATION

3

Connect a coaxial cable between the ANTENNA OUT terminal on the VCR and the antenna terminal on the TV.

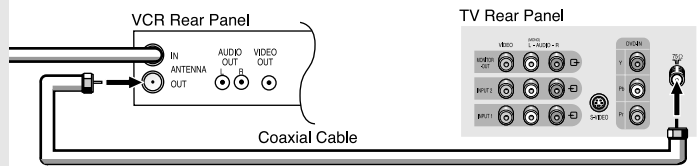

A coaxial cable is usually included with a VCR. (If not, check your local electronics store).

4

Connect a set of audio cables between the AUDIO OUT jacks on the VCR and the AUDIO jacks on the TV.

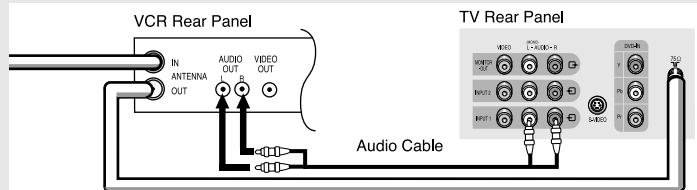

5

Connect a video cable between the VIDEO OUT jack on the VCR and the VIDEO jack on the TV.

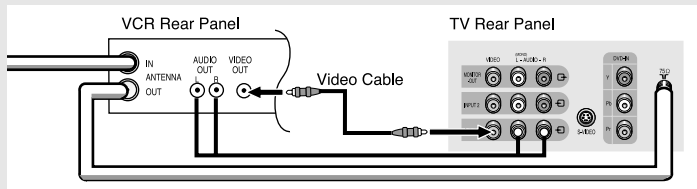

Follow the instructions in "Viewing a VCR or Camcorder Tape" to view your VCR tape.

Note: This figure shows the Standard connector-jack panel. The actual configuration for your TV may be different.

INSTALLATION

Connecting an S-VHS VCR (Option)

Your Samsung TV can be connected to an S-Video signal from an S-VHS VCR. (This connection delivers a better picture as compared to a standard VHS VCR.)

1

To begin, follow steps 1-3 in the previous section to connect the antenna or cable to your VCR and your TV.

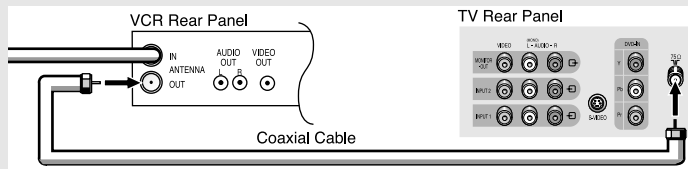

2

Connect a set of audio cables between the AUDIO OUT jacks on the VCR and the 2 AUDIO INPUT jacks on the TV.

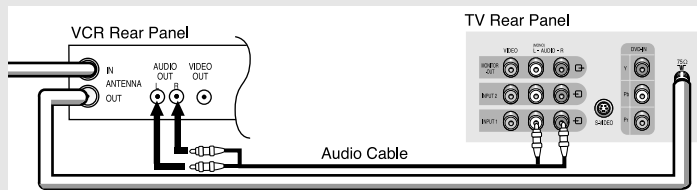

Make sure the jacks you are using are underneath the number "2".

3

Connect an S-video cable between the S-VIDEO OUT jack on the VCR and the S-VIDEO INPUT jack on the TV.

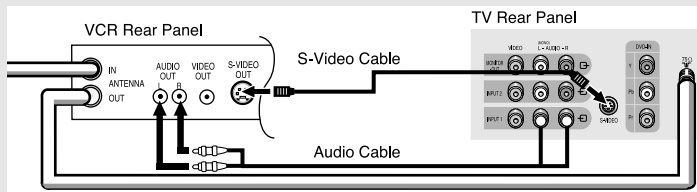

An S-video cable is usually included with an S-VHS VCR. (If not, check your local electronics store.)

INSTALLATION

Connecting a Second VCR to Record from the TV

Your TV can send out signals of its picture and sound to be recorded by a second VCR. To do this, connect your second VCR as follows:

1

Connect a set of audio cables between the AUDIO OUT jacks on the TV and the AUDIO IN jacks on the VCR.

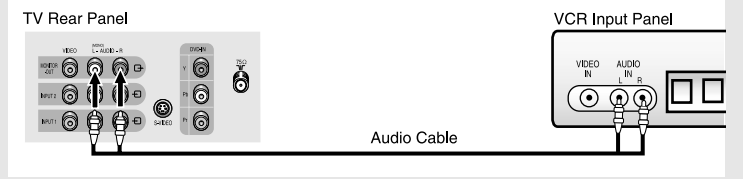

(The VCR input jacks might be either on the front or on back of the VCR.)

2

Connect a video cable between the VIDEO OUT jack on the TV and the VIDEO IN jack on the VCR.

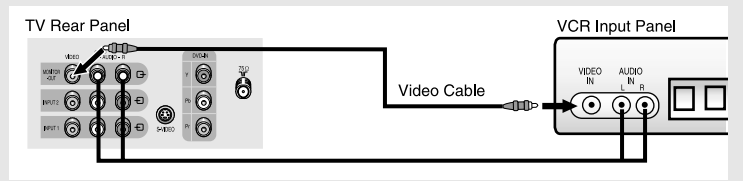

Refer to your VCR's instructions for more information about how to record using this kind of connection.

Connecting a DVD Player (Option)

The rear panel jacks on your TV make it easy to connect a DVD player to your TV.

1

Connect a set of audio cables between the AUDIO INPUT 2 jacks on the TV and the AUDIO OUT jacks on the DVD player.

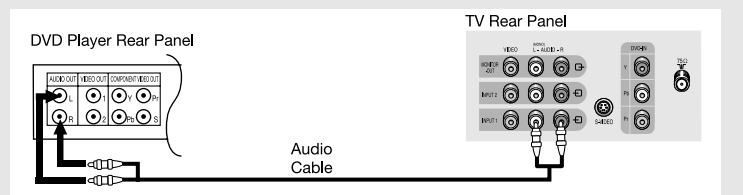

2

Connect a video cable between the DVD-IN (Y, Pb, Pr) jacks on the TV and the DVD-OUT (Y, Pb, Pr) jacks on the DVD player.

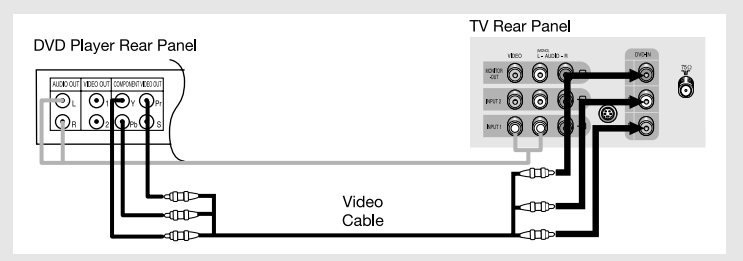

Note: For an explanation of Component video, see your DVD player's owner's manual.

INSTALLATION

Connecting a Camcorder

The rear panel jacks on your TV make it easy to connect a camcorder to your TV. They allow you to view the camcorder tapes without using a VCR. (Also see “Viewing a VCR or Camcorder Tape” on page 3.16)

1

Locate the A/V output jacks on the camcorder. They are usually found on the side or back of the camcorder.

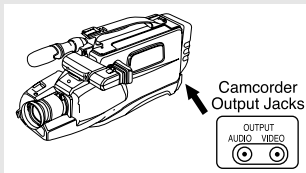

2

Connect an audio cable between the AUDIO OUTPUT jack on the camcorder and the AUDIO terminals on the rear of the TV.

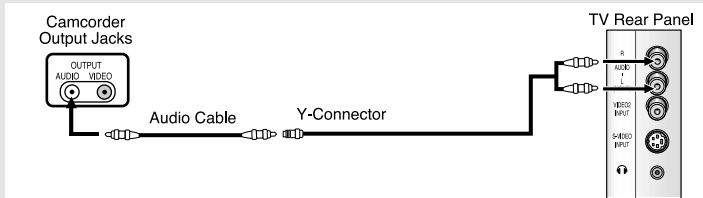

3

Connect a video cable between the VIDEO OUTPUT jack on the camcorder and the VIDEO terminal on the rear of the TV.

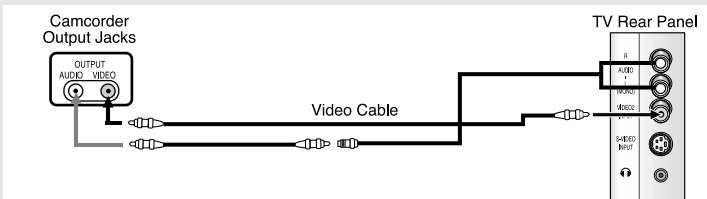

The audio-video cables shown here are usually included with a Camcorder. (If not, check your local electronics store.) If your camcorder is stereo, you need to connect a set of two cables.

Note: This figure shows the Standard connector-jack panel. The actual configuration for your TV may be different.

INSTALLATION

Installing Batteries in the Remote Control

1

Slide the cover out completely.

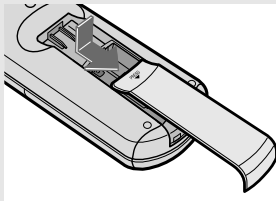

2

Install two AA size batteries.

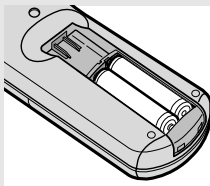

◀ Make sure to match the “+” and “-” ends of the batteries with the diagram inside the compartment.

3

Replace the cover.

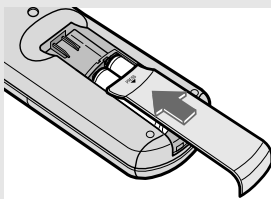

◀ Remove the batteries and store them in a cool, dry place if you won't be using the remote control for a long time.

The remote control can be used up to about 23 feet from the TV.

(Assuming typical TV usage, the batteries last for about one year.)

Chapter Three

OPERATION

Turning the TV On and Off

Press the **POWER** button on the remote control.
You can also use the **POWER** button on the front panel.

Plug & Play Feature

When the TV is initially powered On, five basic customer settings proceed automatically and subsequently: Setting the language, Video signal source, Ant. input check, Auto program, and Clock.

1

Press the **POWER** button on the remote control.

The message "Plug & Play" is displayed.
It flickers for a little while and then the "Language" menu is automatically displayed.



2

Press the **VOL+** or **VOL-** button to select the desired language.
Press the **MENU** button to enter the language, and then the "Channel" menu is automatically displayed.

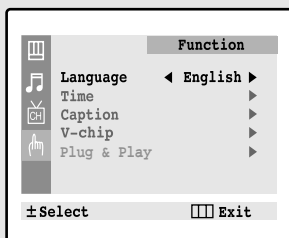

3

Press the **VOL+** or **VOL-** button to select the desired video signal source.
Press the **MENU** button to enter the video signal source, and then the "Ant Input check" is automatically displayed.

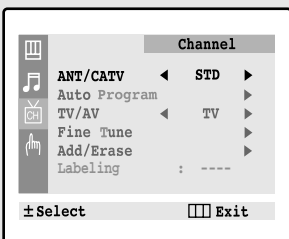

continued...

OPERATION

4

Make sure that the antenna is connected to the TV. And then press the **VOL+** or **VOL-** button to activate "Auto Program" or press the **MENU** button to skip. (refer to "Auto program" on page 3.6.)

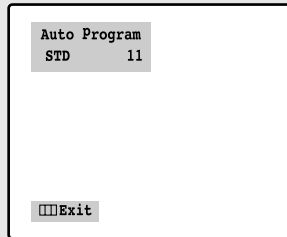

5

Press the **VOL+** or **VOL-** button to move to the hour or minute. Set the hour or minute by pressing the **CH▲** or **CH▼** button. (refer to "Setting the clock" on page 3.10.)

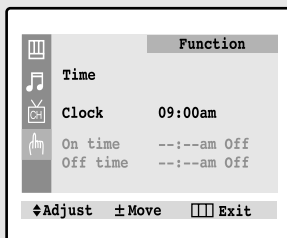

6

When you have finished, press the **MENU** button. The message "Enjoy your watching.." is displayed.

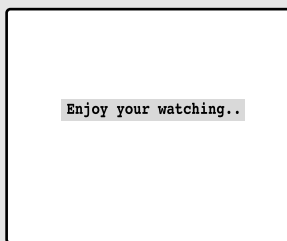

7

If you want to reset this feature

- (1) Press the **MENU** button.
- (2) Press the **CH▼** button three times to select the Function menu and press the **VOL+** button.
- (3) Press the **CH▼** button to select Plug & Play and press the **VOL+** button.
The message "Plug & Play" is displayed.

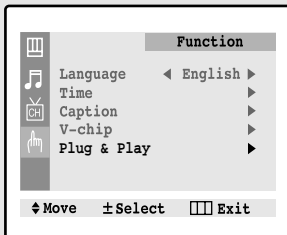

Note: Plug & Play feature doesn't work when the V-chip is on or when in the A/V mode.

Viewing the Menus and On-Screen Displays

Viewing the Menus

1

With the power on, press the **MENU** button.

The main menu appears on the screen. Its left side has four icons: Picture, Sound, Channel, and Function.

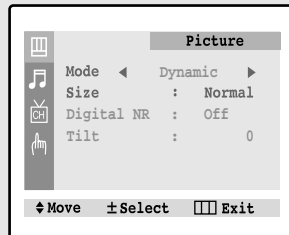

◀ The on-screen menus disappear from the screen after about thirty seconds.

2

Use the **CH▲** and **CH▼** buttons to highlight one of the 4 icons. Then press the **VOL+** button to access the icon's sub-menu.

Press the **MENU** button to exit.

◀ You can also use the **MENU**, **CHANNEL**, and **VOLUME** buttons on the control panel of the TV to make selections.

Viewing the Display

1

Press the **DISPLAY** button on the remote control.

The on-screen display shows any or all of the following: Active channel, Audio source and the time.

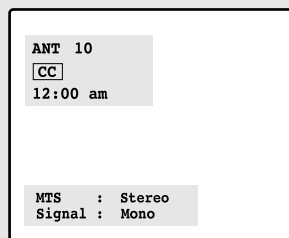

◀ The on-screen displays disappear after about twelve seconds.

When Closed Caption has been set, the icon (CC) will appear by pressing the Display button.

OPERATION

Selecting a Menu Language

1

Press **MENU** to display the menu.

Press **CH ▼** three times to select "Function", then press the **VOL +** button.

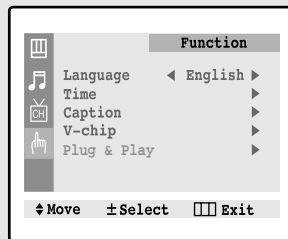

2

Press **VOL +** to select the appropriate language: English, Spanish, or French.

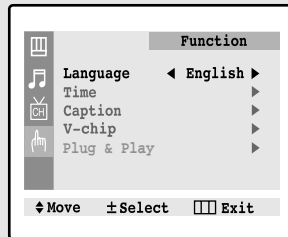

3

Press **MENU** twice to exit.

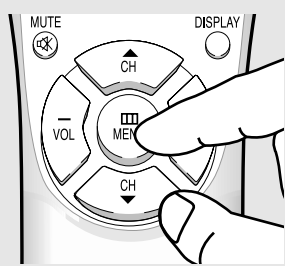

Memorizing the Channels

Your TV can memorize and store all of the available channels for both “off-air” (antenna) and cable channels. After the available channels are memorized, use the CH ▲ and CH ▼ buttons to scan through the channels. This eliminates the need to change channels by entering the channel digits. There are three steps for memorizing channels: selecting a broadcast source, memorizing the channels (automatic) and adding and deleting channels (manual).

Selecting the Video Signal-source

Before your television can begin memorizing the available channels, you must specify the type of signal source that is connected to the TV (i.e., an antenna or a cable system).

1

Press **MENU** to display the menu.

Press **CH ▼** two times to select “Channel”, then press the **VOL +** button.

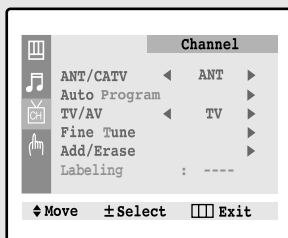

2

Repeatedly press **VOL +** to cycle through these choices:
ANT (antenna),
STD, HRC or IRC (all cable TV).

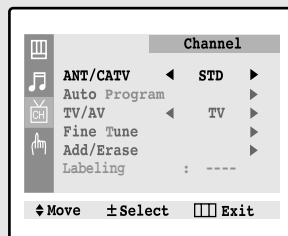

Note: STD, HRC and IRC identify various types of cable TV systems. Contact your local cable company to identify the type of cable system that exists in your particular area.

At this point the signal source has been selected. Proceed to “Storing Channels in Memory” (next page).

3

Press **MENU** twice to exit.

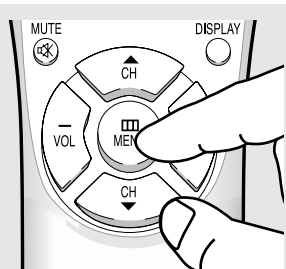

OPERATION

Storing Channels in Memory (Automatic Method)

1

First, select the correct signal source (ANT, STD, HRC, IRC). See steps 1-3 on previous page.

Press the **MENU** button, then press the **CH ▼** button twice to select "Channel," then press the **VOL +** button.

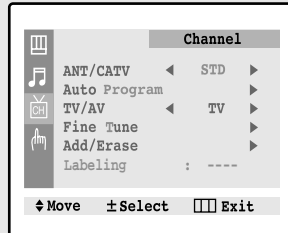

2

Press the **CH ▼** button to select "Auto program".

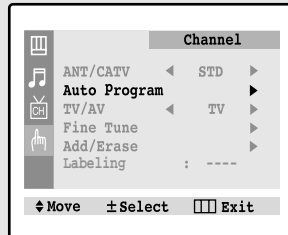

3

Press the **VOL +** button. The TV will begin memorizing all of the available channels.

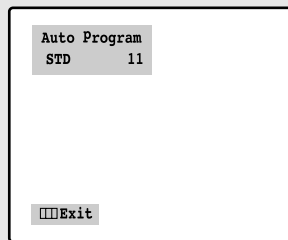

◀ The TV automatically cycles through all of the available channels and stores them in memory. This takes about one to two minutes.

Press the **MENU** button at any time to interrupt the memorization process and return to the Channel menu.

4

After all the available channels are stored, the Auto program menu reappears. Press the **MENU** button twice to exit.

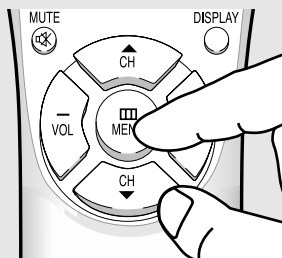

OPERATION

Adding and Erasing Channels (Manual Method)

1

Press the **MENU** button.
Press the **CH ▼** button
twice to select "Channel",
then press the **VOL+** button.

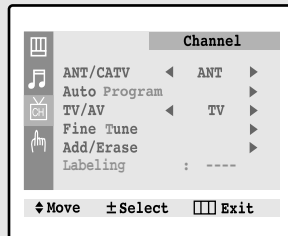

2

Press the **CH ▲** or **CH ▼**
button to select
"Add/Erase".
Press the **VOL+** button.

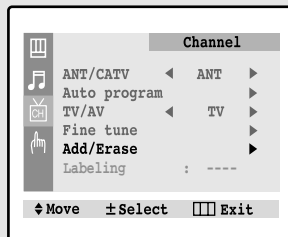

3

Press the **VOL+/+** or number
buttons to select the
channel you want added
or erased.

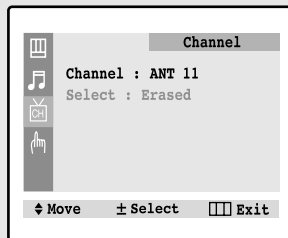

4

Press the **CH ▲** or **CH ▼**
button to select "Select".

Press the **VOL+** or **VOL-**
button to select "Added"
or "Erased".

Press the **MENU** button
three times to exit.

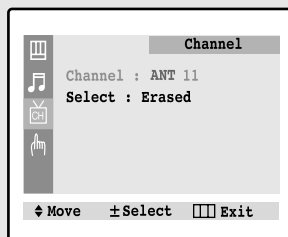

Changing Channels

Using the Channel Buttons

1

Press the **CH ▲** or **CH ▼** button to change channels.

When you press **CH ▲** or **CH ▼**, the TV changes channels in sequence. You will see all the channels that the TV has memorized. (The TV must have memorized at least three channels.) You will not see channels that were either erased or not memorized.

Directly Accessing Channels

Use the number buttons to quickly tune to any channel.

1

Press the number buttons to go directly to a channel.
For example, to select channel 27, press “2”, then “7”.
The TV will change channels when you press the second number.

When you use the number buttons, you can directly select channels that were either erased or not memorized.

To select a channel over 100, press the **+100** button. (For channel 122, press “+100”, then “2”, then “2”.)

To change to single-digit channels (0–9) faster, press “0” before the single digit. (For channel “4”, press “0”, then “4”.)

Using the PRE-CH Button to select the Previous Channel

1

Press the **PRE-CH** button.
The TV will switch to the last channel viewed.

◀ To quickly switch between two channels that are far apart, tune to one channel, then use the number button to select the second channel. Then, use the **PRE-CH** button to quickly alternate between them.

Adjusting the Volume

Press the **VOL +** or **VOL –** button to increase or decrease the volume.

Using Mute

At any time, you can temporarily cut off the sound using the Mute button.

1

Press the **MUTE** button and the sound cuts off.
The word “Mute” will appear in the lower-left corner of the screen.

2

To turn mute off, press the **MUTE** button again, or simply press either the **VOL –** or **VOL +** button.

Labeling the Channels

(TXN2734F / TXN2434F / TXN2730F / TXN2726)

Use this feature to assign an easy-to-remember label to any channel (i.e., “CBS”, “ESPN”, “PBS2”, “CNN1”, etc.) A label consists of four fields, where each field is a letter, a number, “*”, or a blank. When the DISPLAY button is pressed, the channel label will appear next to the channel number.

1

Press the **CH ▲** or **CH ▼** button to tune to the channel that will be labeled.

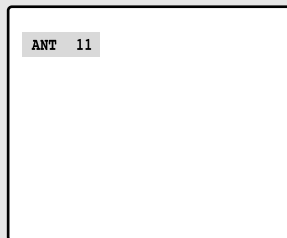

2

Press the **MENU** button to display the menu, then press the **CH ▼** button to select “Channel”.

Press the **VOL +** button.

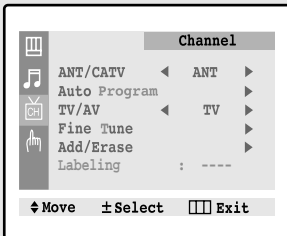

◀ Note: You cannot select “Labeling” in the A/V mode.

3

Press the **CH ▼** button to select “Labeling”.

Press the **VOL +** button to begin labeling. The left-most field will be highlighted.

(Each label has four fields. See top paragraph.)

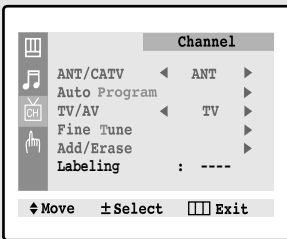

4

Press the **CH ▲** or **CH ▼** button to select a letter, a number, “*”, or a blank. (Pressing the **CH ▲** button results in this sequence: A,B,...Z,*, blank,0,1,...9).

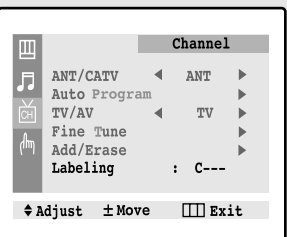

5

Press the **VOL+** button to switch to the next field, which will be highlighted. Select a second letter or digit using the **CH ▲** and **CH ▼** buttons, as above. Repeat the process to select the **MENU** button to set the label and clear the menus from the screen.

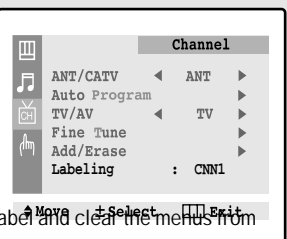

OPERATION

Setting the Clock

1

Press the **MENU** button to display the on-screen menu.

Press the **CH ▼** button three times to select "Function".
Press the **VOL +** button.

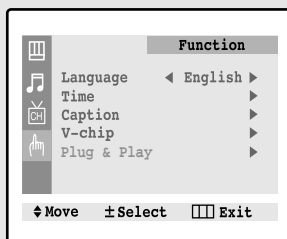

2

Press the **CH ▼** button to select "Time" menu.

Press the **VOL +** button:
The Time menu will appear on the screen, and "Clock" will be selected.

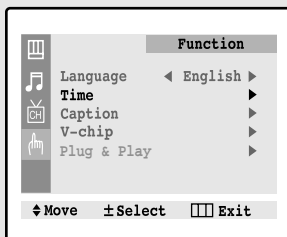

3

Press the **VOL +** button again (the hours digits will be selected). Press the **CH ▲** or **CH ▼** button repeatedly until the correct hour appears.

After the hour is entered, press the **VOL +** button. (at this point the minutes digits will be selected.)

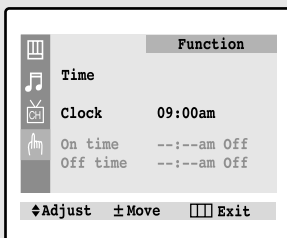

◀ When selecting the hours, be sure to select the proper time of day (AM or PM).

You can change the hours by pressing **CH ▲** or **CH ▼** repeatedly (or by holding down either of these buttons).

4

Press the **CH ▲** or **CH ▼** button to select the correct minutes.

After selecting the correct minutes, press the **VOL +** button.

Press the **MENU** button three times to exit.

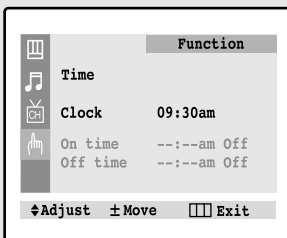

◀ The time will appear every time you press DISPLAY.

Customizing the Picture

You can use the on-screen menus to change the contrast, brightness, tint, color, and sharpness according to personal preference. (Alternatively, you can use one of the “automatic” settings. See next page.)

- 1**
Press **MENU** to display menu.

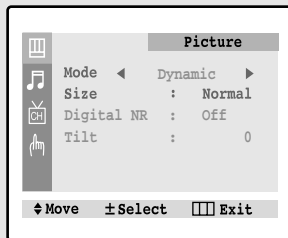

- 2**
Press **VOL -** or **VOL +** repeatedly, until the word “Custom” is selected. (When Custom is highlighted, the words “Adjust” will appear on the screen.)

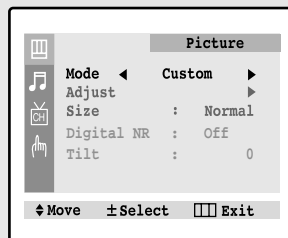

- 3**
Press **CH ▼** to select “Adjust”, then press **VOL+**. (The words Color Tone, Contrast, Brightness, Sharpness, Color, and Tint will appear on the screen.) Press **CH ▲** or **CH ▼** to select a particular item.

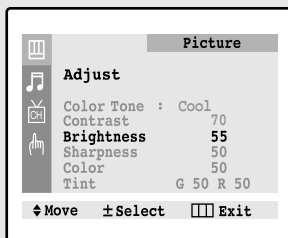

- 4**
Press **VOL -** or **VOL +** to increase or decrease the value of a particular item.

Press **MENU** four times to exit.

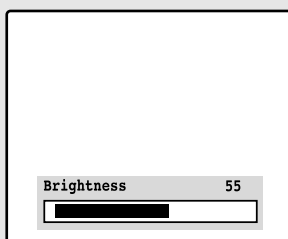

◀ After adjusting an item, the gauge will automatically disappear (after about 5 seconds).

Using Automatic Picture Settings

Your TV has three automatic picture settings (“Dynamic”, “Standard”, and “Movie”) that are preset at the factory. You can activate either Dynamic, Standard or Movie by making a selection from the menu. Or, you can select “Custom” which automatically recalls your personalized picture settings.

1

Press **MENU** to display the menu.

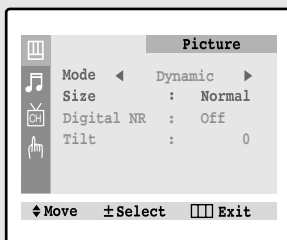

2

Press **VOL -** or **VOL +** to select the “Dynamic”, “Standard”, “Movie” or “Custom” picture setting.

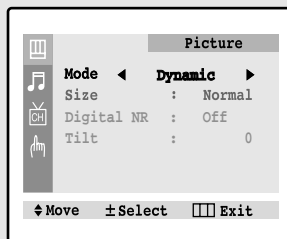

- Choose *Dynamic* for viewing the TV during the day or when there is bright light in the room.
- Standard: Optimal indoor screen condition.
- Choose *Movie* when viewing the TV in low light, or when playing video games.
- Choose *Custom* if you want to adjust the settings according to personal preference (see “Customizing the Picture”, page 3.11).

Customizing the Sound

You can use the on-screen menus to adjust the bass, treble, and balance according to individual preference. (Alternatively, you can use one of the “automatic” settings. See next page.)

1

Press the **MENU** button to display the menu.

Press the **CH ▼** button to select “Sound” menu.

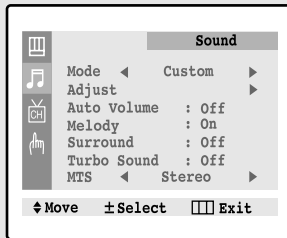

2

Press the **VOL -** or **VOL +** button repeatedly, until the word “Custom” is selected.

(When Custom is selected, the words “Adjust” will appear on the screen.)

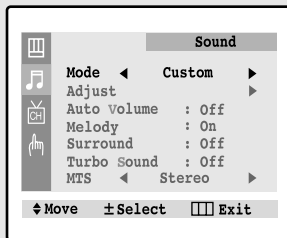

3

Press the **CH ▼** button to select “Adjust”, then press the **VOL+** button. (The words Bass, Treble, and Balance will appear on the screen.)

Press the **CH ▲** or **CH ▼** button to select a particular item to be changed.

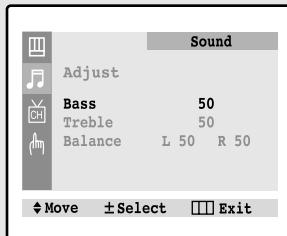

4

Press the **VOL -** or **VOL +** button to increase or decrease the value of a particular item.

Press the **MENU** button four times to exit.

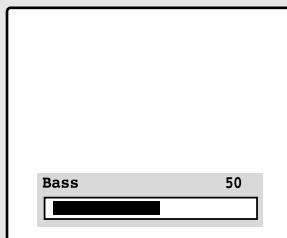

Using Automatic Sound Settings

Your TV has four automatic sound settings (“Standard”, “Music”, “Movie” and “Speech”) that are preset at the factory. You can activate any of them by making a selection from the on-screen menu. Or, you can select “Custom”, which automatically recalls your personalized sound settings.

1

Press the **MENU** button to display the menu.

Press the **CH▼** button to select “Sound” menu.

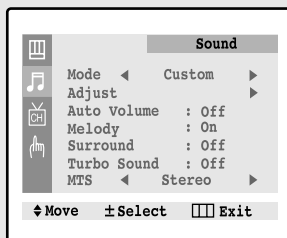

2

Press the **VOL -** or **VOL +** button repeatedly to select the “Standard”, “Music”, “Movie”, “Speech” or “Custom” sound settings.

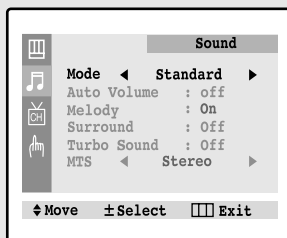

- Choose *Standard* for the standard factory settings.
- Choose *Music* when watching music videos or concerts.
- Choose *Movies* when watching movies.
- Choose *Speech* when watching a show that is mostly dialogue (i.e., news).
- Choose *Custom* to recall your personalized settings.

OPERATION

Setting The On/Off Melody

You can hear clear melody sound when the TV is powered On or Off.

1

Press the **MENU** button to display the menu.

Press the **CH ▼** button to select "Sound" menu , then press the **VOL+** button.

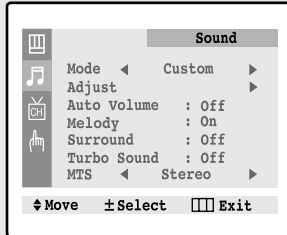

2

Press the **CH ▼** button to select "Melody", then press the **VOL+** or **VOL-** button to select the "On" or "Off".

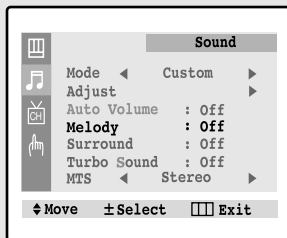

3

Press the **MENU** button twice to exit.

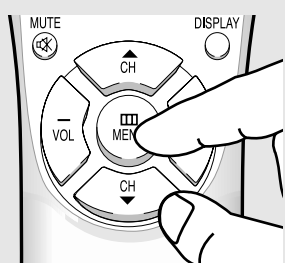

OPERATION

Viewing a VCR or Camcorder Tape

You must select the appropriate mode in order to view the VCR or Camcorder signal on the TV.

1

Press the **MENU** button to display the menu.

Press the **CH ▼** button twice to select "Channel", then press the **VOL+** button.

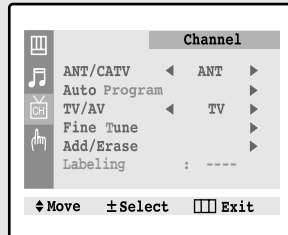

2

Press the **CH ▼** button twice to select the "TV/AV".

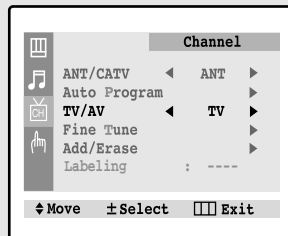

3

Press the **VOL+** or **VOL-** button .
You will switch between viewing the signals coming from equipment connected to the TV's A/V jacks, and the TV signal.

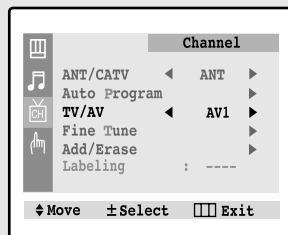

4

Press the **MENU** button twice to exit.

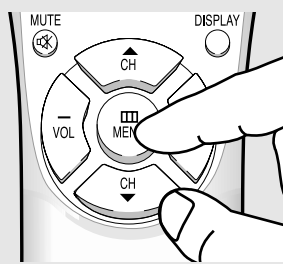

Chapter Four

SPECIAL FEATURES

Customizing Your Remote Control (TXN2734F / TXN2036F / TXN2730F / TXN2726)

Your TV comes equipped with a “universal” remote control. In addition to controlling the TV, the universal remote can also operate a VCR, DVD and a cable box (even if your VCR, DVD and cable box are made by manufacturers other than Samsung).

Setting Up Your Remote Control to Operate Your VCR or DVD

1

Turn off your VCR or DVD.

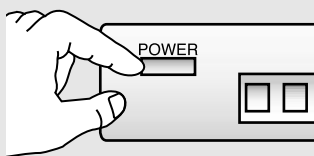

2

On your Samsung remote control, press **SET**.

3

Press the **VCR or DVD** button on the top right of your remote control.

4

Enter both digits of the VCR or DVD code listed on the next page for your brand of VCR or DVD.

5

Press the **POWER** button on the remote control. Your VCR or DVD should turn on. If your VCR or DVD turns on, your remote control is now set correctly.

6

Once your remote control is set up, press the **VCR or DVD** button any time you want to use the remote to operate your VCR or DVD.

◀ The remote control has four “modes”: “TV,” “VCR,” “DVD” and “Cable” Press the “VCR” or “DVD” button to switch the remote control to the “VCR” or “DVD” mode.

◀ Make sure you enter both digits of the code, even if the first digit is a “0.” If more than one code listed, try the first one.

◀ If your VCR or DVD does not turn on, repeat steps 2, 3, and 4, but try one of the other codes listed for the brand of your particular VCR or DVD. If no other codes are listed, try each code, 00 through 72.

◀ When your remote control is in the “VCR” or “DVD” mode, the volume buttons still control your TV’s volume.

When your remote is in the “TV” mode, the VCR control buttons (PLAY, STOP, etc.) will still operate your VCR.

SPECIAL FEATURES

VCR Codes

Admiral	15,88	Hitachi	14,24,44,45	Quasar	17,53
Aiwa	24	Instant Replay	17	Radio Shack/Realistic	11,15,17,18,21
Akai	26,31,32	JC Penney	11,14,16,17,23,25,39		24,28,36,52,62
Audio Dynamics	22,25		44,60,62	RCA	9,14,16,17,37,44,46,63,78
Bell & Howell	11	JCL	11,17,23,25,39,55	Samsung	0,16,22,31,41,51
Broksonic	19	Kenwood	11,23,25,39,55	Sansui	25
Candle	16,18,22,54,55,61	KLH	82	Sanyo	11,21
Canon	17,62	LG	1,2,7	Scott	22,50,58,77
Citizen	16,18,22,54,55,61	Lloyd	24	Sears	11,14,18,21,27,28,44,52,57
Colortyme	23	Logik	40	Sharp	15,36,48,54
Craig	16,21	LXI	24	Shintom	26,35,40,64
Curtis-Mathes	9,16,17,23,24,55	Magnavox	17,38,62,65	Signature	24
	62,73,76	Marantz	11,17,23,25,38,39,55,70	Sony	26,35,47
Daewoo	3,4,5,6,7,8,22,54,85	MTC	16,24	Sylvania	17,24,38,62,65
DB	23,25	Multitech	16,24,40,41	Symphonic	24
Dimensia	9	NEC	11,23,25,39,55,70,73	Tandy	11,24
Dynatech	24	Optimus	15	Tatung	39
Electrohome	36	Panasonic	17,62,84,86	Teac	24,39,78
Emerson	17,18,19,22,24,29,32,36,43	Pentax	14,44	Technics	17
	50,51,56,58,66,71,74,76,77,79	Pentex Reserch+	55	Teknika	17,18,24,30
Fisher	11,21,27,28,52,57,67	Philco	17,38,62,65	TMK	76
Funai	24	Philips	17	Toshiba	14,22,28,57,58
General Electric	9,16,17,41,62	Pioneer	14,25,42,59	Toshiko	18
Go Video	16	Portland	53,54,61	Totevision	16,18
Goldstar	18,23,55,69	ProScan	9		
Harman Kardon	23	Quartz	11		

DVD Codes

Philips	7	ProScan	8
Sony	4	RCA	8
Samsung	0	Toshiba	2
Panasonic	6	Sharp	5
LG	1	CurtisMathes	9
JVC	3		

SPECIAL FEATURES

Setting Up Your Remote Control to Operate Your Cable Box

1

Turn off your cable box.

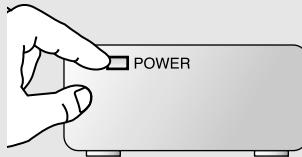

2

On your Samsung remote control, press **SET**.

3

Press the **CABLE** button on the top right of your remote control.

◀ The remote control has four “modes”: “TV,” “VCR,” “DVD” and “CABLE”.

Press the “CABLE” button to switch the remote control to the “Cable” mode.

4

Enter both digits of the cable box code listed below for your brand of cable box.

◀ Make sure you enter both digits of the code, even if the first digit is a “0.” (If more than one code listed, try the first one.)

5

Press **POWER**. Your cable box should turn on. If your cable box turns on, your remote control is now “set up” correctly.

◀ If your cable box does not turn on, repeat steps 2, 3, and 4, but try one of the other codes listed for your particular brand of cable box. (If no other codes are listed, try each cable box code, 00 through 35.)

6

Once your remote control is set up, press the **CABLE** button any time you want to use the remote to operate your cable box.

◀ When your remote control is in the “CABLE” mode, the volume buttons still control your TV’s volume. Also, the VCR control buttons (PLAY, STOP, etc.) will still operate your VCR.

Cable Box Codes

Anvision	15,16	Magnavox	15,16,27,29,34,36	Samsung	0,11,30,52,71,72
Cable Star	15,16		37,40,41,48,49	Signature	54
DaeHan	5	Nawoo	1	Spruce	35
DaeRyung	3	NSC	17	Starcom	54
Dongkuk	4	Oak	24,46	Stargate2000	66
Eagle	15,16	Osk Sigma	24	Sylvania	19,67
Eastern International	20	Panasonic	11,35,47,69	TaePyungYang	2
General Instrument	54	Philips	15,16,27,29,34,36,37	Texscan	19,67
GI	12,13,23,31,32,33,38,44,75,76,77		40,41,48,49	Tocom	25,29,57,58,63
Hamlin	11,12,20,21,42,56	Pioneer	26,28,52	Unika	39,40,49
Hitachi	45,51,54	Randtek	15,16	Universal	59,60
Jerrold	12,13,23,31,32,33,38	RCA	8,35,74	Viewstar	15,16,27,29,34,36,37
	44,54,70,73	Regal	11,20,21		40,41,48,49
LG	6	Regency	10,41	Warner Amex	52
Macom	45,51	SAEWOO	7	Zenith	22,50,65,69

Fine Tuning Channels

Use fine tuning to manually adjust a particular channel for optimal reception.

1

Select the appropriate channel.

Press the **MENU** button to display the menu.
Press the **CH ▼** button twice to select "Channel" menu, then press the **VOL+** button.

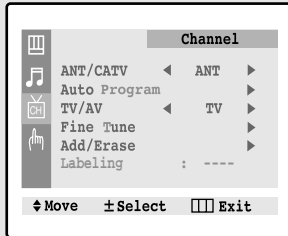

2

Press the **CH ▼** button three times to select "Fine tune", then press the **VOL+** button.

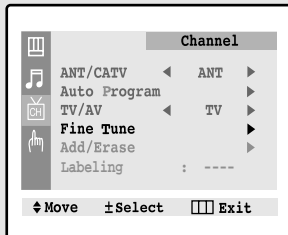

3

Press the **VOL+** and **VOL-** buttons to adjust the fine tuning.

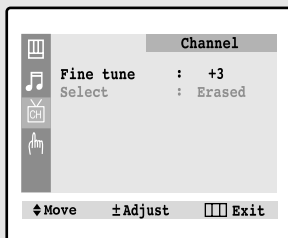

4

To store the fine tuning setting in the TV's memory, press the **CH ▼** button to select "Select". Press the **VOL+** or **VOL-** button to select "Added".

To reset the fine tuning to "0", press the **VOL+** or **VOL-** button to select "Erased".

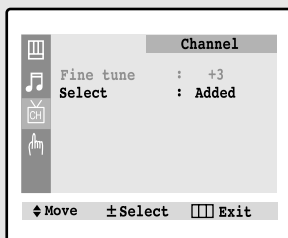

◀ Press the **MENU** button to resume normal viewing.

SPECIAL FEATURES

Changing the Screen Size

1

Press the **MENU** button to display the menu.

Press the **VOL +** button to select the "Picture" menu.

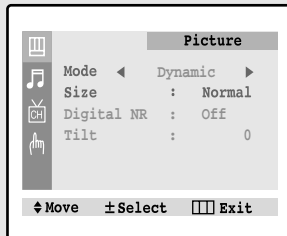

2

Press the **CH ▼** button to select "Size".

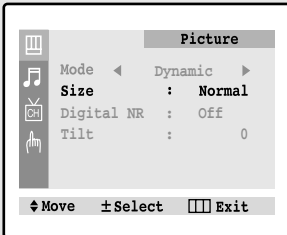

3

Press the **VOL +** or **VOL -** button repeatedly to select "Normal" or "Zoom".

Press the **MENU** button twice to exit.

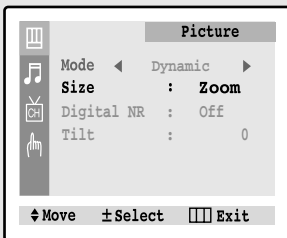

- **Normal** : Sets the picture to 4:3 normal mode. This is a standard TV screen size.
- **Zoom** : Magnifies the size of the picture on screen.

Digital Noise Reduction

If the broadcast signal received by your TV is weak, you can activate the Digital Noise Reduction feature to help reduce any static and ghosting that may appear on the screen.

1

Press the **MENU** button to display the menu.

Press the **VOL +** button to select the "Picture" menu.

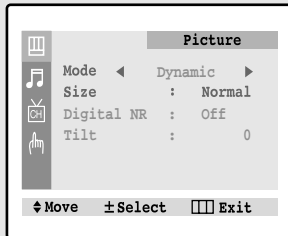

2

Press the **CH ▼** button to select "Digital NR."

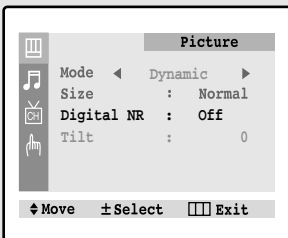

3

Press the **VOL +** or **VOL -** button to select Digital NR "On".

Press the **MENU** button to exit.

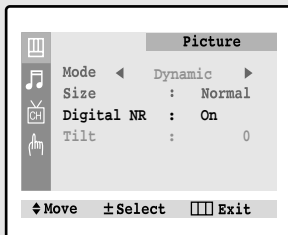

◀ Pressing the **VOL-** or **VOL+** button will alternate between "On" and "Off".

SPECIAL FEATURES

Tilt (TXN2734F / TXN2730F)

Due to the Earth's magnetic field there may be some minor image tilt depending on the TV's location. When this occurs, follow the steps below.

1

Press the **MENU** button to display the menu.

Press the **VOL +** button to select the "Picture" menu.

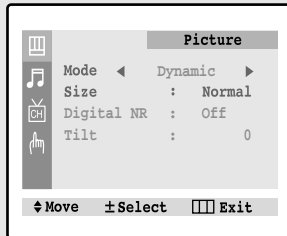

2

Press the **CH ▼** button to select "Tilt".

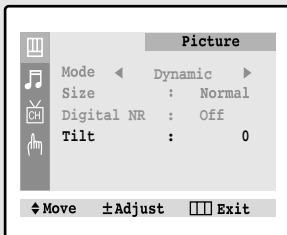

3

press the **VOL-** or **VOL+** buttons to adjust the Tilt.

Press the **MENU** button to exit.

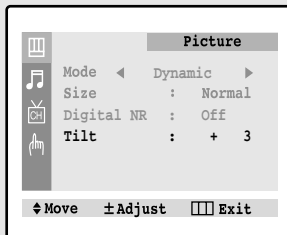

Using the Surf Feature

This feature allows you to set the TV to return to a particular channel after a certain amount of time. For example, you may be watching a channel when commercials start. You can set the Surf to “5 minutes”, then switch channels. After 5 minutes, the TV will return to the original channel. To use the Surf:

1

While you are watching the channel to which you want to return, press the **R.SURF** button. The on-screen display will read “Surf off”.

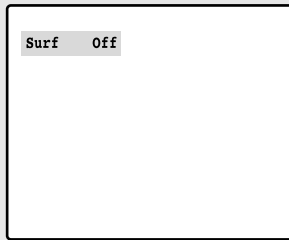

2

Press the **R.SURF** button again to set the timer in thirty second intervals, up to five minutes.

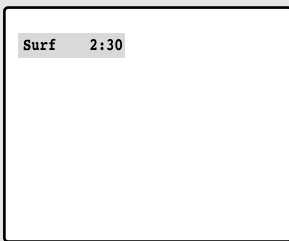

3

The time you set will begin counting down on the screen. When the time runs out, the TV will return to the channel you were watching when you set the timer.

Setting the On/Off Timer

1

Press the **MENU** button to display the menu.

Press the **CH ▼** button three times to select "Function" menu, then press the **VOL+** button.

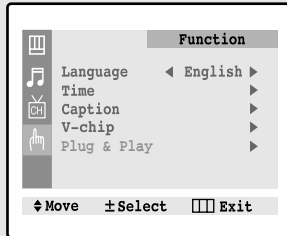

◀ Before using the timer, you must set the TV's clock. (See "Setting the Clock" on page 3.10).

2

Press the **CH ▼** button to select "Time", then press the **VOL+** button.

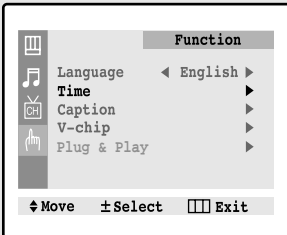

3

Press the **CH ▼** button to select "On time".

Press the **VOL+** button to select the "On time" hours. (The hours digits will be highlighted.)

Press the **CH ▲** or **CH ▼** button repeatedly to select the appropriate hours (i.e., the hour when the TV will turn on.)

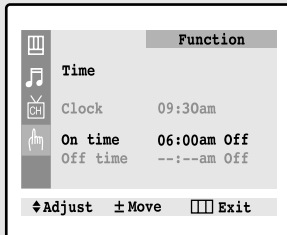

◀ When you set the hours, make sure the correct time of day (AM or PM) appears to the right of the hour.

4

Press **VOL+** to select the "On time" minutes. (The minutes digits will be highlighted.)

Press **CH ▲** or **CH ▼** to select the appropriate minutes.

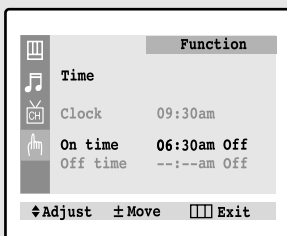

SPECIAL FEATURES

5

Press the **VOL +** button to select "On/Off."

Press the **CH ▲** (or **CH ▼**) button to turn the on-timer "On." (Repeatedly pressing the **CH ▲** or **CH ▼** button will alternate between on and off.)

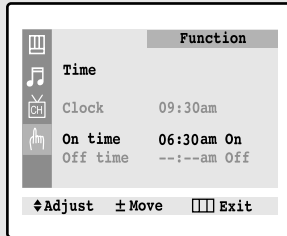

◀ To deactivate the "On time," select "Off" during this step.

6

When finished, press the **VOL +** button.

7

To set the Off time, press the **CH ▼** button to select "Off time."

Press the **VOL +** button and set the hours and minutes. (Follow the same procedure as in steps 1~6 above.)

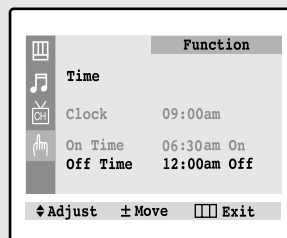

◀ If no function buttons (including remote control buttons or front panel buttons) are operated for three hours after the TV is turned on by "On time", the TV will automatically turn off.

8

When finished setting the timer, press the **MENU** button three times to exit.

Setting the Sleep Timer

The sleep timer automatically shuts off the TV after a preset time (from 10 to 180 minutes).

1

Press the **SLEEP** button on the remote control.

2

Press the **SLEEP** button repeatedly until the appropriate time interval appears (any of the preset values from "Off" to "180").

◀ After about 5 seconds, the sleep display will disappear from the screen, and the time interval will be set.

Sound Features

Choosing a Multi-Channel Sound (MTS) Soundtrack

Depending on the particular program being broadcast, you can listen to stereo, mono, or a Separate Audio Program. (SAP audio is usually a foreign-language translation. Sometimes SAP has unrelated information like news or weather.)

1

Press the **MENU** button to display the menu.

Press the **CH▼** button to select the "Sound" menu, then press the **VOL+** button.

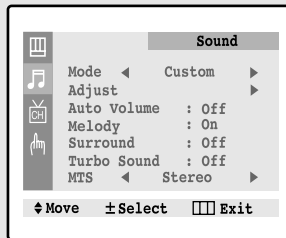

2

Press the **CH▼** button six times to select "MTS".

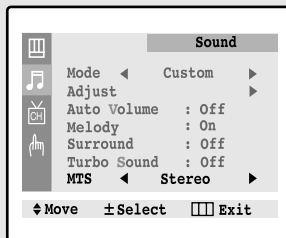

3

Press the **VOL +** or **VOL -** button to select "Mono," "SAP," or "Stereo."

Press the **MENU** button twice to exit

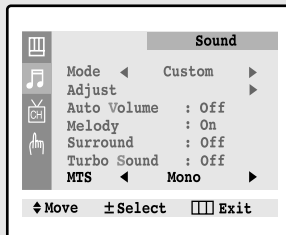

◀ The text at the bottom of the menu tells you if the incoming audio is stereo, SAP, or mono.

- Choose *Stereo* for channels that are broadcasting in stereo.
- Choose *Mono* for channels that are broadcasting in mono, or if you are having difficulty receiving a stereo signal.
- Choose *SAP* to listen to the Separate Audio Program, which is usually a foreign-language translation.

You can also change the MTS setting by pressing the "MTS" button on the remote control. (When you change channels, MTS is set to "Stereo" automatically. To listen in 'SAP' or 'Mono,' change the MTS setting.)

SPECIAL FEATURES

Extra sound settings (Turbo Sound, Surround, or Auto Volume)

• Turbo Sound

Turbo sound suitably emphasizes both higher and lower bands of sound (and includes other effects).

• Surround

“Surround” converts a monaural sound signal into two identical left and right channels. Once the “Surround” is set to “On” or “Off”, the setting applies to the sound effects such as Standard, Music, Movie and Speech.

• Auto Volume

Each broadcasting station has its own signal conditions, and so it is not easy for you to adjust the volume every time the channel is changed. “Auto volume” lets you automatically adjust the volume of the desired channel by lowering the sound output when the modulation signal is high or by raising the sound output when the modulation signal is low.

1

Press the **MENU** button to display the menu.

Press the **CH▼** button to select the “Sound” menu, then press the **VOL +** button.

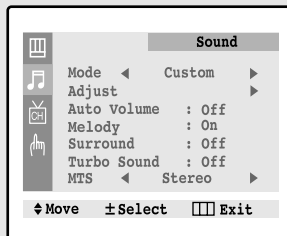

2

Press the **CH▼** button five times to select “Turbo sound”.

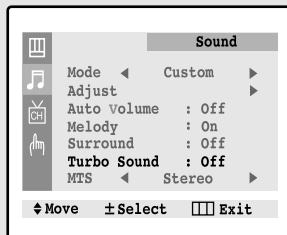

3

Press the **VOL +** button to select “On”.

Press the **MENU** button twice to exit

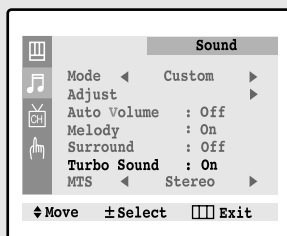

You can set Surround and Auto volume the same way as setting Turbo sound.

Viewing Closed Captions

Your TV decodes and displays the closed captions that are broadcast with certain TV shows. These captions are usually subtitles for the hearing impaired or foreign-language translations. All VCRs record the closed caption signal from television programs, so home-recorded video tapes also provide closed captions. Most pre-recorded commercial video tapes provide closed captions as well. Check for the closed caption symbol in your television schedule and on the tape's packaging: .

1

Press the **MENU** button to display the menu.

Press the **CH ▼** button three times to select the "Function" menu.

Press the **VOL+** button.

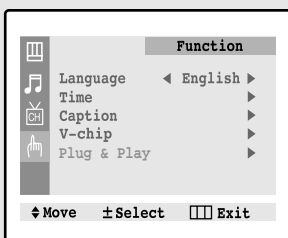

2

Press the **CH ▼** button twice to select the "Caption" menu, then press the **VOL+** button.

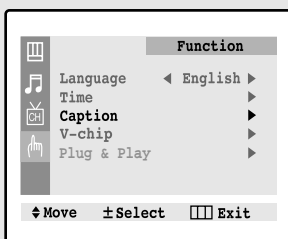

3

Press the **VOL+** or **VOL -** button to turn closed captioning on/off.

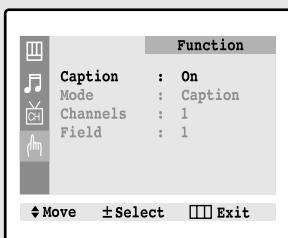

4

Press the **CH ▼** button to select "Mode".

Press the **VOL -** or **VOL +** button to select "Caption" or "Text".

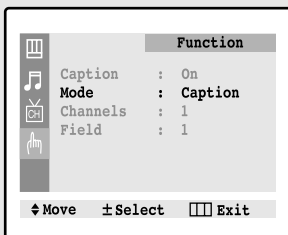

5

Depending on the particular broadcast, it might be necessary to make changes to "Channels" and "Field": Use the **CH ▲**, **CH ▼**, **VOL +** and **VOL -** buttons to make the changes. (Follow the same procedure as in steps 3-4 above.) Press the **MENU** button three times to exit.

◀ Misspellings and unusual characters sometimes occur during closed caption transmissions, especially those of live events. There may be a small delay before captions appear when you change channels. These are not malfunctions of the TV.

◀ In caption mode, captions appear at the bottom of the screen, and they usually cover only a small portion of the picture.

In text mode, information unrelated to the program, such as news or weather, is displayed. Text often covers a large portion of the screen.

◀ Different channels and fields display different information: Field 2 carries additional information that supplements the information in Field 1. (For example, Channel 1 may have subtitles in English, while Channel 2 has subtitles in Spanish.)

SPECIAL FEATURES

Using the V-Chip

The V-Chip feature automatically locks out programming that is deemed inappropriate for children. The user must first enter a PIN (personal ID number) before any of the V-Chip restrictions can be set up or changed.

Note : When the V-chip feature is active, channel-auto program features do not function.

Setting Up Your Personal ID Number (PIN)

1

Press the **MENU** button to display the menu.

Press the **CH ▼** button three times to select the "Function" menu.

Press the **VOL+** button.

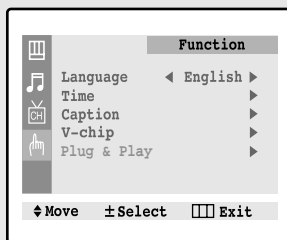

2

Press the **CH ▼** button three times to select the "V-chip" menu.

Press the **VOL+** button.

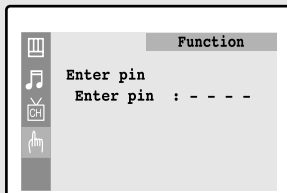

The "Enter pin" screen will appear. Enter your 4-digit PIN number. Note: The default PIN number for a new TV set is "0-0-0-0."

3

After entering a valid PIN number, the "V-chip" screen will appear. Press the **CH ▼** button three times and highlight "Change pin."

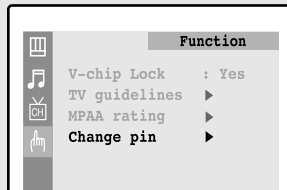

4

While the "Change pin" field is selected, press the **VOL+** button. The Change pin screen will appear. Choose any 4-digits for your PIN and enter them.

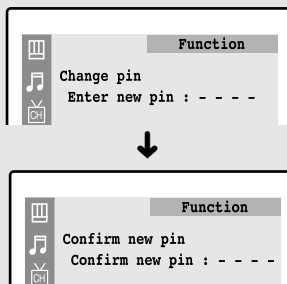

As soon as the 4 digits are entered, the "Confirm new pin" screen appears. Re-enter the same 4 digits. When the Confirm screen disappears, your PIN has been memorized. Press the **MENU** button three times to exit.

◀ Note: If you forget the PIN, press the remote-control keys in the following sequence, which resets the pin to 0-0-0-0:

POWER OFF → MUTE → 8 → 2 → 4 → POWER ON.

SPECIAL FEATURES

How to Enable/Disable the V-Chip

1

Press the **MENU** button to display the menu.

Press the **CH ▼** button three times to select the "Function" menu.

Press the **VOL+** button.

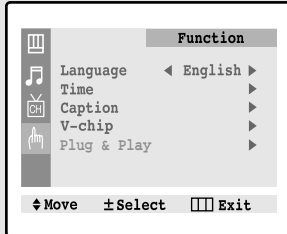

2

Press the **CH ▼** button three times to select the "V-chip" menu.

Press the **VOL+** button.

The "Enter pin" screen will appear. Enter your 4-digit PIN number.

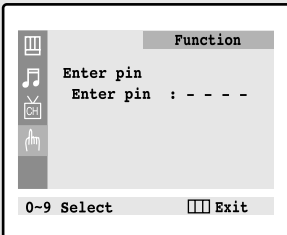

3

The "V-Chip" screen will appear, and "V-Chip lock" will be selected (turns blue color).

To enable the V-Chip feature, press the **VOL+** button so that the "V-Chip lock" field is Yes. (Pressing **VOL+** will alternate between Yes and No.)

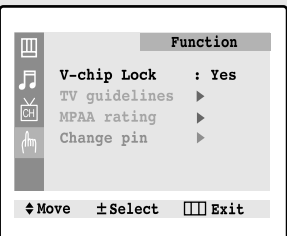

How to Set up Restrictions Using the "TV guidelines"

First, set up a personal identification number (PIN), and enable the V-Chip. (See previous section.) Parental restrictions can be set up using either of two methods: The TV guidelines or the MPAA rating.

1

Press the **MENU** button to display the menu.

Press the **CH ▼** button three times to select the "Function" menu.

Press the **VOL+** button.

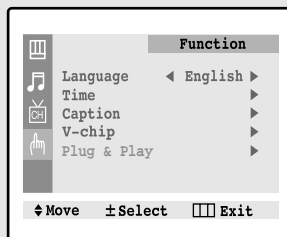

SPECIAL FEATURES

2

Press the **CH ▼** button three times to select the "V-chip" menu.

Press the **VOL+** button.

The "Enter pin" screen will appear. Enter your 4-digit PIN number.

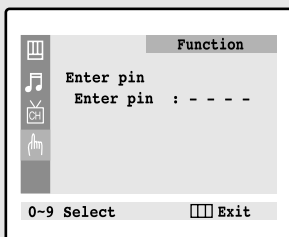

3

The "V-chip" screen will appear. Press the **CH ▼** button, and highlight the field for "TV guidelines".

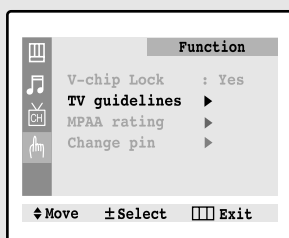

4

Press the **VOL +** button. The "TV guidelines" screen will appear. Press the **CH ▲** or **CH ▼** button to highlight one of the six age-based categories:

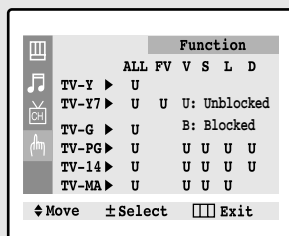

TV-Y Young children
TV-Y7 Children 7 and over

TV-G General audience
TV-PG Parental guidance
TV-14 Viewers 14 and over
TV-MA Mature audience

◀ Note: These categories consist of two separate groups: TV-Y and TV-Y7 (young children through age 7), and TV-G through TV-MA (everybody else).

The restrictions for these two groups work independently: If a household includes very young children as well as young adults, the TV guidelines must be set up separately for each age group. (See next step.)

5

At this point, one of the TV-Ratings is highlighted.

Press the **VOL +** button: Depending on your existing setup, a letter "U" or "B" will start blinking. (U= Unblocked, B= Blocked)

While the "U" or "B" is red, press the **CH ▲** or **CH ▼** button to block or unblock the category.

Press the **MENU** button once to save the TV guidelines. A TV-Rating will be highlighted, and no letters will blink. To exit this screen, press **MENU** again. To select a different TV-Rating, press the **CH ▲** or **CH ▼** button and then repeat the process.

Note 1: The TV-Y7, TV-PG, TV-14 and TV-MA have additional options. See the next step to change any of the following sub-ratings:

FV: Fantasy violence
D: Dialog
L: Offensive language
S: Sexual situation
V: Violence

Note 2: The V-Chip will automatically block certain categories that are "more restrictive." For example, if you block "TV-Y" category, then "TV-Y7" will automatically be blocked. Similarly, if you block the TV-G category, then all the categories in the "young adult" group will be blocked (TV-G, TV-PG, TV-14 and TV-MA). The sub-ratings (D, L, S, V) work together similarly. (See next section.)

SPECIAL FEATURES

6

How to set the FV, V, S, L and D sub-ratings:

First, highlight one of these TV-Ratings: TV-Y7, TV-PG, TV-14 or TV-MA (See Step 4, on previous page).

Next, while the TV-Rating is highlighted, repeatedly press the **VOL +** button. This will cycle through the available sub-ratings (FV, L, S, D or V).

A blinking letter ("U" or "B") will be displayed for each sub-rating. While the "U" or "B" is blinking, press the **CH ▲** or **CH ▼** button to change the sub-rating.

Press **MENU** once to save the TV guidelines. A TV-Rating will be highlighted, and no letters will blink. To exit this screen, press **MENU** again. To select a different TV-Rating, press the **CH ▲** or **CH ▼** button and then repeat the process.

Note: The V-chip will automatically block certain categories that are "More restrictive". For example, if you block "L" sub-rating in TV-PG, then the "L" sub-ratings in TV-14 and TV-MA will automatically be blocked.

7

Press the **MENU** button three times to clear all the screens (Or proceed to the next section, and set up additional restrictions based on the MPAA codes).

How to Set up Restrictions Using the MPAA Ratings: G, PG, PG-13, R, NC-17, X

The MPAA rating system uses the Motion Picture Association of America (MPAA) system, and its main application is for movies. (Eventually, movie videocassettes will be encoded with MPAA ratings.) When the V-Chip lock is on, the TV will automatically block any programs that are coded with objectionable ratings (either MPAA or TV-Ratings).

1

Press the **MENU** button to display the menu.

Press the **CH ▼** button three times to select the "Function" menu.

Press the **VOL+** button.

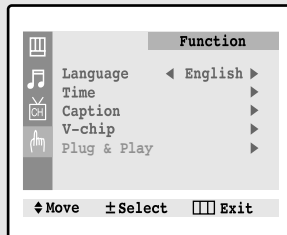

2

Press the **CH ▼** button three times to select the "V-chip" menu.

Press the **VOL+** button.

The "Enter pin" screen will appear. Enter your 4-digit PIN number.

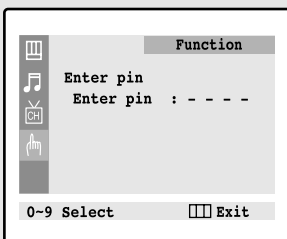

SPECIAL FEATURES

3

The "V-chip" screen will appear. Press the **CH ▼** button twice, and select "MPAA rating".

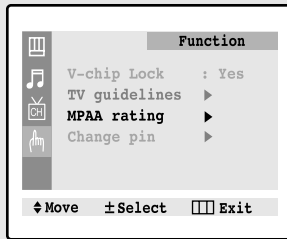

4

While "MPAA rating" is selected, press the **VOL +** button. The "MPAA rating" screen will appear.

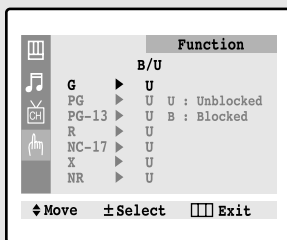

5

Repeatedly press the **CH ▼** button to select a particular MPAA category. Pressing the **CH ▼** button will cycle through the MPAA categories:

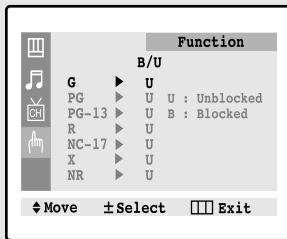

G	General audience (no restrictions).
PG	Parental guidance suggested.
PG-13	PG-13 (Parents strongly cautioned).
R	R (Restricted. Children under 17 should be accompanied by an adult).
NC-17	No children under age 17.
X	X (Adults only).
NR	Not rated.

While a particular category is selected, press **VOL +** to activate it. A letter ("U" or "B") will be displayed. Press **CH ▲** or **CH ▼** to select "U" or "B".

Press **MENU** four times to save the settings and to clear all screens.

Note: The V-Chip will automatically block any category that is "more restrictive." For example, if you block the "PG-13" category, then "R," "NC-17," and "X" will automatically be blocked also.

How to Reset the TV after the V-Chip Blocks a Channel ("Emergency Escape")

If the TV is tuned to a restricted channel, the V-Chip will block it. The screen will go blank and the following message will appear: "Excessive rating".

To resume normal viewing, tune to a different channel using the number buttons. Under certain conditions (depending on the rating of the local TV programs) the V-Chip might lock out all the channels. In this case, use the V-Chip function for an "emergency escape":

Press the **MENU** button to display the menu. Press the **CH ▼** button three times to select the "Function" menu and press the **VOL +** button.

Press the **CH ▼** button three times to highlight the "V-chip" menu and press the **VOL +** button.

Enter your PIN number, and press the **VOL +** button to temporarily disable the V-Chip Lock.

Chapter Five

TROUBLESHOOTING

If the TV seems to have a problem, first try this list of possible problems and solutions. If none of these troubleshooting tips apply, then call your nearest service center.

Identifying Problems

Problem	Possible Solution
Poor picture	Try another channel. Adjust the antenna. Check all wire connections.
Poor sound quality.	Try another channel. Adjust the antenna.
No picture or sound.	Try another channel. Press the TV/VIDEO button. Make sure the TV is plugged in. Check the antenna connections.
No color, wrong colors or tints.	Make sure the program is broadcast in color. Adjust the picture settings. If the set is moved or turned in a different direction, the power should be OFF for at least 30 minutes.
Picture rolls vertically.	Adjust the antenna. Check all wire connections.
The TV operates erratically	Unplug the TV for 30 seconds, then try operating it again.
The TV won't turn on.	Make sure the wall outlet is working.

APPENDIX

Cleaning and Maintaining Your TV

With proper care, your TV unit will give you many years of service. Please follow these guidelines to get the maximum performance from your TV.

Placement

- Do not place the TV near extremely hot, cold, humid or dusty places.
- Do not place the TV near appliances with electric motors that create magnetic fields, such as vacuum cleaners.
- Keep the ventilation openings clear; do not place the TV on a soft surface, such as cloth or paper.
- Place the TV in a vertical position only.

Liquids

- Do not handle liquids near or on the TV. Liquids that spill into it can cause serious damage.

Cabinet

- Never open the cabinet or touch the parts inside.
- Wipe your TV with a clean, dry cloth. Never use water, cleaning fluids, wax, or chemicals.
- Do not put heavy objects on top of the cabinet.

Temperature

- If your TV is suddenly moved from a cold to a warm place, unplug the power cord, and allow at least two hours for moisture that may have formed inside the unit to dry completely.

Using Your TV in Another Country

If you plan to take your TV with you to a foreign country, please be aware of the different television systems that are in use around the world. A TV designed for one system may not work properly with another system due to differences in the TV channel frequencies.

Specifications

Model	TXN2734F / TXN2434F / TXN2034F / TXN2036F / TXN2730F TXN2030F / TXN2726
Voltage	AC 120V
Frequency of Operation	60Hz
Dimensions (mm/inches)	TXN2734F: 730 x 485 x 575 mm / 28.74 x 19.09 x 22.64 inches TXN2434F: 656 x 459 x 511 mm / 25.82 x 18.07 x 20.11 inches TXN2034F: 582 x 481 x 456 mm / 22.91 x 18.93 x 17.95 inches TXN2036F: 658 x 487 x 472 mm / 25.9 x 19.17 x 18.58 inches TXN2730F: 760 x 493 x 588 mm / 29.9 x 19.4 x 23.14 inches TXN2030F: 578 x 488 x 464 mm / 22.75 x 19.21 x 18.26 inches TXN2726: 740 x 519 x 589 mm / 29.13 x 20.43 x 23.18 inches
Weight (Kg/ lbs)	TXN2734F: 43.5 Kg / 95.9 lbs TXN2434F: 31 Kg / 68.34 lbs TXN2034F: 24 Kg / 52.9 lbs TXN2036F: 25.5 Kg / 56.16 lbs TXN2730F: 43.7 Kg / 96.25 lbs TXN2030F: 23.9 Kg / 52.64 lbs TXN2726: 35.9 Kg / 79.07 lbs

Free Manuals Download Website

<http://myh66.com>

<http://usermanuals.us>

<http://www.somanuals.com>

<http://www.4manuals.cc>

<http://www.manual-lib.com>

<http://www.404manual.com>

<http://www.luxmanual.com>

<http://aubethermostatmanual.com>

Golf course search by state

<http://golfingnear.com>

Email search by domain

<http://emailbydomain.com>

Auto manuals search

<http://auto.somanuals.com>

TV manuals search

<http://tv.somanuals.com>