

SAMSUNG TECHWIN

SAMSUNG

SALES NETWORK

• **SAMSUNG TECHWIN CO., LTD.**

145-3, Sangdaewon 1-dong, Jungwon-gu, Seongnam-si,
Gyeonggi-do 462-703, Korea
TEL : +82-31-740-8137-8139 FAX : +82-31-740-8145

• **SAMSUNG OPTO-ELECTRONICS UK, LTD.**

Samsung House, 1000 Hillswood Drive, Hillswood Business
Park Chertsey, Surrey KT16 OPS
TEL : +44-1932-45-5308 FAX : +44-1932-45-5325

• **TIANJIN SAMSUNG OPTO-ELECTRONICS CO., LTD.**

7 Pingchang Rd, Nankai Dist. Tianjin 300190, P.R China
TEL : +86-22-2761-4724(33821) FAX : +86-22-2761-6514

P/No. : Z6806-0750-01B

www.samsungtechwin.com
www.samsungcctv.com

Download from www.Softmanuals.com. All Manuals Search And Download.

SAMSUNG

High Strength
10X Zoom



High-Resolution 10X Vandal-Proof Dome Camera SVD-4300 User's Manual

Thank you for purchasing a SAMSUNG CCD CAMERA.
Before attempting to connect or operate this product,
please read these instructions carefully and save this manual for future use.

ENGLISH

Before operating the camera, confirm the camera model and proper input power voltage. In order to that you can understand this manual thoroughly, we'll introduce our model description.

■ **SVD-4300 SERIES**

- NTSC MODEL •PAL MODEL
- SVD-4300N SVD-4300P

■ **MODEL DESCRIPTION**

- SVD-4300X
└── SIGNAL SYSTEM

- SIGNAL SYSTEM
N → NTSC MODEL
P → PAL MODEL

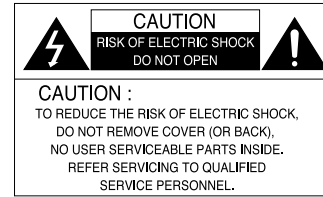

The lightning flash with an arrowhead symbol, within an equilateral triangle is intended to alert the user to the presence of uninsulated "dangerous voltage" within the product's enclosure that may be of sufficient magnitude to constitute a risk of electric shock to persons.



The exclamation point within an equilateral triangle is intended to alert the user to the presence of important operating and maintenance (servicing) instructions in the literature accompanying the appliance.

INFORMATION - This equipment has been tested and found to comply with limits for a Class A digital device, pursuant to part 15 of the FCC Rules. These limits are designed to provide reasonable protection against harmful interference when the equipment is operated in a commercial environment. This equipment generates, uses, and can radiate radio frequency energy and, if not installed and used in accordance with the instruction manual, may cause harmful interference to radio communications.

Operation of this equipment in a residential area is likely to cause harmful interference in which case the user will be required to correct the interference at his own expense.

WARNING - Changes or modifications not expressly approved by the manufacturer could void the user's authority to operate the equipment.

WARNING - To prevent electric shock and risk of fire hazards:

- ◆ Do NOT use power sources other than that specified.
- ◆ Do NOT expose this appliance to rain or moisture.

This installation should be made by a qualified service person and should conform to all local codes.

Features

A/F 10x Optical Zoom

The built-in SVD-4300 optical zoom lens is a highly durable component. It features auto focus, auto iris, and zoom functions.

SSNR (Samsung Super Noise Reduction)

By using built-in SSNR function manufactured by SAMSUNG TECHWIN, the amount of low illumination noise has been significantly reduced, and the signal-to-noise ratio (S/N) as well as horizontal resolution have been improved, resulting in a clear and sharp image display even in the dark.

High Sensitivity

The built-in high sensitivity COLOR CCD enables a clear image even in 0.005Lux (Sens-up, color) or lower illumination.

High Resolution

Featuring 500TV line horizontal resolution in color mode and 570TV line horizontal resolution in BW mode, the camera features Sony's 410,000 pixel CCD and captures clean, noiseless, high-quality images.

Day & Night

The camera automatically determines whether it is night time or day time, selecting operating mode automatically. The camera operates in color mode during day light conditions and BW mode in night conditions for clearer identification.

IP66 Approved / Dust and Rain Resistant

With dust and rain resistant design, the camera can be installed outside under building eaves or places that are exposed to the dust and rain.

RS-485 Function

The camera, using a RS-485 communication can remote control relate to ZOOM/FOCUS and OSD menu functions.

Sub Monitor Function

The sub monitor function enables easy adjustment of the camera angle within the monitoring range during its installation.

3-Axis camera mechanism

The SVD-4300 is especially incredibly flexible to install with its 3-axis camera construction, which makes the camera wall or slope mountable.

Miscellaneous Functions

Other miscellaneous functions of the camera include privacy zone masking, digital zoom, line lock synchronization(INT/LL), freeze, horizontal inversion, and user-configured presets.



Samsung Techwin cares for the environment at all product manufacturing stages to preserve the environment, and is taking a number of steps to provide customers with more environment-friendly products. The Eco mark represents Samsung Techwin's will to create environment-friendly products, and indicates that the product satisfies the EU RoHS Directive.

Warnings & Cautions

This information is provided to ensure your safety and to prevent any losses, financial or otherwise. Please read it carefully and use the product accordingly.

Warning/Attention/Special Mark Messages



Ignoring this information may result in material loss and/or serious personal injuries including death.



Indicates "Never Allowed."



Indicates "No Disassembling."



Indicates "Must Observe."



Correct Disposal of This Product (Waste Electrical & Electronic Equipment)

(Applicable in the European Union and other European countries with separate collection systems)

This marking shown on the product or its literature, indicates that it should not be disposed with other household wastes at the end of its working life. To prevent possible harm to the environment or human health from uncontrolled waste disposal, please separate this from other types of wastes and recycle it responsibly to promote the sustainable reuse of material resources.

Household users should contact either the retailer where they purchased this product, or their local government office, for details of where and how they can take this item for environmentally safe recycling.

Business users should contact their supplier and check the terms and conditions of the purchase contract. This product should not be mixed with other commercial wastes for disposal.

Contents

Precautions	8	• CAM TITLE	18
Components and Accessories	10	• WHITE BALANCE	21
Overview	11	• BACKLIGHT	22
Connection	13	• MOTION DETECTION	23
■ Connecting To Monitor	13	• FOCUS	24
■ Connecting To Power	14	• EXPOSURE	28
■ RS-485 communication control	15	• SPECIAL	33
Operating Your Camera	16	• RESET	38
■ Menu Configuration	16	• EXIT	38
■ Menu Setup	17	Troubleshooting	39
		Specification	40
		Dimension	42



Precautions

Do not install the camera in extreme temperature conditions.



Only use the camera under conditions where temperatures are between -10°C and $+50^{\circ}\text{C}$. Be especially careful to provide ventilation when operating under high temperatures.

Do not install or use the camera in an environment where the humidity is high.



It can cause the image quality to be poor.

Do not drop the camera or subject them to physical shocks.



It can cause malfunctions to occur.

Never keep the camera face to strong light directly.

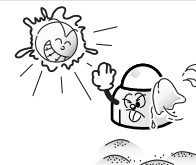

It can damage the CCD.

Do not install the camera under unstable lighting conditions.



Severe lighting change or flicker can cause the camera to work improperly.

Do not touch the front lens of the camera.



It is one of the most important parts of the camera. Be careful not to be stained by fingerprint.

Do not expose the camera to radioactivity.



If it is exposed to radioactivity, For heated CCD, it will be out of order.



Notes

- If the camera is exposed to spotlight or object reflecting strong light, smear or blooming may occur.
- Please check that the power satisfies the normal specification before connecting the camera.

Components and Accessories

1. SVD-4300

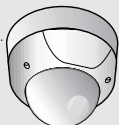

2. Instruction Manual



3. Quick Install Guide



4. Wrench



5. Ø5 Tapping Screws 4EA



6. Template



7. Installation Video Output Cable



Overview

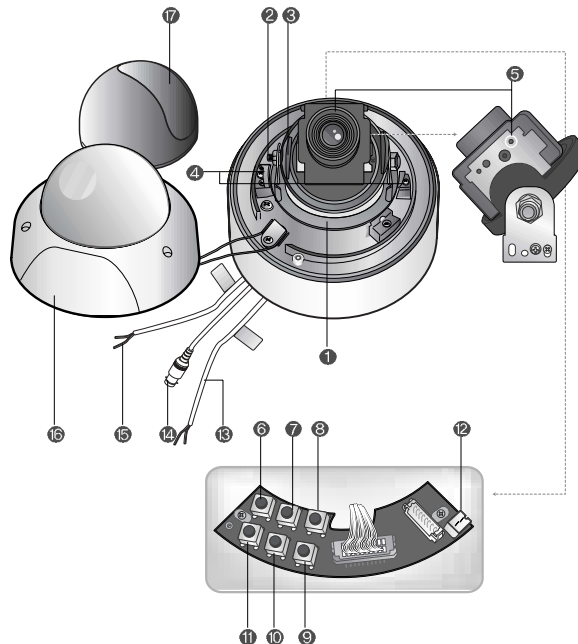

Overview

- ① **Pan Base**
control panning angle of camera
- ② **Rotate Base Holding Screw**
fix rotated position
- ③ **Rotate Base**
control rotating angle of camera
- ④ **Pan Base Holding Screws (Color : Silver)**
fix panned position
- ⑤ **Auto Focus 10x Zoom Lens Module.**
- ⑥ **SET button**
To access the main setup menu. Pressing the "SET" button locks the zoom control functions of these buttons and prompts the main setup menu.
- ⑦ **AF button**
To activate auto focus just once.
- ⑧ **UP (WIDE button)**
To move the arrow indicator to up.(To widen the view : ZOOM OUT)
- ⑨ **DOWN(TELE button)**
To move the arrow indicator to down (To close in on a far object: ZOOM IN)
- ⑩ **LEFT (F-NEAR button)**
To move the arrow indicator to left. (To see a near object clearly)
- ⑪ **RIGHT (F-FAR button)**
To move the arrow indicator to right. (To see a far object clearly)
- ⑫ **Video Output Terminal to Monitor**
- ⑬ **Power Input Jack**
- ⑭ **Video Output Jack**
- ⑮ **RS-485 Control Cable**
The detailed description refers to p15
- ⑯ **Dome Cover**
- ⑰ **Shield Case**

Notes

- The zoom position is saved after 5 seconds when you set zoom function.

Connection

Connecting to Monitor

Connect the VIDEO-OUT jack to the VIDEO-IN jack of monitor.

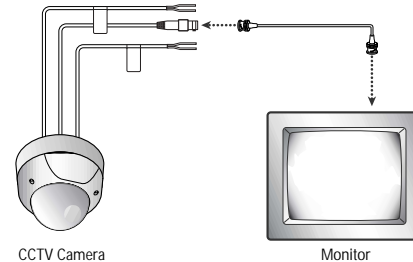

- As the connecting method varies with the instruments, refer to the manual supplied with the instrument.
- If necessary, you can connect the monitor to the REMOTE jack on the back of your camera.
- Only connect the cable when the power is turned off.
- Set the 75Ω / Hi-Z selection switch as shown below if you have an intermediate device.

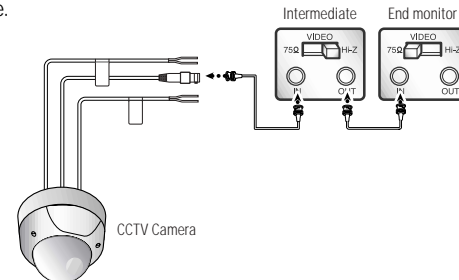

Connection

Connecting to Power

Use AC 24V / 300mA or DC 12V / 500mA power source.

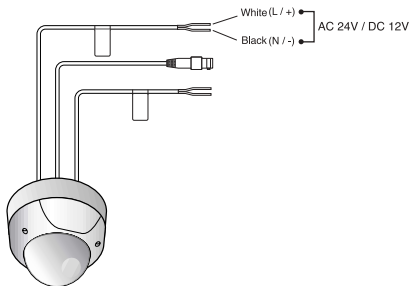

For DC Power Type

- For DC power as the voltage drop according to the length of the cable in the above table, a camera may malfunction if there is an excessively long cable run.

Resistance of copper wire [at 20°C (68°F)]

Copper wire size (AWG)	#24 (0.22mm ²)	#22 (0.33mm ²)	#20 (0.52mm ²)	#18 (0.83mm ²)
Resistance (Ω / m)	0.078	0.050	0.030	0.018
Voltage Drop (V/m)	0.028	0.018	0.011	0.006

* Voltage for camera operation: 12V DC ±10%

* Voltage drops in the above table are variable according to types of cable manufacturer.

Notes

- Be sure to connect power only after all the installation is complete.
- Note that AC or DC adaptor is not supplied with camera.
- Use the UL listed, class 2 power transformer of AC 24V adaptor.
- Ground should be connected to the GND terminal.

RS-485 communication control

Connecting to RS-485 Control Cable

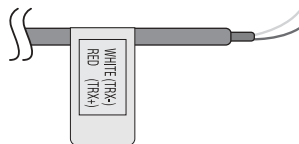

CONTROL CABLE	SPEC
RED (TRX+)	RS-485 +
WHITE (TRX-)	RS-485 -

Using a RS-485 communication, it will be able to control the ZOOM/FOCUS and OSD menu at the SAMSUNG TECHWIN System Controller or DVR.

- (1) The case which it controls from the PC

Using a RS-485 converter, It connects to RS-485 control cable outside camera and serial cable

EX) SERIAL PORT OF THE PC(COM1) — SERIAL CABLE -- RS-485 CONVERTER
-- RS-485 CONTROL CABLE

- (2) The case which it controls from the DVR or System Controller

It connects the RS-485 control cable in the connection terminal of 485 control boards which are connected with the DVR or System Controller.

485 CONTROL BOARD CONNECTION TERMINAL	RS-485 CONTROL CABLE
(+)CONNECTION TERMINAL	RED (TRX+)
(-)CONNECTION TERMINAL	WHITE (TRX-)

Notes

- When you construct external control systems for a camera control, please use to the SAMSUNG TECHWIN PROTOCOL or PELCO-D PROTOCOL.
- When you connecting to RS-485 control cable, please peel off the outer skin inside the RS-485 control cable.

Operating Your Camera

Menu Configuration

MAIN SETUP MENU			
CAM TITLE	• OFF	• ON	
WHITE BALANCE	• ATW(OUTDOOR)	• AWC → SET	• MANUAL
BACKLIGHT	• OFF	• LOW	• MIDDLE
	• HIGH		
MOTION DET	• OFF	• ON	
FOCUS	• MODE	• ZOOM TRK	
	• ZOOM SPEED	• D-ZOOM	
	• DISP ZOOM MAG	• ZOOM POS INIT	
	• LENS INIT	• END	
EXPOSURE	• BRIGHTNESS	• IRIS	• SHUTTER
	• AGC	• SSNR	• SENS-UP
	• END		
SPECIAL	• USER PRESET	• PRIVACY	• DAY/NIGHT
	• SYNC	• COMM ADJ	• IMAGE ADJ
	• END		
RESET			
EXIT			

Menu Setup

Use the six buttons on back of the camera.

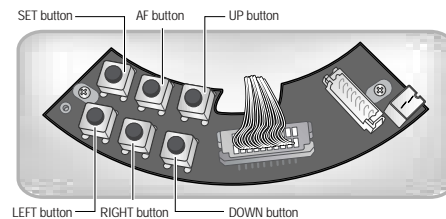

1. Press the SET button to access the main setup mode.
 - Main setup menu is displayed on the monitor screen.

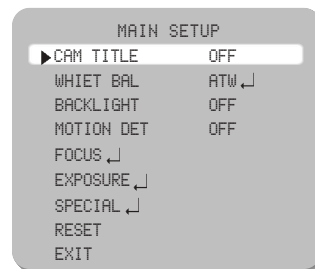

2. Select the desired feature using the UP or DOWN button.
 - Each pressing of the UP or DOWN button moves the indicator to the next or previous feature.
 - Move the arrow indicator to the desired feature item.

Operating Your Camera

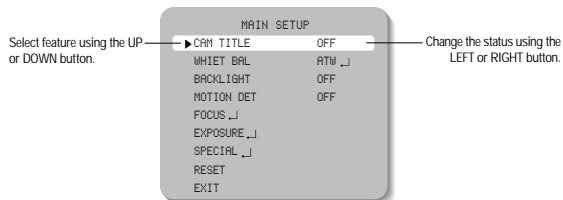

3. Change the status of the selected feature using the LEFT or RIGHT button.
4. When completed, move the arrow indicator to 'EXIT' and press the SET button.

Notes

- Features marked with a ↵ have an accessible submenu.
- Access the submenu by pressing the SET button.

CAM TITLE

Use this feature to designate a name for the camera, which will display on the monitor screen.

1. Press the SET button to display the main setup menu and move the arrow indicator to 'CAM TITLE' using the UP or DOWN button.
2. Set 'CAM TITLE' to 'ON' using the LEFT or RIGHT button.

Notes

- If the CAM TITLE feature is set to 'OFF', the name will not be displayed in the monitor.

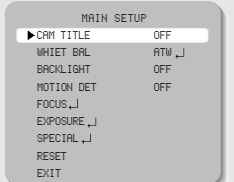

3. Press SET button.



4. You can enter up to 15 characters.

- ➊ Move the cursor to the character entry field using the LEFT or RIGHT button.
- ➋ Use UP, DOWN, LEFT, and RIGHT buttons to select a desired character.



- ➌ Press the SET button to confirm selection of the blinking character. The character is then saved, and the cursor in the entry field moves to the next position.
- ➍ Repeat steps ➊ through ➌ until the desired name has been entered.

Notes

• Correcting Mistakes

Move the cursor to 'CLR' and press the SET button to clear the entire entry. To modify one character, use ← or → to position the cursor above the character to be modified and click the SET button after selecting the character to enter.

Operating Your Camera

5. Select on screen position of the CAM TITLE.

- Move the cursor to 'POS' and press SET button.



- The CAM TITLE is displayed on the top-left of the monitor screen. (Default position)



- Select the position by using the 4-directional buttons, then press the SET button to confirm the position.



6. When completed, move the cursor to 'END' and press SET button.

WHITE BALANCE CONTROL

Your camera provides three 'WHITE BAL' control modes for your choosing in adjusting the white balance.

- Press the SET button to access the main setup menu and move the indicator to 'WHITE BAL' using the UP or DOWN button.
- Set 'WHITE BAL' using the LEFT or RIGHT button.

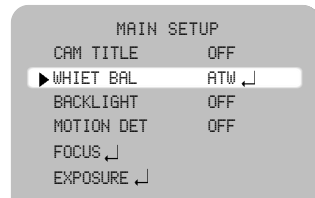

The three white balance control modes are as follows :

ATW(Auto Tracking White Balance):

- OUTDOOR: This mode can be used within the color temperature range 1800~10500K (Ex: fluorescent light, outdoor, sodium vapor lamp or inside tunnels)
- INDOOR: This mode can be used within the color temperature range 3000K~10500K.

AWC(Auto White balance Control):

The white balance is automatically adjusted in a specific environment. In order to obtain the best result, press the SET button while the camera focuses on white paper. If the environment including the light source is changed, you have to adjust the white balance again.

Manual:

To fine adjust, select the Manual mode. You can increase or decrease the red or blue factor while monitoring the difference on the screen. Set to 'MANUAL' mode and press the SET button. Increase or decrease the value for red(R-Gain) and blue(B-Gain), watching the color of the picture, and press the SET button when you obtain the best color.

Operating Your Camera

Notes

- Proper White Balance may not be obtained under the following conditions.
 - ① When the scene contains mostly high color temperature object, such as a blue sky or sunset.
 - ② When the scene is dim.
 - ③ If your camera directly faces a fluorescent lamp or is used in an environment of varying lighting conditions.

BACKLIGHT

When there is a strong backlight behind the object, clear images of the background as well as the object can still be obtained by using the BACKLIGHT function.

1. Please position the arrow to point to 'BACKLIGHT' on the SETUP menu by using the UP and DOWN buttons.
2. Please select the mode you wish to operate by pressing the LEFT or RIGHT button.

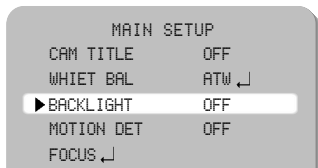

- **HIGH/MIDDLE/LOW:** You can adjust the sensitivity of Backlight Compensation.
- **OFF:** BACKLIGHT function does not operate.



Backlight ON



Backlight OFF

MOTION DETECTION

This product has a feature that allows you to observe movements of objects in 4 different areas on the screen, and the words 'MOTION DETECTED' appear on the screen when movement is detected; hence a single individual can conduct supervision efficiently. The camera detects an object's movement by sensing disparity of outline, and level of brightness and color.

- Please press the SETUP button.
 - OFF: MOTION DETECTION mode is cancelled.
 - ON: Any motion in the selected areas is observed.
- Please press the SETUP button.
 - OFF: MOTION DETECTION mode is cancelled.
 - ON: Any motion in the selected areas is observed.
- Please select the area you wish to observe from the 4 areas in AREA SEL mode.
- Please select ON mode for the chosen area.
- Please adjust the size of the area to be observed by using the UP, DOWN, LEFT or RIGHT button.
- Please press the SETUP button to save changes and complete the setting.

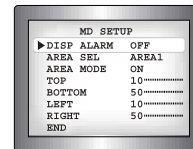

Notes

Tips on Using the Motion Detection Feature

- The feature may not function properly under flickering light conditions.
- The camera interprets sudden changes in lighting and subsequent change in brightness of an object as motion.
- With the feature enabled, other algorithms may require additional time to operate than usual.
- This system does not guarantee prevention of fire or theft. The manufacturer shall not be held responsible for any accident or damage incurred.

Operating Your Camera

FOCUS

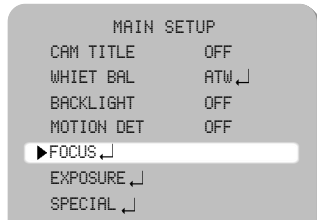

1. Press the SET button to access the main setup manu and then position the indicator over FOCUS using the UP or DOWN button.
2. Press the SET button.

🕒 **MODE:** You can select the most suitable zoom mode. Move the arrow indicator to 'MODE' using UP or DOWN button.

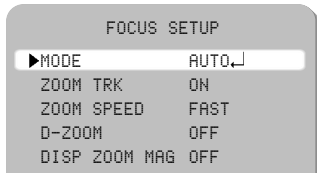

• **AUTO:** Select AUTO and press the SET button to confirm. Increase or decrease optical zoom (ZOOM) or digital zoom (D-ZOOM) positions using the UP or DOWN button while verifying the changes on screen. Enabling D-ZOOM (ON) means that digital zoom will activate once optical zoom ends. Focus is automatically adjusted with moving zoom.

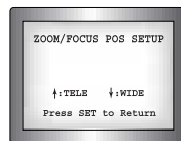

• **ONE PUSH :** Focus is automatically adjusted just once, after zoom position is changed. Select 'ONE PUSH' and press the SET button to confirm. Increase or decrease optical zoom (ZOOM) or digital zoom (D-ZOOM) positions using the directional buttons while verifying the changes on screen. Press the SET button once desired image quality is obtained.



• **MANUAL :** Select 'MANUAL' and press the SET button to confirm. Increase or decrease optical zoom (ZOOM) or digital zoom (D-ZOOM) positions using the directional buttons while verifying the changes on screen. Press the SET button once desired image quality is obtained. Focus can be manually adjusted, independent of moving zoom.

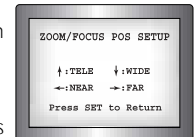

🕒 **ZOOM TRK:** You can select to use 'ZOOM TRK'. Move the arrow indicator to 'ZOOM TRK' using UP or DOWN button. Set 'ZOOM TRK' to on using LEFT or RIGHT button.

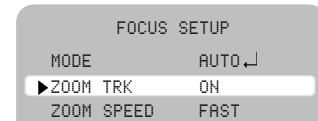

🕒 **ZOOM SPEED:** Configure zoom tracing speed using this feature. Position the indicator over 'ZOOM SPEED' using the UP or DOWN button and then set to desired mode using the LEFT or RIGHT button.

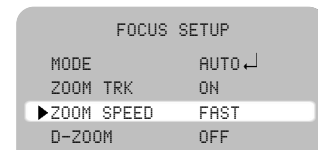

Operating Your Camera

- **FAST:** To move zoom fast.
- **SLOW:** To move zoom slowly.

Notes

- The 'ZOOM SPEED' mode cannot be used if 'MODE' is set to 'AUTO' and 'ZOOM TRK' is 'ON'.

- **D-ZOOM:** Configure magnification limit from x2~x10 using this feature. Position the indicator over 'D-ZOOM' using the UP or DOWN button. Set 'D-ZOOM' to 'ON' and press the SET button to confirm.

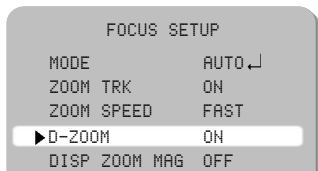

- Set 'ZOOM LIMIT' to the desired level using the LEFT or RIGHT button.



- **DISP ZOOM MAG:** Use this feature to display the current zoom magnification level on screen. Position the indicator over 'DISP ZOOM MAG' using the UP or DOWN button. Then set to ON using the LEFT or RIGHT button.

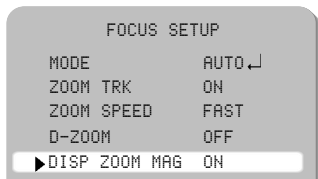

- **ZOOM POS INIT:** Configure zoom position using this feature. Position the indicator over 'ZOOM POS INIT' using the LEFT or RIGHT button.

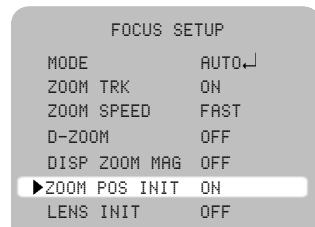

Notes

- Preset setting has priority over a ZOOM POS INIT setting.

- **LENS INIT :** Use this feature to initialize the lens(1x, WIDE). Position the indicator over LENS INIT, using the UP or DOWN button. Press the SET button to confirm.

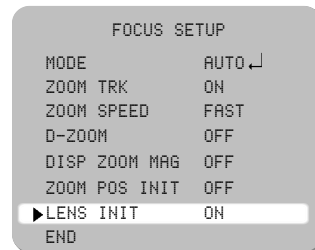

- **END:** To revert to the main setup menu.

Operating Your Camera

EXPOSURE

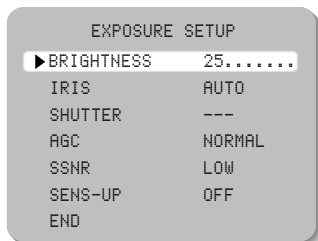

1. Press the SET button to access the main setup menu and then position the indicator over 'EXPOSURE' using the UP or DOWN button.
2. Press the SET button to confirm.

- **BRIGHTNESS**: Use this feature to adjust image brightness. Position the indicator over 'BRIGHTNESS' using the UP or DOWN button. Then increase or decrease brightness level using the LEFT or RIGHT button while verifying the changes on screen. Set END once desired level is obtained.

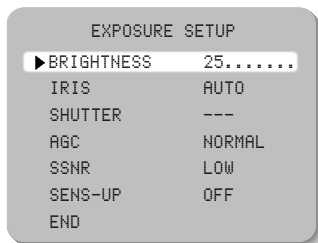

- **IRIS**: Set 'IRIS' to 'AUTO' or 'MANUAL'. Position the indicator over 'IRIS' using the UP or DOWN button and then select the desired iris mode using the LEFT or RIGHT button.

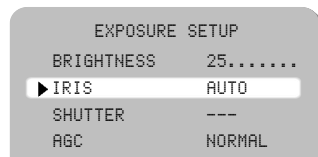

- **AUTO**: The iris is automatically activated upon illumination.
- **MANUAL**: Manual iris configuration. Set 'IRIS' to 'MANUAL' using the LEFT or RIGHT button and then press the SET button. Increase or decrease iris level using the LEFT or RIGHT button while verifying the changes on screen.

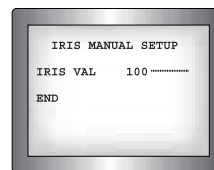

- **SHUTTER** : Control image brightness by adjusting shutter speed.
 1. Position the indicator over 'SHUTTER' using the UP or DOWN button. Then select the desired shutter mode (A.FLK, ESC, MANUAL) using the LEFT or RIGHT button.

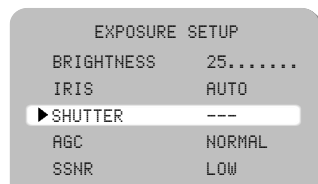

Operating Your Camera

- **A.FLK (NTSC: 1/100, PAL: 1/120)**: Flicker-free mode
- **ESC**: Automatic shutter speed setting (optimal)
- **MANUAL**: Manual shutter speed setting

2. If you choose 'MANUAL', select the optimal shutter speed.

- In MANUAL mode, the optimal shutter speed needs to be designated. Select from 1/60 to 1/120,000 (NTSC) or from 1/50 to 1/120,000 (PAL).
- * 'Sens-Up' mode can be configured manually (2x to 128x).
- Verify changes made to the shutter speed by referencing to changes in on screen brightness.

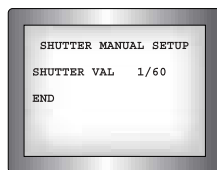

3. Press the SET button to complete.



Notes

- Image may become unstable if the camera is set to 'ESC' mode and faces a strong fluorescent light.
- Under 'ESC' mode, the brightness can be adjusted using the LEFT or RIGHT button.
- The WDR feature is not available under MANUAL mode.
- Sens-up is disabled under 'MANUAL' or 'A.FLK' mode.

• **AGC (Auto Gain Control)**: For brighter images.

1. Position the indicator over 'AGC' using the UP or DOWN button.
2. Set 'AGC' to the desired mode using the LEFT or RIGHT button.

- **HIGH** : Wide range gain value adjustment
- **NORMAL** : Normal range gain value adjustment.
- **OFF** : Disabled

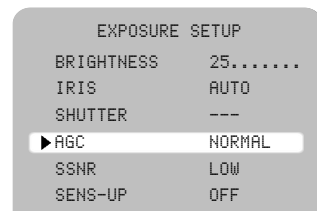

• **SSNR (Samsung Super Noise Reduction)**: On screen noise reduction.

1. Position the indicator over 'SSNR' using the UP or DOWN button.
2. Set 'SSNR' to the desired mode using the LEFT or RIGHT button.

- **LOW** : Low noise reduction
- **MIDDLE** : Medium noise reduction
- **HIGH** : High noise reduction
- **OFF** : Disabled

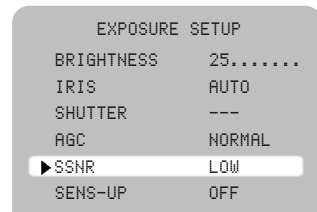

Operating Your Camera

Notes

- Changing 'AGC' setting from NORMAL to HIGH results in greater sensitivity, as well as on screen noise.
- Setting 'AGC' to OFF locks 'SSNR' configuration.

☉ **SENS-UP** : This feature ensures clear images at night or under low lighting conditions.

1. Position the indicator over 'SENS-UP' using the UP or DOWN button.
2. Set 'SENS-UP' to the desired mode using the LEFT or RIGHT button.
 - **AUTO** : Select this mode for use in night time or under low lighting conditions.
 - **OFF** : Disabled

EXPOSURE SETUP	
BRIGHTNESS	25.....
IRIS	AUTO
SHUTTER	---
AGC	NORMAL
SSNR	LOW
▶ SENS-UP	OFF
END	

Notes

- Once 'AUTO' mode is set, the user can configure Sens-Up limit by increasing /decreasing the shutter speed (e.g.: x2,...,x32, x64,..., x128).
- Enabling Sens-Up increases camera sensitivity and may result in additional noise and/or other phenomena. This is normal.

SPECIAL

SPECIAL SETUP	
▶ USER PRESET	OFF
PRIVACY	OFF
DAY/NIGHT	COLOR ↵
SYNC	INT
COMM ADJ ↵	
IMAGE ADJ ↵	
END	

1. Press the SET button to access the main setup menu and then position the indicator over 'SPECIAL' using the UP or DOWN button.
2. Press the SET button to confirm.

☉ USER PRESET:

Preset user-designated configurations using this feature. Position the indicator over 'USER PRESET' using the UP or DOWN button and then set to 'ON' using the LEFT or RIGHT button. Press the SET button to confirm.

SPECIAL SETUP	
▶ USER PRESET	OFF
PRIVACY	OFF
DAY/NIGHT	COLOR ↵
SYNC	INT
COMM ADJ ↵	
IMAGE ADJ ↵	
END	

Operating Your Camera

- **PRESET NO**: Up to eight different preset configurations are supported.

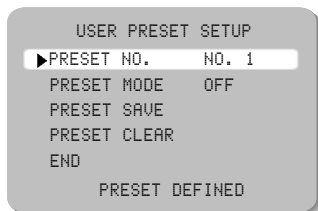

- **PRESET MODE**: Configure initial settings under FOCUS, EXPOSURE, etc.

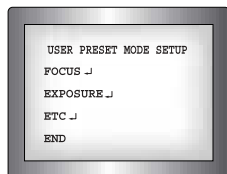

- **PRESET SAVE**: Save configured preset.

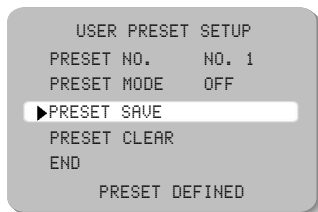

- **PRESET CLEAR**: Clear configured preset.

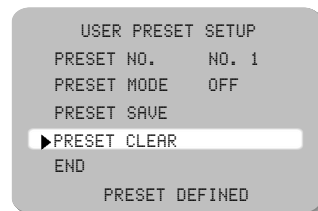

- **END**: Revert to the SPECIAL SETUP menu.

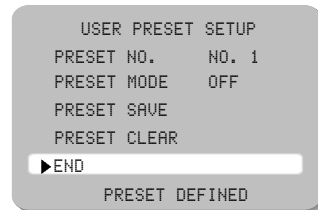

- **PRIVACY**: Mask privacy area using this feature. The mask area expand/contract upon the zoom position.

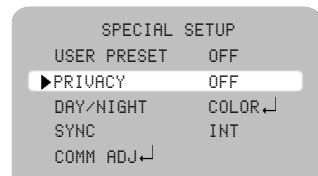

Operating Your Camera

- **GROUP SEL** : Choose up to eight groups. Each group can consist of four mask areas.
- **AREA SEL** : Configure eight mask areas.
- **AREA MODE** : Mask area display.
- **MASK TONE** : Adjust desired mask color level.
- **TOP** : To move the mask area up.
- **BOTTOM** : To move the mask area down.
- **LEFT** : To move the mask area left.
- **RIGHT** : To move the mask area right.



- **DAY/NIGHT**: Select from COLOR, BW or AUTO modes.

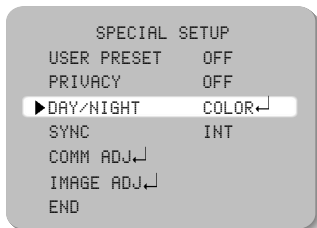

- **COLOR** : Color mode.
- **BW** : BW mode.
- **AUTO1, 2** : The camera automatically detects lighting conditions and selects the mode accordingly. Auto 1 mode is switched to IR Cut Filter more lightning conditions than Auto 2.

Notes

- When selecting AUTO2 mode, the AGC is fixed at HIGH mode.

- **SYNC** : Two synchronization modes are available INTERNAL and EXTERNAL LINE-LOCK. In LINE-LOCK mode, it synchronizes the camera's video out signal to the external SYNC signal.

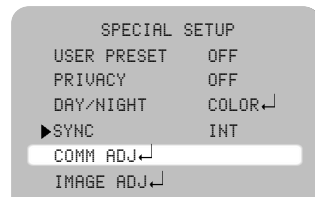

- **INT** : Internal synchronization
- **LL** : External line-lock synchronization
 - If you choose 'LL', you can adjust the desired phase. Press the SET button.
 - You can adjust the desired phase from 0 to 359.

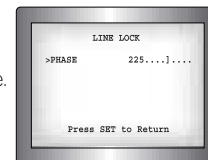

Notes

- For NTSC models, the line-lock mode can be used if the external SYNC signal frequency is at 60Hz.
- For PAL models, the line-lock mode can be used if the external SYNC signal frequency is at 50Hz.

- **COMM ADJ**: Use this feature to select communication protocol. Position the indicator over "COMMUNICATION" using the UP or DOWN button.



Operating Your Camera

- **CAM ID** : Assign ID number to the camera. It is restricted available to set ID from 1 to 255.
- **DISP CAM ID** : Displays camera ID on top left corner of the screen.
- **BAUD RATE** : Configure baud rate from 9600, 19200, 38400, 57600bps.
- **UART MODE** : Configure parity bit to NONE, EVEN, or ODD. Data bit is set to 8bit, and stop bit to 1bit. Set the UART MODE to EVEN if using the Remote Controller.
- **RET PKT** : Used to transfer a packet.
- **END**

◉ **IMAGE ADJ**: Includes image quality or special function factors.



- **FREEZE** : Use this feature to freeze capture an image.
- **H-REV** : Use this feature to horizontally inverse the screen.
- **V-REV** : Use this feature to vertically inverse the screen.
- **SHARPNESS** : Increasing this value sharpens object edges. Too high of a setting, however, produces noise and may obscure the image.
- **COLOR AGAIN** : Adjusting this value affects the chroma level only; the burst level is unaffected.

◉ **END**: evert back to the USER PRESET menu.

RESET

To reset your camera to factory default condition.

EXIT

To finish setup menu.

Troubleshooting

Refer to the following table if you are experiencing trouble with your camera. Contact an authorized technician if the table does not provide you with a solution to the trouble.

Problem	Solution
No display	<ul style="list-style-type: none"> • Check the power cable and the wiring between the camera and the monitor. • Ensure proper video cable connection (Video Out Jack).
Dim display	<ul style="list-style-type: none"> • The lens could be dirty. Clean with a soft, clean piece of cloth. • Adjust monitor settings. • Adjust camera position if exposed to a strong light source.
Dark display	<ul style="list-style-type: none"> • Adjust the monitor's contrast level. • Set the intermediate device, if in use, to 75Ω/ Hi-z (refer to p.13).
The camera is not functioning properly and its surface is hot	<ul style="list-style-type: none"> • Check the power source for compliance with specifications.
Motion Detection feature is not active.	<ul style="list-style-type: none"> • Ensure that the feature is set to ON.
Uneven colors Flickering	<ul style="list-style-type: none"> • Adjust and configure WHITE BAL. • The camera may be facing the sun or a fluorescent light. Adjust the position of the camera.
Can't select LL mode	<ul style="list-style-type: none"> • The camera may be connected to a DC power source. Connect to an AC power source.
LL is not function properly.	<ul style="list-style-type: none"> • Check external SYNC signal frequency (should be 60Hz for NTSC, 50Hz for PAL).

Specifications



		SVD-4300N	SVD-4300P
P O W E R	Input Voltage	AC24V(±10%), DC 12V(±10%)	
	Input Current	290mA(Steady-state)	
	Power Consumption	460mA(Zoom, Focus, Day&night motor operating) - 5.5W Max(Zoom, Focus, Day&Night motor operating)	
C C D	Size	1/4 inch, Interline Transfer CCD	
	Total Pixels	811(H) x 508(V)	795(H) x 596(V)
	Effective Pixels	768(H) x 494(V)	752(H) x 582(V)
O P T I C S	Optics	10X, f=3.8 to 38.0mm(F1.8)	
	Min. Focus Distance	1.500mm	
	D. ZOOM	OFF/ON (X2 - X10)	
	Angle Field of view	H : Appr. 51.2(Wide) to 5.58(Tele)/V : Appr. 39.3(Wide) to 4.27(Tele)	
S y n c.	Scanning System	2:1 Interlace	
	Synchronization	Internal / Line-Lock	
	Frequency	H: 15.734KHz / V: 59.94Hz	H: 15.625KHz / V : 50.00Hz
E L E C.	Resolution	500 TV Lines(Min.) : Color (WIDE) / 570 TV Lines(Min.) : B/W (WIDE)	
	Video Output	CVBS : 1.0Vp-p/75Ω(VBS EXT)	
	S/N (Y signal)	50 dB (AGC Off, Weight ON)	
	Min. Illumination	0.7Lux@F1.8, 0.005Lux@F1.8(Sens-up), Color/0.02Lux@F1.8(B/W)	
	Backlight Compensation	LOW/MIDDLE/HIGH/OFF Selectable	
	Day & Night	Auto1, Auto2, COLOR, B/W(ICR)	
	Gain Control	Normal, High, OFF Selectable	
	White Balance	ATW (INDOOR(3,000K-10,500K), OUTDOOR (1,800K-10,500K))/AWC/MANUAL	
	Electronic shutter speed	AUTO (X128-1/60sec-1/120,000sec) Sens-up and Sens-up Limit is selectable, Flickerless	AUTO (X128-1/50sec-1/120,000sec) Sens-up and Sens-up Limit is selectable, Flickerless
	O.S.D	Built-In	
	Motion Detection	ON/OFF(4 Programmable Zone per Screen)	
	SSNR	Low, Middle, High, Off	
	Focus	Auto / Manual / One push	
	Zoom Movement Speed	1.67sec : Wide to Tele	1.75sec : Wide to Tele
	IRIS Control	Auto, Manual	
	Lens Initialize	Built-In	
	Camera Title	OFF/ON (Displayed 15 characters)	

		SVD-4300N	SVD-4300P
E L E C.	Communication	RS485 External Control(TRX+, TRX-) 9600,19200, 38400 and 57600bps selectable	
		SAMSUNG TECHWIN PROTOCOL AVAILABLE	
		PELCO-D PROTOCOL AVAILABLE	
	Privacy Function	ON/OFF(32Zones, It consists of 8Group 4Programmable Zone per Screen)	
	FLIP	Vertical, Horizontal, Vertical-Horizontal, OFF Selectable	
	Preset	8 Positions	
Operating Temperature/Humidity		-10°C to +50°C / 20% to 80% RH	
Dimension		Ø150 x 130mm(H)	
Weight		1.4 kg	

Dimension

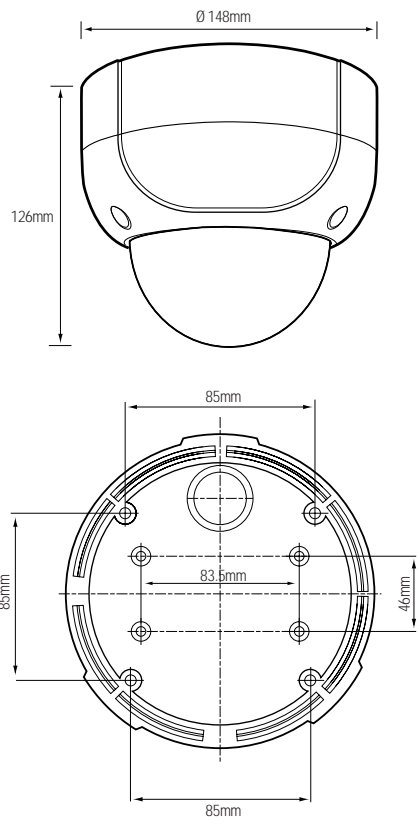

DECLARATION OF CONFORMITY

Application of Council Directive(s)	<u>89 / 336 / EEC</u>
Manufacturer's Name	<u>SAMSUNG TECHWIN CO., LTD</u>
Manufacturer's Address	<u>SAMSUNG TECHWIN CO., LTD</u> <u>42, SUNGJU-DONG CHANGWON-CITY,</u> <u>KYUNGNAM, KOREA, 641-716</u>
European Representative Name	_____
European Representative Address	_____
Equipment Type/Environment	<u>CCTV Camera</u>
Model Name	<u>SVD-4300P</u>
Beginning Serial NO.	<u>S6700001</u>
Year of Manufacture	<u>2006. 7. 1</u>
Conformance to	<u>EN 50081-1 : 1992</u> <u>EMC-Directive 89/336 EEC and 92/31/EEC</u> <u>EN 50130-4 : 1996</u>

We, the undersigned, hereby declare that the equipment specified above conforms to the above Directive(s).

Manufacturer	SAMSUNG TECHWIN CO., LTD	Legal Representative in Europe
Signature	<i>Young Taek, SON</i>	Signature
Full Name	YOUNG TAEK SON	Full Name
Position	QUALITY CONTROL MANAGER	Position
Place	CHANGWON, KOREA	Place
Date	2006. 7. 1	Date

Free Manuals Download Website

<http://myh66.com>

<http://usermanuals.us>

<http://www.somanuals.com>

<http://www.4manuals.cc>

<http://www.manual-lib.com>

<http://www.404manual.com>

<http://www.luxmanual.com>

<http://aubethermostatmanual.com>

Golf course search by state

<http://golfingnear.com>

Email search by domain

<http://emailbydomain.com>

Auto manuals search

<http://auto.somanuals.com>

TV manuals search

<http://tv.somanuals.com>