

SyncMaster 172MP/152MP



Index

- ▢ Main Page
- ▢ Safety Instructions
 - ▢ Notational
 - ▢ Power
 - ▢ Installation
 - ▢ Cleaning
 - ▢ Other
- ▢ Introduction
 - ▢ Unpacking
 - ▢ Front
 - ▢ Rear
 - ▢ Remote Control
- ▢ Setup
 - ▢ Connecting Your Monitor
 - ▢ Connecting to a Computer
 - ▢ Connecting to Other Devices
 - ▢ Installing the Monitor Driver
 - ▢ Automatic
 - ▢ Manual
 - ▢ Installing a VESA Base
 - ▢ Folding the base / Removing the base
 - ▢ Installing a VESA Base
- ▢ Adjusting Your LCD Monitor
 - ▢ User Controls
 - ▢ User control buttons
 - ▢ Direct-Access Features
 - ▢ On-Screen Display
 - ▢ OSD Functions
 - ▢ Screen Adjustment Animation Clips
- ▢ Troubleshooting
 - ▢ Check before Calling for Service
 - ▢ Problems and Solutions
 - ▢ Q & A
- ▢ Specifications
 - ▢ General Specifications
 - ▢ PowerSaver
 - ▢ Preset Timing Modes
- ▢ Information
 - ▢ Service Center
 - ▢ Terms
 - ▢ Regulatory
 - ▢ Natural Color
 - ▢ For Better Display
 - ▢ Authority

Safety Instructions - Notational

Please read the following safety instructions as they are designed to prevent damage to property and harm to the user.



Warning / Caution



Failure to follow directions noted by this symbol could result in bodily harm or damage to equipment.

Notational Conventions



Prohibited



Do not disassemble



Do not touch



Important to read and understand at all times



Disconnect the plug from the outlet



Grounding to prevent an electric shock

Safety Instructions - Power



When not used for extended periods of time, set your computer to DPMS. If using a screen saver, set it to the active screen mode.



- **Do not use a damaged or loose plug.**
 - This may cause an electric shock or fire.



- **Do not pull the plug out by the wire nor touch the plug with wet hands.**
 - This may cause an electric shock or fire.



- **Use only a properly grounded plug and receptacle.**
 - An improper ground may cause electric shock or equipment damage.



- **Do not excessively bend the plug and wire nor place heavy objects upon them, which could cause damage.**
 - This may cause an electric shock or fire.



- **Disconnect the plug from the outlet during storms or lightning or if it is not used for a long period of time.**
 - Failure to do so may cause an electric shock or fire.

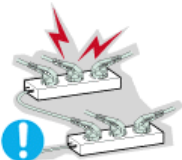

- **Do not connect too many extension cords or plugs to an outlet.**
 - This may cause a fire.

Safety Instructions - Installation



- **Do not cover the vents on the monitor cabinet.**
 - Bad ventilation may cause a breakdown or fire.



- **Put your monitor in a location with low humidity and a minimum of dust.**
 - An electric shock or fire could result inside the monitor.



- **Do not drop the monitor when moving it.**
 - This may cause damage to the product or human body.



- **Place the monitor on a flat and stable surface.**
 - The monitor can cause injury by falling.



- **Set down the monitor carefully.**
 - It could be damaged or broken.



- **Do not place the monitor face down.**
 - The TFT-LCD surface may be damaged.



- **Installing a wall bracket must be done by a qualified professional.**
 - Installation by unqualified personnel may result in injury.
 - Always use the mounting device specified in the owner's manual.

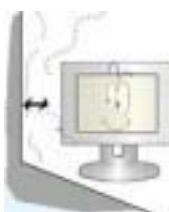

- **Leave a space for ventilation between the product and the wall.**
 - Poor ventilation may cause the interior temperature to rise and lead to a fire.

Safety Instructions - Cleaning



When cleaning the monitor case or the surface of the TFT-LCD screen, wipe with a slightly moistened, soft fabric.



- Do not spray detergent directly on the monitor.



- Use the recommended detergent with a smooth cloth.



- If the connector between the plug and the pin is dusty or dirty, clean it properly with a dry cloth.

- A dirty connector can cause an electric shock or fire.



- Do not set a glass of water, chemicals or any small metal objects on the monitor.

- This may cause damage, electric shock or a fire.
- If a foreign substance gets into the monitor, disconnect the plug and then contact a [service center](#).



- Contact a Service Center or Customer Center for interior cleaning once a year.

- Keep the product's interior clean. Dust which has accumulated in the interior over an extended period of time may cause malfunction or a fire.

Safety Instructions - Other



Do not remove cover(or back). No user serviceable parts inside.

- This may cause an electric shock or a fire.
- Refer servicing to qualified service personnel.



If your monitor does not operate normally - in particular, if there are any unusual sounds or smells coming from it - unplug it immediately and contact an authorized dealer or service.

- This may cause an electric shock or fire.



Do not place any heavy objects on the monitor.

- This may cause an electric shock or a fire.



For each hour of looking at the monitor, you should let your eyes rest for 5 minutes.

- This will reduce eye fatigue.



Do not use or store inflammable substances near the monitor.

- This may cause an explosion or fire.



Do not try to move the monitor by pulling on the wire or the signal cable.

- This may cause a breakdown, electric shock or a fire due to damage to the cable.



Do not move the monitor right or left by pulling only the wire or the signal cable.

- This may cause a breakdown, electric shock or a fire due to damage to the cable.



Never insert anything metallic into the monitor openings.

- This may cause an electric shock, fire or injury.

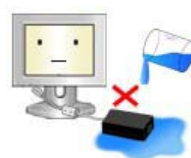

Be careful that adaptor should not be in contact with water and therefore not be wet.

- This may cause malfunction, an electric shock or a fire.
- Do not use adaptor by the waterside or outside particularly when it rains or snows.
- Be careful that adaptor should not be wet while cleaning floor with water.

Safety Instructions - Other



Keep all power adaptors apart.

- Possible fire hazard.



Keep power adaptor away from any other heat source.

- Possible fire hazard.



Remove and discard vinyl bag from power adaptor before use.

- Possible fire hazard.



Always keep power adaptor in well-ventilated area.



If you view a fixed screen for an extended period of time, residual image or blurriness may appear.

- Change the mode to energy save or set a screensaver to moving picture when you need to be away from the monitor for an extended period of time.



To ease eye strain, take at least a five-minute break after every hour of using the monitor.



Do not use the monitor where it can be exposed to strong vibrations.

- Exposure to strong vibrations can be a fire hazard and shorten the life of the monitor.



When moving the monitor, turn the power switch off and unplug the power cord.

Make sure that all cables, including the antenna cable and cables connecting to other devices, are disconnected before moving the monitor.

- Failure to disconnect a cable may damage it and lead to a fire or an electric shock.

Introduction - Unpacking

 Please make sure the following items are included with your monitor. If any items are missing, [contact your dealer](#).



User's Guide and Natural Color/
Driver Installation CD

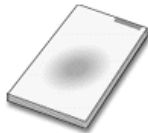

Quick Setup Guide



Warranty Card
(Not available in all locations)



Remote Control



Monitor



Batteries (AAA X 2)



Power Cord



Signal Cable(15 pin D-Sub)



DC Adapter



Audio Cable



TV Tuner Box (option)

Introduction - Front

 For detailed information concerning the monitor functions, refer to [User Controls](#) under Adjusting Your Monitor. The monitor's front configuration may vary slightly depending on the monitor model.

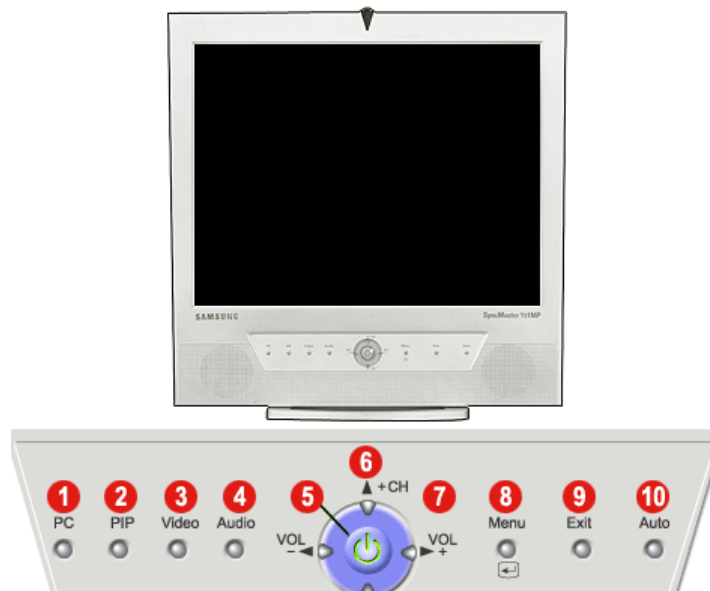

- | | |
|-----------------------------------|--------------------------------------|
| 1. PC mode button | 6. Up-Down button / Channel button |
| 2. PIP mode button | 7. Left-Right button / Volume button |
| 3. Video mode button | 8. Menu button |
| 4. Audio mode button | 9. Exit button |
| 5. Power button / Power indicator | 10. Auto button |

PIP(Picture in Picture)?

Feature allowing one program to be viewed on the entire screen while one or more programs play in small windows superimposed over the base program. PIP is also referred to as Split Windows.

Introduction - Rear

 For detailed information concerning cable connections, refer to [Connecting Cables](#) under Setup. The monitor's rear configuration may vary slightly depending on the monitor model.

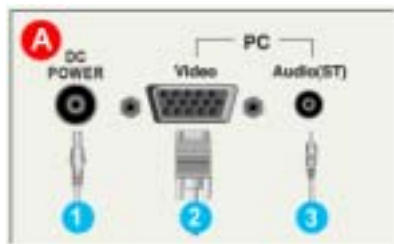

A. PC Connection Terminal

1. Power Connection Terminal (14V DC)
2. Computer Connection Terminal (15 Pin D-SUB)
3. Audio Connection Terminal (Audio (ST))

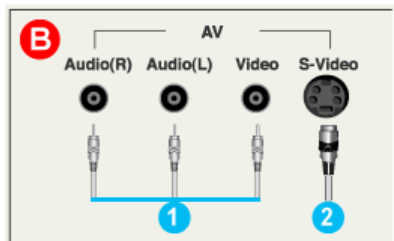

B. AV Connection Terminal

1. AV Audio (L,R) / Video connection terminal
2. S-Video connection terminal

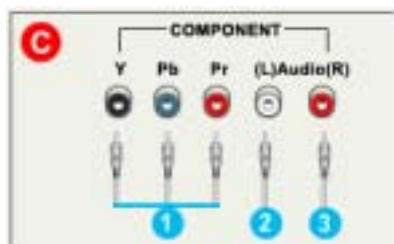

C. DVD/DTV Connection Terminal

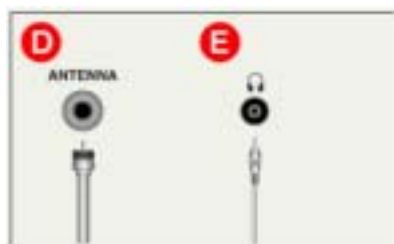

1. DVD/DTV component(Y, Pb, Pr) Terminal
2. DVD/DTV left audio connection terminal (L)
3. DVD/DTV right audio connection terminal (R)



D. Antenna Connection Terminal (When TV is connected)

E. Headphone connection terminal

Introduction - Remote Control

-  For detailed information of the Remote Control Unit functions, refer to Adjusting Your Monitor > User Controls > User Control Buttons > [Remote Control buttons](#).
The remote control's configuration may vary slightly depending on the monitor model.
-  The Remote control may function within a range of 0.23 to 33 feet (7cm to 10m) and 30 degrees to the left and right of the monitor's Remote Control Reception sensor.

[Button Names](#) | [Replacing Batteries](#) | [Usage](#)

1. Button Names



1. Power button
2. PC mode button
3. PIP(Picture-in-Picture) mode button
4. Video mode button
5. Audio mode button
6. PIP Position button
7. PIP Size button
8. Up-Down button / Channel button
9. Left-Right button / Volume button
10. Menu button
11. Exit button
12. Mute button
13. Channel button
14. Display button
15. Previous channel button
16. Auto button
17. Channel search button
18. MTS/S-mode button
19. Caption button

2. Replacing Batteries



1. Slide out the cover pressing part marked .
2. Insert the batteries matching their polarities (+, -).
3. Slide in the cover.

Setup - Connecting Your Monitor

 Turn on your computer and monitor. If your monitor displays an image, installation is complete.

1. Connecting to a Computer

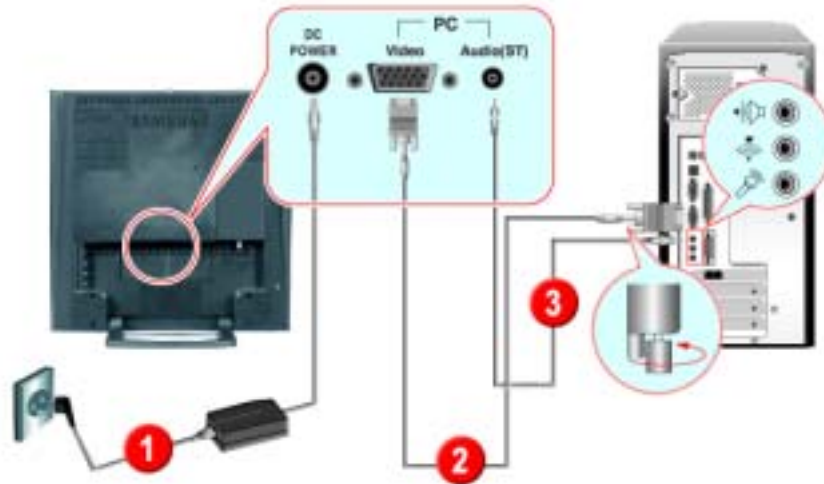

1. Connect the power cord to the DC adapter and connect the adapter jack to the DC POWER port on the back of your monitor.
2. Connect the signal cable to the video port on your computer.
3. Connect the audio cable for your monitor to the audio port on the back of your computer.
4. Turn on both your computer and the monitor.
5. You may enjoy clear and quality sound from the computer sound card using the monitor speakers. (You don't need to install any separate speakers for your computer.)

 Contact a local Samsung Electronics [service center](#) to buy optional items.

Setup - Connecting to other devices

 This monitor allows the user to connect it to such input devices as a DVD player, a VCR or camcorder, or a DTV or TV without disconnecting the PC. For detailed information on connecting AV input devices, refer to [User Controls](#) under Adjusting Your Monitor.

[Connecting AV Devices](#) | [Connecting TV](#) | [Connecting DVD / DTV Set Top Box](#)

[Connecting to a Macintosh](#) | [Connecting Headphone](#)

1. Connecting AV Devices

 The monitor has AV connection terminals to connect AV input devices like DVDs, VCRs or Camcorders. You may enjoy AV signals as long as the monitor is turned on.

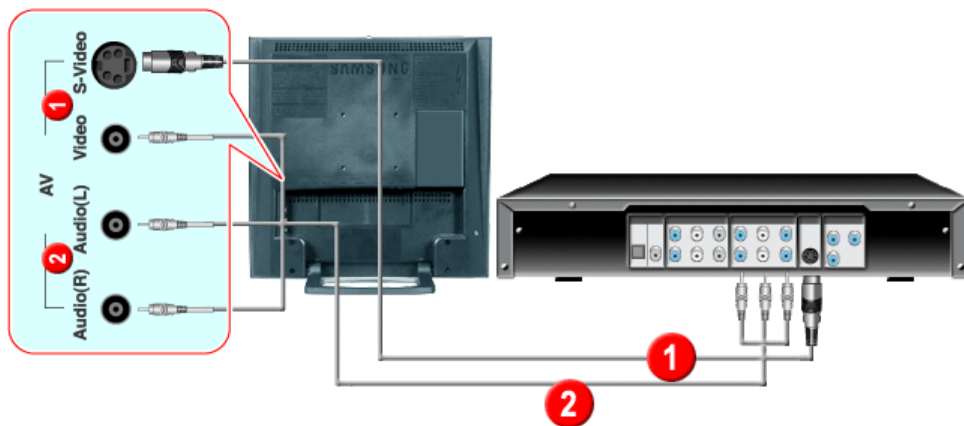

1. Input devices such as DVDs, VCRs or Camcorders are connected to the Video or S-Video terminal of the monitor using the RCA or S-VHS cable.

 S-VHS or RCA cable is optional.

2. Connect the Audio (R) and Audio (L) terminals of a DVD, VCR or Camcorders to the monitor's R and L audio input terminals using audio cables.
3. Select Video or S-Video that is connected to a DVD, VCR or Camcorders using the Source button on the monitor's front.
4. Then, start the DVD, VCR or Camcorders with a DVD disc or tape inserted.

Setup - Connecting to other devices

2. Connecting TV (Connect a TV tuner box (option))

 With a TV tuner box (option), you can watch TV simply by hooking up the monitor to an antenna or to your cable box. There is no need to buy a TV card which connects to a PC, or additional hardware or software.

Contact a local Samsung Electronics [service center](#) to buy optional items.



1. Connect the antenna or the cable box to the TV tuner box using the "ANTENNA" terminal on the tuner box.
2. Remove the TV Tuner Box cover from the rear of the monitor.
3. Insert the connected tuner box into the slot and firmly tighten the two screws using a coin to lock the box in place. (Loose screws may cause a blank screen or picture noise)
4. Replace the TV Tuner Box cover.
5. Turn on the monitor.
6. Select TV using Source button among the external signal adjustment buttons.
7. Select a desired TV channel.

 **As this product is designed for NTSC signals only, you cannot view TV programs in countries where PAL or SECAM signals are used.**

Setup - Connecting to other devices

3. Connecting DVD / DTV Set Top Box

-  Connect to the DVD / DTV Set Top Box input if the device has a DTV/DVD connector. You can watch DTV/DVD simply by hooking up the DTV/DVD with the monitor as long as the power is on.

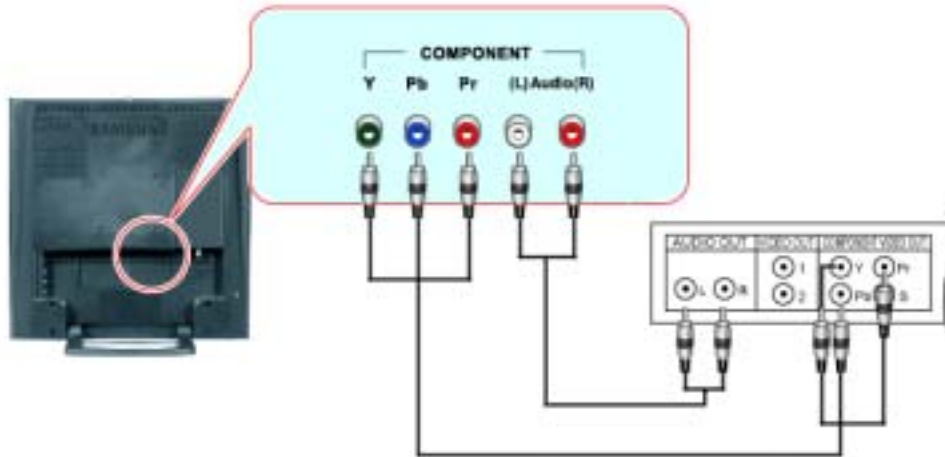

1. Connect a video cable between the COMPONENT(Y, Pb, Pr) jacks on the Monitor and the Y, Pb, Pr jacks on the DVD / DTV set top box.
2. Connect the Audio (R) and Audio (L) outputs on the DVD / DTV set top box to the Audio (R) and Audio (L) inputs on the monitor using audio cables.
3. Select COMP using the Video button from the user control buttons.

4. Connecting to a Macintosh

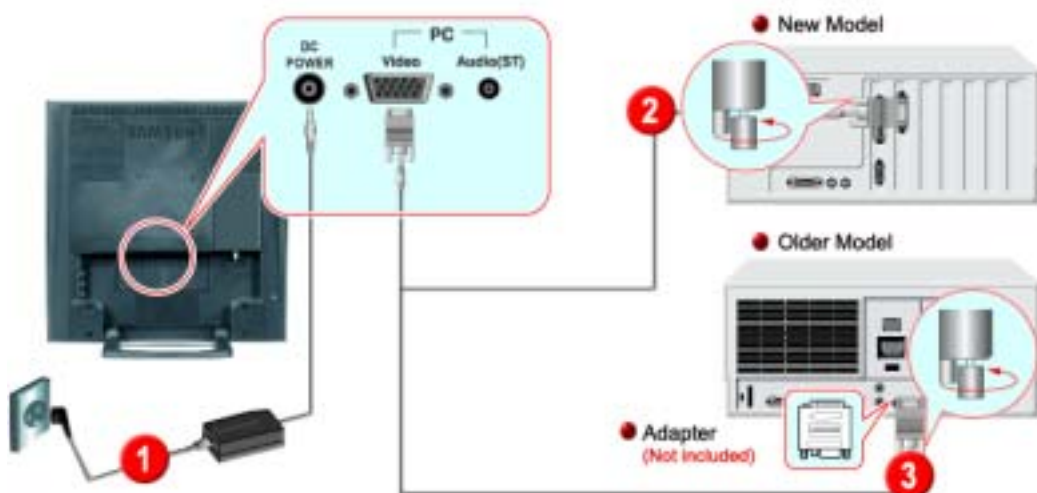

1. Connect the power cord to the DC adapter and then connect the adapter jack to the DC POWER port on the monitor. (Voltage is automatically adjusted by the power adaptor.)
2. Connect the signal cable to the D-SUB port on the Macintosh computer.
3. For older model Macintoshes, you need to adjust the resolution control DIP switch on the Macintosh adapter (optional) referring to the switch configuration table shown on its rear.
4. Turn on the monitor and Macintosh.

-  Contact a local Samsung Electronics [service center](#) to buy optional items.

Setup - Connecting to other devices

5. Connecting Headphone

 You may connect your headphones to the monitor.

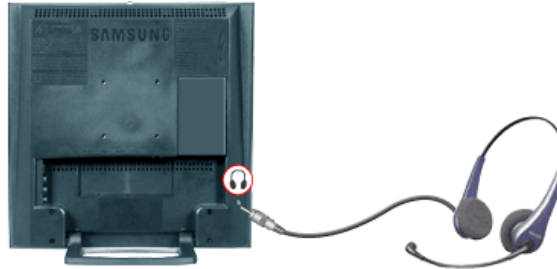

1. Connect your headphones to the Headphone-out port.

Setup - Installing the Monitor Driver

 When prompted by the operating system for the monitor driver, insert the CD-ROM included with this monitor. Driver installation is slightly different from one operating system to another. Follow the directions as appropriate for the operating system you have.

Prepare a blank disk and download the driver program file at the Internet web site shown here.

- Internet web site : <http://www.samsung-monitor.com/> (Worldwide)
<http://www.samsungusa.com/monitor/> (USA)
<http://www.sec.co.kr/monitor/> (Korea)
<http://www.samsungmonitor.com.cn/> (China)

[Windows ME](#) | [Windows XP/2000](#)

1. Windows ME

 Refer to "Installing the Monitor Driver and User Manual" CD-ROM supplied with the monitor. When inserted into the computer CD drive, the CD-ROM boots up automatically. If it fails to boot up automatically, click **monsetup.exe** twice in the CD-ROM drive folder of Windows Explorer.

1. Insert CD into the CD-ROM driver.
2. Click "**Windows ME Driver**"
3. Choose your monitor model in the model list, then click the "**OK**" button.



4. Click the "**Install**" button in the "**Warning**" window.



5. Monitor driver installation is completed.

Setup - Installing the Monitor Driver

2. Windows XP/2000

Refer to "Installing the Monitor Driver and User Manual" CD-ROM supplied with the monitor. When inserted into the computer CD drive, the CD-ROM boots up automatically. If it fails to boot up automatically, click **monsetup.exe** twice in the CD-ROM drive folder of Windows Explorer.

1. Insert CD into the CD-ROM driver.
2. Click "**Windows XP/2000 Driver**".
3. Choose your monitor model in the model list, then click the "**OK**" button.



4. Click the "**Install**" button in the "**Warning**" window.



5. If you can see following Message window, then click the "**Continue Anyway**" button. Then click "**OK**" button.

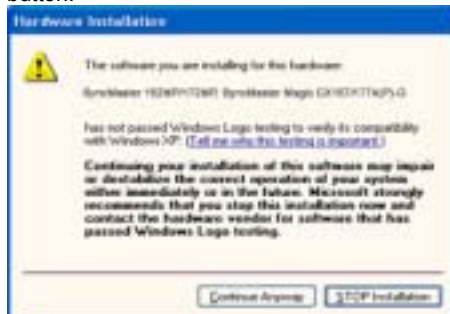

This monitor driver is under certified MS logo. This installation will not damage your system. The certified driver will be posted on Samsung Monitor Homepage <http://www.samsung-monitor.com/>

6. Monitor driver installation is completed.

Setup - Installing the Monitor Driver

 **When prompted by the operating system for the monitor driver, insert the CD-ROM included with this monitor. Driver installation is slightly different from one operating system to another. Follow the directions as appropriate for the operating system you have.**

Prepare a blank disk and download the driver program file at the Internet web site shown here.

- Internet web site : <http://www.samsung-monitor.com/> (Worldwide)
<http://www.samsungusa.com/monitor/> (USA)
<http://www.sec.co.kr/monitor/> (Korea)
<http://www.samsungmonitor.com.cn/> (China)

To install the monitor driver manually, follow the procedures explained below after checking your operating system.

[Windows XP](#) | [Windows 2000](#) | [Windows Me](#) | [Windows NT](#) | [Linux](#)

1. Microsoft® Windows® XP Operating System

1. Insert CD into the CD-ROM driver.
2. Click "**Start**" —> "**Control Panel**" then click the "**Appearance and Themes**" Icon.

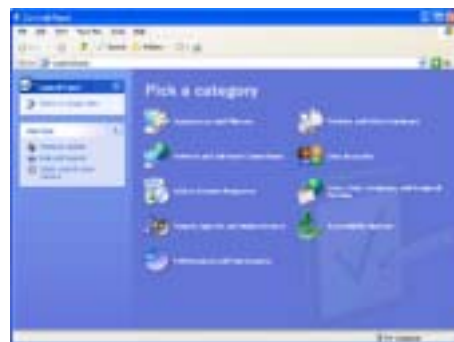

3. Click "**Display**" icon and choose the "**Settings**" tab then click "**Advanced..**".



4. Click the "**Properties**" button on the "**Monitor**" tab and select "**Driver**" tab.



Setup - Installing the Monitor Driver

5. Click "**Update Driver..**" and select "**Install from a list or..**" then click "**Next**" button.

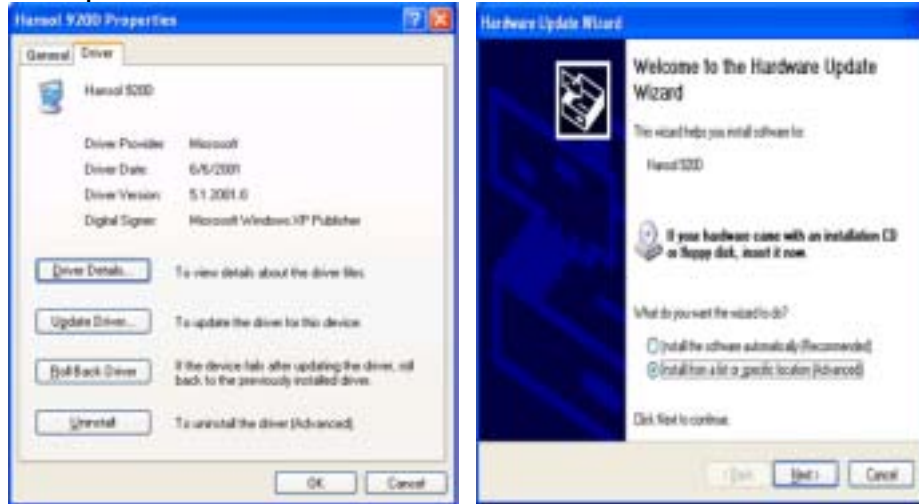

6. Select "**Don't search, I will..**" then click "**Next**" and then click "**Have disk**".



7. Click the "**Browse**" button then choose A:(D:\Driver) and choose your monitor model in the model list and click the "**Next**" button.



8. If you can see following "**Message**" window, then click the "**Continue Anyway**" button. Then click "**OK**" button.

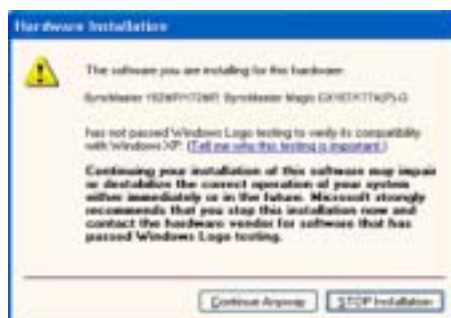

This monitor driver is under certified MS logo. This installation will not damage your system. The certified driver will be posted on Samsung Monitor Homepage <http://www.samsung-monitor.com/>

Setup - Installing the Monitor Driver

9. Click the "Close" button then click "OK" button continually.

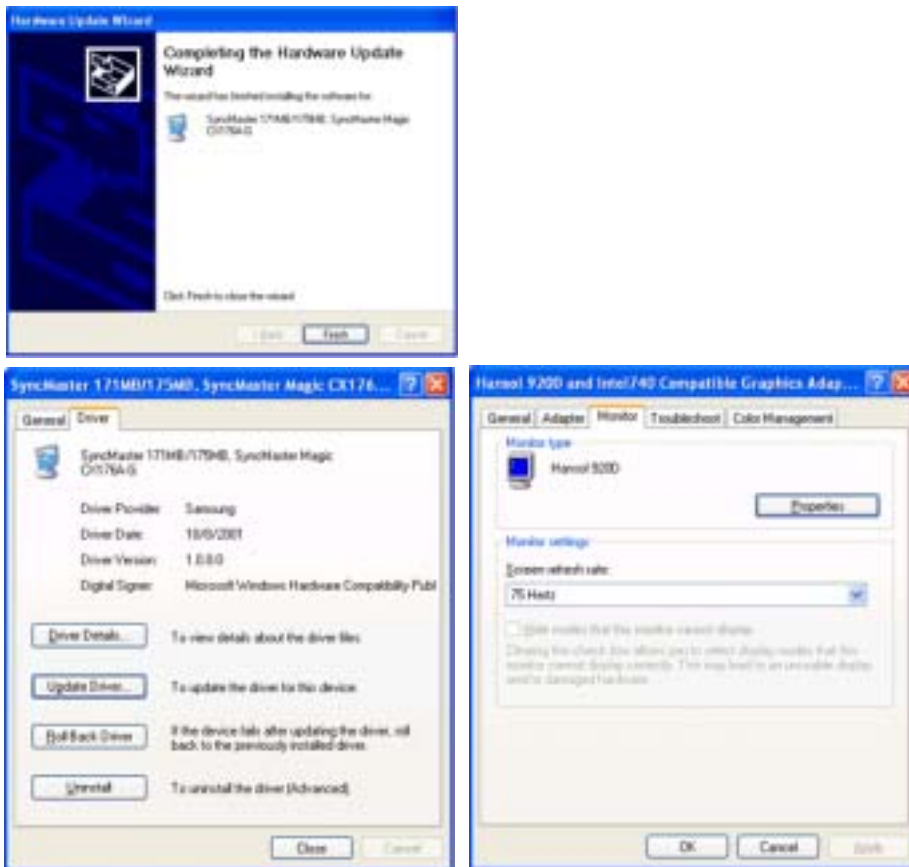

10. Monitor driver installation is completed.

2. Microsoft® Windows® 2000 Operating System

* When you can see "Digital Signature Not Found" on your monitor, follow these steps.

1. Choose "OK" button on the "Insert disk" window.
2. Click the "Browse" button on the "File Needed" window.
3. Choose A:(D:Driver) then click the "Open" button and then click "OK" button.

* How to install

1. Click "Start", "Setting", "Control Panel".
2. Double click the "Display" icon.
3. Choose the "Settings" tab and then click "Advanced..".
4. Choose "Monitor":
 - Case 1: If the "Properties" button is inactive, it means your monitor is properly configured. Please stop installation.
 - Case 2: If the "Properties" button is active, click the "Properties" button then follow next steps continually.
5. Click "Driver" and then click on "Update Driver.." then click on the "Next" button.

Setup - Installing the Monitor Driver

6. Choose "**Display a list of the known drivers for this device so that I can choose a specific driver**" then click "**Next**" and then click "**Have disk**".
7. Click the "**Browse**" button then choose A:(D:\Driver).
8. Click the "**Open**" button, then click "**OK**" button.
9. Choose your monitor model and click the "**Next**" button then click "**Next**" button.
10. Click the "**Finish**" button then the "**Close**" button.

If you can see the "**Digital Signature Not Found**" window then click the "**Yes**" button. And click the "**Finish**" button then the "**Close**" button.

3. Microsoft® Windows® Millennium Operating System

1. Click "**Start**", "**Setting**", "**Control Panel**".
2. Double click "**Display**" icon.
3. Select the "**Settings**" tab and click "**Advanced Properties**" button.
4. Select the "**Monitor**" tab.
5. Click the "**Change**" button in the "**Monitor Type**" area.
6. Choose "**Specify the location of the driver**".
7. Choose "**Display a list of all the driver in a specific location..**" then click "**Next**" button.
8. Click the "**Have Disk**" button
9. Specify A:(D:\driver) then click "**OK**" button.
10. Select "**Show all devices**" and choose the monitor that corresponds to the one you connected to your computer and click "**NEXT**". Click "**NEXT**" again and "**FINISH**" to complete installation.
11. Continue choosing "**CLOSE**" button and "**OK**" button until you close the Display Properties dialogue box.
(You may get a screen with a warning or other message, just click the appropriate option for your monitor.)

4. Microsoft® Windows® NT 4.0 Operating System

1. Click **Start**, **Settings**, **Control Panel**, and then double-click **Display** icon.
2. In Display Registration Information window, click Settings Tab and then click **All Display Modes**.
3. Select a mode that you wish to use (Resolution, Number of colors and Vertical frequency) and then click **OK**.
4. Click **Apply** button if you see the screen working normally after clicking Test. If the screen is not normal, change to a different mode (lower mode of resolution, colors or frequency).

 If there is no Mode at **All Display Modes**, select the level of resolution and vertical frequency by referring to the [Preset Display Modes](#) in the user guide.

5. Linux Operating System

 To execute X-Window, you need to make the X86Config file, which is a type of system setting file.

1. Press Enter at the first and the second screen after executing the X86Config file.
2. The third screen is for **setting your mouse**.
3. Set a mouse for your computer.
4. The next screen is for **selecting a keyboard**.
5. Set a Keyboard for your computer.
6. The next screen is for **setting your monitor**.
7. First of all, set a **horizontal frequency** for your monitor. (You can enter the frequency directly.)
8. Set a **vertical frequency** for your monitor. (You can enter the frequency directly.)
9. Enter the **model name of your monitor**. This information will not affect the actual execution of X-Window.
10. You have **finished** setting up your monitor.
Execute X-Window after setting other requested hardware.

Setup - Installing a VESA base

 This monitor supports various types of VESA-standard bases. You need to either fold or remove the base in use in order to install a VESA base.

[Folding the base](#) | [Removing the base](#)

1. Folding the base

 The monitor may be reclined from 0 to 90 degrees. When fully folded (reclined), the base becomes a handy holder for moving the monitor around.

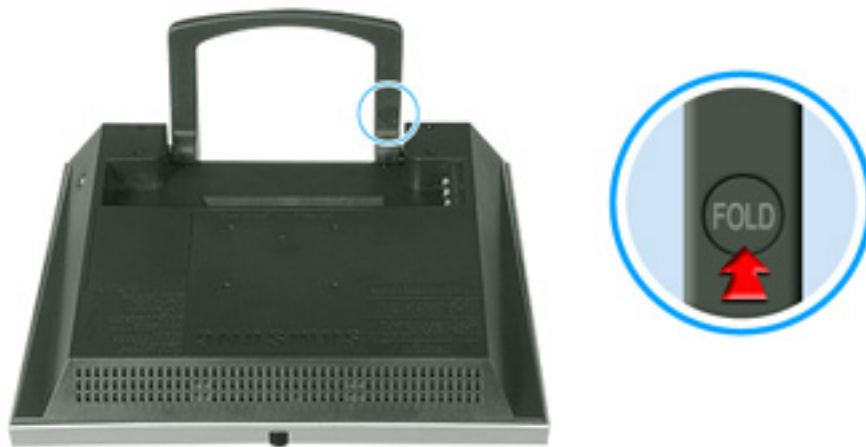

1. Lay the LCD monitor face-down on a flat surface with a cushion beneath it to protect the screen.
2. Disconnect the monitor cables.
3. Fully recline the monitor backward pressing the **FOLD** button.
4. Reconnect the monitor cables.

 You may [install a VESA base](#) when the monitor base is fully folded.

2. Removing the base

 You can separate the base from the monitor.



1. Lay the LCD monitor face-down on a flat surface with a cushion beneath it to protect the screen.
2. Disconnect the monitor cables.
3. Remove the four bolts that fasten the base to the monitor.
4. Reconnect the monitor cables.

 You may [install a VESA base](#) when the monitor base is separated.

Setup - Installing a VESA base

-  The monitor supports VESA mounting standard for use with various VESA mounting devices. This monitor accepts a 75mm x 75mm VESA-compliant mounting interface pad. You need to [fold the monitor base](#) before installing a VESA base.

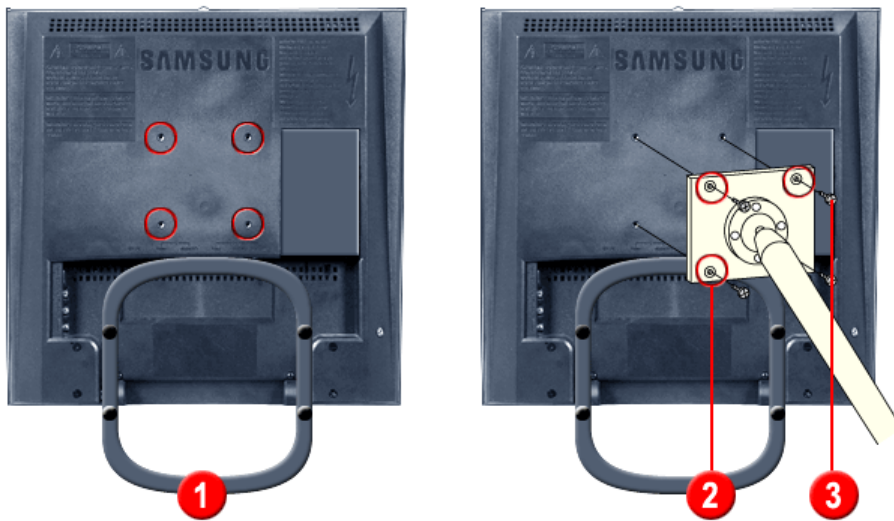

Align **the four bolt holes (1)** on the monitor base with **the holes (2)** on the VESA base and then fasten the base with **the four bolts (3)** supplied.

-  Only the supplied bolts should be used.

 Samsung Electronics will not be responsible for damages caused by using a base other than those specified.

Adjusting Your LCD Monitor - User Controls

 The control button configuration may vary slightly depending on the monitor model.

[Source Buttons](#) | [Control Buttons](#) | [Remote Control Buttons](#)

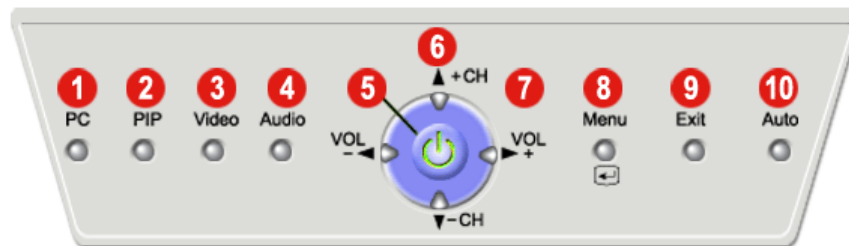

| Source Buttons |

1. PC mode button

Switches from Video mode to PC mode.

2. PIP mode button

In PC Mode, turns on Video or TV screens in PIP mode. Using this function, you may view a Video or TV program while performing PC work. (PIP mode button works in PC mode only.)

To switch Screen modes: [PC + TV] → [PC + Video] → [PC + S-Video] (Press [here](#) to view Screen Mode Switching Animation Clips)

In PIP mode, [COMP] is not supported.

3. Video mode button

Switches from PC mode to Video mode. The image size automatically switches to Full when Video mode is on.

To switch Screen modes: [TV] → [Video] → [S-Video] → [COMP] (Press [here](#) to view Screen Mode Switching Animation Clips)

4. Audio mode button

Adjusts Audio mode. You may switch to the Audio signal for the current display mode when the wrong audio is playing.

To switch Screen modes: [PC] → [TV] → [Video] → [COMP] (Press [here](#) to view Screen Mode Switching Animation Clips)

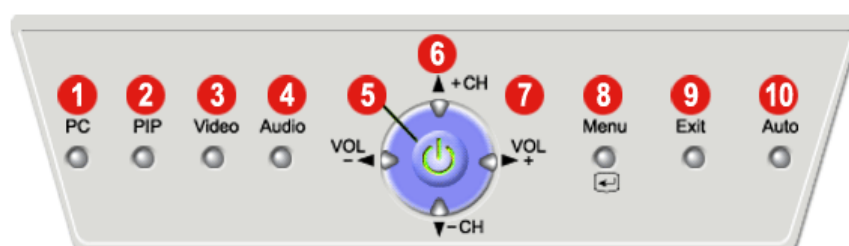

Adjusting Your LCD Monitor - User Controls

| Control Buttons |

 For more information on the screen adjustment functions, refer to [On-Screen Display](#).

5. Power button / Power indicator

Use this button for turn the monitor on and off. Power Indicator shows PowerSaver mode by green blinking. Refer to Specifications > [PowerSaver](#).

6. ▲+CH / ▼-CH button

Moves from one menu item to another vertically or adjusts selected menu values. In TV mode, selects TV channels. For more information, refer to Direct-Access Features > [Channel](#).

7. VOL- ◀ / VOL ▶+ button

Moves from one menu item to another horizontally or adjusts selected menu values. Also adjusts the audio volume. For more information, refer to Direct-Access Features > [Volume](#).

8. Menu(☰) button

Use this button for open the OSD and activate a highlighted menu item.

9. Exit button

Exit button exits from the menu screen or closes screen adjustment menu.

10. Auto button

Auto button adjusts the screen automatically. For more information, refer to Direct-Access Features > [Automatic Save](#).

| Remote Control Buttons |

 For more information on the screen adjustment functions, refer to [On-Screen Display](#).

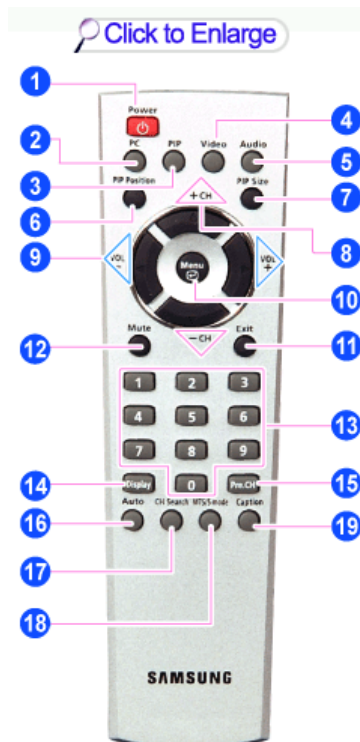

1. Power button
2. PC button
3. PIP(Picture-in-Picture) button
4. Video button
5. Audio button
6. PIP Position button
7. PIP Size button
8. Up-Down button / Channel button
9. Left-Right button / Volume button
10. Menu button
11. Exit button
12. Mute button
13. Channel button
14. Display button
15. Previous channel button
16. Auto button
17. Channel search button
18. MTS/S-mode button
19. Caption button

1. Power button

Adjusting Your LCD Monitor - User Controls

Use this button for turn the monitor on and off.

2.-5. Source Button ▲Up

See the [Source Buttons](#) above.

6. PIP Position button ▲Up

Adjusts the location of Video image in PIP mode. Press VOL - ◀ / VOL ▶ +, ▲ + CH / ▼ - CH buttons to adjust the location up and down or left and right.

7. PIP Size button ▲Up

Adjusts the PIP image size in PIP mode. Use the VOL - ◀ / VOL ▶ + buttons to exit PIP mode, or reduce or enlarge the PIP screen.

8.-11. Control Buttons ▲Up

See the [Control Buttons](#) above.

12. Mute button ▲Up

Pauses (mutes) the audio output temporarily. The audio resumes if Mute or VOL - ◀ / VOL ▶ + button is pressed in the Mute mode.

13. Channel button ▲Up

Selects TV channels in the TV mode. You may use this button in PIP mode as well.

14. Display button ▲Up

Shows a Video Source, Audio Source, current channel number, an audio type and Speaker Mute ON/OFF on the upper right corner of the screen.

15. Previous channel button ▲Up

This button is used to return to the immediately previous channel.

16. Auto button ▲Up

Adjusts the screen display automatically. For more information, refer to Direct-Access Features > [Automatic Save](#).

17. Channel search button ▲Up

Automatically scans and registers TV channels available (viewable) in the current location. For detailed information on adjusting the TV screen, refer to OSD Functions > [TV Screen](#).

18. MTS/S-mode button ▲Up

When you press this button, current audio mode is displayed on the lower left corner of the screen.(Only TV Screen)

	Audio Type	MTS/S_Mode	Default
FM Stereo	Mono	Mono	Manual Change
	Stereo	Mono ↔ Stereo	
	SAP	Mono ↔ SAP	Mono

Adjusting Your LCD Monitor - User Controls

19. Caption button ▲Up

Turns on Closed Captioning service (in English). In some countries, Caption service is not available. You may turn on Closed Captioning service while viewing certain television programs in countries like the United States or a video tape with a "CC" marking.

Adjusting Your LCD Monitor - User Controls

 Direct-Access Features let you display Monitor Adjustment Menu by simply pressing Auto button once. Or they are used to adjust monitor functions. You need to activate functions other than Auto Adjustment only when Auto-Access Features are off.

[Automatic Save](#) | [OSD Lock/Unlock](#) | [Volume](#) | [Channel](#)

1. Automatic Save

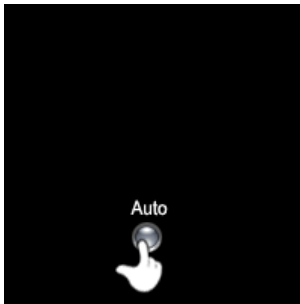

The monitor display becomes more stabilized if adjusted by Auto Adjustment functions when the monitor is installed for the first time. Try Auto Adjustment before attempting Manual Adjustment. Ensure the clock frequency of the monitor matches that of the computer video card before carrying out Auto Adjustment.

When the **Auto** button is pressed, the monitor screen turns black and the Auto Adjustment screen appears as shown in the animated screen on the left.

 To make the automatic adjustment function sharper, execute the 'AUTO' function while the [AutoPattern.exe](#) is on.

2. OSD Lock/Unlock



This function allows you to secure the current settings so that they cannot be inadvertently changed.

With the OSD screen off, push and hold the Menu button for at least 5 seconds to lock or unlock the controls.

The following functions are available even while the OSD menu is locked.

- | | |
|---------------------------|---|
| 1. Control buttons | Source button(PC, PIP , Video, Audio mode button), Volume button, Channel button, Menu button, Exit button, Auto button |
| 2. PC Screen | Brightness, Contrast |
| 3. TV Screen | Channel, Volume |

With the OSD screen off, push and hold the Menu button for five or more seconds to unlock the OSD settings.

This function is activated by pressing the Menu button on the front panel of the monitor. (It is not available by pressing the Menu button on the remote controller.)

3. Volume

When OSD is not on the screen, push the VOL - ◀ / VOL ▶ + button to adjust volume.

1. Push the ◀ button to decrease the volume.
2. Push the ▶ button to increase the volume.



Adjusting Your LCD Monitor - User Controls

4. Channel

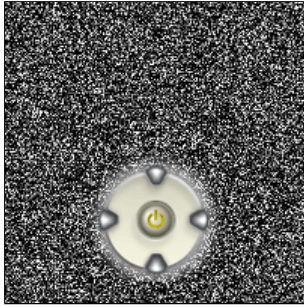

When OSD is not on the screen, push the ▲ + CH / ▼ - CH button to select channel number.

1. Push the ▼ button to decrease the channel number.
2. Push the ▲ button to increase the channel number.



This function is available in TV or PC + TV (PIP) mode only. You need to [connect a TV tuner box \(option\)](#) to make PC+TV mode appear in TV mode or PIP mode.

Adjusting Your LCD Monitor - On-Screen Display







SyncMaster 152MP

 Characters and icons become highlighted in blue during adjustment for each menu.

1. PC Screen

 For detailed information on Screen Adjustment in the PC mode, refer to [PC Screen Adjustment Animation Clips](#).



	<p>Contrast Adjust Contrast.</p>
	<p>Brightness Adjust Brightness.</p>
	<p>Color Control The tone of color can be changed from redish white to bluish white. The individual color components are also user customizable.</p> <ol style="list-style-type: none"> 1) Mode 1: Plain white. 2) Mode 2: Reddish white. 3) Mode 3: Bluish white. 4) User mode: User customizable. 5) Reset: Color parameters are replaced with the factory default values.
	<p>Image This menu includes Image Lock and Image Effect as its sub-menu.</p> <ol style="list-style-type: none"> 1) Image Lock: Image Lock is used to fine tune and get the best image by removing noises that creates unstable images with jitters and shimmers. If satisfactory results are not obtained using the Fine adjustment, use the Coarse adjustment and then use Fine again. <ul style="list-style-type: none"> • Coarse: Removes noise such as vertical stripes. Coarse adjustment may move the screen image area. You may relocate it to the center using the Horizontal Control menu. • Fine: Removes noise such as horizontal stripes. If the noise persists even after Fine tuning, repeat it after adjusting the frequency (clock speed). • Information: Display current display mode. • Reset: Image lock and position parameters are replaced with the factory default values. 2) Image Effect: Image being displayed can be made softer or sharper.
	<p>Position This adjusts the screen location horizontally and vertically.</p>
	<p>Sound The monitor has a built-in high fidelity stereo audio amplifier.</p> <ul style="list-style-type: none"> • Mode <ol style="list-style-type: none"> 1) Custom : Choose Custom to recall your personalized settings. <ul style="list-style-type: none"> - Bass: Emphasize low frequency audio. - Treble: Emphasize high frequency audio. 2) Standard: Choose Standard for the standard factory settings. 3) Music: Choose Music when watching music videos or concerts. 4) Movie: Choose Movie when watching movies. 5) Speech: Choose Speech when watching a show that is mostly dialogue (i.e., news).
	<p>PIP When external A/V devices such as VCR are connected to the monitor, PIP allows you to watch video from such devices in a small window super-imposed on pc video signal.</p> <ol style="list-style-type: none"> 1) Size: Adjusts the PIP Screen Size 2) Position: Change PIP window position.

Adjusting Your LCD Monitor - On-Screen Display



SyncMaster 152MP

2. TV Screen

 For detailed information on Screen Adjustment in TV mode, refer to [TV Screen Adjustment Animation Clips](#). Screen Adjustment in TV mode does not affect the PC screen at all.

You can use this function only if your monitor is [connected to a TV tuner box \(option\)](#).
If the [video adjustment icon](#) is shown on the screen, your TV tuner box has not been properly connected to the monitor.







	<p>Picture Controls Contrast, Brightness, Sharpness, Color and Tint of the TV image.</p> <p>1) Mode</p> <ul style="list-style-type: none"> • Custom : Choose Custom to recall your personalized settings. <ul style="list-style-type: none"> - Contrast : Adjust the contrast of TV without affecting PC RGB's contrast. - Brightness : Adjust the brightness of TV without affecting PC RGB's brightness. - Sharpness : Adjust the sharpness of TV image. - Color : Change the richness of color. - Tint : Change the tone of color. • Dynamic : Choose Dynamic for viewing the TV during the day or when there is bright- light in the room. • Standard : Choose Standard for the standard factory settings. • Movie : Choose Movie when viewing the movie. <p>2) Color tone</p> <ul style="list-style-type: none"> • Normal • Warm 1 • Warm 2 • Cool 1 • Cool 2
	<p>Sound The monitor has a built-in high fidelity stereo audio amplifier.</p> <p>1) Mode</p> <ul style="list-style-type: none"> • Custom : Choose Custom to recall your personalized settings. <ul style="list-style-type: none"> - Bass : Emphasize low frequency audio. - Treble : Emphasize high frequency audio. • Standard : Choose Standard for the standard factory settings. • Music : Choose Music when watching music videos or concerts. • Movie : Choose Movie when watching movies. • Speech : Choose Speech when watching a show that is mostly dialogue (i.e., news). <p>2) MTS (Multichannel Television Stereo)</p> <ul style="list-style-type: none"> • Stereo • Mono • SAP(Separate Audio Program)

Adjusting Your LCD Monitor - On-Screen Display

SyncMaster 152MP

2. TV Screen



	<p>Channel</p> <p>The channel system can be set in several different ways.</p> <p>1) ANT / CATV Select a channel system that is being used in your region.</p> <ul style="list-style-type: none"> • STD • HRC • IRC • ANT (antenna) <p>STD, HRC and IRC identify various types of cable TV systems. Contact your local cable company to identify the type of cable system that exists in your particular area.</p> <p>2) Auto program The TV automatically cycles through all of the available channels and stores them in memory. This takes about one to two minutes. In rare cases, "Auto program" may miss a couple of channels due to weak signals or for other reasons such as a channel does not exist when "Auto program" is executed.</p> <p>3) Fine Tune Due to weak signals or an incorrect antenna configuration, some of the channels may not be tuned correctly.</p> <p>4) Add/Erase Adds or erases channels from the memory.</p> <p>5) LNA (Low Noise Amplifier) Amplifies signals when antenna reception is poor. However if incoming signals are interfering with each other, turn off LNA as it may malfunction.</p>
	<p>Size</p> <p>1) Normal Sets the picture to 4:3 normal mode(This is the standard TV screen size.)</p> <p>2) Wide Sets the picture to 16:9 wide mode.</p> <p>This feature does not work in PIP mode.</p>
	<p>Sleep Timer Automatically shuts off the screen at a pre-programmed time (30 min., 60 min., 120 min.)</p>
	<p>Caption Enable or disable caption feature and set the appearance of caption text.</p>
	<p>V - Chip (more information) Protects children from viewing inappropriate programs by blocking certain broadcast or video programs.</p>

Adjusting Your LCD Monitor - On-Screen Display







SyncMaster 152MP

3. Video Screen

 For detailed information on Screen Adjustment in the Video mode, refer to [Video Screen Adjustment Animation Clips](#). Screen Adjustment in the Video mode does not affect the PC screen at all.

You can use this function only if your monitor is not connected to a TV tuner box.



	<p>Picture Controls Contrast, Brightness, Sharpness, Color and Tint of the Video image.</p> <p>1) Mode</p> <ul style="list-style-type: none"> • Custom : Choose Custom to recall your personalized settings. <ul style="list-style-type: none"> - Contrast : Adjust the contrast of Video without affecting PC RGB's contrast. - Brightness : Adjust the brightness of Video without affecting PC RGB's brightness. - Sharpness : Adjust the sharpness of Video image. - Color : Change the richness of color. - Tint : Change the tone of color. • Dynamic : Choose Dynamic for viewing the Video during the day or when there is bright- light in the room. • Standard : Choose Standard for the standard factory settings. • Movie : Choose Movie when viewing the movie. <p>2) Color tone</p> <ul style="list-style-type: none"> • Normal • Warm 1 • Warm 2 • Cool 1 • Cool 2
	<p>Sound The monitor has a built-in high fidelity stereo audio amplifier.</p> <p>1) Mode</p> <ul style="list-style-type: none"> • Custom : Choose Custom to recall your personalized settings. <ul style="list-style-type: none"> - Bass : Emphasize low frequency audio. - Treble : Emphasize high frequency audio. • Standard : Choose Standard for the standard factory settings. • Music : Choose Music when watching music videos or concerts. • Movie : Choose Movie when watching movies. • Speech : Choose Speech when watching a show that is mostly dialogue (i.e., news). <p>2) MTS(Multichannel Television Stereo)</p> <ul style="list-style-type: none"> • Stereo • Mono • SAP(Separate Audio Program)
	<p>Size</p> <p>1) Normal Sets the picture to 4:3 normal mode(This is the standard TV screen size.)</p> <p>2) Wide Sets the picture to 16:9 wide mode.</p>
	<p>Sleep Timer Automatically shuts off the screen at a pre-programmed time (30 min., 60 min., 120 min.)</p>
	<p>Caption Enable or disable caption feature and set the appearance of caption text.</p>
	<p>V - Chip (more information) Protects children from viewing inappropriate programs by blocking certain broadcast or video programs.</p>







Adjusting Your LCD Monitor - On-Screen Display

SyncMaster 152MP

4. DTV / DVD(Component) Control

 See [Screen Adjustment Animation Clips in DTV mode](#) for detailed instructions on how to adjust the screen in DTV mode. Adjusting the screen in DTV/DVD mode does not affect the image on your PC screen.







	Contrast Adjusts the contrast of the image on the screen.
	Brightness Adjusts the brightness of the image on the screen.
	Sound The monitor has a built-in high fidelity stereo audio amplifier. • Mode <ol style="list-style-type: none"> 1) Custom: Choose Custom to recall your personalized settings. <ul style="list-style-type: none"> - Bass: Emphasize low frequency audio. - Treble: Emphasize high frequency audio. 2) Standard: Choose Standard for the standard factory settings. 3) Music: Choose Music when watching music videos or concerts. 4) Movie: Choose Movie when watching movies. 5) Speech: Choose Speech when watching a show that is mostly dialogue (i.e., news).
	Color Change the richness of color.
	Size You can switch the image size between 16:9 and Full aspect ratios.
	Position This adjusts the screen location horizontally and vertically.

5. OSD Control

 Press the Exit button to make the menu disappear. The adjustments made are saved automatically as the menu screen disappears. The OSD (On-Screen Display) feature may not function properly depending on input signals.
For detailed information on screen adjustment functions, refer to [OSD Screen Adjustment Animation Clips](#).



	Language You can choose one of 4 languages. (English, Spanish, French, Portuguese)
	Position Move the OSD Window to the vertical and horizontal direction.
	Halftone Change the opaqueness of the background of the OSD.
	Duration The number of seconds that the OSD will remain visible before disappearing.
	Beep Press Beep to turn the beeping sound on/off when you press buttons.

Adjusting Your LCD Monitor - On-Screen Display







SyncMaster 172MP

 Characters and icons become highlighted in blue during adjustment for each menu.

1. PC Screen

 For detailed information on Screen Adjustment in the PC mode, refer to [PC Screen Adjustment Animation Clips](#).



	<p>Contrast Adjust Contrast.</p>
	<p>Brightness Adjust Brightness.</p>
	<p>Color Control The tone of color can be changed from reddish white to bluish white. The individual color components are also user customizable.</p> <p>1) Mode 1: Plain white. 2) Mode 2: Reddish white. 3) Mode 3: Bluish white. 4) User mode: User customizable. 5) Reset: Color parameters are replaced with the factory default values.</p>
	<p>Image This menu includes Image Lock and Image Effect as its sub-menu.</p> <p>1) Image Lock: Image Lock is used to fine tune and get the best image by removing noises that creates unstable images with jitters and shimmers. If satisfactory results are not obtained using the Fine adjustment, use the Coarse adjustment and then use Fine again.</p> <ul style="list-style-type: none"> • Coarse: Removes noise such as vertical stripes. Coarse adjustment may move the screen image area. You may relocate it to the center using the Horizontal Control menu. • Fine: Removes noise such as horizontal stripes. If the noise persists even after Fine tuning, repeat it after adjusting the frequency (clock speed). • Information: Display current display mode. • Reset: Image lock and position parameters are replaced with the factory default values. <p>2) Image Effect: Image being displayed can be made softer or sharper.</p>
	<p>Position This adjusts the screen location horizontally and vertically.</p>
	<p>Sound The monitor has a built-in high fidelity stereo audio amplifier.</p> <ul style="list-style-type: none"> • Mode <ol style="list-style-type: none"> 1) Custom : Choose Custom to recall your personalized settings. <ul style="list-style-type: none"> - Bass: Emphasize low frequency audio. - Treble: Emphasize high frequency audio. 2) Standard: Choose Standard for the standard factory settings. 3) Music: Choose Music when watching music videos or concerts. 4) Movie: Choose Movie when watching movies. 5) Speech: Choose Speech when watching a show that is mostly dialogue (i.e., news).
	<p>PIP When external A/V devices such as VCR are connected to the monitor, PIP allows you to watch video from such devices in a small window super-imposed on pc video signal.</p> <p>1) Size: Adjusts the PIP Screen Size</p> <p>2) Position: Change PIP window position.</p>

Adjusting Your LCD Monitor - On-Screen Display



SyncMaster 172MP

2. TV Screen

 For detailed information on Screen Adjustment in TV mode, refer to [TV Screen Adjustment Animation Clips](#). Screen Adjustment in TV mode does not affect the PC screen at all.

You can use this function only if your monitor is [connected to a TV tuner box \(option\)](#).
If the [video adjustment icon](#) is shown on the screen, your TV tuner box has not been properly connected to the monitor.







	<p>Picture Controls Contrast, Brightness, Sharpness, Color and Tint of the TV image.</p> <p>1) Mode</p> <ul style="list-style-type: none"> • Custom : Choose Custom to recall your personalized settings. <ul style="list-style-type: none"> - Contrast : Adjust the contrast of TV without affecting PC RGB's contrast. - Brightness : Adjust the brightness of TV without affecting PC RGB's brightness. - Sharpness : Adjust the sharpness of TV image. - Color : Change the richness of color. - Tint : Change the tone of color. • Dynamic : Choose Dynamic for viewing the TV during the day or when there is bright- light in the room. • Standard : Choose Standard for the standard factory settings. • Movie : Choose Movie when viewing the movie. <p>2) Mode</p> <ul style="list-style-type: none"> • Normal • Warm 1 • Warm 2 • Cool 1 • Cool 2
	<p>Sound The monitor has a built-in high fidelity stereo audio amplifier.</p> <p>1) Mode</p> <ul style="list-style-type: none"> • Custom : Choose Custom to recall your personalized settings. <ul style="list-style-type: none"> - Bass : Emphasize low frequency audio. - Treble : Emphasize high frequency audio. • Standard : Choose Standard for the standard factory settings. • Music : Choose Music when watching music videos or concerts. • Movie : Choose Movie when watching movies. • Speech : Choose Speech when watching a show that is mostly dialogue (i.e., news). <p>2) MTS(Multichannel Television Stereo)</p> <ul style="list-style-type: none"> • Stereo • Mono • SAP(Separate Audio Program)

Adjusting Your LCD Monitor - On-Screen Display

SyncMaster 172MP

2. TV Screen



	<p>Channel</p> <p>The channel system can be set in several different ways.</p> <p>1) ANT / CATV Select a channel system that is being used in your region.</p> <ul style="list-style-type: none"> • STD • HRC • IRC • ANT(antenna) <p>STD, HRC and IRC identify various types of cable TV systems. Contact your local cable company to identify the type of cable system that exists in your particular area.</p> <p>2) Auto program The TV automatically cycles through all of the available channels and stores them in memory. This takes about one to two minutes. In rare cases, "Auto program" may miss a couple of channels due to weak signals or for other reasons such as a channel does not exist when "Auto program" is executed.</p> <p>3) Fine Tune Due to weak signals or an incorrect antenna configuration, some of the channels may not be tuned correctly.</p> <p>4) Add/Erase Adds or erases channels from the memory.</p> <p>5) LNA (Low Noise Amplifier) Amplifies signals when antenna reception is poor. However if incoming signals are interfering with each other, turn off LNA as it may malfunction.</p>
	<p>Size</p> <p>1) Normal Sets the picture to 4:3 normal mode(This is the standard TV screen size.)</p> <p>2) Wide Sets the picture to 16:9 wide mode.</p> <p>3) Zoom Magnifies the size of the picture on screen.</p> <p>This feature does not work in PIP mode.</p>
	<p>Sleep Timer Automatically shuts off the screen at a pre-programmed time (30 min., 60 min., 120 min.)</p>
	<p>Caption Enable or disable caption feature and set the appearance of caption text.</p>
	<p>V - Chip (more information) Protects children from viewing inappropriate programs by blocking certain broadcast or video programs.</p>

Adjusting Your LCD Monitor - On-Screen Display







SyncMaster 172MP

3. Video Screen

 For detailed information on Screen Adjustment in the Video mode, refer to [Video Screen Adjustment Animation Clips](#). Screen Adjustment in the Video mode does not affect the PC screen at all.

You can use this function only if your monitor is not connected to a TV tuner box.



	<p>Picture Controls Contrast, Brightness, Sharpness, Color and Tint of the Video image.</p> <p>1) Mode</p> <ul style="list-style-type: none"> • Custom : Choose Custom to recall your personalized settings. <ul style="list-style-type: none"> - Contrast : Adjust the contrast of Video without affecting PC RGB's contrast. - Brightness : Adjust the brightness of Video without affecting PC RGB's brightness. - Sharpness : Adjust the sharpness of Video image. - Color : Change the richness of color. - Tint : Change the tone of color. • Dynamic : Choose Dynamic for viewing the Video during the day or when there is bright- light in the room. • Standard : Choose Standard for the standard factory settings. • Movie : Choose Movie when viewing the movie. <p>2) Mode</p> <ul style="list-style-type: none"> • Normal • Warm 1 • Warm 2 • Cool 1 • Cool 2
	<p>Sound The monitor has a built-in high fidelity stereo audio amplifier.</p> <p>1) Mode</p> <ul style="list-style-type: none"> • Custom : Choose Custom to recall your personalized settings. : <ul style="list-style-type: none"> - Bass : Emphasize low frequency audio. - Treble : Emphasize high frequency audio. • Standard : Choose Standard for the standard factory settings. • Music : Choose Music when watching music videos or concerts. • Movie : Choose Movie when watching movies. • Speech : Choose Speech when watching a show that is mostly dialogue (i.e., news). <p>2) MTS(Multichannel Television Stereo)</p> <ul style="list-style-type: none"> • Stereo • Mono • SAP(Separate Audio Program)
	<p>Size</p> <p>1) Normal Sets the picture to 4:3 normal mode(This is the standard TV screen size.)</p> <p>2) Wide Sets the picture to 16:9 wide mode.</p> <p>3) Zoom Magnifies the size of the picture on screen.</p> <p>This feature does not work in PIP mode.</p>
	<p>Sleep Timer Automatically shuts off the screen at a pre-programmed time (30 min., 60 min., 120 min.)</p>
	<p>Caption Enable or disable caption feature and set the appearance of caption text.</p>
	<p>V - Chip (more information) Protects children from viewing inappropriate programs by blocking certain broadcast or video programs.</p>







Adjusting Your LCD Monitor - On-Screen Display

SyncMaster 172MP

4. DTV / DVD(Component) Control

 See [Screen Adjustment Animation Clips in DTV mode](#) for detailed instructions on how to adjust the screen in DTV mode. Adjusting the screen in DTV mode does not affect the image on your PC screen.







	Contrast Adjusts the contrast of the image on the screen.
	Brightness Adjusts the brightness of the image on the screen.
	Sound The monitor has a built-in high fidelity stereo audio amplifier. • Mode 1) Custom: Choose Custom to recall your personalized settings. - Bass: Emphasize low frequency audio. - Treble: Emphasize high frequency audio. 2) Standard: Choose Standard for the standard factory settings. 3) Music: Choose Music when watching music videos or concerts. 4) Movie: Choose Movie when watching movies. 5) Speech: Choose Speech when watching a show that is mostly dialogue (i.e., news).
	Color Change the richness of color.
	Size You can switch the image size between 16:9 and Full aspect ratios.
	Position This adjusts the screen location horizontally and vertically.

5. OSD Control

 Press the Exit button to make the menu disappear. The adjustments made are saved automatically as the menu screen disappears. The OSD (On-Screen Display) feature may not function properly depending on input signals.
For detailed information on screen adjustment functions, refer to [OSD Screen Adjustment Animation Clips](#).



	Language You can choose one of 4 languages. (English, Spanish, French, Portuguese)
	Position Move the OSD Window to the vertical and horizontal direction.
	Halftone Change the opaqueness of the background of the OSD.
	Duration The number of seconds that the OSD will remain visible before disappearing.
	Beep Press Beep to turn the beeping sound on/off when you press buttons.

Troubleshooting - Check before Calling for Service

 Check the following items yourself before calling for service. Contact the [service center](#) for problems that you cannot solve by yourself.

[Self-Test Feature Check](#) | [Video mode not supported](#) | [Display Adapter Driver](#) | [Maintenance and Cleaning](#) | [Symptoms & Recommended Actions](#)

1. Self-Test Feature Check

Your monitor provides a self test feature that allows you to check whether your monitor is functioning properly.

1. Turn off both your computer and the monitor.
2. Unplug the video cable from the back of the computer.
3. Turn on the monitor.

The figure shown below ("Check Signal Cable") appears on a black background when the monitor is in its normal working condition though it does not sense any video signal: While in the Self-Test mode, the LED power indicator remains green and the figure moves around on the screen.





Failure of any of the boxes to appear indicates a problem with your monitor. This box also appears during normal operation if the video cable becomes disconnected or damaged.

4. Turn off your monitor and reconnect the video cable; then turn on both your computer and the monitor.

If your monitor screen remains blank after using the previous procedure, check your video controller and computer system; **your monitor is functioning properly.**

2. Video mode not supported

This indicates the display resolution or refresh rate is not properly set on your computer video card. Reboot the computer in Safe Mode and select "Default" in the "Refresh Rate Unknown" box while setting Adapter for Display Properties.

-  **Contact the computer dealer or manufacturer for information on Safe Mode Booting.**
-  Refer to Specifications > [Preset Timing Modes](#) for the resolutions or frequencies that are supported by the monitor.

Sometimes the screen turns black without the "Video mode not supported" message appearing on the screen. This indicates the monitor is set for a frequency out of range or the PowerSaver mode is on.

Troubleshooting - Check before Calling for Service

3. Display Adapter Driver

 Display adapter refers to the computer video card driver. If the adapter is not properly set, you cannot adjust resolution, frequency or color and you cannot install the monitor driver.

1. Checking Adapter Driver

Click Start → Settings → Control Panel → Display → Settings → Advanced → Adapter.

If "Default" or a wrong product model is indicated, it means that the adapter driver is not properly installed. Install the adapter driver again according to the information provided by the computer or

video card manufacturers.

2. Installing Adapter Driver

 The instructions given below are for general circumstances. For specific issues, contact the relevant computer or video card manufacturers.

- 1) Click Start → Settings → Control Panel → Display → Settings → Advanced → Adapter → Update Driver → Next → Display a list of the known drivers for this device so that I can choose a specific driver → Next → Have Disk (Insert Video Card Driver diskette) → OK → Next → Next → Finish.
- 2) In case you have Adapter Driver Setup file on your computer:
Run Setup.exe or Install.exe, which is found in the Adapter Driver Setup file.

4. Maintenance and Cleaning

1. Maintaining the Monitor Case

Clean with a soft cloth after disconnecting the power cord.



- Do not use benzene, thinner or other flammable substances, or a wet cloth.
- We recommend a Samsung cleansing agent is used to prevent damage to the screen.

2. Maintaining the Flat Panel Display Screen

Clean with a soft cloth (cotton flannel) smoothly.



- Never use acetone, benzene or thinner.
(They may cause flaws or deformation of the screen surface.)
- The user will be required to pay costs and related expenses for repair of damages caused by him/her.

Troubleshooting - Check before Calling for Service

5. Symptoms and Recommended Actions



A monitor recreates visual signals received from the computer. Therefore, if there is trouble with the computer or the video card, this can cause the monitor to become blank, have poor coloring, noise, Video mode not supported, etc. In this case, first check the source of the problem, and then contact a [service center or your dealer](#).

1. Check if the power cord and the video cables are properly connected to the computer.
2. Check if the computer beeps more than 3 times when booting.
(If it does, request an after-service for the main board of the computer.)
3. If you installed a new video card or if you assembled the PC, check if you installed the adapter (video) driver and the monitor driver.
4. Check if the scanning ratio of the video screen is set at 75Hz or 85Hz.
(Do not exceed 60Hz when using the maximum resolution.)
5. If you have problems in installing the adapter (video) driver, boot the computer in Safe Mode, remove the Display Adapter at the "**Control Panel, System, Device Administrator**" and then reboot the computer to reinstall the adapter (video) driver.

Troubleshooting - Problems and Solutions

 The following table lists possible problems and their solutions. Before calling for service, check the information in this section to see if you can remedy any problems yourself. If you do need assistance, please call, [the phone number on the Information section](#) or [contact your dealer](#).

[Installation](#) | [Screen](#) | [Audio](#) | [Remote Control](#)

1. Problems related to Installation

 Problems related to the monitor installation and their solutions are listed.

Problems	Solutions
It appears the PC does not function normally.	<ul style="list-style-type: none"> Check if the Display Adapter Driver (VGA Driver) is properly installed. (Refer to Installing Driver)
The monitor screen flickers.	<ul style="list-style-type: none"> Check if the signal cable between the computer and the monitor is securely connected and tightened. (Refer to Connecting to a Computer)
TV screen is blurred or shows noise signals.	<ul style="list-style-type: none"> Check if the TV antenna connector is securely connected to the external antenna. (Refer to Connecting to TV)
TV signal is not received	<ul style="list-style-type: none"> Check "Channel system" and make sure you choose the correct channel system. (Refer to the Channel System) Select "Channel auto program" to configure the channel system automatically. (Refer to the Channel System)
Strange characters appear on the screen.	<ul style="list-style-type: none"> Switch "Caption On" to "Caption Off" if strange characters appear on the TV screen. (Refer to Caption)

Troubleshooting - Problems and Solutions

2. Problems related to Screen

 Problems related to the monitor screen and their solutions are listed.

Problems	Solutions
Screen is blank and power indicator is off	<ul style="list-style-type: none"> Ensure that the power cord is firmly connected and the LCD monitor is on. (Refer to the Connecting Your Monitor)
"Check Signal Cable" message	<ul style="list-style-type: none"> Ensure that the signal cable is firmly connected to the PC or video sources. (Refer to the Connecting Your Monitor) Ensure that the PC or video sources are turned on.
"Video mode not supported" message	<ul style="list-style-type: none"> Check the maximum resolution and the frequency of the video adaptor. Compare these values with the data in the Preset Timing Modes Chart.
Picture rolls vertically.	<ul style="list-style-type: none"> Check if the signal cable is securely connected. Connect it again securely. (Refer to Connecting to a Computer)
Image is not clear. Picture is blurred.	<ul style="list-style-type: none"> Run Frequency Coarse and Fine tuning. Turn on again after removing all accessories (video extension cable, etc.) Set resolution and frequency to the recommended ranges. 15 inch model (1024 x 768 @ 60Hz), 17 inch model (1280 x 1024 @ 60Hz)
Picture image is unstable and vibrates.	<ul style="list-style-type: none"> Check if the resolution and frequency set for the computer video card falls in the range supported by the monitor. If not, reset them referring to the current Information under the monitor menu and Preset Timing Modes.
Ghost images are shown in the picture.	
The image is too light or too dark	<ul style="list-style-type: none"> Adjust the Brightness and Contrast. (Refer to the Brightness, Contrast)
Screen color is inconsistent.	<ul style="list-style-type: none"> Adjust color using User Mode under OSD Color Adjustment menu.
Color image is distorted with dark shadows.	
White color is poor.	
Power Indicator blinks green.	<ul style="list-style-type: none"> The monitor is currently saving the changes made in settings to the OSD memory.
Screen is blank and power indicator light is steady green or blinks every 0.5 or 1 seconds	<ul style="list-style-type: none"> The monitor is using its power management system. press a key on the keyboard
The monitor front control buttons do not respond.	<ul style="list-style-type: none"> Check if OSD Lock/Unlock is on by pressing Menu button. If the problem persists, contact the service center.

Troubleshooting - Problems and Solutions

3. Problems related to Audio

 Problems related to audio signals and their solutions are listed below.

Problems	Solutions
No sound	<ul style="list-style-type: none"> • Ensure that the audio cable is firmly connected to both the audio-in port on your monitor and the audio-out port on your sound card. (Refer to the Connecting Your Monitor) • Check the volume level. (Refer to the Volume)
Sound level is too low.	<ul style="list-style-type: none"> • Check the volume level. (Refer to the Volume) • If the volume is still too low after turning the control to its maximum, check the volume control on the computer sound card or software program.
Sound is too high pitched or too low pitched	<ul style="list-style-type: none"> • Adjust the Treble and Bass to appropriate level.

4. Problems related to Remote Control

 Problems related to the remote control and their solutions are listed.

Problems	Items to check
The remote control buttons do not respond.	<ul style="list-style-type: none"> • Check the battery polarities (+/-). • Check if the batteries have been exhausted. • Check if the power is on. • Check if the power cord is securely connected. • Check if a special fluorescent or neon lamp is on in the vicinity.

Troubleshooting - Q & A

 Frequently asked questions are summarized here for your reference.

Question	Answer
How can I change the frequency?	<p>Frequency can be changed by reconfiguring the video card.</p> <p>Note that video card support can vary, depending on the version of the driver used. (Refer to the computer or the video card manual for details.)</p>
How can I adjust the resolution?	<p>Windows XP: Reset resolution by clicking Control Panel → Appearance & Theme → Display → Settings.</p> <p>Windows ME/2000: Set the resolution at the Control Panel → Display → Settings.</p> <p>* Contact the video card manufacturer for details.</p>
How can I set the Power Saving function?	<p>Windows XP: Reset Power Saving parameters by clicking Control Panel → Appearance & Theme → Display → Screen Saver or in the computer BIOS SETUP. (Refer to Windows/Computer Manual)</p> <p>Windows ME/2000: Set the function at BIOS-SETUP of the computer or the screen saver. (Refer to Windows/Computer Manual).</p>
How can I clean the outer case/LCD Panel?	<p>Disconnect the power cord and then clean the monitor with a soft cloth, using either a cleaning solution or plain water.</p> <p>Do not leave any remains of the detergent nor scratch the case. Do not allow any water to go inside the monitor.</p>

Specifications - General Specifications

SyncMaster 152MP

 Design and specifications are subject to change without prior notice.

General	
Model Name	SyncMaster 152MP
LCD Panel	
Size	15.0 inch (Diagonal)
Display area	304.128 (H) x 228.056 (V)
Pixel Pitch	0.297 (H) x 0.297 (V)
Type	a-si TFT active matrix
Viewing Angle	140(H) / 120 (V)
Synchronization	
Horizontal	30 ~ 60 kHz
Vertical	56 ~ 75 Hz
Display Color	
16,194,277 Colors	
Resolution	
Optimum resolution	1024 x 768@60Hz
Maximum resolution	1024 x 768@75Hz
Input Signal, Terminated	
RGB Analog, Composite H/V Sync, 0.7Vp-p Positive at 75 ohm, Separate H/ V sync, TTL level positive or negative	
TV / Video	
Color system	NTSC, PAL
Sound system	M
Video format	CVBS, S-VHS
DTV(Component)	
DVD	Composite Sync 480i, 480p
YPbPr	Composite Sync 1080i, 720p, 480p, 480i
Video signal	0.7 Vp-p @ 75 ohm
Maximum Pixel Clock	
80 MHz	
Power Supply	
90 to 264 VAC, 60/50Hz ± 3Hz	
Signal Cable	
15pin to 15pin D-sub cable, Detachable	
Power Consumption	
Less than 48.0 W	
Power Saving	
Less than 2W	
Dimensions / Weight (WxDxH)	
358.6 x 175.5 x 361.5 mm (When Stand is not foleded)	
358.6 x 51.0 x 402.6 mm (When Stand is foled)	
358.6 x 51.0 x 350.6 mm / 3.45 kg (Without stand)	

Specifications - General Specifications

SyncMaster 152MP

VESA Mounting Interface	
75mm x 75mm (for use with Specialty(Arm) Mounting hardware.)	
Environmental considerations	
Operating	Temperature : 50°F ~ 104°F(10°C ~ 40°C) Humidity : 10% ~ 80%, non-condensing
Storage	Temperature : -4°F ~ 113°F (-20°C ~ 45°C) Humidity : 5% ~ 95%, non-condensing
Plug and Play Capability	
This monitor can be installed on any Plug & Play compatible system. Interaction of the monitor and computer systems will provide the best operating conditions and monitor settings. In most cases, monitor installation will proceed automatically, unless the user wishes to select alternate settings.	
Dot Acceptable	
TFT LCD panel manufactured by using advanced semiconductor technology with precision of 99.999% above is used for this product. But the pixels of RED, GREEN, BLUE and WHITE color seem to be bright sometimes or some of black pixels could be seen. This is not from bad quality and you can use it without uneasiness.	
The number of TFT LCD pixels :	<ul style="list-style-type: none"> • 15 inch: 2,359,296 • 17 inch: 3,932,160 • 18 inch: 3,932,160 • 21 inch: 5,760,000 • 24 inch: 6,912,000

Specifications - PowerSaver

SyncMaster 152MP



This monitor has a built-in power management system called PowerSaver. This system saves energy by switching your monitor into a low-power mode when it has not been used for a certain amount of time. The monitor automatically returns to normal operation when you press a key on the keyboard. For energy conservation, turn your monitor OFF when it is not needed, or when leaving it unattended for long periods. The PowerSaver system operates with a VESA DPMS compliant video card installed in your computer. Use a software utility installed on your computer to set up this feature.

State	Normal Operation	Power saving mode EPA/ENERGY 2000	Power off (120 Vac)
Power Indicator	Green	Green, Blinking	Black
Power Consumption	Less than 48.0W	Less than 2W	2W



This monitor is EPA ENERGY STAR® compliant and ENERGY2000 compliant when used with a computer equipped with VESA DPMS functionality. As an ENERGY STAR® Partner, SAMSUNG has determined that this product meets the ENERGY STAR® guidelines for energy efficiency.

Specifications - Preset Timing Modes

SyncMaster 152MP



If the signal transferred from the computer is the same as the following Preset Timing Modes, the screen will be adjusted automatically. However, if the signal differs, the screen may go blank while the power LED is on. Refer to the video card manual and adjust the screen as follows.

Table 1. Preset Timing Modes

Display Mode	Horizontal Frequency (kHz)	Vertical Frequency (Hz)	Pixel Clock (MHz)	Sync Polarity (H/V)
MAC, 640 x 480	35.000	66.667	30.240	-/-
MAC, 832 x 624	49.726	74.551	57.284	-/-
IBM, 640 x 350	31.469	70.086	25.175	+/-
IBM, 640 x 480	31.469	59.940	25.175	-/-
IBM, 720 x 400	31.469	70.087	28.322	-/+
VESA, 640 x 480	37.500	75.000	31.500	-/-
VESA, 640 x 480	37.861	72.809	31.500	-/-
VESA, 800 x 600	35.156	56.250	36.000	+,-/+,-
VESA, 800 x 600	37.879	60.317	40.000	+/+
VESA, 800 x 600	46.875	75.000	43.500	+/+
VESA, 800 x 600	48.077	72.188	50.000	+/+
VESA, 1024 x 768	48.363	60.004	65.000	-/-
VESA, 1024 x 768	56.476	70.069	75.000	-/-
VESA, 1024 x 768	60.023	75.029	78.750	+/+

Table 2. NTSC Broadcasting Systems

Color System	Sound System	Stereo System	Channel System	Countries
NTSC	M	A2	US	Korea
		BTSC (SAP)	US	USA, Canada, Chile, Venezuela, Cuba, Colombia, Jamaica, Mexico, Panama, Peru, Philippines, Puerto-Rico, Taiwan
		EIAJ	Japan	Japan



Horizontal Frequency

The time to scan one line connecting the right edge to the left edge of the screen horizontally is called Horizontal Cycle and the inverse number of the Horizontal Cycle is called Horizontal Frequency. Unit: kHz

Vertical Frequency

Like a fluorescent lamp, the screen has to repeat the same image many times per second to display an image to the user. The frequency of this repetition is called Vertical Frequency or Refresh Rate. Unit: Hz

Specifications - General Specifications

SyncMaster 172MP

 Design and specifications are subject to change without prior notice.

General	
Model Name	SyncMaster 172MP
LCD Panel	
Size	17.0 inch (diagonal)
Display area	337.92 (H) x 270.336 (V)
Pixel Pitch	0.264 (H) x 0.264 (V)
Type	a-si TFT active matrix
Viewing Angle	170 (H) / 170 (V)
Synchronization	
Horizontal	31 ~ 81 kHz
Vertical	56 ~ 75 Hz
Display Color	
16,194,277 Colors	
Resolution	
Optimum resolution	1024 x 768@60Hz
Maximum resolution	1024 x 768@75Hz
Input Signal, Terminated	
RGB Analog, Composite H/V Sync, 0.7Vp-p Positive at 75 ohm, Separate H/ V sync, TTL level positive or negative	
TV / Video	
Color system	NTSC, PAL
Sound system	M
Video format	CVBS, S-VHS
DTV(Component)	
DVD	Composite Sync 480i, 480p
YPbPr	Composite Sync 1080i, 720p, 480p, 480i
Video signal	0.7 Vp-p @ 75 ohm
Maximum Pixel Clock	
135 MHz	
Power Supply	
90 to 264 VAC, 60/50Hz ± 3Hz	
Signal Cable	
15pin to 15pin D-sub cable, Detachable	
Power Consumption	
Less than 58.0 W	
Power Saving	
Less than 2W	
Dimensions / Weight (WxDxH)	
412.0 x 203.0 x 414.5 mm (When Stand is not foleded)	
412.0 x 58.5 x 472.0 mm (When Stand is foled)	
412.0 x 58.5 x 407.5 mm / 4.85kg (without foleded)	

Specifications - General Specifications

SyncMaster 172MP

VESA Mounting Interface	
75mm x 75mm (for use with Specialty(Arm) Mounting hardware.)	
Environmental considerations	
Operating	Temperature : 50°F ~ 104°F(10°C ~ 40°C) Humidity : 10% ~ 80%, non-condensing
Storage	Temperature : -4°F ~ 113°F (-20°C ~ 45°C) Humidity : 5% ~ 95%, non-condensing
Plug and Play Capability	
This monitor can be installed on any Plug & Play compatible system. Interaction of the monitor and computer systems will provide the best operating conditions and monitor settings. In most cases, monitor installation will proceed automatically, unless the user wishes to select alternate settings.	
Dot Acceptable	
TFT LCD panel manufactured by using advanced semiconductor technology with precision of 99.999% above is used for this product. But the pixels of RED, GREEN, BLUE and WHITE color seem to be bright sometimes or some of black pixels could be seen. This is not from bad quality and you can use it without uneasiness.	
The number of TFT LCD pixels :	<ul style="list-style-type: none"> • 15 inch: 2,359,296 • 17 inch: 3,932,160 • 18 inch: 3,932,160 • 21 inch: 5,760,000 • 24 inch: 6,912,000

Specifications - PowerSaver

SyncMaster 172MP

 This monitor has a built-in power management system called PowerSaver. This system saves energy by switching your monitor into a low-power mode when it has not been used for a certain amount of time. The monitor automatically returns to normal operation when you press a key on the keyboard. For energy conservation, turn your monitor OFF when it is not needed, or when leaving it unattended for long periods. The PowerSaver system operates with a VESA DPMS compliant video card installed in your computer. Use a software utility installed on your computer to set up this feature.

State	Normal Operation	Power saving mode EPA/ENERGY 2000	Power off (120 Vac)
Power Indicator	Green	Green, Blinking	Black
Power Consumption	Less than 48.0W	Less than 2W	2W



This monitor is EPA ENERGY STAR® compliant and ENERGY2000 compliant when used with a computer equipped with VESA DPMS functionality. As an ENERGY STAR® Partner, SAMSUNG has determined that this product meets the ENERGY STAR® guidelines for energy efficiency.

Specifications - Preset Timing Modes

SyncMaster 172MP



If the signal transferred from the computer is the same as the following Preset Timing Modes, the screen will be adjusted automatically. However, if the signal differs, the screen may go blank while the power LED is on. Refer to the video card manual and adjust the screen as follows.

Table 1. Preset Timing Modes

Display Mode	Horizontal Frequency (kHz)	Vertical Frequency (Hz)	Pixel Clock (MHz)	Sync Polarity (H/V)
MAC, 640 x 480	35.000	66.667	30.240	-/-
MAC, 832 x 624	49.726	74.551	57.284	-/-
IBM, 640 x 350	31.469	70.086	25.175	+/-
IBM, 640 x 480	31.469	59.940	25.175	-/-
IBM, 720 x 400	31.469	70.087	28.322	-/+
VESA, 640 x 480	37.500	75.000	31.500	-/-
VESA, 640 x 480	37.861	72.809	31.500	-/-
VESA, 800 x 600	35.156	56.250	36.000	+,-/+,-
VESA, 800 x 600	37.879	60.317	40.000	+/+
VESA, 800 x 600	46.875	75.000	43.500	+/+
VESA, 800 x 600	48.077	72.188	50.000	+/+
VESA, 1024 x 768	48.363	60.004	65.000	-/-
VESA, 1024 x 768	56.476	70.069	75.000	-/-
VESA, 1024 x 768	60.023	75.029	78.750	+/+
VESA, 1280 x 1024	63.981	60.020	108.00	+/+
VESA, 1280 x 1024	79.976	75.025	135.00	+/+
VESA, 1280 x 1024	81.129	76.106	135.00	-/-

Table 2. NTSC Broadcasting Systems

Color System	Sound System	Stereo System	Channel System	Countries
NTSC	M	A2	US	Korea
		BTSC (SAP)	US	USA, Canada, Chile, Venezuela, Cuba, Colombia, Jamaica, Mexico, Panama, Peru, Philippines, Puerto-Rico, Taiwan
		EIAJ	Japan	Japan



Horizontal Frequency

The time to scan one line connecting the right edge to the left edge of the screen horizontally is called Horizontal Cycle and the inverse number of the Horizontal Cycle is called Horizontal Frequency. Unit: kHz

Vertical Frequency

Like a fluorescent lamp, the screen has to repeat the same image many times per second to display an image to the user. The frequency of this repetition is called Vertical Frequency or Refresh Rate. Unit: Hz

Information - Service Center

- **AUSTRALIA :**
Samsung Electronics Australia Pty Ltd.
Customer Response Centre
7 Parkview Drive, Homebush Bay NSW 2127
Tel : 1300 362 603
<http://www.samsung.com.au/>
- **BRAZIL :**
Samsung Eletronica da Amazonia Ltda.
R. Prof. Manoelito de Ornellas, 303, Terro B
Chacara Sto. Antonio, CEP : 04719-040
Sao Paulo, SP
SAC : 0800 124 421
<http://www.samsung.com.br/>
- **CANADA :**
Samsung Electronics Canada Inc.
Samsung Customer Care
7037 Financial Drive
Mississauga, Ontario
L5N 6R3
1-800-SAMSUNG (1-800-726-7864)
<http://www.samsung.ca/>
- **CHILE :**
SONDA S.A.
Teatinos 550, Santiago Centro, Santiago, Chile
Fono: 56-2-5605000 Fax: 56-2-5605353
56-2-800200211
<http://www.sonda.com/>
<http://www.samsung.cl/>
- **COLOMBIA :**
Samsung Electronics Colombia
Cra 9 No 99A-02 Of. 106
Bogota, Colombia
Tel.: 9-800-112-112
Fax: (571) 618 - 2068
<http://www.samsung-latin.com/>
e-mail : soporte@samsung-latin.com
- **ESPAÑA :**
Samsung Electronics Comercial Iberica, S.A.
Ciencias, 55-65 (Poligono Pedrosa) 08908
Hospitalet de Llobregat (Barcelona)
Tel. : (93) 261 67 00
Fax. : (93) 261 67 50
<http://samsung.es/>
- **FRANCE :**
SAMSUNG ELECTRONICS FRANCE Service
Paris Nord 2
66 rue des Vanesses
BP 50116 Villepinte
95950 Roissy CDG Cedex
Tel : 08 25 08 65 65
Fax : 01 48 63 06 38
<http://www.samsungservices.com/>
- **GERMANY :**
TELEPLAN Rhein-Main GmbH
Feldstr. 16
64331 Weiterstadt
T. 06151/957-1306
F. 06151/957-1732
* EURO 0.12/Min
<http://www.samsung.de/>
- **HUNGARY :**
Samsung Electronics Magyar Rt.
1039, Budapest, Lehel u. 15-17.
Tel: 36 1 453 1100
Fax: 36 1 453 1101
<http://www.samsung.hu/>
- **ITALY :**
Samsung Electronics Italia S.p.a.
Via C. Donat Cattin, 5
20063 Cernusco s/Naviglio (MI)
Servizio Clienti: 199.153.153
<http://www.samsung-italia.com/>
- **MEXICO :**
SAMSUNG ELECTRONICS MEXICO. S.A. DE C.V.
Saturno NO.44, Col. Nueva Industrial Vallejo
Gustavo A.Madero C.P.07700, Mexico D.F. Mexico
TEL. 52-55-5747-5100
Fax. 52-55-47 52 02
RFC: SEM950215S98
<http://www.samsung.com.mx/>

IMPORTADO POR: SAMSUNG ELECTRONICS MEXICO. S.A. DE C.V.
Saturno NO.44, Col. Nueva Industrial Vallejo
Gustavo A.Madero C.P.07700, Mexico D.F. Mexico
TEL. 52-55-5747-5100

EXPORTADO POR: Samsung Electronics CO.,LTD.
416, Mae tan-3dong, Yeongtong-gu,
Suwon City, Kyongki-Do Korea
- **NETHERLANDS/BELGIUM/LUXEMBOURG :**
Samsung Electronics Benelux B. V.
Fleminglaan 12 2289 CP Rijiswijk, NEDERLANDS
Service and informatielijn ;
Belgium :0800-95214, <http://www.samsung.be/>
Netherlands : 0800-2295214, <http://www.samsung.nl/>
- **PANAMA :**
Samsung Electronics Latinoamerica(Z.L.) S.A.
Calle 50 Edificio Plaza Credicorp, Planta Baja
Panama
Tel. : (507) 210-1122, 210-1133
Tel : 800-3278(FAST)
<http://www.samsung-latin.com/>
- **PERU**
Servicio Integral Samsung
Av.Argentina 1790 Lima1. Peru
Tel: 51-1-336-8686
Fax: 51-1-336-8551
<http://www.samsungperu.com/>
- **PORTUGAL :**
SAMSUNG ELECTRONICA PORTUGUESA S.A.
Rua Mário Dioniso, Nº2 - 1º Dt. 2795-140 LINDA-A-VELHA
Tel. 214 148 114/100 Fax. 214 148 133/128
Free Line 800 220 120
<http://www.samsung.pt/>
- **SOUTH AFRICA :**
Samsung Electronics,5 Libertas Road, Somerset Office Park,
Bryanston Ext 16. Po Box 70006, Bryanston,2021, South Africa
Tel : 0027-11-549-1621
Fax : 0027-11-549-1629
<http://www.samsung.co.za/>
- **SWEDEN/DENMARK/NORWAY/FINLAND :**
Samsung Electronics AB
Box 713
S-194 27 UPPLANDS VÄSBY
SVERIGE
Besöksadress : Johanneslundsvägen 4
Samsung support Sverige: 020-46 46 46
Samsung support Danmark : 8088-4646
Samsung support Norge: 8001-1800
Samsung support Finland: 0800-118001
Tel +46 8 590 966 00
Fax +46 8 590 966 50
<http://www.samsung.se/>

Information - Service Center

- **THAILAND :**
HAI SAMSUNG SERVICE CENTER
MPA COMPLEX BUILDING, 1st-2nd Floor
175 SOI SUEKSA VIDHAYA SATHON SOI 12
SILOM ROAD ,SILOM,BANGRAK
BANGKOK 10500
TEL : 0-2635-2567
FAX : 0-2635-2556

- **UKRAINE :**
SAMSUNG ELECTRONICS REPRESENTATIVE OFFICE IN UKRAINE
4 Glybochitska str.
Kiev, Ukraine

Tel. 8-044-4906878
Fax 8-044-4906887
Toll-free 8-800-502-0000
<http://www.samsung.com.ua/>

- **United Kingdom :**
Samsung Electronics (UK) Ltd.
Samsung House, 225 Hook Rise South
Surbiton, Surrey KT6 7LD
Tel. : (0208) 391 0168
Fax. : (0208) 397 9949
< European Service Center & National Service >
Stafford Park 12 Telford, Shropshire, TF3 3BJ
Tel. : (0870) 242 0303
Fax. : (01952) 292 033
<http://samsungservice.co.uk/>

- **U.S.A. :**
Samsung Electronics America
Service Division
400 Valley Road, Suite 201
Mount Arlington, NJ 07856
1-800-SAMSUNG (1-800-726-7864)
<http://samsungusa.com>

Information - Terms

■ Sync Signal

Sync (Synchronized) Signals refer to the standard signals that are required to display desired colors on the monitor. They are divided into Vertical and Horizontal Sync Signals. These signals display normal color images by the set resolution and frequency.

Types of Sync Signals

Separate	This is a scheme of transmitting individual vertical sync signals to the monitor.
Composite	This is a scheme of combining vertical sync signals into one composite signal and transmitting it to the monitor. The monitor displays the color signals by separating the composite signal into original color signals.
Sync On Green	This scheme does not use sync signals. Instead, it combines horizontal and vertical sync signals into a Green signal and transmits to the monitor. It is mainly used for workstations.

■ Dot Pitch

The image on a monitor is composed of red, green and blue dots. The closer the dots, the higher the resolution. The distance between two dots of the same color is called the 'Dot Pitch'. Unit: mm

■ Vertical Frequency

The screen must be redrawn several times per second in order to create and display an image for the user. The frequency of this repetition per second is called Vertical Frequency or Refresh Rate. Unit: Hz

Example: If the same light repeats itself 60 times per second, this is regarded as 60 Hz. In this case, flickering of the screen can be detected. To avoid this problem, there is a Flicker-free Mode using a vertical frequency over 70 Hz.

■ Horizontal Frequency

The time to scan one line connecting the right edge to the left edge of the screen horizontally is called Horizontal Cycle. The inverse number of the Horizontal Cycle is called Horizontal Frequency. Unit: kHz

■ Interlace and Non-Interlace Methods

Showing the horizontal lines of the screen from the top to the bottom in order is called the Non-Interlace method while showing odd lines and then even lines in turn is called the Interlace method. The Non-Interlace method is used for the majority of monitors to ensure a clear image. The Interlace method is the same as that used in TVs.

■ Plug & Play

This is a function that provides the best quality screen for the user by allowing the computer and the monitor to exchange information automatically. This monitor follows the international standard VESA DDC for the Plug & Play function.

■ Resolution

The number of horizontal and vertical dots used to compose the screen image is called 'resolution'. This number shows the accuracy of the display. High resolution is good for performing multiple tasks as more image information can be shown on the screen.

Example: If the resolution is 1024 X 768, this means the screen is composed of 1024 horizontal dots (horizontal resolution) and 768 vertical lines (vertical resolution).

■ A2

This system uses two carriers to transmit voice data. Countries such as South Korea and Germany use this system.

■ BTSC

Broadcast Television System Committee
The stereo broadcasting system that is used in most of the countries that have adopted the NTSC system, including the United States, Canada, Chile, Venezuela and Taiwan. It also refers to the organization that has been organized to promote its development and management.

■ EIAJ

Electronic Industries Association of Japan

Information - Regulatory

[FCC Information](#) | [IC Compliance Notice](#) | [MPR II Compliance](#) |
[European Notice \(Europe only\)](#) | [PCT Notice](#) | [VCCI](#) |
[TCO'95-Ecological requirements for personal computers \(TCO95 applied model only\)](#)
[TCO'99-Ecological requirements for personal computers \(TCO99 applied model only\)](#)
[TCO'03-Ecological requirements for personal computers \(TCO03 applied model only\)](#)

■ FCC Information

User Instructions

The Federal Communications Commission Radio Frequency Interference Statement includes the following warning:

Note: This equipment has been tested and found to comply with the limits for a Class B digital device, pursuant to Part 15 of the FCC Rules. These limits are designed to provide reasonable protection against harmful interference in a residential installation. This equipment generates, uses, and can radiate radio frequency energy and, if not installed and used in accordance with the instructions, may cause harmful interference to radio communications. However, there is no guarantee that interference will not occur in a particular installation. If this equipment does cause harmful interference to radio or television receptions, which can be determined by turning the equipment off and on, the user is encouraged to try to correct the interference by one or more of the following measures:

- Reorient or relocate the receiving antenna.
- Increase the separation between the equipment and receiver.
- Connect the equipment into an outlet on a circuit different from that to which the receiver is connected.
- Consult the dealer or an experienced radio/TV technician for help.

User Information

Changes or modifications not expressly approved by the party responsible for compliance could void the user's authority to operate the equipment. If necessary, consult your dealer or an experienced radio/television technician for additional suggestions. You may find the booklet called How to Identify and Resolve Radio/TV Interference Problems helpful. This booklet was prepared by the Federal Communications Commission. It is available from the U.S. Government Printing Office, Washington, DC 20402, Stock Number 004-000-00345-4.

The party responsible for product compliance:
 SAMSUNG ELECTRONICS CO., LTD
 America QA Lab of Samsung
 3351 Michelson Drive,
 Suite #290, Irvine, CA92612 USA
 Tel) 949-975-7310
 Fax) 949-922-8301

Warning

User must use shielded signal interface cables to maintain FCC compliance for the product.

Provided with this monitor is a detachable power supply cord with IEC320 style terminations. It may be suitable for connection to any UL Listed personal computer with similar configuration. Before making the connection, make sure the voltage rating of the computer convenience outlet is the same as the monitor and that the ampere rating of the computer convenience outlet is equal to or exceeds the monitor voltage rating.

For 120 Volt applications, use only UL Listed detachable power cord with NEMA configuration 5-15P type (parallel blades) plug cap. For 240 Volt applications use only UL Listed Detachable power supply cord with NEMA configuration 6-15P type (tandem blades) plug cap.

■ IC Compliance Notice

This Class B digital apparatus meets all requirements of the Canadian Interference-Causing Equipment Regulations of ICES-003.

Cet appareil Numérique de classe B respecte toutes les exigences du Règlement NMB-03 sur les équipements produisant des interférences au Canada.

■ MPR II Compliance

This monitor complies with SWEDAC(MPR II) recommendations for reduced electric and magnetic fields.

Information - Regulatory

■ European Notice (Europe only)

Products with the CE marking comply with the EMC Directive(89/336/EEC), (92/31/EEC), (93/68/EEC) and the Low Voltage Directive (73/23/EEC) issued by the Commission of the European Community.

Compliance with these directives implies conformity to the following European Norms:

- EN55022:1998+A1:2000 - Radio Frequency Interference
- EN55024:1998 - Electromagnetic Immunity
- EN55013:1990+A12:1994+A13:1996+A14:1999 - Radio Frequency Interference
- EN55020:1994+A11:1996+A12/A13/A14:1999 - Electromagnetic Immunity
- EN61000-3-2:1995+A1/A2:1998 - Power Line Harmonics
- EN61000-3-3:1995 - Voltage Fluctuations
- EN60065:1997 or EN60095:1998 - Product Safety

■ PCT Notice



■ VCCI

This is a Class B product based on the standard of the Voluntary Control Council for Interference by Information Technology Equipment (VCCI). If this is used near a radio or television receiver in a domestic environment, it may cause radio interference. Install and use the equipment according to the instruction manual.

■ TCO'95-Ecological requirements for personal computers (TCO applied model only)



AB general requirements

AB2 Written Eco-document accompanying the products

Congratulations! You have just purchased a TCO'95 approved and labelled product! Your choice has provided you with a product developed for professional use. Your purchase has also contributed to reducing the burden on the environment and to the further development of environmentally-adapted electronic products.

Why do we have environmentally-labelled monitors?

In many countries, environmental labelling has become an established method for encouraging the adaptation of goods and services to the environment. The main problem as far as monitors and other electronic equipment are concerned is that environmentally harmful substances are used both in the products and during their manufacture. Since it has not been possible so far for the majority of electronic equipment to be recycled in a satisfactory way, most of these potentially damaging substances sooner or later enter Nature.

There are also other characteristics of a monitor, such as energy consumption levels, that are important from both the working and natural environment viewpoints. Since all types of conventional electricity generation have a negative effect on the environment (acidic and climate-influencing emissions, radioactive waste, etc.) it is vital to conserve energy. Electronic equipment in offices consumes an enormous amount of energy, since it is often routinely left running continuously.

Information - Regulatory

What does labelling involve?

This product meets the requirements for the TCO'95 scheme, which provides for international environmental labelling of monitors. The labelling scheme was developed as a joint effort by the TCO (The Swedish Confederation of Professional Employees), Naturskyddsforeningen (The Swedish Society for Nature Conservation) and NUTEK (The National Board for Industrial and Technical Development in Sweden).

The requirements cover a wide range of issues: environment, ergonomics, usability, emission of electrical and magnetic fields, energy consumption and electrical and fire safety.

The environmental demands concern among other things restrictions on the presence and use of heavy metals, brominated and chlorinated flame retardants, CFCs (freons), and chlorinated solvents. The product must be prepared for recycling and the manufacturer is obliged to have an environmental plan, which must be adhered to in each country where the company conducts its operations policy. The energy requirements include a demand that the monitor after a certain period of inactivity shall reduce its power consumption to a lower level, in one or more stages. The length of time to reactivate the monitor shall be reasonable for the user.

Labelled products must meet strict environmental demands, for example in respect of the reduction of electric and magnetic fields, along with physical and visual ergonomics and good usability.

TCO Development Unit 1996-11-29

On the page this folder you will find a brief summary of the environmental requirements met by this product.

The complete environmental criteria document may be ordered from:

TCO Development Unit

S-11494 Stockholm

Sweden

Fax: +46 8 782 92 07

E-mail (Internet): development@tco.se

Current information regarding TCO'95-approved and labelled products may also be obtained via the Internet, using the address:

<http://www.tco-info.com/>

TCO'95 is a co-operative project between(3 logos)

Environmental Requirements

Brominated flame retardants are present in printed circuit boards, cables, wires, casings and housings. In turn, they delay the spread of fire. Up to thirty percent of the plastic in a computer casing can consist of flame retardant substances. These are related to another group of environmental toxins, PCBs, which are suspected to give rise to similar harm, including reproductive damage in fish eating birds and mammals, due to the bioaccumulative processes. Flame retardants have been found in human blood and researchers fear that disturbances in foetus development may occur.

- TCO'95 demand requires that plastic components weighing more than 25 grams must not contain organically bound chlorine and bromine.

Lead

Lead can be found in picture tubes, display screens, solders and capacitors. Lead damages the nervous system and in higher doses, causes lead poisoning.

- TCO'95 requirement Permits the inclusion of lead since no replacement has yet been developed.

Cadmium

Cadmium is present in rechargeable batteries and in the colour generating layers of certain computer displays. Cadmium damages the nervous system and is toxic in high doses.

- TCO'95 requirement states that batteries may not contain more than 25 ppm (parts per million) of cadmium. The colour-generating layers of display screens must not contain any cadmium.

Mercury

Mercury is sometimes found in batteries, relays and switches. Mercury damages the nervous system and is toxic in high doses.

- TCO'95 requirement states that batteries may not contain more than 25 ppm (parts per million) of mercury. It also demands that no mercury is present in any of the electrical or electronics components concerned with the display unit.

CFCs (freons)

CFCs (freons) are sometimes used for washing printed circuit boards and in the manufacturing of expanded foam for packaging. CFCs break down ozone and thereby damage the ozone layer in the stratosphere, causing increased reception on Earth of ultraviolet light with consequent increased risks of skin cancer (malignant melanoma).

- The relevant TCO'95 requirement: Neither CFCs nor HCFCs may be used during the manufacturing of the product or its packaging.

Information - Regulatory

TCO'99-Ecological requirements for personal computers (TCO applied model only)



Congratulations!

You have just purchased a TCO'99 approved and labelled product! Your choice has provided you with a product developed for professional use. Your purchase has also contributed to reducing the burden on the environment and also to the further development of environmentally adapted electronics products.

This product meets the requirements for the TCO'99 scheme which provides for an international environmental and quality labelling of personal computers. The labelling scheme was developed as a joint effort by the TCO(The Swedish Confederation of Professional Employees), Svenska Naturskyddsforeningen(The Swedish Society for Nature Conservation), Statens Energimyndighet(The Swedish National Energy Administration) and SEMKO AB.

The requirements cover a wide range of issues: environment, ergonomics, usability, reduction of electric and magnetic fields, energy consumption and electrical safety.

Why do we have environmentally labelled computers?

In many countries, environmental labelling has become an established method for encouraging the adaptation of goods and services to the environment. The main problem, as far as computers and other electronics equipment are concerned, is that environmentally harmful substances are used both in the products and during their manufacture. Since it is not so far possible to satisfactorily recycle the majority of electronics equipment, most of these potentially damaging substances sooner or later enter nature.

There are also other characteristics of a computer, such as energy consumption levels, that are important from the viewpoints of both the work (internal) and natural (external) environments. Since all methods of electricity generation have a negative effect on the environment (e.g. acidic and climate-influencing emissions, radioactive waste), it is vital to save energy. Electronics equipment in offices is often left running continuously and thereby consumes a lot of energy.

What does labelling involve?

The environmental demands have been developed by Svenska Naturskyddsforeningen (The Swedish Society for Nature Conservation). These demands impose restrictions on the presence and use of heavy metals, brominated and chlorinated flame retardants, CFCs(freons)and chlorinated solvents, among other things. The product must be prepared for recycling and the manufacturer is obliged to have an environmental policy which must be adhered to in each country where the company implements its operational policy.

The energy requirements include a demand that the computer and/or display, after a certain period of inactivity, shall reduce its power consumption to a lower level in one or more stages. The length of time to reactivate the computer shall be reasonable for the user.

Below you will find a brief summary of the environmental requirements met by this product. The complete environmental criteria document may be ordered from:

TCO Development

SE-114 94 Stockholm, Sweden
Fax: +46 8 782 92 07
Email (Internet): development@tco.se

Current information regarding TCO'99 approved and labelled products may also be obtained via the Internet, using the address: <http://www.tco-info.com/>

Environmental requirements

Flame retardants

Flame retardants are present in printed circuit boards, cables, wires, casings and housings. Their purpose is to prevent, or at least to delay the spread of fire. Up to 30% of the plastic in a computer casing can consist of flame retardant substances. Most flame retardants contain bromine or chloride, and those flame retardants are chemically related to another group of environmental toxins, PCBs. Both the flame retardants containing bromine or chloride and the PCBs are suspected of giving rise to severe health effects, including reproductive damage in fish-eating birds and mammals, due to the bio-accumulative* processes. Flame retardants have been found in human blood and researchers fear that disturbances in foetus development may occur.

The relevant TCO'99 demand requires that plastic components weighing more than 25 grams must not contain flame retardants with organically bound bromine or chlorine. Flame retardants are allowed in the printed circuit boards since no substitutes are available.

Information - Regulatory

Cadmium**

Cadmium is present in rechargeable batteries and in the colour-generating layers of certain computer displays. Cadmium damages the nervous system and is toxic in high doses. The relevant TCO'99 requirement states that batteries, the colour-generating layers of display screens and the electrical or electronics components must not contain any cadmium.

Mercury**

Mercury is sometimes found in batteries, relays and switches. It damages the nervous system and is toxic in high doses. The relevant TCO'99 requirement states that batteries may not contain any mercury. It also demands that mercury is not present in any of the electrical or electronics components associated with the labelled unit. There is however one exception. Mercury is, for the time being, permitted in the back light system of flat panel monitors as today there is no commercially available alternative. TCO aims on removing this exception when a Mercury free alternative is available.

CFCs (freons)

The relevant TCO'99 requirement states that neither CFCs nor HCFCs may be used during the manufacture and assembly of the product. CFCs (freons) are sometimes used for washing printed circuit boards. CFCs break down ozone and thereby damage the ozone layer in the stratosphere, causing increased reception on earth of ultraviolet light with e.g. increased risks of skin cancer (malignant melanoma) as a consequence.

Lead**

Lead can be found in picture tubes, display screens, solders and capacitors. Lead damages the nervous system and in higher doses, causes lead poisoning. The relevant TCO'99 requirement permits the inclusion of lead since no replacement has yet been developed.

* Bio-accumulative is defined as substances which accumulate within living organisms.

** Lead, Cadmium and Mercury are heavy metals which are Bio-accumulative.

Information - Regulatory

- TCO'03-Ecological requirements for personal computers (TCO applied model only)



Congratulations!

The display you have just purchased carries the TCO03 Displays label. This means that your display is designed, manufactured and tested according to some of the strictest quality and environmental requirements in the world. This makes for a high performance product, designed with the user in focus that also minimizes the impact on our natural environment.

Some of the features of the TCO03 Display requirements:

Ergonomics

Good visual ergonomics and image quality in order to improve the working environment for the user and to reduce sight and strain problems. Important parameters are luminance, contrast, resolution, reflectance, colour rendition and image stability.

Energy

- Energy-saving mode after a certain time - beneficial both for the user and the environment
- Electrical safety

Emissions

- Electromagnetic fields
- Noise emissions

Ecology

- The product must be prepared for recycling and the manufacturer must have a certified environmental management system such as EMAS or ISO 14 000
- Restrictions on
 - chlorinated and brominated flame retardants and polymers
 - heavy metals such as cadmium, mercury and lead.

The requirements included in this label have been developed by TCO Development in cooperation with scientists, experts, users as well as manufacturers all over the world. Since the end of the 1980s TCO has been involved in influencing the development of IT equipment in a more user-friendly direction. Our labelling system started with displays in 1992 and is now requested by users and IT-manufacturers all over the world.

For more information, Please visit
www.tcodevelopment.com

Information - Natural Color

● Natural Color Software Program



One of the recent problems in using a computer is that the color of the images printed out by a printer or other images scanned by a scanner or a digital camera are not the same as those shown on the monitor.

The Natural Color S/W is the very solution for this problem. It is a color administration system developed by Samsung Electronics in association with Korea Electronics & Telecommunications Research Institute (ETRI). This system is available only for Samsung monitors and makes the color of the images on the monitor the same as the printed or scanned images.

For more information, refer to Help (F1) in the software program.

How to install the Natural Color software

Insert the CD included with the Samsung monitor into the CD-ROM Drive. Then, the initial screen of the program installation will be executed. Click Natural Color on the initial screen to install the Natural Color software. To install the program manually, insert the CD included with the Samsung monitor into the CD-ROM Drive, click the [Start] button of Windows and then select [Execute]. Enter D:\color\eng\setup.exe and then press the <Enter> key.
(If the drive where the CD is inserted is not D:\, enter the applicable drive.)

How to delete the Natural Color software program

Select [Setting]/[Control Panel] on the [Start] menu and then double-click [Add/Delete a program]. Select Natural Color from the list and then click the [Add/Delete] button.

Information - For Better Display

● For Better Display

1. Adjust computer resolution and screen injection rate (refresh rate) in control panel of computer as described below to enjoy the best quality of picture. You can have an uneven quality of picture in the screen if the best quality of picture is not provided in TFT-LCD.
 - Resolution: 1024 x 768
 - Vertical frequency (refresh rate): 60 Hz
2. TFT LCD panel manufactured by using advanced semiconductor technology with precision of 99.999% above is used for this product. But the pixels of RED, GREEN, BLUE and WHITE color seem to be bright sometimes or some of black pixels could be seen. This is not from bad quality and you can use it without uneasiness.
 - For example, the number of TFT LCD pixels that is contained in this product are 2,359,296.
3. When you clean the monitor and the panel outside, please apply the recommended small amount of cleaner by using soft and dry cloth and polish it. Let LCD area not to be forced but to be scrubbed out softly. If excessive force is applied, you can have a stain on it.
4. If you are not satisfied with the quality of picture, you can get better quality of picture by executing "auto adjustment function" in display screen that is appeared as window termination button is pressed. If there's still noise after automatic adjustment, use FINE/COARSE adjustment function.
5. If you view a fixed screen for an extended period of time, residual image or blurriness may appear. Change the mode to energy save or set a screensaver to moving picture when you need to be away from the monitor for an extended period of time.

Information - For Better Display

● For Better Display

1. Adjust computer resolution and screen injection rate (refresh rate) on computer as described below to enjoy the best quality of picture. You can have an uneven quality of picture in the screen if the best quality of picture is not provided in TFT-LCD.
 - Resolution: 1280 x 1024
 - Vertical frequency (refresh rate): 60 Hz
2. TFT LCD panel manufactured by using advanced semiconductor technology with precision of 99.999% above is used for this product. But the pixels of RED, GREEN, BLUE and WHITE color seem to be bright sometimes or some of black pixels could be seen. This is not from bad quality and you can use it without uneasiness.
 - For example, the number of TFT LCD pixels that is contained in this product are 3,932,160 .
3. When you clean the monitor and the panel outside, please apply the recommended small amount of cleaner by using soft and dry cloth and polish it. Let LCD area not to be forced but to be scrubbed out softly. If excessive force is applied, you can have a stain on it.
4. If you are not satisfied with the quality of picture, you can get better quality of picture by executing "auto adjustment function" in display screen that is appeared as window termination button is pressed. If there's still noise after automatic adjustment, use FINE/COARSE adjustment function.
5. If you view a fixed screen for an extended period of time, residual image or blurriness may appear. Change the mode to energy save or set a screensaver to moving picture when you need to be away from the monitor for an extended period of time.

Information - Authority

**Information in this document is subject to change without notice.
© 2003 Samsung Electronics Co., Ltd. All rights reserved.**

Reproduction in any manner whatsoever without the written permission of Samsung Electronics Co., Ltd. is strictly forbidden.

Samsung Electronics Co., Ltd. shall not be liable for errors contained herein or for incidental or consequential damages in connection with the furnishing, performance, or use of this material.

Samsung is the registered trademark of Samsung Electronics Co., Ltd.; *Microsoft*, *Windows* and *Windows NT* are registered trademarks of Microsoft Corporation; *VESA*, *DPMS* and *DDC* are registered trademarks of Video Electronics Standard Association; the *ENERGY STAR* name and logo are registered trademarks of the U.S. Environmental Protection Agency (EPA). As an ENERGY STAR Partner, Samsung Electronics Co., Ltd. has determined that this product meets the ENERGY STAR guidelines for energy efficiency. All other product names mentioned herein may be the trademarks or registered trademarks of their respective owners.



<http://www.samsung-monitor.com/> (Worldwide)
<http://www.samsungusa.com/monitor/> (USA)
<http://www.sec.co.kr/monitor/> (Korea)
<http://www.samsungmonitor.com.cn/> (China)

Free Manuals Download Website

<http://myh66.com>

<http://usermanuals.us>

<http://www.somanuals.com>

<http://www.4manuals.cc>

<http://www.manual-lib.com>

<http://www.404manual.com>

<http://www.luxmanual.com>

<http://aubethermostatmanual.com>

Golf course search by state

<http://golfingnear.com>

Email search by domain

<http://emailbydomain.com>

Auto manuals search

<http://auto.somanuals.com>

TV manuals search

<http://tv.somanuals.com>