

afety precautions	Features	How to install	How to use	How to store and clean	Troubleshooting	Specifications
-------------------	----------	----------------	------------	------------------------	-----------------	----------------



Samsung's OMS (Optical Media Solution) Customer Support Website (www.samsung-ODD.com) offers the latest versions of firmware for ODD products, user instructions and product information.



Related links

<http://www.samsung-ODD.com>

<http://www.samsung.com>

Select model

SH-B123L(TS-HB43L) LightScri

Select language

Select your language

Firmware Update

Check your firmware version.

Warranty Statement

Warranty statement for your product

Safety precautions	Features	How to install	How to use	How to store and clean	Troubleshooting	Specifications
--------------------	----------	----------------	------------	------------------------	-----------------	----------------

Safety precaution

Safety precautions ▶

During installation -

During operation -

Others -

RoHS and WEEE -

Related links

<http://www.samsung-ODD.com> 

<http://www.samsung.com> 

Select model

SH-B123L(TS-HB43L) LightScrib 

Select language

Select your language 

Firmware Update





Check your firmware version. 

Warranty Statement

Warranty statement for your product 

Safety precautions

■ Important to read and understand at all times

	Warning	This symbol indicates an extremely dangerous situation. If users ignore this symbol and handle the device with the wrong way, serious injury or death could result.
	Caution	This symbol indicates that a dangerous situation might occur. If users ignore this symbol and handle the device with the wrong way, serious damage to the product could result.
	Important	Important to read and understand at all times.
	Caution	Do not disassemble.
	Note	Note

Before use, always make sure that discs do not have a crack. If the disc has a crack, we recommend that you make a copy and use the copy. When you continue to use a cracked disc, the size of the crack will increase. This will cause irreparable damage to the disc.

 Top

afety precautions	Features	How to install	How to use	How to store and clean	Troubleshooting	Specifications
-------------------	----------	----------------	------------	------------------------	-----------------	----------------

Safety precaution

Safety precautions -

During installation ▶

During operation -

Others -

RoHS and WEEE -

Related links

<http://www.samsung-ODD.com> 

<http://www.samsung.com> 

Select model

SH-B123L(TS-HB43L) LightScril

Select language

Select your language

Firmware Update

Check your firmware version. 

Warranty Statement

Warranty statement for your product 

During Installation

■ Installation

 Do not install the drive on the unstable surface.

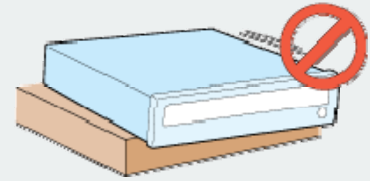

 Do not place the drive in direct sunlight.

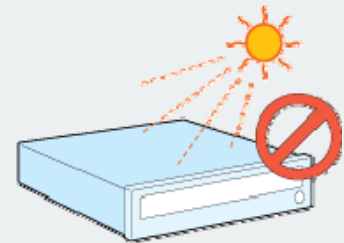

 Avoid very low or high temperatures.

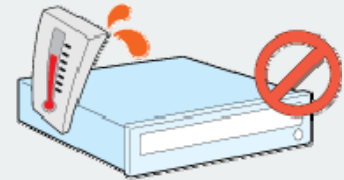

 Avoid high humidity.

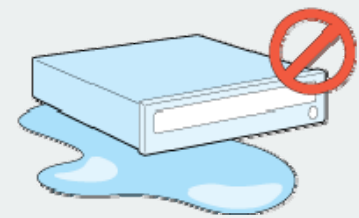

 Top



Safety precautions	Features	How to install	How to use	How to store and clean	Troubleshooting	Specifications
--------------------	----------	----------------	------------	------------------------	-----------------	----------------

Safety precaution

Safety precautions -

During installation -

During operation ▶

Others -

RoHS and WEEE -

Related links

<http://www.samsung-ODD.com>

<http://www.samsung.com>

Select model

SH-B123L(TS-HB43L) LightScri

Select language

Select your language

Firmware Update

Check your firmware version.



Warranty Statement

Warranty statement for your product

During Operation

■ Operation

- i** Handle the drive carefully to prevent damage from an external shock.

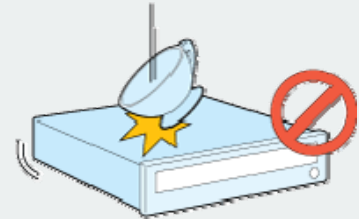

- i** Do not drop the drive. Protect the drive from severe shocks.

- ▶ If you do not protect it, this can cause damage to the drive.



- !** Do not move the drive while in operation. Do not attempt to open the disc tray by force.

Make sure that you close all open applications before you open the tray. Always use the Eject button to open and close the tray.

- ▶ Do not insert a pin into the emergency hole while the drive is in operation.
- ▶ Keep your hand away from the tray while the drive is in operation. This can result in damage to the product or human body.

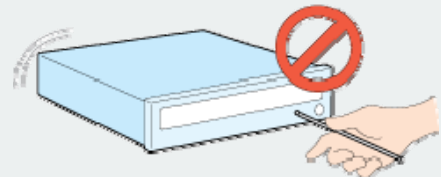

- !** Do not use cracked, distorted or damaged discs.

- ▶ A disc with a crack can break while you use it, especially when the crack is near the center of the disc.
- ▶ Before you use the disc, always make sure that it does not have a crack. If the disc has a crack, we recommend you make a copy of the disc and use the copy. When you continue to use a cracked disc, the size of the crack will increase. This will cause irreparable damage to the disc.
- ▶ Do not use low-quality discs (illegal, scratched, damaged, etc.).
- ▶ **If you use such discs, Samsung is not responsible for the damage that this can cause.**

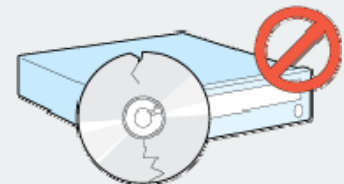

[↑ Top](#)

All Contents Copyright © 2001 - 2010



SAMSUNG Electronics Co., Ltd. Optical Disc Drive

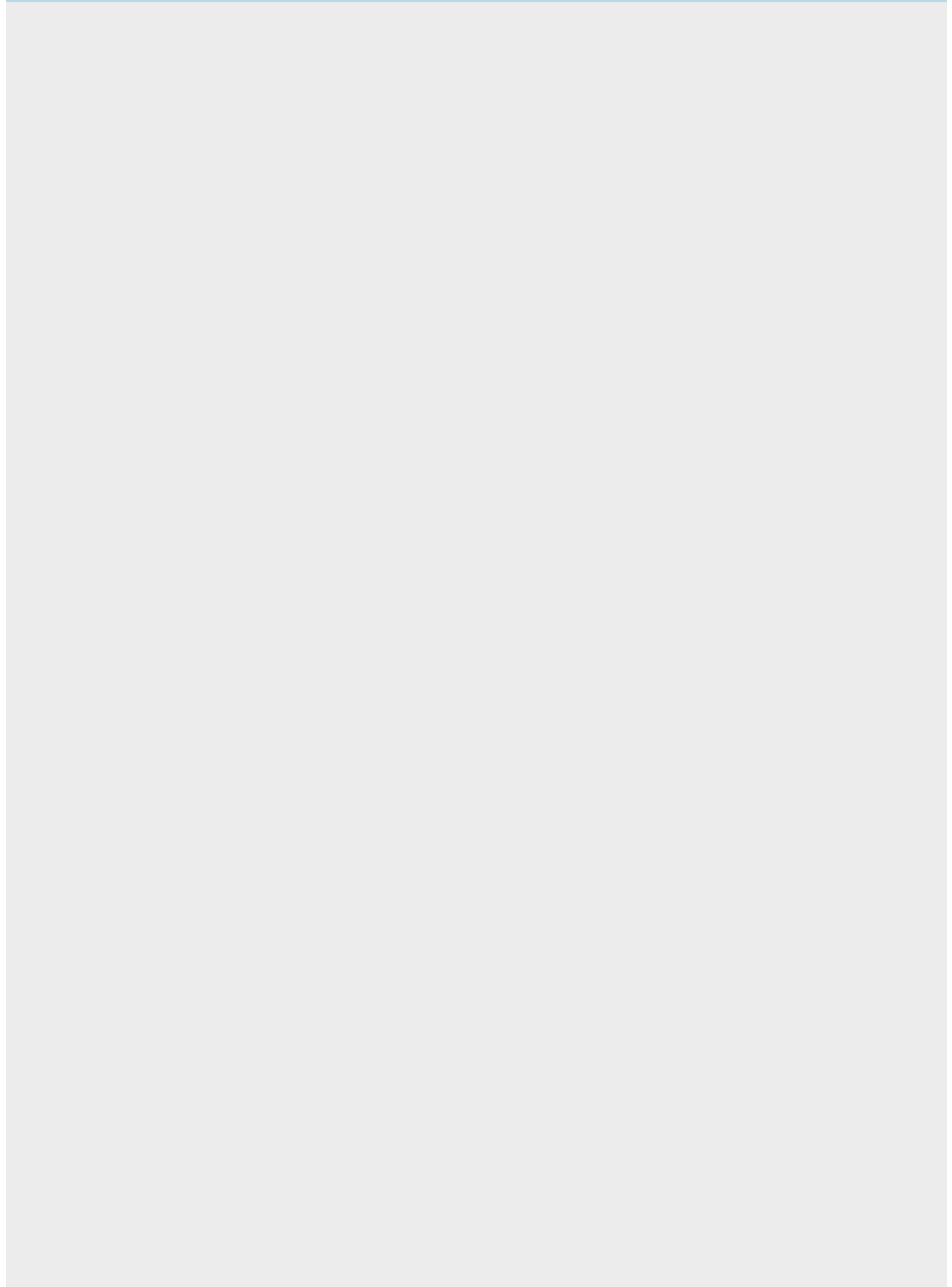

Safety precautions	Features	How to install	How to use	How to store and clean	Troubleshooting	Specifications
--------------------	----------	----------------	------------	------------------------	-----------------	----------------

Safety precaution

Safety precautions	-
During installation	-
During operation	-
Others	▶
RoHS and WEEE	-

Related links

<http://www.samsung-ODD.com> 

<http://www.samsung.com> 

Select model

SH-B123L(TS-HB43L) LightScril

Select language

Select your language

Firmware Update

Check your firmware version. 

Warranty Statement

Warranty statement for your product 

Others

■ Others

 Make sure that no food particles and other unwanted matter enter the drive casing.

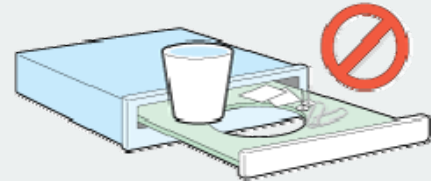

 To protect against the risk of fire, do not use liquids such as alcohol and benzene on the drive.

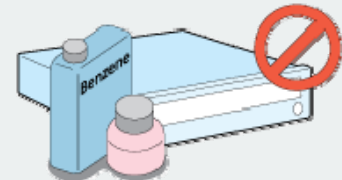

 Do not disassemble, repair or modify the device without our approval.
▶ To reduce the risk of damage, electric shock and fire.

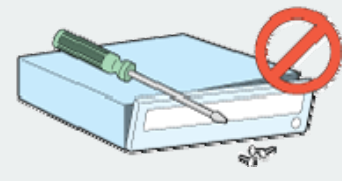

 Top

Safety precautions	Features	How to install	How to use	How to store and clean	Troubleshooting	Specifications
--------------------	----------	----------------	------------	------------------------	-----------------	----------------

Safety precaution

Safety precautions	-
During installation	-
During operation	-
Others	-
RoHS and WEEE	>

Related links

<http://www.samsung-ODD.com>

<http://www.samsung.com>

Select model

SH-B123L(TS-HB43L) LightScri

Select language

Select your language

Firmware Update

Check your firmware version.



Warranty Statement

Warranty statement for your product

RoHS and WEEE

■ RoHS

Samsung Eco mark

The Samsung Eco logo shows consumers that Samsung develops eco-friendly products. This logo demonstrates Samsung's continuous efforts to develop eco-friendly products.



RoHS(Restriction of the use of certain hazardous substances in electrical and electronic equipment)

The RoHS, the environmental regulation announced by European Union, restricts the use of lead, mercury, cadmium, hexavalent chromium, PBB, and PBDE in products put on the market in the European Union after July 1, 2006.

■ WEEE

Correct Disposal of This Product (Waste Electrical & Electronic Equipment)

(Applicable in the European Union and other European countries with separate collection systems)



This marking on the product, accessories or literature indicates that the product and its electronic accessories (e.g. charger, headset, USB cable) should not be disposed of with other household waste at the end of their working life. To prevent possible harm to the environment or human health from uncontrolled waste disposal, separate these items from other types of waste and recycle them responsibly to promote the sustainable reuse of material resources.

Household users should contact either the retailer where they purchased this product, or their local government office, for details of where and how they can take this item for environmentally safe recycling.

Business users should contact their supplier and check the terms and conditions of the purchase contract. This product should not be mixed with other commercial waste for disposal.

[Top](#)

afety precautions	Features	How to install	How to use	How to store and clean	Troubleshooting	Specifications
-------------------	----------	----------------	------------	------------------------	-----------------	----------------

Features
Exterior ▶
System requirements -
Features -

Related links

<http://www.samsung-ODD.com> 

<http://www.samsung.com> 

Select model

SH-B123L(TS-HB43L) LightScril

Select language

Select your language

Firmware Update

Check your firmware version. 

Warranty Statement

Warranty statement for your product 

Exterior

■ Front



1. Door tray
2. Emergency hole
3. LED/Eject button

Note

Design and specifications are subject to change without prior notice.

■ Back

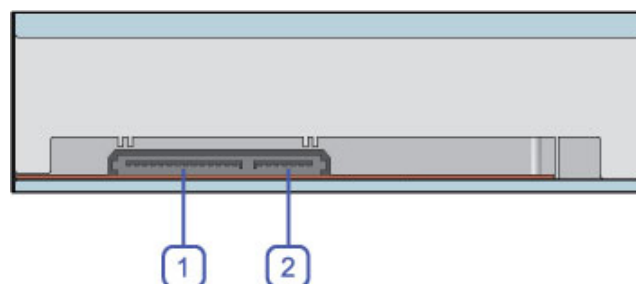

1. S-ATA power port
2. S-ATA data port

■ Components

- ▶ BD-ROM/DVD writer
- ▶ S-ATA data cable
- ▶ Mounting screws
- ▶ Quick installation guide
- ▶ Application software & user manual CD

Note

- ▶ If you need to return the purchased product, make sure to include all the accessories provided with the product to receive a refund.

All Contents Copyright © 2001 - 2010



▶ The type of accessories varies depending on a product model. Some accessories are subject to change without notice.

SAMSUNG Electronics Co., Ltd.



Optical Disc Drive

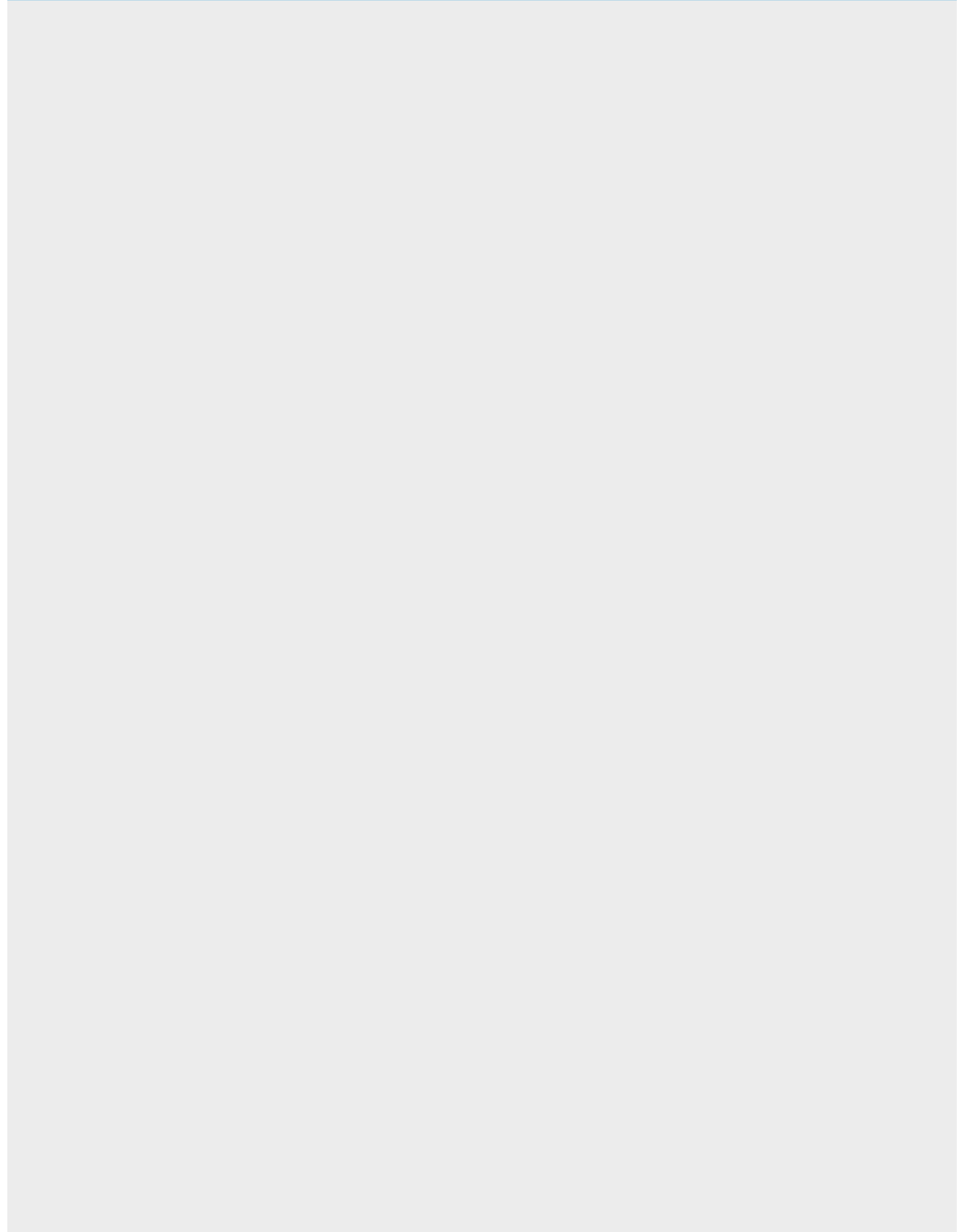



afety precautions	Features	How to install	How to use	How to store and clean	Troubleshooting	Specifications
-------------------	----------	----------------	------------	------------------------	-----------------	----------------

Features

Exterior -

System requirements ▶

Features -

Related links

<http://www.samsung-ODD.com>

<http://www.samsung.com>

Select model

SH-B123L(TS-HB43L) LightScril

Select language

Select your language

Firmware Update

Check your firmware version.

Warranty Statement

Warranty statement for your product

System requirements

■ System requirements

Item	Description
OS	Microsoft Windows XP (SP2 or above)/Vista/7
CPU	Pentium4 3.2 GHz or above
RAM	1 GB or more
Monitor	HDCP support recommended (Digital playback support)
Graphic card	HDCP support (for Bluray disc playback, the graphic card must have HDCP support.)

Top



afety precautions	Features	How to install	How to use	How to store and clean	Troubleshooting	Specifications
-------------------	----------	----------------	------------	------------------------	-----------------	----------------

Features
Exterior -
System requirements -
Features ▶

Related links

<http://www.samsung-ODD.com> 

<http://www.samsung.com> 

Select model

SH-B123L(TS-HB43L) LightScri

Select language

Select your language 

Firmware Update

Check your firmware version. 

Warranty Statement

Warranty statement for your product 

Features

■ Versatile multimedia features

	Disc type	Writable	Rewritable	Read	Labeling
BD	BD-ROM(DL)	X	X	O	X
	BD-RE(DL)	X	X	O	X
	BD-R(DL)	X	X	O	X
DVD	DVD-ROM(DL)	X	X	O	X
	DVD-RW	X	O	O	X
	DVD+R(DL)	O	X	O	X
	DVD-R(DL)	O	X	O	X
	DVD+RW	X	O	O	X
	LightScribe Media	O	X	O	O
CD	DVD-RAM	X	O	O	X
	CD-ROM	X	X	O	X
	CD-R	O	X	O	X
	CD-RW	X	O	O	X
	LightScribe Media	O	X	O	O

▶ **Writable:** Write once and read many times.

▶ **Rewritable:** Read and write data once or more times.

 Top

■ Recommended DVD disc types

DVD-R Media

TAIYO-YUDEN, TDK, MKM(VERBATIM, MITSUBISHI), MAXELL, FUJIFILM, RITEK, CMC

DVD-RW Media

TDK, MKM(VERBATIM, MITSUBISHI), JVC, RITEK, CMC

DVD+R Media

All Contents Copyright © 2001 - 2010

RICOH, TAIYO-YUDEN, MKM(VERBATIM, MITSUBISHI), RITEK, CMC, PRODISC, OPTDISC

SAMSUNG Electronics Co., Ltd.



DVD+RW Media

RICOH, MKM(VERBATIM, MITSUBISHI), RITEK, CMC

Optical Disc Drive

DVD±R DL

MKM(VERBATIM, MITSUBISHI), RICOH

DVD-RAM

MAXELL, MKM(VERBATIM, MITSUBISHI)

[↑ Top](#)

■ Recommended CD disc types

CD-R Media

TAIYO-YUDEN, RICOH, MKM(VERBATIM, MITSUBISHI), MAXELL, FUJIFILM, RITEK (PHTHARO), CMC, PIONEER, PRINCO, TDK

CD-RW Media

RICOH, MKM(VERBATIM, MITSUBISHI), RITEK, CMC

HS CD-RW Media

RICOH, MKM(VERBATIM, MITSUBISHI), CMC

US CD-RW Media

MKM(VERBATIM, MITSUBISHI)

[↑ Top](#)

■ LightScribe

▶ **CD:** MKM(VERBATIM, MITSUBISHI), MBI, CMC

▶ **DVD:** MKM(VERBATIM, MITSUBISHI)

[↑ Top](#)

■ Buffer underrun prevention technology included

What is "buffer underrun prevention technology"?

A technology to prevent "buffer underrun" errors in which the data transmission speed is not as fast as the data writing speed when you record data.

[↑ Top](#)

[Safety precautions](#)
[Features](#)
[How to install](#)
[How to use](#)
[How to store and clean](#)
[Troubleshooting](#)
[Specifications](#)

How to install

[How to install the drive](#)
[How to connect the cables](#)
[How to install the driver](#)
[How to update the Firmware](#)
[How to remove the utilities](#)

Related links

<http://www.samsung-ODD.com>
<http://www.samsung.com>

Select model

Select language

Firmware Update

Check your firmware version.



Warranty Statement

Warranty statement for your product

How to install the drive

1. Switch off the PC.
2. Open the cover.
See the pictures.

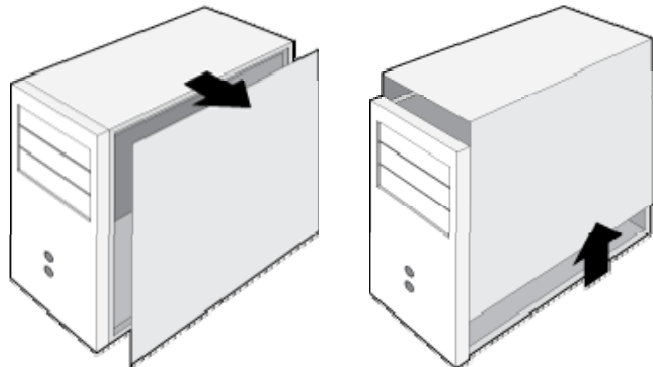

3. If necessary, attach the support devices on both sides of the drive.

- ▶ The support devices are PC accessories. Purchase a pair if necessary.
(Screw: M3 x 6 x 4)

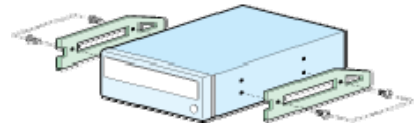

4. Remove the plate. Insert the drive.

- ▶ Make sure to use the screws (M3 x 6) included with the drive.
- ▶ If you use other screws, this can cause damage.

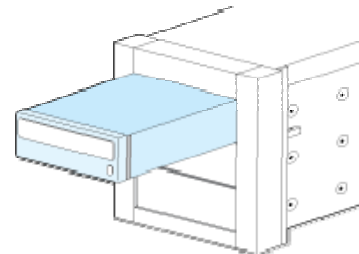

! Caution

Securely tighten the screws.

If the screws are not securely tightened, this can increase the noise level.

[Top](#)



Safety precautions

Features

How to install

How to use

How to store and clean

Troubleshooting

Specifications

How to install

How to install the drive -

How to connect the cables ▶

How to install the driver -

How to update the Firmware -

How to remove the utilities -

Related links

<http://www.samsung-ODD.com>
<http://www.samsung.com>

Select model

SH-B123L(TS-HB43L) LightScriL

Select language

Select your language

Firmware Update

Check your firmware version.



Warranty Statement

Warranty statement for your product

How to connect the cables

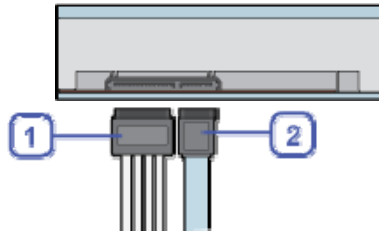

1. S-ATA power cable
2. S-ATA data cable

How to connect the S-ATA cable

When you use one S-ATA drive

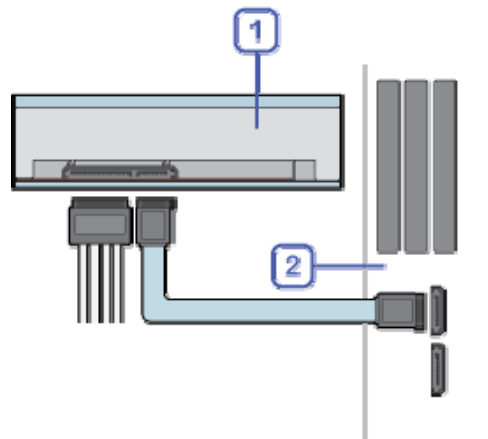

1. Drive
2. Mainboard

All Contents Copyright © 2001 - 2010

When you have more than one drive

SAMSUNG Electronics Co., Ltd.

Optical Disc Drive

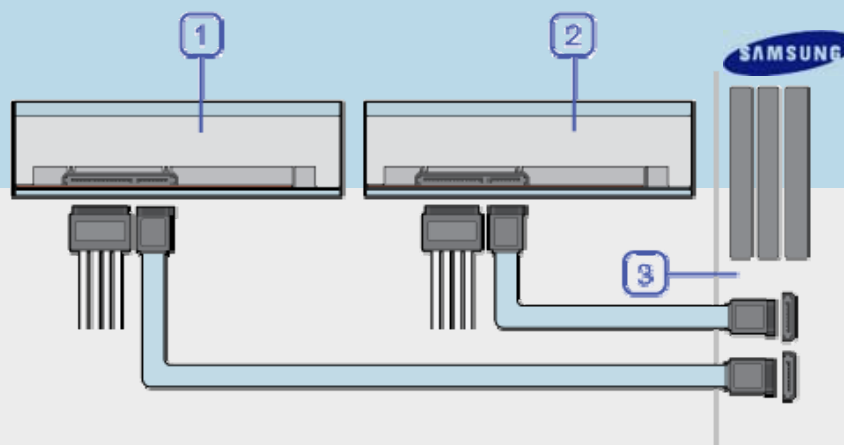

1. Drive (S-ATA 1)
2. Drive (S-ATA 2)
3. Mainboard

! Caution

Securely tighten the screws.

If the screws are not securely tightened, this can increase the noise level.

[Top](#)

afety precautions	Features	How to install	How to use	How to store and clean	Troubleshooting	Specifications
-------------------	----------	----------------	------------	------------------------	-----------------	----------------

How to install

How to install the drive	-
How to connect the cables	-
How to install the driver	▶
How to update the Firmware	-
How to remove the utilities	-

Related links

<http://www.samsung-ODD.com>

<http://www.samsung.com>

Select model

SH-B123L(TS-HB43L) LightScri

Select language

Select your language

Firmware Update

Check your firmware version.



Warranty Statement

Warranty statement for your product

How to install the driver

■ How to use the Device Manager

Windows XP

1. Click **Start - Settings - Control Panel - Performance and Maintenance**.
2. Click the **Administrative Tools** icon in the **Performance and Maintenance** window.
3. Click the **Computer Management** icon in the **Administrative Tools** window.
4. Click **Device Manager** icon in the **Administrative Tools** window and then click BD-ROM/DVD drive.

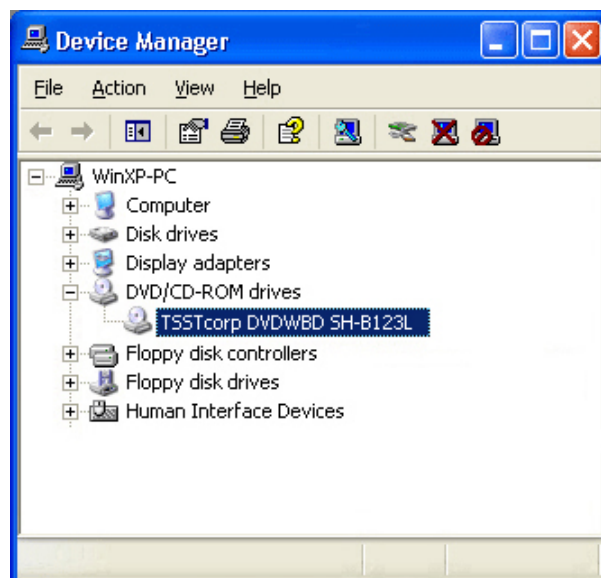

Note

The picture above shows if the driver is installed correctly.

[Top](#)

Windows Vista

1. Click **Start - Control Panel - System - Device Manager**.
2. Click BD-ROM/DVD drive in the **Device Manager** window.

Note

The picture above shows if the driver is installed correctly.

[Top](#)

All Contents Copyright © 2001 - 2010

SAMSUNG Electronics Co., Ltd.

Optical Disc Drive

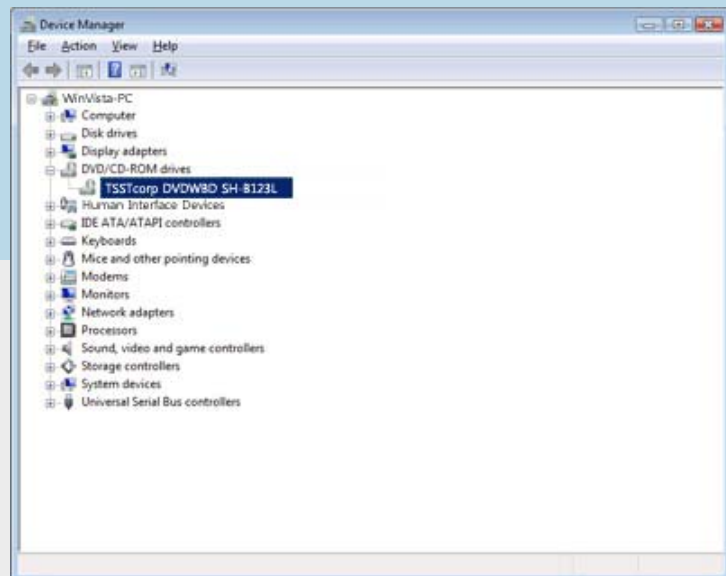

Windows 7

1. Click **Start - Control Panel - System and Security - System - Device Manager**.
2. Click BD-ROM/DVD drive in the **Device Manager** window.

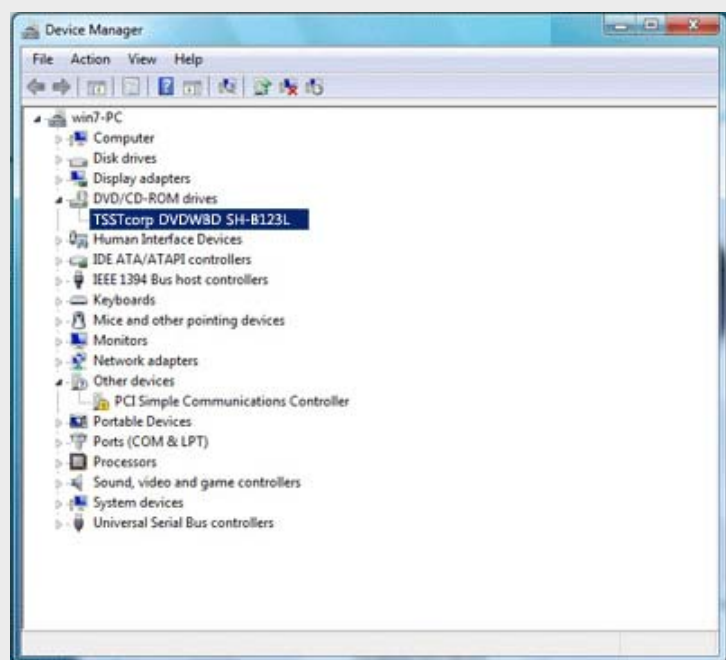

Note

The picture above shows if the driver is installed correctly.

[↑ Top](#)

afety precautions	Features	How to install	How to use	How to store and clean	Troubleshooting	Specifications
-------------------	----------	----------------	------------	------------------------	-----------------	----------------

How to install

How to install the drive	-
How to connect the cables	-
How to install the driver	-
How to update the Firmware	▶
How to remove the utilities	-

How to update the Firmware

1. Go to www.samsung-ODD.com .
2. Click **Firmware** on the menu bar (in the upper right corner).
3. Click **Firmware Downloads**. Find your drive model and start the download.

 [Top](#)

Related links

<http://www.samsung-ODD.com> 

<http://www.samsung.com> 

Select model

SH-B123L(TS-HB43L) LightScril

Select language

Select your language

Firmware Update

Check your firmware version. 

Warranty Statement

Warranty statement for your product 

afety precautions	Features	How to install	How to use	How to store and clean	Troubleshooting	Specifications
-------------------	----------	----------------	------------	------------------------	-----------------	----------------

How to install

How to install the drive	-
How to connect the cables	-
How to install the driver	-
How to update the Firmware	-
How to remove the utilities	▶

Related links

<http://www.samsung-ODD.com>

<http://www.samsung.com>

Select model

SH-B123L(TS-HB43L) LightScril

Select language

Select your language

Firmware Update

Check your firmware version.



Warranty Statement

Warranty statement for your product

How to remove the utilities

Click **Start - Setting - Control Panel - Add/Remove Programs**. The window below shows.

Windows XP

- ▶ Click the **Add/Remove** button to remove the program.

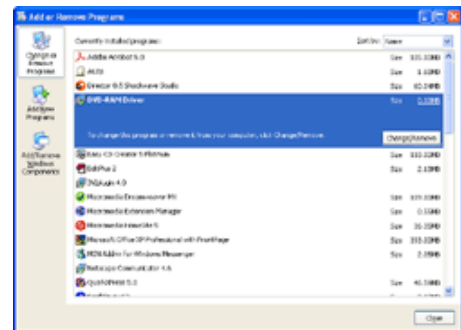

Top

Windows Vista

- ▶ Click the **Add/Remove** button to remove the program.

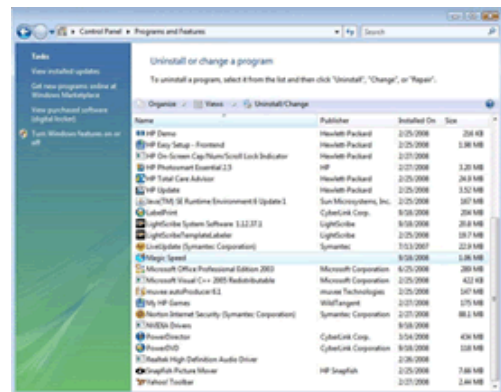

Top

Windows 7

- ▶ Click the **Add/Remove** button to remove the program.

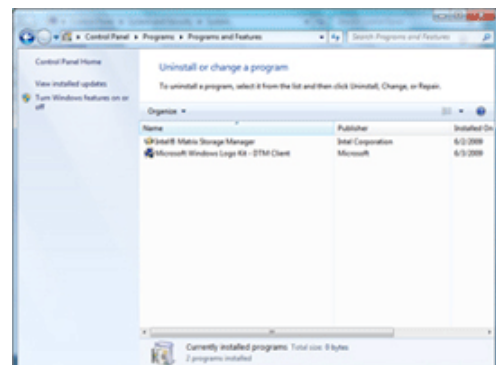

[↑ Top](#)

All Contents Copyright © 2001 - 2010



SAMSUNG Electronics Co., Ltd. Optical Disc Drive

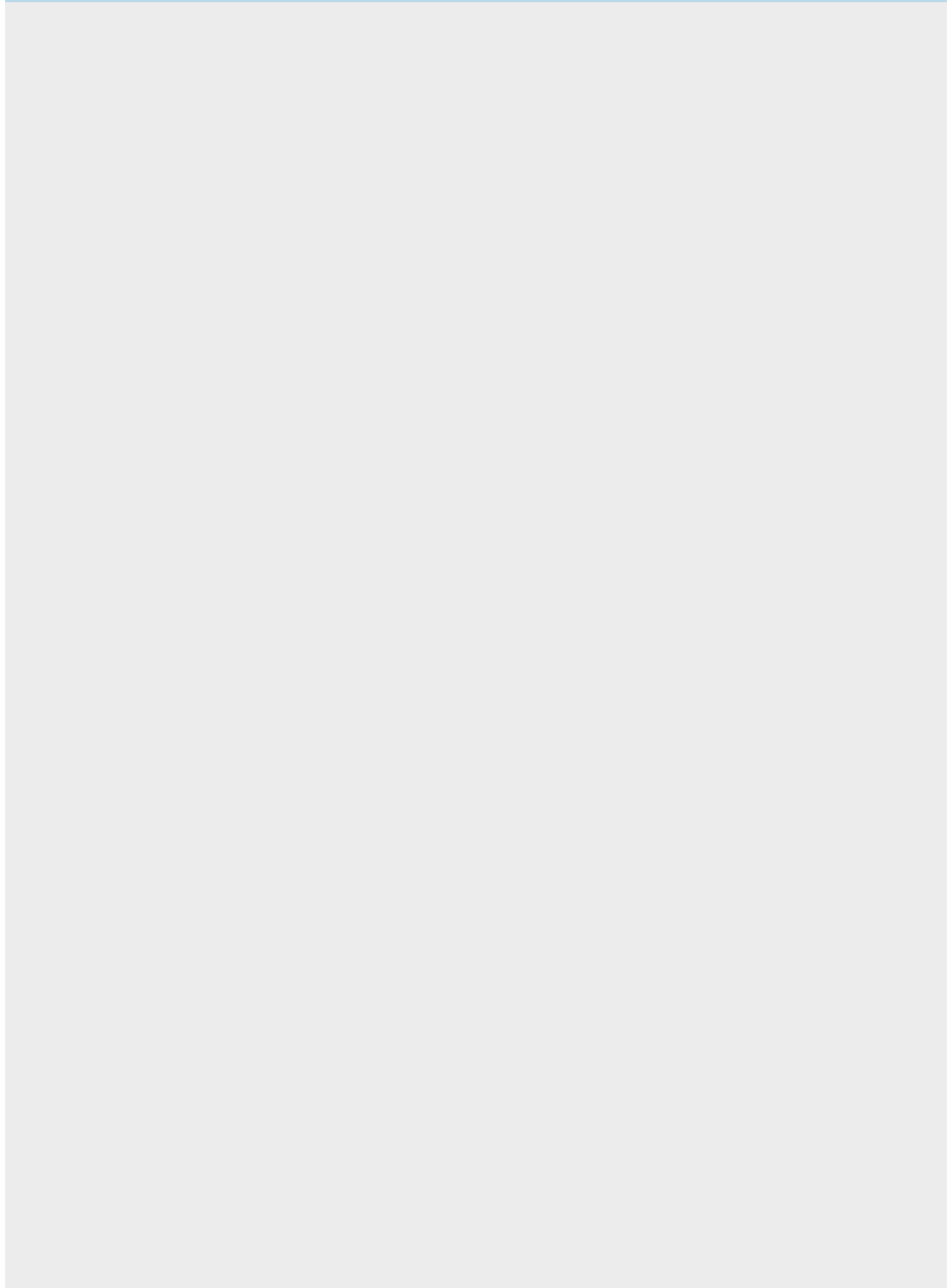



afety precautions	Features	How to install	How to use	How to store and clean	Troubleshooting	Specifications
-------------------	----------	----------------	------------	------------------------	-----------------	----------------

How to use

How to use the drive ▶

How to use the drive and other discs -

How to use MAGIC SPEED (Option) -

When the LED blinks -

Related links

<http://www.samsung-ODD.com>

<http://www.samsung.com>

Select model

SH-B123L(TS-HB43L) LightScrib

Select language

Select your language

Firmware Update

Check your firmware version.

Warranty Statement

Warranty statement for your product

How to use the drive

Caution

Do not switch off the PC while the LED indicator blinks green. Also do not disconnect the drive.

This can cause damage to the drive.

How to use a drive that is installed horizontally

You can use **3.15 inch or 4.72 inch (80 mm or 120 mm) discs**.

The drive can only read the disc correctly if the disc is placed inside the tray guiding line.

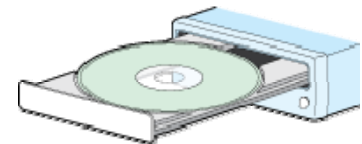

How to use a drive that is installed vertically

You can install and use this drive vertically.

You can only use **4.72 inch (120 mm) discs**.

The drive can only read the disc correctly if the disc is placed inside the tray guiding line.

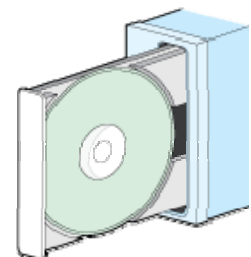

Top

afety precautions	Features	How to install	How to use	How to store and clean	Troubleshooting	Specifications
-------------------	----------	----------------	------------	------------------------	-----------------	----------------

How to use
How to use the drive
How to use the drive and other discs
How to use MAGIC SPEED (Option)
When the LED blinks

Related links

<http://www.samsung-ODD.com>

<http://www.samsung.com>

Select model

SH-B123L(TS-HB43L) LightScri

Select language

Select your language

Firmware Update

Check your firmware version.



Warranty Statement

Warranty statement for your product

How to use discs

Important

The BD-ROM/DVD Writer lets you write DVD±RW discs with **Cyberlink Power2go** and enables "packet writing" (high-speed recording) with **Instant Burn**.

The drive also lets you write DVD±R discs with **Cyberlink Power2go**.

Caution

It is illegal to make unauthorized copies of DVD or software titles. A person who makes illegal copies can be held responsible for copyright infringement.

If you use low-quality discs, this can increase the recording time or make it impossible to use the disc.

- ▶ You can use the drive to play Audio CD, CD-ROM, CD-R/RW and DVD-ROM discs. If your computer recognizes the [CD-ROM] icon designated to the BD-ROM/DVD writer as the 'E:' drive, insert a CD-ROM or a DVD-ROM disc and access the 'E:' drive.
- ▶ To play a DVD Video disc:
 - You need a DVD decoder board or DVD decoder software program. (Provided with Power DVD)
 - Use Power DVD to change the region code of the BD-ROM/DVD Writer.

DVD Region Protection Coding (RPC)

DVD Region Protection Coding (RPC):

The RPC feature is supported on DVD players and is used with DVD-video discs (such as movies). The motion picture industry has divided the world into different regions that correspond to the regional markets into which the motion picture industry releases movies. Movies worldwide have RPC codes, based on the region of the world in which they are being sold. These RPC codes help to control and prevent pirating of new movies into other motion picture regions before their release within those markets.

This drive supports RPC phase II. In the RPC-2 mode, users can change the local code. RPC-2 is selected by default for this drive.

You can change the region code up to five times via an MPEG application.

Please contact your dealer or local SAMSUNG representative if you need to change the local code more than five times.

[↑ Top](#)



afety precautions	Features	How to install	How to use	How to store and clean	Troubleshooting	Specifications
-------------------	----------	----------------	------------	------------------------	-----------------	----------------

How to use
How to use the drive -
How to use the drive and other discs -
How to use MAGIC SPEED (Option) ▶
When the LED blinks -

Related links

<http://www.samsung-ODD.com>

<http://www.samsung.com>

Select model

SH-B123L(TS-HB43L) LightScri

Select language

Select your language

Firmware Update

Check your firmware version.



Warranty Statement

Warranty statement for your product

How to use MAGIC SPEED (Option)

■ What is MAGIC SPEED?

MAGIC SPEED is a program that enables the user to select the reading speed of CD disc between two modes offered by the drive: **Maximum Speed Mode (Max Mode)** and **Silent Mode**.

! Important

MAGIC SPEED may not be provided depending on the specifications.

■ Development background

Modern ODD products offer a high reading speed.

With the increased reading speed, faster data processing has become possible. However, high rotation speed often causes more noise, and it is more probable that damaged discs crash. Against this backdrop, we have developed a **Speed-down** algorithm and applied this technology to newly-launched products to provide a safer and more comfortable environment.

! What is the Speed-down Algorithm?

The Speed-down Algorithm operates the device at a safer disc reading speed. This prevents possible disc crashes when the disc has cracks. For customers who want to play CDs at maximum speed, **MAGIC SPEED** lets customers choose the reading speed. (The writing speed will not be limited)

↑ Top

■ What is MAGIC SPEED and how to use it?

MAGIC SPEED mode

- ▶ **Max Mode:** Set the reading speed to the maximum level for the drive.
- ▶ **Silent Mode:** Set the reading speed to a stable low speed.
- ▶ When the PC restarts, all modes set by **MAGIC SPEED** will be reset to low noise mode. If you want to use the maximum speed mode, change the settings as necessary.

! Caution

A disc with a crack can crash when you operate it in **Max Mode**. We recommend you that you use such discs in **Silent Mode**. We also recommend that you make a copy of such discs and use the copy.

All Contents Copyright © 2001 - 2010

SAMSUNG Electronics Co., Ltd.

Optical Disc Drive

How to use MAGIC SPEED

1. Get the **MAGIC SPEED** program from our website. Then install it on your computer.
2. Right-click the **MAGIC SPEED** tray icon to start the program.
3. Select the desired mode and select **Settings**. The reading speed of the drive will be in the selected mode.
4. Select **Close** to exit.



The reading speed will be active until it is changed or the program stops.

Note

- ▶ We recommend you to use **Max Mode** for data copy or disc copy, and **Silent Mode** for normal operation.

- ▶ Other functions

- **To disable Auto-Run**

This is a default feature that automatically runs when the PC starts.

If you want to disable the auto-run feature, deselect the auto-run option in the tray icon menu.

Where can I download MAGIC SPEED?

Visit our website (www.samsung-ODD.com) for customer support, and select **Firmware** > **MAGIC SPEED**.

Top



afety precautions	Features	How to install	How to use	How to store and clean	Troubleshooting	Specifications
-------------------	----------	----------------	------------	------------------------	-----------------	----------------

How to use

How to use the drive -

How to use the drive and other discs -

How to use MAGIC SPEED (Option) -

When the LED blinks ▶

Related links

<http://www.samsung-ODD.com>

<http://www.samsung.com>

Select model

SH-B123L(TS-HB43L) LightScrib

Select language

Select your language

Firmware Update

Check your firmware version.

Warranty Statement

Warranty statement for your product

When the LED blinks

Status	LED
Disc Lead-In	Blue: Blinks every 0.3 seconds.
Writing	Blue: Blinks every 0.3 seconds.
Reading	Blue: Blinks every 0.3 seconds.
Audio Playback [Digital Mode]	Blue: Blinks every 0.3 seconds.
Standby	Off
No Disc	Off

Note

The indicator light goes off when the drive is not in use (standby) after disc lead-in.

Top



afety precautions	Features	How to install	How to use	How to store and clean	Troubleshooting	Specifications
-------------------	----------	----------------	------------	------------------------	-----------------	----------------

How to store and clean

How to clean the drive ▶

How to store discs -

How to clean discs -

Related links

<http://www.samsung-ODD.com> 

<http://www.samsung.com> 

Select model

SH-B123L(TS-HB43L) LightScrib

Select language

Select your language 

Firmware Update

Check your firmware version. 

Warranty Statement

Warranty statement for your product 

How to clean the drive

1. Switch off the PC and pull the drive out.
2. Use a soft cloth to remove any foreign matter from the surface of the drive.

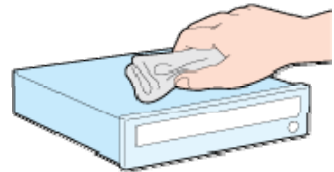

Caution

- ▶ Do not use benzene, paint thinner or other solvents.
- ▶ Do not use cotton swabs or similar items to clean the interior of the unit. This can cause damage to the unit.

 Top

Safety precautions	Features	How to install	How to use	How to store and clean	Troubleshooting	Specifications
------------------------------------	--------------------------	--------------------------------	----------------------------	--	---------------------------------	--------------------------------

How to store and clean

[How to clean the drive](#) -

[How to store discs](#) ▶

[How to clean discs](#) -

Related links

<http://www.samsung-ODD.com> 

<http://www.samsung.com> 

Select model

SH-B123L(TS-HB43L) LightScrib

Select language

Select your language

Firmware Update

Check your firmware version. 

Warranty Statement

Warranty statement for your product 

How to store discs

Important

This part of the manual gives information to prevent damage or data loss.
Read carefully and use the device correctly.

- ▶ Do not place it in direct sunlight.
- ▶ Place it so that it sits on its side on a flat surface.
- ▶ Do not scratch the disc or put a label on it.
- ▶ Handle the disc carefully to prevent damage from an external shock.
- ▶ Do not expose it to large temperature changes.
(Exposure to such environment can cause congealing.)

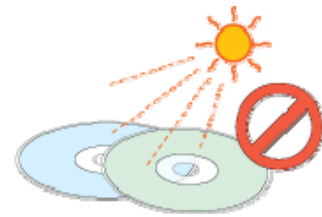

 [Top](#)

afety precautions	Features	How to install	How to use	How to store and clean	Troubleshooting	Specifications
-------------------	----------	----------------	------------	------------------------	-----------------	----------------

How to store and clean

How to clean the drive -

How to store discs -

How to clean discs ▶

Related links

<http://www.samsung-ODD.com> 

<http://www.samsung.com> 

Select model

SH-B123L(TS-HB43L) LightScril

Select language

Select your language

Firmware Update

Check your firmware version. 

Warranty Statement

Warranty statement for your product 

How to clean discs

Important

This part of the manual gives information to prevent damage or data loss.
Read carefully and use the device correctly.

- ▶ Do not touch the surface of the disc.
Put your fingers on the edge of the disc to hold it.

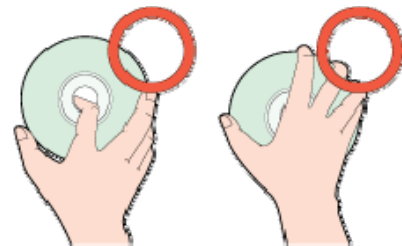

- ▶ Use a soft cotton cloth to clean the disc. Start from the center and move to the edge of the disc.
- ▶ Use only disc-cleaning liquids. Do not use benzene, paint thinner or other solvents.

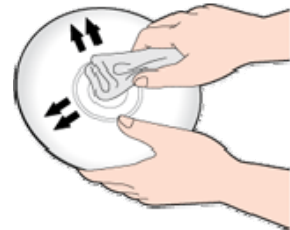

Note

If the disc surface becomes dirty with fingerprints, foreign substances or dust, the disc will not function properly.

 Top

afety precautions	Features	How to install	How to use	How to store and clean	Troubleshooting	Specifications
-------------------	----------	----------------	------------	------------------------	------------------------	----------------

Troubleshooting
Troubleshooting ▶
Caution: possible errors -

Related links

<http://www.samsung-ODD.com> 

<http://www.samsung.com> 

Select model

SH-B123L(TS-HB43L) LightScriber

Select language

Select your language

Firmware Update

Check your firmware version. 

Warranty Statement

Warranty statement for your product 

Troubleshooting

■ General problems

Problem	Meaning / Solution
The tray does not open.	Make sure that the PC is on.
	Make sure that the power cable within the PC is connected correctly.
	If the tray still does not open when the power is on, switch off the power and insert a pin (paper clip) into the emergency hole.
The tray does not close.	Make sure that the disc is inserted correctly.
The PC is not working correctly.	Make sure that the drive is connected correctly to the PC.
	See if there is a floppy disc in the PC.
The system does not read the disc.	Make sure that the system detects the drive.
	Make sure that you use a disc type that is supported by the drive.
	Make sure that the LED indicator becomes blue.
	Make sure that you inserted the disc with the label facing up.
	Make sure that you use the correct program to play the disc.
	Make sure that the disc is clean.
	Examine the drive for congealing.
Make sure that the region code of the drive matches the region code of the disc.	

You can confirm the software version on our customer support site.

Address: www.samsung-ODD.com 

▶ See **SUPPORT > Download Center > User Manual**.

For more information on using the software, refer to the help section provided by the software program or visit the company's website.

 Top



afety precautions	Features	How to install	How to use	How to store and clean	Troubleshooting	Specifications
-------------------	----------	----------------	------------	------------------------	------------------------	----------------

Troubleshooting
Troubleshooting -
Caution: possible errors ▶

Related links

<http://www.samsung-ODD.com> 

<http://www.samsung.com> 

Select model

SH-B123L(TS-HB43L) LightScrib 

Select language

Select your language 

Firmware Update

Check your firmware version. 

Warranty Statement

Warranty statement for your product 

Caution: Possible errors

The drive uses laser light to write data onto the surface of the disc. Writing errors can occur if you use a damaged disc. Make sure to prevent the conditions below before you start to write a disc.

Note

These settings are recommended for all drives.

- Do not use multitasking. Disable the screen saver.
 - ▶ A buffer under-run can occur if the system uses multitasking while the drive writes data.
- Do not let any outside computer access the host PC while the drive writes data.
 - ▶ An error can occur if another user accesses a network printer while the drive writes data.
- Disable the CD auto-run feature on all drives.
 - ▶ If you insert an auto-run CD into another drive within the same system while the drive writes data, this can cause an error.
- It is recommended that you use the image file format when you write a large number of small-sized files.
 - ▶ When there are many small files to write, the transfer rate decreases and the Buffer underrun protection feature works at a more frequent rate. This causes a lower writing quality.
 - ▶ If you are doing a CD-to-CD copy, it is not necessary to verify if you have available space on your hard disc.

However, in the case of image files, we recommend that you make sure you to have at least two times the amount of space needed for the data on your hard disc. This is because image files are copied to the hard disc before they are copied to the media.
- Use a regulation-length (50 cm) or shorter S-ATA cable.
 - ▶ If you use an S-ATA cable longer than 50 cm, this can cause a transmission error.
- Do not use more than one type of writing software.
 - ▶ Before you install a writing program, make sure to first uninstall existing versions of the program or other writing programs. After you uninstall any software, restart the PC. (The Windows operating system can be damaged if you install different language versions)

Note

We recommend that you use the data recording software provided by Samsung. If you use other recording software, this can cause an error.

All Contents Copyright © 2001 - 2010

SAMSUNG Electronics Co., Ltd.

Optical Disc Drive

The write speed for a disc can be restricted if:

1. **The disc has bad properties, or there are other discs with bad properties under the same ID.**



The drive examines the disc properties to determine the best write conditions for the type of disc. Because the two types of disc have the same property data but different properties, it is often not possible to use the same settings. It is necessary to decrease the writing speed to make the writing more stable.

If discs from two different disc makers have the same writing speed according to the labels, but actually have different writing speeds, it is necessary to reduce the writing speed.

2. **Samsung standards to decrease writing speed**

▶ **Standard 1:** If there are high-speed discs in the market that have very bad property data, the writing speed is decreased. This also happens if there are low-speed discs with the same ID.

▶ **Standard 2:** Discs for which the speed was reduced, will be examined again. If low-speed discs are no longer available in the market under the same ID as a high-speed disc, the decreased writing speed will no longer apply to the high-speed disc.

Note

It is possible that you do not get good writing quality with discs from manufacturers that are not registered in the drive's firmware.

We thus recommend that you only use discs from recommended companies.

Always make sure that the writing was successful before you put the disc in storage. This is very important when you want to store important data.

(Samsung is not responsible for any loss caused by a backup failure)

Note

We update the list of supported media on a regular basis and make them available in our firmware upgrades.

Top

afety precautions	Features	How to install	How to use	How to store and clean	Troubleshooting	Specifications
-------------------	----------	----------------	------------	------------------------	-----------------	----------------

Specifications

Product specifications ▶

Related links

<http://www.samsung-ODD.com>

<http://www.samsung.com>

Select model

SH-B123L(TS-HB43L) LightScri

Select language

Select your language

Firmware Update

Check your firmware version.



Warranty Statement

Warranty statement for your product

Product specifications

■ Specifications

Category		SH-B123L (TS-HB43L)	
		BD-ROM/DVD writer	
Disc	Usable discs	BD: BD-ROM(DL), BD-R(DL), BD-RE(DL), Hybrid Disc DVD: DVD-ROM(DL), DVD-R(DL), DVD-RW, DVD+R(DL), DVD+RW, DVD-RAM, DVD-Video, LightScribe DVD-R, LightScribe DVD+R CD: CD-ROM, CD-R, CD-RW, CD-DA, CD+E (G), CD-MIDI, CD-TEXT, CD-ROM XA, Mixed Mode CD, CD-I, CD-I Bridge (Photo-CD, Video-CD), Multisession CD (Photo-CD, CD-EXTRA, Portfolio), LightScribe CD-R	
	Disc diameter	3.15 inch or 4.72 inch (80 mm or 120 mm)	
Interface support	Interface port	S-ATA	
	Burst Transfer Rate	S-ATA 1.5 Gbps	
Access time (random)	BD-ROM	210 ms	
	DVD-ROM	150 ms	
	CD-ROM	150 ms	
Data transfer speed (max)	Media type	Write	Read
	BD-ROM	-	CAV 12X
	BD-R/RE/ROM DL/R DL	-	CAV 8X
	BD-RE DL	-	CAV 6X
	DVD+R	CAV 16X	CAV 16X

All Contents Copyright © 2001 - 2010	Category		SH-B123L (TS-HB43L)	
			BD-ROM/DVD writer	
SAMSUNG Electronics Co., Ltd.	Optical Disc Drive	DVD+RW	ZCLV 8X	CAV 12X 
		DVD+R DL	ZCLV 8X	CAV 12X
		DVD-R DL	ZCLV 8X	CAV 12X
		DVD-R	CAV 16X	CAV 16X
		DVD-RW	ZCLV 6X	CAV 12X
		DVD-ROM	-	CAV 16X
		DVD-ROM DL	-	CAV 12X
		DVD-RAM	PCAV 12X	PCAV 12X
		CD-ROM	-	CAV 48X
		CD-R	CAV 48X	CAV 40X
		US-RW	ZCLV 24X	CAV 40X
		HS-RW	CLV 10X	CAV 40X
		CD-RW	CLV 4X	CAV 40X
Buffer memory		2 MB		
Drive installation		Horizontal / Vertical		
Operating environment	Temperature	41 ℉ ~ 113 ℉ (5 °C ~ 45 °C)		
	Humidity	5% ~ 80% (RH)		
Dimensions (width x height x length)		148.2 x 42 x 170 mm		
Weight		750 g		

Disc labeling time

Media type	Setting	Titles only	The entire label area (including graphics)
CD media	Best	Less than 3:30 min	Less than 28:00 min
DVD media	Best	Less than 3:30 min	Less than 30:00 min

 **Note**

- ▶ Does not support DVD-R for Authoring.
- ▶ Cannot playback or record on both sides of a dual layer disc simultaneously.
- ▶ The read/write capacity of the supported discs depends on the condition of the disc and the recording format of the drive. Therefore, the read/write quality may not be perfect.

- ▶ Severe vibration or external impact may decrease the quality of printed images.
- ▶ Firmly install the product into the PC before use.
- ▶ In case of a disc identification error message, thoroughly clean the surface of the disc where the label is presented and then start printing.
- ▶ The quality of the printed image cannot be ensured if printing an image on the area which is already used for printing.
- ▶ For more information on the writing, install CyberLink software and refer to the HELP section.
- ▶ Specifications are subject to change without notice.

[↑ Top](#)

■ FCC information to the user

This equipment has been tested and found to comply with the limits for a Class B digital device, pursuant to Part 15 of the FCC Rules. These limits are designed to provide reasonable protection against harmful interference in a residential installation.

This equipment generates, uses and can radiate radio frequency energy and, if not installed and used in accordance with the instructions, may cause harmful interference to radio communications.

However, there is no guarantee that interference will not occur in a particular installation. If this equipment does cause harmful interference to radio or television reception, which can be determined by turning the equipment off and on, the user is encouraged to try to correct the interference by one or more of the following measures:

- ▶ Reorient or relocate the receiving antenna.
- ▶ Increase the separation between the equipment and receiver.
- ▶ Connect the equipment into an outlet on a circuit different from that to which the receiver is connected.
- ▶ Consult the dealer or an experienced radio/TV technician for help.

! Caution

Change or modifications not expressly approved by the manufacturer responsible for compliance could void the user's authority to operate the equipment.

[↑ Top](#)

■ Laser Standard

EN 60825-1:2007

i Important

The product specifications above may be changed to improve device performance without prior notice.

[↑ Top](#)

Safety precautions	Features	How to install	How to use	How to store and clean	Troubleshooting	Specifications
--------------------	----------	----------------	------------	------------------------	-----------------	----------------

Index

Related links

<http://www.samsung-ODD.com> 

<http://www.samsung.com> 

Select model

SH-B123L(TS-HB43L) LightScribble

Select language

Select your language

Firmware Update

Check your firmware version. 

Warranty Statement

Warranty statement for your product 

Index

Safety precautions

- ▶ Safety precautions
- ▶ During installation
- ▶ During operation
- ▶ Others
- ▶ RoHS and WEEE

Features

- ▶ Exterior
- ▶ System requirements
- ▶ Features

How to install

- ▶ How to install the drive
- ▶ How to connect the cables
- ▶ How to install the driver
- ▶ How to update the Firmware
- ▶ How to remove the utilities

How to use

- ▶ How to use the drive
- ▶ How to use the drive and other discs
- ▶ How to use MAGIC SPEED (Option)
- ▶ When the LED blinks

How to store and clean

- ▶ How to clean the drive
- ▶ How to store discs
- ▶ How to clean discs

Troubleshooting

- ▶ Troubleshooting
- ▶ Caution: possible errors

Specifications

- ▶ Product specifications

[↑ Top](#)

All Contents Copyright © 2001 - 2010



SAMSUNG Electronics Co., Ltd. Optical Disc Drive

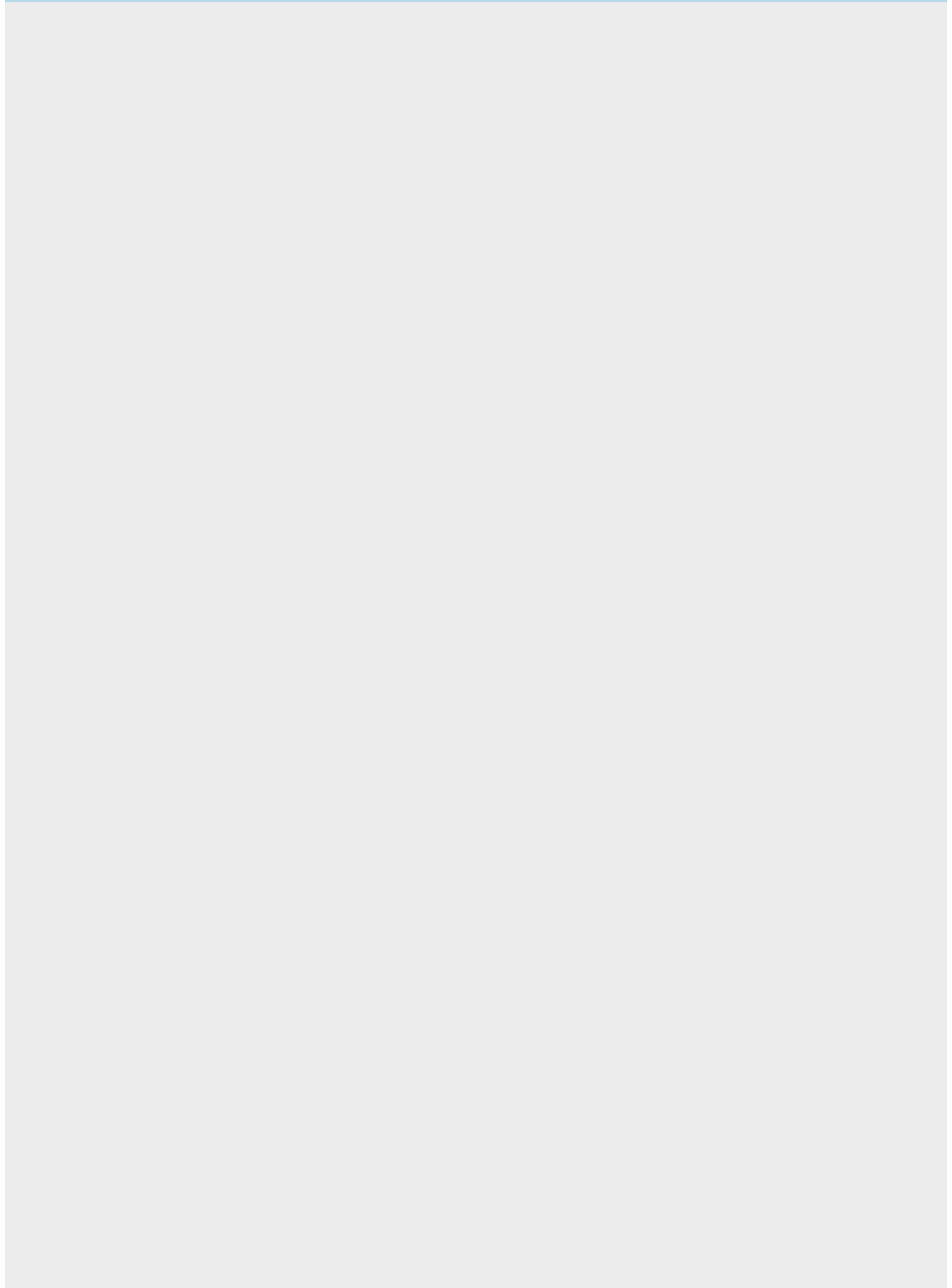

Free Manuals Download Website

<http://myh66.com>

<http://usermanuals.us>

<http://www.somanuals.com>

<http://www.4manuals.cc>

<http://www.manual-lib.com>

<http://www.404manual.com>

<http://www.luxmanual.com>

<http://aubethermostatmanual.com>

Golf course search by state

<http://golfingnear.com>

Email search by domain

<http://emailbydomain.com>

Auto manuals search

<http://auto.somanuals.com>

TV manuals search

<http://tv.somanuals.com>