

PCA-6189

**Full-sized PCI/ISA-bus socket
479 Pentium® M/ Celeron® M
processor-based CPU card**

User's Manual

Copyright Notice

This document is copyrighted, 2005, by Advantech Co., Ltd. All rights are reserved. Advantech Co., Ltd. reserves the right to make improvements to the products described in this manual at any time without notice. No part of this manual may be reproduced, copied, translated or transmitted in any form or by any means without the prior written permission of Advantech Co., Ltd. Information provided in this manual is intended to be accurate and reliable. However, Advantech Co., Ltd. assumes no responsibility for its use, nor for any infringements upon the rights of third parties which may result from its use.

Acknowledgements

- AWARD is a trademark of Phoenix Technologies Ltd.
- IBM and PC are trademarks of International Business Machines Corporation.
- Intel®, Pentium® M / Celeron® M are trademarks of Intel Corporation.
- WinBond is a trademark of Winbond Corporation.

All other product names or trademarks are the properties of their respective owners.

Part No. 2002618900
Printed in Taiwan

4th Edition
March 2005

1.0.1 A Message to the Customer

Advantech customer services

Each and every Advantech product is built to the most exacting specifications to ensure reliable performance in the harsh and demanding conditions typical of industrial environments. Whether your new Advantech equipment is destined for the laboratory or the factory floor, you can be assured that your product will provide the reliability and ease of operation for which the name Advantech has come to be known. Your satisfaction is our primary concern. Here is a guide to Advantech's customer services. To ensure you get the full benefit of our services, please follow the instructions below carefully.

Technical support

We want you to get the maximum performance from your products. So if you run into technical difficulties, we are here to help. For the most frequently asked questions, you can easily find answers in your product documentation. These answers are normally a lot more detailed than the ones we can give over the phone.

So please consult this manual first. If you still cannot find the answer, gather all the information or questions that apply to your problem, and with the product close at hand, call your dealer. Our dealers are well trained and ready to give you the support you need to get the most from your Advantech products. In fact, most problems reported are minor and are able to be easily solved over the phone.

In addition, free technical support is available from Advantech engineers every business day. We are always ready to give advice on application requirements or specific information on the installation and operation of any of our products.

Table 1.1: PCA-6189 comparison table

Model	PCA-6189VE-00A2	PCA-6189VG-00A2	PCA-6189G2-00A2	PCA-6189F-00A2
VGA: Intel 855GME integrated	Yes	Yes	Yes	Yes
USB 2.0 port	2	2	4	4
LAN 1: Intel 82551QM 10/100Base-T	Yes	No	No	No
LAN 1: Intel 82541 10/100/1000Base-T	No	Yes	Yes	Yes
LAN 2: Intel 82541 10/100/1000Base-T	No	No	Yes	Yes
Dual Channel Ultra 160 SCSI: Adaptec 7899	No	No	No	Yes

Table 1.2: PCA-6189 DDR memory compatibility table

Vendor	Size	Speed	Type	ECC	Model	Memory
Apacer	256MB	DDR266	DDR	N	77.10603 .112	Infineon HYB25D25680B T-7(32×8)
Kingston	256MB	DDR266	DDR	N	NA	Nanya NT5DS32MBAT- 6
	256MB	DDR266	DDR	N	"KVR256 X64C25/ 256	"Kingston D328DM- 60(32×8)
	512MB	DDR266	DDR	N	KVR266 X64C25/ 512	Kingston D328DL- 60(32×8)
	512MB	DDR266	DDR	N	9905006- 30.A00	Kingston D328DP-75
Apacer	512MB	DDR333	DDR	N	NA	SAMSUNG K4H560838C- TCB3(32×8)
Transcend	256MB	DDR333	DDR	N	TS32ML D64V3F5	SAMSUNG K4H560838D- TCB3(32×8)
Samsung (DSL)	256MB	DDR333	DDR	N	NA	SAMSUNG K4H560838F- TCB3(32×8)
Kingston	512MB	DDR333	DDR	N	KVR333 X64C25/ 512	Kingston D328DM- 60(32×8)
	512MB	DDR333	DDR	N	NA	Nanya NT5DS32MBAT- 6
Apacer	512MB	DDR400	DDR	N	77.10736 .19G	Infineon HYB25D256807 BT-5(32×8)
Transcend	256MB	DDR400	DDR	N	TS32ML D64V4F3	MOSEL V58C2256804SA T5(32×8)
	512MB	DDR400	DDR	N	TS64ML D64V4F3	SAMSUNG K4H560838F- TCCC(32×8)

Sam- sung(DSL)	512MB	DDR400	DDR	N	NA	SAMSUNG K4H560838F- TCCC(32×8)
Kingston	256MB	DDR400	DDR	N	KVR400 X64C3/ 256	Hynix HY5DU56822BT- D43(32×8)
UG	1GB	DDR266	DDR	N	NA	Hynix HY5DU128822A T-H
Apacer	512MB	DDR333	DDR	N	77.10728 .56G	Mosel V58C2256804SA T5B
DSL	512MB	DDR333	DDR	N	NA	SAMSUNG K4H560838F- TCB3
	1GB	DDR333	DDR	N	NA	SAMSUNG K4H510838B- TCB3
Transcend	1GB	DDR333	DDR	N	NA	SAMSUNG K4H560438E- TCB3
Apacer	256MB	DDR400	DDR	N	77.10636 .115	Infineon HYB25D256800 BT-5
	256MB	DDR400	DDR	N	77.10636 .465	SAMSUNG K4H560838E- TCCC
	512MB	DDR400	DDR	N	77.10736 .114	Infineon HYB25D256800 BT-5
	512MB	DDR400	DDR	N	77.10736 .56G	Mosel V58C2256804SA T5B
	512MB	DDR400	DDR	N	77.10736 .464	SAMSUNG K4H560838E- TCCC
	1GB	DDR400	DDR	N	77.11136 .464	SAMSUNG K4H510838B- TCCC

DSL	256MB	DDR400	DDR	N	NA	Hynix HY5DU56822BT-D43
	256MB	DDR400	DDR	N	NA	SAMSUNG K4H560838E-TCCC
Kingston	256MB	DDR400	DDR	N	KVR400 X72C3A/ 256	Hynix HY5DU56822CT-D43
Transcend	1GB	DDR400	DDR	N	NA	SAMSUNG K4H510838B-TCCC
Apacer	512MB	DDR333	DDR	Y	77.10735 .114	Infineon HYB25D256800 BT-6
	512MB	DDR333	DDR	Y	77.10735 .464	SAMSUNG K4H560838E-TCB3
	1GB	DDR333	DDR	Y	77.11135 .464	SAMSUNG K4H510838B-TCB3
Apacer	512MB	DDR400	DDR	Y	77.10738 .114	Infineon HYB25D256800 BT-5
	1GB	DDR400	DDR	Y	77.11138 .464	SAMSUNG K4H510838B-TCCC
UG	512MB	DDR400	DDR	Y	NA	Hynix HY5DU56822CT-D43
Transcend	256MB	DDR400	DDR	Y	NA	Mosel V58C22568004S AT5
	512MB	DDR400	DDR	Y	NA	Mosel V58C22568004S AT5

* PCA-6189 only supports DDR333 RAM. If DDR400 RAM is used, it will operate at the speed of DDR333

1.0.1 Product warranty

Advantech warrants to you, the original purchaser, that each of its products will be free from defects in materials and workmanship for two years from the date of purchase.

This warranty does not apply to any products which have been repaired or altered by persons other than repair personnel authorized by Advantech, or which have been subject to misuse, abuse, accident or improper installation. Advantech assumes no liability under the terms of this warranty as a consequence of such events.

If an Advantech product is defective, it will be repaired or replaced at no charge during the warranty period. For out-of-warranty repairs, you will be billed according to the cost of replacement materials, service time and freight. Please consult your dealer for more details.

If you think you have a defective product, follow these steps:

- Step 1. Collect all the information about the problem encountered. (For example, type of PC, CPU speed, Advantech products used, other hardware and software used, etc.) Note anything abnormal and list any on-screen messages you get when the problem occurs.
- Step 2. Call your dealer and describe the problem. Please have your manual, product, and any helpful information readily available.
- Step 3. If your product is diagnosed as defective, obtain an RMA (return material authorization) number from your dealer. This allows us to process your return more quickly.
- Step 4. Carefully pack the defective product, a fully-completed Repair and Replacement Order Card and a photocopy proof of purchase date (such as your sales receipt) in a shippable container. A product returned without proof of the purchase date is not eligible for warranty service.
- Step 5. Write the RMA number visibly on the outside of the package and ship it prepaid to your dealer.

1.0.2 Initial Inspection

Before you begin installing your single board computer, please make sure that the following materials have been shipped:

1 PCA-6189 Pentium® M / Celeron® M processor-based single board computer	
1 PCA-6189 Startup Manual	
1 CD with driver utility and manual (in PDF format)	
1 FDD cable	P/N: 1700340640
2 Ultra ATA 100 HDD cables	P/N: 1701400452
2 Serial ATA HDD data cable	P/N: 1700071000
2 Serial ATA HDD power cable	P/N: 1703150102
1 ATX 12V power converter cable	P/N: 170304015K
1 Printer (parallel) port & COM port cable kit	P/N: 1701260305
1 Y cable for PS/2 keyboard and PS/2 mouse	P/N: 1700060202
1 DVI cable	P/N: 1700000821
1 Two USB ports cable	P/N: 1700100170
1 Heat sink and fan	P/N: 1960001631

If any of these items are missing or damaged, contact your distributor or sales representative immediately.

We have carefully inspected the PCA-6189 mechanically and electrically before shipment. It should be free of marks and scratches and in perfect working order upon receipt.

As you unpack the PCA-6189, check it for signs of shipping damage. (For example, damaged box, scratches, dents, etc.) If it is damaged or it fails to meet the specifications, notify our service department or your local sales representative immediately. Also notify the carrier. Retain the shipping carton and packing material for inspection by the carrier. After inspection, we will make arrangements to repair or replace the unit

1.0.3 Release Note

Date	Revision	Description
December 2004	1st. Edition	Initial Release

Important Safety Information

SAFETY INSTRUCTIONS

FCC

This device complies with the requirements in part 15 of the FCC rules: Operation is subject to the following two conditions:

- 1. This device may not cause harmful interference, and*
- 2. This device must accept any interference received, including interference that may cause undesired operation*

This equipment has been tested and found to comply with the limits for a Class A digital device, pursuant to Part 15 of the FCC Rules. These limits are designed to provide reasonable protection against harmful interference when the equipment is operated in a commercial environment. This equipment generates, uses, and can radiate radio frequency energy and, if not installed and used in accordance with the instruction manual, may cause harmful interference to radio communications. Operation of this device in a residential area is likely to cause harmful interference in which case the user will be required to correct the interference at his/her own expense. The user is advised that any equipment changes or modifications not expressly approved by the party responsible for compliance would void the compliance to FCC regulations and therefore, the user's authority to operate the equipment.

CAUTION!!

There is a danger of a new battery exploding if it is incorrectly installed. Do not attempt to recharge, force open, or heat the battery. Replace the battery only with the same or equivalent type recommended by the manufacturer. Discard used batteries according to the manufacturer's instructions.

Contents

Chapter 1	Hardware Configuration	2
1.1	Introduction	2
1.2	Features	3
1.3	Specifications	3
1.3.1	System.....	3
1.3.2	Memory.....	4
1.3.3	Input/Output.....	4
1.3.4	VGA interface.....	4
1.3.5	Ethernet LAN.....	5
1.3.6	Ultra 160 SCSI.....	5
1.3.7	Industrial features	5
1.3.8	Mechanical and environmental specifications.....	5
1.4	Jumpers and Connectors.....	5
	Table 1.1:Jumpers.....	6
	Table 1.2:Connectors.....	6
	Table 1.3:SCSI Daughter Board Connectors.....	7
	Table 1.4: On Board Switch	7
1.5	Board Layout: Jumper and Connector Location	8
	Figure 1.1:Jumper and Connector locations	8
	Figure 1.2:I/O Connectors	9
	Figure 1.3:SCSI daughter board	9
1.6	PCA-6189 Block Diagram	10
	Figure 1.4:Block Diagram	10
1.7	Safety Precautions	11
1.8	Jumper Settings	12
1.8.1	How to set jumpers	12
1.8.2	CMOS clear (J1).....	12
	Table 1.5:CMOS (J1).....	12
1.8.3	Watchdog timer output (J2).....	12
	Table 1.6:Watchdog timer output (J2).....	13
1.9	System Memory	13
1.9.1	CPU FSB and memory speed	14
	Table 1.7:CPU FSB and memory speed	14
1.10	Memory Installation Procedures	14
1.11	Processor Installation	14
Chapter 2	Connecting Peripherals	18
2.1	Introduction	18
2.2	1st & 2nd (CN1, CN2) IDE Connectors	18
2.3	Floppy Drive Connector (CN3).....	19
2.4	Parallel Port (CN4).....	20

2.5	USB Ports CN6, CN31, and CN32	21
2.6	VGA Connector CN7	22
2.7	LVDS connector VCN2	22
2.8	DVI connector VCN3.....	23
2.9	Ethernet Connector (CN8 and CN34).....	23
2.10	Serial Ports (COM1 : CN9; COM2 : CN10).....	24
2.11	PS/2 Keyboard/Mouse Connector (CN11/CN33).....	24
2.12	External Keyboard Connector (CN12).....	25
2.13	CPU Fan Connector (CN14)	25
2.14	Front Panel Connectors (CN16, 17, 18, 19, 21&29).....	26
	2.14.1 Power LED (CN16)	26
	2.14.2 External speaker (CN17)	26
	2.14.3 Reset (CN18)	27
	2.14.4 HDD LED (CN19).....	27
	2.14.5 ATX soft power switch (CN21).....	27
	2.14.6 SM Bus Connector (CN29).....	27
2.15	ATX feature connector (CN20).....	28
2.16	AC-97 Audio interface (CN43).....	28
2.17	Serial ATA interface (SA0 and SA1).....	29
2.18	Connecting to SNMP-1000 remote manager	29
2.19	Auxiliary 4-pin power connector (ATX1)	30
Chapter 3	Award BIOS Setup.....	32
3.1	Introduction	32
	3.1.1 CMOS RAM Auto-backup and Restore	32
3.2	Entering Setup	33
	Figure 3.1: Award BIOS Setup initial screen	33
3.3	Standard CMOS Setup	33
	Figure 3.2: Standard CMOS features screen	33
3.4	Advanced BIOS Features	34
	Figure 3.3: Advanced BIOS features screen.....	34
3.4.1	CPU Features	34
3.4.2	Hard Disk Boot Priority.....	34
3.4.3	Virus Warning.....	34
3.4.4	CPU L1 & L2 Cache, CPU L3 Cache	34
3.4.5	Quick Power On Self Test	35
3.4.6	First/Second/Third Boot Device	35
3.4.7	Boot Other Device	35
3.4.8	Swap Floppy Drive	35
3.4.9	Boot UP Floppy Seek	35
3.4.10	Boot Up NumLock Status.....	35
3.4.11	Gate A20 Option.....	35
3.4.12	Typematic Rate Setting.....	35
3.4.13	Typematic Rate (Chars/Sec).....	35

3.4.14	Typematic Delay (msec).....	35
3.4.15	Security Option	36
3.4.16	APIC Mode.....	36
3.4.17	MPS Version Control For OS.....	36
3.4.18	OS Select For DRAM > 64MB	36
3.4.19	Report No FDD For WIN 95	36
3.4.20	Small Logo(EPA) Show	36
3.5	Advanced Chipset Features.....	37
	Figure 3.4:Advanced chipset features screen	37
3.5.1	DRAM Timing Selectable	37
3.5.2	CAS Latency Time	37
3.5.3	Active to Precharge Delay	37
3.5.4	DRAM RAS# to CAS# Delay	38
3.5.5	DRAM RAS# Precharge.....	38
3.5.6	DRAM Data Integrity Mode.....	38
3.5.7	System BIOS Cacheable.....	38
3.5.8	Video Bios Cacheable.....	38
3.5.9	Memory Hole At 15M-16M	38
3.5.10	Delayed Transaction	38
3.5.11	Delay Prior to Thermal	38
3.5.12	AGP Aperture Size (MB)	39
3.5.13	Init Display First	39
3.5.14	On-Chip VGA.....	39
3.5.15	On-Chip Frame Buffer Size.....	39
3.5.16	Boot display	39
3.5.17	Panel Number	39
3.6	Integrated Peripherals.....	40
	Figure 3.5:Integrated peripherals.....	40
3.7	On-chip IDE Device.....	40
	Figure 3.6:On-Chip IDE Device.....	40
3.7.1	IDE DMA transfer access	40
3.7.2	On-Chip IDE Device	41
3.7.3	On-Chip Serial ATA	41
3.7.4	Serial ATA Port0/Port1 Mode.....	41
3.7.5	IDE HDD Block Mode	41
3.8	Onboard Device Menu	41
	Figure 3.7:Onboard Device.....	41
3.8.1	USB Controller	42
3.8.2	USB 2.0 Controller	42
3.8.3	USB Keyboard/Mouse Support	42
3.8.4	AC97 Audio.....	42
3.8.5	On-board LAN1 Control.....	42
3.8.6	On-board LAN2 Control.....	42
3.9	SuperIO Device	42
	Figure 3.8:SuperIO Device.....	42

3.9.1	On-board FDC Controller	43
3.9.2	On-board Serial Port 1	43
3.9.3	On-board Serial Port 2	43
3.9.4	UART Mode Select	43
3.9.5	RxD, TxD Active	43
3.9.6	IR Transmission Delay	43
3.9.7	UR2 Duplex Mode	43
3.9.8	Use IR Pins	43
3.9.9	On-board Parallel Port	43
3.9.10	Parallel Port Mode	43
3.9.11	EPP Mode Select	44
3.9.12	ECP Mode Use DMA	44
3.9.13	PWRON After PWR-FAIL	44
3.10	Power Management Setup	44
	Figure 3.9:Power management setup screen (1)	44
3.10.1	ACPI function	44
3.10.2	Power Management	44
3.10.3	Video Off Method	45
3.10.4	Video Off In Suspend	45
3.10.5	Suspend Type	45
3.10.6	Modem Use IRQ	45
3.10.7	Soft-Off by PWR-BTTN	45
3.10.8	CPU THRM-Throttling	45
3.10.9	Power On by LAN	46
3.10.10	Power On by Modem	46
3.10.11	Power On by Alarm	46
3.10.12	Primary IDE (0,1) and Secondary IDE (0,1)	46
3.10.13	FDD, COM, LPT PORT	46
3.10.14	PCI PIRQ [A-D]#	46
3.11	PnP/PCI Configurations	46
	Figure 3.10:PnP/PCI configurations screen	46
3.11.1	PNP OS Installed	47
3.11.2	Reset Configuration Data	47
3.11.3	Resources Controlled By	47
3.11.4	PCI/VGA Palette Snoop	47
3.12	PC Health Status	47
3.12.1	CPU Warning Temperature	47
	Figure 3.11:PC health status screen	47
3.12.2	Current System Temp	48
3.12.3	Current CPU Temperature	48
3.12.4	Current CPUFAN Speed	48
3.12.5	VCORE, VBAT(V), 5VSB(V)	48
3.12.6	Shutdown Temperature	48
3.13	Frequency/Voltage Control	48
	Figure 3.12:Spread Spectrum Control screen	48

	3.13.1	Auto-detect PCI CLK	48
	3.13.2	Spread Spectrum	48
	3.14	Passwords and Settings	49
	3.14.1	Load Setup Defaults.....	49
	3.14.2	Set Supervisor Password.....	49
	3.14.3	Set User Password	49
	3.14.4	Save & Exit Setup.....	49
	3.14.5	Exit Without Saving.....	49
Chapter	4	Chipset Software Install Utility.....	52
	4.1	Before you begin	52
	4.2	Introduction	52
	4.3	Windows XP Driver Setup.....	53
Chapter	5	VGA Setup	58
	5.1	Introduction	58
	5.2	Dynamic Video Memory Technology (DVMT)	58
	5.3	Windows XP Driver Setup.....	59
Chapter	6	LAN Configuration	64
	6.1	Introduction	64
	6.2	Features	64
	6.3	Installation.....	65
	6.4	Win XP Driver Setup (Intel 82541/82551)	65
Chapter	7	SCSI Setup & Configuration.....	70
	7.1	Introduction	70
	7.2	Understanding SCSI.....	71
	7.3	SCSI IDs.....	71
	7.4	Terminating the SCSI Bus.....	72
	7.5	Configuring the SCSI interface with SCSISelect.....	73
	7.6	Starting SCSISelect.....	75
	7.7	Using SCSI Disk Utilities	79
	7.8	Installation under Windows 2000	80
	7.9	Windows 9X Driver setup procedure.....	80
Chapter	8	USB 2.0 Configuration.....	86
	8.1	Introduction	86
	8.2	Features	86
	8.3	Installation	86
Chapter	9	Onboard Security Setup	88
	9.1	Introduction	88
	9.2	Windows XP Driver Setup.....	89
	9.3	Using the OBS Hardware Doctor Utility	91
Chapter	10	SATA RAID Setup	94

10.1	Introduction	94
10.2	Entering Setup	94
	Figure 10.1:RAID Setup initial screen	94
10.3	Array Configuration Utility	95
	Figure 10.2:SATA RAID Setup Main Menu screen.....	95
	10.3.1 Managing Arrays	95
	10.3.2 Creating Arrays.....	96
	10.3.3 Adding/Removing a Bootable Array	96
	10.3.4 Add/Delete Hotspares	96
	10.3.5 Initializing Disk Drives.....	96
	10.3.6 Rebuilding Arrays.....	97
10.4	Installing the driver	97
Appendix A Programming the watchdog		100
A.1	Programming the Watchdog Timer	100
	A.1.1 Watchdog timer overview.....	100
	A.1.2 Reset/ Interrupt selection	100
	A.1.3 Programming the Watchdog Timer	100
	A.1.4 Example Program	103
Appendix B Pin Assignments		110
B.1	IDE Hard Drive Connector (CN1, CN2).....	110
	Table B.1:IDE hard drive connector (CN1, CN2).....	110
B.2	Floppy Drive Connector (CN3).....	111
	Table B.2:Floppy drive connector (CN3)	111
B.3	Parallel Port Connector (CN4)	112
	Table B.3:Parallel port connector (CN4).....	112
B.4	USB Connector (CN6)	113
	Table B.4:USB1/USB2 connector (CN6).....	113
B.5	VGA Connector (CN7)	113
	Table B.5:VGA connector (CN7).....	113
B.6	VCN2 LVD connector	114
	Table B.6:VCN2 LVDS connector.....	114
B.7	VCN3 DVI connector.....	115
	Table B.7:VCN3 DVI connector	115
B.8	COM1/COM2 RS-232 Serial Port (CN9, CN10).....	115
	Table B.8:COM1/2 RS-232 serial port (CN9/10).....	115
B.9	PS/2 Keyboard/Mouse Connector (CN11).....	116
	Table B.9:PS/2 keyboard/mouse connector (CN11)...	116
B.10	External Keyboard Connector (CN12).....	116
	Table B.10:External keyboard connector (CN12)	116
B.11	Power LED (CN16).....	116
	Table B.11: CPU Fan Power Connector (CN14).....	116
B.12	Power LED (CN16).....	117
	Table B.12:Power LED (CN16)	117

B.13	External Speaker Connector (CN17).....	117
	Table B.13:External Speaker Connector (CN17)	117
B.14	Reset Connector (CN18)	118
	Table B.14:Reset connector (CN18).....	118
B.15	ATX Feature Connector (CN20).....	118
	Table B.15:HDD LED connector (CN19)	118
B.16	ATX Feature Connector (CN20).....	119
	Table B.16:ATX Feature Connector (CN20)	119
B.17	ATX Soft Power Switch (CN21)	119
	Table B.17:ATX soft power switch (CN21).....	119
B.18	H/W Monitor Alarm (CN22).....	120
	Table B.18:H/W Monitor alarm (CN22)	120
B.19	SM Bus Connector (CN29).....	120
	Table B.19:SM bus onnector (CN29).....	120
B.20	Audio Interface (CN43)	121
	Table B.20:Audio Interface(CN 43)	121
B.21	LCD Inverter power connectore (VP1).....	121
	Table B.21:LCD inverter power connector (CN 20) ..	121
B.22	System I/O Ports.....	122
	Table B.22:System I/O ports	122
B.23	DMA Channel Assignments.....	123
	Table B.23:DMA channel assignments	123
B.24	Interrupt Assignments	123
	Table B.24:Interrupt assignments	123
B.25	1st MB Memory Map	124
	Table B.25:1st MB memory map	124
B.26	PCI Bus Map	124
	Table B.26:PCI bus map.....	124

CHAPTER

1

General Information

Chapter 1 Hardware Configuration

1.1 Introduction

The PCA-6189 is designed with Intel® 855GME chipset and 6300ESB (I/O controller) to support the Intel® Pentium® M / Celeron® M processor, high speed DDR333 memory, and high performance I/O functions such as dual Gigabit Ethernet ports, Serial/parallel ATA ports, and a PCI-X (64-bit / 66Mhz) bus. With the compliance with PICMG 1.0 specification, PCA-6189 can be used with wide choice of existing PCI/ISA backplanes to meet versatile requirements of industrial applications.

The PCA-6189 is designed to deliver high performance but low thermal profile best for industrial embedded applications. It uses Intel's long-life 855GME and 6300ESB chipset, with the socket 479 it can supports vary on the Pentium® M and Celeron® M processor by different applications. It has 2 DIMM sockets and supports ECC (error checking and correction) function for best reliability. It accepts up to 2GB DDR 333/266 SDRAM memory, enough for most of applications. PCA-6189 could support dual Giga LAN with the Gigabit Ethernet ports controller -- Intel® 82541 which is connected to the 32-bit PCI bus of the 6300ESB I/O controller. With the 855GME integrated graphic controller PCA-6189 provides one VGA display connector one LVDS and one DVI interface for panel display. Two serial ATA ports (up to 150MB/s)which can support RAID 0,1 functions and allows the use of thin and long SATA cables for storage devices, eliminating the cabling issue inside an industrial grade chassis. In addition, the PCA-6189 also provides most of the popular I/O interfaces such as four USB 2.0 ports, AC-97 audio interface, 2 RS-232 ports, one enhanced parallel port and floppy disk interface.

The PCA-6189 is designed with reliability considerations to be suitable for industrial environments. A specially designed heat-sink is attached to the main chips to keep them cool and to extend the operating temperature to 60 degree Celsius. The CMOS data backup and restore function protects the BIOS setup data from loss due to battery failure. A 256-level watchdog timer prevents the system from hanging up if a program cannot be executed normally. A remote management port allows users to monitor the system healthy status and control the system remotely through the standard SNMP/HTTP protocols when used with Advantech's SNMP-1000 Intelligent System Manager.

Note: Some of the features mentioned above are not available with all models. For more information about the specifications of a particular model, see Table 1.1 : Comparison table and Section 1.3: Specifications.

1.2 Features

1. Supports FSB 400 MHz low thermal profile Intel® Pentium® M processor or Intel® Celeron® M processor
2. Supports 2 Serial-ATA devices with Software RAID 0 or 1 functions
3. Supports DDR 200/266/333 SDRAM up to 2GB
4. Optional onboard Adaptec AIC-7899 dual channel Ultra160 SCSI up to 160MB/sec.
5. Onboard integrated VGA controller supports LVDS and DVI interface
6. 64-bit, 66MHz PCI-X
7. Supports 10/100/1000Base-T Ethernet
8. Remote management with SNMP-1000-B1

1.3 Specifications

1.3.1 System

- **CPU:** Intel® socket 479 Celeron® M up to 1.5 GHz, Pentium® M up to 2.0 GHz, FSB 400 MHz
- **L2 Cache:** CPU built-in 512/1024/2048 KB full-speed L2 cache
- **BIOS:** Award Flash BIOS (4Mb Flash Memory)
- **System Chipset:** Intel 855GME + 6300ESB
- **SATA/EIDE hard disk drive interface:** Supports up to two independent Serial ATA hard drives (up to 150MB/s) with software RAID 0 or 1 functions, as well as two IDE hard disk drives, or four enhanced IDE devices. Supports PIO mode 4 (16.67 MB/s data transfer rate) and ATA 33/66/100 (33/66/100MB/s data transfer rate.)

- **Floppy disk drive interface:** Supports up to two floppy disk drives, 5¼" (360 KB and 1.2 MB) and/or 3½" (720 KB, 1.44 MB). BIOS enabled/disabled

1.3.2 Memory

- **RAM:** Up to 2 GB in two 184-pin DIMM sockets. Supports DDR266/333 SDRAM

1.3.3 Input/Output

- **Bus interface:** PICMG 1.0 compliant PCI/ISA bus interface
- **Enhanced parallel port:** Configurable to LPT1, LPT2, LPT3, or disabled. Standard DB-25 female connector provided. Supports EPP/SPP/ECP
- **Serial ports:** Two RS-232 ports with 16C550 UARTs (or compatible) with 16-byte FIFO buffer. Supports speeds up to 115.2 Kbps. Ports can be individually configured to COM1, COM2 or disabled
- **Keyboard and PS/2 mouse connector:** One 6-pin mini-DIN connector is located on the mounting bracket for easy connection to a keyboard or PS/2 mouse. An on board keyboard pin header connector is also available
- **ISA bus:** Supports ISA without DMA. PCI-to-ISA bridge: ITE IT8888
- **AC-97 Audio:** PCA-6189 can provide audio function with the optional audio extension module PCA-AUDIO-00A1
- **USB ports:** PCA-6189 supports up to four USB 2.0 ports with transmission rates up to 480Mbps; available on the I/O bracket (dual layer brackets only) or through the two-USB-port cable (P/N: 1700100170) for single layer version. With the dual layer versions, users can choose between CN32 on the I/O bracket or the on-board connector CN6, depending on their applications. For example, users can link CN6 to the front side panel thru the USB cable. Please note that users can't use CN32 on I/O bracket *and* CN6 at the same time. Users must set S1 and S2 (on the back side of the CPU card) correctly for the USB port configuration they are using. Please refer to section 2.5 for switch settings.

1.3.4 VGA interface

- **Controller:** Intel 855GME chipset integrated
- **Display memory:** Share system memory up to 64 MB, BIOS selectable
- **Resolution:** VGA port: 2048 x 1536, up to 75 Hz

LVDS connector, dual channel: 25 MHz to 112 MHz

DVI connector: 2048 x 1536, 75 MHz

1.3.5 Ethernet LAN

- Supports single 10/100Base-T networking or single/dual10/100/1000Base-T Ethernet networking
- **Controller:**
 - Single 10/100Base-T: Intel 82551QM
 - Single 10/100/1000Base-T: Intel 82541GI(PCI)
 - Dual 10/100/1000Base-T: Two Intel 82541GI (PCI)

1.3.6 Ultra 160 SCSI

- Provides dual channel Ultra 160 SCSI interface
- Chipset: Adaptec AIC7899

1.3.7 Industrial features

- **Watchdog timer:** Can generate a system reset or IRQ11. The watchdog timer is programmable, with each unit equal to one second or one minute (255 levels). You can find programming detail in Appendix A

1.3.8 Mechanical and environmental specifications

- **Operating temperature:** 0° ~ 60° C (32° ~ 140° F, depending on CPU)
- **Storage temperature:** -20° ~ 70° C (-4° ~ 158° F)
- **Humidity:** 20 ~ 95% non-condensing
- **Power supply voltage:** +5 V, ±12 V
- **Power consumption:** Typical : +5V:6.53A, +12V:4.57A (Intel Pentium® M 1.8 GHz with 400 MHz FSB, 512 MB DDR 333 SDRAM)
- **Board size:** 338 x 122 mm (13.3" x 4.8")
- **Board weight:** 0.5 kg (1.2 lb)

1.4 Jumpers and Connectors

Connectors on the PCA-6189 single board computer link it to external devices such as hard disk drives and a keyboard. In addition, the board has a number of jumpers used to configure your system for your application.

The tables below list the function of each of the board jumpers and connectors. Later sections in this chapter give instructions on setting jump-

ers. Chapter 2 gives instructions for connecting external devices to your single board computer.

Table 1.1: Jumpers	
Label	Function
J1	CMOS Clear
J2	Watchdog timer output selection

Table 1.2: Connectors	
Label	Function
CN1	Primary IDE connector
CN2	Secondary IDE connector
CN3	Floppy drive connector
CN4	Parallel port
CN6	USB port (share with CN32)
CN7	VGA connector
VCN2	LVDS connector
VCN3	DVI connector
CN8	Ethernet connector 1
CN9	Serial port: COM1
CN10	Serial port: COM2
CN11	PS/2 keyboard and mouse connector
CN12	External keyboard connector
CN13	Reserved
CN14	CPU FAN connector
CN16	Power LED
CN17	External speaker
CN18	Reset connector
CN19	HDD LED connector
CN20	ATX feature connector
CN21	ATX soft power switch (PS_ON)

Table 1.2: Connectors	
CN22	HW Monitor Alarm Close: Enable OBS Alarm Open: Disable OBS Alarm
CN27	Extension I/O board connector
CN28	Extension I/O board connector
CN29	SM BUS Connector PIN1: SMB_DATA PIN2: SMB_CLOCK
CN30	Extension PCI connector (for SCSI daughter board)
CN31	USB port 0,1
CN32	USB port 2,3
CN34	Ethernet connector 2
CN43	AC97 Link connector
CN44	CF Socket (On Back Side)
SA0	Serial ATA0
SA1	Serial ATA1
ATX1	ATX 12 V Auxillary power connector
VP1	LCD inverter power connector

Notice: The 4-pin ATX 12V power connector "ATX1" must be connected to the power supply to provide adequate power to the CPU card. Otherwise system might be unstable.

Table 1.3: SCSI Daughter Board Connectors	
CN1	Channel A 68-pin Ultra 160 SCSI Connector
CN2	Channel B 68-pin Ultra 160 SCSI Connector
CN3	Channel B 50-pin Ultra Wide SCSI Connector

Table 1.4: On Board Switch	
S1,S2	USB connector(CN6 or CN32) selection switch
SW1	PCI bus selection switch

1.5 Board Layout: Jumper and Connector Location

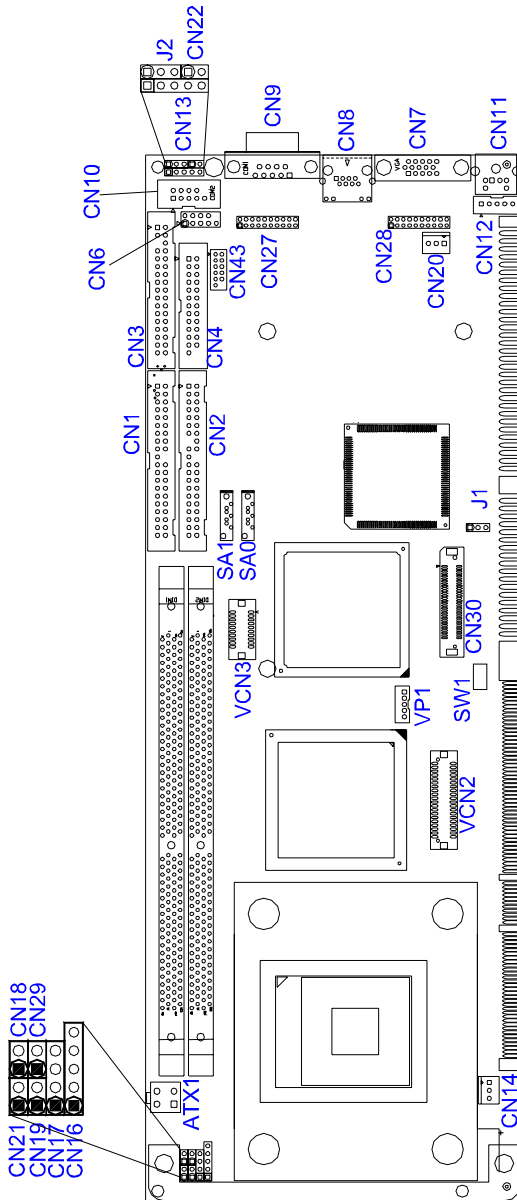

Figure 1.1: Jumper and Connector locations

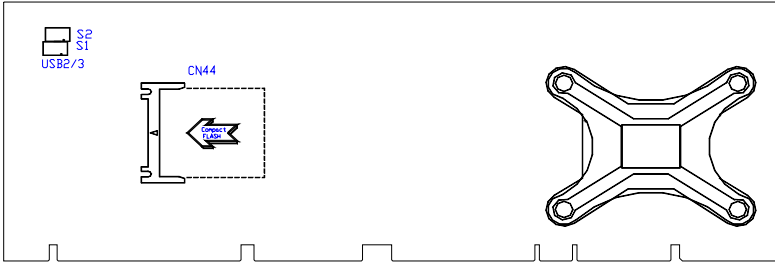

Figure 1.2: I/O Connectors

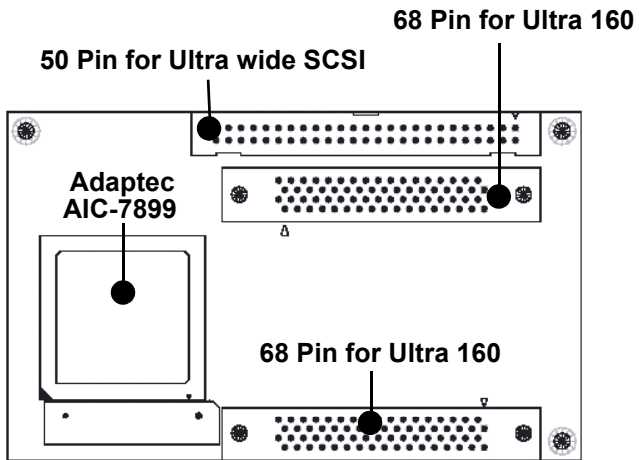

Figure 1.3: SCSI daughter board

1.6 PCA-6189 Block Diagram

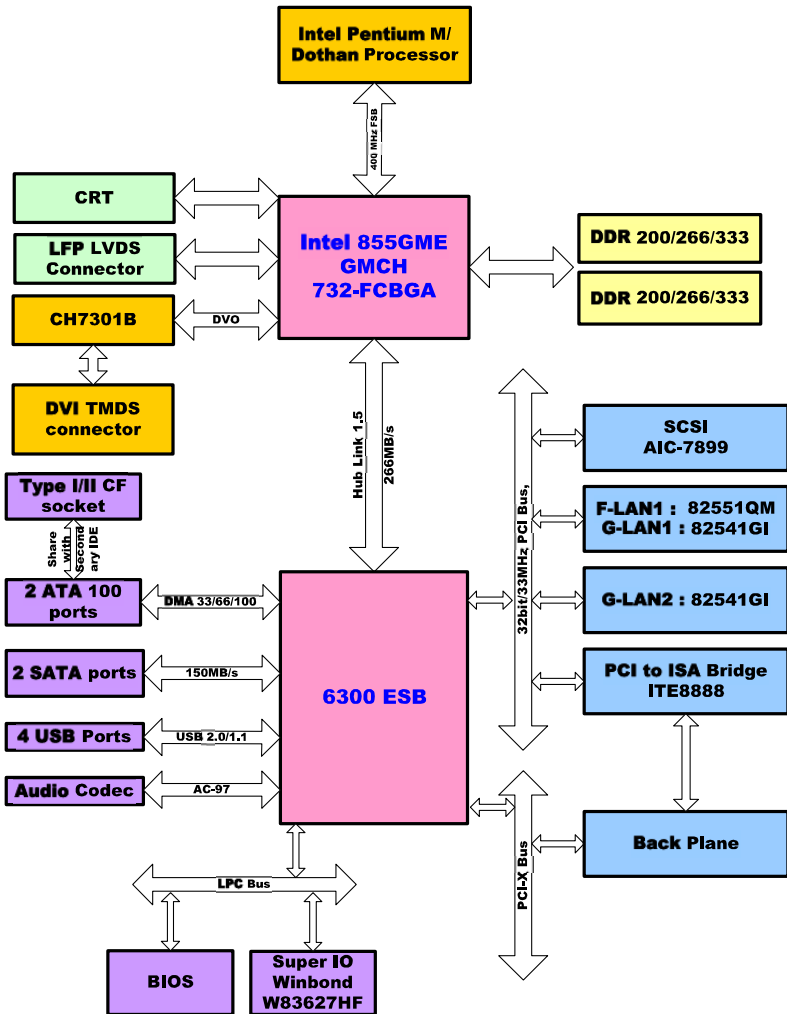

Figure 1.4: Block Diagram

1.7 Safety Precautions

Warning! Always completely disconnect the power cord from your chassis whenever you work with the hardware. Do not make connections while the power is on. Sensitive electronic components can be damaged by sudden power surges. Only experienced electronics personnel should open the PC chassis.

Caution! Always ground yourself to remove any static charge before touching the single board computer. Modern electronic devices are very sensitive to static electric charges. As a safety precaution, use a grounding wrist strap at all times. Place all electronic components on a static-dissipative surface or in a static-shielded bag when they are not in the chassis.

Caution! The computer is provided with a battery-powered Real-time Clock circuit. There is a danger of explosion if battery is incorrectly replaced. Replace only with same or equivalent type recommended by the manufacturer. Discard used batteries according to manufacturer's instructions.

Notice: Before install your PCA-6189 into a chassis, make sure that all components on both sides of the CPU card do not touch any metal parts, especially the chassis wall and add-on card at the adjacent slot.

1.8 Jumper Settings

This section provides instructions on how to configure your single board computer by setting the jumpers. It also includes the single board computer's default settings and your options for each jumper.



1.8.1 How to set jumpers

You can configure your single board computer to match the needs of your application by setting the jumpers. A jumper is a metal bridge that closes an electrical circuit. It consists of two metal pins and a small metal clip (often protected by a plastic cover) that slides over the pins to connect them. To “close” (or turn ON) a jumper, you connect the pins with the clip. To “open” (or turn OFF) a jumper, you remove the clip. Sometimes a jumper consists of a set of three pins, labeled 1, 2, and 3. In this case you connect either pins 1 and 2, or 2 and 3. A pair of needle-nose pliers may be useful when setting jumpers.

1.8.2 CMOS clear (J1)

The PCA-6189 single board computer contains a jumper that can erase CMOS data and reset the system BIOS information. Normally this jumper should be set with pins 1-2 closed. If you want to reset the CMOS data, set J1 to 2-3 closed for just a few seconds, and then move the jumper back to 1-2 closed. This procedure will reset the CMOS to its default setting.

Table 1.5: CMOS (J1)

Function	Jumper Setting
* Keep CMOS data	 1-2 closed
Clear CMOS data	 2 3 closed

* default setting

1.8.3 Watchdog timer output (J2)

The PCA-6189 contains a watchdog timer that will reset the CPU or send a signal to IRQ11 in the event the CPU stops processing. This feature means the PCA-6189 will recover from a software failure or an EMI problem. The J2 jumper settings control the outcome of what the computer will do in the event the watchdog timer is tripped.

Table 1.6: Watchdog timer output (J2)

Function	Jumper Setting
IRQ11	1  1-2 closed

* Reset	1  2-3 closed
---------	---

* default setting

Note: The interrupt output of the watchdog timer is a low level signal. It will be held low until the watchdog timer is reset.

1.9 System Memory

The PCA-6189 has two sockets for 184-pin dual inline memory modules (DIMMs).

All these sockets use 2.5 V unbuffered double data rate synchronous DRAMs (DDR SDRAM). They are available in capacities of 128, 256, 512 and 1024 MB. The sockets can be filled in any combination with DIMMs of any size, giving a total memory size between 128 MB and 2 GB.

1.9.1 CPU FSB and memory speed

The PCA-6189 can accept DDR SDRAM memory chips without parity. Also note: The PCA-6189 accepts PC2100 (DDR266), PC2700 (DDR 333) and DDR SDRAM, depending on the CPU front side bus frequency (FSB). Please refer to the table below for the relationship between the CPU FSB and memory speed.

Table 1.7: CPU FSB and memory speed

Memory Speed	Processor	FSB frequency	Memory speed Outcome
DDR400	Pentium M or Celeron M	400 MHz	333 MHz
DDR333	Pentium M or Celeron M	400 MHz	333 MHz
DDR266	Pentium M or Celeron M	400 MHz	266 MHz

The PCA-6189 supports ECC (error checking and correction), and memory modules with 9 SDRAM chips/side support ECC.

1.10 Memory Installation Procedures

To install DIMMs, first make sure the two handles of the DIMM socket are in the "open" position. i.e. The handles lean outward. Slowly slide the DIMM module along the plastic guides on both ends of the socket. Then press the DIMM module right down into the socket, until you hear a click. This is when the two handles have automatically locked the memory module into the correct position of the DIMM socket. To remove the memory module, just push both handles outward, and the memory module will be ejected by the mechanism in the socket.

1.11 Processor Installation

The CPU on the board must have a fan or heat sink attached, to prevent overheating.

Warning: *Without a fan or heat sink, the CPU will over-heat and cause damage to both the CPU and the single board computer. To install a CPU, first turn off your system and remove its cover. Locate the processor socket 479.*

1. To open the socket, turn the socket screw clockwise as far as it will go.

2. Place the CPU in the empty socket and then follow the instructions that came with the CPU. If you have no instructions, complete the following procedure:

- Carefully align the CPU on top of the socket, making sure the corner pin patterns of the CPU match the patterns on the socket.

- Gently place the CPU on top of the socket. It should insert easily. If it does not insert easily, check that the socket screw is turned clockwise as far as possible.

3. After the CPU has been inserted, turn the screw counter-clockwise as far as it will go to lock the CPU into position. The top plate of the socket should slide up into the locked position. You will feel some resistance against the screw as the CPU pins tighten in the socket. This is normal and will not damage the CPU. Turn the screw counter-clockwise as far as it will go.

CHAPTER

2

Connecting Peripherals

Chapter 2 Connecting Peripherals

2.1 Introduction

You can access most of the connectors from the top of the board while it is installed in the chassis. If you have a number of cards installed or have a packed chassis, you may need to partially remove the card to make all the connections.

2.2 1st & 2nd (CN1, CN2) IDE Connectors

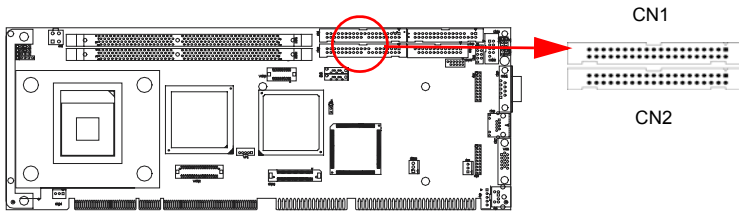

You can attach up to four IDE (Integrated Drive Electronics) drives to the PCA-6189's built-in controller. The primary (CN1) and secondary (CN2) connectors can each accommodate two drives.

Wire number 1 on the cable is red or blue and the other wires are gray. Connect one end to connector CN1 or CN2 on the single board computer. Make sure that the red/blue wire corresponds to pin 1 on the connector (in the upper right hand corner). See Chapter 1 for help finding the connector.

Unlike floppy drives, IDE hard drives can connect in either position on the cable. If you install two drives to a single connector, you will need to set one as the master and the other as the slave. You do this by setting the jumpers on the drives. If you use just one drive per connector, you should set each drive as the master. See the documentation that came with your drive for more information.

Connect the first hard drive to the other end of the cable. Wire 1 on the cable should also connect to pin 1 on the hard drive connector, which is labeled on the drive circuit board. Check the documentation that came with the drive for more information.

Connect the second hard drive to the remaining connector (CN2 or CN1), in the same way as described above.

2.3 Floppy Drive Connector (CN3)

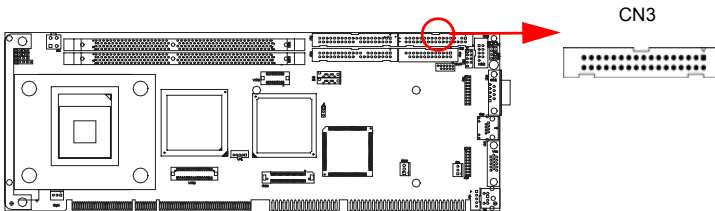

You can attach up to two floppy disk drives to the PCA-6189's on board controller. You can use 3.5" (720 KB, 1.44 MB) drives.

The single board computer comes with a 34-pin daisy-chain drive connector cable. On one end of the cable is a 34-pin flat-cable connector. On the other end are two sets of 34-pin flat-cable connector (usually used for 3.5" drives). The set on the end (after the twist in the cable) connects to the A: floppy drive. The set in the middle connects to the B: floppy drive.

2.4 Parallel Port (CN4)

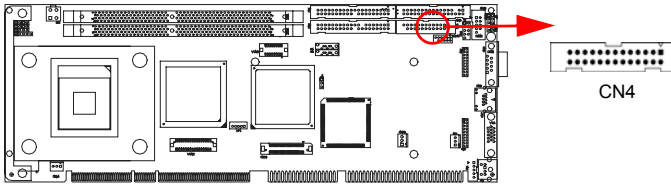

The parallel port is normally used to connect the single board computer to a printer. The PCA-6189 includes an onboard parallel port, accessed through a 26-pin flat-cable connector, CN4. The card comes with an adapter cable which lets you use a traditional DB-25 connector. The cable has a 26-pin connector on one end and a DB-25 connector on the other, mounted on a retaining bracket. The bracket installs at the end of an empty slot in your chassis, giving you access to the connector.

The parallel port is designated as LPT1, and can be disabled or changed to LPT2 or LPT3 in the system BIOS setup.

To install the bracket, find an empty slot in your chassis. Unscrew the plate that covers the end of the slot. Screw in the bracket in place of the plate. Next, attach the flat-cable connector to CN4 on the CPU card. Wire 1 of the cable is red or blue, and the other wires are gray. Make sure that wire 1 corresponds to pin 1 of CN4. Pin 1 is on the upper right side of CN4.

2.5 USB Ports CN6, CN31, and CN32

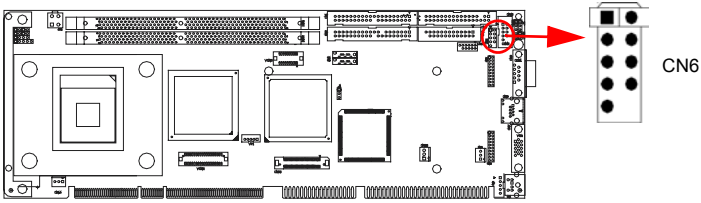

The PCA-6189 provides up to four ports for the USB (Universal Serial Bus) interface, which gives complete Plug & Play and hot swapping for up to 127 external devices. The USB interface complies with USB Specification Rev. 2.0, supports transmission rate up to 480 Mbps and is fuse-protected. The USB interface can be disabled in the system BIOS setup.

Connector CN31 connects to USB ports 0 and 1, while CN6 and CN32 share ports 2 and 3. Users can choose to use either CN6 or CN32 for ports 2 and 3 by setting the hyper-miniature DIP switch. To set the switch, see the note below.

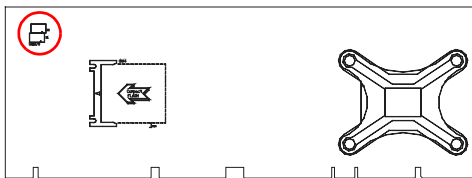

Note: To enable CN6, turn on pins 3 and 4 of S1 and S2, and also turn off pins 1 and 2. To enable CN32 (for USB ports 3 and 4 of the dual layer bracket) turn on pin 1 and 2 of S1 and S2, and also turn off pins 3 and 4. Any other DIP switch setup for the USB function will be unstable.

2.6 VGA Connector CN7

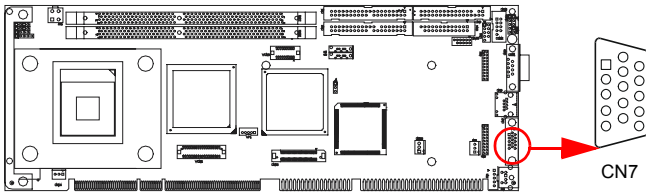

The PCA-6189 includes a VGA interface that can drive conventional CRT displays. CN7 is a standard 15-pin D-SUB connector commonly used for VGA. Pin assignments for CRT connector CN7 are detailed in Appendix B.

2.7 LVDS connector VCN2

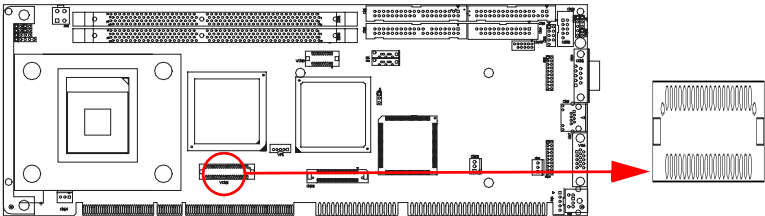

The PCA-6189 provides a LVDS interface that supports 18-bit LCD panels. Pin assignments for the LVDS connector VCN2 are detailed in Appendix B.

2.8 DVI connector VCN3

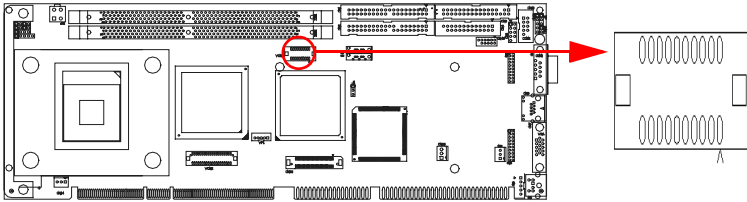

The VCN3 provides a DVI interface that supports DVI display. This connector should be used with a 20-pin DVI cable (p/n: 1700000821) Pin assignments for the VCN3 are detailed in Appendix B.

2.9 Ethernet Connector (CN8 and CN34)

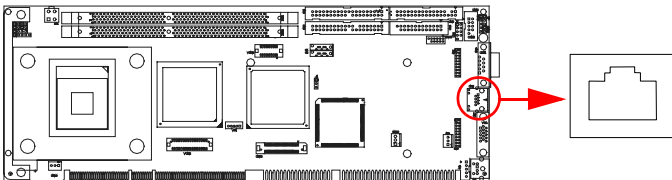

The PCA-6189 is equipped with single/dual high-performance 32-bit PCI-bus Ethernet interface, which is fully compliant with IEEE 802.3/u 10/100Mbps CSMA/CD and IEEE 802.3ab 1000Base-T standards. It is supported by all major network operating systems and is 100% Novell NE-2000 compatible. An onboard RJ-45 jack provides convenient 10/100Base-T or 10/100/1000Base-T RJ-45 operation.

2.10 Serial Ports (COM1 : CN9; COM2 : CN10)

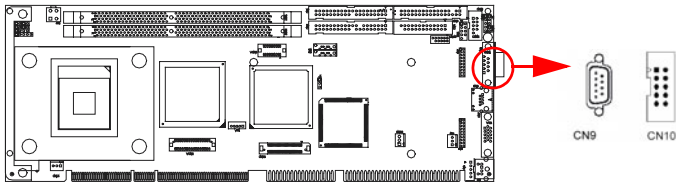

The PCA-6189 offers two serial ports, CN9 as COM1 and CN10 as COM2. These ports can connect to serial devices, such as a mouse or a printer, or to a communications network.

The IRQ and address ranges for both ports are fixed. However, if you want to disable the port or change these parameters later, you can do this in the system BIOS setup.

Different devices implement the RS-232 standard in different ways. If you are having problems with a serial device, be sure to check the pin assignments for the connector.

2.11 PS/2 Keyboard/Mouse Connector (CN11/CN33)

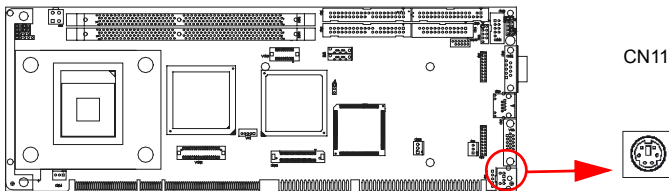

The 6-pin mini-DIN connector (CN11) on the card mounting bracket provides connection to a PS/2 keyboard or a PS/2 mouse. CN11 can also be connected to an adapter cable (P/N: 1700060202, available from Advantech) for connecting to both a PS/2 keyboard and a PS/2 mouse.

2.12 External Keyboard Connector (CN12)

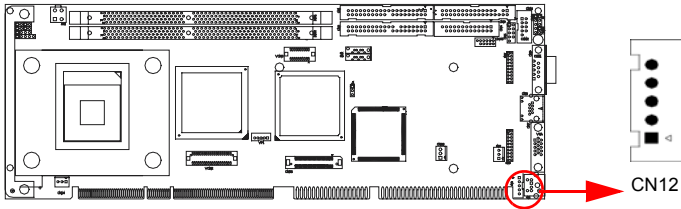

In addition to the PS/2 mouse/keyboard connector on the PCA-6189's rear plate, there is also an extra onboard external keyboard connector. This gives system integrators greater flexibility in designing their systems.

2.13 CPU Fan Connector (CN14)

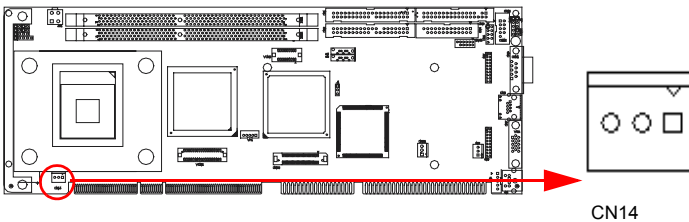

If fan is used, this connector supports cooling fans of 500mA (6W) or less.

2.14 Front Panel Connectors (CN16, 17, 18, 19, 21&29)

There are several external switches to monitor and control the PCA-6189

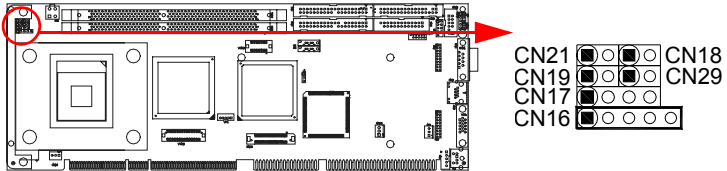

2.14.1 Power LED (CN16)

CN16 is a 5-pin connector for the power on LED. Refer to Appendix B for detailed information on the pin assignments. If a PS/2 or ATX power supply is used, the system's power LED status will be as indicated below:

Table 2.1: PS/2 or ATX power supply LED status

Power mode	LED (PS/2 power)	LED (ATX power)
System On	On	On
System Suspend	Fast flashes	Fast flashes
System Off	Off	Slow flashes

2.14.2 External speaker (CN17)

CN17 is a 4-pin connector for an external speaker. If there is no external speaker, the PCA-6189 provides an onboard buzzer as an alternative. To enable the buzzer, set pins 3-4 as closed

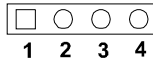

2.14.3 Reset (CN18)

Many computer cases offer the convenience of a reset button. Connect the wire from the reset button.



2.14.4 HDD LED (CN19)

You can connect an LED to connector CN19 to indicate when the HDD is active.



2.14.5 ATX soft power switch (CN21)

If your computer case is equipped with an ATX power supply, you should connect the power on/off button on your computer case to CN21. This connection enables you to turn your computer on and off.

2.14.6 SM Bus Connector (CN29)

This connector is reserved for Advantech's SNMP-1000 HTTP/SNMP Remote System Manager. The SNMP-1000 allows users to monitor the internal voltages, temperature and fans from a remote computer through an Ethernet network.

CN29 can be connected to CN19 of SNMP-1000. Please be careful about the pin assignments, pin 1 must be connected to pin 1 and pin2 to pin 2 on both ends of cable.

2.15 ATX feature connector (CN20)

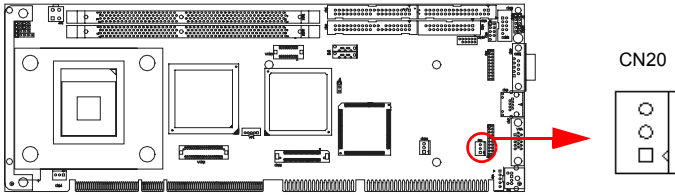

Connect to the CN1 on the Advantech backplane to enable the ATX function, 5V stand-by.

2.16 AC-97 Audio interface (CN43)

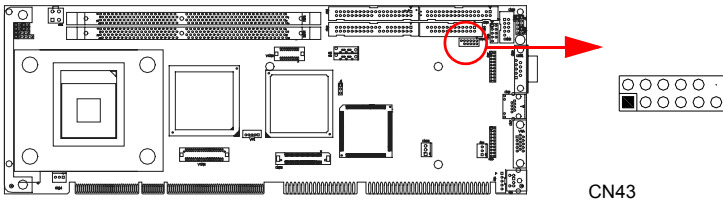

The PCA-6189 provides AC-97 audio through PCA-AUDIO-00A1 module from Advantech.

2.17 Serial ATA interface (SA0 and SA1)

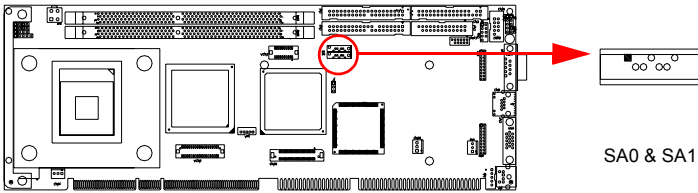

In addition to the two EIDE interfaces (up to four devices), the PCA-6189 features high performance serial ATA interface (up to 150MB/s) which eases cabling to hard drives with thin and long cables.

2.18 Connecting to SNMP-1000 remote manager

Use the 6-pin to 8-pin cable to connect the single board computer to SNMP-1000. This cable comes with the SNMP-1000.



2.19 Auxiliary 4-pin power connector (ATX1)

To ensure the sufficiency of power supply for Pentium M or Celeron M single board computer, one auxiliary 4 pin power connector is available on PCA-6189. This connector must be connected to the power supply, otherwise system might be unstable.

CHAPTER
3

Award BIOS Setup

Chapter 3 Award BIOS Setup

3.1 Introduction

Award's BIOS ROM has a built-in setup program that allows you to modify the basic system configuration. This type of information is stored in battery-backed memory (CMOS RAM) so that it retains the setup information when the power is turned off.

3.1.1 CMOS RAM Auto-backup and Restore

The CMOS RAM is powered by an onboard button cell battery. When you finish BIOS setup, the data in CMOS RAM will be automatically backed up to Flash ROM. If operation in a harsh industrial environment causes a soft error, BIOS will recheck the data in CMOS RAM and automatically restore the original data in Flash ROM to CMOS RAM for booting.

Note: If you intend to change the CMOS setting without restoring the previous backup, you have to click on "DEL" within two seconds of the "CMOS checksum error..." display screen message appearing. Then enter the "Setup" screen to modify the data. If the "CMOS checksum error..." message appears again and again, please check to see if you need to replace the battery in your system.

3.2 Entering Setup

Turn on the computer and press to enter the BIOS setup.

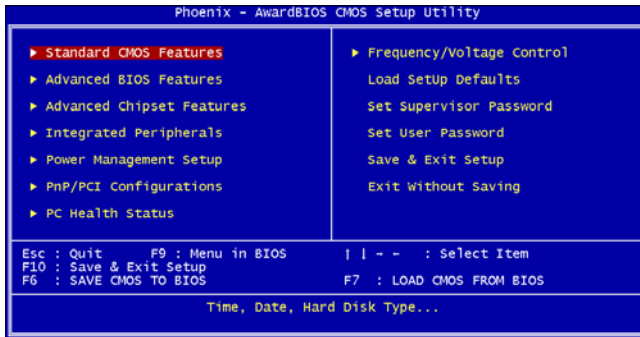

Figure 3.1: Award BIOS Setup initial screen

3.3 Standard CMOS Setup

Choose the *Standard CMOS Features* option from the initial setup screen menu to display the screen below. This menu allows you to configure system components such as date, time, hard disk drive, floppy drive, display, and memory.

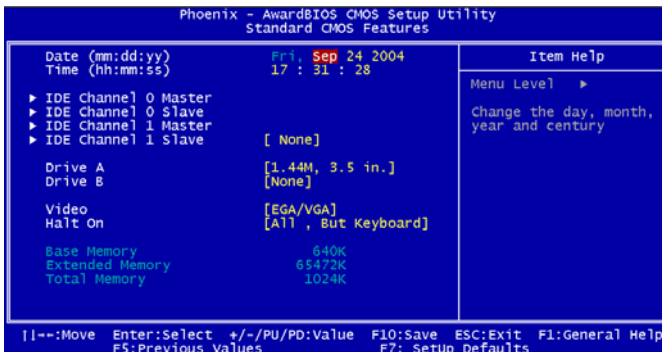

Figure 3.2: Standard CMOS features screen

3.4 Advanced BIOS Features

The *Advanced BIOS Features* screen appears when you choose the *Advanced BIOS Features* item from the initial setup screen menu. Use this screen to configure the PCA-6189 according to your particular requirements. Below are some major items that are provided in the Advanced BIOS Features screen. A quick booting function is provided for your convenience. Simply enable the Quick Booting item to save yourself valuable time.

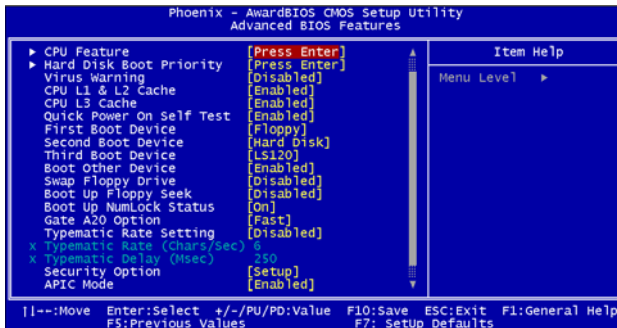

Figure 3.3: Advanced BIOS features screen

3.4.1 CPU Features

The *CPU Features* allows you to adjust the value of Thermal Monitors 1 and 2 with the *BUS ratio* and *BUS VID* settings. Using this setting, you can choose to lower the CPU speed for a fixed length of time when the CPU temperature gets too high. The choices are *4 Min*, *8 Min*, *16 Min*, and *32 Min*.

3.4.2 Hard Disk Boot Priority

Use this setting to select the hard disk boot device priorities.

3.4.3 Virus Warning

Use this setting to enable virus warning. The choices are *Enabled* and *Disabled*.

3.4.4 CPU L1 & L2 Cache, CPU L3 Cache

Enabling this feature speeds up memory access. The choices are *Enabled* or *Disabled*.

3.4.5 Quick Power On Self Test

This setting allows the system to skip certain tests while booting. This will decrease the time needed to boot the system.

3.4.6 First/Second/Third Boot Device

The BIOS will load the OS with the devices in the sequence selected. The sequence includes: *Floppy*, *LS120*, *HDD-0*, *SCSI*, *CDROM*, *HDD-1*, *HDD-2*, *HDD-3*, *ZIP100*, *USB-FDD*, *USB-ZIP*, *USBCDROM*, *USB-HDD*, *LAN*, and *Disabled*.

3.4.7 Boot Other Device

Use this option to choose another device to boot. The choices are *Enabled* or *Disabled*.

3.4.8 Swap Floppy Drive

If the system has two floppy drives, choose *Enabled* to assign physical drive B to logical drive A and vice-versa. The choices are *Enabled* or *Disabled*.

3.4.9 Boot UP Floppy Seek

Select the command *Disabled* to speed the boot up. Select *Enabled* to search disk drives during boot up.

3.4.10 Boot Up NumLock Status

This feature selects the power on state for NumLock. The choices are *Off* and *On*.

3.4.11 Gate A20 Option

Normal: A pin in the keyboard controller controls Gate A20.

Fast (Default): The chipset controls GateA20.

3.4.12 Typematic Rate Setting

The typematic rate is the rate key strokes repeat as determined by the keyboard controller. The commands are *Enabled* and *Disabled*. Enabling allows the typematic rate and delay to be selected.

3.4.13 Typematic Rate (Chars/Sec)

BIOS accepts the following input values (characters/second) for typematic rate: 6, 8, 10, 12, 15, 20, 24, 30.

3.4.14 Typematic Delay (msec)

Typematic delay is the time interval between the appearance of two consecutive characters, when holding down a key. The input values for this category are: 250, 500, 750, 1000 (milliseconds).

3.4.15 Security Option

Choose an option for this setting to have the system prompt for a password every time the system boots or only when you enter setup.

System: The system will not boot and access to setup will be denied if the correct password is not entered at the prompt.

Setup: The system will boot, but access to Setup will be denied if the correct password is not entered at the prompt.

Note: To disable security, select "PASSWORD SETTING" in the main menu. At this point, you will be asked to enter a password. Simply press <Enter> to disable security. When security is disabled, the system will boot, and you can enter Setup freely.

3.4.16 APIC Mode

Use this setting to enable the APIC mode. The choices are *Disabled* or *Enabled*.

3.4.17 MPS Version Control For OS

This function reports if an FDD is available for Windows 95. The selections are 1.1 or 1.4.

3.4.18 OS Select For DRAM > 64MB

Select OS2 only if you are running OS/2 operating system with greater than 64MB of RAM on the system. Commands are *Non-OS2* or *OS2*.

3.4.19 Report No FDD For WIN 95

This setting determines if the BIOS should report the absence of a floppy disk drive to Windows 95. When set to *Yes*, the BIOS will assign IRQ 6 to another device. This allows computers with no floppy disk drives to boot into Windows 95 normally. When set to *No*, Windows 95 will detect the absence of the floppy disk drive and halt the system with an error message. Please note that this BIOS feature has no relevance in other operating systems. Only Windows 95 is affected. It does not matter what you set this BIOS option to if you are using other operating systems.

3.4.20 Small Logo(EPA) Show

This setting controls whether or not the EPA logo is shown. The choices are *Disabled* or *Enabled*.

3.5.4 DRAM RAS# to CAS# Delay

In order to improve performance, certain space in memory is reserved for ISA cards. This memory must be mapped into the memory space below 16 MB. The choices are: 3 and 2.

3.5.5 DRAM RAS# Precharge

This controls the idle clocks after issuing a precharge command to DRAM. You can leave this on the default setting. The choices are: 3 and 2.

3.5.6 DRAM Data Integrity Mode

System can auto-detect the SDRAM module whether the module supports ECC or not. When using the ECC SDRAM module, users can choose ECC or non-ECC according to the manual.

3.5.7 System BIOS Cacheable

Selecting Enabled allows caching of the system BIOS ROM at F0000h-FFFFFh, resulting in better system performance. However, if any program writes to this memory area, a system error may occur. The choices are *Enabled* and *Disabled*.

3.5.8 Video Bios Cacheable

Selecting *Enabled* allows caching of the video BIOS, resulting in better system performance. However, if any program writes to this memory area, a system error may occur. The choices are *Enabled* and *Disabled*.

3.5.9 Memory Hole At 15M-16M

Enabling this feature reserves 15 MB to 16 MB memory address space for ISA expansion cards that specifically require this setting. This makes memory from 15 MB and up unavailable to the system. Expansion cards can only access memory up to 16 MB. The default setting is *Disabled*.

3.5.10 Delayed Transaction

This setting allows the chipset's embedded 32-bit posted write buffer to support delayed transaction cycles. If the setting is "Enabled," all PCI-to-ISA writers are buffered and the PCI bus is released after writing to the buffer. If setting is *Disabled*, the PCI bus will bypass the write buffer and write directly to the ISA bus.

3.5.11 Delay Prior to Thermal

This setting controls the length of time to lower the CPU speed when CPU temperature is too high. The choices are: *4 Min*, *8 Min*, *16 Min*, and *32 Min*.

3.5.12 AGP Aperture Size (MB)

Use this setting to select the size of the Accelerated Graphics Port (AGP) aperture. The aperture is a portion of the PCI memory address range dedicated to graphics memory address space. Host cycles that hit the aperture range are forwarded to the AGP without any translation. The choices are: *64*, *128*, and *256*.

3.5.13 Init Display First

Choose the first display interface to initiate while booting. The choices are *PCI Slot* and *Onboard/AGP*.

3.5.14 On-Chip VGA

The VGA controller is enabled by default. Disable the onboard VGA controller by selecting *Disabled*.

3.5.15 On-Chip Frame Buffer Size

Use this setting to select the frame buffer size. Options include *1*, *4*, *8*, *16*, or *32* MB.

3.5.16 Boot display

You can select the display type for your computer equipment. Choices for this option include: *VBIOS Default*, *CRT*, *LFP*, *CRT + LFP*, *EFP*, and *CRT + EFP*. *EFP* can be used for LCD displays.

3.5.17 Panel Number

This option allows you to set the resolution of your screen. Values include *640x480*, *800x600*, *1024x768*, *1280x1024*, and *1600x1200*.

3.6 Integrated Peripherals

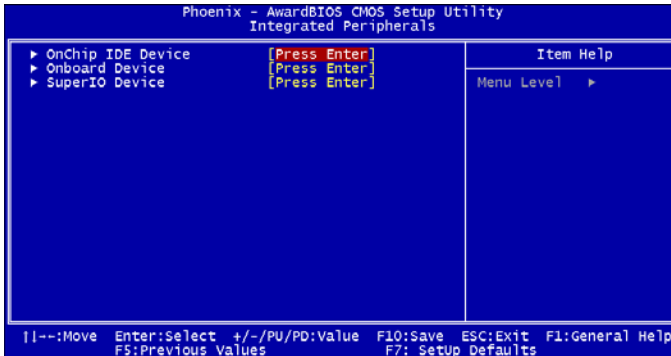

Figure 3.5: Integrated peripherals

3.7 On-chip IDE Device

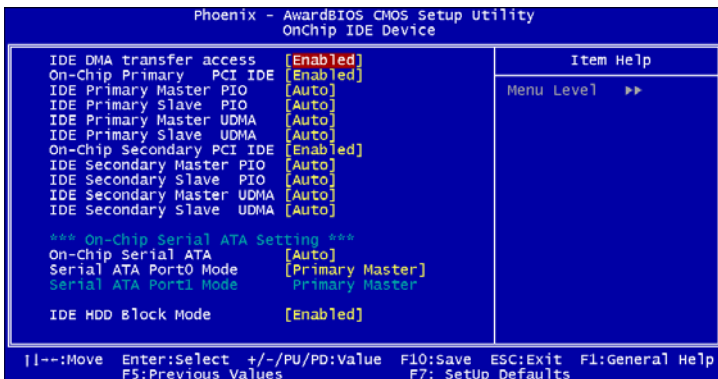

Figure 3.6: On-Chip IDE Device

3.7.1 IDE DMA transfer access

This setting controls the DMA function of hard disk drive. The choices are *Enabled* or *Disabled*. Choose *Enabled* to assign the IDE DMA function.

3.7.2 On-Chip IDE Device

IDE Primary (Secondary) Master/Slave PIO/UDMA Mode (Auto) Each channel (Primary and Secondary) has both a master and a slave, making four IDE devices possible. Because each IDE device may have a different Mode timing (0, 1, 2, 3, 4), it is necessary for these to be independent. The default setting *Auto* will allow auto-detection to ensure optimal performance.

3.7.3 On-Chip Serial ATA

Choose the status of serial ATA. The default setting is *Auto*, which allows the system to arrange all parallel and serial ATA resources automatically. The value *Disabled* will disable the SATA controller. *Combined Mode* will combine PATA and SATA, and max of 2 IDE drives in each channel. *Enhanced Mode* will enable both SATA and PATA, and max of 6 IDE drives are supported. The *SATA Only* means SATA is operating in legacy mode.

3.7.4 Serial ATA Port0/Port1 Mode

Select the mode for SATA port0 and SATA port1. The choices are *Primary Master*, *Primary Slave*, *Secondary Master*, *Secondary Slave*, *SATA0 Master* and *SATA1 Master*.

3.7.5 IDE HDD Block Mode

If your IDE hard drive supports block mode, select *Enabled* for automatic detection of the optimal number of block read/writes per sector for the drive.

3.8 Onboard Device Menu

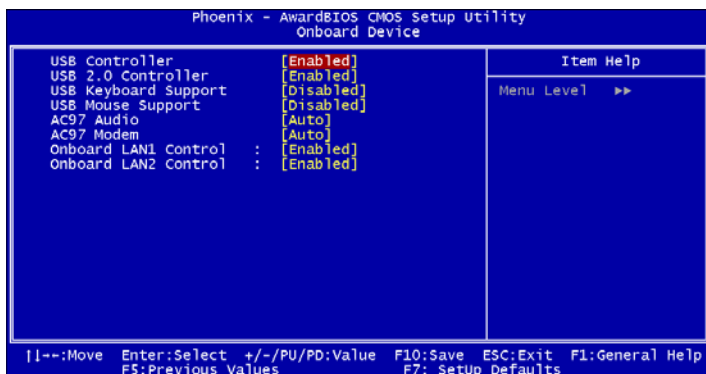

Figure 3.7: Onboard Device

3.8.1 USB Controller

Select *Enabled* if your system contains a Universal Serial Bus (USB) controller and you have USB peripherals. The choices are *Enabled* or *Disabled*.

3.8.2 USB 2.0 Controller

Use this option to disable/enable the USB 2.0 controller only. The BIOS itself may/may not have high speed USB support. If the BIOS has high speed USB support built in, the support will turn on automatically when a high speed device is attached. The choices are *Enabled* or *Disabled*.

3.8.3 USB Keyboard/Mouse Support

Select *Enabled* if you plan to use an USB keyboard. The choices are *Enabled* or *Disabled*.

3.8.4 AC97 Audio

Select *Disable* if you do not want to use AC-97 audio. The options are *Auto* and *Disabled*.

3.8.5 On-board LAN1 Control

The options for this setting are *Enabled* and *Disabled*. Select *Disable* if you don't want to use the onboard LAN controller1.

3.8.6 On-board LAN2 Control

The options for this setting are *Enabled* and *Disabled*. Select *Disable* if you don't want to use the onboard LAN controller2.

3.9 SuperIO Device

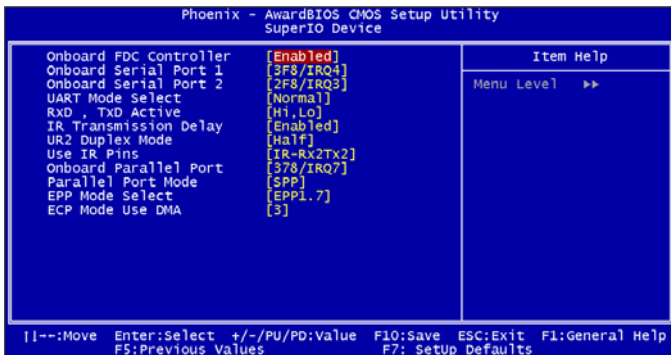

Figure 3.8: SuperIO Device

3.9.1 On-board FDC Controller

When enabled, this field allows you to connect your floppy disk drives to the onboard floppy disk drive connector instead of a separate controller card. If you want to use a different controller card to connect the floppy disk drives, set this field to *Disabled*.

3.9.2 On-board Serial Port 1

The settings are *3F8/IRQ4*, *2F8/IRQ3*, *3E8/IRQ4*, *2E8/IRQ3*, *Auto*, and *Disabled* for the on-board serial connector.

3.9.3 On-board Serial Port 2

The settings are *3F8/IRQ4*, *2F8/IRQ3*, *3E8/IRQ4*, *2E8/IRQ3*, *Auto*, and *Disabled* for the on-board serial connector.

3.9.4 UART Mode Select

This item allows you to select the UART mode. The choices are *IrDA*, *ASKIR*, and *Normal*.

3.9.5 RxD, TxD Active

This item allows you to determine the active mode of RxD/TxD. The choices are: *Hi/Hi*, *Lo/Lo*, *Lo/Hi*, and *Hi/Lo*.

3.9.6 IR Transmission Delay

This item allows you to set the IR transmission delay. The choices are *Enabled* and *Disabled*.

3.9.7 UR2 Duplex Mode

This item allows you to select the IR half/full duplex function. The choices are *Half* and *Full*.

3.9.8 Use IR Pins

The choices are: *RxD2*, *TxD2*; *IR-Rx2Tx2*.

3.9.9 On-board Parallel Port

This field sets the address of the on-board parallel port connector. You can select either *378/IRQ7*, *278/IRQ5*, *3BC/IRQ7*, or *Disabled*. If you install an I/O card with a parallel port, make sure there is no conflict in the address assignments. The single board computer can support up to three parallel ports, as long as there are no conflicts for each port.

3.9.10 Parallel Port Mode

This field allows you to set the operation mode of the parallel port. The setting *Normal* allows normal speed operation, but in one direction only. *EPP* allows bidirectional parallel port operation at maximum speed. *ECP* allows the parallel port to operate in bi-directional mode and at a speed

faster than the maximum data transfer rate. *ECP+EPP* allows normal speed operation in a two-way mode.

3.9.11 EPP Mode Select

This field allows you to select EPP port type 1.7 or 1.9. The choices are: *EPPI.9* or *EPPI.7*.

3.9.12 ECP Mode Use DMA

This selection is available only if you select “ECP” or “ECP + EPP” in the Parallel Port Mode field. In ECP Mode Use DMA, you can select DMA channel 1, or DMA channel 3. Leave this field on the default setting.

3.9.13 PWRON After PWR-FAIL

This option allows you to set the system so that it reboots after a power failure. Select *Former-Sts* to reboot the system with its former settings.

3.10 Power Management Setup

The power management setup controls the single board computer's “green” features to save power. The following screen shows the manufacturer’s defaults.

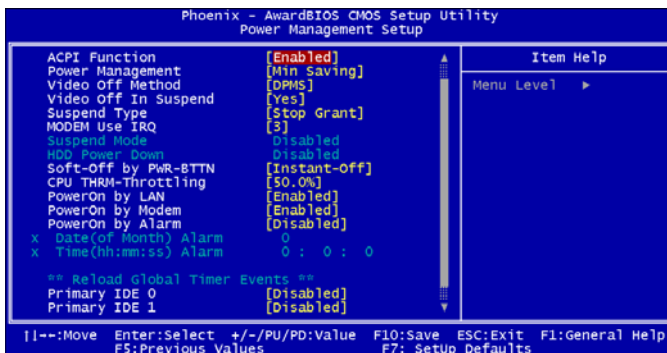

Figure 3.9: Power management setup screen (1)

3.10.1 ACPI function

The choices are *Enabled* and *Disabled*.

3.10.2 Power Management

This option allows you to select from *Min Saving*, *Max Saving*, or *User Defined* to set the degree of power saving. If you select *Min Saving* or

Max Saving, the values for *HDD Power Down* and *Suspend Mode* (the following settings) are filled in automatically. If you select *User Defined*, you must also enter values for *HDD Power Down* and *Suspend Mode*.

Table 3.1: Power Management settings	
Min Saving	For minimum power usage, sets <i>Suspend Mode</i> to 1 hour and set <i>HDD Power Down</i> to 15 minutes.
Max Saving	For maximum power usage, sets <i>Suspend Mode</i> to 1 minute, and set <i>HDD Power Down</i> to 1 minute
User Defined (Default)	Allows you to set each mode individually. When not disabled, each of the ranges are from 1 minute to 1 hour except for <i>HDD Power Down</i> , which ranges from 1 minute to 15 minutes, and <i>Disabled</i> .

3.10.3 Video Off Method

Use this setting to select a method to turn off the video. The choices are: *Blank Screen*, *V/H SYNC+ Blank*, and *DPMS*.

3.10.4 Video Off In Suspend

If value of this setting is *Yes*, the video will turn off when the system is suspended. The choices are *No* and *Yes*.

3.10.5 Suspend Type

Use this option to set the suspension type: *Stop Grant* or *PwrOn Suspend*.

3.10.6 Modem Use IRQ

This determines the IRQ to be used by the MODEM. The choices are: *3*, *4*, *5*, *7*, *9*, *10*, *11*, and *NA*.

3.10.7 Soft-Off by PWR-BTTN

If you select *I* then pushing the ATX soft power switch button once will switch the system to *System off* power mode. Otherwise, you can choose *Delay 4 sec*. If you do, then pushing the button for more than 4 seconds will turn off the system, whereas pushing the button momentarily (for less than 4 seconds) will switch the system to *Suspend mode*.

3.10.8 CPU THRM-Throttling

This field allows you to select the CPU THRM-Throttling rate. The choices: *75.0%*, *50.0%*, and *25.0%*.

3.10.9 Power On by LAN

Choose *Enabled* to resume system function by LAN, or choose *Disabled* to resume system function by PCI card.

3.10.10 Power On by Modem

This item allows you to wake up the system via a COM port from the remote host. The choices are *Enabled* and *Disabled*.

3.10.11 Power On by Alarm

The choices are *Enabled* and *Disabled*.

3.10.12 Primary IDE (0,1) and Secondary IDE (0,1)

Choose *Enabled* to set the system to resume from suspend mode when Primary IDE (0,1) or Secondary IDE (0,1) is active. The choices are *Enabled* and *Disabled*.

3.10.13 FDD, COM, LPT PORT

Choose *Enabled* to set the system to resume from suspend mode if FDD, COM port, or LPT port is active. The choices are *Enabled*, and *Disabled*.

3.10.14 PCI PIRQ [A-D]#

When this value is set to *Enabled*, the system will resume from suspend mode if an interruption occurs. The choices are *Enabled* and *Disabled*.

3.11 PnP/PCI Configurations

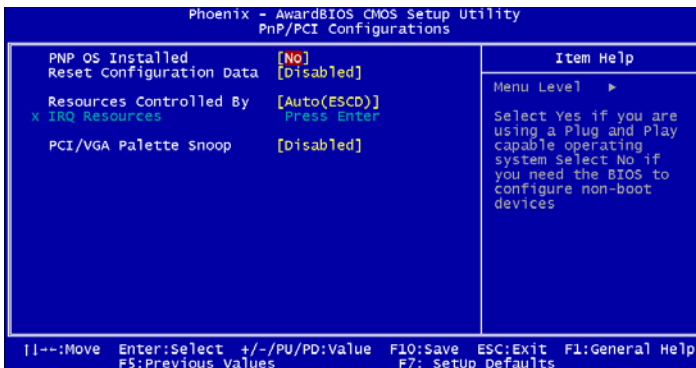

Figure 3.10: PnP/PCI configurations screen

3.11.1 PNP OS Installed

Set this option to *Yes* if PNP OS is installed on your system. The default value for this setting is *No*.

3.11.2 Reset Configuration Data

Default is *Disabled*. Select *Enable* to reset Extended System Configuration Data (ESCD) if you have installed a new add-on and system configuration has caused such a conflict that the OS cannot boot.

3.11.3 Resources Controlled By

The values for this option are *Auto (ESCD)* and *Manual*. If you choose *Manual*, you will need to choose resources from the IRQ Resources submenu. The *Auto (ESCD)* choice automatically configures all of the boot and Plug and Play devices, but you must be using Windows 95 or above.

3.11.4 PCI/VGA Palette Snoop

The default value for this setting is *Disabled*.

3.12 PC Health Status

3.12.1 CPU Warning Temperature

This item will prevent the CPU from overheating. The choices are *Disabled*, *50°C/122°F*, *53°C/127°F*, *56°C/133°F*, *60°C/140°F*, *63°C/145°F*, *66°C/151°F*, and *70°C/158°F*.

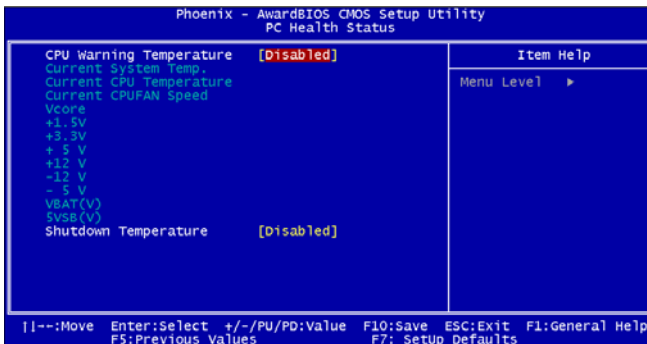

Figure 3.11: PC health status screen

3.12.2 Current System Temp

This shows you the current temperature of system.

3.12.3 Current CPU Temperature

This shows you the current CPU temperature.

3.12.4 Current CPUFAN Speed

This shows you the current CPU fan operating speed.

3.12.5 VCORE, VBAT(V), 5VSB(V)

This shows you the voltage of VCORE, +1.5 V, 3.3 V, +5 V, +12 V, -12 V, -5 V, VBAT(V), and 5VSB(V).

3.12.6 Shutdown Temperature

This option sets the temperature at which the system will shut down if the CPU overheats. You can choose a value from 60°C/140°F, 65°C/149°F, 70°C/158°F, 75°C/167°F, and Disabled.

3.13 Frequency/Voltage Control

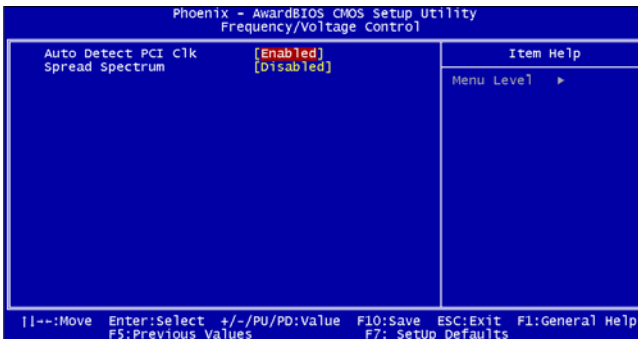

Figure 3.12: Spread Spectrum Control screen

3.13.1 Auto-detect PCI CLK

Use this function to reduce the occurrence of electromagnetic interference (EMI). If this option is set to *Enabled*, BIOS will check for components in PCI and DIMM slots, and then turn off clock pulses to empty slots.

3.13.2 Spread Spectrum

Use this function to tune the PCI clock frequency. Setting this option to *Disabled* will limit the clock signal spread, increase the consistency of the frequency, but increase the EMI. Setting this option to *Enabled* will decrease the EMI.

3.14 Passwords and Settings

3.14.1 Load Setup Defaults

Choose the *Load Setup Defaults* selection from the initial setup screen. At the prompt, enter *Y* to return system setup options to default values.

3.14.2 Set Supervisor Password

Choose the *Set Supervisor Password* selection from the initial setup screen. At the **ENTER PASSWORD:** prompt, enter a password with up to eight characters. Typing a password clears any previously entered password from CMOS memory. Pressing the Enter key at this prompt without supplying a password will disable the password function. At the **CONFIRM PASSWORD:** prompt, enter the password again. Press Esc at any time to abort the process. The system will prompt for a password according to the Security Option value on the Advanced BIOS features menu.

3.14.3 Set User Password

Choose the *Set User Password* selection from the initial setup screen. At the **ENTER PASSWORD:** prompt, enter a password with up to eight characters. Typing a password clears any previously entered password from CMOS memory. Pressing the Enter key at this prompt without supplying a password will disable the password function. At the **CONFIRM PASSWORD:** prompt, enter the password again. Press <Esc> at any time to abort the process. The system will prompt for a password according to the Security Option value on the Advanced BIOS features menu.

3.14.4 Save & Exit Setup

Choose the *Save & Exit Setup* selection from the initial setup screen. At the prompt, enter *Y* to save the setup values to the CMOS memory of the chipset, or enter *N* to abort the exit. The microprocessor will retrieve these values every time you turn your system on and compare this to what it finds as it checks the system. This record is required for the system to operate.

3.14.5 Exit Without Saving

Choose the *Exit Without Saving* selection from the initial setup screen. At the prompt, enter *Y* to exit without saving new setup values to CMOS memory, or enter *N* to abort the exit.

CHAPTER
4

**Chipset Software
Installation Utility**

Chapter 4 Chipset Software Install Utility

4.1 Before you begin

To facilitate the installation of the enhanced display device drivers and utility software, you should read the instructions in this chapter carefully before you attempt installation. The device drivers for the PCA-6189 board are located on the software installation CD. The auto-run function of the driver CD will guide and link you to the utilities and device drivers under a Windows system. The Intel Chipset Software Installation Utility is not required on any systems running Windows NT 4.0. Updates are provided via Service Packs from Microsoft.

Note: The files on the software installation CD are compressed. Do not attempt to install the drivers by copying the files manually. You must use the supplied SETUP program to install the drivers.

Before you begin, it is important to note that most display drivers need to have the relevant software application already installed in the system prior to installing the enhanced display drivers. In addition, many of the installation procedures assume that you are familiar with both the relevant software applications and operating system commands. Review the relevant operating system commands and the pertinent sections of your application software's user's manual before performing the installation.

4.2 Introduction

The Intel Chipset Software Installation (CSI) utility installs to the target system the Windows INF files that outline to the operating system how the chipset components will be configured. This is needed for the proper functioning of the following features:

- Core PCI and ISA PnP services.
- AGP support.
- IDE Ultra ATA 100/66/33 and Serial ATA interface support.
- USB 1.1/2.0 support (USB 2.0 driver needs to be installed separately for Win98)

- Identification of Intel chipset components in the Device Manager.
- Integrates superior video features. These include filtered sealing of 720 pixel DVD content, and MPEG-2 motion compensation for software DVD

Note: This utility is used for the following versions of Windows system, and it has to be installed before installing all the other drivers: Windows 98SE Windows 2000, Windows ME, Windows XP

4.3 Windows XP Driver Setup

1. Insert the driver CD into your system's CD-ROM drive. In a few seconds, the software installation main menu appears. Move the mouse cursor over the "Auto" button under the "CSI UTILITY" heading, a message pops up telling you to install the CSI utility before other device drivers, as shown in the following figure. Click on this button. Taking Windows XP as example.



2. Click "Next" when you see the following message.

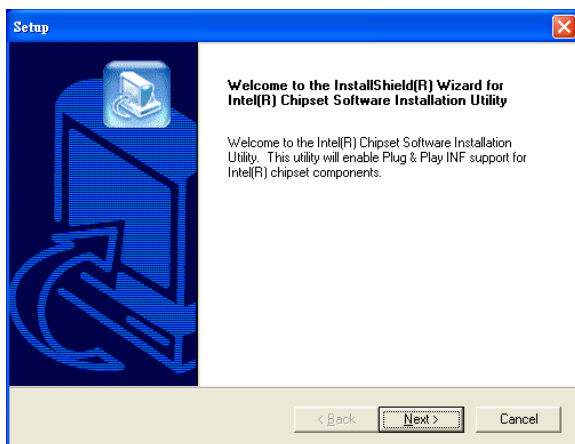

3. Click "Yes" when you see the following message.

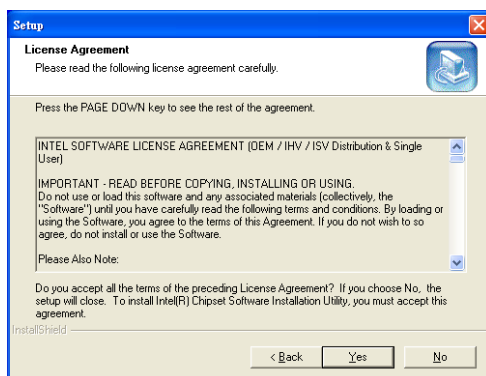

4. Click "Next" when you see the following message.

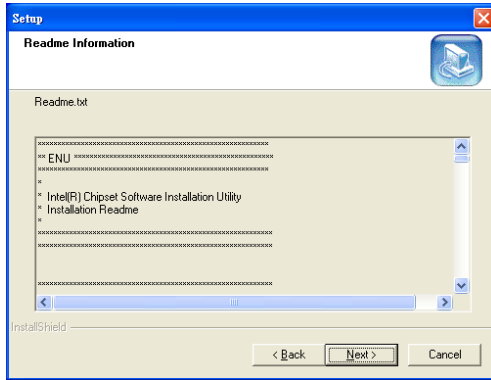

5. When the following message appears, click "Finish" to complete the installation and restart Windows.

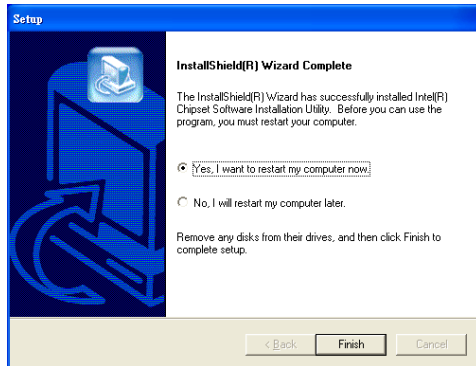

CHAPTER
5

VGA Setup

Chapter 5 VGA Setup

5.1 Introduction

The PCA-6189 has VGA onboard, you need to install the VGA driver to enable the function.

The Intel 855GME Chipset provides a highly integrated graphics accelerator delivering high performance 2D, 3D, and video capabilities. With its interfaces to UMA using a DVMT configuration, an analog display, a LVDS port, and two digital display ports (e.g. flat panel), the GMCH can provide a complete graphics solution.

The Intel 855GME also provides 2D hardware acceleration for block transfers of data (BLTs). The BLT engine provides the ability to copy a source block of data to a destination and perform raster operations (e.g.,ROP1, ROP2, and ROP3) on the data using a pattern, and/or another destination. Performing these

common tasks in hardware reduces CPU load, and thus improves performance.

High bandwidth access to data is provided through the system memory interface. The GMCH uses

Tiling architecture to increase system memory efficiency and thus maximize effective rendering bandwidth. The Intel 855GME Chipset improves 3D performance and quality with 3D Zone rendering technology. The Intel 855GME GMCH also supports Video Mixer rendering, and Bi-Cubic filtering.

5.2 Dynamic Video Memory Technology (DVMT)

The Intel 855GME supports DVMT in a non-graphics system memory configuration. DVMT is a mechanism that manages system memory and the internal graphics device for optimal graphics performance. DVMT enabled software drivers, working with the memory arbiter and the operating system, utilize the system memory to support 2D graphics and 3D applications. DVMT dynamically responds to application requirements by allocating the proper amount of display and texturing memory.

5.3 Windows XP Driver Setup

Note: Before installing this driver, make sure the CSI utility has been installed in your system. See Chapter 4 for information on installing the CSI utility

1. Insert the driver CD into your system's CD-ROM drive. In a few seconds, the software installation main menu appears, as shown in the following figure. Under the "VGA DRIVERS" heading, click on one of the buttons (labeled "W2K XP" and "WIN NT" respectively) according to the operating system you are using. The following installation procedure is for Windows XP. For other operating systems, please follow the on-screen installation guide.



1. Please click on "Next" to continue the installation

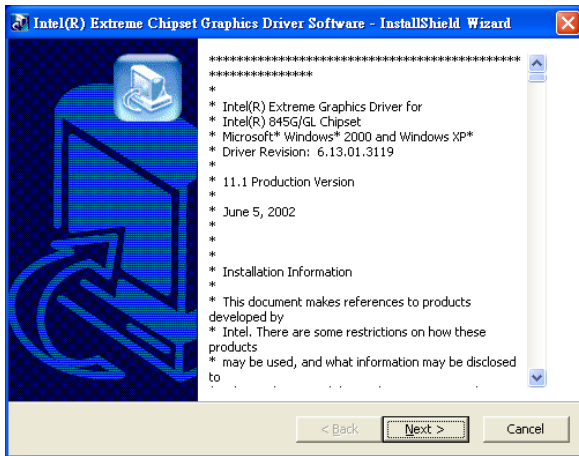

2. You will see a welcome window. Please click on "Next" to continue the installation.

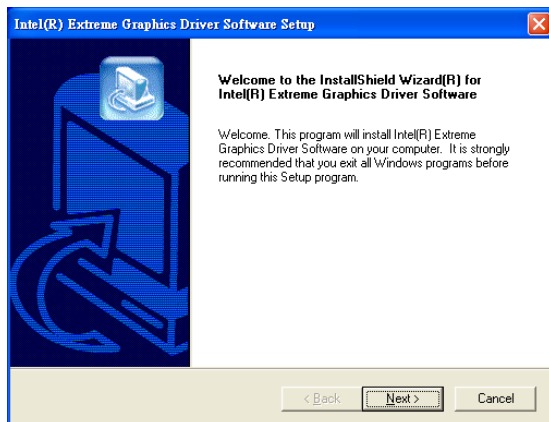

3. Click "Yes" when you see the following message.

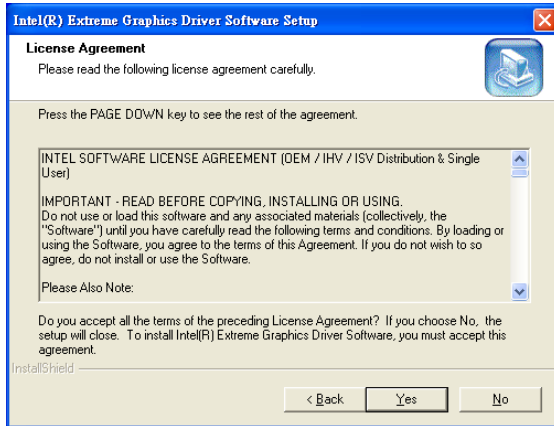

4. Click on "Yes" to continue the installation

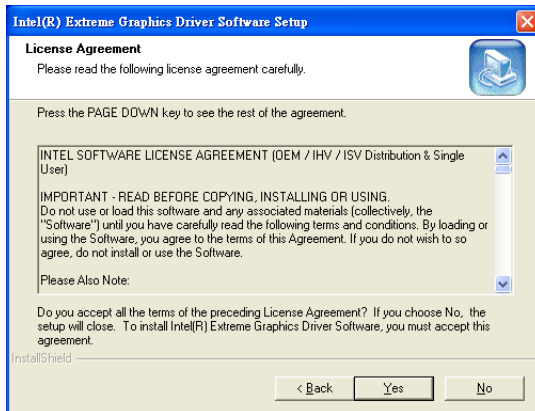

5. Click "Finish" to complete the installation and restart the computer now or later.

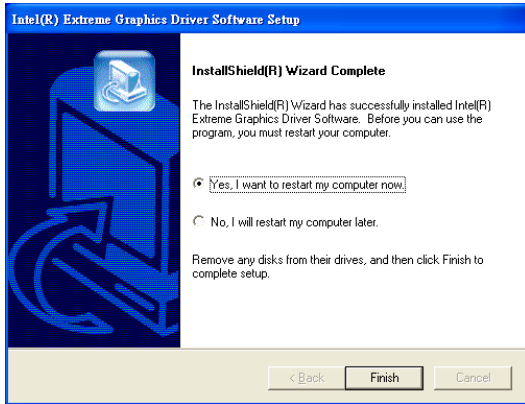

CHAPTER
6

LAN Configuration

Chapter 6 LAN Configuration

6.1 Introduction

The PCA-6189 features the 32-bit 10/100/1000 Mbps Ethernet network interface. This interface supports bus mastering architecture and auto-negotiation features. Therefore standard twisted-pair cabling with RJ-45 connectors for 10 Mbps, 100 Mbps and 1000 Mbps connections can be used. Extensive driver support for commonly-used network systems is also provided.

6.2 Features

- Intel 82551 10/100Base-T Ethernet LAN controller
- Optional single/dual Intel 82541 10/100/1000 Base-T Ethernet LAN controller
- Supports Wake-on-LAN remote control function.
- PCI Bus Master complies with PCI Rev. 2.2
- MAC & PHY (10/100/1000 Mbps) interfaces.
- Complies with 1000Base-T, 100Base-TX, and 10Base-T applications.
- Fully supports 1000Base-T, 100Base-TX, and 10Base-T operation.
- Single RJ-45 connector gives auto-detection of 10 Mbps, 100 Mbps, or 1000 Mbps network data transfer rates and connected cable types.
- Plug and Play.
- Enhancements on ACPI & APM.
- Complies with PCI Bus Power Management Interface Rev. 1.1,
- ACPI Rev. 2.0, and Device Class Power Management Rev. 1.0.

6.3 Installation

Note: Before installing the LAN drivers, make sure the CSI utility has been installed in your system. See Chapter 4 for information on installing the CSI utility.

The PCA-6189's onboard Ethernet interface supports all major network operating systems. However, the installation procedure varies with different operating systems. In the following sections, refer to the one that provides driver setup procedure for the operating system you are using.

6.4 Win XP Driver Setup (Intel 82541/82551)

1. Insert the driver CD into your system's CD-ROM drive. In a few seconds, the software installation main menu appears, as shown in the following figure. Under the "LAN Drivers" heading, click on the "Manual" to open file manager, then click "SETUP.EXE" to run the installation procedure



2. Select "I accept the terms in the license agreement" and click "Next" to continue.

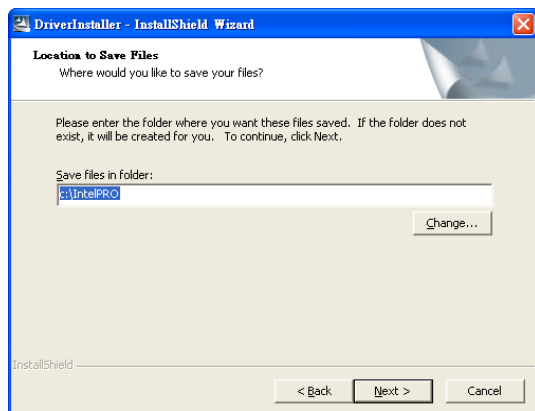

3. Click "Next" to continue.

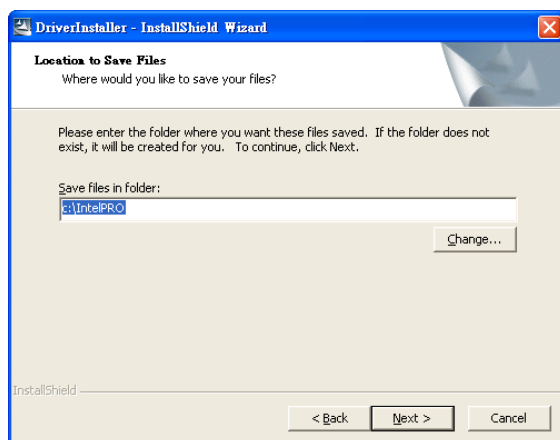

4. Click "Install Software" to start the installation procedure.



5. The driver will be installed automatically and the LAN function will be enabled after the installation

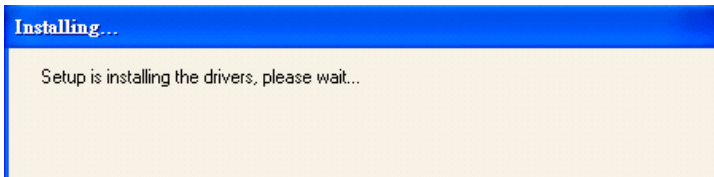

CHAPTER

7

SCSI Setup & Configuration

Chapter 7 SCSI Setup & Configuration

7.1 Introduction

The PCA-6189 is equipped with an Adaptec AIC-7899 single-chip PCI-to-SCSI host adapter which provides a dual channel Ultra 160 multi-tasking interface between your computer's PCI bus and SCSI devices (disk drives, CD-ROM drives, scanners, tape backups, removable media drives, etc.). Ultra 160 is a new generation of SCSI technology that expands SCSI performance from 80 MBytes/sec to 160 MBytes/sec. Up to a total of 15 SCSI devices can be connected to each of the SCSI connectors.

The AIC-7899 combines this Ultra 160 SCSI technology with Adaptec's SpeedFlex technology. SpeedFlex allows the Adaptec SCSI card to be backwards compatible with previous generations of SCSI products, while allowing newer Ultra 160 SCSI devices to operate at the higher 160 MBytes/sec rate.

There are 3 SCSI connectors on the CPU card: CN50 and CN51 for Ultra 160 devices, and CN52 for 50-pin SCSI devices. You can use Ultra 160 and Ultra wide devices simultaneously without compromising the performance.

If you need to configure the SCSI, the onboard SCSI Select configuration utility allows you to change host adapter settings without opening the computer or handling the board. The SCSI Select utility also contains a utility to low-level format and verifies the disk media on your hard disk drives.

Note: If any peripheral is running at SE mode, the Ultra 160 SCSI segment will run at speeds up to 40 MBytes/sec only instead of 160 MBytes/sec.

7.2 Understanding SCSI

SCSI (pronounced .scuzzy.) stands for Small Computer Systems Interface. SCSI is an industry standard computer interface for connecting SCSI devices to a common SCSI bus.

A SCSI bus is an electrical pathway that consists of a SCSI interface installed in a computer and one or more SCSI devices. SCSI cables are used to connect the devices to the SCSI interface. For the SCSI bus to function properly, a unique SCSI ID must be assigned to the SCSI interface and each SCSI device connected to it, and the SCSI bus must be properly terminated.

7.3 SCSI IDs

Each device attached to the SCSI bus, as well as the SCSI controller itself, must be assigned a unique SCSI ID number from 0 to 15. A SCSI ID uniquely identifies each SCSI device on the SCSI bus and determines priority when two or more devices are trying to use the SCSI bus at the same time.

Refer to the device's documentation to set the SCSI ID. Here are some general guidelines for SCSI IDs:

- For internal SCSI devices, the SCSI ID usually is set by configuring a jumper on the device.
- For external SCSI devices, the SCSI ID usually is set with a switch on the back of the device.
- SCSI ID numbers don't have to be sequential, as long as the SCSI controller and each device has a different number.
- For example, you can have an internal SCSI device with ID 0, and an external SCSI device with ID 6.
- SCSI ID 7 has the highest priority on the SCSI bus. The priority of the remaining IDs, in descending order, is 6 to 0, then 15 to 8.
- The on-board SCSI interface is preset to SCSI ID 7 and should not be changed. This gives it the highest priority on the SCSI bus.
- Most internal SCSI hard disk drives come from the factory pre-set to SCSI ID 0.
- If you have 8-bit (or Narrow) SCSI devices, they must use SCSI IDs 0, 1, 2, 3, 4, 5, or 6. SCSI ID 0 is recommended for the first SCSI hard disk drive.

- If you are booting your computer from a SCSI hard disk drive connected to the SCSI bus, the Boot SCSI ID setting in the SCSISelect utility must correspond to the SCSI ID of the device from which you are booting. By default, the Boot SCSI ID is set to 0. We recommend that you do not change this setting.
- In Windows 95/98, you can use the Device Manager to determine which SCSI ID is assigned to each installed SCSI device.

7.4 Terminating the SCSI Bus

To ensure reliable communication on the SCSI bus, the ends of the SCSI bus must be properly terminated. This is accomplished when the device at the end of the each cable, or the end of the cable itself, has a terminator installed (or enabled). Terminators must be removed, or termination must be disabled, on devices between the ends of each cable.

Since the method for terminating a SCSI device can vary widely, refer to the device's documentation for instructions on how to enable or disable termination. Here are some general guidelines for termination:

- Internal Ultra 160 and Ultra 2 SCSI devices come from the factory with termination disabled and cannot be changed. Proper termination for internal Ultra 160 and Ultra2 SCSI devices is provided by a 68-pin Internal LVD (low voltage differential) SCSI cable, which has a built-in terminator at its end.
- Termination on non-Ultra 160 and Ultra2 internal SCSI devices usually is controlled by manually setting a jumper or a switch on the device, or by physically removing or installing one or more resistor modules on the device.
- Termination on most external SCSI devices is controlled by installing or removing a SCSI terminator. However, termination on some external SCSI devices is enable or disabled by setting a switched on the back of the SCSI device.

The last external Ultra160 or Ultra2 SCSI device must be terminated with an LVD/SE (low voltage differential/single ended) terminator plug to ensure that the device will operate at its maximum speed. If you use a different kind of terminator plug, the data I/O rate will decrease.

By default, termination on the SCSI controller itself is set to Automatic (the preferred method). We recommend that you do not change this default setting.

7.5 Configuring the SCSI interface with SCSISelect

SCSISelect, included with the CPU card, enables you to change SCSI settings without opening the computer. SCSISelect also enables you to low-level format or verify the disk media of your SCSI hard disk drives. The following table lists the available and default settings for each SCSISelect option.

Note: The default settings are appropriate for most systems. Run SCSISelect if you need to change or view current settings, or if you would like to run the SCSI disk utilities.

SCSISelect Options	Available Settings	Default Setting
SCSI Bus Interface		
Definitions:		
Host Adapter SCSI ID	0-15	7
SCSI Parity Checking	Enable, Disabled	Enabled
Host Adapter SCSI Termination		
LVD/SE Connectors		
SE Connectors	Automatic	Automatic
	Enabled	
	Disabled	
	Automatic	
SE Connectors	Low On/High On	Automatic
	Low Off/High Off	
	Low Off/High On	
	Low Off/High On	
Boot Device Options:		
Boot SCSI ID	0-15	0
BootLUNNumber1	0-7	0

SCSI Device Configuration:		
Sync Transfer Rate (MBytes/sec)		
	160, 80.0, 53.4, 40.0,	160
	32.0, 26.8, 20.0,	
	16.0, 13.4, 10.0	
	ASYN	
Initiate Wide Negotiation	Yes, No	Yes (enabled)
Enable Disconnection	Yes, No	Yes (enabled)
Send Start Unit Command	Yes, No	Yes (enabled)
Enable Write Back Cache2	N/C (No Change)	N/C (No Change)
	Yes, No	
BIOS Multiple LUN Support2	Yes, No	No (disabled)
Include in BIOS Scan2	Yes, No	Yes (enabled)
Advanced Configuration Options:		
Reset SCSI Bus at IC Initialization	Enabled, Disabled	Enabled
Display <Ctrl><A> Messages during BIOS Initialization	Enabled, Disabled	Enabled
Extended BIOS Translation for DOS Drives > 1 GByte	Enabled, Disabled	Enabled
Verbose/Silent Mode	Verbose, Silent	Verbose
HostAdapterBIOS	Enabled	Enabled
	Disabled : Not Scan	
	Disabled: Scan Bus	
Domain Validation2	Enabled, Disabled	Enabled
Support Removable Disks Under BIOS as Fixed Disks2	Disabled	Disabled
	Boot Only,	
	All Disks	

BIOS Support for BootableCD_ROM2	Enabled, Disabled	Enabled
BIOS Support for Int 13	Enabled, Disabled	Enabled
Extensions2		
1 Setting is valid only if Multiple LUN Support is enabled.		
2 Settings are valid only if host adapter BIOS is enabled.		

7.6 Starting SCSISelect

Follow these steps to start SCSISelect:

1. Turn on or restart your system. During the startup process, pay careful attention to the messages that appear on your screen.
2. When the following message appears on your screen, press the Ctrl-A keys simultaneously (this message appears for only a few seconds): Press <Ctrl><A> for SCSISelect (TM) Utility!
3. From the menu that appears, use the arrow keys to move the cursor to the option you want to select, then press ENTER.

Note: If you have difficulty viewing the display, press F5 to toggle between color and monochrome modes. (This feature may not work on some monitors.)

Exiting SCSISelect

Follow these steps to exit SCSISelect:

1. Press ESC until a message prompts you to exit (if you changed any settings, you are prompted to save the changes before you exit.)
2. At the prompt, select YES to exit, then press any key to reboot the computer. Any changes you made in SCSISelect take effect after the computer boots.

Using SCSISelect Settings

To select an option, use the arrow keys to move the cursor to the option, then press ENTER. In some cases, selecting an option displays another menu. You can return to the previous menu at any time by pressing ESC. To restore the original SCSISelect default values, press F6 from the main SCSISelect screen.

SCSI Bus Interface Definitions

- **Host Adapter SCSI ID**-(Default: 7) Sets the SCSI ID for the SCSI controller. The Adaptec SCSI controller AIC-7899 is set at 7, which gives the highest priority on the SCSI bus. We recommend that you do not change this setting.
- **SCSI Parity Checking**-(Default: Enabled) When set to Enabled, verifies the accuracy of data transfer on the SCSI bus. Leave this setting enabled unless any SCSI device does not support SCSI parity.
- **Host Adapter SCSI Termination**-(Default: Automatic) Determines the termination setting for the SCSI card. The default setting for both the LVD/SE (low voltage differential/single ended) connectors and SE connectors is Automatic, which allows the SCSI card to adjust the termination as needed depending on the configuration of the connected SCSI devices. We recommend that you do not change these settings.

Boot Device Options

- **Boot SCSI ID**-(Default: 0) Specifies the SCSI ID of your boot device. We recommend that you don't change the default setting.
- **Boot LUN Number**-(Default: 0) Specifies which LUN (Logical Unit Number) to boot from on your boot device. This setting is not valid unless Multiple LUN Support is **Enabled**

SCSI Device Configuration

SCSI Device Configuration options can be set individually for each connected SCSI device.

Note: *To configure settings for a SCSI device, you must know it.s SCSI ID*

- **Sync Transfer Rate**-(Default: 160) Determines the maximum synchronous data transfer rate that the SCSI card supports. Use the maximum value of 160 MBytes/sec.

- **Initiate Wide Negotiation**-(Default: Yes) When set to Yes, the SCSI card attempts 16-bit data transfer (wide negotiation.) When set to No, the SCSI card uses 8-bit data transfer unless the SCSI device requests wide negotiation.

Note: Set Initiate Wide Negotiation to NO if you are using an 8-bit SCSI device that hangs or exhibits other performance problems with 16-bit data transfer rate enabled.

- **Enable Disconnection**-(Default: Yes) When set to Yes, allows the SCSI device to disconnect from the SCSI bus. Leave the setting at Yes if two or more SCSI device is connected, changing the setting to No results in slightly better performance.
- **Send Start Unit Command**-(Default: Yes) When set to Yes, the Start Unit Command is sent to the SCSI device at bootup.

The following three options have no effect if the SCSI Card BIOS is disabled. (The SCSI Cards BIOS is normally enabled by default.)

- **Enable Write Back Cache**-(Default: N/C) Can be used to enable or disable the write-back cache on SCSI disk drives connected to the host adapter. Leave this option at its default setting of N/C (no change), which usually allow for optimum drive performance.
- **BIOS Multiple LUN Support**-(Default: No) Leave this setting at No if the device does not have multiple Logical Unit Numbers (LUNs.) When set to Yes, the SCSI card BIOS provides boot support for a SCSI device with multiple LUNs (for example, a CD jukebox. device in which multiple CDs can be accessed simultaneously.)
- **Include in BIOS Scan**-(Default: Yes) When set to Yes, the SCSI card BIOS includes the device as part of its BIOS scan at bootup.

Advanced Configuration Options

Note: Do not change the Advanced Configuration Options unless absolutely necessary.

- **Reset SCSI Bus at IC Initialization**-(Default: Enabled) When set to Enabled, the SCSI card generates a SCSI bus reset during its power-on initialization and after a hard reset.

- **Display <Ctrl> <A> Messages during BIOS Initialization**-(Default: Enabled) When set to Enabled, the SCSI card BIOS displays the Press <Ctrl> <A> for SCSI Select (TM) Utility! message on your screen during system bootup. If this setting disabled, you can still invoke the SCSISelect Utility by pressing <Ctrl> <A> after the SCSI card BIOS banner appears.
- **Extended BIOS Translation for DOS Drives > 1 GByte**-(Default: Enabled) When set to **Enabled**, provides an extended translation scheme for SCSI hard disks with capacities greater than 1 GByte. This setting is necessary only for MS-DOS 5.0 or above; it is not required for other operating systems, such as NetWare or UNIX.

Caution: Changing the translation scheme destroys all data on the drive. Be sure to back your disk drives before changing the translation scheme.

Use the MS-DOS Fdisk command to partition a disk larger than 1GByte controlled by the SCSI card BIOS, when using DOS, Windows 3.1.x, or Windows 95/98.

- **Verbose/Silent Mode**-(Default: Verbose) When set to Verbose, the SCSI card BIOS displays the host adapter model on the screen during system buildup. When set to **Silent**, the message is not displayed during bootup.
- **Host Adapter BIOS (Configuration Utility Reserves BIOS Space)**-(Default: Enabled) Enables or disables the SCSI card BIOS.
- Leave at **Enabled** to allow the SCSI card BIOS to scan and initialize all SCSI devices.
- Set to **Disabled: Not scan** if the devices on the SCSI bus (for example, CD-ROM drives) are controlled by software drivers and do not need the BIOS, and you do not want the BIOS to scan the SCSI bus.
- Set to **Disabled: Scan Bus** if you do not need the BIOS, but you want it to scan the SCSI devices on the bus and you need to spin up the devices.

The following four options have no effect when the SCSI Card BIOS is disabled. (The SCSI Card BIOS is normally enabled by default.)

- **Domain Validation**.(Default: Enabled) Determines the optimal transfer rate for each device on the SCSI bus and sets transfer rates accordingly. Displays the resulting data transfer rate.

- **Support Removable Disks Under BIOS as Fixed Disks.** (Default: Disabled) Determines which removable-media drives are supported by the SCSI card BIOS. Choices are as follows:
 - **Disabled.** No removable-media drives are treated as hard disk drives. Software drivers are required because the drives are not controlled by the BIOS.
 - **Boot Only.** Only the removable-media drive designated as the boot device is treated as a hard disk drive.
 - **All Disks.** All removable-media drives supported by the BIOS are treated as hard disk drives.

Caution: You may lose data if you remove a removable-media cartridge from a SCSI drive controlled by the SCSI card BIOS while the drive is on. If you want to be able to remove the media while the drive is on, install the removable-media software driver and set Support Removable Disks Under BIOS as Fixed Disks to **Disabled**.

- **BIOS Support for Bootable CD-ROMs.** (Default: Enabled) When set to Enabled, the SCSI card BIOS allows the computer to boot from a CD-ROM drive.
- **BIOS Support for Int 13 Extensions.** (Default: Enabled) When set to Enabled, the SCSI card BIOS supports Int 13h extensions as required by Plug-and-Play. The setting can be either enabled or disabled if your system is not Plug-and-Play.

7.7 Using SCSI Disk Utilities

To access the SCSI disk utilities, follow these steps:

1. Select the SCSI Disk Utilities option from the menu that appears after starting SCSISelect. SCSISelect scans the SCSI bus (to determine the devices installed) and displays a list of all SCSI

7.8 Installation under Windows 2000

If you are only using SCSI hard drives without any IDE HDD drive installed. Please follow these steps:

1. Insert Windows 2000 CD Disk.
2. Press F6 immediately when it displays: “Set up is inspecting your computer’s hardware configuration.”
3. Then it enter SCSI installation. Please insert SCSI driver floppy disk.

7.9 Windows 9X Driver setup procedure

1. In the window 9x screen, click on “start” and select “setting”. Then click on the “Control Panel” icon to select .System.

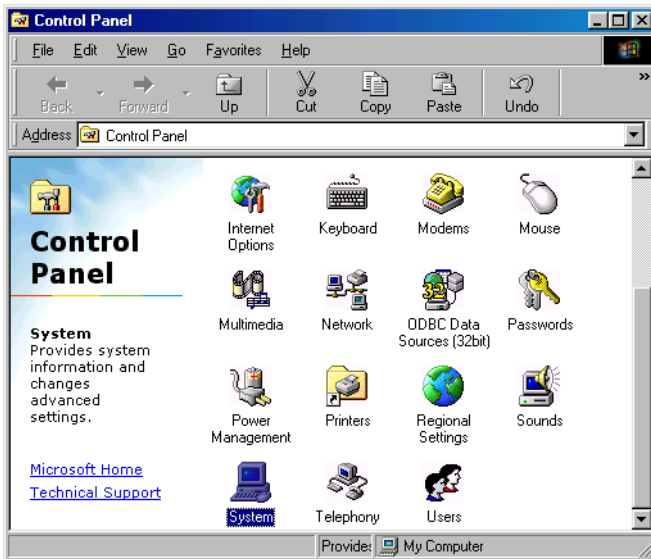

2. In the “System properties”, choose “PCI SCSI Bus Controller.” Then click on “Properties.”

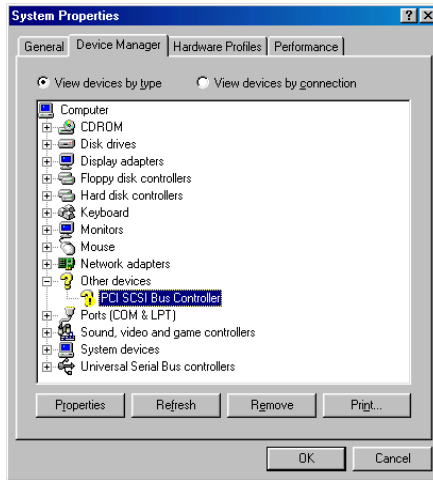

3. Click on "Update Driver"

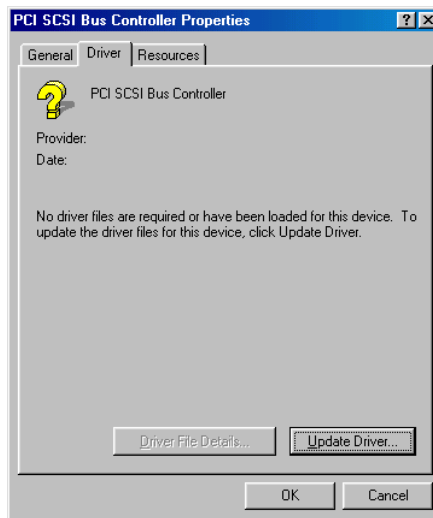

4. Click on “Next”

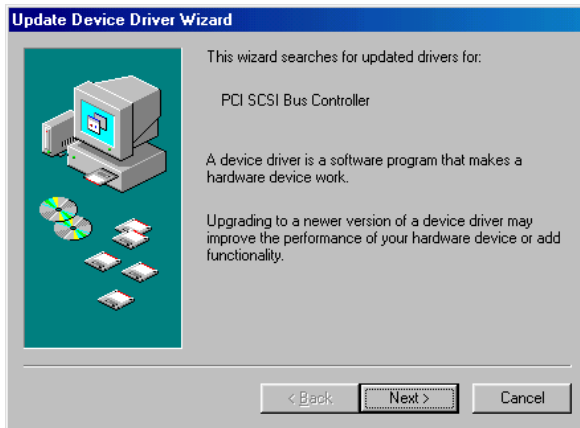

5. Recommend to search for a better driver



6. If the SCSI driver is supplied in floppy disk, click on "Floppy disk drives." Then, click on "Next." If the SCSI driver is supplied in CD-ROM disk, click on "Specify a location:" then enter "E:\Drv_SCSI\AIC7899\Windows\Win9X"

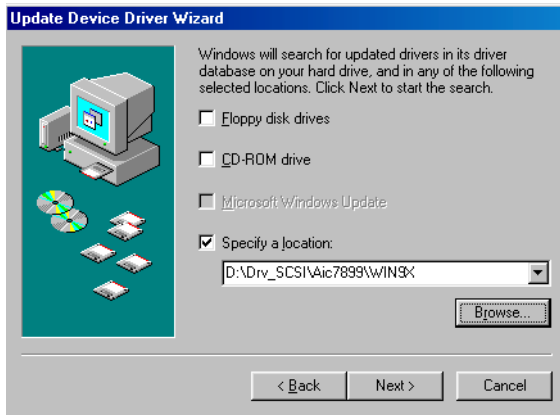

7. In the "Update Device Driver Wizard" click on "Next."

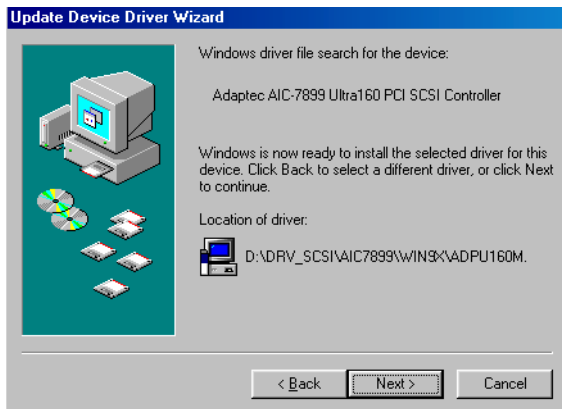

8. The installation is completed. Click on "Finish."

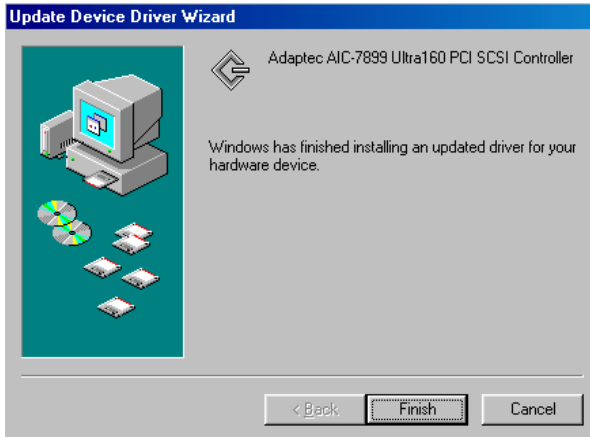

9. Click on "Yes" to restart the system.

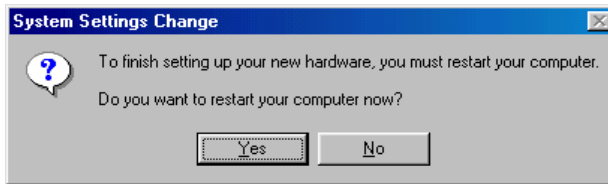

CHAPTER
8

USB 2.0 Configuration

Chapter 8 USB 2.0 Configuration

8.1 Introduction

The PCA-6189 is designed with Intel 6300ESB which supports both USB 1.1 and USB 2.0 high-speed transmission. It still remains the compatibility with today's USB device. High-speed USB 2.0 provides data transfer up to 480Mb/s which is 40 times faster than USB 1.1. It is ideal for today's speed-demanding I/O peripherals.

8.2 Features

- Provides data transmission rate up to 480Mb/s
- Offer 40 greater bandwidth than USB 1.1
- Offers complete compatibility with current USB device

8.3 Installation

Note: Before installing this driver, make sure the CSI utility has been installed in your system. See Chapter 4 for information on installing the CSI utility.

Note: Install service pack 4 under Windows 2000 to enable USB 2.0.

Note: Install service pack 1 under Windows XP to enable USB 2.0.

CHAPTER

9

Onboard Security Setup

Chapter 9 Onboard Security Setup

9.1 Introduction

The PCA-6189's hardware monitor is designed with Winbond W83627HF. Onboard security (OBS) functions monitor key hardware. They help you maintain your system's stability and durability. The PCA-6189 can monitor 5 sets of system positive voltages, 2 sets of system negative voltages, CPU cooling fan speed, and CPU temperature. The positive system voltage sets which can be monitored include:

- CPU core voltage: 1.3 V ~ 3.3 V, according to Intel specifications.
- Transmission voltage from CPU to chipset: typically 1.8 V.
- Chipset voltage: typically 3.3 V.
- Main voltage: +5 V, +12 V.

The negative system voltage sets which can be monitored include:

- Main voltage: -5 V, -12 V.

9.2 Windows XP Driver Setup

1. Insert the driver CD into your system's CD-ROM drive. In a few seconds, the software installation main menu appears, as shown in the following figure. Click on the "Install" button under the "OBS DRIVERS" heading.

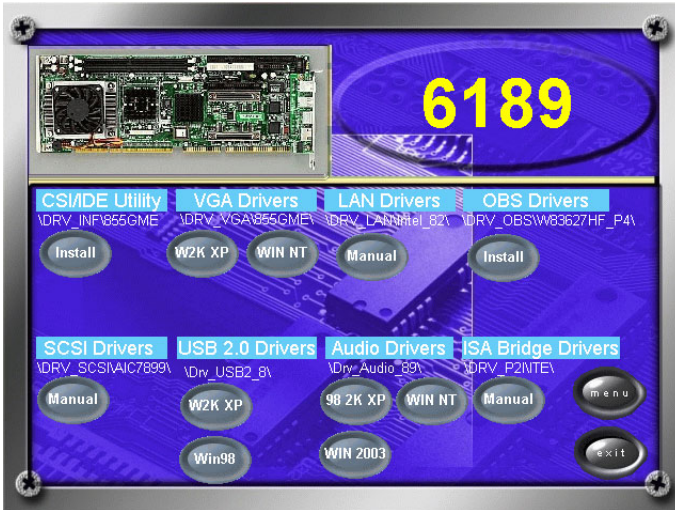

2. Click "Next" when you see the following message.

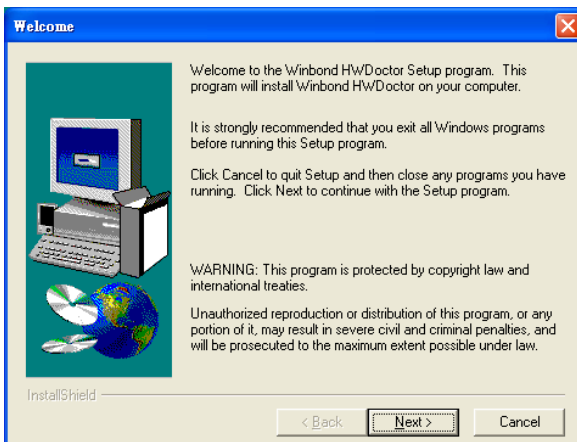

3. Click "Next" when you see the following message.

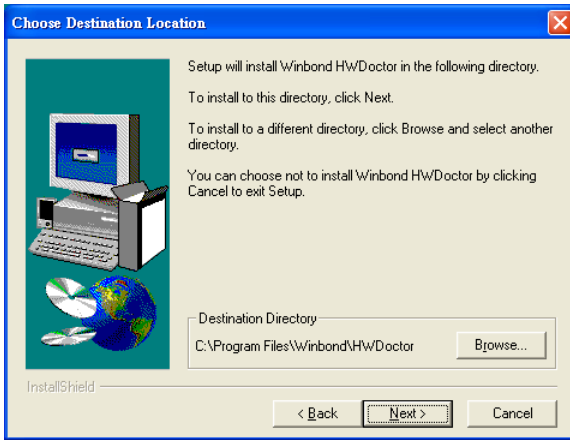

4. Click "Next" when you see the following message.

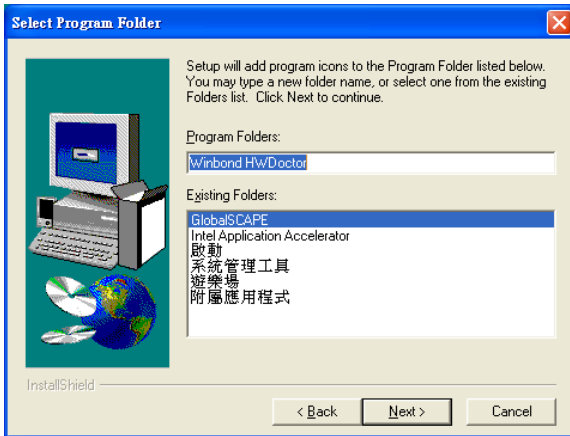

5. Click "Next" to continue.

6. Click "Finish" when you see the following message.

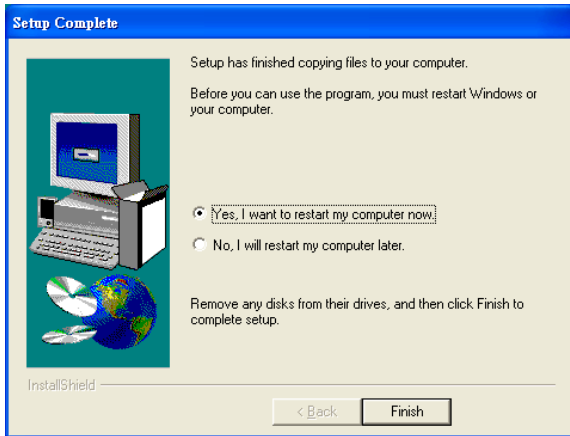

9.3 Using the OBS Hardware Doctor Utility

After completing the setup, all the OBS functions are permanently enabled. When a monitored reading exceeds safe limits, a warning message will be displayed and an error beep tone will activate to attract your attention.

OBS Hardware Doctor will show an icon on the right side of the bottom window bar. This icon is the "Terminate and Stay Resident" (TSR) icon. It will permanently remain in the bottom window bar, and will activate warning signals when triggered by the onboard security system.

You can view or change values for various OBS settings by running this utility:

1. From the desktop of Windows, click on "Start" and select "Programs", select "Winbond HWDDoctor" and click "HWDCTOR."

- It is recommended that you load the default values for all the OBS settings. However, if desired, you can establish new conditions for voltage, fan speed, and temperature.

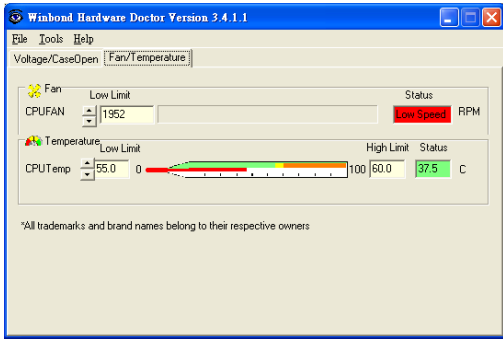
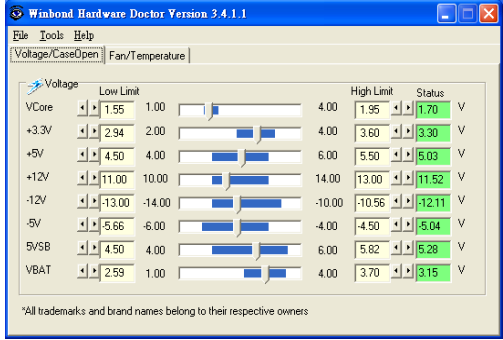

CHAPTER 10

SATA RAID Setup

Chapter 10 SATA RAID Setup

10.1 Introduction

To support demanding disk I/O, Intel 6300ESB chipset integrates two Serial ATA controllers with software RAID 0 and 1 capability. RAID 0 striping increases the storage performance and is designed to speed up data transfer rates for disk-intensive applications. RAID 1 mirroring protects valuable data that might be lost in the event of a hard drive failure.

Note: *Operating system support list: Microsoft Windows 2000, Windows Server 2003, Windows XP; Linux: Red Hat Advanced Server 2.1 and 3.0, SuSE SLES 8.0 and 8.2, SuSE 9.0, United Linux 1.0, Miracle Linux 2.1*

Note: *Device drivers and utility software require around 20 MB disk space*

10.2 Entering Setup

Turn on the computer and press <Ctrl> + <A> when following message prompted to enter the “Adaptec Embedded SATA HostRAID Controller” for setup:

Press <Ctrl><A> for Adaptec RAID Configuration Utility



Figure 10.1: RAID Setup initial screen

10.3 Array Configuration Utility

Select the “Array Configuration Utility” in the “Initial Setup Screen” menu, and the “SATA RAID Setup Main Menu screen” screen will display. This menu allows users to configure RAID function such as manage/create array, add/delete hotspare and initialize drives.

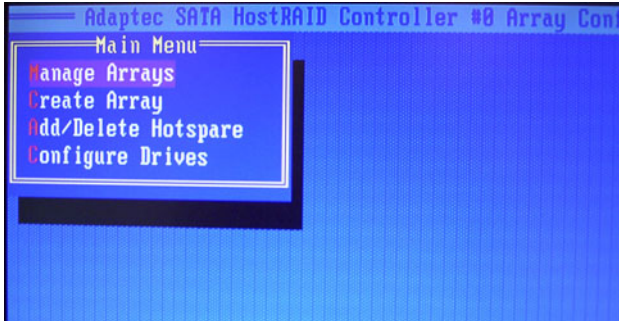

Figure 10.2: SATA RAID Setup Main Menu screen

10.3.1 Managing Arrays

Viewing Array Properties

1. From the manual, select the “Manage Arrays”
2. Select the array in the “List of array” and press “Enter” to view the selected array properties
3. Press “Esc” to return to the previous menu

Deleting Arrays

1. From the manual, select the “Manage Arrays”
2. Select the array you want to delete, and press “Delete”
3. In the “Array Properties” dialog box, select “Delete” and press “Enter”, then following warning message will be displayed:

Warning!! *Deleting the array will render array unusable.*

Do you want to delete the array? (Yes/No):

4. If press “Yes”, then following message will be displayed, and select the number you want: *To delete the partition table, choose which member: member #0, member #1, both, none*
5. Press “Esc” to return to the previous menu

10.3.2 Creating Arrays

Before creating arrays, please make sure that the disks for the array already connected and installed in the system.

1. Select “Create Array” from the setup main menu
2. Select the disks for the new array then press “Insert”. To deselect any disk, highlight the disk then press “Delete”
3. Press “Enter” when both selected disks ready, then the Array Properties menu displays
4. In the Array Properties menu, select a type of array and press “Enter”.
5. Type in a label of the created array and press “Enter”
6. For RAID 0, please select the desired stripe size from 16, 32, and 64 KB
7. Press “Done” when you finished

10.3.3 Adding/Removing a Bootable Array

To make a bootable array:

1. Select “Manage Arrays” from main menu
2. Select the array that you want to make it bootable and press “Ctrl+B” to make it a bootable array
3. To make the array nonbootable, select a bootable array and press “Ctrl+B” to make it become nonbootable

10.3.4 Add/Delete Hotspares

To make add, delete, or view hotspares, please select the “Add/Delete Hotspares” option.

1. Select “Add/Delete Hotspares” from the main menu
2. Select and highlight the disk you want to designate as a Hotspare, and then press “Insert”
3. Press “Yes” when the following message is displayed:
Do you want to create spare? (Yes/No)

10.3.5 Initializing Disk Drives

Initializing drives

1. Select “Initialize Drives” from the main menu
2. Select and highlight the disk you want to initializing, and then press “Insert”
3. Repeat Step 2 for initialize more drive

4. Press “Enter”
5. Read the warning message and type “Y” to continue

10.3.6 Rebuilding Arrays

You can rebuild the array to have optimal status by replacing a failed disk of a RAID 1 or RAID 10 array with a new disk.

Note: Rebuilding applies to Fault Tolerant arrays (RAID 1) only.

You can perform a Rebuild in the following ways:

System Shutdown Rebuild

Shutdown the system and replace the failed disk with a new one with equal or greater capacity. Once the system is booted, a new drive can be assigned as the spare drive, and this will start the Rebuild task. All the data from the good disk will be copied to the new one, and the original RAID 0 or RAID 1 array will be recreated.

Manual Rebuild

1. Select “Manage Arrays” from the main menu
2. Select and highlight the disk you want to rebuild, and then press “Ctrl + R” to Rebuild

Verifying Drives

If having a mismatch of data during a build of RAID 1, you can verify the drives with following steps:

1. Select the drives you want to verify
2. Press “Ctrl+S”
3. When the Verify is complete, you will be notified with any errors found during the Verify operation.

10.4 Installing the driver

Installing the driver in Windows system

Be sure to create the array before entering or installing the operating system.

1. Restart the computer
2. Press <Ctrl> + <A> to enter the “Adaptec Embedded SATA Host RAID Controller” to setup the SATA array system

3. When the array is build, insert the driver CD and restart the system
4. Windows searches the disk for a suitable driver
5. When the Adaptec Embedded Serial ATA HostRAID driver is found, press “Enter”. Follow the instructions to complete your installation.

Appendix

A

Programming the Watchdog Timer

Appendix A Programming the watchdog

A.1 Programming the Watchdog Timer

The PCA-6189's watchdog timer can be used to monitor system software operation and take corrective action if the software fails to function after the programmed period. This section describes the operation of the watchdog timer and how to program it.

A.1.1 Watchdog timer overview

The watchdog timer is built-in the super I/O controller W83627HF. It provides the following functions for user programming:

- Can be enabled and disabled by user's program.
- Timer can be set from 1 to 255 seconds or 1 to 255 minutes.
- Generates an interrupt or resets signal if the software fails to reset the timer after time-out.

A.1.2 Reset/ Interrupt selection

The J2 jumper is used to select reset or interrupt (IRQ 11) in the event the watchdog timer is tripped. See Chapter 1 for detailed jumper settings.

Note: The interrupt output of the watchdog timer is a low level signal. It will be held low until the watchdog timer is reset.

A.1.3 Programming the Watchdog Timer

The I/O port address of the watchdog timer is 2E(hex) and 2F(hex). 2E (hex) is the address port. 2F(hex) is the data port.

You must first assign the address of register by writing address value into address port 2E(hex), then write/read data to/from the assigned register through data port 2F (hex).

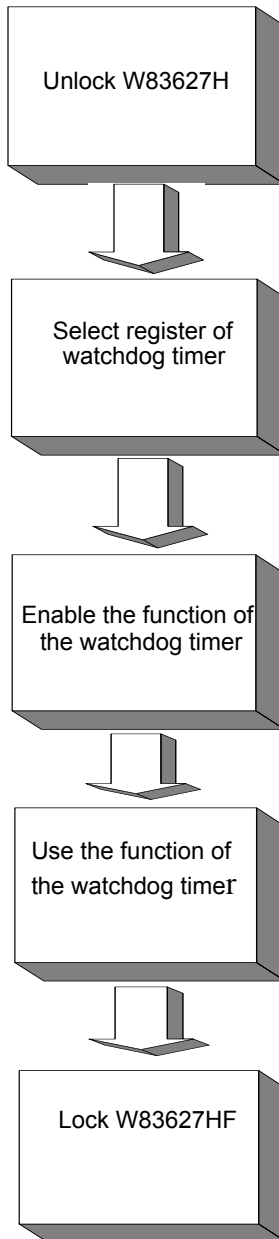

Watchdog Timer Registers		
Address of register (2E)	Attribute	
Read/Write	Value (2F) and description	
87 (hex)	----	Write this address to I/O address port 2E (hex) twice to unlock theW83627HF
07 (hex)	write	Write 08 (hex) to select register of watchdog timer.
30 (hex)	write	Write 01 (hex) to enable the function of the watchdog timer. Disabled is set as default.
F5 (hex)	write	Set seconds or minutes as units for the timer.
Write 0 to bit 3: set second as counting unit. [default]		
Write 1 to bit 3: set minute as counting unit		
F6 (hex)	write	0: stop timer [default] 01~FF (hex): The amount of the count, in seconds or minutes, depends on the value set in register F5 (hex). This number decides how long the watchdog timer waits for strobe before generating an interrupt or reset signal. Writing a new value to this register can reset the timer to count with the new value.

F7 (hex)	read/write	Bit 6: Write 1 to enable keyboard to reset the timer, 0 to disable.[default] Bit 5: Write 1 to generate a timeout signal immediately and automatically return to 0. [default=0] Bit 4: Read status of watchdog timer, 1 means timer is "time out".
AA (hex)	----	Write this address to I/O port 2E (hex) to lock the watchdog timer.2

Table A.1: Watchdog timer registers

A.1.4 Example Program

1. Enable watchdog timer and set 10 sec. as timeout interval

```

;-----
Mov dx,2eh                ; Unlock W83627HF
Mov al,87h
Out dx,al
Out dx,al
;-----
Mov al,07h                ; Select registers of watchdog timer
Out dx,al
Inc dx
Mov al,08h
Out dx,al
;-----
Dec dx                    ; Enable the function of watchdog timer
Mov al,30h
Out dx,al
Inc dx
Mov al,01h
Out dx,al

```

Dec dx ; Set second as counting unit

Mov al,0f5h

Out dx,al

Inc dx

In al,dx

And al,not 08h

Out dx,al

Dec dx ; Set timeout interval as 10 seconds and start counting

Mov al,0f6h

Out dx,al

Inc dx

Mov al,10

Out dx,al

Dec dx ; lock W83627HF

Mov al,0aah

Out dx,al

2. Enable watchdog timer and set 5 minutes as timeout interval

Mov dx,2eh ; unlock W83627H

Mov al,87h

Out dx,al

Out dx,al

Mov al,07h ; Select registers of watchdog timer

Out dx,al

Inc dx

Mov al,08h

Out dx,al

```
;-----  
Dec dx          ; Enable the function of watchdog timer  
Mov al,30h  
Out dx,al  
Inc dx  
Mov al,01h  
Out dx,al
```

```
;-----  
Dec dx          ; Set minute as counting unit  
Mov al,0f5h  
Out dx,al  
Inc dx  
In al,dx  
Or al,08h  
Out dx,al
```

```
;-----  
Dec dx          ; Set timeout interval as 5 minutes and start counting  
Mov al,0f6h  
Out dx,al  
Inc dx  
Mov al,5  
Out dx,al
```

```
;-----  
Dec dx          ; lock W83627HF  
Mov al,0aah  
Out dx,al
```

3. Enable watchdog timer to be reset by mouse

```
;-----  
Mov dx,2eh      ; unlock W83627H  
Mov al,87h  
Out dx,al
```

```

Out dx,al
;-----
Mov al,07h      ; Select registers of watchdog timer
Out dx,al
Inc dx
Mov al,08h
Out dx,al
;-----
Dec dx          ; Enable the function of watchdog timer
Mov al,30h
Out dx,al
Inc dx
Mov al,01h
Out dx,al
;-----
Dec dx          ; Enable watchdog timer to be reset by mouse
Mov al,0f7h
Out dx,al
Inc dx
In al,dx
Or al,80h
Out dx,al
;-----
Dec dx          ; lock W83627HF
Mov al,0aah
Out dx,al
4. Enable watchdog timer to be reset by keyboard
;-----
Mov dx,2eh      ; unlock W83627H
Mov al,87h
Out dx,al

```

```

Out dx,al
;-----
Mov al,07h      ; Select registers of watchdog timer
Out dx,al
Inc dx
Mov al,08h
Out dx,al
;-----
Dec dx          ; Enable the function of watchdog timer
Mov al,30h
Out dx,al
Inc dx
Mov al,01h
Out dx,al
;-----
Dec dx          ; Enable watchdog timer to be strobed reset by keyboard
Mov al,0f7h
Out dx,al
Inc dx
In al,dx
Or al,40h
Out dx,al
;-----
Dec dx          ; lock W83627HF
Mov al,0aah
Out dx,al
5. Generate a time-out signal without timer counting
;-----
Mov dx,2eh      ; unlock W83627H
Mov al,87h
Out dx,al

```

```

Out dx,al
;-----
Mov al,07h      ; Select registers of watchdog timer
Out dx,al
Inc dx
Mov al,08h
Out dx,al
;-----
Dec dx          ; Enable the function of watchdog timer
Mov al,30h
Out dx,al
Inc dx
Mov al,01h
Out dx,al
;-----
Dec dx          ; Generate a time-out signal
Mov al,0f7h
Out dx,al      ; Write 1 to bit 5 of F7 register
Inc dx
In al,dx
Or al,20h
Out dx,al
;-----
Dec dx          ; lock W83627HF
Mov al,0aah
Out dx,al

```

Appendix

B

I/O Pin Assignments

Appendix B Pin Assignments

B.1 IDE Hard Drive Connector (CN1, CN2)

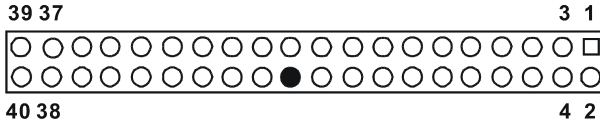

Table B.1: IDE hard drive connector (CN1, CN2)

Pin	Signal	Pin	Signal
1	IDE RESET*	2	GND
3	DATA 7	4	DATA 8
5	DATA 6	6	DATA 9
7	DATA 5	8	DATA 10
9	DATA 4	10	DATA 11
11	DATA 3	12	DATA 12
13	DATA 2	14	DATA 13
15	DATA 1	16	DATA 14
17	DATA 0	18	DATA 15
19	SIGNAL GND	20	N/C
21	DISK DMA REQUEST	22	GND
23	IO WRITE	24	GND
25	IO READ	26	GND
27	IO CHANNEL READY	28	CSEL
29	HDACKO*	30	GND
31	IRQ14	32	IDSC16-
33	ADDR 1	34	PDIAG
35	ADDR 0	36	ADDR 2
37	HARD DISK SELECT 0*	38	HARD DISK SELECT 1*
39	IDE ACTIVE*	40	GND

* low active

B.2 Floppy Drive Connector (CN3)

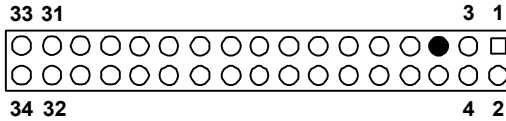

Table B.2: Floppy drive connector (CN3)

Pin	Signal	Pin	Signal
1	GND	2	FDHDIN*
3	GND	4	N/C
5	N/C	6	FDEDIN*
7	GND	8	INDEX*
9	GND	10	MOTOR 0*
11	GND	12	DRIVE SELECT 1*
13	GND	14	DRIVE SELECT 0*
15	GND	16	MOTOR 1*
17	GND	18	DIRECTION*
19	GND	20	STEP*
21	GND	22	WRITE DATA*
23	GND	24	WRITE GATE*
25	GND	26	TRACK 0*
27	GND	28	WRITE PROTECT*
29	GND	30	READ DATA*
31	GND	32	HEAD SELECT*
33	GND	34	DISK CHANGE*

* low active

B.3 Parallel Port Connector (CN4)

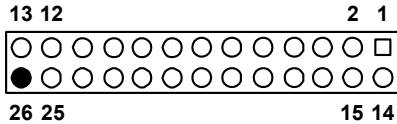

Table B.3: Parallel port connector (CN4)

Pin	Signal	Pin	Signal
1	STROBE*	14	AUTOFD*
2	D0	15	ERR
3	D1	16	INIT*
4	D2	17	SLCTINI*
5	D3	18	GND
6	D4	19	GND
7	D5	20	GND
8	D6	21	GND
9	D7	22	GND
10	ACK*	23	GND
11	BUSY	24	GND
12	PE	25	GND
13	SLCT	26	N/C

* low active

B.4 USB Connector (CN6)

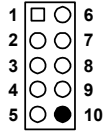

Table B.4: USB1/USB2 connector (CN6)

Pin	USB1 Signal	Pin	USB2 Signal
1	+5 V	6	+5 V
2	UV-	7	UV-
3	UV+	8	UV+
4	GND	9	GND
5	Chassis GND	10	N/CA

B.5 VGA Connector (CN7)

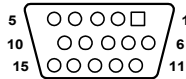

Table B.5: VGA connector (CN7)

Pin	Signal	Pin	Signal
1	RED	9	VCC
2	GREEN	10	GND
3	BLUE	11	N/C
4	N/C	12	SDT
5	GND	13	H-SYNC
6	GND	14	V-SYNC
7	GND	15	SCK

B.6 VCN2 LVD connector

(Insert diagram)

Pin	Signal	Pin	Signal
1	VDDSAFE5	21	G4
2	VDDSAFE5	22	G5
3	GND	23	G6
4	GND	24	G7
5	VDDSAFE3	25	R0
6	VDDSAFE3	26	R1
7	VCON	27	R2
8	GND	28	R3
9	B0	29	R4
10	B1	30	R5
11	B2	31	R6
12	B3	32	R7
13	B4	33	GND
14	B5	34	GND
15	B6	35	SFCLK
16	B7	36	FLM
17	G0	37	M
18	G1	38	LP
19	G2	39	ENBKL
20	G3	40	ENVEE

B.7 VCN3 DVI connector

(insert diagram)

Table B.7: VCN3 DVI connector

Pin	Signal	Pin	Signal
1	#TMDS1_0	11	GND
2	AGP_5V_TMDS2	12	DDC3_SDAOUT
3	TMDS1_0	13	#TMDS1_2
4	GND	14	#TMDS1_2
5	GND	15	TMDS1_2
6	TMDS1_CK	16	ATI_12C_DAT
7	#TMDS1_1	17	AGP_5V_TMDS2
8	GND	18	ATI_12C_CLK
9	#TMDS1_1	19	CPIS_ENA_BL
10	DDC3_SCLOUT	20	CPIS_VDD_VCL

B.8 COM1/COM2 RS-232 Serial Port (CN9, CN10)

(insert diagram)

Table B.8: COM1/2 RS-232 serial port (CN9/10)

Pin	Signal
1	DCD
2	RXD
3	TXD
4	DTR
5	GND
6	DSR
7	RTS
8	CTS
9	RI

B.9 PS/2 Keyboard/Mouse Connector (CN11)

(INSERT DIAGRAM)

Table B.9: PS/2 keyboard/mouse connector (CN11)

Pin	Signal
1	KB DATA
2	MS DATA
3	GND
4	VCC
5	KB CLOCK
6	MS CLOCK

B.10 External Keyboard Connector (CN12)

(Insert diagram)

Table B.10: External keyboard connector (CN12)

Pin	Signal
1	CLK
2	DATA
3	NC
4	GND
5	VCC

B.11 Power LED (CN16)

(insert diagram)

Table B.11: CPU Fan Power Connector (CN14)

Pin	Signal
1	GND
2	+12V
3	Detect

B.12 Power LED (CN16)

(insert diagram)

Table B.12: Power LED (CN16)

Pin	Function
1	LED power (+5 V)
2	NC
3	GND
4	NC
5	GND

B.13 External Speaker Connector (CN17)

(insert diagram)

Table B.13: External Speaker Connector (CN17)

Pin	Function
1	Internal buzzer
2	NC
3	Internal buzzer
4	Speaker out

B.14 Reset Connector (CN18)



Table B.14: Reset connector (CN18)

Pin	Signal
1	RESET
2	GND

B.15 ATX Feature Connector (CN20)



Table B.15: HDD LED connector (CN19)

Pin	Signal
1	VCC (LED+)
2	IDE LED (LED-)

B.16 ATX Feature Connector (CN20)

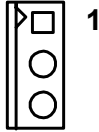

Table B.16: ATX Feature Connector (CN20)

Pin	Signal
1	PS-ON
2	VCC
3	VCCSB

B.17 ATX Soft Power Switch (CN21)



Table B.17: ATX soft power switch (CN21)

Pin	Signal
1	5VSB
2	PWR-BTN

B.18 H/W Monitor Alarm (CN22)

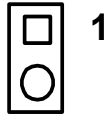

Table B.18: H/W Monitor alarm (CN22)

Pin	Signal
1	Enable OBS alarm
2	Disable OBS alarm

B.19 SM Bus Connector (CN29)

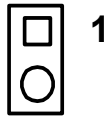

Table B.19: SM bus onnector (CN29)

Pin	Signal
1	SMB_DATA
2	SMB_CLK

B.20 Audio Interface (CN43)

(insert diagram)

Table B.20: Audio Interface(CN 43)

1 VCC	2 GND
3 Sync	4 BITCLK
5 SDOUT	6 SDIN0
7 SDIN1	8 AC-RST
9 +12V	10 GND
11 GND	12 N/C

B.21 LCD Inverter power connectore (VP1)

(insert diagram)

Table B.21: LCD inverter power connector (CN 20)

Pin	Signal
1	+12V
2	GND
3	ENABKL
4	VBR
5	+5V

B.22 System I/O Ports

Addr. range (Hex)	Device
000-01F	DMA controller
020-021	Interrupt controller 1, master
022-023	Chipset address
040-05F	8254 timer
060-06F	8042 (keyboard controller)
070-07F	Real-time clock, non-maskable interrupt (NMI) mask
080-09F	DMA page register
0A0-0BF	Interrupt controller 2
0C0-0DF	DMA controller
0F0	Clear math co-processor
0F1	Reset math co-processor
0F8-0FF	Math co-processor
1F0-1F8	Fixed disk
200-207	Game I/O
278-27F	Parallel printer port 2 (LPT3)
290-297	On-board hardware monitor
2F8-2FF	Serial port 2
300-31F	Prototype card
360-36F	Reserved
378-37F	Parallel printer port 1 (LPT2)
380-38F	SDLC, bisynchronous 2
3A0-3AF	Bisynchronous 1
3B0-3BF	Monochrome display and printer adapter (LPT1)
3C0-3CF	Reserved
3D0-3DF	Color/graphics monitor adapter
3F0-3F7	Diskette controller
3F8-3FF	Serial port 1

B.23 DMA Channel Assignments

Table B.23: DMA channel assignments

Channel	Function
0	Available
1	Available
2	Floppy disk (8-bit transfer)
3	Available
4	Cascade for DMA controller 1
5	Available
6	Available
7	Available

B.24 Interrupt Assignments

Table B.24: Interrupt assignments

Priority	Interrupt#	Interrupt source
1	NMI	Parity error detected
2	IRQ0	Interval timer
3	IRQ1	Keyboard
-	IRQ2	Interrupt from controller 2 (cascade)
4	IRQ8	Real-time clock
5	IRQ9	Cascaded to INT 0A (IRQ 2)
6	IRQ10	Available
7	IRQ11	Available
8	IRQ12	PS/2 mouse
9	IRQ13	INT from co-processor
10	IRQ14	Primary IDE Channel
11	IRQ15	Secondary IDE Channel
12	IRQ3	Serial communication port 2
13	IRQ4	Serial communication port 1
14	IRQ5	Parallel port 2
15	IRQ6	Diskette controller (FDC)
16	IRQ7	Parallel port 1 (print port)

B.25 1st MB Memory Map

Table B.25: 1st MB memory map

Addr. range (Hex)	Device
E0000h - FFFFFh	BIOS
CC000h - DFFFFh	Unused
C0000h - CBFFFh	VGA BIOS
A0000h - BFFFFh	Video Memory
00000h - 9FFFFh	Base memory

B.26 PCI Bus Map

Table B.26: PCI bus map

Function Signals	Device ID	INT# pin	GNT	REQ
Onboard LAN1		INT E		
Onboard LAN2	AD21	INT H	GNT F	REQ F
SCSI	AD19	INT F, G	GNT A	REQ A
Bridge	AD22		GNT E	REQ E
PCI slot 1	AD31	INT B, C, D, A	GNT A	REQ A
PCI slot 2	AD30	INT C, D, A, B	GNT B	REQ B
PCI slot 3	AD29	INT D, A, B, C	GNT C	REQ C
PCI slot 4	AD28	INT A, B, C, D	GNT D	REQ D

Free Manuals Download Website

<http://myh66.com>

<http://usermanuals.us>

<http://www.somanuals.com>

<http://www.4manuals.cc>

<http://www.manual-lib.com>

<http://www.404manual.com>

<http://www.luxmanual.com>

<http://aubethermostatmanual.com>

Golf course search by state

<http://golfingnear.com>

Email search by domain

<http://emailbydomain.com>

Auto manuals search

<http://auto.somanuals.com>

TV manuals search

<http://tv.somanuals.com>