



# SyncMaster150MP SyncMaster170MP

(For PAL systems)  
TFT-LCD Monitor



**Owner's  
Instructions**

## For Better Display

1. Adjust computer resolution and screen injection rate (refresh rate) in control panel of computer as described below to enjoy the best quality of picture. You can have an uneven quality of picture in the screen if the best quality of picture is not provided in TFT-LCD.
  - Resolution: 15" 1024 x 768      • Vertical frequency (refresh rate): 60 Hz
  - 17" 1280 x 1024
2. TFT LCD panel manufactured by using advanced semiconductor technology with precision of 99.999% above is used for this product. But the pixels of RED, GREEN, BLUE and WHITE color seem to be bright sometimes or some of black pixels could be seen. This is not from bad quality and you can use it without uneasiness.
  - For example, the no. of TFT LCD pixels that is contained in this product are 2,359,296 (15"), 3,932,160 (17").
3. When you clean the monitor and the panel outside, please apply the recommended small amount of cleaner by using soft and dry cloth and polish it. Let LCD area not to be forced but to be scrubbed out softly. If excessive force is applied, you can have a stain on it.
4. If you are not satisfied with the quality of picture, you can get better quality of picture by executing "auto adjustment function" in display screen that is appeared as window termination button is pressed. If there's still noise after automatic adjustment, use FINE/COARSE adjustment function.

**Information in this document is subject to change without notice.  
© 2001 Samsung Electronics Co., Ltd. All rights reserved.**

Reproduction in any manner whatsoever without the written permission of Samsung Electronics Co., Ltd. is strictly forbidden.

Samsung Electronics Co., Ltd. shall not be liable for errors contained herein or for incidental or consequential damages in connection with the furnishing, performance, or use of this material.



The *Samsung logo* and *SyncMaster* are registered trademarks of Samsung Electronics Co., Ltd.; *Microsoft*, *Windows*<sup>®</sup> and *Windows*<sup>®</sup> *NT* are registered trademarks of Microsoft Corporation; *VESA*, *DPMS* and *DDC* are registered trademarks of Video Electronics Standard Association; the *ENERGY STAR* name and logo are registered trademarks of the U.S. Environmental Protection Agency (EPA). As an ENERGY STAR Partner, Samsung Electronics Co., Ltd. has determined that this product meets the ENERGY STAR guidelines for energy efficiency. All other product names mentioned herein may be the trademarks or registered trademarks of their respective owners.

# Table of Contents

Safety Instructions . . . . .	2
Unpacking Your Monitor . . . . .	3
Setting up Your LCD Monitor . . . . .	4
Setting up an Ergonomic Workstation . . . . .	4
Monitor Location . . . . .	4
Workstation Height . . . . .	4
Viewing Angle . . . . .	4
Kensington Security Slot . . . . .	4
Connecting Your LCD Monitor . . . . .	5
Plug and Play . . . . .	6
Installing the Video Driver . . . . .	6
Self-Test Feature Check (STFC) . . . . .	6
Getting Help . . . . .	7
Warm-up Time . . . . .	7
Adjusting Your LCD Monitor . . . . .	8
User Controls . . . . .	8
Automatic Save . . . . .	9
Direct-Access Features . . . . .	10
OSD Lock/Unlock . . . . .	10
ON-Screen Display (OSD) . . . . .	11
Accessing the Menu System . . . . .	11
OSD Functions and Adjustments . . . . .	12
Appendix . . . . .	19
By Remote-Control . . . . .	19
PowerSaver . . . . .	21
Troubleshooting . . . . .	22
Specifications . . . . .	25
Pin Assignments . . . . .	27
Display Modes . . . . .	28
Installing VESA Compliant Mounting Devices . . . . .	30
Wall Mount Instructions . . . . .	30
Retractable Stand . . . . .	31
Maintenance of Your LCD Monitor . . . . .	31
Attaching a Wall or Arm Mounting Device . . . . .	32
Index . . . . .	33
Regulatory Information . . . . .	Inside back cover
Customer Service / Technical Support . . . . .	Back cover

## Safety Instructions

- 1** Before connecting the AC power cord to the DC adapter outlet, make sure the voltage designation of the DC adapter corresponds to the local electrical supply.
- 2** Never insert anything metallic into the cabinet openings of the liquid cristal display (LCD) monitor; doing so may create the danger of electric shock.
- 3** To avoid electric shock, never touch the inside of the LCD monitor. Only a qualified technician should open the case of the LCD monitor.
- 4** Never use your LCD monitor if the power cord has been damaged. Do not allow anything to rest on the power cord, and keep the cord away from areas where people can trip over it.
- 5** Be sure to hold the plug, not the cord, when disconnecting the LCD monitor from an electric socket.
- 6** Openings in the LCD monitor cabinet are provided for ventilation. To prevent overheating, these openings should not be blocked or covered. Also, avoid using the LCD monitor on a bed, sofa, rug, or other soft surface. Doing so may block the ventilation openings in the bottom of the cabinet. If you put the LCD monitor in a bookcase or some other enclosed space, be sure to provide adequate ventilation.
- 7** Put your LCD monitor in a location with low humidity and a minimum of dust.
- 8** Do not expose the LCD monitor to rain or use it near water (in kitchens, near swimming pools, etc.). If the LCD monitor accidentally gets wet, unplug it and contact an authorized dealer immediately. You can clean the LCD monitor with a damp cloth when necessary, but be sure to unplug the LCD monitor first.
- 9** Place the LCD monitor on a solid surface and treat it carefully. The screen is made of thin glass with a plastic front surface and can be damaged if dropped, hit or scratched. Do not clean the front panel with keton-type materials (e.g., acetone), ethyl alcohol, toluene, ethyl acid, methyl, or chloride – these may damage the panel.
- 10** Locate your LCD monitor near an easily accessible AC outlet.
- 11** If your LCD monitor does not operate normally – in particular, if there are any unusual sounds or smells coming from it – unplug it immediately and contact an authorized dealer or service center.
- 12** High temperature can cause problems. Don't use your LCD monitor in direct sunlight, and keep it away from heaters, stoves, fireplaces, and other sources of heat.
- 13** Unplug the LCD monitor when it is going to be left unused for an extended period of time.
- 14** Unplug your LCD monitor from the AC outlet before any service.

	<b>CAUTION</b> RISK OF ELECTRIC SHOCK DO NOT OPEN	
<b>CAUTION: TO REDUCE THE RISK OF ELECTRIC SHOCK, DO NOT REMOVE COVER (OR BACK).</b> <b>NO USER-SERVICEABLE PARTS INSIDE.</b> <b>REFER SERVICING TO QUALIFIED SERVICE PERSONNEL.</b>		

## Unpacking Your Monitor

Please make sure the following items are included with your monitor. If any items are missing, contact your dealer.



Installation CD  
(Not available in all locations)



Power Cord

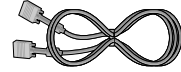

15-pin D-Sub Signal Cable



Warranty Card  
(Not available in all locations)



Monitor

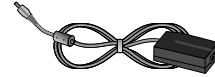

DC Adapter



Manual

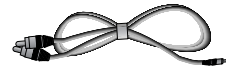

Stereo-RCA Cable  
(option)



Scart Jack



Stereo-Stereo Cable

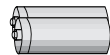

Batteries  
(AAA x 2)



Remote Controller



PAL-NTSC Connector  
(option)

## Setting up Your LCD Monitor

### Setting up an Ergonomic Workstation

Consider the advice given below before you install your monitor.

#### Monitor location

Choose a position that exposes your monitor to the least reflection from lights or windows, usually at a right angle to any window.

#### Workstation height

Place your LCD monitor so that the top of the screen is slightly below your eye level when you are comfortably seated.

#### Viewing angle

Tilt the screen until you feel comfortable working with your monitor.



Figure 1. Tilt the screen

### Kensington Security Slot

This monitor offers you the opportunity to secure your monitor using a Kensington-type security device. Kensington lock is not included. Refer to your locking device documentation for installation instructions.

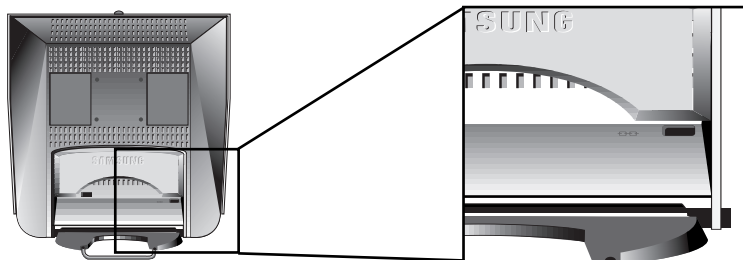

Figure 2. Kensington-type security slot location

## Setting up Your LCD Monitor

### Connecting Your LCD Monitor

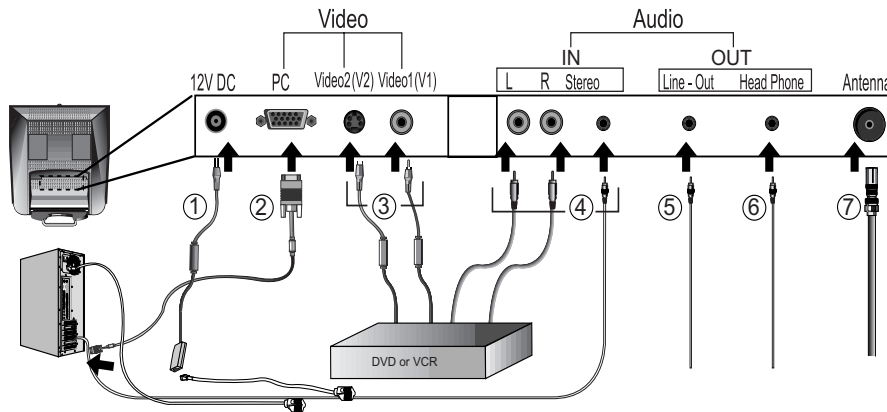

Figure 3. Cable connections

- 1** Connect the power cord to the DC adapter and connect the adapter jack to the DC12V power port on the back of your monitor.
- 2** Connect the signal cable to the video port on your computer.
- 3** Connect the RCA cable or S-VHS cable to your DVD, VCR or camcorder. (RCA cable and S-VHS cable not included)
- 4** Connect the audio sources (computer, DVD, VCR or Camcorder) to proper Audio input ports (Ain(L), Ain(R) or Ain(stereo)).
- 5** Connect your external audio system to the Line-out port.
- 6** Connect your headphone to the Headphone-out port.
- 7** Connect antenna or CATV cable to "Antenna" port.
- 8** Turn on both your computer and the monitor.
- 9** If necessary, install the video driver for the monitor. (See "Installing the video driver" on page 6)
- 10** After your monitor has been fully installed successfully, run Auto-Adjustment. (See page 12)

# Setting up Your LCD Monitor

## Plug and Play

The adoption of the new **VESA**<sup>®</sup> Plug and Play solution eliminates complicated and time consuming setup. It allows you to install your monitor in a Plug and Play compatible system without the usual hassles and confusion. Your PC system can easily identify and configure itself for use with your display. This monitor automatically tells the PC system its Extended Display Identification Data (EDID) using Display Data Channel (DDC) protocols so the PC system can automatically configure itself to use the flat panel display. If your PC system needs a video driver, follow the instructions given below according to the operating system your computer uses.

## Installing the Video Driver

The CD that accompanies this product contains the necessary drivers for installing your monitor. Please refer to the driver installation instructions included with your CD package for more information.

## Self-Test Feature Check (STFC)

Your monitor provides a self-test feature that allows you to check whether your monitor is functioning properly. Make sure that PC is selected as a primary source by checking if the source indicator LED labeled "PC" is on. If your monitor and computer are properly connected but the monitor screen remains dark and the power indicator is blinking, run the monitor self-test by following the steps given below:

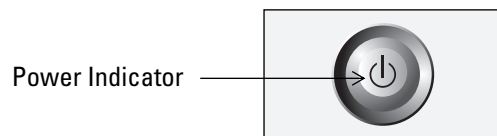

Figure 4. Power Indicator

- 1 Turn off both your computer and the monitor.
- 2 Unplug the video cable from the back of the computer.
- 3 Turn on the monitor.



## Setting up Your LCD Monitor

If the monitor is functioning properly, you will see a white box with a large blue oval Samsung logo and an error message "Check Signal Cable." in red color.

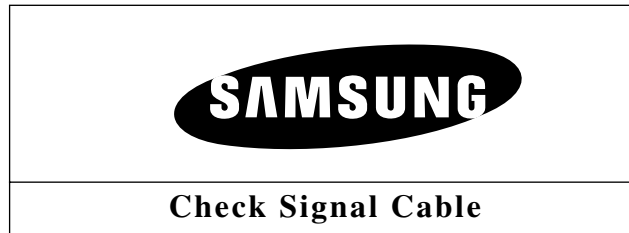

Figure 5. Monitor self-test screen

This box also appears during normal operation if the video cable becomes disconnected or damaged.

- 4 Turn off your monitor and reconnect the video cable; then turn on both your computer and the monitor.

If your monitor screen remains blank after following the previous procedure, check your video controller and computer system; your monitor is functioning properly.

### Getting Help

If your monitor does not display an image, check your cable connections and refer to "Troubleshooting" on page 22. If you experience difficulties with the quality of the displayed image, run Auto Adjustment (see page 12) and refer to "Adjusting Your LCD Monitor" on page 8 or "Troubleshooting" on page 22.

### Warm-up Time

All LCD monitors need time to become thermally stable whenever you turn on the monitor after letting the monitor be turned off for a couple of hours. Therefore, to achieve more accurate adjustments for parameters, allow the LCD monitor to warm (be on) for at least 20 minutes before making any screen adjustments.

## Adjusting Your LCD Monitor

### User Controls

Your LCD monitor allows you to easily adjust the characteristics of the image being displayed. All of these adjustments are made using the control buttons on the front of the monitor. While you use these buttons to adjust the controls, an on-screen menu shows you their numeric values as they change.

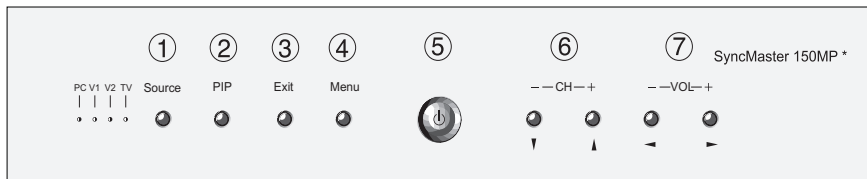

\* 17" : SyncMaster 170MP

Figure 6. User control locations

No.	Name	Description
1	Source	<ul style="list-style-type: none"> <li>■ Selects Video source.</li> <li>■ Four source indicator LEDs on the left of the control button indicate currently active Video source.</li> </ul>
2	PIP	<ul style="list-style-type: none"> <li>■ Activates PIP(Picture-in-Picture) window directly.</li> <li>■ PIP to Fullscreen video.</li> <li>■ PIP off.</li> </ul>
3	Exit	<ul style="list-style-type: none"> <li>■ Exits from menus and sub-menus.</li> <li>■ Exits from the OSD system.</li> <li>■ Turns the PIP off.</li> </ul>
4	Menu	<ul style="list-style-type: none"> <li>■ Opens the OSD and selects the highlighted function.</li> </ul>
5	Power	<ul style="list-style-type: none"> <li>■ Turns ON/OFF the monitor.</li> <li>■ Indicates the status of the monitor.               <ul style="list-style-type: none"> <li>-Green : Normal Operation.</li> <li>-Amber : Power Saving Mode or Disconnected Signal Cable.</li> </ul> </li> </ul>

## Adjusting Your LCD Monitor

No.	Name	Description
6	▼ ▲	■ Moves the selector up or down on the OSD.
	- CH +	■ Increases or decreases the channel number.
7	◀ ▶	■ Moves the selector left or right on the OSD. ■ Increases or decreases the values of the selected function.
	- VOL +	■ Increases or decreases the level of audio volume.

### Automatic Save



Whenever you open the on-screen menu and allow an adjustment window to remain active for about 3 seconds without pressing other buttons, the monitor automatically saves any adjustment you have made. These changes are saved into a user area in the monitor.

The monitor can save adjustments for up to 5 user modes. It has 9 for 150MP (11 for 170MP) factory preset or preload modes, one for each signal frequency as listed in table 7 on page 28. If you have made no adjustments, the on-screen menu disappears and the monitor does not save anything.

## Adjusting Your LCD Monitor

### Direct-Access Features

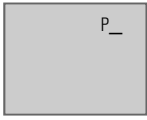
While you are watching full screen TV or in PIP mode

<p><b>Program</b></p>		<p>Valid only after performing "Channel auto program". When OSD is not on the screen, push the "▼" or "▲" button to select program channel number.</p> <p><b>1</b> Push the "▼" button to decrease channel number.</p> <p><b>2</b> Push the "▲" button to increase the channel number.</p>
<p><b>Volume</b></p>		<p>When OSD is not on the screen, push the "◀" or "▶" button to adjust volume.</p> <p><b>1</b> Push the "◀" button to decrease the volume.</p> <p><b>2</b> Push the "▶" button to increase the volume.</p>

### OSD Lock/Unlock

This function allows you to secure the current settings so that they cannot be inadvertently changed, while still allowing you to adjust the Brightness, Contrast, Channel, and Volume. You can unlock the OSD controls at any time by using the same procedure.

With the **OSD** screen off, push and hold the **Menu** button for at least 5 seconds to lock or unlock the controls. When locked, a 'LOCKED!' message will be displayed along the bottom of each OSD menu except for these screens :

- Brightness
- Contrast
- Channel
- Volume

# Adjusting Your LCD Monitor

## ON-Screen Display(OSD)

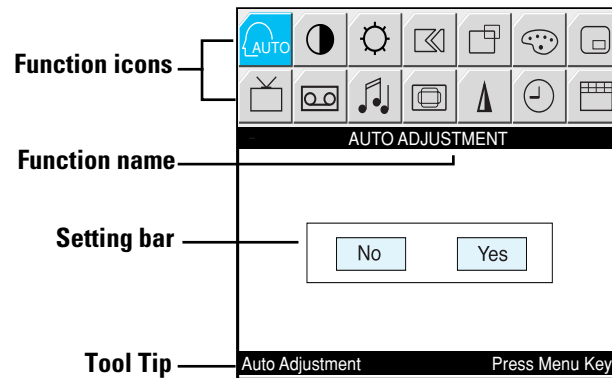

Figure 7. On-Screen Display(OSD)

### Accessing the menu system

- 1** With the OSD off, push the **Menu** button to display the main OSD menu.
- 2** Use the " ▼ ▲ ◀ ▶ " buttons to move from one function to another. As you move from one icon to another, the function name changes to reflect the function or group of functions represented by that icon. See Table 1 starting on the next page to view a complete list of all of the functions available for the monitor.
- 3** Press the **Menu** button once to activate the highlighted function, then follow the Tool Tips to select the function and adjust the value.
- 4** Use " ▲ " and " ▼ " buttons to select the sub-menu, and press the **Menu** button once to activate the selected sub-menu.
- 5** After selecting a function, use the " ◀ " and " ▶ " buttons to make necessary adjustments. The setting bar moves and the numeric value indicator changes to reflect your adjustments.









*NOTE: The numeric value indicator is provided as a point of reference only and has nothing to do with a real measurement.*

- 6** Push the **Exit** button a couple of times to return to the main menu to select another function or to exit from the OSD.

## Adjusting Your LCD Monitor











### OSD functions and adjustments

Table 1. Screen controls

Icon	Menus and Sub-menus	Function Descriptions	
		◀	▶
	<b>Auto Adjustment</b>	"Auto adjustment" allows the monitor to self-adjust to the incoming video signal. The values of fine, coarse and position are adjusted automatically.	
	<b>Contrast</b>		
	<b>Brightness</b>		
	<b>Image Lock</b>	Image Lock is used to fine tune and get the best image by removing noises that creates unstable images with jitters and shimmers.	



## Adjusting Your LCD Monitor

Table 1. Screen controls (Continued)

Icon	Menus and Sub-menus	Function Descriptions ◀ ▶	
	<ul style="list-style-type: none"> <li>■ Fine</li> <li>■ Coarse</li> </ul>	<p>The Fine and Coarse adjustments allow you to fine tune the image quality of your monitor to your preference. Use the "◀" and "▶" buttons to remove any noise. If satisfactory results are not obtained using the Fine adjustment, use the Coarse adjustment and then use Fine again. This function may change the width of the image. Use the H-Position menu to center the image on the screen.</p>	
		When Fine value is wrong.	When Coarse value is wrong.
			
		<ul style="list-style-type: none"> <li>■ Information</li> </ul>	Display current display mode.
	<ul style="list-style-type: none"> <li>■ Reset</li> </ul>	Image lock and position parameters are replaced with the factory default values.	
	<p><b>H-Position</b></p> 		
	<p><b>V-Position</b></p> 		

## Adjusting Your LCD Monitor

Table 1. Screen controls (Continued)

Icon	Menus and Sub-menus	Function Descriptions ◀ ▶
	<b>Color</b>	The tone of color can be changed from redish white to bluish white. The individual color components are also user customizable.
	■ Mode1	Redish white.
	■ Mode2	Plain white.
	■ Mode3	Bluish white.
	■ User Mode	User customizable.
	■ Reset	Color parameters are replaced with the factory default values.
	<b>PIP(Picture-in-Picture)</b>	When external A/V devices such as VCR, DVD or RF(TV)cable are connected to the monitor, PIP allows you to watch video from such devices in a small window super-imposed on pc video signal.
	■ Size	Resize PIP window.
	■ Position	Change PIP window position.
	<b>TV Setup</b>	The channel system can be set in several different ways.
	■ *Channel system	Select a channel system that is being used in your region. (See "PAL broadcasting systems" on page 29) CCIR AUSTRALIA Upon selecting a channel system, you will be asked if you want to perform "Channel auto program ". Select "OK " to perform the "Channel auto program " or select "Cancel" to select different channel system.

\* According to our R&D Lab test result, "Channel auto program" usually takes around 8 minutes to scan 70 channels. The scanning can be longer or shorter depending on the number of channels .





## Adjusting Your LCD Monitor

Table 1. Screen controls (Continued)

Icon	Menus and Sub-menus	Function Descriptions								
	<ul style="list-style-type: none"> <li>■ Manual Tune</li> </ul>	<p>Due to the weak signals or a wrong antenna configuration, some of the channels may not be tuned correctly or there could be a mismatch of the channel number between a Real channel and a Program channel. Use this menu to fine tune and perform necessary corrective actions.</p> <ul style="list-style-type: none"> <li>• Program : Program numbers are given in a sequential manner based on the search order of Channel Auto Program.</li> <li>• Channel: Channel numbers are given according to the CCIR or Australia standard channel table.</li> <li>• Save           <ul style="list-style-type: none"> <li>- Use ← → buttons to fine tune the picture quality and then select "Save" menu. Now press "Menu" button to save the fine tuned channel.</li> </ul> </li> <li>• Add           <ul style="list-style-type: none"> <li>- Use this function to add a real channel.</li> <li>- Use ← → buttons to select a desired channel and then select "Add" menu. Now press "Menu" button to add the channel.</li> </ul> </li> <li>• Cancel           <ul style="list-style-type: none"> <li>- Use this menu to undo the current job.</li> </ul> </li> </ul>								
	<ul style="list-style-type: none"> <li>■ Stereo System</li> </ul>	<ul style="list-style-type: none"> <li>• In most of the cases, stereo system is automatically detected. But, in case you are experiencing audio problem, use this menu to manually select the stereo system. Currently selected stereo system is highlighted and you can change the stereo system manually. Use ↑ ↓ buttons to select a stereo system.</li> </ul> <table style="margin-left: auto; margin-right: auto;"> <tr> <td>B/G</td> <td>A2</td> </tr> <tr> <td>B/G</td> <td>NICAM</td> </tr> <tr> <td>I</td> <td>NICAM</td> </tr> <tr> <td>D/K</td> <td>NICAM</td> </tr> </table>	B/G	A2	B/G	NICAM	I	NICAM	D/K	NICAM
B/G	A2									
B/G	NICAM									
I	NICAM									
D/K	NICAM									



## Adjusting Your LCD Monitor

Table 1. Screen controls (Continued)

Icon	Menus and Sub-menus	Function Descriptions
	<ul style="list-style-type: none"> <li>■ Channel Sort</li> </ul>	<p>Channel order can be re-arranged by this menu. If you want to place P5 before P2, see the example below.</p> <p>Example) from : P5 to : P2</p> <p>Before: P1 P2 P3 P4 P5</p>  <p>New: [ P1 P5 P2 P3 P4 ] P1 P2 P3 P4 P5</p>
	<ul style="list-style-type: none"> <li>■ Store</li> </ul>	<p>Select "store" menu to save the adjustment.</p>
	<ul style="list-style-type: none"> <li>■ Channel Delete</li> </ul>	<p>Select a channel you wish to delete by using the " From" menu, then select "Channel Delete" to delete the selected channel.</p>
	<p><b>Video Control</b></p>	<p>This funtion is active if you select an input source other than PC.(DVD,VCR,TV)</p>
	<ul style="list-style-type: none"> <li>■ Contrast</li> </ul>	<p>Adjust the contrast of video or TV without affecting PC RGB's contrast.</p>
	<ul style="list-style-type: none"> <li>■ Brightness</li> </ul>	<p>Adjust the brightness of video or TV without affecting PC RGB's brightness.</p>
	<ul style="list-style-type: none"> <li>■ Sharpness</li> </ul>	<p>Adjust the sharpness of video or TV image.</p>
	<ul style="list-style-type: none"> <li>■ Color</li> </ul>	<p>Change the richness of color.</p>



## Adjusting Your LCD Monitor

Table 1. Screen controls (Continued)

Icon	Menus and Sub-menus	Function Descriptions ◀ ▶
	<b>Audio Control</b>	The monitor has a built-in high fidelity stereo audio amplifier. The audio circuit processes audio signal from various external input sources such as DVD, VCR, TV or PC.
	<ul style="list-style-type: none"> <li>■ Source Select</li> </ul>	Selects a sound source from PC, DVD, VCR or TV.
	<ul style="list-style-type: none"> <li>■ Bass</li> </ul>	Bass: Emphasize low frequency audio.
	<ul style="list-style-type: none"> <li>■ Treble</li> </ul>	Treble: Emphasize high frequency audio.
	<ul style="list-style-type: none"> <li>■ Speaker mute</li> </ul>	Mutes the sound temporarily.  <i>NOTE: Mute is released when you change channel, adjust volume, activate PIP or access MTS menu via either the monitor or the remote controller.</i>
	<b>Image Size</b>	The size of the image being displayed can be handled in several different ways.
	<ul style="list-style-type: none"> <li>■ Expand1</li> </ul>	Resize the image to fill the whole screen. (applicable to PC RGB only : <b>150MP</b> ) (applicable to both PC RGB and video : <b>170MP</b> )
	<ul style="list-style-type: none"> <li>■ Expand2</li> </ul>	Expand images keeping the original aspect ratio. (applicable to PC RGB only : <b>150MP</b> ) (applicable to both PC RGB and video : <b>170MP</b> )
	<ul style="list-style-type: none"> <li>■ Normal</li> </ul>	Display the incoming image as it is. (applicable to PC RGB only : <b>150MP</b> ) (applicable to both PC RGB and video : <b>170MP</b> )
	<ul style="list-style-type: none"> <li>■ Zoom</li> </ul>	The image can be magnified up to 64 times larger than the original image. The enlarged image can also be panned.
	<ul style="list-style-type: none"> <li>■ Pan</li> </ul>	Move the zoomed image horizontally and vertically.

## Adjusting Your LCD Monitor

Table 1. Screen controls (Continued)

Icon	Menus and Sub-menus	Function Descriptions
	<b>Image Effect</b>	Image being displayed can be made softer or sharper. <ul style="list-style-type: none"> <li>• Sharpen more</li> <li>• Sharpen</li> <li>• Medium</li> <li>• Soften</li> <li>• Soften more</li> </ul>
	<b>Timer</b>	The monitor system will turn off automatically if one of three time intervals is selected. 30 min. 60 min. 120 min.
	<b>OSD Control</b>	OSD language and appearance can be changed.
	■ Language	English Deutsch Español Français Italiano Svenska
	■ Position	Move the OSD Window to the vertical and horizontal direction.
	■ Halftone	Change the opaqueness of the background of the OSD.
	■ Duration	The number of seconds that the OSD will remain visible before disappearing.
■ Beep	Enables or Disables the sound generated when you touch the control buttons.	

# Appendix

## By Remote-Control

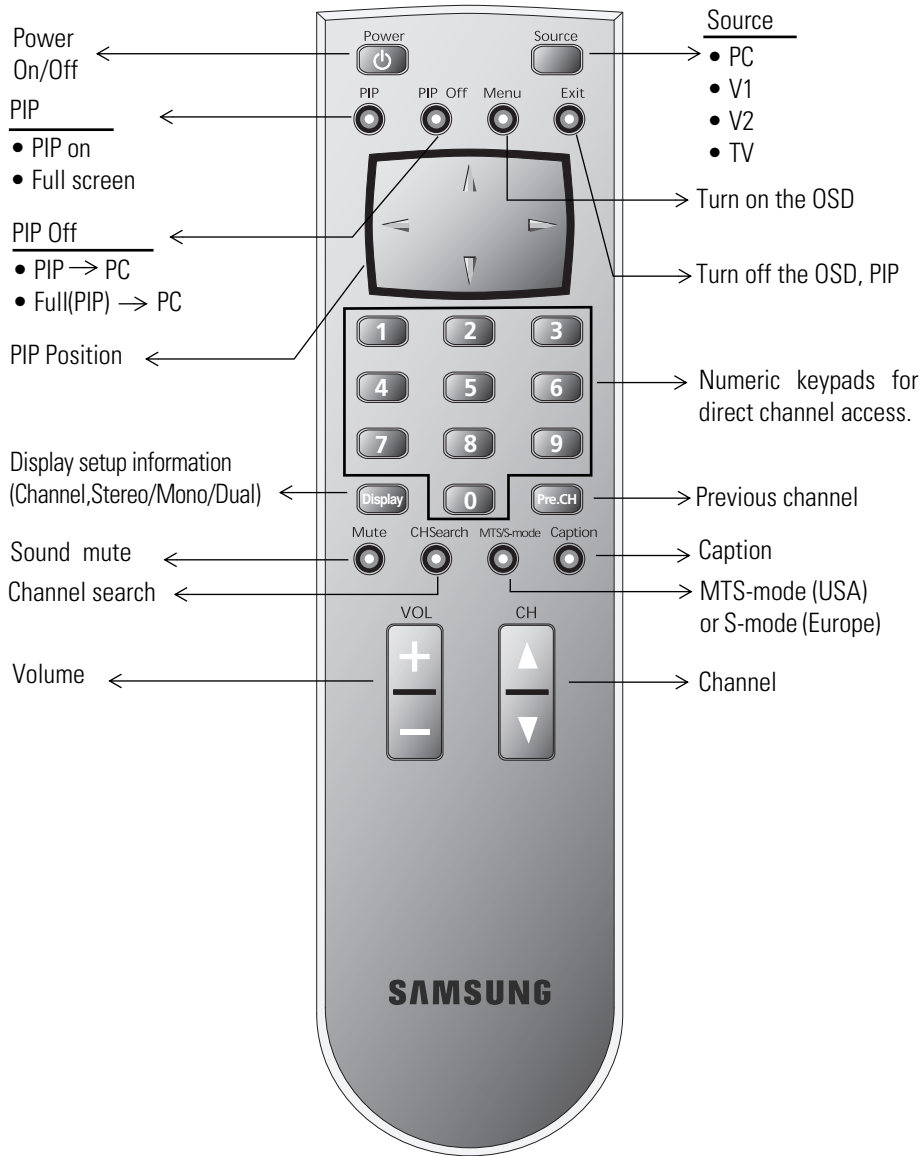

## Appendix

### ■ Features that can only be accessed via remote controller

Display	Shows a current channel number and an audio type on the upper right corner of the screen. <div data-bbox="778 622 978 757" style="border: 1px solid black; padding: 5px; margin: 10px auto; width: fit-content;">                     P12 Stereo                 </div>		
MTS/S-Mode	You can set the audio mode by using this button. When you press this button, current audio mode is displayed on the lower left corner of the screen <div data-bbox="778 875 978 1003" style="border: 1px solid black; padding: 5px; margin: 10px auto; width: fit-content;">                     Stereo                 </div> <p data-bbox="528 1048 1225 1171">Note) SyncMaster150/170MP have an automatic stereo detection feature. Thus, depending on the types of audio, the monitor automatically changes their audio mode from Mono to Stereo or vice versa.</p>		
	Audio Type	MTS/S-Mode	Default
FM Stereo	Mono	Mono	Automatic Change
	Stereo	Mono ← → Stereo	
	Dual	Dual1 ← → Dual2	Dual1
NICAM	Mono	Mono	Automatic Change
	Stereo	Mono ← → Stereo	
	Dual	Mono → Dual1 → Dual2 ↑ ← →	Dual1

## Appendix

### PowerSaver

This monitor has a built-in power management system called PowerSaver. This system saves energy by switching your monitor into a low-power mode when it has not been used for a certain period of time. The available modes are "On", "Standby", "Sleep", and "Deep Sleep". PowerSaver operates with a VESA DPMS compliant video card installed in your computer. You use a software utility installed on your computer to set up this feature. See Table 2 below for details.

Table 2. Power-saving modes

State	Normal Operation	Power-Saving Function mode (EPA/NUTEK)		
		Standby Mode	Sleep Mode Position A1	Deep Sleep Mode Position A2
Horizontal Sync Vertical Sync Video	Active Active Active	Inactive Active Blanked	Active Inactive Blanked	Inactive Inactive Blanked
Power Indicator	Green	Amber	Amber Blinking (0.5 sec interval)	Amber Blinking (1 sec interval)
Power Consumption	<b>150MP :</b> 33W (Max.) <b>170MP :</b> 52W (Max.)	Less than 3W	Less than 3W	Less than 3W

*NOTE: This monitor automatically returns to normal operation when horizontal and vertical sync return. This occurs when you move the computer's mouse or press a key on the keyboard.*

This monitor is EPA ENERGY STAR<sup>®</sup> compliant and NUTEK compliant when used with a computer equipped with VESA DPMS functionality. For energy conservation, turn your monitor OFF when you are not using it or when leaving it unattended for long periods.

## Appendix

### Troubleshooting

If you have a problem setting up or using your LCD monitor, you may be able to solve it yourself. Before contacting customer service, try the suggested actions that are appropriate to your problem.

Table 3. Troubleshooting – Image

What you see...	Suggested Actions	Reference
Screen is blank and power indicator is off	<ul style="list-style-type: none"> <li>■ Ensure that the power cord is firmly connected and the LCD monitor is on.</li> </ul>	Connecting your LCD monitor, page 5.
“ Check Signal Cable” message	<ul style="list-style-type: none"> <li>■ Ensure that the signal cable is firmly connected to the PC or video sources.</li> <li>■ Ensure that the PC or video sources are turned on.</li> </ul>	Connecting your LCD monitor, page 5.
“Sync. Out of Range” message	<ul style="list-style-type: none"> <li>■ Check the maximum resolution and the frequency of the video adaptor.</li> <li>■ Compare these values with the data in the Display Modes Timing Chart.</li> </ul>	Display Modes, page 28.
The image is too light or too dark	<ul style="list-style-type: none"> <li>■ Adjust the Brightness and Contrast.</li> </ul>	Brightness, page 12. Contrast, page 12.
Horizontal bars appear to flicker, jitter or shimmer on the image	<ul style="list-style-type: none"> <li>■ Adjust the Fine function.</li> </ul>	Image Lock, Fine, page 12~13.
Vertical bars appear to flicker, jitter or shimmer on the image.	<ul style="list-style-type: none"> <li>■ Adjust the Coarse function and then adjust the Fine function.</li> </ul>	Image Lock, Coarse, page 12~13. Image Lock, Fine, page 12~13.



## Appendix

Table 3. Troubleshooting – Image (Continued)

What you see...	Suggested Actions	Reference
Screen is blank and power indicator light is steady amber or blinks every 0.5 or 1 seconds	<ul style="list-style-type: none"> <li>■ The monitor is using its power management system.</li> <li>■ Move the computer's mouse or press a key on the keyboard</li> </ul>	Power Saver, page 21.
Image is not stable and may appear to vibrate	<ul style="list-style-type: none"> <li>■ Check that the display resolution and frequency from your PC or video board is an available mode for your monitor. On your computer check: Control Panel, Display, Settings</li> </ul>	Display Modes, page 28.
	<ul style="list-style-type: none"> <li>■ If the setting is not correct, use your computer utility program to change the display settings.</li> </ul>	Installing the Video Driver, page 6.
	<i>NOTE: Your monitor supports multiscan display functions within the following frequency domain:</i>	
	<ul style="list-style-type: none"> <li>■ Horizontal frequency:</li> <li>■ Vertical frequency:</li> <li>■ Maximum refresh rate:</li> </ul>	<b>150MP</b> : 30 kHz – 69 kHz <b>170MP</b> : 30 kHz – 81kHz  56 Hz – 85 Hz  <b>150MP</b> : 1024 x 768 @ 85 Hz <b>170MP</b> : 1280 x 1024 @ 76Hz
Image is not centered on the screen.	<ul style="list-style-type: none"> <li>■ Adjust the horizontal and vertical position.</li> </ul>	H-Position, page 13. V-Position, page 13.
You need the monitor driver software	<ul style="list-style-type: none"> <li>■ Download the driver from WWW pages:  <a href="http://samsungelectronics.com/support/downloads/monitor/index.html">http://samsungelectronics.com/support/downloads/monitor/index.html</a> </li> </ul>	

## Appendix

Table 4. Troubleshooting – Audio and TV

Problem	Suggested Actions	Reference
No sound	<ul style="list-style-type: none"> <li>■ Ensure that the audio cable is firmly connected to both the audio-in port on your monitor and the audio-out port on your sound card.</li> </ul>	Connecting your LCD Monitor, page 5.
	<ul style="list-style-type: none"> <li>■ Check the volume level</li> </ul>	Audio Controls, page 17.
Sound level is too low	<ul style="list-style-type: none"> <li>■ Check the volume level</li> </ul>	Audio Controls, page 17.
	<ul style="list-style-type: none"> <li>■ If the volume is still too low after turning the control to its maximum, check the volume control on the computer sound card or software program.</li> </ul>	Refer to your computer, sound card or software documentation.
Sound is too high pitched or too low pitched	<ul style="list-style-type: none"> <li>■ Adjust the Treble and Bass to appropriate level.</li> </ul>	Audio Controls, page 17.
TV signal is not received	<ul style="list-style-type: none"> <li>■ Check "Channel system" and make sure you choose the correct channel system.</li> <li>■ Select "Channel auto program" to configure the channel system automatically.</li> </ul>	See "PAL broadcasting systems" on page 29.

## Appendix

### Specifications

Table 5. Technical and environmental specifications

		150MP	170MP
Panel	Size Display Size Type Pixel pitch Viewing Angle	15.0" Diagonal 304.1 (H) x 228.1 (V) mm a-si TFT active matrix 0.297 (H) x 0.297 (V) mm 70/70/60/60 (L/R/U/D) (Depending on the panel manufacturer, the viewing angle may be different from this spec.)	17.0" Diagonal 338 (H) x 270 (V) mm a-si TFT active matrix 0.264 (H) x 0.264 (V) mm 80/80/80/80 (L/R/U/D) (Depending on the panel manufacturer, the viewing angle may be different from this spec.)
* Frequency	Horizontal Vertical  Display color	30 – 69 kHz 56 – 85 Hz  16,777,216 colors	30 – 81 kHz 56 – 85 Hz (~XGA) 60 – 76 Hz (SXGA) 16,777,216 colors
Display Resolution	Optimum Mode Maximum Mode	1024 x 768 @ 60 Hz 1024 x 768 @ 85 Hz	1280 x 1024 @ 60 Hz 1280 x 1024 @ 76 Hz
Input Signal	Sync.  Video signal	H/V Separate, TTL, P. or N. H/V Composite, TTL, P. or N. Sync-on-green 0.3 Vp-p, N. 0.7 Vp-p @ 75 ohm	
TV, Video	Color system Sound system Video format	PAL B/G, D/K, I CVBS, S-VHS	
Video	Color system	PAL/NTSC	
Power Supply	Input Output	AC 100-240 Vrms (50 ~ 60Hz) DC 12V/3A	AC 100-240 Vrms (50 ~ 60Hz) DC 12V/4.5A

\* Referring to Standard signal modes, page 28.

## Appendix

**Table 5. Technical and environmental specifications**

		150MP	170MP
Power Consumption	Maximum Power Saving	33 W < 3 W	52 W < 3 W
Dimensions/ Weight	Unit (WxHxD) : Monitor body	15.0 x 15.0 x 2.2 inch / 9.7 lbs (382 x 380 x 57 mm / 4.4 kg )	17.6 x 17.2 x 2.48 inch / 14.3 lbs (448 x 438 x 63 mm / 6.5 kg)
	With stand	15.0 x 15.0 x 6.0 inch / 9.7 lbs (382 x 380 x 153 mm / 4.4 kg)	17.6 x 17.2 x 8.15 inch / 14.3 lbs (448 x 438 x 207 mm / 6.5 kg)
	When folded	15.0 x 17.7 x 2.4 inch / 9.7 lbs (382 x 450 x 61 mm / 4.4 kg)	17.6 x 20.5 x 2.75 inch / 14.3 lbs (448 x 522 x 70 mm / 6.5 kg)
	Carton	19.1 x 20.5 x 8.0 inch / 15.4 lbs (486 x 522 x 203 mm / 7.0 kg)	22.5 x 24.8 x 7.95 inch / 20.9 lbs (572 x 632 x 202 mm / 9.5 kg)
Environmental Considerations	Operating Temperature Operating Humidity Storage Temperature Storage Humidity	50 °F to 104 °F (10 °C to 40 °C) 10% to 80% 13 °F to 113 °F (-25 °C to 45 °C) 5% to 95%	
Audio Characteristics	Audio Input 1 Audio Input 2 Line-out (Audio out) Headphone out Frequency Response	RCA Jack Red(R) White(L), 0.5Vrms (-9dB) 3.5Ø Stereo Jack, 0.5Vrms (-9dB) 3.5Ø Stereo Jack, 0.7Vrms (-7dB)  Max. 10mW Output (3.5Ø Stereo Jack 32Ω) RF: 80Hz - 15kHz (at - 3dB) A/V: 80Hz - 20kHz (at - 3dB)	

## Appendix

### Pin Assignments

Table 6. 15 pin D-sub connector

Pin	Separate H/V	Composite H/V	Sync-on-green
1	Red	Red	Red
2	Green	Green	Green + H/V Sync
3	Blue	Blue	Blue
4	GND	GND	GND
5	GND (DDC Return)	GND (DDC Return)	GND (DDC Return)
6	GND-Red	GND-Red	GND-Red
7	GND-Green	GND-Green	GND-Green
8	GND-Blue	GND-Blue	GND-Blue
9	No Connection	No Connection	Not used
10	GND-Sync/Self Test	GND-Sync/Self Test	GND-Sync/Self Test
11	GND	GND	GND
12	DDC_SDA	DDC_SDA	DDC_SDA
13	H_Sync	H/V Sync	Not used
14	V_Sync	Not used	Not used
15	DDC_SCL	DDC_SCL	DDC_SCL

## Appendix

### Display Modes

If the signal from the system equals to the standard signal mode, the screen is adjusted automatically. If the signal from the system doesn't equal to the standard signal mode, adjust the mode with referring to the Videocard user guide because the screen might not display or only the power LED might be on. For the display modes listed below, the screen image has been optimized during manufacture.

Table 7. Preset timing modes

Mode	Resolution	Horizontal Frequency (kHz)	Vertical Frequency (Hz)	Pixel Clock Frequency (MHz)	Sync Polarity (H/V)
VGA	720 x 400	31.469	70.087	28.322	-/+
	640 x 480	31.469	59.940	25.175	-/-
	640 x 480	37.500	75.000	31.500	-/-
	640 x 480	43.269	85.008	36.000	-/-
SVGA	800 x 600	46.875	75.000	49.500	+/+
	800 x 600	53.674	85.061	56.250	+/+
XGA	1024 x 768	48.363	60.004	65.000	-/-
	1024 x 768	60.023	75.029	78.750	+/+
	1024 x 768	68.677	84.997	94.500	+/+
SXGA (170MP only)	1280 x 1024	63.981	60.020	108.000	+,-/+,-
	1280 x 1024	79.976	75.025	135.000	+/+

## Appendix

Table 8. PAL Broadcasting Systems

Model Name	Color System	Sound System	Stereo System	Channel System	Countries
150MP 170MP	PAL	B/G	A2	CCIR	Germany,Austria,Swiss,Netherlands,
				AUSTRALIA	Australia
		I	NICAM	CCIR	Sweden,Spain,Denmark,Norway, Finland,Belgium,Iceland,Portugal, Malaysia,Singapore,Thailand
				CCIR	India,Israel,Kuwait,Jordan,Yugoslavia
				CCIR	UK,Hongkong

## Appendix

### Installing VESA compliant mounting devices

Refer to page 32 to fold the base.

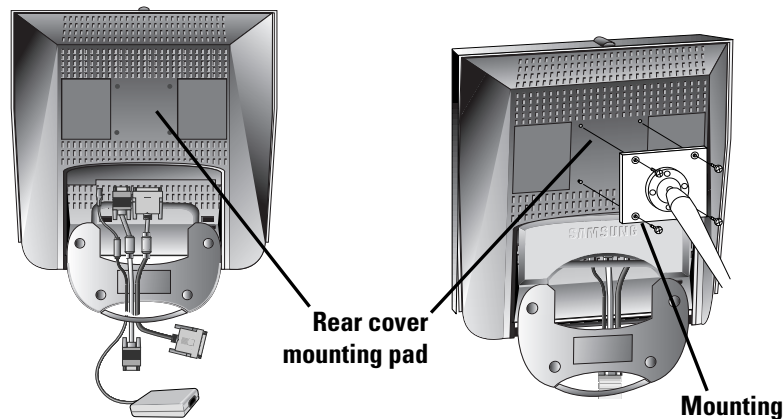

Align the mounting interface pad with the holes in the rear cover mounting pad and secure it with the four screws that came with the arm-type base, wall mount hanger or other bases.

#### Wall Mount Instructions

The following instructions apply to a hollow sheet-rock wall only Tools/Hardware needed - Philips screwdriver, four toggle bolts, 5/8in dia. Drill bit and drill. Contact Ergotron at (800) 888-8458 to purchase the triple pivot direct mount adapter and wall mount bracket kit.

- **150MP (15")** : No. 47 - 007 - 099 (Pivot direct mount adapter)  
No. 97 - 101 - 003 (Wall mount bracket kit)
- **170MP (17")** : No. 47 - 007 - 099 - 02 (Pivot direct mount adapter)  
No. 97 - 101 - 003 - 00 (Wall mount bracket kit)

Align the wall mount bracket on the wall at the desired height, making sure that the bracket will be mounted between the wall studs. Mark the four corner openings and drill four 5/8-dia. holes.

Assemble the wall mount kit according to the instructions provided with it.

Securely attach Ergotron's flat panel, triple pivot direct mount adapter to the back of the monitor using the four 4mm, .7 pitch x 10mm screws provided with the arm.

Secure the assembly to the wall using four 3/16 by 3-inch long toggle bolts.



## Appendix

### Retractable Stand

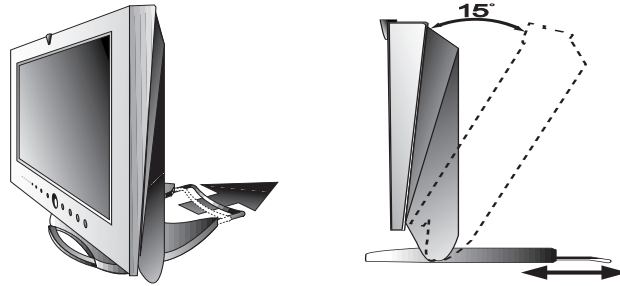

*NOTE: \*Please pull the rear retractable part of the stand when you tilt the monitor to the backward direction to give more stability. The maximum tilt angle is 15 degree to the backward direction. Please do not tilt the monitor other than specified range. **Excessive force to tilt the monitor other than specified range may give permanent damage to the mechanical part of the stand.***

### Maintenance of Your LCD monitor

**WARNING:** To avoid risk of electric shock, do not disassemble the monitor cabinet (except for gaining access to the cable connectors as described on page 5). Users cannot service the monitor. User maintenance is restricted to cleaning as explained below:

Unplug the monitor from the power outlet before cleaning.

- To clean your flat panel display screen, lightly dampen a soft, clean cloth with water or mild detergent. If possible, use a special screen cleaning tissue or solution suitable for the antistatic coating.
- To clean the monitor cabinet, use a cloth lightly dampened with a mild detergent.
- Never use flammable cleaning material to clean your LCD monitor or any other electrical apparatus.

## Appendix

### Attaching a wall or Arm mounting device

The monitor supports VESA mounting standard for use with various VESA mounting devices. To install any VESA mounting device, please follow the instructions given.

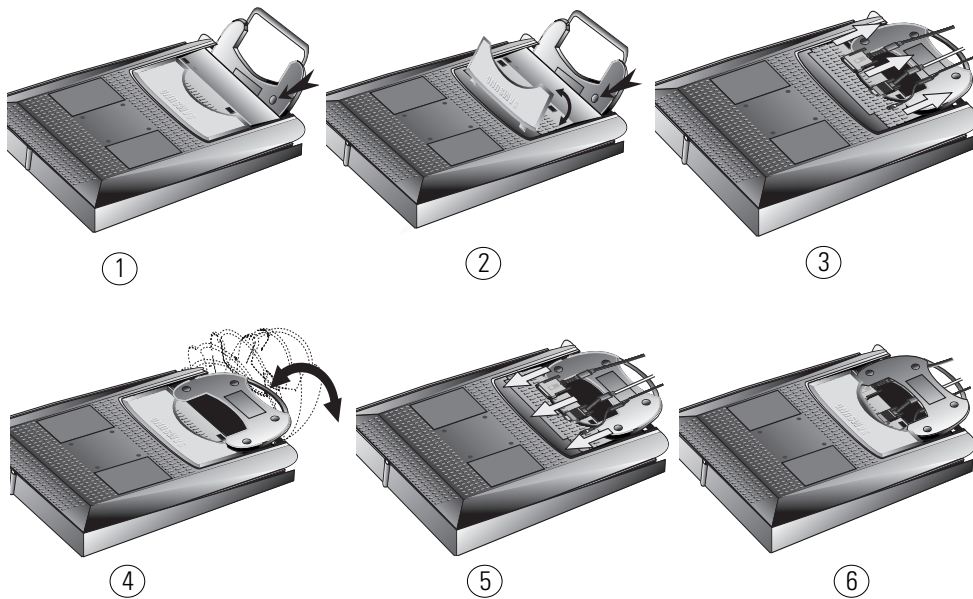

- 1** Lay the LCD monitor face-down on a flat surface with a cushion or other soft materials to protect the screen.
- 2** Remove the connector cover
- 3** Remove any cable connected on the monitor.
- 4** Press "FOLD" button on the stand and tilt the monitor backward until the stand in up-right position.
- 5** Connect any cable you removed at step 3.
- 6** Place the connector cover removed at step 2.
- 7** Now you are ready to install Wall/Arm mounting device depending on your applications.

## Index

### A

Audio control 17  
Automatic Save 9  
Auto adjustment 12

### B

Bass 17  
Beep 18  
Brightness 12

### C

Cable connections 5  
CH 9  
Channel 10  
Channel Sort 16  
Coarse 13  
Color 14  
Contrast 12

### D

DC adapter 3  
Display Modes 28  
Duration 18

### E

Exit 8

### F

Fine 13  
Function icons 11

### H

Halftone 18  
H-position 13

### I

Image lock 12  
Image effect 18  
Image size 17  
Information 13  
Installation CD 3

### K

Kensington security slot 4

### L

Language 18

### M

Manual Tune 15  
Menu 8  
MTS/S-Mode 20

### O

ON-Screen Display 11

OSD Lock/Unlock 10

OSD Control 18

### P

PAL-NTSC connector 3  
PAL Broadcasting System 29  
Pan 17  
Pin Assignments 27  
PIP 8, 14  
Plug and Play 6  
Power 8  
Power Indicator 6  
Power-saving modes 21  
Program 10

### R

Remote Controller 3, 19  
Reset 13

### S

S-VHS Cable 3  
Safety Instructions 2  
Scart Jack 3  
Screen controls 12  
Self-test feature check 6  
Sharpness 16  
Size 14  
Source 8, 17  
Speaker mute 17  
Stereo-RCA Cable 3  
Stereo System 15  
Store 16

### T

Tilt the screen 4  
Timer 18  
Treble 17  
Troubleshooting 22  
TV Setup 14

### U

User control locations 8  
User mode 14

### V

Video Control 16  
VOL 9  
Volume 10  
V-position 13

### Z

Zoom 17

## Regulatory Information

### FCC Information

#### User Instructions

The Federal Communications Commission Radio Frequency Interference Statement includes the following warning:

**Note:** This equipment has been tested and found to comply with the limits for a Class B digital device, pursuant to Part 15 of the FCC Rules. These limits are designed to provide reasonable protection against harmful interference in a residential installation. This equipment generates, uses, and can radiate radio frequency energy and, if not installed and used in accordance with the instructions, may cause harmful interference to radio communications. However, there is no guarantee that interference will not occur in a particular installation. If this equipment does cause harmful interference to radio or television receptions, which can be determined by turning the equipment off and on, the user is encouraged to try to correct the interference by one or more of the following measures:

- Reorient or relocate the receiving antenna.
- Increase the separation between the equipment and receiver.
- Connect the equipment into an outlet on a circuit different from that to which the receiver is connected.
- Consult the dealer or an experienced radio/TV technician for help.

#### User Information

Changes or modifications not expressly approved by the party responsible for compliance could void the user's authority to operate the equipment.

If necessary, consult your dealer or an experienced radio/television technician for additional suggestions. You may find the booklet called How to Identify and Resolve Radio/TV Interference Problems helpful. This booklet was prepared by the Federal Communications Commission. It is available from the U.S. Government Printing Office, Washington, DC 20402, Stock Number 004-000-00345-4.

#### Warning

User must use shielded signal interface cables to maintain FCC compliance for the product.

#### Declaration of conformity for products Marked with FCC Logo

This device complies with Part 15 of the FCC Rules. Operation is subject to the following two conditions: (1) this device may not cause harmful interference, and (2) this

device must accept any interference received, including interference that may cause undesired operation.

The party responsible for product compliance:

SAMSUNG ELECTRONICS CO., LTD

America QA Lab of Samsung

85 West Tasman Drive

San Jose, CA 95134 USA

Tel) 408-544-5124

Fax) 408-544-5191

Provided with this monitor is a detachable power supply cord with IEC320 style terminations. It may be suitable for connection to any UL Listed personal computer with similar configuration. Before making the connection, make sure the voltage rating of the computer convenience outlet is the same as the monitor and that the ampere rating of the computer convenience outlet is equal to or exceeds the monitor voltage rating.

For 120 Volt applications, use only UL Listed detachable power cord with NEMA configuration 5-15P type (parallel blades) plug cap. For 240 Volt applications use only UL Listed Detachable power supply cord with NEMA configuration 6-15P type (tandem blades) plug cap.

### IC Compliance Notice

This Class B digital apparatus meets all requirements of the Canadian Interference-Causing Equipment Regulations of ICES-003.

Cet appareil Numérique de classe B respecte toutes les exigences du Règlement ICES-003 sur les équipements produisant des interférences au Canada.

### MPR II Compliance

This monitor complies with SWEDAC(MPR II) recommendations for reduced electric and magnetic fields.

### European Notice

Products with the CE Marking comply with both the EMC Directive (89/336/EEC), (92/31/EEC), (93/68/EEC) and the Low Voltage Directive (73/23/EEC) issued by the Commission of the European Community.

Compliance with these directives implies conformity to the following European Norms:

- EN55022 (CISPR 22) – Radio Frequency Interference
- EN50082-1 : 1992 – Electromagnetic Immunity
- EN60555-2 (IEC555-2) – Power Line Harmonics
- EN60555-3 (IEC555-3) – Voltage Fluctuations
- EN60950 (IEC950) – Product Safety.

**U.S.A.:**

Samsung Electronics America (SEA)  
400 Valley Road, Suite 201  
Mt. Arlington, NJ 07856  
Tel.: 1-800-SAMSUNG (1-800-726-7864)

**CANADA:**

Samsung Electronics Canada Inc.  
7037 Financial Drive  
Mississauga, Ontario L5N 6R3  
Tel.: 1-800-SAMSUNG (1-800-726-7864)  
Fax.: (905) 542-1199

**GERMANY:**

Samsung Electronics GmbH  
Samsung-Haus, Am Kronberger Hang 6  
65824 Schwalbach/Ts.  
Tel. 49 (0180) 5121213 \*  
Fax. 49 (0180) 5121214 \*  
\*DM 0,24/Min.

**AUSTRALIA:**

Samsung Electronics Australia Pty Ltd.  
Unit G, 10-16 South Street,  
Rydalmere, N.S.W. 2116  
P.O. BOX 368  
Tel.: (02) 638 5200

**ITALIA:**

Samsung Electronics Italia SpA  
Via C. Donat Cattin,  
5-20063 Cernusco sul Naviglio (Mi)  
Tel.: 167-010740

**PANAMA:**

Servicios Samsung (Zona Libre), S.A.  
50 and 61 Streets Sta, Cecilia  
Bdl. Don Camilo, Panama City  
Tel.: (507) 264-0195 or 269-5571  
Fax: (507) 269-5568

**MEXICO:**

Samsung Electronics Mexico S.A. de C.V.  
Saturno 44 Col. Nva. Industrial Vallejo  
Del. Gustavo A. Madero C.P. 07700  
Mexico D.F. Tel. 5747-5100  
RFC: SEM950215S98

**ESPAÑA:**

Samsung Electrónica Comercial Ibérica, S.A. Ciencias, 55-  
65 (Poligono Pedrosa) 08908 Hospitalet de Llobregat  
(Barcelona)  
Tel.: (93) 261 67 00  
Fax.: (93) 261 67 50

**UK:**

Samsung Electronics (UK) Ltd.  
Samsung House, 225 Hook Rise South  
Surbiton, Surrey KT6 7LD  
Tel.: (0181) 391 0168  
Fax.: (0181) 397 9949  
<European Service Center & National Service>  
Stafford Park 12 Telford, Shropshire, TF3 3BJ  
Tel.: (01952) 292 262  
Fax.: (01952) 292 033

**THAILAND:**

Samsung Service Center  
729-729/1 JSP Tower Rachadapisek RD.,  
Bangpongpan, Yannawa, Bangkok 10120  
Tel: (662) 2954508-14  
Fax: (662) 2954267

**SOUTH AFRICA:**

Samsung Electronics South Africa  
Somerset Office Park 5 Libertas Road  
Bryanston, South Africa  
Tel: (27)-11-463-5678  
Fax: (27)-11-463-5215

**BRASIL:**

Samsung Eletrônica da Amazonia Ltda.  
R. Prof. Manoelito de Ornellas, 303-2º Andar  
Chácara Sto. Antônio • cep: 04719-040  
São Paulo • SP  
Tel.: (011) 541-8500  
Fax: (011) 523-3995, 522-0726

**SWEDEN:**

Samsung Electronics Svenska, AB  
Box 713, S-194 27 Upplands Vasby  
Tel: (468) 590-966-00  
Fax: (468) 590-966-50

IMPORTADO POR: SAMSUNG ELECTRONICS MEXICO S.A. DE C.V.  
SATURNO 44 COL. NVA. INDUSTRIAL VALLEJO  
DEL. GUSTAVO A. MADERO C.P. 07700  
MEXICO D.F. TEL. 5747-5100  
RFC: SEM950215S98  
EXPORTADO POR: SAMSUNG ELECTRONICS CO.,LTD.  
JOONG-ANG DAILY NEWS BLDG.  
7 SOON-WHA-DONG CHUNG-KU,  
C.P.O BOX 2775, 1144 SEOUL, KOREA



"As an ENERGYSTAR® Partner, SAMSUNG has determined that this product meets the ENERGYSTAR® guidelines for energy efficiency."

P/N : BN68-00123D-05



Printed on recyclable paper

## Free Manuals Download Website

<http://myh66.com>

<http://usermanuals.us>

<http://www.somanuals.com>

<http://www.4manuals.cc>

<http://www.manual-lib.com>

<http://www.404manual.com>

<http://www.luxmanual.com>

<http://aubethermostatmanual.com>

Golf course search by state

<http://golfingnear.com>

Email search by domain

<http://emailbydomain.com>

Auto manuals search

<http://auto.somanuals.com>

TV manuals search

<http://tv.somanuals.com>