



SyncMaster 151MP SyncMaster 171MP

(For NTSC systems)
TFT-LCD Monitor



**Owner's
Instructions**

For Better Display

1. Adjust computer resolution and screen injection rate (refresh rate) in control panel of computer as described below to enjoy the best quality of picture. You can have an uneven quality of picture in the screen if the best quality of picture is not provided in TFT-LCD.
 - Resolution: 15" 1024 x 768 • Vertical frequency (refresh rate): 60 Hz
 - 17" 1280 x 1024
2. TFT LCD panel manufactured by using advanced semiconductor technology with precision of 99.999% above is used for this product. But the pixels of RED, GREEN, BLUE and WHITE color seem to be bright sometimes or some of black pixels could be seen. This is not from bad quality and you can use it without uneasiness.
 - For example, the no. of TFT LCD pixels that is contained in this product are 2,359,296 (15"), 3,932,160 (17").
3. When you clean the monitor and the panel outside, please apply the recommended small amount of cleaner by using soft and dry cloth and polish it. Let LCD area not to be forced but to be scrubbed out softly. If excessive force is applied, you can have a stain on it.
4. If you are not satisfied with the quality of picture, you can get better quality of picture by executing "auto adjustment function" in display screen that is appeared as window termination button is pressed. If there's still noise after automatic adjustment, use FINE/COARSE adjustment function.

**Information in this document is subject to change without notice.
© 2001 Samsung Electronics Co., Ltd. All rights reserved.**

Reproduction in any manner whatsoever without the written permission of Samsung Electronics Co., Ltd. is strictly forbidden.

Samsung Electronics Co., Ltd. shall not be liable for errors contained herein or for incidental or consequential damages in connection with the furnishing, performance, or use of this material.



The *Samsung logo* and *SyncMaster* are registered trademarks of Samsung Electronics Co., Ltd.; *Microsoft*, *Windows*[®] and *Windows*[®] *NT* are registered trademarks of Microsoft Corporation; *VESA*, *DPMS* and *DDC* are registered trademarks of Video Electronics Standard Association; the *ENERGY STAR* name and logo are registered trademarks of the U.S. Environmental Protection Agency (EPA). As an ENERGY STAR Partner, Samsung Electronics Co., Ltd. has determined that this product meets the ENERGY STAR guidelines for energy efficiency. All other product names mentioned herein may be the trademarks or registered trademarks of their respective owners.

Table of Contents

Safety Instructions	2
Unpacking Your Monitor	3
Setting up Your LCD Monitor	4
Setting up an Ergonomic Workstation	4
Monitor Location	4
Workstation Height	4
Viewing Angle	4
Connecting Your LCD Monitor	5
Connecting TV Tuner Box (option)	6
Plug and Play	7
Installing the Video Driver	7
Self-Test Feature Check (STFC)	7
Getting Help	8
Warm-up Time	8
Adjusting Your LCD Monitor	9
User Controls	9
Automatic Save	10
Direct-Access Features	10
OSD Lock/Unlock	11
On Screen Display (OSD)	12
Accessing the Menu System	12
OSD Functions and Adjustments	13
PC Functions and Adjustments	14
TV/ Video Functions and Adjustments with the LNA (Low Noise Amplifier)	18
DTV Functions and Adjustments	23
Appendix	25
V-Chip	25
By Remote-Control	27
PowerSaver	29
Troubleshooting	30
Specifications	33
Pin Assignments	35
Display Modes	36
Attaching a Wall or Arm Mounting Device	37
Installing VESA Compliant Mounting Devices	38
Wall Mount Instructions	38
Retractable Stand	39
Maintenance of Your LCD Monitor	39
Index	40
Regulatory Information	Inside back cover
Customer Service / Technical Support	Back cover

Safety Instructions

- 1** Before connecting the AC power cord to the DC adapter outlet, make sure the voltage designation of the DC adapter corresponds to the local electrical supply.
- 2** Never insert anything metallic into the cabinet openings of the liquid crystal display (LCD) monitor; doing so may create the danger of electric shock.
- 3** To avoid electric shock, never touch the inside of the LCD monitor. Only a qualified technician should open the case of the LCD monitor.
- 4** Never use your LCD monitor if the power cord has been damaged. Do not allow anything to rest on the power cord, and keep the cord away from areas where people can trip over it.
- 5** Be sure to hold the plug, not the cord, when disconnecting the LCD monitor from an electric socket.
- 6** Openings in the LCD monitor cabinet are provided for ventilation. To prevent overheating, these openings should not be blocked or covered. Also, avoid using the LCD monitor on a bed, sofa, rug, or other soft surface. Doing so may block the ventilation openings in the bottom of the cabinet. If you put the LCD monitor in a bookcase or some other enclosed space, be sure to provide adequate ventilation.
- 7** Put your LCD monitor in a location with low humidity and a minimum of dust.
- 8** Do not expose the LCD monitor to rain or use it near water (in kitchens, near swimming pools, etc.). If the LCD monitor accidentally gets wet, unplug it and contact an authorized dealer immediately. You can clean the LCD monitor with a damp cloth when necessary, but be sure to unplug the LCD monitor first.
- 9** Place the LCD monitor on a solid surface and treat it carefully. The screen is made of thin glass with a plastic front surface and can be damaged if dropped, hit or scratched. Do not clean the front panel with keton-type materials (e.g., acetone), ethyl alcohol, toluene, ethyl acid, methyl, or chloride – these may damage the panel.
- 10** Locate your LCD monitor near an easily accessible AC outlet.
- 11** If your LCD monitor does not operate normally – in particular, if there are any unusual sounds or smells coming from it – unplug it immediately and contact an authorized dealer or service center.
- 12** High temperature can cause problems. Don't use your LCD monitor in direct sunlight, and keep it away from heaters, stoves, fireplaces, and other sources of heat.
- 13** Unplug the LCD monitor when it is going to be left unused for an extended period of time.
- 14** Unplug your LCD monitor from the AC outlet before any service.

	CAUTION RISK OF ELECTRIC SHOCK DO NOT OPEN	
CAUTION: TO REDUCE THE RISK OF ELECTRIC SHOCK, DO NOT REMOVE COVER (OR BACK). NO USER-SERVICEABLE PARTS INSIDE. REFER SERVICING TO QUALIFIED SERVICE PERSONNEL.		

Unpacking Your Monitor

Please make sure the following items are included with your monitor. If any items are missing, contact your dealer.



Installation CD
(Not available in all locations)



Monitor

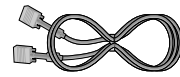

15-pin D-Sub Signal Cable



DC Adapter



Warranty Card
(Not available in all locations)



Remote Controller



Stereo Audio Cable



Manual

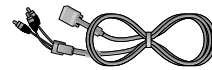

RCA DTV Cable
(option)



Power Cord



Batteries
(AAA x 2)



Tuner Box
(option)

Setting up Your LCD Monitor

Setting up an Ergonomic Workstation

Consider the advice given below before you install your monitor.

Monitor location

Choose a position that exposes your monitor to the least reflection from lights or windows, usually at a right angle to any window.

Workstation height

Place your LCD monitor so that the top of the screen is slightly below your eye level when you are comfortably seated.

Viewing angle

Tilt the screen until you feel comfortable working with your monitor.



Figure 1. Tilt the screen

Setting up Your LCD Monitor

Connecting Your LCD Monitor

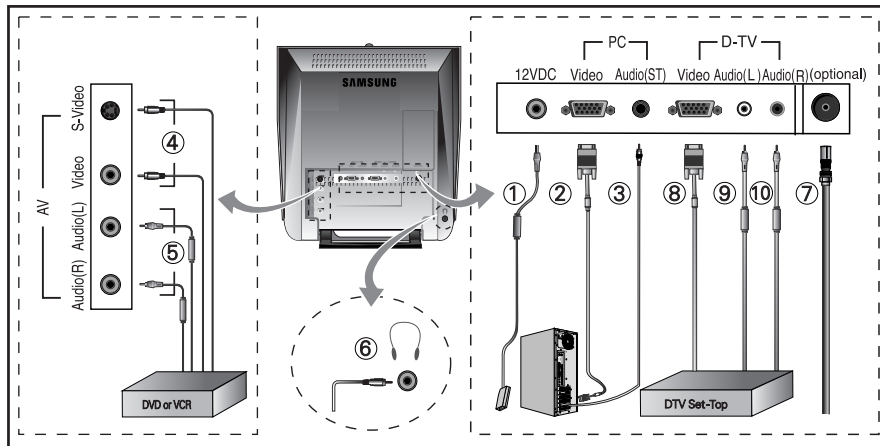

Figure 2. Cable connections

1. Connecting Computer (① ② ③)

- Connect the power cord to the DC Adaptor and connect the adaptor jack to the DC 12V power connector on the back of the monitor.
- Connect the 15-pin D-SUB of the video signal cable to the PC video connector on the back of the monitor.
- Connect the stereo audio cable to "Audio (ST)" on the back of the monitor and the other end to "Audio Out" terminal of the sound card on your computer.
- If necessary, please install monitor driver contained on the accompanied CD. For driver installation, please refer "Installing Video Driver" section on page 7.

2. Connecting External A/V Devices (④ ⑤)

- Connect RCA (Yellow) or S-VHS cable to an appropriate external A/V device such as VCR, DVD or camcorder. (RCA cable and S-VHS cable not included)
- Connect RCA audio cables to "Audio (R)" and "Audio (L)" terminals and the other ends to corresponding audio out terminals on the A/V device. (Stereo-RCA cable not included)
- Headphone may be connected to the headphone output on the left-hand side of the monitor marked (⑥). **While the headphone is connected, the sound from the built-in speakers will be disabled.**

3. Connecting TV/CATV (⑦)

- Connect an antenna or CATV cable to the antenna terminal on the back of the monitor.
 - ☞ Optional TV tuner is required. The optional TV tuner can be purchased from the local Samsung Monitor dealers.

4. Connecting DTV Set-Top Box (⑧ ⑨ ⑩)

- Connect the RCA DTV Cable to the Video port of the DTV Function on the back of the monitor.
- Connect the RCA Cable to "Audio(L)" and "Audio(R)" on the back of the monitor and the other end to "Audio Out" terminal of the Set-Top Box.

Setting up Your LCD Monitor

Connecting TV Tuner Box (option)

- 1 Unplug the DC adapter.
- 2 Remove cover of tuner box housing by sliding down.
- 3 Connect antenna or CATV cable to "Antenna" port of the tuner box.

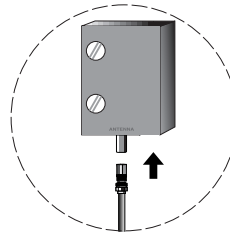

- 4 Insert the tuner box into tuner box housing on the back of the monitor. Please use a coin or screwdriver to tighten the two screws to fix the tuner.

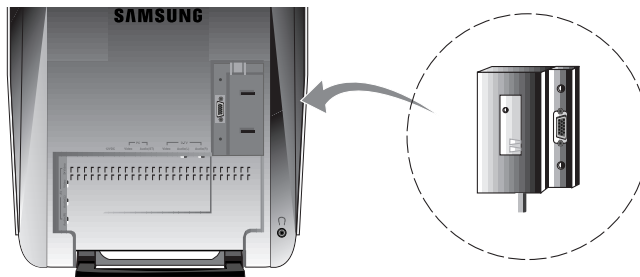

- 5 Put the tuner box housing cover back on.

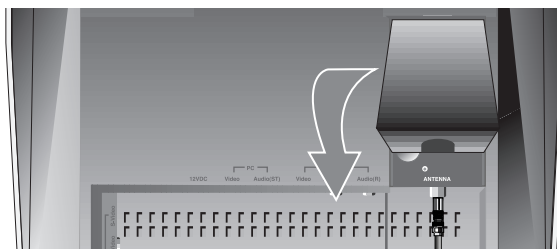

- 6 Connect the power cord of DC adapter then the monitor will be ready for TV function.

Setting up Your LCD Monitor

Plug and Play

The adoption of the new **VESA®** Plug and Play solution eliminates complicated and time consuming setup. It allows you to install your monitor in a Plug and Play compatible system without the usual hassles and confusion. Your PC system can easily identify and configure itself for use with your display. This monitor automatically tells the PC system its Extended Display Identification Data (EDID) using Display Data Channel (DDC) protocols so the PC system can automatically configure itself to use the flat panel display. If your PC system needs a video driver, follow the instructions given below according to the operating system your computer uses.

Installing the Video Driver

The CD that accompanies this product contains the necessary drivers for installing your monitor. Please refer to the driver installation instructions included with your CD package for more information.

Self-Test Feature Check (STFC)

Your monitor provides a self-test feature that allows you to check whether your monitor is functioning properly. Make sure that PC is selected as a primary source by checking if the source indicator LED labeled "PC" is on. If your monitor and computer are properly connected but the monitor screen remains dark and the power indicator is blinking, run the monitor self-test by following the steps given below:



Figure 3. Power Indicator

- 1** Turn off both your computer and the monitor.
- 2** Unplug the video cable from the back of the computer.
- 3** Turn on the monitor.

Setting up Your LCD Monitor

If the monitor is functioning properly, you will see a white box with a large blue oval Samsung logo and an error message "Check Signal Cable." in red color.

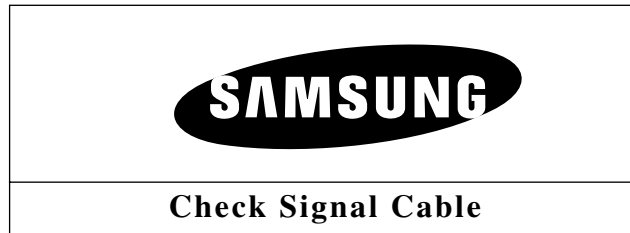

Figure 4. Monitor self-test screen

This box also appears during normal operation if the video cable becomes disconnected or damaged.

- 4 Turn off your monitor and reconnect the video cable; then turn on both your computer and the monitor.

If your monitor screen remains blank after following the previous procedure, check your video controller and computer system; your monitor is functioning properly.

Getting Help

If your monitor does not display an image, check your cable connections and refer to "Troubleshooting" on page 30. If you experience difficulties with the quality of the displayed image, push Auto Button (see page 9) and refer to "Adjusting Your LCD Monitor" on page 9 or "Troubleshooting" on page 30.

Warm-up Time

All LCD monitors need time to become thermally stable whenever you turn on the monitor after letting the monitor be turned off for a couple of hours. Therefore, to achieve more accurate adjustments for parameters, allow the LCD monitor to warm (be on) for at least 20 minutes before making any screen adjustments.

Adjusting Your LCD Monitor

User Controls

Your LCD monitor allows you to easily adjust the characteristics of the image being displayed. All of these adjustments are made using the control buttons on the front of the monitor. While you use these buttons to adjust the controls, an OSD shows you their numeric values as they change.

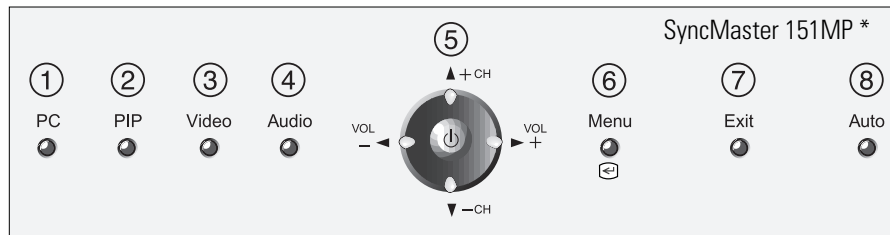

* 17" : SyncMaster 171MP

Figure 5. User control locations

No.	Name	Description
1	PC	<ul style="list-style-type: none"> ■ Selects PC source. ■ PIP window off.
2	PIP	<ul style="list-style-type: none"> ■ Activates PIP(Picture-in-Picture) window directly in PC mode. ■ Selects video sources (Video/S-video/TV).
3	Video	<ul style="list-style-type: none"> ■ Activates full screen video window. ■ Selects video sources (Video/S-video/TV).
4	Audio	<ul style="list-style-type: none"> ■ Selects audio source (PC/Video/TV).
5	Power	<ul style="list-style-type: none"> ■ Turns ON/OFF the monitor. ■ Indicates the status of the monitor. <ul style="list-style-type: none"> - Green : Normal Operation. - Amber : Power Saving Mode or Disconnected Signal Cable.
	▼ ▲ - CH +	<ul style="list-style-type: none"> ■ Moves the selector up or down on the OSD. ■ Increases or decreases the channel number.
	◀ ▶ - VOL +	<ul style="list-style-type: none"> ■ Moves the selector left or right on the OSD. ■ Increases or decreases the values of the selected function. ■ Increases or decreases the level of audio volume.

Adjusting Your LCD Monitor

No.	Name	Description
6	Menu 	<ul style="list-style-type: none"> Opens the OSD and selects the highlighted function.
7	Exit	<ul style="list-style-type: none"> Exits from menus and sub-menus. Exits from the OSD system.
8	Auto	<ul style="list-style-type: none"> "Auto" allows the monitor to self-adjust to the incoming video signal. The values of fine, coarse and position are adjusted automatically.

Automatic Save

Whenever you open the OSD and allow an adjustment window to remain active for about 3 seconds without pressing other buttons, the monitor automatically saves any adjustment you have made. These changes are saved into a user area in the monitor.

The monitor can save adjustments for up to 5 user modes. It has 9 for 151MP (11 for 171MP) factory preset or preload modes, one for each signal frequency as listed in table 7 on page 36. If you have made no adjustments, the OSD disappears and the monitor does not save anything.

Direct-Access Features

While you are watching full screen TV or in PIP mode

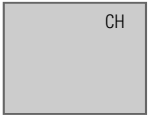
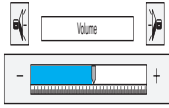
Program		<p>Valid only after performing "Channel auto program". When OSD is not on the screen, push the "▼" or "▲" button to select program channel number.</p> <ol style="list-style-type: none"> Push the "▼" button to decrease channel number. Push the "▲" button to increase the channel number.
Volume		<p>When OSD is not on the screen, push the "◀" or "▶" button to adjust volume.</p> <ol style="list-style-type: none"> Push the "◀" button to decrease the volume. Push the "▶" button to increase the volume.

Adjusting Your LCD Monitor

OSD Lock/Unlock

While OSD window is not on, push and then hold Menu button for about 5 seconds to Lock or Unlock OSD menus. When OSD menus are locked, all OSD menus are disabled and colored in gray to indicate that those functions are not accessible but the following functions:

1. PC
 - Brightness
 - Contrast
2. TV
 - Channel
 - Volume
3. Control buttons
 - Direct access keys: PC, PIP, Video, Audio, Channel, Volume, Menu, Exit, Auto
4. Remote Controller
 - All direct access keys on the remote controller

Initial OSD icons

Depending on the configuration of the monitor, the appearance of OSD is different.

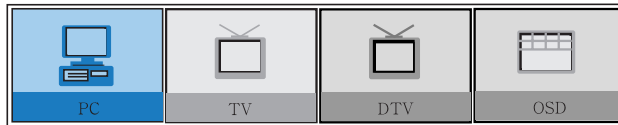

Fig. 6. With Optional TV Tuner

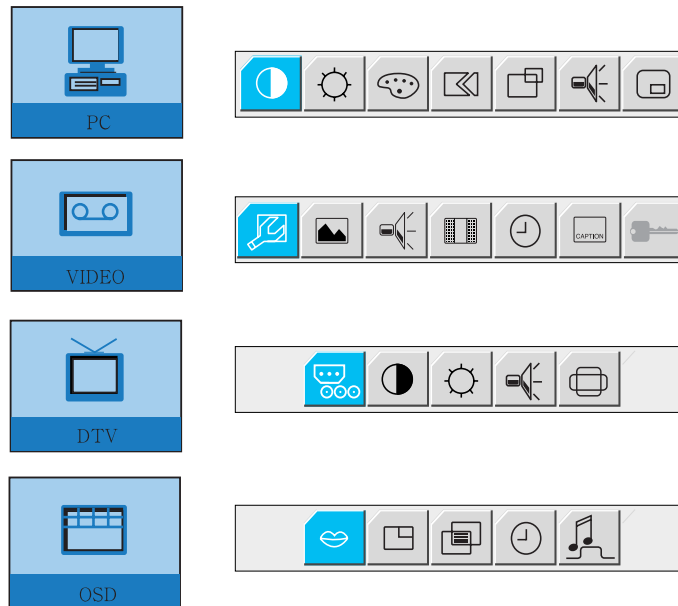

Fig. 7. Without Optional TV Tuner

- ⇒ The optional TV tuner can be purchased from the local Samsung Monitor dealers. Some OSD menus are disabled in gray color when they are not available in a certain mode of operation. Those menus are enabled when corresponding OSD menus are activated.

Adjusting Your LCD Monitor

On Screen Display (OSD)



Accessing the menu system

- 1** With the OSD off, push the **Menu** button to display the main OSD menu.
- 2** Use the "▼▲◀▶" buttons to move from one function to another. As you move from one icon to another, the function name changes to reflect the function or group of functions represented by that icon. See Table 1 starting on the next page to view a complete list of all of the functions available for the monitor.
- 3** Press the **Menu** button once to activate the highlighted function, then follow the Tool Tips to select the function and adjust the value.
- 4** Use "▲" and "▼" buttons to select the sub-menu, and press the **Menu** button once to activate the selected sub-menu.
- 5** After selecting a function, use the "◀" and "▶" buttons to make necessary adjustments. The setting bar moves and the numeric value indicator changes to reflect your adjustments.

NOTE: The numeric value indicator is provided as a point of reference only and has nothing to do with a real measurement.

- 6** Push the **Exit** button a couple of times to return to the main menu to select another function or to exit from the OSD.

Adjusting Your LCD Monitor

OSD functions and adjustments

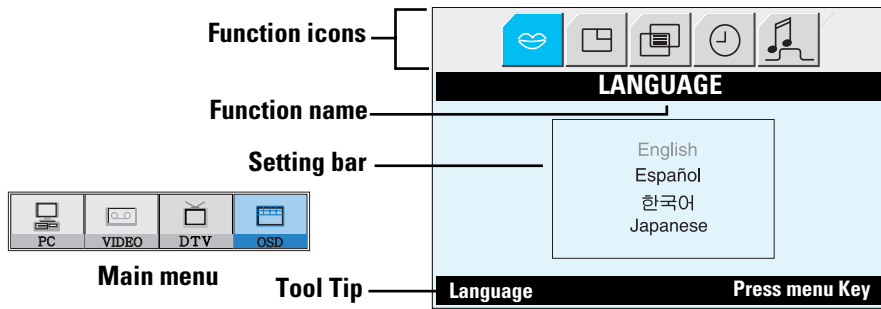







Table 1. Screen controls

Main Menu	Icon	Menus and Sub-menus	Function Descriptions	
			◀ ▶	
		LANGUAGE	OSD language and appearance can be changed. English Español 한국어 Japanese	
			POSITION	Move the OSD Window to the vertical and horizontal direction.
			HALFTONE	Change the opaqueness of the background of the OSD.
			DURATION	The number of seconds that the OSD will remain visible before disappearing.
			BEEP	Enables or Disables the sound generated when you touch the control buttons.

Adjusting Your LCD Monitor

PC functions and adjustments

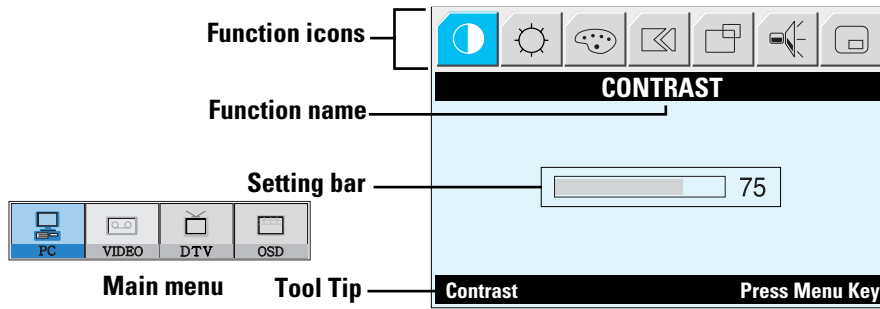

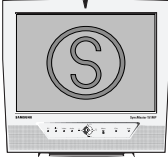
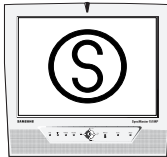
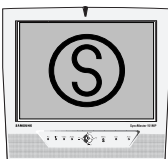
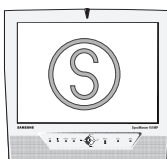

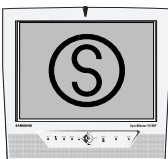
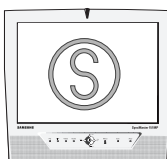



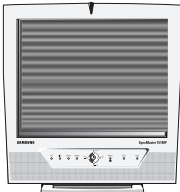

Table 1. Screen controls (Continued)

Main Menu	Icon	Menus and Sub-menus	Function Descriptions	
			◀	▶
		CONTRAST		
				
		BRIGHTNESS		
		COLOR	The tone of color can be changed from redish white to bluish white. The individual color components are also user customizable.	
		■ Mode1	Redish white.	
		■ Mode2	Plain white.	
		■ Mode3	Bluish white.	
■ User Mode	User customizable.			



Adjusting Your LCD Monitor

Table 1. Screen controls (Continued)

Main Menu	Icon	Menus and Sub-menus	Function Descriptions	
			◀	▶
		■ Reset	Color parameters are replaced with the factory default values.	
		IMAGE	Image Lock is used to fine tune and get the best image by removing noises that create unstable images with jitters and shimmers.	
		IMAGE LOCK		
		■ Coarse ■ Fine	The Coarse and Fine adjustments allow you to fine tune the image quality of your monitor to your preference. Use the "◀" and "▶" buttons to remove any noise. If satisfactory results are not obtained using the Fine adjustment, use the Coarse adjustment and then use Fine again. This function may change the width of the image. Use the H-Position menu to center the image on the screen.	
			When Coarse value is wrong.	When Fine value is wrong.
				
■ Information	Display current display mode.			
■ Reset	Image lock and position parameters are replaced with the factory default values.			







Adjusting Your LCD Monitor

Table 1. Screen controls (Continued)

Main Menu	Icon	Menus and Sub-menus	Function Descriptions
			◀ ▶
 PC		IMAGE SIZE	The size of the image being displayed can be handled in several different ways.
		■ Expand1	Resize the image to fill the whole screen. (applicable to PC RGB only)
		■ Expand2	Expand images keeping the original aspect ratio. (applicable to PC RGB only)
		■ Normal	Display the incoming image as it is. (applicable to PC RGB only)
		■ Zoom	The image can be magnified up to 64 times larger than the original image. The enlarged image can also be panned.
		■ Pan	Move the zoomed image horizontally and vertically.
		IMAGE EFFECT	Image being displayed can be made softer or sharper. <ul style="list-style-type: none"> • Sharpen more • Sharpen • Medium • Soften • Soften more

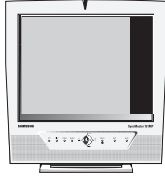
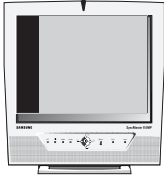
Adjusting Your LCD Monitor

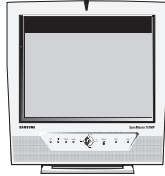
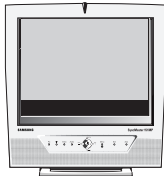
Table 1. Screen controls (Continued)

Main Menu	Icon	Menus and Sub-menus	Function Descriptions	
			◀	▶
		H-POSITION 		
		V-POSITION 		
		SOUND	The monitor has a built-in high fidelity stereo audio amplifier. The audio circuit processes audio signal from various external input sources such as DVD, VCR, TV, or PC.	
		<input type="checkbox"/> Bass	Bass: Emphasize low frequency audio.	
		<input type="checkbox"/> Treble	Treble: Emphasize high frequency audio.	
		<input type="checkbox"/> Surround	On, Off	
		PIP (Picture-in-Picture)	When external A/V devices such as VCR, DVD or RF(TV)cable are connected to the monitor, PIP allows you to watch video from such devices in a small window super-imposed on pc video signal.	
		<input type="checkbox"/> Size	Resize PIP window.	
		<input type="checkbox"/> Position	Change PIP window position.	

Adjusting Your LCD Monitor

TV/ Video functions and adjustments with the LNA (Low Noise Amplifier)

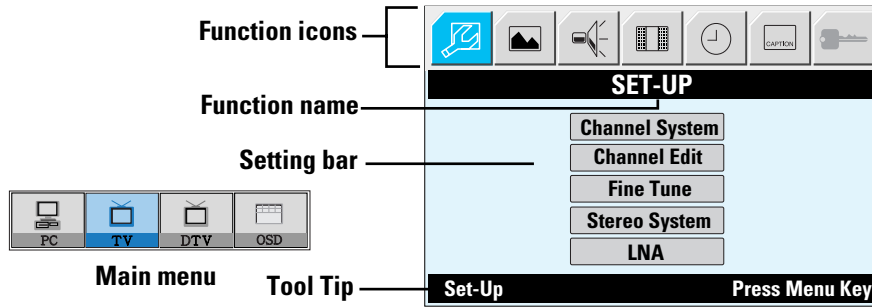

Table 1. Screen controls (Continued)



Main Menu	Icon	Menus and Sub-menus	Function Descriptions
			◀ ▶
		SET-UP	The channel system can be set in several different ways.
		<ul style="list-style-type: none"> ■ *Channel system 	Select a channel system that is being used in your region. (See "NTSC broadcasting systems" on page 36) <ul style="list-style-type: none"> • US-Air • US-Cable • Japan-Air • Japan-Cable Upon selecting a channel system, you will be asked if you want to perform "Channel auto program". Select "OK" to perform the "Channel auto program" or select "Cancel" to select different channel system. (See page 22 for "Channel auto program".)

* It takes 8 minutes in average to scan 70 channels. The amount of time to finish channel scanning is completely depending on the number of channels available in your region.

* TV menu () is available only after the installation of TV tuner.
 Before installing the TV tuner, Menus are all in gray color and navigation is disabled as well.



Adjusting Your LCD Monitor

Table 1. Screen controls (Continued)

Main Menu	Icon	Menus and Sub-menus	Function Descriptions
		<ul style="list-style-type: none"> ■ Channel Edit 	<p>In rare cases, "Channel auto program" may miss a couple of channels due to weak signals or for other reasons such as a channel does not exist when "Channel auto program" is executed. To add a newly found channel or remove a channel, please follow the steps described below.</p> <ul style="list-style-type: none"> • Push Menu button and then select "Channel Edit" under "TV Setup" menu. • Select "Add" to add the channel or select "Erase" to remove the channel.
		<ul style="list-style-type: none"> ■ Fine Tune 	<p>Due to weak signals or a wrong antenna configuration, some of the channels may not be tuned correctly. Select "Fine Tune" under TV Setup menu to make the video image as clear as possible.</p> <ul style="list-style-type: none"> • Use "◀ ▶" to fine tune the quality of video images when you satisfy with the setting, press "▼" to highlight "Save" or "Cancel" menu. • Select "Save" to save or "Cancel" to cancel the setting.
		<ul style="list-style-type: none"> ■ Stereo System 	<p>Due to the various encoding schemes, the audio system corresponding to the channel system must be selected manually. Currently, there are three stereo audio systems in NTSC system: A2, BTSC and EIAJ. Please select the stereo audio system that is applicable to your region.</p> <ul style="list-style-type: none"> • A2: Korea • BTSC: Most regions using NTSC System including USA, Canada, Chile, Venezuela, and Taiwan • EIAJ: Japan (See "NTSC broadcasting systems" on page 36) <p><i>NOTE:</i> <i>BTSC: Broadcast Television System Committee.</i> <i>EIAJ: Electronic Industries Association of Japan.</i></p>







Adjusting Your LCD Monitor

Table 1. Screen controls (Continued)

Main Menu	Icon	Menus and Sub-menus	Function Descriptions ◀ ▶
		<ul style="list-style-type: none"> ■ LNA 	<p>This function is provided to amplify signal automatically in case of bad reception sensitivity of antenna.</p> <p>But if mis-operation is experienced due to interference with the received signal, please shutdown the LNA(Low Noise Amplifier).</p>





Adjusting Your LCD Monitor

Table 1. Screen controls (Continued)

Main Menu	Icon	Menus and Sub-menus	Function Descriptions ◀ ▶
 		PICTURE	This function is active if you select an input source other than PC.(DVD,VCR,TV)
		■ Contrast	Adjust the contrast of video or TV without affecting PC RGB's contrast.
		■ Brightness	Adjust the brightness of video or TV without affecting PC RGB's brightness.
		■ Sharpness	Adjust the sharpness of video or TV image.
		■ Color	Change the richness of color.
		■ Tint	Change the tone of color.
		■ Reset	Picture parameters are replaced with the factory default values.
		SOUND	The monitor has a built-in high fidelity stereo audio amplifier. The audio circuit processes audio signal from various external input sources such as DVD, VCR, TV, or PC.
		■ Bass	Bass: Emphasize low frequency audio.
		■ Treble	Treble: Emphasize high frequency audio.
		■ Surround	On, Off
		ACTIVE AREA	The Active Area of the image being displayed can be handled in Narrow and Wide. This function is not working in PIP.
		Narrow	Wide
			

Adjusting Your LCD Monitor

Table 1. Screen controls (Continued)

Main Menu	Icon	Menus and Sub-menus	Function Descriptions
			◀ ▶
 TV  VIDEO		TIMER	The monitor system will turn off automatically if one of three time intervals is selected. Off. 30 min. 60 min. 120 min.
		Closed Caption (US only)	Enable or disable closed caption feature and set the appearance of closed caption text. <ul style="list-style-type: none"> • On/Off • Caption/Text • Channel 1/2 • Field 1/2 • Box/Shadow
		V- Chip	See " V- Chip " on page 25 ~ 26. NOTE: If you forgot V-Chip Password <ul style="list-style-type: none"> • Press and hold the "Audio" button on the front of the monitor for 10 seconds. The screen will blink once as the password is reset to the original state. • The initial password of V-Chip is '0000'.

* According to our R&D Lab test result, "Channel auto program" usually takes around 3 minutes to scan 61 channels. The scanning can be longer or shorter depending on the number of channels and the video source whether the video source is from cable or air.

*Upon completion of "Channel auto program", the result of the channel search is stored in designated internal memory. Each found channel is indexed into that memory and the channel indices are used as a look up table. In other words, when a user changes the channel, the monitor refers to the look up table to find the appropriate channel frequency instead of performing physical frequency scanning which gives a lot slower tuning result. In rare cases, "Channel auto program" may miss a channel due to weak signals or for other reasons. To add a channel, please enter the channel number by using the numeric key pads on the remote controller, then use "Fine Tune" menu in the "TV Setup" menu from OSD. When you finish fine tuning the channel you want to add, select "Save".

Adjusting Your LCD Monitor

DTV functions and adjustments

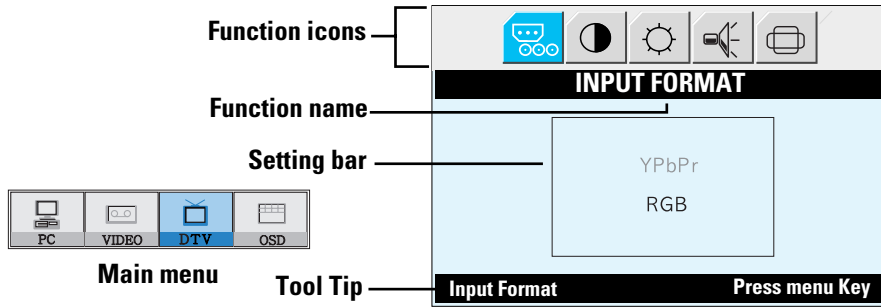





Table 1. Screen controls (Continued)

Main Menu	Icon	Menus and Sub-menus	Function Descriptions
			◀ ▶
		INPUT FORMAT	Select DTV input type. <ul style="list-style-type: none"> • YPbPr • RGB <i>NOTE: If the input type is different, the monitor doesn't display.</i>
		CONTRAST	Adjust the contrast of DTV without affecting PC RGB's contrast.
		BRIGHTNESS	Adjust the brightness of DTV without affecting PC RGB's brightness.
		SOUND	The monitor has a built-in high fidelity stereo audio amplifier. The audio circuit processes audio signal from various external input sources such as DVD, VCR, TV, or PC.
		■ Bass	Bass: Emphasize low frequency audio.
		■ Treble	Treble: Emphasize high frequency audio.
		■ Surround	On, Off

Adjusting Your LCD Monitor

Table 1. Screen controls (Continued)

Main Menu	Icon	Menus and Sub-menus	Function Descriptions	
			◀	▶
		SCREEN SIZE	Select DTV size. <ul style="list-style-type: none"> • 16 : 9 • Full 	
				
			16 : 9	Full

Appendix

V - Chip (US only)

The Telecommunications Act of 1996 in USA requires that every television made, starting in 1998, must be equipped with the technological device named V - Chip. The V - Chip can block certain rated television shows off television (if chosen) so children cannot watch programs that their parents do not approve. With this device, program-rating information will be transmitted along with the television signal, and be decoded by the chip in each television. The chip will then compare the rating codes to values preset by the viewer, which is meant to be the parents. If the rating codes are higher than the preset values, the television signal will be blocked, and a blank screen will be displayed.

SyncMaster 151MP/171MP have this feature and you can adjust the V - Chip setting via OSD. Use arrow keys on the remote controller or control buttons on the front cabinet of the monitor to change the setting.

1. Select V - Chip on OSD, then enter 4 digits of pin number.
 - Initial pin number is "0000"
 - If you enter an incorrect pin number "Incorrect" message will be displayed for 3 seconds.
2. Use arrow keys to change or to activate the highlighted function.
3. Setting up **TV Guidelines**
 - Use Up/Down/Left/Right arrow buttons to move around the matrix and press **Menu** button to change the value from "U" to "B" or "B" to "U"
 - **U** : Unblock **B** : Block

	All	FV	V	S	L	D
TV-Y	B					
TV-Y7	B	B				
TV-G	U					
TV-PG	U		U	U	U	U
TV-14	U		U	U	U	
TV-MA	U		U	U	U	
TV-Y : Young Children TV-Y7 : Children 7 and over TV-G : General Audience TV-PG : Parent Guidance TV-14 : Viewers 14 and over TV-MA : Mature audience			FV : Fantasy Violence V : Violence S : Sexual Situation L : Coarse Language D : Suggestive Dialog			



Appendix

4. Setting up MPAA rating Mode

- Use Up/Down/Left/Right arrow buttons to move around the matrix and press **Menu** button to change the value from "U" to "B" or "B" to "U".
- MPAA : Motion Picture Association (of) America [movie rating organization]

G	U	General Guidance
PG	U	Parental Guidance Suggested
PG-13	U	Parents Strongly Cautioned
R	U	Restricted Under 17 Requires
NC-17	U	No Children Under 17 Admitted
X	U	Adult Only
NR	U	Not Rated

5. Entering a new pin number

- Use numeric keys enter a new pin number. Pin number confirm menu appears.
- Again, use numeric keys to enter the pin number you entered at the previous step. If the two pin numbers do not match, "Incorrect" message will be displayed for 3 seconds.

6. Blocking Screen

- If the incoming signal's rating is higher than the one specified, the screen will be blanked and "Excessive rating" message will be appeared.

*NOTE: When the screen is blocked by V-Chip, and if you forget the password of the V-Chip setting, press the **AUDIO** button in 10 second on the front cabinet of the monitor and it returns the '0000' default value.*

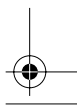
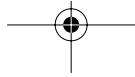
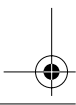
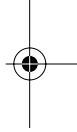
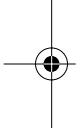

Appendix

By Remote-Control

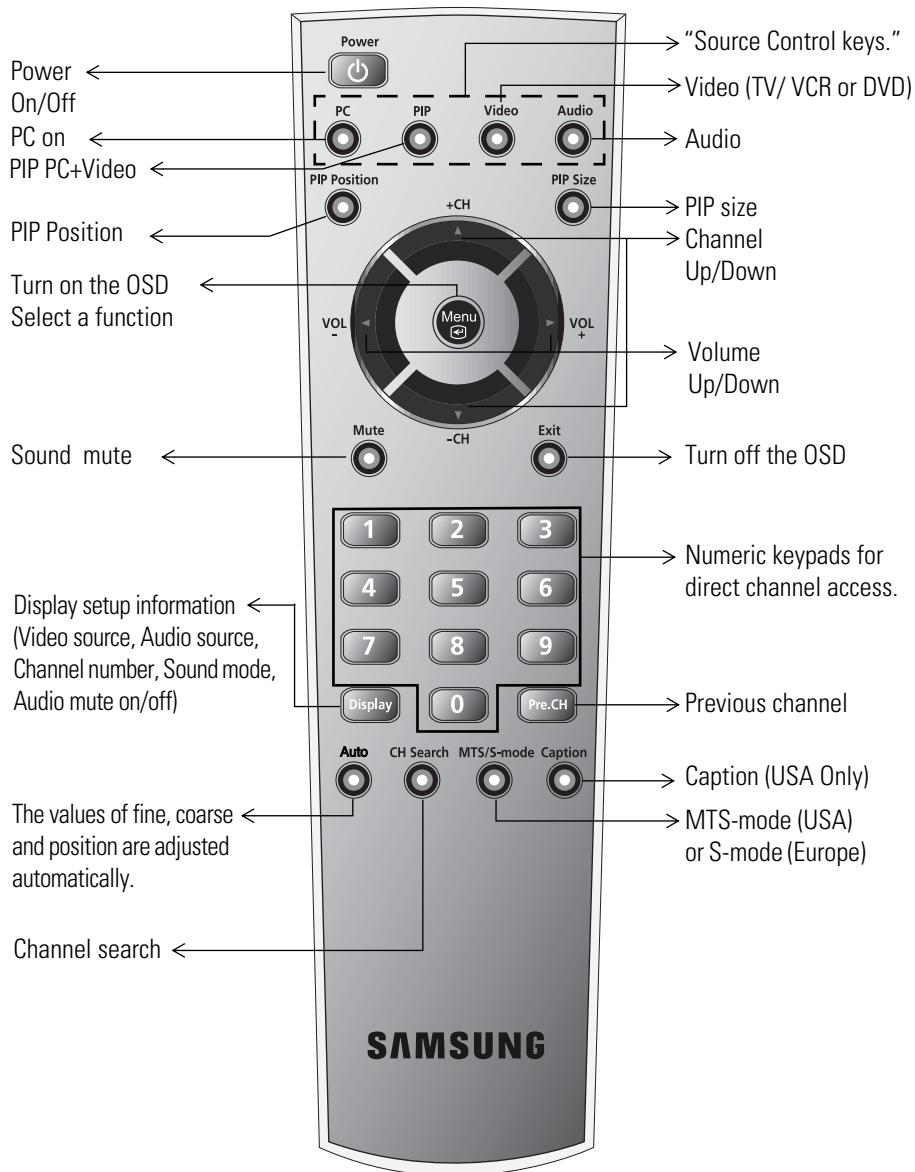



Appendix

■ Features that can only be accessed via remote controller

Display	<p>Shows a selected video source, audio source, current channel number, sound mode and the state of audio mute on the upper right corner of the screen.</p> <div data-bbox="778 656 978 786" style="border: 1px solid black; padding: 5px; margin: 10px auto; width: fit-content;"> <ul style="list-style-type: none"> • Video Source: _ • Audio Source: _ • CH/Mono • Sound Mute: off </div>
MTS/S-Mode	<p>You can set the audio mode by using this button. When you press this button, current sound mode is displayed on the lower left corner of the screen.</p> <div data-bbox="778 940 978 1066" style="border: 1px solid black; padding: 5px; margin: 10px auto; width: fit-content;"> <p style="text-align: center;">Stereo</p> </div> <p><i>Note: SyncMaster151MP/171MP have an automatic stereo detection feature. Thus, depending on the types of audio, the monitor automatically changes its audio mode from Mono to Stereo or vice versa.</i></p>

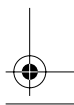
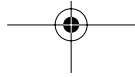
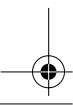
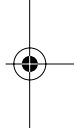
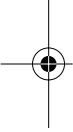

Appendix

PowerSaver

This monitor has a built-in power management system called PowerSaver. This system saves energy by switching your monitor into a low-power mode when it has not been used for a certain period of time. The available modes are "On", "Standby", "Sleep", and "Deep Sleep". PowerSaver operates with a VESA DPMS compliant video card installed in your computer. You use a software utility installed on your computer to set up this feature. See Table 2 below for details.

Table 2. Power-saving modes

State	Normal Operation	Power-Saving Function mode (EPA/ NUTEK/ ENERGY2000)		
		Standby Mode	Sleep Mode Position A1	Deep Sleep Mode Position A2
Horizontal Sync Vertical Sync	Active Active	Inactive Active	Active Inactive	Inactive Inactive
Power Indicator	Green	Amber	Amber Blinking (0.5 sec interval)	Amber Blinking (1 sec interval)
Power Consumption	151MP : 40W (Max.) 171MP : 52W (Max.)	Less than 3W	Less than 3W	Less than 3W

NOTE: This monitor automatically returns to normal operation when horizontal and vertical sync return. This occurs when you move the computer's mouse or press a key on the keyboard.

This monitor is EPA ENERGY STAR[®] compliant and NUTEK/ENERGY2000 compliant when used with a computer equipped with VESA DPMS functionality.

For energy conservation, turn your monitor OFF when you are not using it or when leaving it unattended for long periods.

Appendix

Troubleshooting

If you have a problem setting up or using your LCD monitor, you may be able to solve it yourself. Before contacting customer service, try the suggested actions that are appropriate to your problem.

Table 3. Troubleshooting – Image

What you see...	Suggested Actions	Reference
Screen is black and power indicator is off	<ul style="list-style-type: none"> ■ Ensure that the power cord is firmly connected and the LCD monitor is on. 	Connecting your LCD monitor, page 5.
“ Check Signal Cable” message	<ul style="list-style-type: none"> ■ Ensure that the signal cable is firmly connected to the PC or video sources. ■ Ensure that the PC or video sources are turned on. 	Connecting your LCD monitor, page 5.
“Sync. Out of Range” message	<ul style="list-style-type: none"> ■ Check the maximum resolution and the frequency of the video adaptor. ■ Compare these values with the data in the Display Modes Timing Chart. 	Display Modes, page 36.
The image is too light or too dark	<ul style="list-style-type: none"> ■ Adjust the Brightness and Contrast. 	Brightness, page 14. Contrast, page 14.
Horizontal bars appear to flicker, jitter or shimmer on the image	<ul style="list-style-type: none"> ■ Adjust the Fine function. 	Image Lock, Fine, page 15.
Vertical bars appear to flicker, jitter or shimmer on the image.	<ul style="list-style-type: none"> ■ Adjust the Coarse function and then adjust the Fine function. 	Image Lock, Coarse, page 15. Image Lock, Fine, page 15.

Appendix

Table 3. Troubleshooting – Image (Continued)

What you see...	Suggested Actions	Reference
Screen is black and power indicator light is steady amber or blinks every 0.5 or 1 seconds	<ul style="list-style-type: none"> ■ The monitor is using its power management system. ■ Move the computer's mouse or press a key on the keyboard 	Power Saver, page 29.
Image is not stable and may appear to vibrate	<ul style="list-style-type: none"> ■ Check that the display resolution and frequency from your PC or video board is an available mode for your monitor. On your computer check: Control Panel, Display, Settings 	Display Modes, page 36.
	<ul style="list-style-type: none"> ■ If the setting is not correct, use your computer utility program to change the display settings. 	Installing the Video Driver, page 7.
	<i>NOTE: Your monitor supports multiscan display functions within the following frequency domain:</i>	
	<ul style="list-style-type: none"> ■ Horizontal frequency: ■ Vertical frequency: ■ Maximum refresh rate: 	151MP : 30 kHz ~ 69 kHz 171MP : 30 kHz ~ 81kHz 56 Hz ~ 85 Hz 151MP : 1024 x 768 @ 85 Hz 171MP : 1280 x 1024 @ 76Hz
Image is not centered on the screen.	<ul style="list-style-type: none"> ■ Adjust the horizontal and vertical position. 	H-Position, page 17. V-Position, page 17.
You need the monitor driver software	<ul style="list-style-type: none"> ■ Download the driver from WWW pages: http://www.samsung-monitor.com http://www.samsungmonitor.com (USA Only) 	

Appendix

Table 4. Troubleshooting – Audio and TV

Problem	Suggested Actions	Reference
No sound	<ul style="list-style-type: none"> ■ Ensure that the audio cable is firmly connected to both the audio-in port on your monitor and the audio-out port on your sound card. 	Connecting your LCD Monitor, page 5.
	<ul style="list-style-type: none"> ■ Check the volume level 	Sound Controls.
Sound level is too low	<ul style="list-style-type: none"> ■ Check the volume level 	Sound Controls.
	<ul style="list-style-type: none"> ■ If the volume is still too low after turning the control to its maximum, check the volume control on the computer sound card or software program. 	Refer to your computer, sound card or software documentation.
Sound is too high pitched or too low pitched	<ul style="list-style-type: none"> ■ Adjust the Treble and Bass to appropriate level. 	Sound Controls, page 17.
TV signal is not received	<ul style="list-style-type: none"> ■ Check "Channel system" and make sure you choose the correct channel system. ■ Select "Channel auto program" to configure the channel system automatically. ■ Check "TV Tuner Box" see "Connecting TV Tuner Box" on page 6. 	See "NTSC broadcasting systems" on page 36.

Appendix

Specifications

Table 5. Technical and environmental specifications

		151MP	171MP
Panel	Size Display Size Type Pixel pitch Viewing Angle	15.0" Diagonal 304.1 (H) x 228.1 (V) mm a-si TFT active matrix 0.297 (H) x 0.297 (V) mm 70/70/60/60 (L/R/U/D) (Depending on the panel manufacturer, the viewing angle may be different from this spec.)	17.0" Diagonal 338 (H) x 270 (V) mm a-si TFT active matrix 0.264 (H) x 0.264 (V) mm 80/80/80/80 (L/R/U/D) (Depending on the panel manufacturer, the viewing angle may be different from this spec.)
* Frequency	Horizontal Vertical Display color	30 ~ 69 kHz 56 ~ 85 Hz 16,777,216 colors	30 ~ 81 kHz 56 ~ 85 Hz (~XGA) 60 ~ 76 Hz (SXGA) 16,777,216 colors
Display Resolution	Optimum Mode Maximum Mode	1024 x 768 @ 60 Hz 1024 x 768 @ 85 Hz	1280 x 1024 @ 60 Hz 1280 x 1024 @ 76 Hz
Input Signal	Sync. Video signal	H/V Separate, TTL, P. or N. H/V Composite, TTL, P. or N. Sync-on-green 0.3 Vp-p, N. 0.7 Vp-p @ 75 ohm	
TV, Video	Color system Sound system Video format	NTSC M/N CVBS, S-VHS	
DTV	YPbPr RGB Video signal	Composite sync. 1080i, 720p, 480p, 480i (except U.S.A.) Separate sync. 1080i, 720p, 480p, 480i (except U.S.A.) 0.7 Vp-p @ 75 ohm	
Video	Color system	NTSC	

* Referring to Preset timing modes, page 36.

Appendix

Table 5. Technical and environmental specifications (Continued)

		151MP	171MP
Power Supply	Input Output	AC 90 ~ 264 Vrms (50Hz / 60Hz) DC 12V/4.5A	
Power Consumption	Maximum Power Saving	40 W < 3 W	52 W < 3 W
Dimensions/ Weight	Unit (WxHxD) : Monitor body	14.1 x 13.8 x 2.0 inch / 7.2 lbs (358.6 x 351.1 x 51 mm / 3.3 kg)	16.2 x 16.1 x 2.3 inch / 10.3 lbs (412 x 408.0 x 58.5 mm / 4.7 kg)
	With stand	14.1 x 14.2 x 6.9 inch / 7.7 lbs (358.6 x 360.1 x 175.5 mm / 3.5 kg)	16.2 x 16.5 x 8.0 inch / 11 lbs (412.0 x 418.0 x 203.0 mm / 5 kg)
	When folded	14.1 x 15.9 x 2.0 inch / 7.7 lbs (358.6 x 402.6 x 51 mm / 3.5 kg)	16.2 x 18.6 x 2.3 inch / 11lbs (412.0 x 472.0 x 58.5 mm / 5 kg)
Environmental Considerations	Operating Temperature	50 °F to 104 °F (10 °C to 40 °C)	
	Operating Humidity	10% to 80%	
	Storage Temperature	13 °F to 113 °F (-25 °C to 45 °C)	
	Storage Humidity	5% to 95%	
Audio Characteristics	Audio Input 1 Audio Input 2 Audio Input 3 Headphone out Frequency Response	RCA Jack Red(R) White(L), 0.5Vrms (-9dB) 3.5Ø Stereo Jack, 0.5Vrms (-9dB) RCA Jack Red(R) White(L), 0.5Vrms (-9dB) Max. 10mW Output (3.5Ø Stereo Jack 32Ω) RF: 80Hz ~ 15kHz (at - 3dB) A/V: 80Hz ~ 20kHz (at - 3dB)	

Appendix

Pin Assignments

Table 6. 15 pin D-sub connector

Pin	Separate H/V	Composite H/V	Sync-on-green
1	Red	Red	Red
2	Green	Green	Green + H/V Sync
3	Blue	Blue	Blue
4	GND	GND	GND
5	GND (DDC Return)	GND (DDC Return)	GND (DDC Return)
6	GND-Red	GND-Red	GND-Red
7	GND-Green	GND-Green	GND-Green
8	GND-Blue	GND-Blue	GND-Blue
9	No Connection	No Connection	Not used
10	GND-Sync/Self Test	GND-Sync/Self Test	GND-Sync/Self Test
11	GND	GND	GND
12	DDC_SDA	DDC_SDA	DDC_SDA
13	H_Sync	H/V Sync	Not used
14	V_Sync	Not used	Not used
15	DDC_SCL	DDC_SCL	DDC_SCL

Appendix

Display Modes

If the signal from the system equals to the standard signal mode, the screen is adjusted automatically. If the signal from the system doesn't equal to the standard signal mode, adjust the mode with referring to the Videocard user guide because the screen might not display or only the power LED might be on. For the display modes listed below, the screen image has been optimized during manufacture.

Table 7. Preset timing modes

Mode	Resolution	Horizontal Frequency (kHz)	Vertical Frequency (Hz)	Pixel Clock Frequency (MHz)	Sync Polarity (H/V)
VGA	720 x 400	31.469	70.087	28.322	-/+
	640 x 480	31.469	59.940	25.175	-/-
	640 x 480	37.500	75.000	31.500	-/-
	640 x 480	43.269	85.008	36.000	-/-
SVGA	800 x 600	46.875	75.000	49.500	+/+
	800 x 600	53.674	85.061	56.250	+/+
XGA	1024 x 768	48.363	60.004	65.000	-/-
	1024 x 768	60.023	75.029	78.750	+/+
	1024 x 768	68.677	84.997	94.500	+/+
SXGA (171MP only)	1280 x 1024	63.981	60.020	108.000	+,-/+,-
	1280 x 1024	79.976	75.025	135.000	+/+

Table 8. NTSC Broadcasting Systems

Color System	Sound System	Stereo System	Channel System	Countries
NTSC	M	A2	US	Korea
		BTSC (SAP)	US	USA, Canada, Chile, Venezuela, Cuba, Colombia, Jamaica, Mexico, Panama, Peru, Philippines, Puerto-Rico, Taiwan
		EIAJ	Japan	Japan

Appendix

Attaching a wall or Arm mounting device

The monitor supports VESA mounting standard for use with various VESA mounting devices. To install any VESA mounting device, please follow the instructions given.

Case 1.

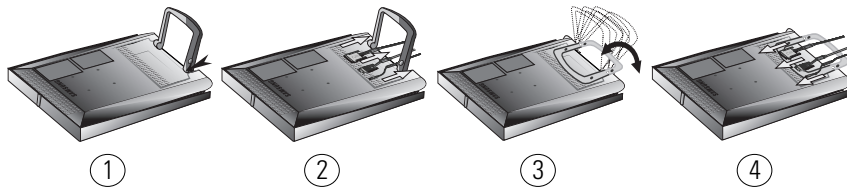

- 1** Lay the LCD monitor face-down on a flat surface with a cushion or other soft materials to protect the screen.
- 2** Remove all cables connected to the monitor.
- 3** Press "FOLD" button on the stand and tilt the monitor backward until the stand is folded in the monitor.
- 4** Connect all cable you removed at step 2.
- 5** Now you are ready to install Wall/Arm mounting device depending on your applications.

Case 2.

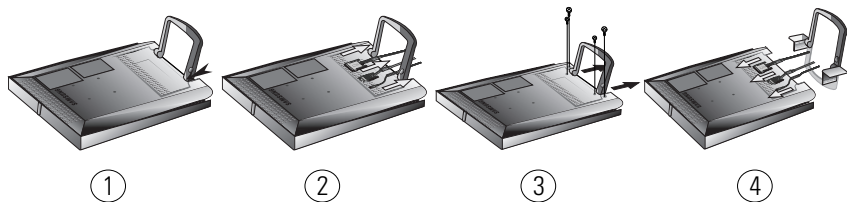

- 1** Lay the LCD monitor face-down on a flat surface with a cushion or other soft materials to protect the screen.
- 2** Remove all cable connected on the monitor.
- 3** Remove the four screws and then remove the Stand from the LCD monitor.
- 4** Connect all cable you removed at step 2.
- 5** Now you are ready to install Wall/Arm mounting device depending on your applications.

Appendix

Installing VESA compliant mounting devices

Refer to page 37 to fold the base.

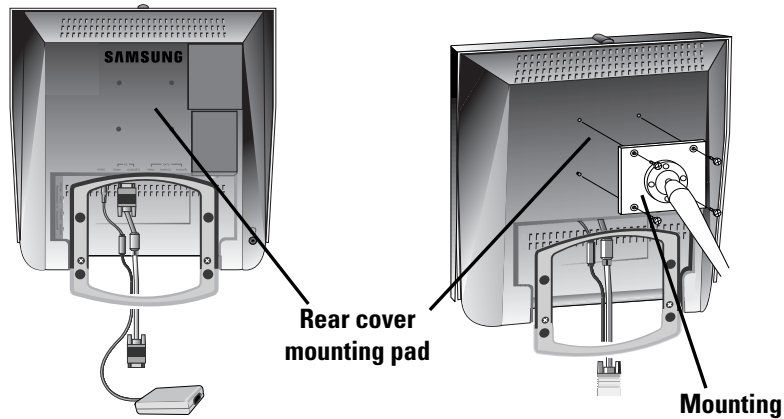

Align the mounting interface pad with the holes in the rear cover mounting pad and secure it with the four screws that came with the arm-type base, wall mount hanger or other bases.

Wall Mount Instructions

The following instructions apply to a hollow sheet-rock wall only Tools/Hardware needed - Phillips screwdriver, four toggle bolts, 5/8in dia. Drill bit and drill. Contact Ergotron at (800) 888-8458 to purchase the triple pivot direct mount adapter and wall mount bracket kit.

- **151MP (15")** : No. 47 - 007 - 099 (Pivot direct mount adapter)
No. 97 - 101 - 003 (Wall mount bracket kit)
- **171MP (17")** : No. 47 - 007 - 099 - 02 (Pivot direct mount adapter)
No. 97 - 101 - 003 - 00 (Wall mount bracket kit)

Align the wall mount bracket on the wall at the desired height, making sure that the bracket will be mounted between the wall studs. Mark the four corner openings and drill four 5/8-dia. holes.

Assemble the wall mount kit according to the instructions provided with it.

Securely attach Ergotron's flat panel, triple pivot direct mount adapter to the back of the monitor using the four 4mm, .7 pitch x 10mm screws provided with the arm.

Secure the assembly to the wall using four 3/16 by 3-inch long toggle bolts.

Appendix

Retractable Stand

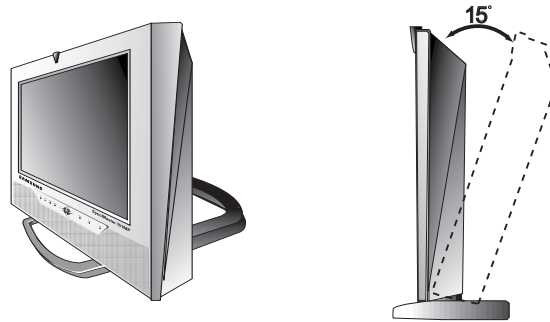

*NOTE: The maximum tilt angle is 15 degree to the backward direction. Please do not tilt the monitor other than specified range. **Excessive force to tilt the monitor other than specified range may give permanent damage to the mechanical part of the stand.***

Maintenance of Your LCD monitor

WARNING: To avoid risk of electric shock, do not disassemble the monitor cabinet (except for gaining access to the cable connectors as described on page 5). Users cannot service the monitor. User maintenance is restricted to cleaning as explained below:

Unplug the monitor from the power outlet before cleaning.

- To clean your flat panel display screen, lightly dampen a soft, clean cloth with water or mild detergent. If possible, use a special screen cleaning tissue or solution suitable for the antistatic coating.
- To clean the monitor cabinet, use a cloth lightly dampened with a mild detergent.
- Never use flammable cleaning material to clean your LCD monitor or any other electrical apparatus.

Index

A

Active Area 21
Automatic Save 9

B

Bass 21, 23
Beep 13
Brightness 14, 21, 23

C

Cable connections 5
CH 9
Channel System 18
Closed Caption 22
Coarse 15
Color 21
Contrast 14, 21, 23

D

DC adapter 3
Display Modes 36
Duration 13

E

Exit 10

F

Fine 15
Fine Tune 19
Function icons 13, 14, 18

H

Halftone 13
H-position 17

I

Image lock 15
Image size 16
Information 15
Input Format 23
Installation CD 3

K

Kensington security slot 4

L

Language 13
LNA 20

M

Menu 10
MTS/S-Mode 28

N

NTSC Broadcasting System 36

O

On Screen Display (OSD) 12
OSD Lock/Unlock 11
OSD Control 13

P

Pan 16
Pin Assignments 35
PIP 9,17
Plug and Play 7
Power 9
Power Indicator 7
Power-saving modes 29
Program 10

R

Remote Controller 3, 27
Reset 15, 21

S

S-VHS Cable 3
Safety Instructions 2
Screen size 24
Self-test feature check 7
Sharpness 21
Size 17
Sound 17, 21, 23
Stereo-RCA Cable 3
Stereo System 19
Surround 21, 23

T

Tilt the screen 4
Timer 22
Tint 21
Treble 21, 23
Troubleshooting 30
TV Setup 18

U

User control locations 9
User mode 14

V

V-Chip 22, 25
VOL 9
Volume 10
V-position 17

Z

Zoom 16

Regulatory Information

FCC Information

User Instructions

The Federal Communications Commission Radio Frequency Interference Statement includes the following warning:

Note: This equipment has been tested and found to comply with the limits for a Class B digital device, pursuant to Part 15 of the FCC Rules. These limits are designed to provide reasonable protection against harmful interference in a residential installation. This equipment generates, uses, and can radiate radio frequency energy and, if not installed and used in accordance with the instructions, may cause harmful interference to radio communications. However, there is no guarantee that interference will not occur in a particular installation.

If this equipment does cause harmful interference to radio or television receptions, which can be determined by turning the equipment off and on, the user is encouraged to try to correct the interference by one or more of the following measures:

- Reorient or relocate the receiving antenna.
- Increase the separation between the equipment and receiver.
- Connect the equipment into an outlet on a circuit different from that to which the receiver is connected.
- Consult the dealer or an experienced radio/TV technician for help.

User Information

Changes or modifications not expressly approved by the party responsible for compliance could void the user's authority to operate the equipment.

If necessary, consult your dealer or an experienced radio/television technician for additional suggestions. You may find the booklet called How to Identify and Resolve Radio/TV Interference Problems helpful. This booklet was prepared by the Federal Communications Commission. It is available from the U.S. Government Printing Office, Washington, DC 20402, Stock Number 004-000-00345-4.

Warning

User must use shielded signal interface cables to maintain FCC compliance for the product.

Declaration of conformity for products Marked with FCC Logo

This device complies with Part 15 of the FCC Rules. Operation is subject to the following two conditions: (1) this device may not cause harmful interference, and (2) this device must accept any interference received, including interference that may cause undesired operation.

The party responsible for product compliance:

SAMSUNG ELECTRONICS CO., LTD
America QA Lab of Samsung
85 West Tasman Drive
San Jose, CA 95134 USA
Tel) 408-544-5124
Fax) 408-544-5191

Provided with this monitor is a detachable power supply cord with IEC320 style terminations. It may be suitable for connection to any UL Listed personal computer with similar configuration. Before making the connection, make sure the voltage rating of the computer convenience outlet is the same as the monitor and that the ampere rating of the computer convenience outlet is equal to or exceeds the monitor voltage rating.

For 120 Volt applications, use only UL Listed detachable power cord with NEMA configuration 5-15P type (parallel blades) plug cap. For 240 Volt applications use only UL Listed Detachable power supply cord with NEMA configuration 6-15P type (tandem blades) plug cap.

IC Compliance Notice

This Class B digital apparatus meets all requirements of the Canadian Interference-Causing Equipment Regulations of ICES-003.

Cet appareil Numérique de classe B respecte toutes les exigences du Règlement ICES-003 sur les équipements produisant des interférences au Canada.

MPR II Compliance

This monitor complies with SWEDAC(MPR II) recommendations for reduced electric and magnetic fields.

European Notice

Products with the CE Marking comply with both the EMC Directive (89/336/EEC), (92/31/EEC), (93/68/EEC) and the Low Voltage Directive (73/23/EEC) issued by the Commission of the European Community.

Compliance with these directives implies conformity to the following European Norms:

- EN55022:1998 – Radio Frequency Interference
- EN55024:1998 – Electromagnetic Immunity
- EN61000-3-2:1995 + A1 + A2 – Power Line Harmonics
- EN61000-3-3:1995 – Voltage Fluctuations
- EN60950 – Product Safety.

U.S.A.:

Samsung Electronics America (SEA)
400 Valley Road, Suite 201
Mt. Arlington, NJ 07856
Tel.: 1-800-SAMSUNG (1-800-726-7864)

CANADA:

Samsung Electronics Canada Inc.
7037 Financial Drive
Mississauga, Ontario L5N 6R3
Tel.: 1-800-SAMSUNG (1-800-726-7864)
Fax.: (905) 542-1199

GERMANY:

Samsung Electronics GmbH
Samsung-Haus, Am Kronberger Hang 6
65824 Schwalbach/Ts.
Tel. 49 (0180) 5121213 *
Fax. 49 (0180) 5121214 *
*DM 0,24/Min.

AUSTRALIA:

Samsung Electronics Australia Pty Ltd.
Unit G, 10-16 South Street,
Rydalmere, N.S.W. 2116
P.O. BOX 368
Tel.: (02) 638 5200

ITALIA:

Samsung Electronics Italia SpA
Via C. Donat Cattin,
5-20063 Cernusco sul Naviglio (Mi)
Tel.: 167-010740

PANAMA:

Servicios Samsung (Zona Libre), S.A.
50 and 61 Streets Sta, Cecilia
Bdl. Don Camilo, Panama City
Tel.: (507) 264-0195 or 269-5571
Fax: (507) 269-5568

MEXICO:

Samsung Electronics Mexico S.A. de C.V.
Saturno 44 Col. Nva. Industrial Vallejo
Del. Gustavo A. Madero C.P. 07700
Mexico D.F. Tel. 5747-5100
RFC: SEM950215S98

ESPAÑA:

Samsung Electrónica Comercial Ibérica, S.A. Ciencias, 55-
65 (Poligono Pedrosa) 08908 Hospitalet de Llobregat
(Barcelona)
Tel.: (93) 261 67 00
Fax.: (93) 261 67 50

UK:

Samsung Electronics (UK) Ltd.
Samsung House, 225 Hook Rise South
Surbiton, Surrey KT6 7LD
Tel.: (0181) 391 0168
Fax.: (0181) 397 9949
<European Service Center & National Service>
Stafford Park 12 Telford, Shropshire, TF3 3BJ
Tel.: (01952) 292 262
Fax.: (01952) 292 033

THAILAND:

Samsung Service Center
729-729/1 JSP Tower Rachadapisek RD.,
Bangpongpan, Yannawa, Bangkok 10120
Tel: (662) 2954508-14
Fax: (662) 2954267

SOUTH AFRICA:

Samsung Electronics South Africa
Somerset Office Park 5 Libertas Road
Bryanston, South Africa
Tel: (27)-11-463-5678
Fax: (27)-11-463-5215

BRASIL:

Samsung Eletrônica da Amazonia Ltda.
R. Prof. Manoelito de Ornellas, 303-2º Andar
Chácara Sto. Antônio • cep: 04719-040
São Paulo • SP
Tel.: (011) 541-8500
Fax: (011) 523-3995, 522-0726

SWEDEN:

Samsung Electronics Svenska, AB
Box 713, S-194 27 Upplands Vasby
Tel: (468) 590-966-00
Fax: (468) 590-966-50

IMPORTADO POR: SAMSUNG ELECTRONICS MEXICO S.A. DE C.V.
SATURNO 44 COL. NVA. INDUSTRIAL VALLEJO
DEL. GUSTAVO A. MADERO C.P. 07700
MEXICO D.F. TEL. 5747-5100
RFC: SEM950215S98
EXPORTADO POR: SAMSUNG ELECTRONICS CO.,LTD.
JOONG-ANG DAILY NEWS BLDG.
7 SOON-WHA-DONG CHUNG-KU,
C.P.O BOX 2775, 1144 SEOUL, KOREA



"As an ENERGYSTAR® Partner, SAMSUNG has determined that this product meets the ENERGYSTAR® guidelines for energy efficiency."

P/N : BN68-00199C-05



Printed on recyclable paper

Free Manuals Download Website

<http://myh66.com>

<http://usermanuals.us>

<http://www.somanuals.com>

<http://www.4manuals.cc>

<http://www.manual-lib.com>

<http://www.404manual.com>

<http://www.luxmanual.com>

<http://aubethermostatmanual.com>

Golf course search by state

<http://golfingnear.com>

Email search by domain

<http://emailbydomain.com>

Auto manuals search

<http://auto.somanuals.com>

TV manuals search

<http://tv.somanuals.com>