

SyncMaster 173MW

Notational

Please read the following safety instructions as they are designed to prevent damage to property and harm to the user.



Warning / Caution



Failure to follow directions noted by this symbol could result in bodily harm or damage to equipment.

Notational Conventions



Prohibited



Important to read and understand at all times



Do not disassemble



Disconnect the plug from the outlet



Do not touch



Grounding to prevent an electric shock

Power



When not used for extended periods of time, set your PC to DPMS. If using a screen saver, set it to the active screen mode.



Do not use a damaged or loose plug.

- This may cause an electric shock or fire.



Do not pull the plug out by the wire nor touch the plug with wet hands.

- This may cause an electric shock or fire.



Use only a properly grounded plug and receptacle.

- An improper ground may cause electric shock or equipment damage.



Do not excessively bend the plug and wire nor place heavy objects upon them, which could cause damage.

- This may cause an electric shock or fire.

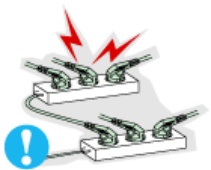

Do not connect too many extension cords or plugs to an outlet.

- This may cause a fire.

Installation



- **Put your monitor in a location with low humidity and a minimum of dust.**
 - An electric shock or fire could result inside the monitor.



- **Do not drop the monitor when moving it.**
 - This may cause damage to the product or human body.



- **Place the monitor on a flat and stable surface.**
 - The monitor can cause injury by falling.



- **Set down the monitor carefully.**
 - It could be damaged or broken.



- **Do not place the monitor face down.**
 - The TFT-LCD surface may be damaged.



- **Installing a wall bracket must be done by a qualified professional.**
 - Installation by unqualified personnel may result in injury.
 - Always use the mounting device specified in the owner's manual.



- **Leave a space for ventilation between the product and the wall.**
 - Poor ventilation may cause the interior temperature to rise and lead to a fire.



- **To prevent rainwater from running along the outdoor antenna cable and entering the house, be sure the outdoor portion of the cable hangs down below the point of entry.**
 - If rainwater enters the product, it may cause an electric shock or fire.

Installation



● If you are using an outdoor antenna, be sure to put sufficient distance between your antenna and the electrical wires nearby so that they would not come in contact with each other in case the antenna is knocked over by strong wind.

- A knocked-over antenna may cause injury or an electric shock.

Cleaning



When cleaning the monitor case or the surface of the TFT-LCD, wipe with a slightly moistened, soft fabric.



● **Do not spray water or detergent directly on the monitor.**

- This may cause damage, electric shock or a fire.



● **Use the recommended detergent with a smooth cloth.**



● **If the connector between the plug and the pin is dusty or dirty, clean it properly with a dry cloth.**

- A dirty connector can cause an electric shock or fire.



● **When you remove batteries from the remote, be careful that they are not swallowed by children. Keep batteries out of the reach of children.**

- If swallowed, see a doctor immediately.

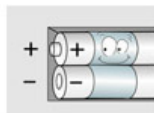

● **When replacing batteries, place the batteries in the correct +/- polarity position as indicated on battery holder.**

- Incorrect polarity may cause a battery to break or leak and could lead to a fire, injury, or contamination (damage).



● **Use only specified standard batteries. Do not use new and used batteries together.**

- may cause a battery to break or leak and could lead to a fire, injury, or contamination (damage).



● **Contact a Service Center or Customer Center for interior cleaning once a year.**

- Keep the product's interior clean. Dust which has accumulated in the interior over an extended period of time may cause malfunction or a fire.

Other



Do not remove cover (or back). No user serviceable parts inside.

- This may cause an electric shock or a fire.
- Refer servicing to qualified service personnel.



If your monitor does not operate normally - in particular, if there are any unusual sounds or smells coming from it - unplug it immediately and contact an authorized dealer or service.

- This may cause an electric shock or fire.



Be careful not to let water drip into the monitor or expose the monitor to moisture.

- This may cause malfunction, an electric shock or a fire.
- Especially avoid operating the monitor near water or outdoors where it could be exposed to snow or rain.



If the monitor is dropped or the casing is damaged, turn the monitor off and unplug the power cord.

- The monitor may malfunction, causing an electric shock or a fire.
- Then contact the [Service Center](#).



Keep the power off when there is thunder and lightning outside, or let the monitor remain unused for an extended period of time.

- The monitor may malfunction, causing an electric shock or a fire.



Do not try to move the monitor by pulling on the wire or the signal cable.

- This may cause a breakdown, electric shock or a fire due to damage to the cable.



Do not move the monitor right or left by pulling only the wire or the signal cable.

- This may cause a breakdown, electric shock or a fire due to damage to the cable.



Do not cover the vents on the monitor cabinet.

- Bad ventilation may cause a breakdown or fire.

Other



Do not place any heavy objects on the monitor.

- This may cause malfunction, an electric shock or a fire.



Do not place water containers, chemical products or small metal objects on the monitor.

- This may cause malfunction, an electric shock or a fire.
- If a foreign substance enters the monitor, unplug the power cord and contact the [Service Center](#).



Do not use or store inflammable substances near the monitor.

- This may cause an explosion or fire.



Never insert anything metallic into the monitor openings.

- This may cause an electric shock, fire or injury.



Do not insert metal objects such as utensils, wire or drill bits, or things that catch fire easily, such as pieces of paper or matches, into the vents or the headphone or A/V ports on the monitor.

- This may cause malfunction, an electric shock or a fire.
- Always contact the [Service Center](#) if foreign substances/objects enter into the monitor.



If you view a fixed screen for an extended period of time, residual image or blurriness may appear.

- Change the mode to energy save or set a screensaver to moving picture when you need to be away from the monitor for an extended period of time.



Be careful when adjusting the stand angle.

- Applying too much force may cause the monitor to topple over or fall, resulting in injury.
- Your hand or finger(s) may get caught between the monitor and the stand, causing injury.



Adjust the resolution and frequency to the levels appropriate for the model.

- Inappropriate resolution may cause undesirable picture quality.

17 inch wide - 1280 X 768

Other



Keep all power adaptors apart.

- Possible fire hazard.



Keep power adaptor away from any other heat source.

- Possible fire hazard.



Remove and discard vinyl bag from power adaptor before use.

- Possible fire hazard.



Always keep power adaptor in well-ventilated area.



Keep the volume at a proper level when you use the headphones.

- Excessively loud volume levels may damage hearing.

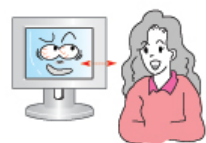

Keep a proper distance between your eyes and the monitor screen.

- Sitting too close to the monitor on a continuous basis may damage eyesight.



When moving the monitor, turn the power switch off and unplug the power cord. Make sure that all cables, including the antenna cable and cables connecting to other devices, are disconnected before moving the monitor.

- Failure to disconnect a cable may damage it and lead to a fire or an electric shock.

Unpacking

 Please make sure the following items are included with your monitor. If any items are missing, [contact your dealer](#).

● Unpacking



User's Guide and Natural Color/
Driver Installation CD



Quick Setup Guide



Warranty Card
(Not available in all locations)



Remote Control



Monitor



Power Cord



Signal Cable (15 pin D-Sub)



DC Adapter



Batteries (AAA X 2)

● Option

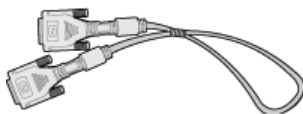

DVI cable

 Contact a local Samsung Electronics [service center](#) to buy optional items.

Front

 For detailed information concerning the monitor functions, refer to [User Controls](#) under Adjusting Your Monitor. The monitor's front configuration may vary slightly depending on the monitor model.



- | | |
|--------------------------------------|---------------------------|
| 1. Auto button | 6. Source button |
| 2. Menu button | 7. PIP button |
| 3. Channel button (Up-Down Button) | 8. Power button |
| 4. Volume button (Left-Right Button) | 9. Power indicator |
| 5. Enter button | 10. Remote Control Sensor |



PIP (Picture in Picture)?

Feature allowing one program to be viewed on the entire screen while one or more programs play in small windows superimposed over the base program.

Rear

 For detailed information concerning cable connections, refer to [Connecting Cables](#) under Setup. The monitor's rear configuration may vary slightly depending on the monitor model.

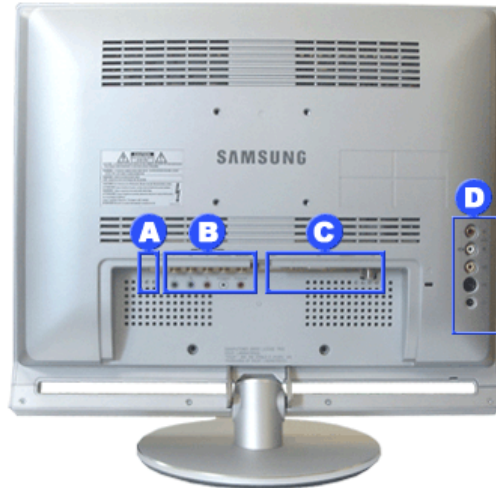

Remove the cover to connect the cables. (Pull the joining part to remove the cover.)

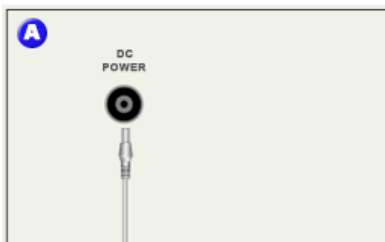

A. Power Connection Terminal (14V DC)

This product may be used with 90 ~ 264V. (Voltage is automatically adjusted by the power adaptor.)

Connect the power source plug when all [cables are connected](#).

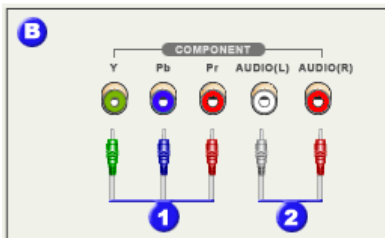

B. DVD/DTV Connection Terminal

1. DVD/DTV component (Y, Pb, Pr) terminal
2. DVD/DTV left / right audio connection terminal (L/R)

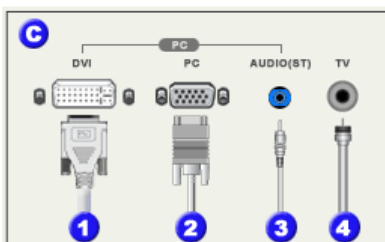

C. PC Connection Terminal

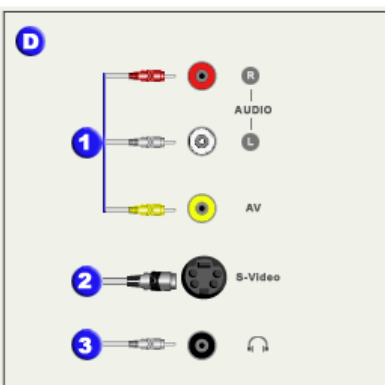

1. Computer Connection Terminal (DVI)
2. Computer Connection Terminal (15 Pin D-SUB)
3. Audio Connection Terminal (Audio (ST))
4. TV Connection Terminal



D. AV Connection Terminal

1. AV Audio (L,R) / Video connection terminal
2. S-Video connection terminal
3. Headphone connection terminal

Remote Control

-  For detailed information of the Remote Control Unit functions, refer to Adjusting Your Monitor > User Controls > User Control Buttons > [Remote Control buttons](#).
The remote control's configuration may vary slightly depending on the monitor model.
-  The Remote control may function within a range of 0.23 to 33 feet (7cm to 10m) and 30 degrees to the left and right of the monitor's Remote Control Reception sensor.

1. Button Names

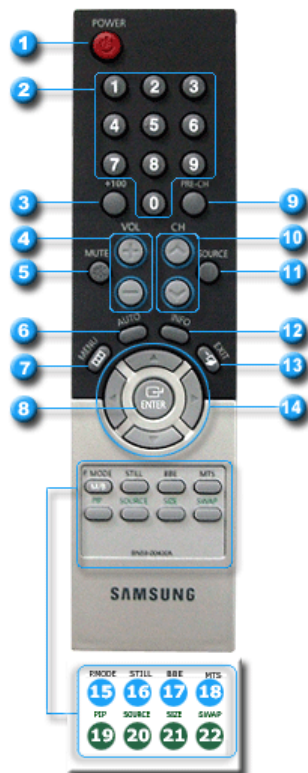



1. POWER
2. Channel
3. +100
4. VOL
5. MUTE
6. AUTO
7. MENU
8. ENTER
9. PRE-CH
10. CH
11. SOURCE
12. INFO
13. EXIT
14. Up-Down Left-Right Buttons
15. P.MODE, M/B (MagicBright™)
16. STILL
17. BBE
18. MTS
19. PIP
20. SOURCE
21. SIZE
22. SWAP

2. Replacing Batteries







1. Slide out the cover pressing part marked ▼.
2. Insert the batteries matching their polarities (+, -).
3. Slide in the cover.

Connecting Your Monitor

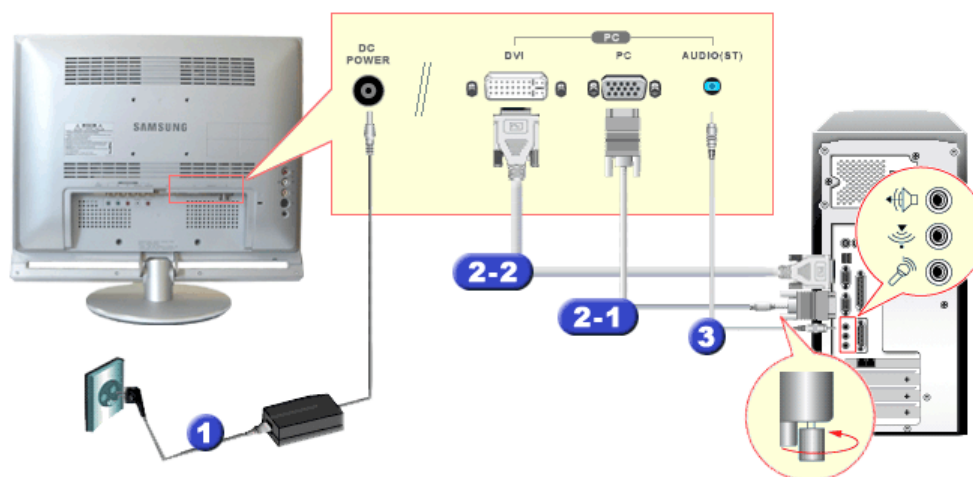

-  Turn on your computer and monitor. If your monitor displays an image, installation is complete.
-  The configuration at the back of the monitor may vary from product to product.

1. Connecting to a Computer



1. Connect the power cord to the DC adapter and connect the adapter jack to the DC POWER port on the back of your monitor.
 2. Connect the signal cable to the **PC Video Connection Terminal** on your computer. There are 2 ways to connect the signal cable to your monitor. Choose one of the followings :
 - 2-1. Using the D-sub (Analog) connector on the video card.
Connect the signal cable to the **15 pin D-sub Port** on the back of your monitor.

 - 2-2. Using the DVI (Digital) connector on the video card.
Connect the DVI Cable(DVI-D + DVI-D) to the **DVI Port** on the back of your Monitor.

 3. Connect the audio cable for your monitor to the audio port on the back of your computer.
 4. Connect the power cord insert a plug in a wall outlet.
 5. Turn on both your computer and the monitor.
 6. You may enjoy clear and quality sound from the computer sound card using the monitor speakers. (You don't need to install any separate speakers for your computer.)
-  You may get a blank screen depending on the type of video card you are using, if you connect simultaneously both the D-sub and DVI cables to one computer.
 -  If you connect properly your monitor using the DVI connector but get a blank or fuzzy screen, check to see if the monitor status is set to analogue. Press Source button to have the monitor double-check the input signal source.

Connecting Your Monitor

-  This monitor allows the user to connect it to such input devices as a DVD player, a VCR or camcorder, or a DTV or TV without disconnecting the PC. For detailed information on connecting AV input devices, refer to [User Controls](#) under Adjusting Your Monitor.
-  The configuration at the back of the monitor may vary from product to product.

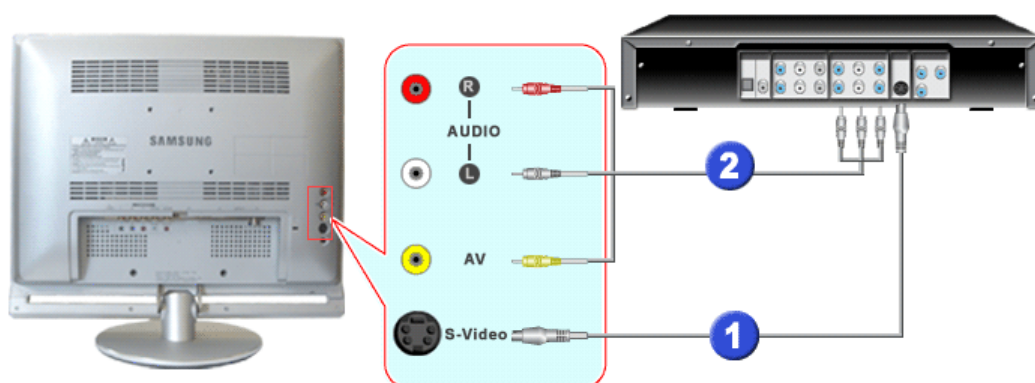
1. Connecting AV Devices

-  The monitor has AV connection terminals to connect AV input devices like DVDs, VCRs or Camcorders. You may enjoy AV signals as long as the monitor is turned on.



1. Input devices such as DVDs, VCRs or Camcorders are connected to the Video or S-Video terminal of the monitor using the RCA or S-VHS cable.

 S-VHS or RCA cable is optional.

2. Connect the Audio (R) and Audio (L) terminals of a DVD, VCR or Camcorders to the monitor's R and L audio input terminals using audio cables.
3. Select Video or S-Video that is connected to a DVD, VCR or Camcorders using the Source button on the monitor's front.
4. Then, start the DVD, VCR or Camcorders with a DVD disc or tape inserted.

Connecting Your Monitor

2. Connecting TV

 You may view television programs on the monitor if it is connected to an antenna or CATV cable without installing any separate TV reception hardware or software on your computer.

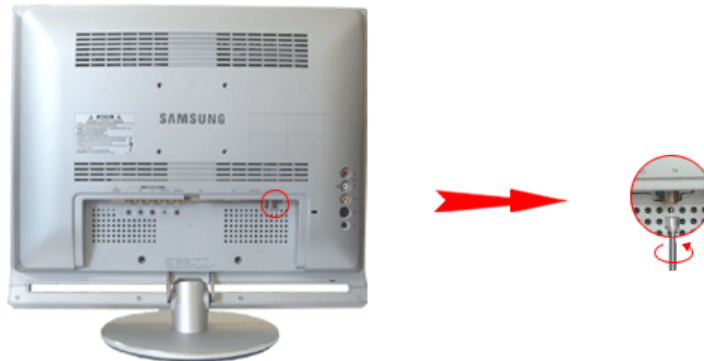

1. Connect the CATV or antenna coaxial cable to the Antenna terminal on the rear of the monitor. You need to use a coaxial antenna cable.

- **When using an interior antenna terminal:**
Check the antenna terminal on the wall first and connect the antenna cable.
- **When using an outdoor antenna:**
If you are using an outdoor antenna, use a professional for installation if possible.
- **To connect the RF cable to the antenna input terminal:**
Keep the copper wire portion of the RF cable straight.

2. Turn on the monitor.
3. Select TV using Source button among the external signal adjustment buttons.
4. Select a desired TV channel.

 **As this product is designed for NTSC signals only, you cannot view TV programs in countries where PAL or SECAM signals are used.**

 **Purchase the antenna cable, antenna converter and amplifier at your neighborhood electronics store.**

 **Is weak signal causing poor reception?**
Purchase and install a signal amplifier for better reception.

Connecting Your Monitor

3. Connecting DVD / DTV Devices

 Connect to the DVD / DTV Devices input if the device has a DVD / DTV connector. You can watch DVD / DTV simply by hooking up the DVD / DTV with the monitor as long as the power is on.

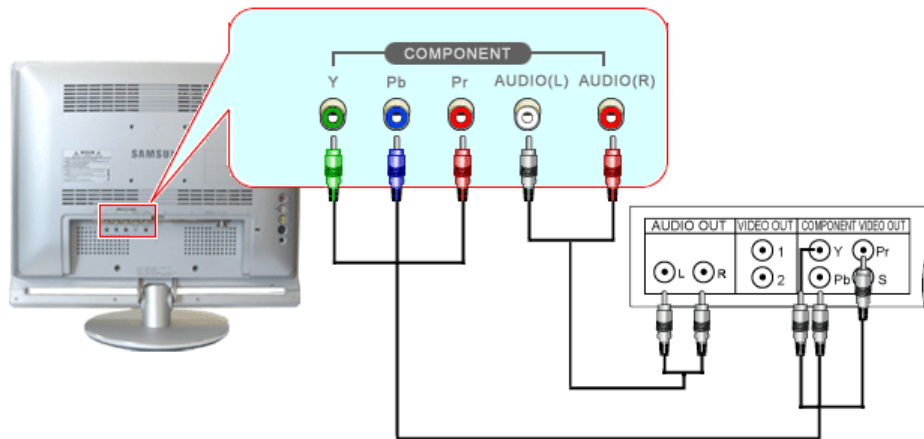

1. Connect a video cable between the component(Y, Pb, Pr) jacks on the Monitor and the Y, Pb, Pr jacks on the DVD / DTV Devices.
2. Connect the Audio (R) and Audio (L) outputs on the DVD / DTV Devices to the Audio (R) and Audio (L) inputs on the monitor using audio cables.
3. Select COMP using the Video button from the user control buttons.

4. Connecting to a Macintosh

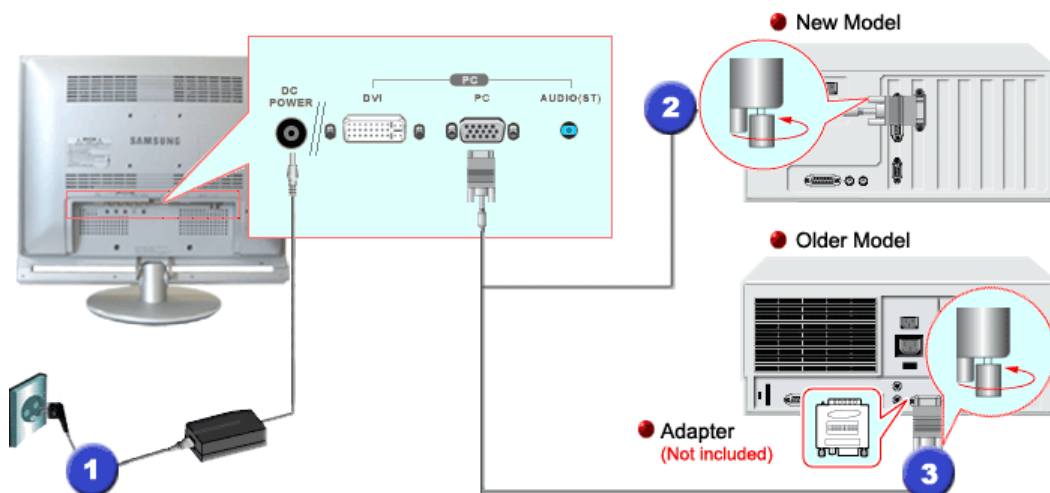

1. Connect the power cord to the DC adapter and then connect the adapter jack to the DC POWER port on the monitor. (Voltage is automatically adjusted by the power adaptor.)
2. Connect the signal cable to the D-SUB port on the Macintosh computer.
3. For older model Macintoshes, you need to adjust the resolution control DIP switch on the Macintosh adapter (optional) referring to the switch configuration table shown on its rear.
4. Turn on the monitor and Macintosh.

Connecting Your Monitor

5. Connecting Headphone

 You may connect your headphones to the monitor.

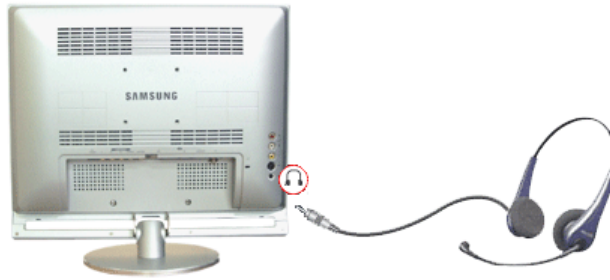

1. Connect your headphones to the Headphone connection terminal.

Installing the Monitor Driver

 When prompted by the operating system for the monitor driver, insert the CD-ROM included with this monitor. Driver installation is slightly different from one operating system to another. Follow the directions as appropriate for the operating system you have.

Prepare a blank disk and download the driver program file at the Internet web site shown here.

- Internet web site : <http://www.samsung-monitor.com/> (Worldwide)
<http://www.samsungusa.com/monitor/> (USA)
<http://www.sec.co.kr/monitor/> (Korea)
<http://www.samsungmonitor.com.cn/> (China)

[Windows ME](#) | [Windows XP/2000](#)

1. Windows ME

 Refer to "Installing the Monitor Driver and User Manual" CD-ROM supplied with the monitor. When inserted into the computer CD drive, the CD-ROM boots up automatically. If it fails to boot up automatically, click **monsetup.exe** twice in the CD-ROM drive folder of Windows Explorer.

1. Insert CD into the CD-ROM driver.
2. Click "**Windows ME Driver**"
3. Choose your monitor model in the model list, then click the "**OK**" button.

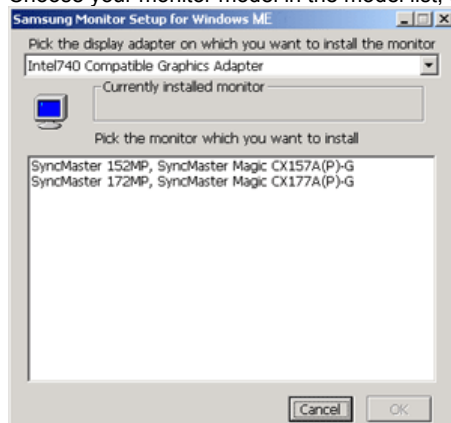

4. Click the "**Install**" button in the "**Warning**" window.

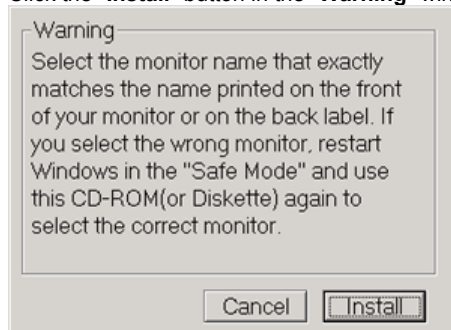

5. Monitor driver installation is completed.

Installing the Monitor Driver

2. Windows XP/2000

 Refer to "Installing the Monitor Driver and User Manual" CD-ROM supplied with the monitor. When inserted into the computer CD drive, the CD-ROM boots up automatically. If it fails to boot up automatically, click **monsetup.exe** twice in the CD-ROM drive folder of Windows Explorer.

1. Insert CD into the CD-ROM driver.
2. Click "**Windows XP/2000 Driver**".
3. Choose your monitor model in the model list, then click the "**OK**" button.

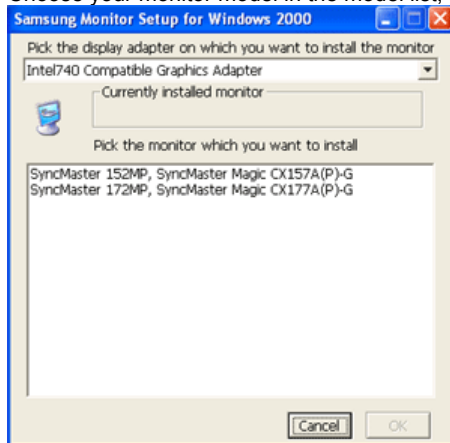

4. Click the "**Install**" button in the "**Warning**" window.

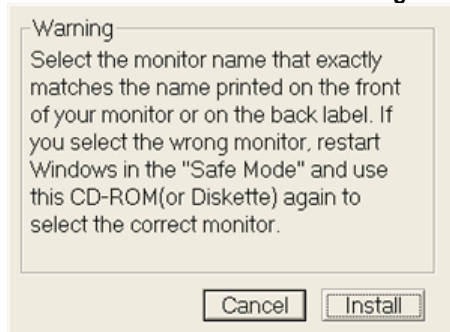

5. If you can see following Message window, then click the "**Continue Anyway**" button. Then click "**OK**" button.

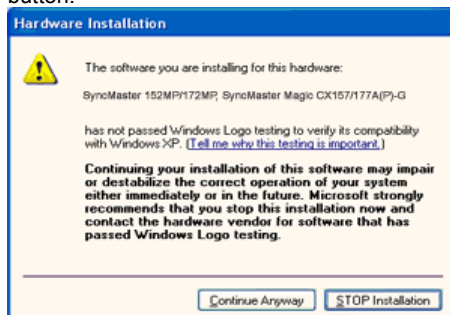

 This monitor driver is under a certified MS logo. This installation will not damage your system. The certified driver will be posted on Samsung Monitor Homepage <http://www.samsung-monitor.com/>

6. Monitor driver installation is completed.

Installing the Monitor Driver

 **When prompted by the operating system for the monitor driver, insert the CD-** this monitor. Driver installation is slightly different from one operating system to another. Follow the directions as appropriate for the operating system you have.

Prepare a blank disk and download the driver program file at the Internet web site shown here.

- Internet web site : <http://www.samsung-monitor.com/> (Worldwide)
<http://www.samsungusa.com/monitor/> (USA)
<http://www.sec.co.kr/monitor/> (Korea)
<http://www.samsungmonitor.com.cn/> (China)

 To install the monitor driver manually, follow the procedures explained below after checking your operating system.

1. Microsoft® Windows® XP Operating System

1. Insert CD into the CD-ROM driver.
2. Click "Start" → "Control Panel" then click the "Appearance and Themes" icon.

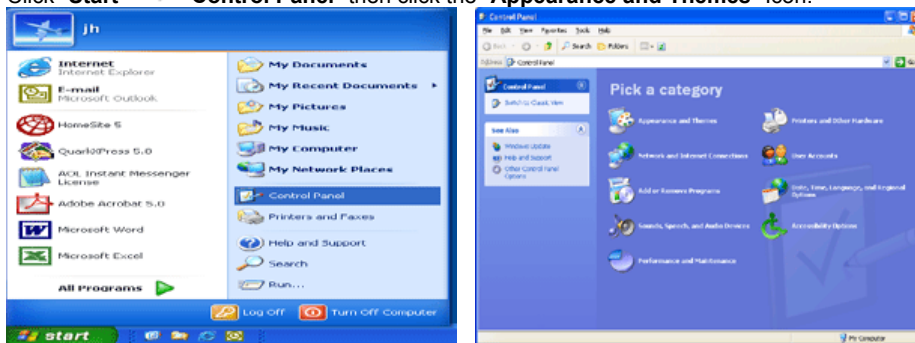

3. Click "Display" icon and choose the "Settings" tab then click "Advanced..".

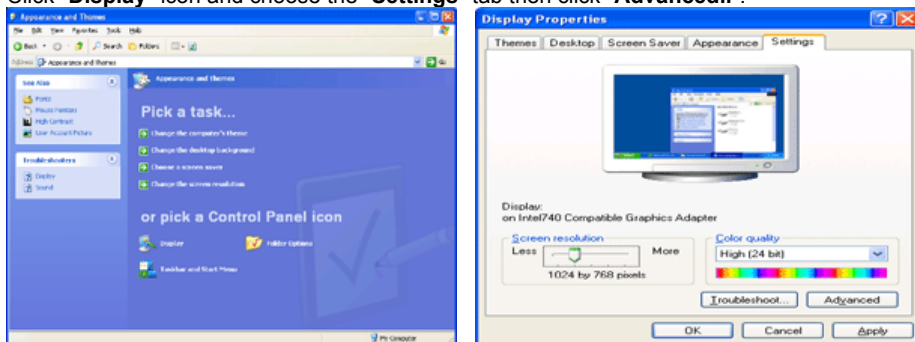

4. Click the "Properties" button on the "Monitor" tab and select "Driver" tab.

Installing the Monitor Driver

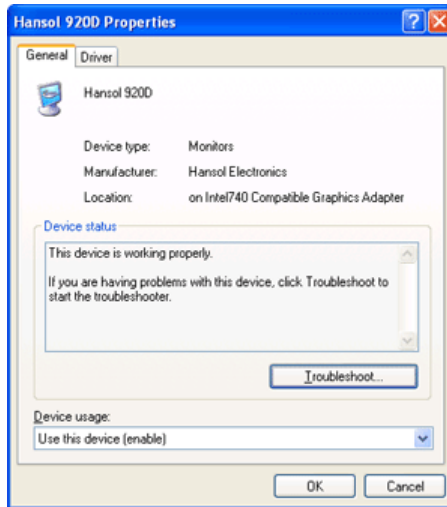
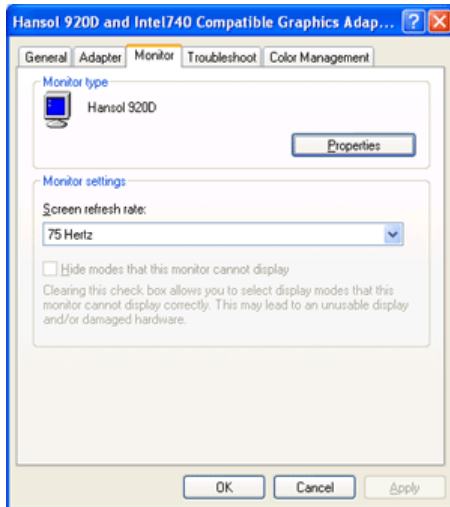

5. Click "**Update Driver..**" and select "**Install from a list or..**" then click "**Next**" button.

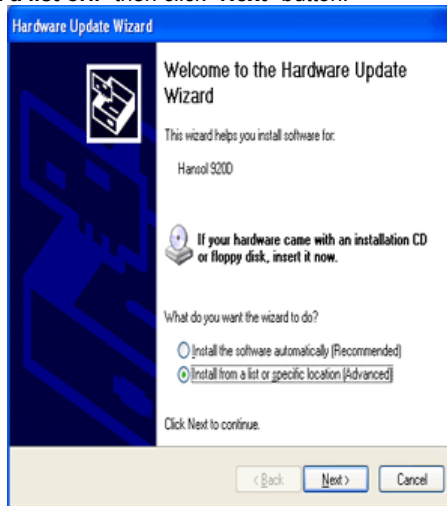
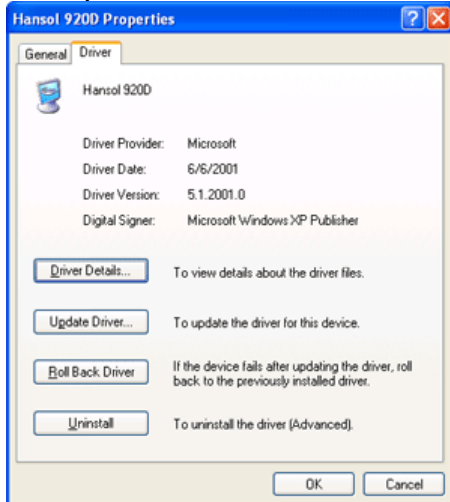

6. Select "**Don't search, I will..**" then click "**Next**" and then click "**Have disk**".

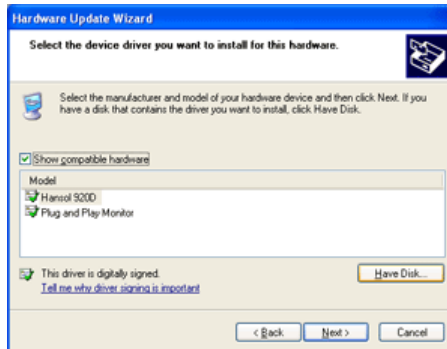
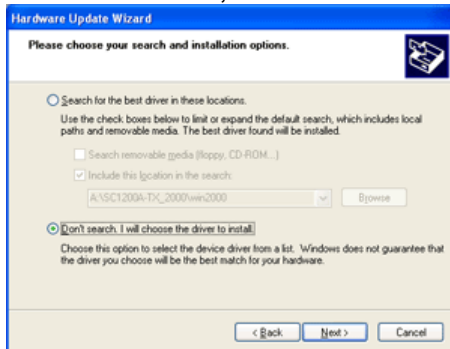

7. Click the "**Browse**" button then choose A:(D:\Driver) and choose your monitor model in the model list and click the "**Next**" button.

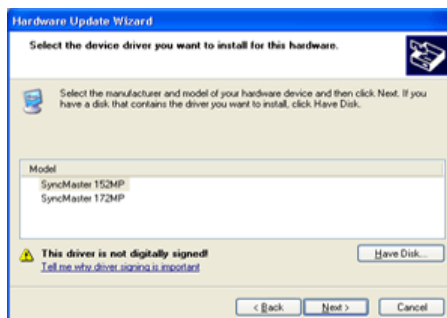
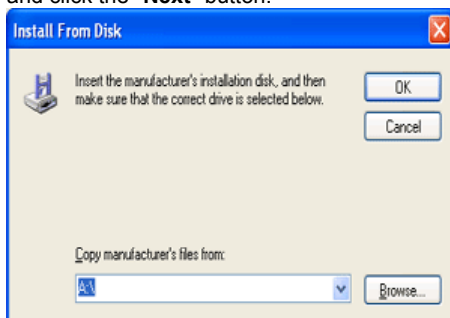

Installing the Monitor Driver

8. If you can see following "Message" window, then click the "Continue Anyway" button. Then click "OK" button.



This monitor driver is under a certified MS logo. This installation will not damage your system. The certified driver will be posted on Samsung Monitor Homepage <http://www.samsung-monitor.com/>

9. Click the "Close" button then click "OK" button continually.

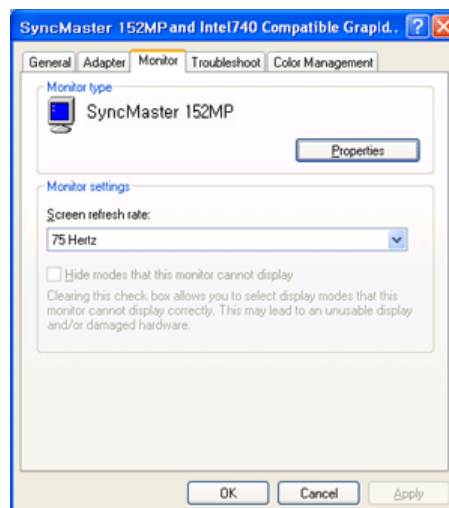
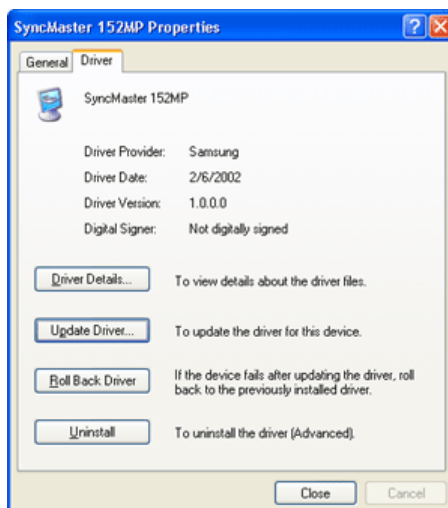
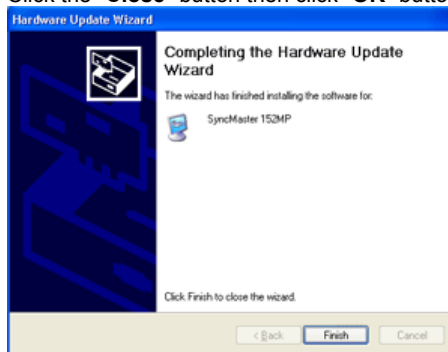

10. Monitor driver installation is completed.

Installing the Monitor Driver

2. Microsoft® Windows® 2000 Operating System

* When you can see "Digital Signature Not Found" on your monitor, follow these steps.

1. Choose **"OK"** button on the **"Insert disk"** window.
2. Click the **"Browse"** button on the **"File Needed"** window.
3. Choose A:(D:\Driver) then click the **"Open"** button and then click **"OK"** button.

* How to install

1. Click **"Start"**, **"Setting"**, **"Control Panel"**.
2. Double click the **"Display"** icon.
3. Choose the **"Settings"** tab and then click **"Advanced.."**.
4. Choose **"Monitor"**.
Case 1: If the "Properties" button is inactive, it means your monitor is properly configured. Please stop installation.
Case 2: If the "Properties" button is active, click the "Properties" button then follow next steps continually.
5. Click **"Driver"** and then click on **"Update Driver.."** then click on the **"Next"** button.
6. Choose **"Display a list of the known drivers for this device so that I can choose a specific driver"** then click **"Next"** and then click **"Have disk"**.
7. Click the **"Browse"** button then choose A:(D:\Driver).
8. Click the **"Open"** button, then click **"OK"** button.
9. Choose your monitor model and click the **"Next"** button then click **"Next"** button.
10. Click the **"Finish"** button then the **"Close"** button.

If you can see the **"Digital Signature Not Found"** window then click the **"Yes"** button. And click the **"Finish"** button then the **"Close"** button.

3. Microsoft® Windows® Millennium Operating System

1. Click **"Start"**, **"Setting"**, **"Control Panel"**.
2. Double click **"Display"** icon.
3. Select the **"Settings"** tab and click **"Advanced Properties"** button.
4. Select the **"Monitor"** tab.
5. Click the **"Change"** button in the **"Monitor Type"** area.
6. Choose **"Specify the location of the driver"**.
7. Choose **"Display a list of all the driver in a specific location.."** then click **"Next"** button.
8. Click the **"Have Disk"** button
9. Specify A:(D:\Driver) then click **"OK"** button.
10. Select **"Show all devices"** and choose the monitor that corresponds to the one you connected to your computer and click **"NEXT"**. Click **"NEXT"** again and **"FINISH"** to complete installation.
11. Continue choosing **"CLOSE"** button and **"OK"** button until you close the Display Properties dialogue box.
(You may get a screen with a warning or other message, just click the appropriate option for your monitor.)

Installing the Monitor Driver

4. Microsoft® Windows® NT 4.0 Operating System

1. Click **Start**, **Settings**, **Control Panel**, and then double-click **Display** icon.
2. In Display Registration Information window, click Settings Tab and then click **All Display Modes**.
3. Select a mode that you wish to use (Resolution, Number of colors and Vertical frequency) and then click **OK**.
4. Click **Apply** button if you see the screen working normally after clicking Test. If the screen is not normal, change to a different mode (lower mode of resolution, colors or frequency).



If there is no Mode at **All Display Modes**, select the level of resolution and vertical frequency by referring to the [Preset Display Modes](#) in the user guide.

5. Linux Operating System



To execute X-Window, you need to make the X86Config file, which is a type of system setting file.

1. Press Enter at the first and the second screen after executing the X86Config file.
2. The third screen is for **setting your mouse**.
3. Set a mouse for your computer.
4. The next screen is for **selecting a keyboard**.
5. Set a Keyboard for your computer.
6. The next screen is for **setting your monitor**.
7. First of all, set a **horizontal frequency** for your monitor. (You can enter the frequency directly.)
8. Set a **vertical frequency** for your monitor. (You can enter the frequency directly.)
9. Enter the **model name of your monitor**. This information will not affect the actual execution of X-Window.
10. You have **finished** setting up your monitor.
Execute X-Window after setting other requested hardware.

Installing a VESA base

-  The monitor supports VESA mounting standard for use with various VESA mounting devices. This monitor accepts a 75mm x 75mm VESA-compliant mounting interface pad.

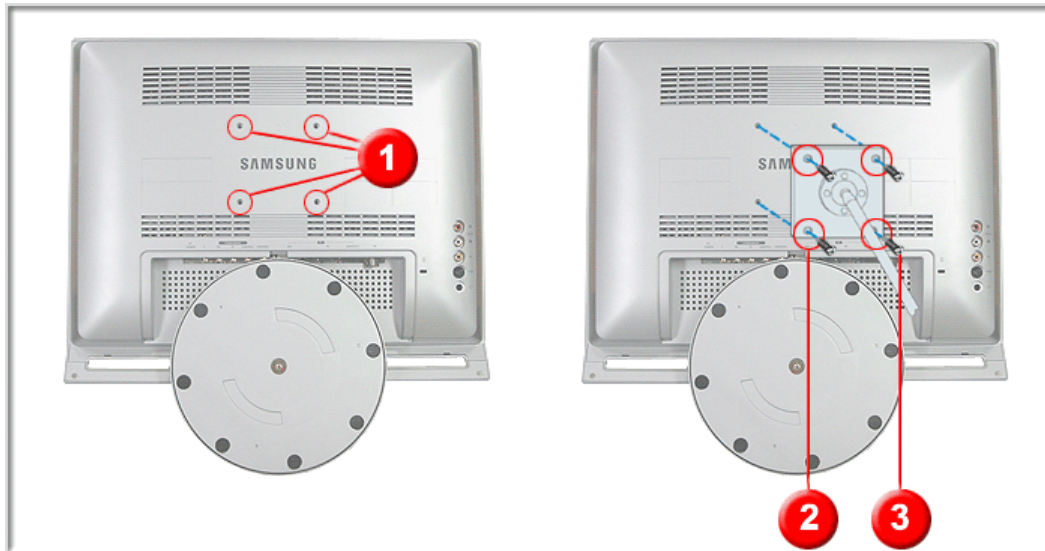

1. Turn off your monitor and unplug its power cord.
2. Lay the LCD monitor face-down on a flat surface with a cushion beneath it to protect the screen.
3. Align **the four bolt holes (1)** on the back of monitor with **the holes(2)** on the VESA base and then fasten the base with **the four bolts (3)** supplied.

Caution :The stand is made of aluminum. Keep it from getting nicked or scratched.

-  Only the supplied bolts should be used.

-  Samsung Electronics will not be responsible for damages caused by using a base other than those specified.

User Controls

 The control button configuration may vary slightly depending on the monitor model.

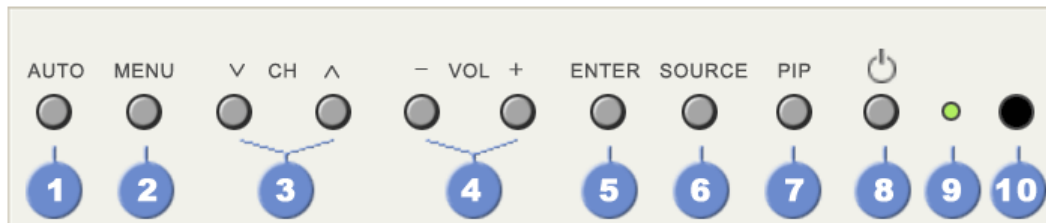

| Control Buttons |

 For more information on the screen adjustment functions, refer to [On-Screen Display](#).

1. **Auto**
Press to self-adjust to the incoming PC signal. The values of fine, coarse and position are adjusted automatically.
To make the automatic adjustment function sharper, execute the 'AUTO' function while the [AUTO PATTERN](#) is on. (Press [here](#) to view an animation about Auto Adjustment.)
2. **Menu**
Use this button to open the on-screen menu and exits from the menu screen or closes screen adjustment menu.
3. **▼ CH ▲**
Moves from one menu item to another vertically or adjusts selected menu values. In TV mode, selects TV channels. For more information, refer to Direct-Access Features > [Channel](#).
4. **– VOL +**
Moves from one menu item to another horizontally or adjusts selected menu values. Also adjusts the audio volume. For more information, refer to Direct-Access Features > [Volume](#).
5. **Enter**
Activate a highlighted menu item.
6. **Source**
Selects the Video source while the OSD is off.
7. **PIP**
Every time you push the button, the PIP window's signal source changes.
8. **Power**
Use this button to turn the monitor on and off. > [PowerSaver](#).
9. **Power indicator**
Lights up when you turn the power off.
10. **Remote Control Sensor**
Aim the remote control towards this spot on the Monitor

User Controls

| Remote Control Buttons |

 For more information on the screen adjustment functions, refer to [On-Screen Display](#).

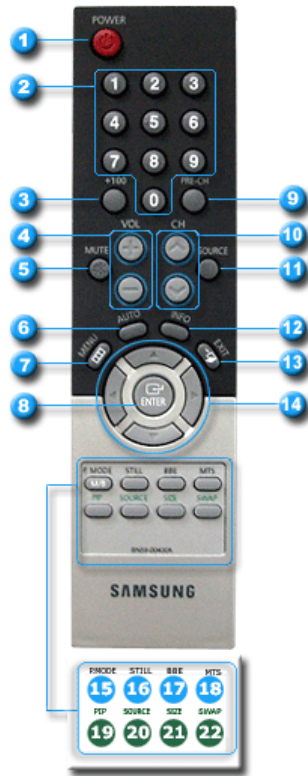

1. **POWER**
2. **Channel**
3. **+100**
4. **VOL**
5. **MUTE**
6. **AUTO**
7. **MENU**
8. **ENTER**
9. **PRE-CH**
10. **CH**
11. **SOURCE**
12. **INFO**
13. **EXIT**
14. **Up-Down Left-Right Buttons**
15. **P.MODE, M/B (MagicBright™)**
16. **STILL**
17. **BBE**
18. **MTS**
19. **PIP**
20. **SOURCE**
21. **SIZE**
22. **SWAP**

1. **POWER** ▲ Up

Use this button to turn the monitor on and off.

2. **Channel** ▲ Up

Selects TV channels in the TV mode. You may use this button in PIP mode as well.

3. **+100** ▲ Up

Press to select channels over 100.
For example, to select channel 121, press "+100", then press "2" and "1".

4. **VOL** ▲ Up

Also adjusts the audio volume. For more information, refer to Direct-Access Features > [Volume](#).

5. **MUTE** ▲ Up

Pauses (mutes) the audio output temporarily. Displayed on the lower left corner of the screen.
The audio resumes if Mute or VOL - / VOL + is pressed in the Mute mode.

6. **AUTO** ▲ Up

Adjusts the screen display automatically.

7. **MENU** ▲ Up

Use this button to open the on-screen menu and exits from the menu screen or closes screen adjustment menu.

8. **ENTER** ▲ Up

Activate a highlighted menu item.

User Controls

9. PRE-CH ▲Up

This button is used to return to the immediately previous channel.

10. CH ▲Up

In TV mode, selects TV channels.

For more information, refer to Direct-Access Features > [Channel](#)

11. SOURCE ▲Up

Push the button, Selects the Video source changes.

12. INFO ▲Up

Shows a video source, current channel number, picture mode, sound mode, Caption On/Off and V-chip On/Off on the upper right corner of the screen.

13. EXIT ▲Up

Exits from the menu screen. Exits from the PIP screen.

14. Up-Down , Left-Right Buttons ▲Up

Moves from one menu item to another horizontally, vertically or adjusts selected menu values.

15. P.MODE, M/B ▲Up

When you press this button, current sound mode is displayed on the lower center of the screen.

TV / AV / S-Video / DTV Mode : P.MODE(Picture Mode)

Then push button again to circle through available preconfigured modes.

(Movie → Dynamic → Standard → Custom)

PC / DVI Mode : M/B (MagicBright™)

Then push button again to circle through available preconfigured modes.

(Text → Internet → Entertain → Custom)

16. STILL ▲Up

When you press this button, current sound mode is displayed on the lower center of the screen.

Press the button once to freeze the screen. Press it again to unfreeze.

17. BBE (Barcus-Berry Electronics) ▲Up

Recreates the natural sound and improves sound clarity through boosting high and low range frequencies. As a result high sounds are clearer, brilliant and finely detailed while low sounds are tight, well-defined and harmonically rich.

18. MTS ▲Up

You can select the MTS (Multichannel Television Stereo) mode.

	Audio Type	MTS/S_Mode	Default
FM Stereo	Mono	Mono	Manual Change
	Stereo	Mono ↔ Stereo	
	SAP	Mono ↔ SAP	Mono

19. PIP ▲Up

Push the PIP button to PIP screen ON.

20. SOURCE ▲Up

Push the button, the PIP window's signal source changes.

21. SIZE ▲Up

Adjusts the PIP image size in PIP mode.

22. SWAP ▲Up

Swapping the contents of the PIP and main image. The image in the PIP window will appear on the main screen, and the main screen image will appear in the PIP window.

On-Screen Display

 Direct-Access Features let you display Monitor Adjustment Menu by simply pressing Auto button once. Or they are used to adjust monitor functions. You need to activate functions other than Auto Adjustment only when Auto-Access Features are off.

1. Auto (Use only PC mode)



The monitor display becomes more stabilized if adjusted by Auto Adjustment functions when the monitor is installed for the first time. Try Auto Adjustment before attempting Manual Adjustment. Ensure the clock frequency of the monitor matches that of the computer video card before carrying out Auto Adjustment.

When the **Auto** button is pressed, the monitor screen turns black and the Auto Adjustment screen appears as shown in the animated screen on the left.

 To make the automatic adjustment function sharper, execute the 'AUTO' function while the [AutoPattern.exe](#) is on.

On-Screen Display

2. Source



 Changing the source is allowed only for external devices that are connected to the monitor at the time.

Ex) **When there is no external device connected:**

[PC] → [DVI] → [TV]

When connected to S-Video:

[PC] → [DVI] → [TV] → [S-Video]

When connected to Component:

[PC] → [DVI] → [TV] → [Component]

On-Screen Display

3. Volume

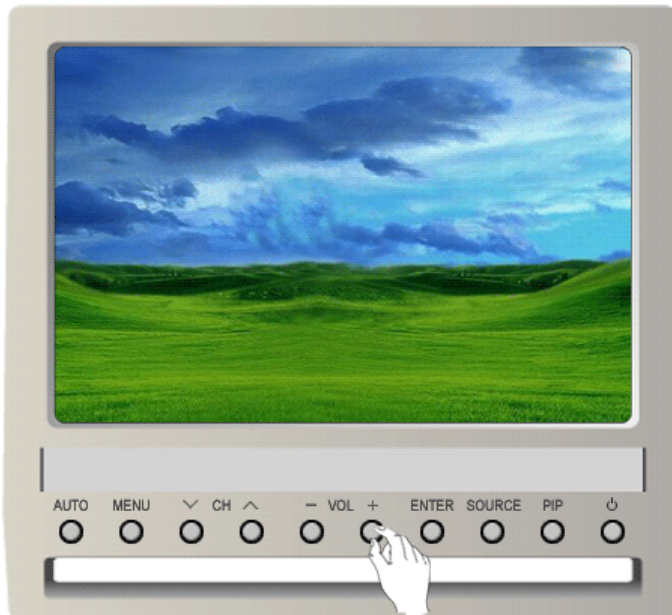

When OSD is not on the screen, push the **- VOL +** button to adjust volume.

1. Push the **-** button to decrease the volume.
2. Push the **+** button to increase the volume.

On-Screen Display

4. Channel



When OSD is not on the screen, push the **▼ CH ▲** button to select channel number.

1. Push the **▼** button to decrease the channel number.
2. Push the **▲** button to increase the channel number.

 This function is available in TV or PC + TV (PIP) mode only.

5. PIP



When OSD is not on the screen, push the PIP button to select PIP source.

 This function is available in PC + TV (PIP) or TV, AV, S-Video, Component + PC(PIP) mode only.

OSD Functions

1. Input Control

 For detailed information on Screen Adjustment in the Input Control, refer to [the Input Control Adjustment Animation Clips](#).



OSD	Description																																																	
Source List	<p>Use to select PC, TV or other external input source connected to the Monitor. Use to select the screen of your choice.</p> <ul style="list-style-type: none"> • PC • DVI • TV • AV • S-Video • Component 																																																	
PIP	<p>When external A / V devices such as VCRs or DVDs are connected to the monitor, PIP allows you to watch video from those devices in a small window super-imposed on the PC video signal. (On/Off)</p> <p>1) PIP</p> <ul style="list-style-type: none"> • ON/ Off : Turn the PIP Screen on or off. <p>2) Source</p> <ul style="list-style-type: none"> • TV / AV / S-Video / Component : PC Mode • PC / DVI : TV / AV / S-Video / Component Mode : Select the input source for the PIP. <p>PIP Settings</p> <table border="1"> <thead> <tr> <th>Main \ Sub</th> <th>PC</th> <th>DVI</th> <th>TV</th> <th>AV</th> <th>S-Video</th> <th>Component</th> </tr> </thead> <tbody> <tr> <td>PC</td> <td>X</td> <td>X</td> <td>O</td> <td>O</td> <td>O</td> <td>O</td> </tr> <tr> <td>DVI</td> <td>X</td> <td>X</td> <td>O</td> <td>O</td> <td>O</td> <td>O</td> </tr> <tr> <td>TV</td> <td>O</td> <td>O</td> <td>X</td> <td>X</td> <td>X</td> <td>X</td> </tr> <tr> <td>AV</td> <td>O</td> <td>O</td> <td>X</td> <td>X</td> <td>X</td> <td>X</td> </tr> <tr> <td>S-Video</td> <td>O</td> <td>O</td> <td>X</td> <td>X</td> <td>X</td> <td>X</td> </tr> <tr> <td>Component</td> <td>O</td> <td>O</td> <td>X</td> <td>X</td> <td>X</td> <td>X</td> </tr> </tbody> </table> <p>3) Swap : Swapping the contents of the PIP and main image. The image in the PIP window will appear on the main screen, and the main screen image will appear in the PIP window.</p> <p>4) Size : Changing the Size of the PIP window.</p>	Main \ Sub	PC	DVI	TV	AV	S-Video	Component	PC	X	X	O	O	O	O	DVI	X	X	O	O	O	O	TV	O	O	X	X	X	X	AV	O	O	X	X	X	X	S-Video	O	O	X	X	X	X	Component	O	O	X	X	X	X
Main \ Sub	PC	DVI	TV	AV	S-Video	Component																																												
PC	X	X	O	O	O	O																																												
DVI	X	X	O	O	O	O																																												
TV	O	O	X	X	X	X																																												
AV	O	O	X	X	X	X																																												
S-Video	O	O	X	X	X	X																																												
Component	O	O	X	X	X	X																																												

OSD Functions

1. Input Control



For detailed information on Screen Adjustment in the Input Control, refer to [the Input Control Adjustment Animation Clips](#).



OSD	Description
PIP	<p>5) Position : Changing the Position of the PIP window.</p> <p>6) Translucency Level • Opaque / High / Medium / Low : Adjusting the Translucency of PIP windows.</p> <p>7) Popup Timer This feature starts the PIP mode. A popup window appears which allows you to view the PIP window in full screen, view it in PIP size, or exit the PIP mode. To use this feature, first set the time using the "Setup Control" menu. (Make sure that the monitor clock is set.)</p>
Edit Name	<p>Name the input device connected to the input jacks to make your input source selection easier.</p> <p>• VCR / DVD / Cable STB / HD STB / Satellite STB / AV Receiver / DVD Receiver / Game / Camcorder / DVD Combo / DHR / PC</p>

OSD Functions

2. Picture Control

● PC Mode



For detailed information on Screen Adjustment in the Picture Control, refer to [the Picture Control Adjustment Animation Clips](#).

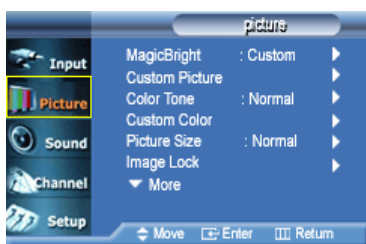

OSD	Description
MagicBright	<p>MagicBright is a new feature providing the optimum viewing environment depending on the contents of the image you are watching. Currently four different modes are available: Text, Internet, Entertain and Custom. Each mode has its own pre-configured brightness value. You can easily select one of four settings by simply pressing the MagicBright control button.</p> <p>1) Entertain : High Brightness For watching motion pictures such as a DVD or VCD.</p> <p>2) Internet : Medium Brightness For working with a mixture of images such as text and graphics.</p> <p>3) Text : Normal Brightness For documentations or works involving heavy text.</p> <p>4) Custom Although the values are carefully chosen by our engineers, the pre-configured values may not be comfortable to your eyes depending on your taste. If this is the case, adjust the Brightness and Contrast by using the OSD menu. Or push the (+) button when OSD screen is not on to access the Brightness control directly.</p>
Custom	<p>You can use the on-screen menus to change the contrast, and brightness according to personal preference.</p> <p>1) Contrast : Adjust the Contrast.</p> <p>2) Brightness : Adjust the Brightness.</p>
Color Tone	<p>The tone of the color can be changed. The individual color components are also user customizable.</p> <ul style="list-style-type: none"> • Cool / Normal / Warm / sRGB / Custom
Control	<p>1) Red 2) Green 3) Blue</p>
Size	<p>You can switch the Picture Size between Normal and Full size.</p> <ul style="list-style-type: none"> • Normal • Full

OSD Functions

2. Picture Control

● **PC Mode**



For detailed information on Screen Adjustment in the Picture Control, refer to [the Picture Control Adjustment Animation Clips](#).

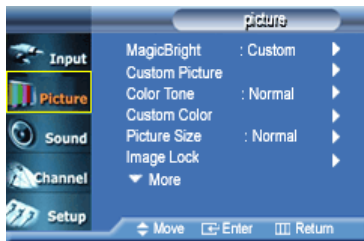

OSD	Description
Image Lock	<p>Image Lock is used to fine tune and get the best image by removing noises that creates unstable images with jitters and shimmers. If satisfactory results are not obtained using the Fine adjustment, use the Coarse adjustment and then use Fine again.</p> <p>1) Coarse : Removes noise such as vertical stripes. Coarse adjustment may move the screen image area. You may relocate it to the center using the Horizontal Control menu.</p> <p>2) Fine : Removes noise such as horizontal stripes. If the noise persists even after Fine tuning, repeat it after adjusting the frequency (clock speed).</p> <p>3) Position : Adjusts the screen location horizontally and vertically.</p>
Auto Adjustment	The values of Fine, Coarse and Position are adjusted automatically.
PIP Picture	<p>You can adjust the PIP Screen Settings.</p> <p>1) Contrast : Adjusts the Contrast of the PIP window on the screen.</p> <p>2) Brightness : Adjusts the Brightness of the PIP window on the screen.</p> <p>3) Sharpness : Use to adjust the difference between the lightest and darkest areas of the PIP window.</p> <p>4) Color : Use to adjust the lightness/darkness on the PIP window.</p> <p>5) Tint : Use to add a natural tone to the PIP window.</p>

OSD Functions

● TV / AV / S-Video / Component Mode

 For detailed information on Screen Adjustment in the Picture Control, refer to [the Picture Control Adjustment Animation Clips](#).



OSD	Description
Mode	<p>The Monitor has four automatic picture settings ("Custom", "Dynamic", "Standard", and "Movie") that are preset at the factory. You can activate either Custom, Dynamic, Standard, or Movie. You can select "Custom" which automatically recalls your personalized picture settings.</p> <ul style="list-style-type: none"> • Dynamic • Standard • Movie • Custom
Custom	<p>You can use the on-screen menus to change the contrast, and brightness according to personal preference.</p> <ol style="list-style-type: none"> 1) Contrast : Adjusts the Contrast. 2) Brightness : Adjusts the Brightness. 3) Sharpness : Use to adjust the difference between the lightest and darkest areas of the display. 4) Color : Use to adjust the lightness/darkness of the display. 5) Tint : Use to add a natural tone to the display.
Color Tone	<p>The tone of the color can be changed. The individual color components are also user customizable.</p> <ul style="list-style-type: none"> • Cool2 / Cool1 / Normal / Warm1 / Warm2
Size	<p>You can switch the Picture Size.</p> <ul style="list-style-type: none"> • Wide • Normal • Parnorama • Zoom1 • Zoom2

OSD Functions

● TV / AV / S-Video / Component Mode

 For detailed information on Screen Adjustment in the Picture Control, refer to [the Picture Control Adjustment Animation Clips](#).



OSD	Description
DNle	<p>- Digital Natural Image engine Samsung's new technology brings you more detailed images with contrast and white enhancement and 3D noise reduction. A New image compensation algorithm gives brighter, clearer, images to our customers. DNle technology will match every signal to your eyes.</p> <p>1) Off : Switches off the DNle mode.</p> <p>2) Medium : Switches on the DNle mode.</p> <p>3) High : The screen is clearer than in Medium.</p> <p>4) Demo : The screen before applying DNle appears on the right and the screen after applying DNle appears on the left.</p>
Digital NR	<p>- Digital Noise Reduction. You can turn the Noise Elimination feature On/Off. The Digital Noise Elimination feature allows you to enjoy clearer and crisper images.</p> <p>• On /Off</p>
Film Mode	<p>You can turn Film Mode On/Off. The Film Mode feature offers you a theater-quality viewing experience.</p> <p>• On /Off</p>
Fleshtone	<p>You can turn the Skin Tone feature On/Off. The Skin Tone feature adjusts the color level to achieve accurate skin tones.</p> <p>• On /Off</p>
PIP Custom Picture	<p>You can adjust the PIP Screen Settings.</p> <p>1) Contrast : Adjusts the Contrast of the PIP window on the screen.</p> <p>2) Brightness : Adjusts the Brightness of the PIP window on the screen.</p>

OSD Functions

 For detailed information on Screen Adjustment in the Sound Control, refer to [the Sound Control Adjustment Animation Clips](#).



OSD	Description
Mode	The Monitor has a built-in high fidelity stereo amplifier. 1) Standard : Choose Standard for the standard factory settings. 2) Music : Choose Music when watching music videos or concerts. 3) Movie : Choose Movie when viewing movies. 4) Speech : Choose Speech when watching a show that is mostly dialogue (i.e., news). 5) Custom : Choose Custom if you want to adjust the settings according to personal preference.
Custom	The sound settings can be adjusted to suit your personal preference. 1) Bass : Emphasize low frequency audio. 2) Treble : Emphasize high frequency audio. 3) Balance : Allows you to adjust the sound balance between the left and right speakers.
BBE	BBE (Barcus-Berry Electronics) recreates the natural sound and improves sound clarity through boosting high and low range frequencies. As a result high sounds are clearer, brilliant and finely detailed while low sounds are tight, well-defined and harmonically rich. • On /Off
Dolby Virtual	Dolby Virtual Sound On/Off (Dolby Virtual simulates the effect of the Dolby Surround sound system, recreating the movie-theatre or concert-hall- quality sound.) • On /Off
MTS	You can select the MTS (Multichannel Television Stereo) mode. - Available in TV Mode Only • Mono, Stereo, SAP (Separate Audio Program) Set 'MTS Setting' to ON to choose Mono, Stereo or SAP.
Auto Volume	Reduces the differences in volume level among broadcasters. • On /Off
Sound Select	You can select either Main or PIP when PIP is On. • Main / PIP

OSD Functions

4. Channel Control



The channel change function is available only in TV mode or when the PIP feature is ON in PC mode and the PIP source is set to TV. (You can change the channel in PC mode when the PIP feature is ON.)

For detailed information on Screen Adjustment in the Channel Control, refer to [the Channel Control Adjustment Animation Clips](#).



OSD	Description
Air/CATV	The channel system can be set in several different ways. <ul style="list-style-type: none"> • Air • STD • HRC • IRC STD, HRC, IRC and Air identify various types of cable TV systems. Contact your local cable company to identify the type of cable system that exists in your particular area.
Auto Program	The TV automatically cycles through all of the available channels and stores them in memory. This takes about one to two minutes. In rare cases, "Auto program" may miss a few channels due to weak signals and the channels may not be added to the channel memory.
Add/Delete	Adds or erases channels from the memory.
Fine Tune	Due to weak signals or an incorrect antenna configuration, some of the channels may not be tuned correctly.

OSD Functions

5. Setup Control



For detailed information on Screen Adjustment in the Setup Control, refer to [the Setup Control Adjustment Animation Clips](#).



OSD	Description
Time	Setting the clock is necessary in order to use the various timer features of the Monitor. 1) Clock Set : Current Time Setting. 2) Sleep Timer : Use to set the Monitor to turn off automatically a set number of minutes. (30 min, 60 min, 90 min, 120 min, 150 min, 180 min) 3) On Timer : Use to set the Monitor to turn on automatically at a preset time. 4) Off Timer : Use to set the monitor to turn off automatically at a preset time.
V-Chip	Protects children from viewing inappropriate programs by blocking certain broadcast or video programs. (More Information)
Caption	Enable or disable the Caption feature and set the appearance of closed caption text. 1) Caption : On / Off 2) Caption Mode 3) Channel 4) Field
Language	You can choose one of 4 languages. • English, French, Spanish, Português Note : The language chosen affects only the language of the OSD. It has no effect on any software running on the computer.
Blue Screen	If no signal is being received or the signal is very weak, a blue screen automatically replaces the noisy picture background. If you wish to continue viewing the poor picture, you must set the "Blue screen" mode to "Off". • On / Off
Translucency Level	Change the translucency of the background of the OSD. • Opaque / High / Medium / Low
Reset	Picture parameters are replaced with the factory default values. 1) Image Reset 2) Color Reset

Check before calling for service

 Check the following items yourself before calling for service. Contact the [service center](#) for problems that you cannot solve by yourself.

1. Self-Test Feature Check

Your monitor provides a self test feature that allows you to check whether your monitor is functioning properly.

1. Turn off both your computer and the monitor.
2. Unplug the video cable from the back of the computer.
3. Turn on the monitor.

The figure shown below ("Check Signal Cable") appears on a black background when the monitor is in its normal working condition though it does not sense any video signal: While in the Self-Test mode, the LED power indicator remains green and the figure moves around on the screen.



Failure of any of the boxes to appear indicates a problem with your monitor. This box also appears during normal operation if the video cable becomes disconnected or damaged.

4. Turn off your monitor and reconnect the video cable; then turn on both your computer and the monitor.

If your monitor screen remains blank after using the previous procedure, check your video controller and computer system; **your monitor is functioning properly.**

2. Not Optimum Mode

This indicates the display resolution or refresh rate is not properly set on your computer video card. Reboot the computer in Safe Mode and select "Default" in the "Refresh Rate Unknown" box while setting Adapter for Display Properties.

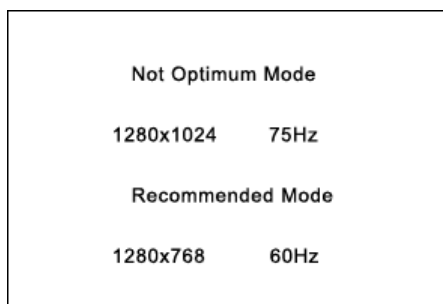

 **Contact the computer dealer or manufacturer for information on Safe Mode Booting.**

 Refer to Specifications > [Preset Timing Modes](#) for the resolutions or frequencies that are supported by the monitor.

Check before calling for service

3. Display Adapter Driver

 Display adapter refers to the computer video card driver. If the adapter is not properly set, you cannot adjust resolution, frequency or color and you cannot install the monitor driver.

1. Checking Adapter Driver

Click Start → Settings → Control Panel → Display → Settings → Advanced Adapter.

If "Default" or a wrong product model is indicated, it means that the adapter driver is not properly installed. Install the adapter driver again according to the information provided by the computer or video card manufacturers.

2. Installing Adapter Driver

 The instructions given below are for general circumstances. For specific issues, contact the relevant computer or video card manufacturers.

1) Click Start → Settings → Control Panel → Display → Settings → Advanced Adapter → Update Driver → Next → Display a list of the known drivers for this device so that I can choose a specific driver → Next → Have Disk (Insert Video Card Driver diskette) → OK → Next → Next → Finish.

2) In case you have Adapter Driver Setup file on your computer:
Run Setup.exe or Install.exe, which is found in the Adapter Driver Setup file.

4. Maintenance

1. Maintaining the Monitor Case

Clean with a soft cloth after disconnecting the power cord.

2. Maintaining the Flat Panel Display Screen

Clean with a soft cloth (cotton flannel) smoothly.



- Do not use benzene, thinner or other flammable substances, or a wet cloth.
- We recommend a Samsung cleansing agent is used to prevent damage to the screen.



- Never use acetone, benzene or thinner. (They may cause flaws or deformation of the screen surface.)
- The user will be required to pay costs and related expenses for repair of damages caused by him/her.

5. Symptoms and Recommended Actions

 A monitor recreates visual signals received from the PC. Therefore, if there is trouble with the PC or the video card, this can cause the monitor to become blank, have poor coloring, noise, Video mode not supported, etc. In this case, first check the source of the problem, and then contact a [service center or your dealer](#).

1. Check if the power cord and the cable are properly connected to the computer.
2. Check if the computer beeps more than 3 times when booting.
(If it does, request an after-service for the main board of the computer.)
3. If you installed a new video card or if you assembled the PC, check if you installed the adapter (video) driver and the monitor driver.
4. Check if the scanning ratio of the video screen is set at 75Hz or 85Hz.
(Do not exceed 60Hz when using the maximum resolution.)
5. If you have problems in installing the adapter (video) driver, boot the computer in Safe Mode, remove the Display Adapter at the "**Control Panel, System, Device Administrator**" and then reboot the computer to reinstall the adapter (video) driver.

Problems and Solutions

 The following table lists possible problems and their solutions. Before calling for service, check the information in this section to see if you can remedy any problems yourself. If you do need assistance, please call the phone number on the warranty card, [the phone number on the Information section](#) or [contact your dealer](#).

[Installation](#) | [Screen](#) | [Audio](#) | [Remote Control](#)

1. Problems related to Installation

 Problems related to the monitor installation and their solutions are listed.

Problems	Solutions
It appears the PC does not function normally.	<ul style="list-style-type: none"> Check if the Display Adapter Driver (VGA Driver) is properly installed. (Refer to Installing Driver)
The monitor screen flickers.	<ul style="list-style-type: none"> Check if the signal cable between the computer and the monitor is securely connected and tightened. (Refer to Connecting to a Computer)
TV screen is blurred or shows noise signals.	<ul style="list-style-type: none"> Check if the TV antenna connector is securely connected to the external antenna. (Refer to Connecting to TV)
TV signal is not received	<ul style="list-style-type: none"> Check "Channel system" and make sure you choose the correct channel system. (Refer to the Channel System) Select "Channel auto program" to configure the channel system automatically. (Refer to the Auto Program)
Strange characters appear on the screen.	<ul style="list-style-type: none"> Switch "Caption On" to "Caption Off" if strange characters appear on the TV screen. (Refer to Caption)

2. Problems related to Screen

 Problems related to the monitor screen and their solutions are listed.

Problems	Solutions
Screen is blank and power indicator is off	<ul style="list-style-type: none"> Ensure that the power cord is firmly connected and the LCD monitor is on. (Refer to the Connecting Your Monitor)
"Check Signal Cable" message	<ul style="list-style-type: none"> Ensure that the signal cable is firmly connected to the PC or video sources. (Refer to the Connecting Your Monitor) Ensure that the PC or video sources are turned on.
"Video mode not supported" message	<ul style="list-style-type: none"> Check the maximum resolution and the frequency of the video adaptor. Compare these values with the data in the Preset Timing Modes Chart.
Picture rolls vertically.	<ul style="list-style-type: none"> Check if the signal cable is securely connected. Connect it again securely. (Refer to Connecting to a Computer)
Image is not clear. Picture is blurred.	<ul style="list-style-type: none"> Run Frequency Coarse and Fine tuning. Turn on again after removing all accessories (video extension cable, etc.) Set resolution and frequency to the recommended ranges. 17 inch wide model (1280 x 768 @ 60Hz)
Picture image is unstable and	<ul style="list-style-type: none"> Check if the resolution and frequency set for the computer

Problems and Solutions

3. Problems related to Audio

 Problems related to audio signals and their solutions are listed below.

Problems	Solutions
vibrates.	video card falls in the range supported by the monitor. If not, reset them referring to the current Information under the monitor menu and Preset Timing Modes .
Ghost images are shown in the picture.	
The image is too light or too dark	<ul style="list-style-type: none"> Adjust the Brightness and Contrast. (Refer to the Brightness, Contrast)
Screen color is inconsistent.	<ul style="list-style-type: none"> Adjust color using Custom Color under OSD Color Adjustment menu.
Color image is distorted with dark shadows.	
White color is poor.	
Power Indicator blinks green.	<ul style="list-style-type: none"> The monitor is currently saving the changes made in settings to the OSD memory.
Screen is blank and power indicator light is steady green or blinks every 0.5 or 1 seconds	<ul style="list-style-type: none"> The monitor is using its power management system. Move the computer's mouse or press a key on the keyboard

3. Problems related to Audio

 Problems related to audio signals and their solutions are listed below.

Problems	Solutions
No sound	<ul style="list-style-type: none"> Ensure that the audio cable is firmly connected to both the audio-in port on your monitor and the audio-out port on your sound card. (Refer to the Connecting Your Monitor) Check the volume level. (Refer to the Volume)
Sound level is too low.	<ul style="list-style-type: none"> Check the volume level. (Refer to the Volume) If the volume is still too low after turning the control to its maximum, check the volume control on the computer sound card or software program.
Sound is too high pitched or too low pitched	<ul style="list-style-type: none"> Adjust the Treble and Bass to appropriate level.

4. Problems related to Remote Control

 Problems related to the remote control and their solutions are listed.

Problems	Items to check
The remote control buttons do not respond.	<ul style="list-style-type: none"> Check the battery polarities (+/-). Check if the batteries have been exhausted. Check if the power is on. Check if the power cord is securely connected. Check if a special fluorescent or neon lamp is on in the vicinity.

Q & A

 Frequently asked questions are summarized here for your reference.

Question	Answer
How can I change the frequency?	<p>Frequency can be changed by reconfiguring the video card.</p> <p>Note that video card support can vary, depending on the version of the driver used. (Refer to the computer or the video card manual for details.)</p>
How can I adjust the resolution?	<p>Windows XP: Reset resolution by clicking Control Panel → Appearance & Theme → Display → Settings.</p> <p>Windows ME/2000: Set the resolution at the Control Panel → Display → Settings.</p> <p>* Contact the video card manufacturer for details.</p>
How can I set the Power Saving function?	<p>Windows XP: Reset Power Saving parameters by clicking Control Panel → Appearance & Theme → Display → Screen Saver or in the computer BIOS SETUP. (Refer to Windows/Computer Manual)</p> <p>Windows ME/2000: Set the function at BIOS-SETUP of the computer or the screen saver. (Refer to Windows/Computer Manual).</p>
How can I clean the outer case/LCD Panel?	<p>Disconnect the power cord and then clean the monitor with a soft cloth, using either a cleaning solution or plain water.</p> <p>Do not leave any remains of the detergent nor scratch the case. Do not allow any water to go inside the monitor.</p>

General Specifications

 Design and specifications are subject to change without prior notice.

General	
Model Name	SyncMaster 173MW
LCD Panel	
Size	17.0 inch (Diagonal)
Display area	370.56 (H) x 222.336 (V)
Pixel Pitch	0.2895 (H) x 0.2895 (V)
Type	a-si TFT active matrix
Synchronization	
Horizontal	30 ~ 61 kHz
Vertical	56 ~ 75 Hz
Display Color	
16,194,277 Colors	
Resolution	
Optimum resolution	1280 x 768@60Hz
Maximum resolution	1280 x 768@60Hz
Input Signal, Terminated	
RGB Analog , DVI Compliant Digital RGB. 0.7Vp-p Positive at 75 ohms Separate H/V sync, Composite H/V sync, TTL level, positive or negative	
TV / Video	
Operating system	NTSC-M
Sound Operating system	BTSC, A2-Korea, EIAJ
Maximum Pixel Clock	
81 MHz	
Power Supply	
90 to 264 VAC, 60/50Hz ± 3Hz	
Signal Cable	
15pin to 15pin D-sub cable, Detachable DVI-D to DVI-D cable, Detachable (option)	
Power Consumption	
Less than 49W	
Dimensions / Weight (WxDxH)	
430.6 x 210.0 x 391.4 mm / 6.15 kg (With Stand)	
430.6 x 58.0 x 362.1 mm (Without Stand)	
Audio Characteristics	
MAX Internal Speaker Out	5W (channel) x 2 (output level : 2.5 W ~ 3.5 W)
Headphone out	RF : 5mW max (400m Vrms) A / V : 10mW max (580 Vrms), Max Input sound : -9dBm
Output Frequency	RF : 100Hz ~ 15kHz A / V : 100Hz ~ 15kHz

General Specifications

Environmental considerations	
Operating	Temperature : 50°F ~ 104°F(10°C ~ 40°C) Humidity : 10% ~ 80%, non-condensing
Storage	Temperature : -4°F ~113°F (-20°C ~ 45°C) Humidity : 5% ~ 95%, non-condensing
Plug and Play Capability	
This monitor can be installed on any Plug & Play compatible system. Interaction of the monitor and computer systems will provide the best operating conditions and monitor settings. In most cases, monitor installation will proceed automatically, unless the user wishes to select alternate settings.	
Dot Acceptable	
TFT LCD panel manufactured by using advanced semiconductor technology with precision of 99.999% above is used for this product. But the pixels of RED, GREEN, BLUE and WHITE color seem to be bright sometimes or some of black pixels could be seen. This is not from bad quality and you can use it without uneasiness.	
The number of TFT LCD pixels :	17 inch wide: 2,949,120

PowerSaver



This monitor has a built-in power management system called PowerSaver. This system saves energy by switching your monitor into a low-power mode when it has not been used for a certain amount of time. The monitor automatically returns to normal operation when you move the computer's mouse or press a key on the keyboard. For energy conservation, turn your monitor OFF when it is not needed, or when leaving it unattended for long periods. The PowerSaver system operates with a VESA DPMS compliant video card installed in your computer. Use a software utility installed on your computer to set up this feature.

State	Normal Operation	Power saving mode EPA/ENERGY 2000	Power off
Power Indicator	Green	Green, Blinking	Black
Power Consumption	Less than 49W	Less than 2W (off mode)	Less than 1W (at 110Vac)



This monitor is EPA ENERGY STAR® compliant and ENERGY2000 compliant when used with a computer equipped with VESA DPMS functionality. As an ENERGY STAR® Partner, SAMSUNG has determined that this product meets the ENERGY STAR® guidelines for energy efficiency.

Preset Timing Modes

 If the signal transferred from the computer is the same as the following Preset Timing Modes, the screen will be adjusted automatically. However, if the signal differs, the screen may go blank while the power LED is on. Refer to the video card manual and adjust the screen as follows.

Preset Timing Modes

Display Mode	Horizontal Frequency (kHz)	Vertical Frequency (Hz)	Pixel Clock (MHz)	Sync Polarity (H/V)
MAC, 640 x 480	35.000	66.667	30.240	-/-
MAC, 832 x 624	49.726	74.551	57.284	-/-
IBM, 640 x 350	31.469	70.086	25.175	+/-
IBM, 640 x 480	31.469	59.940	25.175	-/-
IBM, 720 x 400	31.469	70.087	28.322	-/+
VESA, 640 x 480	37.500	75.000	31.500	-/-
VESA, 640 x 480	37.861	72.809	31.500	-/-
VESA, 800 x 600	35.156	56.250	36.000	+,-/+,-
VESA, 800 x 600	37.879	60.317	40.000	+/+
VESA, 800 x 600	46.875	75.000	49.500	+/+
VESA, 800 x 600	48.077	72.188	50.000	+/+
VESA, 1280 x 768	47.396	60.000	68.250	+/+
VESA, 1280 x 768	47.363	60.004	65.000	-/-
VESA, 1024 x 768	56.476	70.069	75.069	-/-
VESA, 1024 x 768	60.023	75.029	78.750	+/+

Table 2. NTSC Broadcasting Systems

Color System	Sound System	Stereo System	Channel System	Countries
NTSC	M	A2	US	Korea
		BTSC (SAP)	US	USA, Canada, Chile, Venezuela, Cuba, Colombia, Jamaica, Mexico, Panama, Peru, Philippines, Puerto-Rico, Taiwan
		EIAJ	Japan	Japan



Horizontal Frequency

The time to scan one line connecting the right edge to the left edge of the screen horizontally is called Horizontal Cycle and the inverse number of the Horizontal Cycle is called Horizontal Frequency. Unit: kHz

Vertical Frequency

Like a fluorescent lamp, the screen has to repeat the same image many times per second to display an image to the user. The frequency of this repetition is called Vertical Frequency or Refresh Rate. Unit: Hz

Service Center

- **U.S.A. :**
Samsung Computer Products Customer Service
400 Valley Road, Suite 201, Mt. Arlington, NJ 07856
Tel. : (973)601-6000, 1-800-SAMSUNG (1-800-726-7864)
Fax. : (973)601-6001
<http://www.samsungusa.com/monitor/>
- **BRAZIL :**
Samsung Eletronica da Amazonia Ltda.
R. Prof. Manoelito de Ornellas, 303, Terro B
Chacara Sto. Antonio, CEP : 04719-040
Sao Paulo, SP
SAC : 0800 124 421
<http://www.samsung.com.br/>
- **CANADA :**
Samsung Electronics Canada Inc.
7037 Financial Drive
Mississauga, Ontario L5N 6R3
Tel. : 1-800-SAMSUNG (1-800-726-7864)
Fax. : (905) 542-1199
<http://www.samsung.ca/>
- **COLOMBIA :**
Samsung Electronics Colombia
Cra 9 No 99A-02 Of. 106
Bogota, Colombia
Tel.: 9-800-112-112
Fax: (571) 618 - 2068
<http://www.samsung-latin.com/>
e-mail : soporte@samsung-latin.com
- **PANAMA :**
Samsung Electronics Latinoamerica(Z.L.) S.A.
Calle 50 Edificio Plaza Credicorp, Planta Baja
Panama
Tel. : (507) 210-1122, 210-1133
Tel : 800-3278(FAST)
<http://www.samsung-latin.com/>
- **PERU**
Servicio Integral Samsung
Av.Argentina 1790 Lima1. Peru
Tel: 51-1-336-8686
Fax: 51-1-336-8551
<http://www.samsungperu.com/>
- **GERMANY :**
TELEPLAN Rhein-Main GmbH
Feldstr. 16
64331 Weiterstadt
T. 06151/957-1306
F. 06151/957-1732
* EURO 0,12/MIN.
<http://www.samsung.de/>
- **AUSTRALIA :**
Samsung Electronics Australia Pty Ltd.
Customer Response Centre
7 Parkview Drive, Homebush Bay NSW 2127
Tel : 1300 362 603
<http://www.samsung.com.au/>
- **ITALY :**
Samsung Electronics Italia S.p.a.
Via C. Donat Cattin, 5
20063 Cernusco s/Naviglio (MI)
Servizio Clienti: 199.153.153
<http://www.samsung-italia.com/>
- **ESPAÑA :**
Samsung Electronics Comercial Iberica, S.A.
Ciencias, 55-65 (Poligono Pedrosa) 08908
Hospitalet de Llobregat (Barcelona)
Tel. : (93) 261 67 00
Fax. : (93) 261 67 50
<http://samsung.es/>
- **United Kingdom :**
Samsung Electronics (UK) Ltd.
Samsung House, 225 Hook Rise South
Surbiton, Surrey KT6 7LD
Tel. : (0208) 391 0168
Fax. : (0208) 397 9949
< European Service Center & National Service >
Stafford Park 12 Telford, Shropshire, TF3 3BJ
Tel. : (0870) 242 0303
Fax. : (01952) 292 033
<http://samsungservice.co.uk/>
- **THAILAND :**
HAI SAMSUNG SERVICE CENTER
MPA COMPLEX BUILDING,1st-2nd Floor
175 SOI SUEKSA VIDHAYA SATHON SOI 12
SILOM ROAD ,SILOM,BANGRAK
BANGKOK 10500
TEL : 0-2635-2567
FAX : 0-2635-2556
- **SOUTH AFRICA :**
Samsung Electronics,5 Libertas Road, Somerset Office Park,
Bryanston Ext 16. Po Box 70006, Bryanston,2021, South Africa
Tel : 0027-11-549-1621
Fax : 0027-11-549-1629
<http://www.samsung.co.za/>
- **UKRAINE :**
SAMSUNG ELECTRONICS REPRESENTATIVE OFFICE IN UKRAINE
4 Glybochitska str.
Kiev, Ukraine
Tel. 8-044-4906878
Fax 8-044-4906887
Toll-free 8-800-502-0000
<http://www.samsung.com.ua/>
- **SWEDEN/DENMARK/NORWAY/FINLAND :**
Samsung Electronics AB
Box 713
S-194 27 UPPLANDS VÄSBY
SVERIGE
Besöksadress : Johanneslundsvägen 4
Samsung support Sverige: 020-46 46 46
Samsung support Danmark : 8088-4646
Samsung support Norge: 8001-1800
Samsung support Finland: 0800-118001
Tel +46 8 590 966 00
Fax +46 8 590 966 50
<http://www.samsung.se/>
- **HUNGARY :**
Samsung Electronics Magyar Rt.
1039, Budapest, Lehel u. 15-17.
Tel: 36 1 453 1100
Fax: 36 1 453 1101
<http://www.samsung.hu/>
- **FRANCE :**
SAMSUNG ELECTRONICS FRANCE Service
Paris Nord 2
66 rue des Vanesses
BP 50116 Villepinte
95950 Roissy CDG Cedex
Tel : 08 25 08 65 65
Fax : 01 48 63 06 38
<http://www.samsungservices.com/>
- **PORTUGAL :**
SAMSUNG ELECTRONICA PORTUGUESA S.A.
Rua Mário Dioniso, N^o2 - 1^o Drt. 2795-140 LINDA-A-VELHA
Tel. 214 148 114/100 Fax. 214 148 133/128
Free Line 800 220 120
<http://www.samsung.pt/>

Service Center

● **CHILE :**

SONDA S.A.

Teatinos 550, Santiago Centro, Santiago, Chile

Fono: 56-2-5605000 Fax: 56-2-5605353

56-2-800200211

<http://www.sonda.com/>

<http://www.samsung.cl/>

● **MEXICO :**

SAMSUNG ELECTRONICS MEXICO. S.A. DE C.V.

Saturno NO.44, Col. Nueva Industrial Vallejo

Gustavo A.Madero C.P.07700, Mexico D.F. Mexico

TEL. 52-55-5747-5100

Fax. 52-55-47 52 02

RFC: SEM950215S98

<http://www.samsung.com.mx/>

IMPORTADO POR: SAMSUNG ELECTRONICS MEXICO. S.A. DE C.V.

Saturno NO.44, Col. Nueva Industrial Vallejo

Gustavo A.Madero C.P.07700, Mexico D.F. Mexico

TEL. 52-55-5747-5100

EXPORTADO POR: Samsung Electronics CO.,LTD.

416, Mae tan-3dong, Yeoungtong-Gu,

Suwon City, Kyoungki-Do Korea

Terms

- **Sync Signal**

Sync (Synchronized) Signals refer to the standard signals that are required to display desired colors on the monitor. They are divided into Vertical and Horizontal Sync Signals. These signals display normal color images by the set resolution and frequency.

Types of Sync Signals

Separate	This is a scheme of transmitting individual vertical sync signals to the monitor.
Composite	This is a scheme of combining vertical sync signals into one composite signal and transmitting it to the monitor. The monitor displays the color signals by separating the composite signal into original color signals.
Sync On Green	This scheme does not use sync signals. Instead, it combines horizontal and vertical sync signals into a Green signal and transmits to the monitor. It is mainly used for workstations.

- **Dot Pitch**

The image on a monitor is composed of red, green and blue dots. The closer the dots, the higher the resolution. The distance between two dots of the same color is called the 'Dot Pitch'. Unit: mm

- **Vertical Frequency**

The screen must be redrawn several times per second in order to create and display an image for the user. The frequency of this repetition per second is called Vertical Frequency or Refresh Rate. Unit: Hz

Example: If the same light repeats itself 60 times per second, this is regarded as 60 Hz. In this case, flickering of the screen can be detected. To avoid this problem, there is a Flicker-free Mode using a vertical frequency over 70 Hz.

- **Horizontal Frequency**

The time to scan one line connecting the right edge to the left edge of the screen horizontally is called Horizontal Cycle. The inverse number of the Horizontal Cycle is called Horizontal Frequency. Unit: kHz

- **Interlace and Non-Interlace Methods**

Showing the horizontal lines of the screen from the top to the bottom in order is called the Non-Interlace method while showing odd lines and then even lines in turn is called the Interlace method. The Non-Interlace method is used for the majority of monitors to ensure a clear image. The Interlace method is the same as that used in TVs.

- **Plug & Play**

This is a function that provides the best quality screen for the user by allowing the computer and the monitor to exchange information automatically. This monitor follows the international standard VESA DDC for the Plug & Play function.

- **Resolution**

The number of horizontal and vertical dots used to compose the screen image is called 'resolution'. This number shows the accuracy of the display. High resolution is good for performing multiple tasks as more image information can be shown on the screen.

Example: If the resolution is 1024 X 768, this means the screen is composed of 1024 horizontal dots (horizontal resolution) and 768 vertical lines (vertical resolution).

- **A2**

This system uses two carriers to transmit voice data. Countries such as South Korea and Germany use this system.

- **BTSC**

Broadcast Television System Committee

The stereo broadcasting system that is used in most of the countries that have adopted the NTSC system, including the United States, Canada, Chile, Venezuela and Taiwan. It also refers to the organization that has been organized to promote its development and management.

- **EIAJ**

Electronic Industries Association of Japan.

- **RF Cable**

A round signal cable generally used for TV antennas.

- **Satellite Broadcasting**

Broadcasting service provided via satellite. Enables high picture quality and clear sound throughout the country regardless of the location of the viewer.

Terms

- **Sound Balance**

Balances the levels of the sound coming from each speaker in televisions with two speakers.

- **Cable TV**

Whereas the terrestrial broadcasting is delivered via frequency signals through the air, cable broadcasting is transmitted via a cable network. In order to view cable TV, one must purchase a cable receiver and hook it up to the cable network.

- **CATV**

"CATV" refers to the broadcasting service offered at hotels, schools and other buildings through their own broadcasting system, apart from VHF or UHF broadcasting by terrestrial broadcasters. The CATV programs may include movies, entertainment and educational programs. (Different from cable TV.)

CATV can be viewed only within the area in which the CATV service is offered.

- **S-Video**

Short for "Super Video." S-Video allows up to 800 lines of horizontal resolution, enabling high-quality video.

- **VHF/UHF**

VHF indicates TV channels 2 to 13, and UHF indicates channels 14 through 69.

- **Channel Fine Tuning**

This feature allows the viewer to fine-tune the TV channel to obtain the best viewing conditions. The Samsung Monet TV has both automatic and manual channel fine-tuning features to enable the viewer to adjust their desired settings.

- **External Device Input**

External device input refers to video input from such external video devices as VCRs, camcorders and DVD players, separate from a TV broadcast.

Regulatory

● FCC Information

User Instructions

The Federal Communications Commission Radio Frequency Interference Statement includes the following warning:

Note: This equipment has been tested and found to comply with the limits for a Class B digital device, pursuant to Part 15 of the FCC Rules. These limits are designed to provide reasonable protection against harmful interference in a residential installation. This equipment generates, uses, and can radiate radio frequency energy and, if not installed and used in accordance with the instructions, may cause harmful interference to radio communications. However, there is no guarantee that interference will not occur in a particular installation. If this equipment does cause harmful interference to radio or television receptions, which can be determined by turning the equipment off and on, the user is encouraged to try to correct the interference by one or more of the following measures:

- Reorient or relocate the receiving antenna.
- Increase the separation between the equipment and receiver.
- Connect the equipment into an outlet on a circuit different from that to which the receiver is connected.
- Consult the dealer or an experienced radio/TV technician for help.

User Information

Changes or modifications not expressly approved by the party responsible for compliance could void the user's authority to operate the equipment. If necessary, consult your dealer or an experienced radio/television technician for additional suggestions. You may find the booklet called How to Identify and Resolve Radio/TV Interference Problems helpful. This booklet was prepared by the Federal Communications Commission. It is available from the U.S. Government Printing Office, Washington, DC 20402, Stock Number 004-000-00345-4.

The party responsible for product compliance:
SAMSUNG ELECTRONICS CO., LTD
America QA Lab of Samsung
3351 Michelson Drive,
Suite #290, Irvine, CA92612 USA

Warning

User must use shielded signal interface cables to maintain FCC compliance for the product.

Provided with this monitor is a detachable power supply cord with IEC320 style terminations. It may be suitable for connection to any UL Listed personal computer with similar configuration. Before making the connection, make sure the voltage rating of the computer convenience outlet is the same as the monitor and that the ampere rating of the computer convenience outlet is equal to or exceeds the monitor voltage rating.

For 120 Volt applications, use only UL Listed detachable power cord with NEMA configuration 5-15P type (parallel blades) plug cap. For 240 Volt applications use only UL Listed Detachable power supply cord with NEMA configuration 6-15P type (tandem blades) plug cap.

● IC Compliance Notice

This Class B digital apparatus meets all requirements of the Canadian Interference-Causing Equipment Regulations of ICES-003.

Cet appareil Numérique de classe B respecte toutes les exigences du Règlement NMB-03 sur les équipements produisant des interférences au Canada.

● MPR II Compliance

This monitor complies with SWEDAC(MPR II) recommendations for reduced electric and magnetic fields.

Regulatory

● European Notice (Europe only)

Products with the CE marking comply with the EMC Directive(89/336/EEC), (92/31/EEC), (93/68/EEC) and the Low Voltage Directive (73/23/EEC) issued by the Commission of the European Community. Compliance with these directives implies conformity to the following European Norms:

- EN55022:1998+A1:2000 - Radio Frequency Interference
- EN55024:1998 - Electromagnetic Immunity
- EN55013:1990+A12:1994+A13:1996+A14:1999 - Radio Frequency Interference
- EN55020:1994+A11:1996+A12/A13/A14:1999 - Electromagnetic Immunity
- EN61000-3-2:1995+A1/A2:1998 - Power Line Harmonics
- EN61000-3-3:1995 - Voltage Fluctuations
- EN60065:1997 or EN60950:1998 - Product Safety

● PCT Notice



● VCCI

This is a Class B product based on the standard of the Voluntary Control Council for Interference by Information Technology Equipment (VCCI). If this is used near a radio or television receiver in a domestic environment, it may cause radio interference. Install and use the equipment according to the instruction manual.

● TCO'99-Ecological requirements for personal computers (TCO'99 applied model only)



Congratulations!

You have just purchased a TCO'99 approved and labelled product! Your choice has provided you with a product developed for professional use. Your purchase has also contributed to reducing the burden on the environment and also to the further development of environmentally adapted electronics products.

This product meets the requirements for the TCO'99 scheme which provides for an international environmental and quality labelling of personal computers. The labelling scheme was developed as a joint effort by the TCO(The Swedish Confederation of Professional Employees), Svenska Naturskyddsforeningen(The Swedish Society for Nature Conservation), Statens Energimyndighet(The Swedish National Energy Administration) and SEMKO AB.

The requirements cover a wide range of issues: environment, ergonomics, usability, reduction of electric and magnetic fields, energy consumption and electrical safety.

Why do we have environmentally labelled computers?

In many countries, environmental labelling has become an established method for encouraging the adaptation of goods and services to the environment. The main problem, as far as computers and other electronics equipment are concerned, is that environmentally harmful substances are used both in the products and during their manufacture. Since it is not so far possible to satisfactorily recycle the majority of electronics equipment, most of these potentially damaging substances sooner or later enter nature.

Regulatory

There are also other characteristics of a computer, such as energy consumption levels, that are important from the viewpoints of both the work (internal) and natural (external) environments. Since all methods of electricity generation have a negative effect on the environment (e.g. acidic and climate-influencing emissions, radioactive waste), it is vital to save energy. Electronics equipment in offices is often left running continuously and thereby consumes a lot of energy.

What does labelling involve?

The environmental demands has been developed by Svenska Naturskyddsforeningen (The Swedish Society for Nature Conservation). These demands impose restrictions on the presence and use of heavy metals, brominated and chlorinated flame retardants, CFCs (freons) and chlorinated solvents, among other things. The product must be prepared for recycling and the manufacturer is obliged to have an environmental policy which must be adhered to in each country where the company implements its operational policy.

The energy requirements include a demand that the computer and/or display, after a certain period of inactivity, shall reduce its power consumption to a lower level in one or more stages. The length of time to reactivate the computer shall be reasonable for the user.

Below you will find a brief summary of the environmental requirements met by this product. The complete environmental criteria document may be ordered from:

TCO Development

SE-114 94 Stockholm, Sweden
Fax: +46 8 782 92 07
Email (Internet): development@tco.se

Current information regarding TCO'99 approved and labelled products may also be obtained via the Internet, using the address: <http://www.tco-info.com/>

Environmental requirements

Flame retardants

Flame retardants are present in printed circuit boards, cables, wires, casings and housings. Their purpose is to prevent, or at least to delay the spread of fire. Up to 30% of the plastic in a computer casing can consist of flame retardant substances. Most flame retardants contain bromine or chloride, and those flame retardants are chemically related to another group of environmental toxins, PCBs. Both the flame retardants containing bromine or chloride and the PCBs are suspected of giving rise to severe health effects, including reproductive damage in fish-eating birds and mammals, due to the bio-accumulative* processes. Flame retardants have been found in human blood and researchers fear that disturbances in fetus development may occur.

The relevant TCO'99 demand requires that plastic components weighing more than 25 grams must not contain flame retardants with organically bound bromine or chlorine. Flame retardants are allowed in the printed circuit boards since no substitutes are available.

Cadmium**

Cadmium is present in rechargeable batteries and in the colour-generating layers of certain computer displays. Cadmium damages the nervous system and is toxic in high doses. The relevant TCO'99 requirement states that batteries, the colour-generating layers of display screens and the electrical or electronics components must not contain any cadmium.

Mercury**

Mercury is sometimes found in batteries, relays and switches. It damages the nervous system and is toxic in high doses. The relevant TCO'99 requirement states that batteries may not contain any mercury. It also demands that mercury is not present in any of the electrical or electronics components associated with the labelled unit. There is however one exception. Mercury is, for the time being, permitted in the back light system of flat panel monitors as today there is no commercially available alternative. TCO aims on removing this exception when a Mercury free alternative is available.

CFCs (freons)

The relevant TCO'99 requirement states that neither CFCs nor HCFCs may be used during the manufacture and assembly of the product. CFCs (freons) are sometimes used for washing printed circuit boards. CFCs break down ozone and thereby damage the ozone layer in the stratosphere, causing increased reception on earth of ultraviolet light with e.g. increased risks of skin cancer (malignant melanoma) as a consequence.

Lead**

Lead can be found in picture tubes, display screens, solders and capacitors. Lead damages the nervous system and in higher doses, causes lead poisoning. The relevant TCO'99 requirement permits the inclusion of lead since no replacement has yet been developed.

* Bio-accumulative is defined as substances which accumulate within living organisms.

** Lead, Cadmium and Mercury are heavy metals which are Bio-accumulative.

Regulatory

- TCO'03-Ecological requirements for personal computers (TCO'03 applied model only)



Congratulations!

The display you have just purchased carries the TCO03 Displays label. This means that your display is designed, manufactured and tested according to some of the strictest quality and environmental requirements in the world. This makes for a high performance product, designed with the user in focus that also minimizes the impact on our natural environment.

Some of the features of the TCO03 Display requirements:

Ergonomics

Good visual ergonomics and image quality in order to improve the working environment for the user and to reduce sight and strain problems. Important parameters are luminance, contrast, resolution, reflectance, colour rendition and image stability.

Energy

- Energy-saving mode after a certain time - beneficial both for the user and the environment
- Electrical safety

Emissions

- Electromagnetic fields
- Noise emissions

Ecology

- The product must be prepared for recycling and the manufacturer must have a certified environmental management system such as EMAS or ISO 14 000
- Restrictions on
 - chlorinated and brominated flame retardants and polymers
 - heavy metals such as cadmium, mercury and lead.

The requirements included in this label have been developed by TCO Development in cooperation with scientists, experts, users as well as manufacturers all over the world. Since the end of the 1980s TCO has been involved in influencing the development of IT equipment in a more user-friendly direction. Our labelling system started with displays in 1992 and is now requested by users and IT-manufacturers all over the world.

For more information, Please visit
www.tcodevelopment.com

Regulatory

● **TCO'03 Recycling Information (TCO'03 applied model only)**

For recycling information for TCO'03 certified monitors, for the residents in the following countries, please contact the company corresponding to your region of residence. For those who reside in other countries, please contact a nearest local Samsung dealer for recycling information for the products to be treated in environmentally acceptable way.

	[U.S.A. Residents Only]	[European Residents Only]		
	U.S.A.	SWEDEN	NORWAY	GERMANY
COMPANY	Solid Waste Transfer & Recycling Inc	ELKRETSSEN	Elektronikkretur AS	vfw AG
ADDRESS	442 Frelinghuysen Ave Newark, NJ 07114	ELKRETSSEN Box 1357, 111 83 Stockholm Barnhusgatan 3, 4 tr.	6454 Etterstad 0602 Oslo Fyrstikkalln 3B	Max Plank Strasse 42 50858 Collogne Germany
TELEPHONE	973-565-0181	08-545 212 90	23 06 07 40	49 0 2234 9587 - 0
FAX	Fax: 973-565-9485	08-545 212 99	23 06 07 41	
E-MAIL	none	info@el- kretsen.se	adm@elektronikkretur.no	vfw.info@vfw- ag.de
HOME PAGE	http://www.bcua.org/Solid Waste_Disposal.htm	http://www.el- kretsen.se/	http://www.elretur.no/	

Natural Color

- **Natural Color Software Program**



One of the recent problems in using a computer is that the color of the images printed out by a printer or other images scanned by a scanner or a digital camera are not the same as those shown on the monitor.

The Natural Color S/W is the very solution for this problem. It is a color administration system developed by Samsung Electronics in association with Korea Electronics & Telecommunications Research Institute (ETRI). This system is available only for Samsung monitors and makes the color of the images on the monitor the same as the printed or scanned images.

For more information, refer to Help (F1) in the software program.

How to install the Natural Color software

Insert the CD included with the Samsung monitor into the CD-ROM Drive. Then, the initial screen of the program installation will be executed. Click Natural Color on the initial screen to install the Natural Color software. To install the program manually, insert the CD included with the Samsung monitor into the CD-ROM Drive, click the [Start] button of Windows and then select [Execute]. Enter D:\color\eng\setup.exe and then press the <Enter> key.
(If the drive where the CD is inserted is not D:\, enter the applicable drive.)

How to delete the Natural Color software program

Select [Setting]/[Control Panel] on the [Start] menu and then double-click [Add/Delete a program]. Select Natural Color from the list and then click the [Add/Delete] button.

For Better Display

● For Better Display

1. Adjust computer resolution and screen injection rate (refresh rate) in control panel of computer as described below to enjoy the best quality of picture. You can have an uneven quality of picture in the screen if the best quality of picture is not provided in TFT-LCD.
 - Resolution: 1280 x 768
 - Vertical frequency (refresh rate): 60 Hz
2. TFT LCD panel manufactured by using advanced semiconductor technology with precision of 99.999% above is used for this product. But the pixels of RED, GREEN, BLUE and WHITE color seem to be bright sometimes or some of black pixels could be seen. This is not from bad quality and you can use it without uneasiness.
 - For example, the number of TFT LCD pixels that is contained in this product are 2,949,120.
3. When you clean the monitor and the panel outside, please apply the recommended small amount of cleaner by using soft and dry cloth and polish it. Let LCD area not to be forced but to be scrubbed out softly. If excessive force is applied, you can have a stain on it.
4. If you are not satisfied with the quality of picture, you can get better quality of picture by executing "auto adjustment function" in display screen that is appeared as window termination button is pressed. If there's still noise after automatic adjustment, use FINE/COARSE adjustment function.
5. If you view a fixed screen for an extended period of time, residual image or blurriness may appear. Change the mode to energy save or set a screensaver to moving picture when you need to be away from the monitor for an extended period of time.

Authority

**Information in this document is subject to change without notice.
© 2003 Samsung Electronics Co., Ltd. All rights reserved.**

Reproduction in any manner whatsoever without the written permission of Samsung Electronics Co., Ltd. is strictly forbidden.

Samsung Electronics Co., Ltd. shall not be liable for errors contained herein or for incidental or consequential damages in connection with the furnishing, performance, or use of this material.

Samsung is the registered trademark of Samsung Electronics Co., Ltd.; *Microsoft*, *Windows* and *Windows NT* are registered trademarks of Microsoft Corporation; *VESA*, *DPMS* and *DDC* are registered trademarks of Video Electronics Standard Association; the *ENERGY STAR* name and logo are registered trademarks of the U.S. Environmental Protection Agency (EPA). As an ENERGY STAR Partner, Samsung Electronics Co., Ltd. has determined that this product meets the ENERGY STAR guidelines for energy efficiency. All other product names mentioned herein may be the trademarks or registered trademarks of their respective owners.

 **DOLBY** Manufactured under license from Dolby Laboratories "Dolby" and
DIGITAL the double-D symbol are trademarks of Dolby Laboratories.

Free Manuals Download Website

<http://myh66.com>

<http://usermanuals.us>

<http://www.somanuals.com>

<http://www.4manuals.cc>

<http://www.manual-lib.com>

<http://www.404manual.com>

<http://www.luxmanual.com>

<http://aubethermostatmanual.com>

Golf course search by state

<http://golfingnear.com>

Email search by domain

<http://emailbydomain.com>

Auto manuals search

<http://auto.somanuals.com>

TV manuals search

<http://tv.somanuals.com>