



#### SALES NETWORK

• **SAMSUNG TECHWIN CO., LTD.**

145-3, Sangdaewon 1-dong, Jungwon-gu, Seongnam-si,  
Gyeonggi-do 462-703, Korea  
TEL : +82-31-740-8137~8141 FAX : +82-31-740-8145

• **TIANJIN SAMSUNG OPTO-ELECTRONICS CO., LTD.**

7 Pingchang Rd, Nankai Dist. Tianjin 300190, P.R China  
TEL : +86-22-2761-4724(33821) FAX : +86-22-2761-6514

• **SAMSUNG OPTO-ELECTRONICS UK, LTD.**

Samsung House, 1000 Hillswood Drive, Hillswood Business Park  
Chertsey, Surrey KT16 OPS  
TEL : +44-1932-45-5308 FAX : +44-1932-45-5325

[www.samsungtechwin.com](http://www.samsungtechwin.com)  
[www.samsungcctv.com](http://www.samsungcctv.com)

VAN 06. 03

## Professional Security LCD Monitor

### INSTRUCTION MANUAL

# STM-19LV/17LV

#### About this manual

Please read this manual carefully before installing and using the camera. Be sure to keep the manual handy for later reference.

## CONTENTS

SAFETY INSTRUCTION	3
CAUTIONS	4
FCC RF INTERFERENCE STATEMENT	5
CONNECTING WITH EXTERNAL EQUIPMENT	5
REMOTE FUNCTIONS	6
CONTROLS AND FUNCTIONS	6
MOUNTING GUIDE	9
D-SUB CONNECTOR PIN ASSIGNMENTS	9
POWER MANAGEMENT	10
TROUBLESHOOTING GUIDE	10
SPECIFICATIONS	11
DIMENSION	11

## SAFETY INSTRUCTION

Thank you for purchasing our product. Before operating this product, please read the instruction manual.

1. Unplug this product from the wall outlet before cleaning. Do not use liquid cleaners or aerosol cleaners. Use a damp cloth for cleaning.
2. Do not use this product near water.
3. Do not place this product on an unstable cart, stand or table. The product may fall, causing serious damage to the product.
4. Slots and openings in the cabinet and the back are provided for ventilation: to ensure reliable operation of the product, these openings must not be blocked by placing the product on a bed, sofa, rug or other similar surface. This product should never be placed near or over a heat register. This product should not be placed in a built-in installation unless proper ventilation is provided.
5. This product should be operated from the type of power source indicated on the marking label. If you are not sure of the type of power available, consult your dealer or local power company.
6. This product is equipped with a 3 wire grounding type plug having a third (grounding) pin. This is a safety feature. If you are unable to insert the plug into the outlet, contact your electrician to replace your obsolete outlet. Do not defeat the purpose of the grounding-type plug.
7. Do not allow anything to rest on the power cord. Do not locate this product where persons will walk on the cord.
8. If an extension cord is used with this product, make sure that the total of the ampere ratings on the products plugged into the extension cord do not exceed the extension cord ampere rating. Also, make sure that the total of all products plugged into the wall outlet does not exceed 10 amperes.
9. Never push objects of any kind into this product through cabinet slots as they may touch dangerous voltage points or short out parts that could result in a risk of fire or electric shock. Never spill any kind of liquid on the product.
10. Do not attempt to service this product yourself, as opening or removing covers may expose you to dangerous voltage points or other risks. Refer all servicing to service personnel.
11. Unplug this product from the wall outlet and refer servicing to qualified service personnel under the following conditions.
  - When the power cord or plug is damaged or frayed.
  - If liquid has been spilled into the product.
  - If the product has been exposed to rain or water.
  - If the Product does not operate normally when the operating instructions are followed. Adjust only those controls that are covered by the operating instructions since improper adjustment of other controls may result in damage and will often require extensive work by a qualified technician to restore normal operation.
  - If the product has been dropped or the cabinet has been damaged.
  - If the product exhibits a distinct change in performance, indicating a need for service.

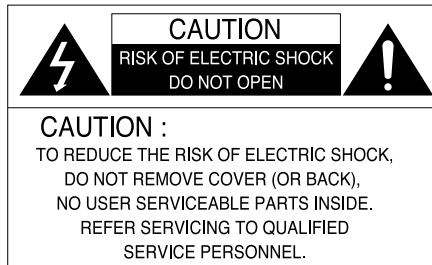

**CAUTION**

The power supply cord is used as the main disconnect device, ensure that the socket-outlet is located/installed near the equipment and is easily accessible.

**CAUTION TO SERVICE PERSONNEL**  
 POWER SUPPLY CORD IS USED AS MAIN POWER DISCONNECT DEVICE IN THIS PRODUCT.  
 UNPLUG THIS PRODUCT FROM THE WALL OUTLET BEFORE REMOVING THE BACK COVER AND SERVICING.

## CAUTIONS

- **NEVER REMOVE THE BACK COVER**  
Removal of the back cover should be carried out only by qualified personnel.
- **DO NOT USE IN HOSTILE ENVIRONMENTS**  
To prevent shock or fire hazard, do not expose the unit to rain or moisture. This unit is designed to be used in the office or home. Do not subject the unit to vibrations, dust of corrosive gases.
- **KEEP IN A WELL VENTILATED PLACE**  
Ventilation holes are provided on the cabinet to prevent the temperature from rising. Do not cover the unit or place anything on the top of unit.
- **AVOID HEAT**  
Avoid placing the unit in direct sunshine or near a heating appliance.
- **TO ELIMINATE EYE FATIGUE**  
Do not use the unit against a bright back ground and where sunlight or other light sources will shine directly on the monitor.
- **BE CAREFUL OF HEAVY OBJECT**  
Neither the monitor itself nor any other heavy object should rest on the power cord. Damage to a power cord can cause fire or electrical shock.

## FCC RF INTERFERENCE STATEMENT

**NOTE**

This equipment has been tested and found to comply with the limits for a Class B digital device, pursuant to Part 15 of the FCC Rules. These limits are designed to provide reasonable protection against harmful interference in a residential installation. This equipment generates, uses and can radiate radio frequency energy and, if not installed and used in accordance with the instructions, may cause harmful interference to radio communications. However, there is no guarantee that interference will not occur in a particular installation. If this equipment does cause harmful interference to radio or television reception which can be determined by turning the equipment off and on, the user is encouraged to try to correct the interference by one or more of the following measures.

- Reorient or relocate the receiving antenna.
- Increase the separation between the equipment and receiver.
- Connect the equipment into an outlet on a circuit different from that to which the receiver is connected.
- Consult the dealer or an experienced radio, TV technician for help.
- Only shielded interface cable should be used.

Finally, any changes or modifications to the equipment by the user not expressly approved by the grantee or manufacturer could void the users authority to operate such equipment.

**• DOC COMPLIANCE NOTICE**

This digital apparatus does not exceed the Class B limits for radio noise emissions from digital apparatus set out in the radio interference regulation of Canadian Department of communications.

## CONNECTING WITH EXTERNAL EQUIPMENT

**A. BOTTOM PANEL CONTROL**

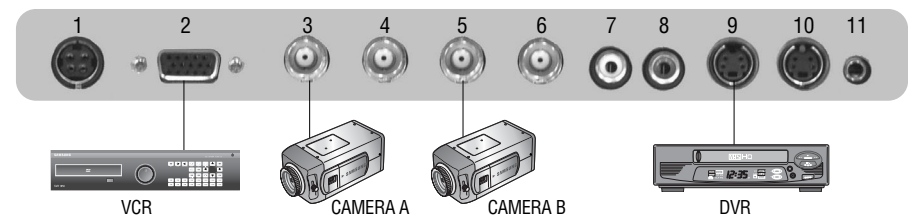

- 1. DC 12V IN    2. D-SUB IN : PC Signal Input    3. VIDEO 1(AV1) IN : Composite signal Input for AV1
- 4. VIDEO 1(AV1) OUT : Video looping output for AV1
- 5. VIDEO 2(AV2) IN : Composite signal Input for AV2
- 6. VIDEO 2(AV2) OUT : Video looping output for AV2
- 7. AUDIO 1 IN : Stereo Audio Signal Input, This input is for AV1, S-VIDEO
- 8. AUDIO 2 IN : Stereo Audio Signal Input, This Output is for AV2
- 9. S-VIDEO (Y/C) IN : Y/C separated signal input
- 10. S-VIDEO (Y/C) OUT : Y/C separated signal looping output    11. PC STEREO IN

## REMOTE FUNCTIONS

### B. REMOTE CONTROLLER

- 1. POWER(⏻) :**  
Turns the power ON or OFF.  
There will be a few seconds delay before the display appears.
- 2. SOURCE :**  
Select pc or video(PC / AV1 / AV2 / S-Video) sources.
- 3. MUTE :** Mute the sound.
- 4. MENU :** Activates and exits the On Screen Display.
- 5. VOL(◀▶) :**  
Increases or decreases the level of audio volume.
- 6. UP/DOWN(▲▼) :** Move to OSD menu.
- 7. AUTO :** Auto geometry adjustment in PC Source.
- 8. EXIT :** Exit the On Screen Display.

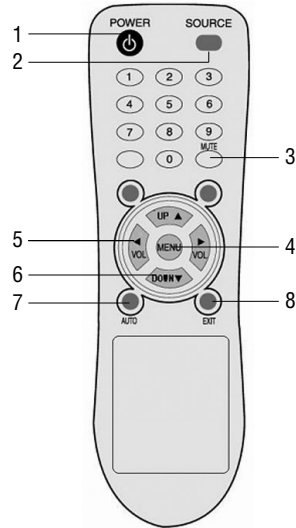

## CONTROLS AND FUNCTIONS



### • Front Key Control

- 1. SOURCE**  
Select input source, and move the previous menu.
- 2. MENU**  
Activates and exits the On Screen Display. This button can also be used to move previous menu or status.  
OSD MENU(MAIN) : Input Source, Screen, Audio, OSD, Color, Utility, Exit.
- 3/4. DOWN / UP**  
This button allows user to enter the sub-menu of the activated function. when down key is pressed on the main menu.
- 5/6. VOL< / VOL >**  
Adjust the volume / Adjust menu settings.

### 7. IR Sensor

Remote controller sensor.

### 8. POWER ON/OFF(⏻)

Turns the power ON or OFF. There will be a few seconds delay before the display appears. The power LED (next to the power switch) lights with green when the power is turned ON. The power is turned off by pressing the power switch again and the power LED goes Red.

### • SELF-TEST DISPLAY

When there is no connection at PC, the On Screen Display will show for 3 seconds.



### • OSD MENU DESCRIPTION

**Input Source** : Select PC or AV1, SVIDEO.

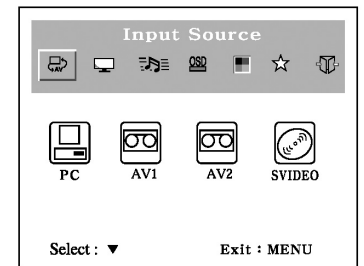

**Screen** :

- Brightness - Increase or decrease the intensity of the image.
- Contrast - Increase or decrease the intensity(lightness or dimness) of the image.
- H. position(PC Mode Only) - Move image horizontally on screen right or left.
- V. position(PC Mode Only) - Move image vertically on screen up or down.
- Clock(PC Mode Only) - Adjust the vertical noise of screen image.
- Phase(PC Mode Only) - Adjust the number of horizontal picture elements.

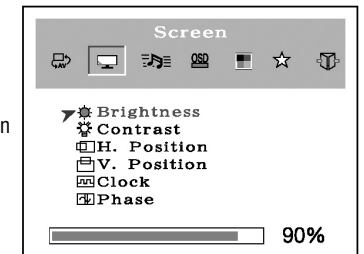

**Audio** **Volume** : Adjust audio volume.

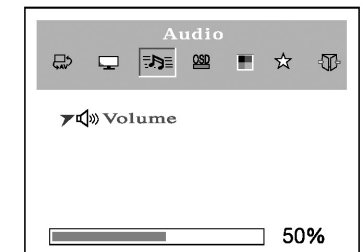

**OSD OSD :**

- ▶ **OSD** H. Position - Move the OSD position to right(▶) or left(◀).
- ▶ **OSD** V. Position - Move the OSD position to up(▲) or down(▼).
- ▶ Transparency - Select the OSD background.
- ▶ OSD Timer - Select the OSD display timing.
- ▶ **A** Language - Select a language among English, Français, Deutsch, Español, Danish, Italiano.

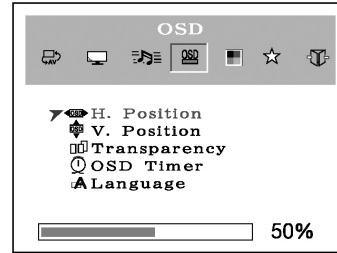

**Color (PC Mode) :**

- ▶ **Color Temp** - Adjust color temperature to 9300, 6500, user. (note : 9300 is factory default)
- ▶ Red - Adjust red color for user.
- ▶ Green - Adjust green color for user.
- ▶ Blue - Adjust blue color for user.

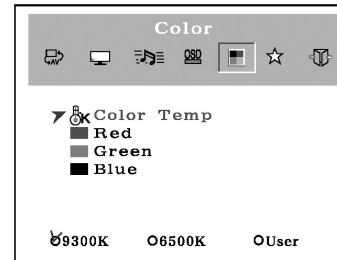

**Utility :**

- ▶ Recall - Select to reset all setting to the factory default values.
- ▶ Lock - Select ON or OFF (ON : Control key lock. OFF : Control key unlock)

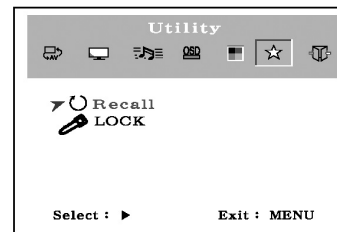

**Exit :** Turn off OSD Menu.

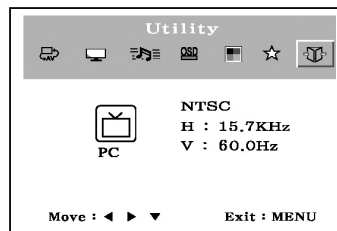

**MOUNTING GUIDE**

Wall mountable using two methods:

- 1) Using the 200 mm pre-cut holes
- 2) Using the VESA standard wall mount design and the 100mm hole pattern on the back panel to install the LCD monitor to the wall.

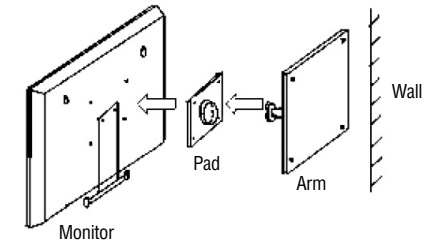
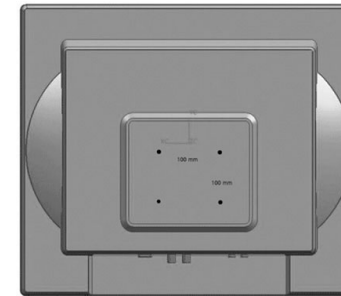

**D-SUB CONNECTOR PIN ASSIGNMENTS**

**• PIN ASSIGNMENTS**

Pin 1	RED VIDEO	Pin 9	
Pin 2	GREEN VIDEO	Pin10	SIGNAL CABLE DETECT
Pin 3	BLUE VIDEO	Pin 11	GROUND
Pin 4	GROUND	Pin 12	SAD(for DDC)
Pin 5	GROUND	Pin 13	H-SYNC.(or H+V SYNC.)
Pin 6	RED GROUND	Pin 14	V-SYNC
Pin 7	GREEN GROUND	Pin 15	SLC(for DDC)
Pin 8	BLUE GROUND		

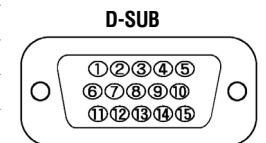

**• ACCESSORY**

- |                   |                  |                        |                        |
|-------------------|------------------|------------------------|------------------------|
| 1. POWER CORD     | 2. USER'S MANUAL | 3. PC cable            | 4. Adaptor             |
| 5. Remote Control | 6. Batteries     | 7. Wall mount (Option) | 8. Rack mount (Option) |

## POWER MANAGEMENT

This monitor features a power management system to “power down” upon receipt of the VESA DPMS(The display power management signaling) from a VESA DPMS video card. The VESA DPMS-compliant video card performs this signaling system through not sending horizontal, vertical, or sync signal. This monitor enters an appropriate mode through identifying each of the three modes of the signaling system.

### • POWER CONSUMPTION

MODE	POWER CONSUMPTION	MODE	POWER CONSUMPTION
ON	<50W	SUSPEND	<5W
STANDBY	<5W	ACTIVE OFF	<5W

### • LED INDICATOR

The power management feature of the monitor is comprised of four stages : On(Green), Standby, Suspend, Active off(Red & Green) and Unsupported mode(Green).

MODE	LED COLOR	MONITOR OPERATION
ON	GREEN	Normal Operation
STANDBY	AMBER	Screen blanks after preset ide time and some electronic circuits or all circuitry in the monitor shutdown.
SUSPEND		
ACTIVE OFF		
UNSUPPORTED MODE	GREEN	Normal operation but the on screen display will show error message.
POWER OFF	RED	Not operation

## TROUBLESHOOTING GUIDE

TROUBLE	TROUBLESHOOTING TIP
No image on display screen	<ol style="list-style-type: none"> <li>1. Check that power cord of the monitor have been connected securely into wall outlet or grounded extension cable or strip.</li> <li>2. Power switch should be in the ON position and LED is lit.</li> <li>3. Check that the Brightness and / or the Contrast adjustments of the Display have not been turned down to minimum levels.</li> </ol>
“Check Input Signal” message on screen	<ol style="list-style-type: none"> <li>1. The signal cable should be completely connected to the video card / computer</li> <li>2. The video card should be completely seated in its slot and the computer is switched ON.</li> </ol>
Display image is not centered, too small or too large in PC mode	Push the down key in front side or Auto key in remote.
Vertical or Horizontal noise is present in the picture	Adjust Clock and Phase in the OSD.

## SPECIFICATIONS

Model Name		STM-19LV	STM-17LV
Video	Composite	2ch input 1.0Vp-p, 75Ω terminated, loop-through out	
	S-VIDEO	1ch input (Y/C), loop-through out	
	VGA	1ch input	
Resolution		1280x1024@60Hz	
Frequency	Horizontal(KHz)	31KHz - 82KHz	
	Vertical(Hz)	50Hz - 77Hz	
VGA Mode		720x480@60Hz, 720x576@50Hz, 800x600@60/75Hz 1024x768@60/75Hz, 1280x1024@60/75Hz	
Power Consumption	Max. 36W	Max. 42W	
Dimensions (WxDxH)	Net	430x428x200mm	382.4x390.5x200mm
	Packing	490x506x225mm	436x476x225mm
Weight(kg)	Net Weight	6.61Kg	5.96Kg
	Gross Weight	8.43Kg	7.67Kg
Power Supply		DC 12V / 4A	
Environmental Considerations	Operating Temperature	50°F-104°F (10°C-4°C)	
	Operating Humidity	10%-80%, Non-condensing	
	Storage Temperature	-4°F-113°F (-20°C-45°C)	
	Storage Humidity	5%-95%, Non-condensing	
LCD Panel Spec	Size	19" Diagonal AM-TFT	17" Diagonal AM-TFT
	Active Display Area	376.32x301.056mm	337.92x270.336mm
	Pixel Pitch(mm)	0.294mm(H) x 0.294mm(V)	0.264mm(H) x 0.264mm(V)
	Brightness(cd/m2)	300cd/m2	
	Contrast Ratio	700:1	
	Response Time(ms)	8ms	
	Viewing Angle(L/R/ T/B)	75/75/75/60	

## DIMENSION

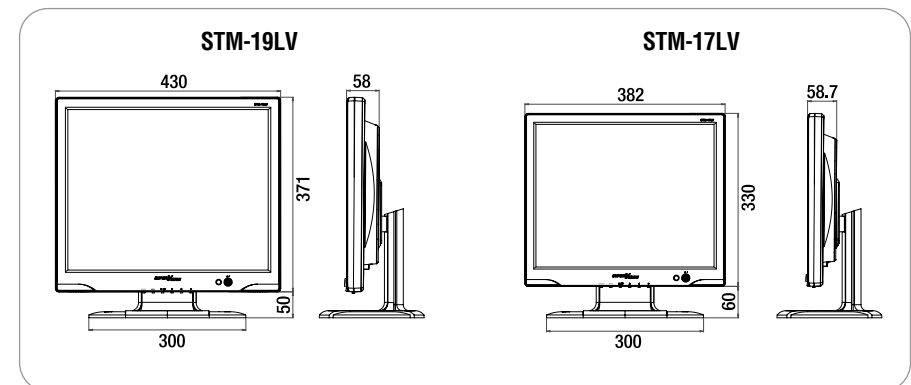

## Free Manuals Download Website

<http://myh66.com>

<http://usermanuals.us>

<http://www.somanuals.com>

<http://www.4manuals.cc>

<http://www.manual-lib.com>

<http://www.404manual.com>

<http://www.luxmanual.com>

<http://aubethermostatmanual.com>

Golf course search by state

<http://golfingnear.com>

Email search by domain

<http://emailbydomain.com>

Auto manuals search

<http://auto.somanuals.com>

TV manuals search

<http://tv.somanuals.com>