

SERIES **3** | TC350

SERIES **5** | TC550

SERIES **7** | TC730

LED TV MONITOR

(MFM TV)

user manual

Thank you for purchasing this Samsung product.
To receive more complete service, please register
your product at
www.samsung.com/register

Model _____ Serial No. _____

 If you have any questions, please call us at 1-800-SAMSUNG
(1-800-726-7864) for assistance.



Figures and illustrations in this User Manual are provided for reference only and may differ from actual product appearance. Product design and specifications may be changed without notice.

Important Warranty Information Regarding Television Format Viewing

See the warranty card for more information on warranty terms.

Wide screen format TVs (with 16:9 aspect ratios, the ratio of the screen width to height) are primarily designed to view wide screen format full-motion video. The images displayed on them should primarily be in the wide screen 16:9 ratio format, or expanded to fill the screen if your model offers this feature, with the images constantly in motion. Displaying stationary graphics and images on the screen, such as the dark sidebars on non-expanded standard format television video and programming, should be limited to no more than 5% of the total television viewing per week. Additionally, viewing other stationary images and text such as stock market crawls, video game displays, station logos, web sites or computer graphics and patterns, should be limited as described above for all televisions. Displaying stationary images for more than 5% of total viewing time can cause uneven aging of your TV and leave subtle, but permanent burned-in ghost images in the LED picture. To avoid this, vary the programming and images, and primarily display full screen moving images, not stationary patterns or dark bars. On LED models that offer picture sizing features, use these controls to view different formats as a full screen picture. Be careful in the selection of television formats you use for viewing and the amount of time you view them. Uneven LED aging as a result of format selection and use, as well as burned in images, are not covered by your Samsung limited warranty.

Still image warning

Avoid displaying still images (such as jpeg picture files), still image elements (such as TV channel logos, stock or news bars at the screen bottom etc.), or programs in panorama or 4:3 image format on the screen. Constantly displaying still pictures can cause image burn-in on the screen, which will affect image quality. To reduce risk of this effect, please follow the recommendations below:

- Avoid displaying the same TV channel for long periods.
- Always try to display a full screen image.
- Reduce brightness and contrast to avoid the appearance of after-images.
- Use all TV features designed to reduce image retention and screen burn. Refer to proper user manual section for details.

Securing the Installation Space

Keep the required distances between the product and other objects (e.g. walls) to ensure proper ventilation. Failing to do so may result in fire or a problem with the product due to an increase in the internal temperature of the product.

Installation with a stand.

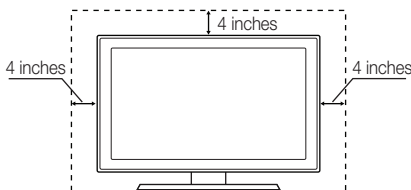

Installation with a wall-mount.

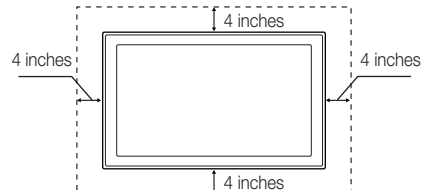

Other Warnings

The actual appearance of the TV may differ from the images in this manual, depending on the model. Be careful when you touch the TV. Some parts can be somewhat hot.

Contents

Getting Started		
• Safety Precautions	4	
Power Related	4	
Installation Related	5	
Cleaning Related	7	
Usage Related	7	
• List of Features	11	
• Accessories	11	
• Viewing the Control Panel	12	
• Viewing the Remote Control.....	14	
• How to Navigate Menus.....	15	
• Connecting to an Antenna	15	
• Plug & Play (Initial Setup).....	16	
Connections		
• Connecting to an AV Device.....	17	
• Connecting to the headphone.....	18	
• Connecting to a PC	18	
Basic Features		
• Changing the Input Source	21	
• Channel Menu	21	
Seeing Channels	21	
Using Favorite Channels	22	
Memorizing Channels	22	
Editing Channels	22	
Other Features	22	
• Picture Menu	24	
Changing the Preset Picture Mode	24	
Adjusting Picture Settings	24	
Response Time	24	
Auto Adjustment	24	
Changing the Picture Options	25	
• Sound Menu	27	
Changing the Preset Sound Mode	27	
Adjusting sound settings	27	
Sound Settings	27	
• Setup Menu	28	
Setting the Time	28	
Using the Sleep Timer	28	
Setting the On/Off Timer	28	
Locking Programs	29	
Other Features	30	
• Support Menu.....	32	
Advanced Features		
• Media Play (USB)	33	
Connecting a USB Device	33	
• Sports Mode.....	38	
Other Information		
• Attaching a Wall Mount/Desktop Stand.....	39	
• Anti-theft Kensington Lock.....	40	
• Troubleshooting	41	
• Storage and Maintenance	43	
• License	44	
• Specifications	45	

Check the Symbol!

TOOLS 

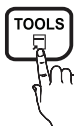

This function can be used by pressing the TOOLS button on the remote control.



Note

Indicates additional information.

Getting Started

Safety Precautions

Icons used for safety precautions



WARNING

Failing to follow the precautions marked with this sign may result in a serious injury or even a fatality.



CAUTION

Failing to follow the precautions marked with this sign may result in a personal injury or property damage.



Do not perform.



Must be followed.

CAUTION

RISK OF ELECTRIC SHOCK DO NOT OPEN

CAUTION: TO REDUCE THE RISK OF ELECTRIC SHOCK, DO NOT REMOVE COVER (OR BACK). THERE ARE NO USER SERVICEABLE PARTS INSIDE. REFER ALL SERVICING TO QUALIFIED PERSONNEL.



This symbol indicates that high voltage is present inside. It is dangerous to make any kind of contact with any internal part of this product.



This symbol alerts you that important literature concerning operation and maintenance has been included with this product.

Power Related

The following images are for your reference and may differ depending on models and countries.

Warning

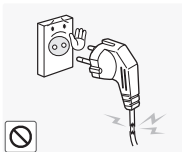

Avoid using a damaged power cord or plug or a loose power outlet.

- Otherwise, it may result in electric shock or fire.

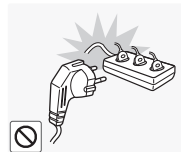

Avoid connecting multiple electric appliances to a single wall outlet.

- Otherwise, it may result in fire due to overheating of the wall outlet.



Avoid plugging in or unplugging the power supply with wet hands.

- Otherwise, it may result in electric shock.

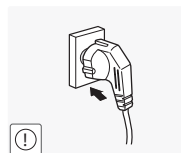

Plug the power plug in firmly.

- Otherwise, it may result in fire.

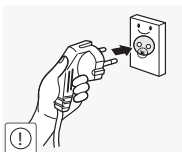

Make sure to connect the power cord to a grounded wall outlet (for insulation class 1 equipment only).

- Otherwise, it may result in electric shock or injury.



Avoid bending or twisting the power cord excessively and avoid placing heavy objects on the cord.

- Otherwise, it may result in electric shock or fire due to a damaged power cord.

Getting Started

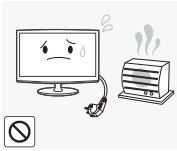

Keep the power cord and the product away from a heater.

- Otherwise, it may result in electric shock or fire.

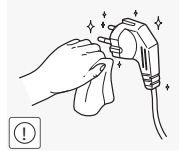

If the pins of the power plug or the wall outlet are covered in dust, clean it using a dry cloth.

- Otherwise, it may result in fire.

! Caution

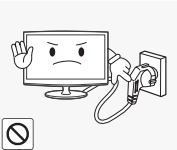

Avoid unplugging the power plug while the product is operating.

- Otherwise, it may damage the product due to electric shock.

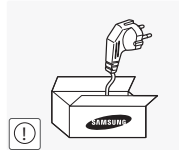

Make sure to use only the power cord supplied by our company. In addition, do not use the power cord of another electric appliance.

- Otherwise, it may result in electric shock or fire.

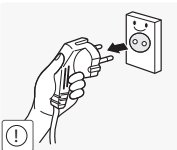

When unplugging the power plug from the wall outlet, make sure to hold it by the plug and not by the cord.

- Otherwise, it may result in electric shock or fire.



Connect the power plug to a wall outlet that can be easily reached.

- When a problem occurs with the product, you must unplug the power plug to cut the power off completely. You cannot cut the power off completely using only the power button on the product.

Installation Related

! Warning



Avoid placing burning candles, mosquito repellent or cigarettes on the product.

- Otherwise, it may result in fire.

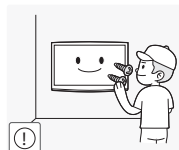

Ask an installation engineer or relevant company to install the product onto the wall.

- Otherwise, it may result in injury.
- Make sure to use the specified wall mount.



Avoid installing the product in a badly-ventilated location such as inside a bookshelf or closet.

- Otherwise, it may result in fire due to internal over-heating.



Keep the plastic bags used to pack the product away from children.

- If children place the plastic bags over their heads, they may suffocate.

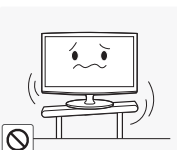

Avoid installing the product in a location that is unstable or exposed to excessive vibration such as on an unstable or slanted shelf.

- The product may fall and this may result in damage to the product or injury.
- If you use the product in a location exposed to excessive vibrations, it may result in a problem with the product or fire.

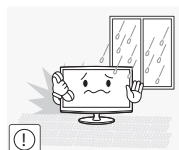

Avoid installing the product in a location exposed to dust, moisture (sauna), oil, smoke or water (rain drops) and installing it within a vehicle.

- This may result in electric shock or fire.

Getting Started



Avoid installing the product in a location exposed to direct sunlight and installing the product near a heat source such as a fireplace or heater.

- This may shorten the product life cycle or cause fire.

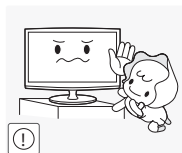

Avoid installing the product where children may reach it.

- If a child touches the product, the product may fall and this may result in injury.
- Since the front part is heavier, install the product on a flat and stable surface.



Bend the outdoor antenna cable downwards at the location where it comes in the house so that rainwater does not flow in.

- If rainwater enters the product, it may result in electric shock or fire.

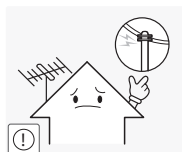

Install the antenna far away from any high voltage cables.

- If the antenna touches or falls onto a high voltage cable, it may result in electric shock or fire.

! Caution



Do not let the product drop while moving it.

- This may result in a problem with the product or injury.

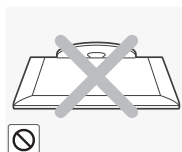

Do not place the product face down on the floor.

- This may damage the panel of the product.

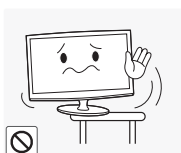

When installing the product on a console or shelf, make sure that the front of the product does not protrude out of the console or shelf.

- Otherwise, this may cause the product to fall off and result in a malfunction or injury.
- Make sure to use a cabinet or shelf suitable to the size of the product.



When putting the product down, handle it gently.

- Otherwise, it may result in a problem with the product or injury.



If the product is installed in a location where the operating conditions vary considerably, a serious quality problem may occur due to the surrounding environment. In this case, install the product only after consulting one of our service engineers about the matter.

- Places exposed to microscopic dust, chemicals, too high or low temperature, high humidity, airports or stations where the product is continuously used.

Getting Started

Cleaning Related

Warning

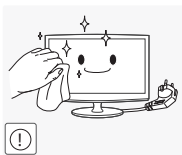

Before cleaning the product, unplug the power cord.

- Otherwise, it may result in electric shock or fire.



When cleaning the product, do not spray water directly over the product parts.

- Make sure that water does not enter the product.
- Otherwise, it may result in fire, electric shock or a problem with the product.

Caution



Avoid spraying cleansing agent directly onto the product.

- This may result in discoloration or cracking of the exterior of the product or the panel coming off.

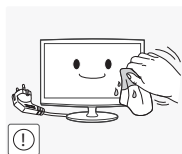

When cleaning the product, disconnect the power cord and clean the product with the supplied cleaning cloth.

- Avoid using chemicals such as wax, benzene, alcohol, thinner, mosquitorepellent, fragrance, lubrication or cleansing agent when cleaning the product.

This may result in the exterior being deformed or the print being removed.

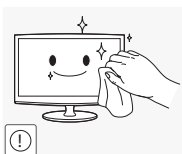

If you can't get the product clean with just the supplied cloth, use a soft, damp cloth with a "monitor-exclusive cleansing agent" and wipe the product with it.

- If no monitor-exclusive cleansing agent is available, dilute a cleansing agent with water at a ratio of 1:10 before cleaning the product.



Since the exterior of the product is easily scratched, be sure to use the supplied cleansing cloth.

Usage Related

Warning

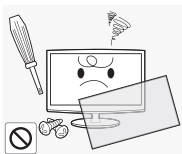

Since a high voltage runs through the product, never disassemble, repair or modify the product yourself.

- Otherwise, it may result in fire or electric shock.
- If the product needs to be fixed, contact a service center.



To move the product, turn the power off and unplug the power cord, the antenna cable and any other wires connected to the product.

- Otherwise, it may result in electric shock or fire due to the damaged power cord.

Getting Started



If the product generates a strange noise, a burning smell, or smoke, unplug the power plug immediately and contact a service center.

- Otherwise, it may result in electric shock or fire.

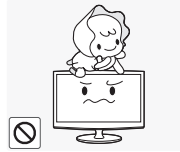

Avoid letting children hang or climb onto the product.

- Otherwise, it may result in the product falling and this may result in injury or death.



If you drop the product or the case is damaged, turn the power off and unplug the power cord. Contact a service center.

- Otherwise, it may result in fire or electric shock.



Avoid placing objects such as toys and cookies on top of the product.

- If a child hangs over the product to grab an object, the object or the product may fall and this may result in injury or even death.

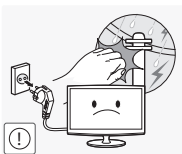

When thunder or lightning occurs, unplug the power cord and under no circumstance touch the antenna cable as this is dangerous.

- Otherwise, it may result in electric shock or fire.



Avoid dropping an object over the product or cause impact to the product.

- Otherwise, it may result in electric shock or fire.

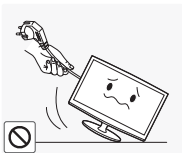

Avoid moving the product by pulling the power cord or antenna cable.

- Otherwise, it may result in electric shock, fire or a problem with the product due to damage to the cable.



When a gas leak occurs, do not touch the product or the power plug and ventilate immediately.

- A spark may result in an explosion or fire.
- During a thunder or lightning storm, do not touch the power cord or antenna cable.

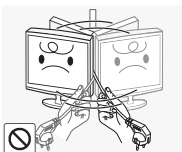

Avoid lifting up or moving the product by holding only the power cord or signal cable.

- Otherwise, it may result in electric shock, fire or a problem with the product due to damage to the cable.



Avoid using or placing inflammable spray or objects near the product.

- This may result in an explosion or fire.

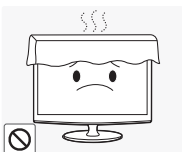

Take care not to block the vent by a table cloth or curtain.

- Otherwise, it may result in fire due to internal overheating.

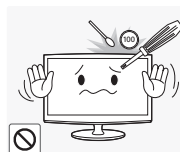

Avoid inserting metal objects such as a chopsticks, coins or hairpins, or inflammable objects into the product (the vents, ports, etc).

- If water or substances enters the product, turn the power off, unplug the power cord and contact a service center.
- Otherwise, it may result in a problem with the product, electric shock or fire.

Getting Started

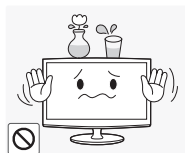

Avoid placing a liquid container such as a vase, flowerpot, beverage, cosmetics or drugs, or a metal object over the product.

- If water or substances enter the product, turn the power off, unplug the power cord and contact a service center.
- Otherwise, it may result in a problem with the product, electric shock or fire.



Do not press down hard on the product. The product may become deformed or damaged.

⚠ Caution



Displaying a still image for a long time may create a persistent image or stain on the screen.

- If you do not use the product for a long time, use the power-saving mode or set the screensaver to the moving picture mode.

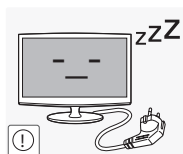

When not using the product for a long time such as leaving your home, unplug the power cord from the wall outlet.

- Otherwise, it may cause dust accumulation and result in fire caused by overheating or short circuit or result in an electric shock.



Set the appropriate resolution and frequency for the product.

- Otherwise, it may result in eye strain.

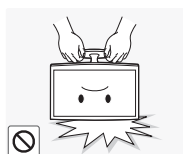

Avoid turning the product upside down or move the product holding only the stand.

- This may cause the product to fall, resulting in damage to the product or injury.



Watching the product from too close a distance continuously may damage your eyesight.



Avoid using a humidifier or cooker near the product.

- Otherwise, it may result in electric shock or fire.

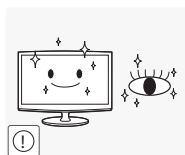

It is important to give your eyes some rest (5 minutes every hour) when viewing the product screen for long periods of time.

- This will alleviate any eye strain.



Since the display panel is hot after using it for a long time, do not touch the product.

Getting Started

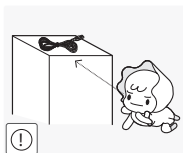

Keep the small accessories in a location out of the reach of children.

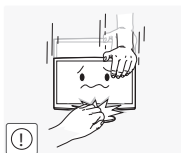

Take care when adjusting the angle of the product or the height of the stand.

- If your hand or finger is caught, you may be injured.
- If the product is tilted excessively, the product may fall and this may result in injury.

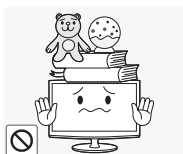

Avoid placing a heavy object over the product.

- Otherwise, it may result in a problem with the product or injury.

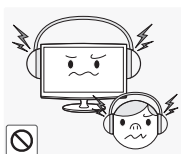

When using headphones or earphones, do not turn the volume too high.

- Having the sound too loud may damage your hearing.



Be careful that children do not place the batteries in their mouths when removed from the remote control. Place the battery in a location that children or infants cannot reach.

- If children have had the battery in their mouths, consult your doctor immediately.

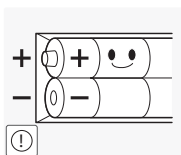

When replacing the batteries, insert them with right polarity (+, -).

- Otherwise, the battery may become damaged or it may cause fire, personal injury or damage due to leakage of the internal liquid.

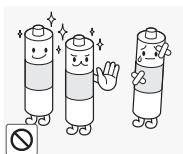

Use only specified standard batteries. Do not use new and used batteries together.

- This may cause a battery to break or leak and may cause fire, injury, or contamination (damage).

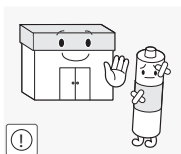

The batteries (and rechargeable batteries) are not ordinary refuse and must be returned for recycling purposes. The customer is responsible for returning the used or rechargeable batteries for recycling.

- The customer can return used or rechargeable batteries to a nearby public recycling center or to a store selling the same type of the battery or rechargeable battery.

Getting Started

List of Features

- **Media Play (USB)**

Allows you to play music files and pictures saved on a USB device.

Accessories

Please make sure the following items are included with your TV. If any items are missing, contact your dealer.

The items' colors and shapes may vary depending on the model.

Check that there is no accessory hidden behind packing materials when you open the box.

- Remote Control (AA59-00821A) & Batteries (AAA x 2)
- User Manual (CD)
- Power Cord
- Warranty Card / Safety Guide / Quick Setup Guide
- Adapter



HDMI Cable
(Not available in all locations)

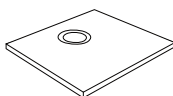

Stand Base



Stand Connector

Input Cables (Sold Separately)



D-Sub



Stereo



Component



Composite (AV)



Coaxial (RF)



HDMI-DVI

Check the cable before plug-in

	Cable	Ports
HDMI		
USB		



Do not plug cable upside down.
Be sure to check before plug-in.



Getting Started

Viewing the Control Panel

 The product color and shape may vary depending on the model.

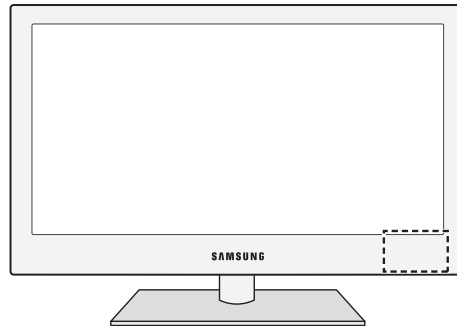
For TC730



SOURCE 	Toggles between all the available input sources. In the on-screen menu, use this button as you would use the ENTER  button on the remote control.
MENU	Displays an on-screen menu, the OSD (on screen display) of your TV's features.
-VOL+	Adjusts the volume. In the OSD, use the -VOL+ buttons as you would use the ◀ and ▶ buttons on the remote control.
▼ CH ▲	Changes the channels. In the OSD, use the ▼ CH ▲ buttons as you would use the ▼ and ▲ buttons on the remote control.
 (Power)	Turns the TV on or off.
Remote control sensor	Aim the remote control towards this spot on the TV.
Power Indicator	Blinks and turns off when the power is on and lights up in standby mode.

Getting Started

For TC350 and TC550

The TV's Controller, a small joystick like button on the central of the TV, lets you control the TV without the remote control.

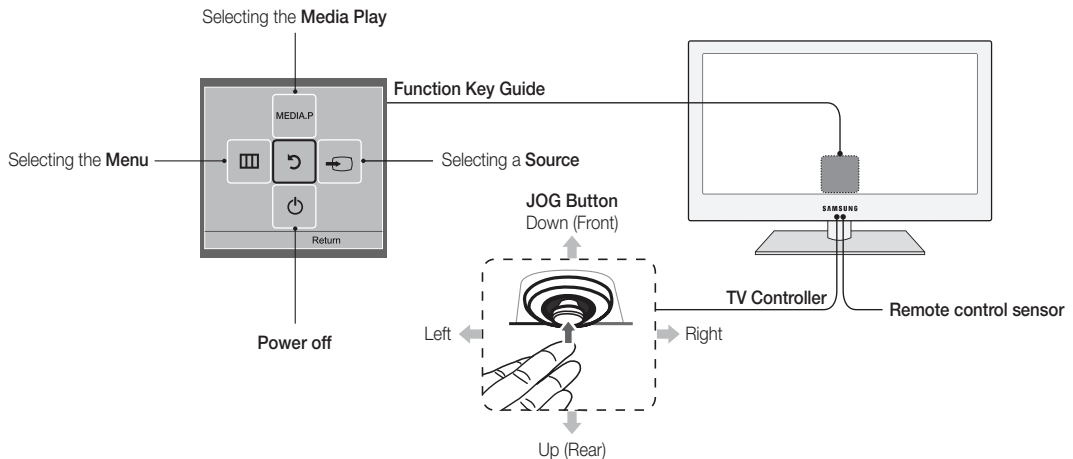

Exits the menu when pressing the controller more than 1 second.

When selecting the function by moving the controller to the up/down/left/ right directions, be sure not to press the controller. If you press it first, you cannot operate it to move the up/down/left/right directions.

Standby mode

Your TV enters Standby mode when you turn it off and continues to consume a small amount of electric power. To be safe and to decrease power consumption, do not leave your TV in standby mode for long periods of time (when you are away on a holiday, for example). It is best to unplug the power cord.

Useful Information

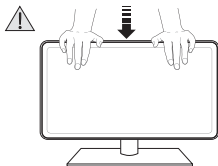

Caution

Do not press down hard on the product.

- The product may become deformed and damaged.

Getting Started

Viewing the Remote Control

 This is a special remote control for the visually impaired and has Braille points on the Channel and Number "5" button.

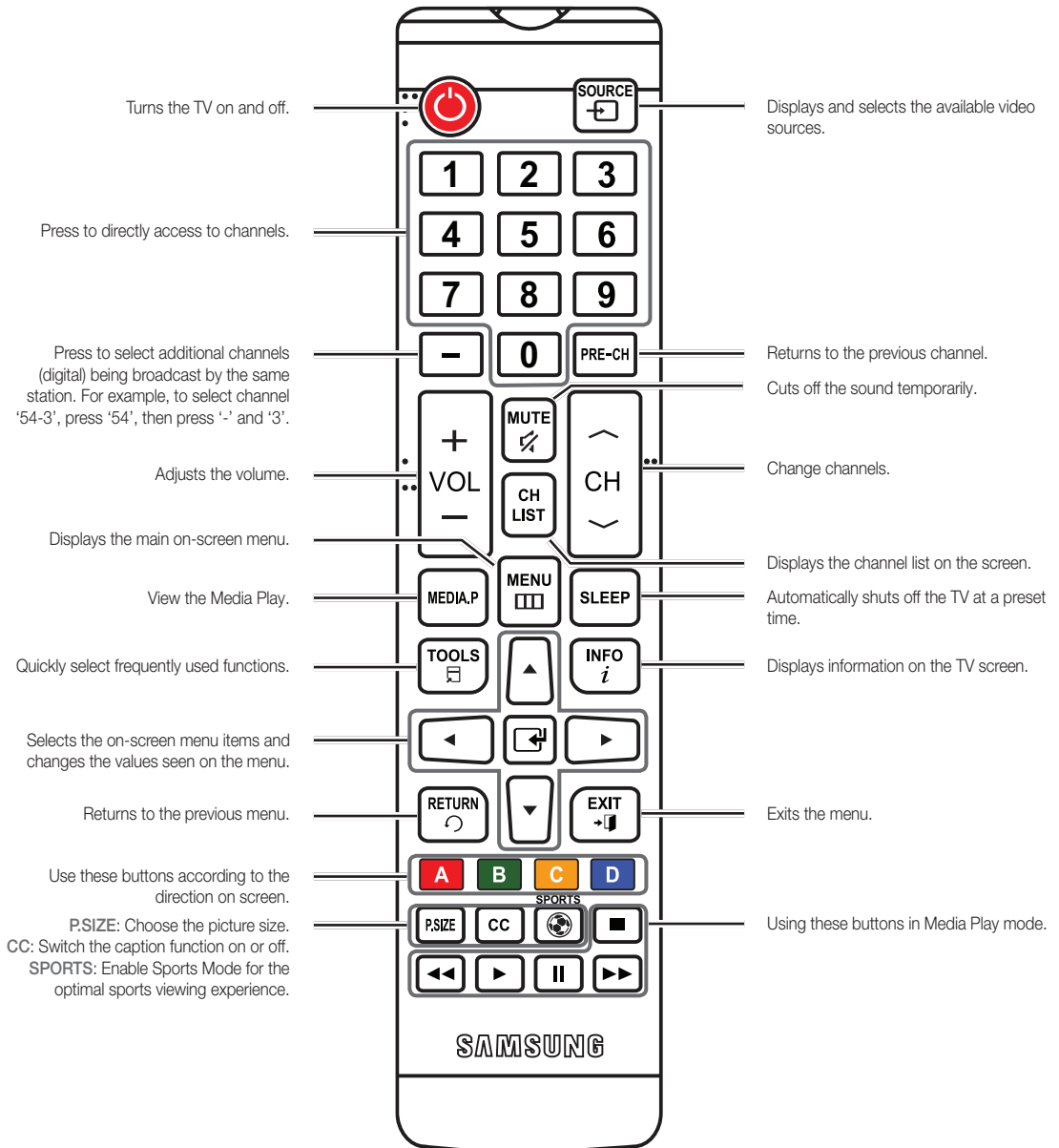

Installing batteries (Battery size: AAA)

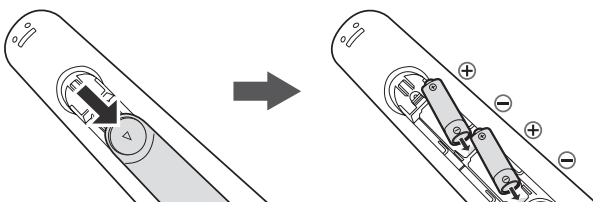

- Use the remote control within 23 feet from the TV.
- Bright light may affect the performance of the remote control. Avoid use when nearby fluorescent lights or neon signs.
- The color and shape may vary depending on the model.

Getting Started

How to Navigate Menus

Before using the TV, follow the steps below to learn how to navigate the menu and select and adjust different functions.

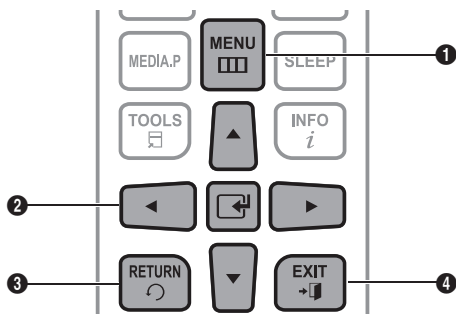

- 1 **MENU** button: Displays the main on-screen menu.
- 2 **ENTER** / Direction button: Move the cursor and select an item. Confirm the setting.
- 3 **RETURN** button: Returns to the previous menu.
- 4 **EXIT** button: Exits the on-screen menu.

How to Operate the OSD (On Screen Display)

The access steps may differ depending on the selected menu.

1	MENU	The main menu options appear on the screen: Picture, Sound, Channel, Setup, Input, Application, Support.
2	▲ / ▼	Select an icon or option with the ▲ or ▼ button.
3	ENTER	Press ENTER to access the sub-menu.
4	▲ / ▼	Select the desired submenu with the ▲ or ▼ button.
5	◀ / ▶	Adjust the value of an item with the ◀ or ▶ button. The adjustment in the OSD may differ depending on the selected menu.
6	ENTER	Press ENTER to confirm the selection.
7	EXIT	Press EXIT .

Connecting to an Antenna

Connecting the adapter and an antenna or cable connection

When you move or swivel the TV with Antenna cable tightly connected, there is high risk antenna jack on TV will be broken off.

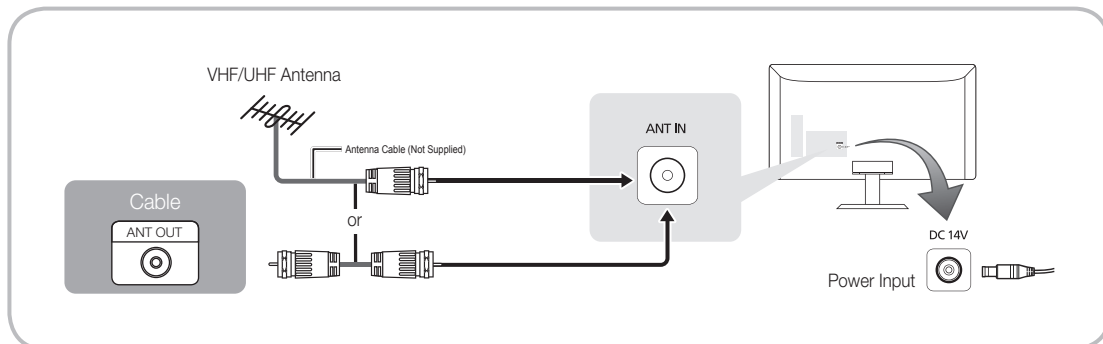

Connect the power adapter to **DC 14V** on the rear of the product. Connect the power cord to the adapter and wall socket. (The input voltage is switched automatically.)











Getting Started

Plug & Play (Initial Setup)

When you turn the TV on for the first time, a sequence of on-screen prompts will assist in configuring basic settings. To turn on the TV, press the **POWER**  button.

 **Plug & Play** is available only when the **Source List** is set to **TV**.

 Before turning on the TV, make you have connected the TV to an antenna or cable connection (p. 15).

1	Selecting a language	Press the ▲ or ▼ button, then press the ENTER  button. Select the desired OSD (On Screen Display) language.	
2	Selecting Store Demo or Home Use	Press the ◀ or ▶ button, then press the ENTER  button. <ul style="list-style-type: none">• Select the Home Use mode. Store Demo Mode is for retail environments.• To return the unit's settings from Store Demo to Home Use (standard): Press the volume button on the TV. When you see the volume OSD, press and hold MENU for 5 sec. (for TC730)• To return the unit's settings from Store Demo to Home Use: Press TV controller on the TV to open function OSD, then select SOURCE  by moving TV controller to right direction, press and hold for 5 seconds. (for TC350 and TC550).	
3	Selecting search options for auto tuning	Press the ▲ or ▼ button, then press the ENTER  button. Select Air , Cable or Auto .  If you selected Cable , you'll go to the cable system screen. Use the ▲ or ▼ button to select the correct cable signal format - STD , HRC , or IRC - and then press ENTER  . Most cable systems use STD . Select the correct cable signal format for both the Digital and Analog systems.  When done, select Start , and the press ENTER  .	
4	Setting the Clock Mode	Set the Clock Mode automatically or manually. <ul style="list-style-type: none">• Auto: Allows you to select DST (Daylight Saving Time) mode and time zone.• Manual: Allows you to manually set the current date and time (p. 28).	
5	View the HDTV Connection Guide	The connection method for the best HD screen quality is displayed.	
6	Enjoy the TV.	Press the ENTER  button.	

If You Want to Rerun Plug & Play...

MENU  → **Setup** → **Plug & Play** → **ENTER** 

NOTE

- To change the TV's setting from **Store Demo** to **Home Use** when not in **Plug & Play**, press the volume button on the TV. When you see the volume in the OSD, press and hold **MENU** for 5 sec. (for TC730)
- To return the unit's settings from **Store Demo to Home Use**: Press TV controller on the TV to open function OSD, then select **SOURCE**  by moving TV controller to right direction, press and hold for 5 seconds. (for TC350 and TC550).

Connections

Connecting to an AV Device

Using an HDMI or HDMI/DVI Cable: HD connection (up to 1080p)

We recommend using the HDMI connection for the best quality HD picture.

Available devices: DVD, Blu-ray player, HD cable box, HD STB (Set-Top-Box) satellite receiver

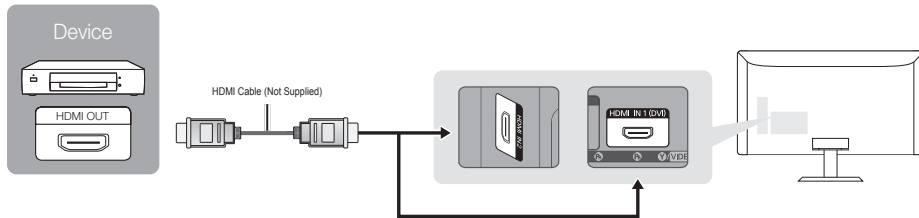



HDMI IN 1 (DVI), HDMI IN 2, PC/DVI AUDIO IN

- When using an HDMI/DVI cable connection, you must use the **HDMI IN 1 (DVI)** jack for video. A DVD, Blu-ray player, HD cable box, or HD STB satellite receiver may require a DVI-HDMI (DVI to HDMI) cable or DVI-HDMI (DVI to HDMI) adapter.
 - The picture may not display normally (if at all) or the audio may not work if an external device that uses an older version of HDMI mode is connected to the TV. If such a problem occurs, ask the manufacturer of the external device about the HDMI version and, if out of date, request an upgrade.
 - Be sure to purchase a certified HDMI cable. Otherwise, the picture may not display or a connection error may occur.
 - For better picture and audio quality, connect to a digital device using an HDMI cable.
 - An HDMI cable supports digital video and audio signals, and does not require an audio cable.
 - To connect the TV to a digital device that does not support HDMI output, use an HDMI/DVI and audio cables.
-  If an HDMI to DVI cable is connected to the **HDMI IN 1 (DVI)** port, the audio does not work.

Using a Component (up to 1080p) or Audio/Video (480i only) Cable

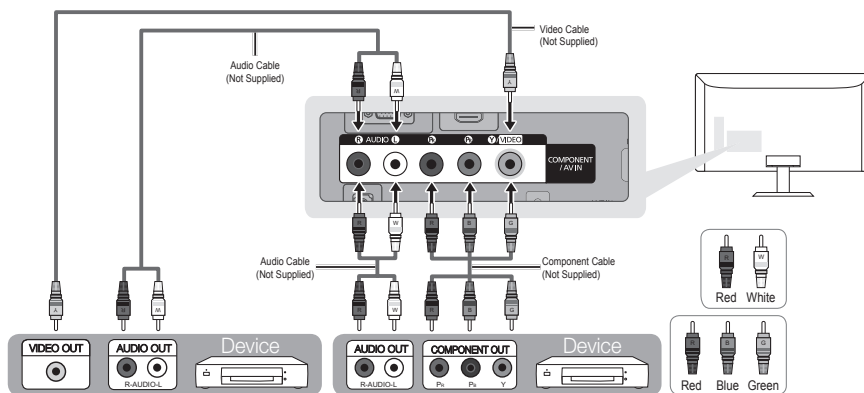
Available devices: DVD, Blu-ray player, cable box, STB satellite receiver, VCR



-  When connecting to **AV IN**, the color of the **AV IN [Y/VIDEO]** jack (green) will not match the video cable (yellow).
-  For better picture quality, the Component connection is recommended over the A/V connection.

Connections

Connecting to the headphone

Using a Headphone Connection

Headphone: You can connect your headphone to the headphone output on your set. While the headphone is connected, the sound from the built-in speaker will be disabled.

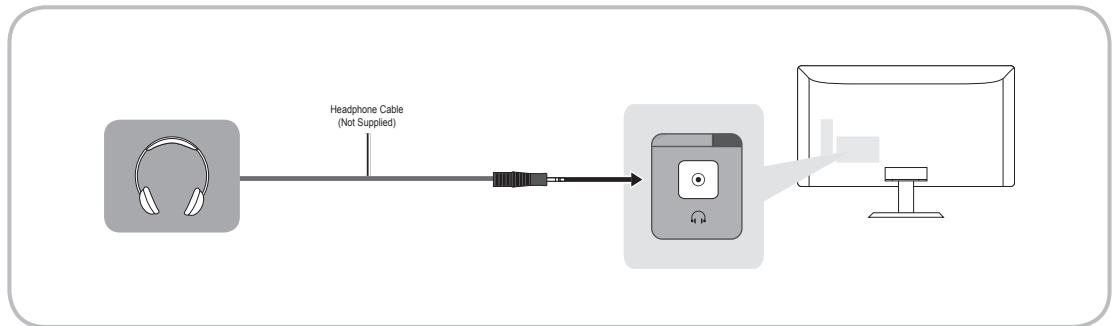

The earphone jack supports only the 3 conductor tip-ring-sleeve (TRS) type.

Connecting to a PC

Using an HDMI Cable or an HDMI to DVI Cable or a D-sub Cable Connection

Your PC may not support an HDMI connection.

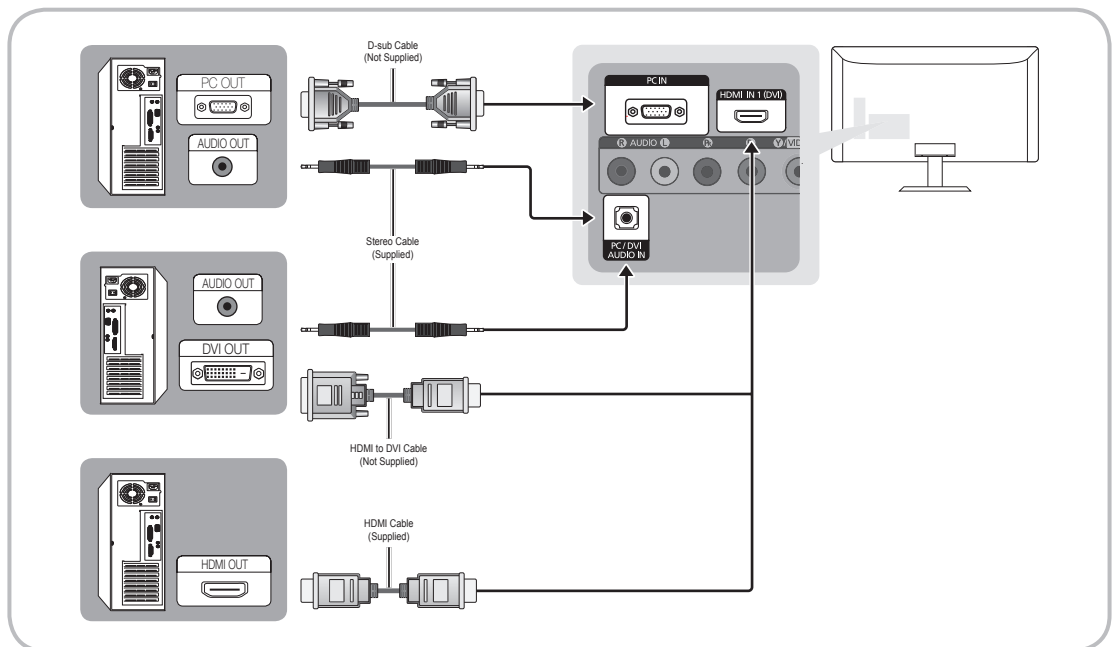

NOTE

- For an HDMI to DVI cable connection, you must use the HDMI IN 1 (DVI) jack.
- For PCs with DVI video out jacks, use an HDMI to DVI cable to connect the DVI out on the PC to the HDMI IN 1 (DVI) jack on the product.

Connections

Display Modes (D-sub and HDMI/DVI Input)

If the signal from the PC is one of the following standard signal modes, the screen is set automatically. However, if the signal from the PC is not one of the following signal modes, a blank screen may be displayed or only the Power LED may be turned on. Therefore, configure it as follows referring to the User Manual of the graphics card.

1366 X 768 (T19C350 model only)

Display Mode			Horizontal Frequency (kHz)	Vertical Frequency (Hz)	Pixel Clock (MHz)	Sync Polarity (H/V)
Mode	Resolution					
IBM	720 x 400	70Hz	31.469	70.087	28.322	-/+
VESA DMT	640 x 480	60Hz	31.469	59.940	25.175	-/-
MAC	640 x 480	67Hz	35.000	66.667	30.240	-/-
VESA DMT	640 x 480	72Hz	37.861	72.809	31.500	-/-
VESA DMT	640 x 480	75Hz	37.500	75.000	31.500	-/-
VESA DMT	800 x 600	60Hz	37.879	60.317	40.000	+/+
VESA DMT	800 x 600	72Hz	48.077	72.188	50.000	+/+
VESA DMT	800 x 600	75Hz	46.875	75.000	49.500	+/+
MAC	832 x 624	75Hz	49.726	74.551	57.284	-/-
VESA DMT	1024 x 768	60Hz	48.363	60.004	65.000	-/-
VESA DMT	1024 x 768	70Hz	56.476	70.069	75.000	-/-
VESA DMT	1024 x 768	75Hz	60.023	75.029	78.750	+/+
VESA DMT	1280 x 720	60Hz	45.000	60.000	74.250	+/+
VESA DMT	1366 x 768	60Hz	47.712	59.790	85.500	+/+

Connections

1920 X 1080

Display Mode			Horizontal Frequency (kHz)	Vertical Frequency (Hz)	Pixel Clock (MHz)	Sync Polarity (H/V)
Mode	Resolution					
IBM	720 x 400	70Hz	31.469	70.087	28.322	-/+
VESA DMT	640 x 480	60Hz	31.469	59.940	25.175	-/-
MAC	640 x 480	67Hz	35.000	66.667	30.240	-/-
VESA DMT	640 x 480	72Hz	37.861	72.809	31.500	-/-
VESA DMT	640 x 480	75Hz	37.500	75.000	31.500	-/-
VESA DMT	800 x 600	60Hz	37.879	60.317	40.000	+/+
VESA DMT	800 x 600	72Hz	48.077	72.188	50.000	+/+
VESA DMT	800 x 600	75Hz	46.875	75.000	49.500	+/+
MAC	832 x 624	75Hz	49.726	74.551	57.284	-/-
VESA DMT	1024 x 768	60Hz	48.363	60.004	65.000	-/-
VESA DMT	1024 x 768	70Hz	56.476	70.069	75.000	-/-
VESA DMT	1024 x 768	75Hz	60.023	75.029	78.750	+/+
VESA DMT	1152 x 864	75Hz	67.500	75.000	108.000	+/+
MAC	1152 x 870	75Hz	68.681	75.062	100.000	-/-
VESA DMT	1280 x 720	60Hz	45.000	60.000	74.250	+/+
VESA DMT	1280 x 800	60Hz	49.702	59.810	83.500	-/+
VESA DMT	1280 x 1024	60Hz	63.981	60.020	108.000	+/+
VESA DMT	1280 x 1024	75Hz	79.976	75.025	135.000	+/+
VESA DMT	1366 x 768	60Hz	47.712	59.790	85.500	+/+
VESA DMT	1440 x 900	60Hz	55.935	59.887	106.500	-/+
VESA DMT	1600 x 900RB	60Hz	60.000	60.000	108.000	+/+
VESA DMT	1680 x 1050	60Hz	65.290	59.954	146.250	-/+
VESA DMT	1920 x 1080	60Hz	67.500	60.000	148.500	+/+

NOTE

- The interlace mode is not supported.
- The set may operate abnormally if you select a non-standard video format.
- Separate and Composite modes are supported. SOG(Sync On Green) is not supported.

 If there is no power cut-off switch, the power consumption is "0" only when the power cord is disconnected.

 DPM(Display Power Management) Function does not work if you used in connection with the HDMI port of this product.

Basic Features

Changing the Input Source

Source List

Use to select TV or an external input sources such as a DVD / Blu-ray player / cable box / STB satellite receiver.

MENU → Input → Source List → ENTER



■ TV / AV / Component / HDMI1/DVI / HDMI2 / PC

1. Press the **SOURCE** button on your remote.
2. Select a desired external input source.
 - You can only choose external devices that are connected to the TV. In the **Source List**, connected inputs will be highlighted.

Edit Name

MENU → Input → Edit Name → ENTER

In the Source List, press the **TOOLS** button, and then you can set an external input sources name you want.

■ VCR / DVD / Cable STB / Satellite STB / PVR STB / AV Receiver / Game / Camcorder / PC / DVI PC / DVI / TV / IPTV / Blu-ray / HD DVD / DMA: Name the device connected to the input jacks to make your input source selection easier.

- If you have connected a PC to the **HDMI IN 1 (DVI)** port with an HDMI cable, select **PC** under **Edit Name** to enter a device name.
- If you have connected a PC to the **HDMI IN 1 (DVI)** port with an HDMI to DVI cable, select **DVI PC** under **Edit Name** to enter a device name.
- If you connected an AV device to the **HDMI IN 1 (DVI)** port with an HDMI to DVI cable, select **DVI** under **Edit Name** to enter a device name.

Information

You can see detailed information about the selected external device.

Channel Menu

Seeing Channels

Channel List

MENU → Channel → Channel List → ENTER

Select a channel in the **All Channels**, **Added Channels**, **Favorite** or **Programmed** screen by pressing the **▲ / ▼** and **ENTER** buttons. Then you can watch the selected channel.

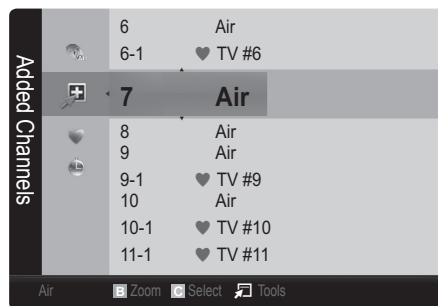

- **All Channels**: Shows all currently available channels.
- **Added Channels**: Shows all added channels.
- **Favorite**: Shows all favorite channels.
- **Programmed**: Shows all currently reserved programs.

- Using the color buttons with the **Channel List**.
 - **Green (Zoom)**: Enlarges or shrinks a channel number.
 - **Yellow (Select)**: Selects multiple channel lists. Select desired channels and press the Yellow button to set all the selected channels at the same time. The **✓** mark appears to the left of the selected channels.
 - **(Tools)**: Displays the **Channel List** option menu. (The options menus may differ depending on the situation.)

Channel Status Display Icons

Icons	Operations
✓	A channel selected.
♥	A channel set as a Favorite.
⌚	A reserved Program.

Basic Features

Using Favorite Channels

MENU → Channel → Channel List → ENTER

♥ Add to Favorite / Delete from Favorite

TOOLS

Set channels you watch frequently as Favorites.

1. Select a channel and press the **TOOLS** button.
2. Add or delete a the channel using the **Add to Favorite** or **Delete** from **Favorite** menu respectively.

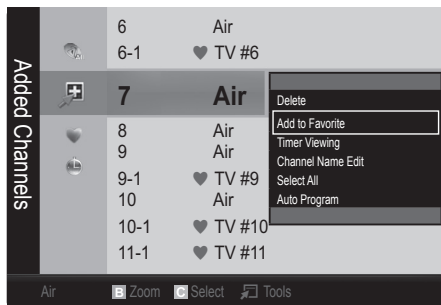

To show all Favorite channels, click on the button shown on the right.

Memorizing Channels

MENU → Channel → ENTER

Antenna (Air / Cable) **TOOLS**

Before your television can begin memorizing the available channels, you must specify the type of signal source that is connected to the TV (i.e. an **Air** or a **Cable** system).

Auto Program

Automatically registers available Air / Cable channels to the TV.

- **Air:** Air antenna signal.
- **Cable:** Cable antenna signal.
- **Auto:** Air and Cable antenna.

NOTE

- When selecting the Cable TV system: **STD**, **HRC** and **IRC** identify various types of cable TV systems. Contact your local cable company to identify the type of cable system that exists in your particular area. At this point, the signal source has been selected.
- After all the available channels are stored, it starts to remove scrambled channels. The **Auto Program** menu then reappears.

How to Stop Auto Programming

1. Press the ENTER button.
2. A message will ask **Stop Auto Program?**. Select **Yes** by pressing the ◀ or ▶ button.
3. Press the ENTER button.

Editing Channels

MENU → Channel → Channel List → ENTER

Channel Name Edit

1. Select a channel and press the **TOOLS** button.
 2. Edit the channel name using the **Channel Name Edit** menu.
- **Channel Name Edit** (analog channels only): Assign your own channel name.

Other Features

MENU → Channel → ENTER

Clear Scrambled Channel

This function is used to filter out scrambled channels after Auto Program is completed. This process may take up to 20–30 minutes.

How to Stop Searching Scrambled Channels

1. Press the ENTER button to select **Stop**.
2. Press the ◀ button to select **Yes**.
3. Press the ENTER button.

This function is only available in **Cable** mode.

Basic Features

Channel List

MENU  → Channel → Channel List → ENTER 

Channel List Option Menu

Set each channel using the Channel List menu options (**Add / Delete**, **Timer Viewing**, **Select All / Deselect All**). Option menu items may differ depending on the channel status.

1. Select a channel and press the **TOOLS** button.
 2. Select a function and change its settings.
- **Add / Delete:** Delete or add a channel to display the channels you want.
 -  **NOTE**
 - All deleted channels will be shown on the **All Channels** menu.
 - A gray-colored channel indicates the channel has been deleted.
 - The **Add** menu only appears for deleted channels.
 - Delete a channel from the **Added Channels** or **Favorite** menu in the same manner.

- **Timer Viewing:** You can set a desired channel to be displayed automatically at the reserved time. Set the current time first to use this function.

1. Press the ◀ / ▶ / ▲ / ▼ buttons to select the desired channel in **Channel List**.
2. Press the **TOOLS** button, then select **Timer Viewing**.
3. Scroll up or down to adjust the settings in the box, or use the numeric buttons on your remote to enter the date and time.

 If you selected **Once**, **Every Week** or **Everyday** in **Repeat**, you can enter the date you want.

4. Press the ENTER  button.

NOTE

- Only memorized channels can be reserved.
- Reserved programs will be displayed in the **Programmed** menu.
- When a digital channel is selected, press the ▶ button to view the digital program.

- **Select All:** Select all the channels in the channel list.



- **Deselect All:** Deselect all the selected channels.

 You can only select **Deselect All** when one or more channels are selected.

Programmed

(in Channel List)

You can view, modify or delete a show you have reserved to watch. **Programmed** timer viewing is displayed here. Highlight a program and press the **TOOLS** button to display Options.

- **Change Info:** Change a show you have reserved to watch. Begin with step 3 of “Timer Viewing” above.
- **Cancel Schedules:** Cancel a show you have reserved to watch.
 -  This deletes the highlighted or selected program(s).
- **Information:** Display a show you have reserved to watch. (You can also change the reservation Information.)
 -  Alternatively, you can view Information by highlighting a program and pressing the ENTER  button.
- **Select All / Deselect All:** Select or deselect all reserved programs.

Fine Tune

(analog channels only)

If the reception is clear, you do not have to fine tune the channel, as this is done automatically during the search and store operation. If the signal is weak or distorted, fine tune the channel manually. Scroll to the left or right until the image is clear.

 Settings are applied to the channel you're currently watching.

 Fine tuned channels that have been saved are marked with an asterisk “*” on the right-hand side of the channel number in the channel banner.

 To reset the fine-tuning, select **Reset**.

Basic Features

Picture Menu

Changing the Preset Picture Mode

MENU → Picture → Mode → ENTER

Mode

Picture modes apply preset adjustments to the picture. Select a mode using the up and down arrow keys, and then press the ENTER button.

When connecting a PC, you can only make changes to the **Entertain** or **Standard**.

- **Dynamic:** Suitable for a bright room.
- **Standard:** Suitable for a normal environment.
- **Movie:** Suitable for watching movies in a dark room.
- **Entertain:** Suitable for watching movies and games.

It is only available in PC mode.

Adjusting Picture Settings

MENU → Picture → ENTER

Samsung MagicAngle

(It's only available in TC350/TC550.)

This feature allows you to see optimal screen quality according to your viewing position. When viewing the screen at an angle from below, above or the side of the product, by setting the appropriate mode for each position you can obtain a similar picture quality as viewing the screen directly from the front.

- **Off:** Select when viewing from the front position.
- **Lean Back Mode:** Select when viewing from a slightly lower position.
- **Standing Mode:** Select when viewing from the upper position.
- **Mode (1-10):** Determines the amount of adjustment. Numbers closer to 10 are best for lower viewing positions.

When Samsung MagicAngle is set to Lean back mode or Standing Mode, Gamma is not available.

Backlight / Contrast / Brightness / Sharpness / Color / Tint (G/R)

MENU → Picture → ENTER

Your television has several setting options for picture quality control.

NOTE

- When you make changes to **Backlight**, **Contrast**, **Brightness** or **Sharpness** the OSD will be adjusted accordingly.
- When connecting a **PC**, you can only make changes to **Backlight**, **Contrast**, **Brightness** and **Sharpness**.
- Settings can be adjusted and stored for each external device connected to the TV.
- Lowering picture brightness reduces power consumption.

Response Time

Accelerate the panel response rate to make video appear more vivid and nature.

Auto Adjustment

Frequency values/position and fine tune are adjusted automatically.

It's only available in PC mode.

Screen

You can increase the picture quality by adjusting the frequency and performing fine-tuning

It's only available in PC mode.

- **Coarse:** Adjusts the frequency when vertical noise appears on the screen (0-100).
- **Fine:** Adjusts the screen to be clearer (0-100).
- **PC Position:** Optimizes the horizontal and vertical picture position of the TV.
- **Image Reset:** Resets the PC settings to the default values.

Basic Features

Changing the Picture Options

Advanced Settings

MENU → Picture → Advanced Settings → ENTER

Advanced Settings are available in the **Standard** and **Movie** modes. When connecting a PC, you can only make changes to **Gamma** and **White Balance**. They are not available when you are watching a digital channel.

To use, select an option using the up and down arrow keys, and then press ENTER . Use the arrow keys to change a value or setting, and then press ENTER .

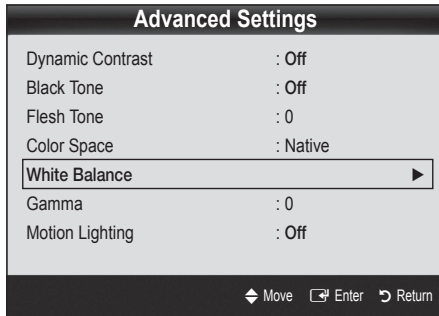

- **Dynamic Contrast (Off / Low / Medium / High):** Adjust the screen contrast.
- **Black Tone (Off / Dark / Darker / Darkest):** Select the black level to adjust the screen depth.
- **Flesh Tone:** Emphasize pink "Flesh Tone."
- **Color Space (Auto / Native):** Adjusts the range of colors (the color gamut) available to create images.
- **White Balance:** Adjusts the red, green, and blue brightness so that the brightest point of a picture becomes white.
R-Offset / G-Offset / B-Offset: Adjust each color's (red, green, blue) darkness.
R-Gain / G-Gain / B-Gain: Adjust each color's (red, green, blue) brightness.
Reset: Resets the **White Balance** to its default settings.
- **Gamma:** Adjust the primary color intensity.
- **Motion Lighting (Off / On):** Reduces power consumption by reducing screen brightness when the picture on the screen is in motion.

Picture Options

MENU → Picture → Picture Options → ENTER

Select an option using the up and down arrow keys, and then press ENTER . Use the arrow keys to change the setting, and then press ENTER .

When connecting a PC, you can only make changes to the **Color Tone, Size.**

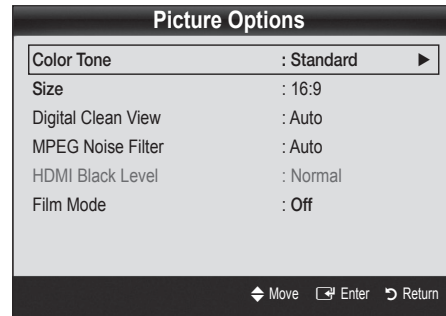

■ Color Tone (Cool / Standard / Warm1 / Warm2)

Warm1 or **Warm2** will be activated when the picture mode is **Movie**.

You can adjust and store settings for each external device you have connected to an input on the TV.

- **Size:** If you have a cable box or satellite receiver, it may have its own set of screen sizes as well. However, we highly recommend you use your TV's 16:9 mode most of the time.



16:9: Sets the picture to 16:9 wide mode.

Zoom1: Use for moderate magnification. Cuts off the top and sides.

Zoom2: Use for a stronger magnification.

Wide Fit: Enlarges the aspect ratio of the picture to fit the entire screen.

Available with HD 1080i / 720p signals in 16:9 mode.









4:3 : Sets the picture to basic (4:3) mode.

Do not watch in 4:3 format for a long time. Traces of borders displayed on the left, right and center of the screen may cause image retention (screen burn) which are not covered by the warranty.

Screen Fit: Displays the full image without any cut-off when HDMI (720p / 1080i / 1080p) or Component (1080i / 1080p) signals are inputted.

Basic Features

NOTE



- After selecting **Zoom1**, **Zoom2** or **Wide Fit**:
 1. Press the ► button to select **Position**.
 2. Press the ENTER  button.
 3. Press the ▲ or ▼ button to move the picture up or down.
 4. Press the ENTER  button.
-  If you want to reset the pictures to its original position, select **Reset**, and then press ENTER . The picture will be reset to its default position.
- After selecting **Screen Fit** in HDMI (1080i/1080p) or Component (1080i/1080p) mode, you may need to center the picture:
 1. Press the ◀ or ▶ button to select **Position**.
 2. Press the ENTER  button.
 3. Press the ▲, ▼, ◀ or ▶ button to move the picture.
 4. Press the ENTER  button.
-  If you want to reset the pictures to its original position, select **Reset**, and then press ENTER . The picture will be reset to its default position.
- HD (High Definition): 16:9 - 1080i/1080p (1920x1080), 720p (1280x720)
- Settings can be adjusted and stored for each external device you have connected to an input on the TV.

Input Source	Picture Size
ATV, AV, Component (480i, 480p)	16:9, Zoom1, Zoom2, 4:3
DTV(1080i), Component (1080i, 1080p), HDMI (720p, 1080i, 1080p)	16:9, 4:3, Wide Fit, Screen Fit

Maintaining the Correct Posture when Using this Product



Maintain the correct posture when using this product.

- Straighten your back.
 - Keep a distance of 45~50 cm (15~19 inches) from your eyes to the screen. Look down at the screen and face the screen forwards.
 - Adjust the angle of the product so that light is not reflected onto the screen.
 - Keep your elbow at a right angle and keep your arm level with the back of your hand.
 - Keep your elbow at a right angle.
 - Place your heels flat on the ground while keeping your knees at an angle of 90 degrees or higher and maintain the position of your arm so that your arm is below your heart.
- **Digital Clean View:** If the broadcast signal received by your TV is weak, you can activate the **Digital Clean View** feature to reduce any static and ghosting that may appear on the screen.
-  When the signal is weak, try other options until the best picture is displayed.
- **MPEG Noise Filter:** Reduces MPEG noise and improves the video quality.
- **HDMI Black Level:** Lets you select the black level on the screen to adjust the screen depth.
-  Available only in HDMI mode (RGB signal).
- **Film Mode:** Sets the TV to automatically sense and process film signals from all sources and adjusts the picture for optimum quality.
-  Available in TV, AV, COMPONENT (480i / 1080i) and HDMI (1080i).

Picture Reset (Reset Picture Mode / Cancel)

Resets your current picture mode to its default settings.

Basic Features

Sound Menu



Changing the Preset Sound Mode

MENU  → Sound → Mode → ENTER 

Mode

- **Standard:** Selects the normal sound mode.
- **Music:** Emphasizes music over voices.
- **Movie:** Provides the best sound for movies.
- **Clear Voice:** Emphasizes voices over other sounds.
- **Amplify:** Increase the intensity of high-frequency sound to allow a better listening experience for the hearing impaired.

Adjusting sound settings

MENU  → Sound → Equalizer → ENTER 

Equalizer

Adjusts the sound mode.

- **Balance L/R:** Adjusts the balance between the right and left speaker.
- **100Hz / 300Hz / 1kHz / 3kHz / 10kHz** (Bandwidth Adjustment): Adjusts the level of specific bandwidth frequencies.
- **Reset:** Resets the equalizer to its default settings.

Sound Settings

MENU  → Sound → ENTER 

DTS TruSurround (Off / On)

(standard sound mode only)

This function provides a virtual 5.1 channel surround sound experience through a pair of speakers using HRTF (Head Related Transfer Function) technology.

Preferred Language

(digital channels only)

Digital-TV broadcasts are capable of simultaneous transmission of many audio tracks (for example, simultaneous translations of the program into foreign languages).

 You can only select a language among the ones being broadcasted.

Multi-Track Sound

(analog channels only)

- **Mono:** Choose for channels that are broadcasting in mono or if you are having difficulty receiving a stereo signal.
- **Stereo:** Choose for channels that are broadcasting in stereo.
- **SAP:** Choose to listen to the Separate Audio Program, which is usually a foreign-language translation.

 Depending on the particular program being broadcast, you can listen to **Mono**, **Stereo** or **SAP**.

Auto Volume (Off / On)

To equalize the volume level on each channel, set to **On**.

Visual Impaired (Off / On)

Activate the audio guide for the visually impaired. This is only available with broadcasts that provide this service.

Sound Reset (Reset All / Cancel)

Reset all sound settings to the factory defaults.

Basic Features

Setup Menu

Setting the Time

MENU → Setup → Time → ENTER

Time

- **Clock:** Setting the clock is for using various timer features of the TV.

The current time will appear every time you press the **INFO** button.

If you disconnect the power cord, you have to set the clock again.

Clock Mode (Auto / Manual)

- **Auto:** Set the current time automatically using the time from a digital channel.
 - The antenna must be connected in order to set the time automatically.
- **Manual:** Set the current time manually.
 - Depending on the broadcast station and signal, the auto time set up may not be correct. In this case, set the time manually.

Clock Set: Set the **Month, Day, Year, Hour, am/pm** and **am/pm** manually.

Available only when **Clock Mode** is set to **Manual**.

You can set the **Month, Day, Year, Hour** and **am/pm** directly by pressing the number buttons on the remote control.

Time Zone: Select your time zone.

This function is only available when the **Clock Mode** is set to **Auto**.

DST (Off / On / Auto): Switches the Daylight Saving Time function on or off.

This function is only available when the **Clock Mode** is set to **Auto**.

Using the Sleep Timer

MENU → Setup → Time → Sleep Timer → ENTER

- **Sleep Timer** : Automatically shuts off the TV after a preset period of time. (30, 60, 90, 120, 150 and 180 minutes).

To cancel the **Sleep Timer**, select **Off**.

Setting the On/Off Timer

MENU → Setup → Time → Timer 1 → ENTER

You can set the TV to turn on automatically at a preset time.

- **Timer 1 / Timer 2 / Timer 3:** Three different on / off timer settings can be made. You must set the clock first.

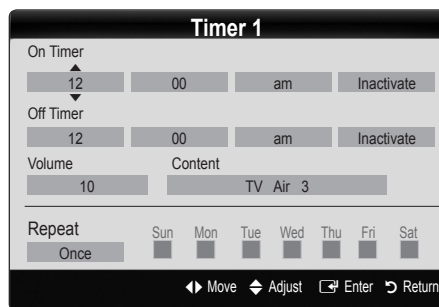

On Timer / Off Timer: Set the hour, minute, and activate / inactivate. (To activate the timer with the setting you've chosen, set to **Activate**.)

Volume: Set the desired volume level.

Content: Select a content to be played when the TV is turned on automatically. (**USB** can be selected only when a USB device is connected to the TV.)

- **TV / USB:** Select **TV** or **USB**. (Make sure that an USB device is connected to your TV.)
- **Antenna:** You can view an antenna source.
- **Channel:** Select the desired channel.
- **Music:** Select the folder containing MP3 files on the USB device.
- **Photo:** Select the folder containing JPEG files on the USB device.

Basic Features

NOTE



- If there is no music file on the USB device or the folder containing a music file is not selected, the Timer function does not operate correctly.
- When there is only one photo file in the USB, the Slide Show will not play.
- If a folder name is too long, the folder cannot be selected.
- Each USB you use is assigned its own folder. When using more than one of the same type of USB, make sure the folders assigned to each USB have different names.

Repeat: Select **Once**, **Everyday**, **Mon~Fri**, **Mon~Sat**, **Sat~Sun** or **Manual** to set at your convenience. If you select **Manual**, you can set up the day you want to activate the timer.

 The mark indicates the day is selected.

 **Auto Power Off** (available only when the TV is turned on by the Timer): The TV will be automatically turned off after 3 hours of being left idle to prevent overheating.

Locking Programs

MENU  → Setup → Program Rating Lock → ENTER 

Program Rating Lock

The PIN input screen appears, Enter your 4 digit PIN number. The Program Rating Lock feature automatically locks out programs that are deemed inappropriate for children. The user must enter a PIN (personal identification number) before any of the Program Rating Lock restrictions are set up or changed.

NOTE

- **Program Rating Lock** is not available in **HDMI**, **Component**, **PC**.
- The default PIN number of a new TV set is "0-0-0-0".
- **Allow All:** Press to unlock all TV ratings.
- **Block All:** Press to lock all TV ratings.

■ **Program Rating Lock (Off / On):** You can block rated TV Programs.

TV Parental Guidelines: You can block TV programs depending on their rating. This function allows you to control what your children are watching.

- **TV-Y:** Young children / **TV-Y7:** Children 7 and over / **TV-G:** General audience / **TV-PG:** Parental guidance / **TV-14:** Viewers 14 and over / **TV-MA:** Mature audience
- **ALL:** Lock all TV ratings. / **FV:** Fantasy violence / **V:** Violence / **S:** Sexual situation / **L:** Adult Language / **D:** Sexually Suggestive Dialog

 The **Program Rating Lock** will automatically block certain categories dealing with more sensitive material. For example, if you block the **TV-Y** category, then **TV-Y7** will automatically be blocked. Similarly, if you block the **TV-G** category, then all the categories in the young adult group will be blocked (**TV-G**, **TV-PG**, **TV-14** and **TV-MA**). The sub-ratings (**D**, **L**, **S**, **V**) work similarly. So, if you block the **L** sub-rating in **TV-PG**, then the **L** sub-ratings in **TV-14** and **TV-MA** will automatically be blocked.

MPAA Rating: You can block movies depending on their MPAA rating. The Motion Picture Association of America(MPAA) has implemented a rating system that provides parents or guardians with advanced information on which films are appropriate for children.

- **G:** General audience (no restrictions). / **PG:** Parental guidance suggested. / **PG-13:** Parents strongly cautioned. / **R:** Restricted. Children under 17 should be accompanied by an adult. / **NC-17:** No children under age 17. / **X:** Adults only. / **NR:** Not rated.

 The **Program Rating Lock** will automatically block any category that deals with more sensitive material. For example, if you block the **PG-13** category, then **R**, **NC-17** and **X** will automatically be blocked.

Canadian English: You can block TV programs depending on their Anglophone Canadian ratings.

- **C:** Programming intended for children under age 8. / **C8+:** Programming generally considered acceptable for children 8 years and over to watch on their own. / **G:** General programming, suitable for all audiences. / **PG:** Parental Guidance. / **14+:** Programming contains themes or content which may not be suitable for viewers under the age of 14. / **18+:** Adult programming.

 The **Program Rating Lock** will automatically block any category that deals with more sensitive material. For example, if you block the **G** category, then **PG**, **14+** and **18+** will automatically be blocked.

Basic Features

Canadian French: You can block TV programs depending on their French Canadian rating.

- **G:** General / **8 ans+:** Programming generally considered acceptable for children 8 years and over to watch on their own. / **13 ans+:** Programming may not be suitable for children under the age of 13. / **16 ans+:** Programming is not suitable for children under the age of 16. / **18 ans+:** Programming restricted to adults.

 The **Program Rating Lock** will automatically block any category that deals with more sensitive material. For example, if you block the **8 ans+** category, then **13 ans+**, **16 ans+** and **18 ans+** will automatically be blocked also.

Downloadable U.S. Rating: Parental restriction information can be used while watching DTV channels.

NOTE

- If information is not downloaded from the broadcasting station, the **Downloadable U.S. Rating** menu is deactivated.
- Parental restriction information is automatically downloaded while watching DTV channels. It may take several seconds.
- The **Downloadable U.S. Rating** menu is available for use after information is downloaded from the broadcasting station. However, depending on the information from the broadcasting station, it may not be available for use.
- Parental restriction levels differ depending on the broadcasting station. The default menu name and **Downloadable U.S. Rating** change depending on the downloaded information.
- Even if you set the on-screen display to another language, the **Downloadable U.S. Rating** menu will appear in English only.
- The rating will automatically block certain categories that deal with more sensitive material.
- The rating titles (For example: Humor Level.etc) and TV ratings (For example: DH, MH, H..etc) may differ depending on the broadcasting station.

- **Change PIN:** The Change PIN screen will appear. Choose any 4 digits for your PIN and enter it in **Enter New PIN**. Re-enter the same 4 digits in **Confirm New PIN**. When the Confirm screen disappears, select the **OK**. The TV has memorized your new PIN.

How to watch a restricted channel

If the TV is tuned to a restricted channel, the Program Rating Lock will block it. The screen will go blank and the following message will appear:

"This channel is blocked by Program Rating Lock. Please enter the PIN to unblock."



 If you forget the PIN code, press the remote control buttons in the following sequence in Standby mode, which resets the PIN to "0-0-0-0": **POWER** (off) → **MUTE** → 8 → 2 → 4 → **POWER** (on).

Other Features

MENU  → **Setup** → **ENTER** 

Language

Set the menu language.

1. Select **Language** and press the **ENTER**  button.
2. Choose desired language and press the **ENTER**  button.

 Choose between **English**, **Español** and **Français**.

Caption

(On-Screen Text Messages)

- **Caption (Off / On):** You can switch the caption function on or off. If captions are not available, they will not be displayed on the screen.

 The Caption feature doesn't work in Component, HDMI and PC modes.

- **Caption Mode:** You can select the desired caption mode.

 The availability of captions depends on the program being broadcast.

Default / CC1 - CC4 / Text1 - Text4: (analog channels only) The Analog Caption function operates in either analog TV channel mode or when a signal is supplied from an external device to the TV. (Depending on the broadcasting signal, the Analog Caption function may or may not work with digital channels.)

Default / Service1 - Service6 / CC1 - CC4 / Text1 - Text4: (digital channels only) The Digital Captions function works with digital channels.

 **Service1 - Service6** may not be available in digital caption mode depending on the broadcast.

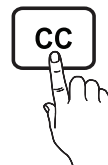

Basic Features

■ Digital Caption Options: (digital channels only)

Size: Options include Default, Small, Standard and Large. The default is Standard.

Font Style: Options include Default and Styles 0 to 7. The default is Style 0.

Foreground Color: Options include Default, White, Black, Red, Green, Blue, Yellow, Magenta and Cyan. You can change the color of the letter. The default is White.

Background Color: Options include Default, White, Black, Red, Green, Blue, Yellow, Magenta and Cyan. You can change the background color of the caption. The default is Black.

Foreground Opacity: This adjusts the opacity of text. Options include Default, Transparent, Translucent, Solid and Flashing.

Background Opacity: This adjusts the opacity of the caption background. Options include Default, Transparent, Translucent, Solid and Flashing.

Return to Default: This option sets each Size, Font Style, Foreground Color, Background Color, Foreground Opacity and Background Opacity to its default.

NOTE

- **Digital Caption Options** are available only when **Default** and **Service1 - Service6** can be selected in Caption Mode.
- The availability of captions depends on the program being broadcasted.
- The **Default** setting follows the standards set by the broadcaster.
- The Foreground and Background cannot be set to have the same color.
- You cannot set both the **Foreground Opacity** and the **Background Opacity** to Transparent.

Game Mode (Off / On)

When connecting to a game console such as PlayStation™ or Xbox™, you can enjoy a more realistic gaming experience by selecting the game mode.

NOTE

- Precautions and limitations for game mode.
 - To disconnect the game console and connect another external device, set **Game Mode** to **Off** in the setup menu.
 - If you display the TV menu in **Game Mode**, the screen shakes slightly.
- **Game Mode** is not available when the input source is set to **TV** or **PC**.
- After connecting the game console, set **Game Mode** to **On**. Unfortunately, you may notice reduced picture quality.
- If **Game Mode** is **On**:
 - **Picture Mode** is set to **Standard** and **Sound Mode** is set to **Movie**.
 - **Equalizer** is not available.

Melody (Off / Low / Medium / High)

Set so that a melody plays when the TV is turned on or off.

Eco Solution

- **Energy Saving (Off / Low / Medium / High / Picture Off)** : This adjusts the brightness of the TV in order to reduce power consumption. If you select Picture Off, the screen is turned off, but the sound remains on. Press any button except volume button to turn on the screen.
- **No Signal Power Off (Off / 15 min. / 30 min. / 60 min.)**: To avoid unnecessary energy consumption, set how long you want the TV to remain on if it's not receiving a signal.
 -  Disabled when a PC connected to the HDMI1/DVI port is in power-saving mode.
- **Auto Power Off (Off / On)**: Saves power by turning TV off automatically when no user operation is received for 4 hours.

Auto Protection Time

- **Off / 2 hours / 4 hours / 8 hours / 10 hours**: If the screen remains idle with a still image for a certain period of time defined by the user, the screen saver is activated to prevent the formation of ghost images on.

Basic Features

Support Menu

MENU  → Support → ENTER 

Self Diagnosis

 Self Diagnostic might take few seconds, this is part of the normal operation of the TV.

■ **Picture Test:** Use to check for picture problems.

Yes: If the test pattern does not appear or there is noise in the test pattern, select Yes. There may be a problem with the TV. Contact Samsung's Call Center for assistance (1-800-SAMSUNG).

No: If the test pattern is properly displayed, select No. There may be a problem with your external equipment. Please check your connections. If the problem persists, refer to the external device's user manual.

■ **Sound Test:** Use the built-in melody sound to check for sound problems.

Yes: If you can hear sound only from one speaker or not at all during the sound test, select Yes. There may be a problem with the TV. Contact Samsung's Call Center for assistance (1-800-SAMSUNG).

No: If you can hear sound from the speakers, select No. There may be a problem with your external equipment. Please check your connections. If the problem persists, refer to the external device's user manual.

■ **Signal Strength:** (Digital channels only) An HD channel's reception quality is either perfect or the channels are unavailable. Adjust your antenna to increase signal strength.

■ **Reset:** All the settings will return to factory defaults.

Software Upgrade

Samsung may offer upgrades for your TV's firmware in the future. Please visit Samsung.com or contact the Samsung call center at 1-800-SAMSUNG (726-7864) to receive information about downloading upgrades and using a USB drive. Upgrades will be possible by connecting a USB drive to the USB port.

 When software is upgraded, video and audio settings you have made will return to their default (factory) settings.

 We recommend you write down your settings so that you can easily reset them after the upgrade.

TV Side Panel

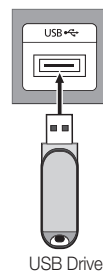

HD Connection Guide

Refer to this information when connecting external devices to the TV.

Contact Samsung

View this information when your TV does not work properly or when you want to upgrade the software. You can find information regarding our call centers and how to download products and software.

Advanced Features

Media Play (USB)

Enjoy video, music and photos files saved on a USB Mass Storage Class (MSC) device.

MENU  → Application → Media Play (USB) → ENTER 





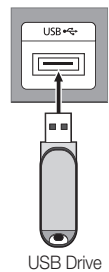

Connecting a USB Device

1. Turn on your TV.
2. Connect a USB device containing video, music and photos files to the **USB** jack on the side of the TV.
3. When the **Application** selection screen is displayed, press the **▶** button to select **Media Play (USB)**, then press the **ENTER**  button.

TV Side Panel



Using the Media Play Menu

1. Press the **MENU** button. Press the **▲** or **▼** button to select **Application**, and then press the **ENTER**  button.
2. Select **Media Play (USB)**, then press the **ENTER**  button.
3. The USB Memory Device name is displayed in the left corner.
 -  The Media Play menu differs depending on the USB Memory Device connected to TV.
 -  Some devices may not be supported due to compatibility problems.
4. Press the **◀** or **▶** button to select an icon **Videos**, **Music**, **Photos**, **Settings** then press the **ENTER**  button.



The displayed image may differ depending on the model.

Advanced Features

 The USB function might not work properly with unlicensed multimedia files.

 Read this information before using **Media Play (USB)** with a USB device:

- Only alphanumeric characters must be used as a folder name or file name (photo, music).
- The file system supports FAT16, FAT32 and NTFS.
- Certain types of USB Digital camera and audio devices may not be compatible with this TV.
- Media Play (USB) only supports the USB Mass Storage Class device (MSC). MSC is a Mass Storage Class Bulk-Only Transport device. Examples of MSC are Thumb drives and Flash Card Readers (Both USB and HUB are not supported.)
- USB HDD is not supported. A USB device that requires high power (more than 0.5A) may not be supported.
- Before connecting your device to the TV, please back up your files to prevent them from damage or loss of data. SAMSUNG is not responsible for any data file damage or data loss.
- Please connect directly to the **USB** port of your TV. If you are using a separate cable connection, there may be a USB Compatibility problem.
- Only MP3 and JPEG file formats are supported.
- The Media Play (USB) mp3 format only supports music files with a high sampling frequency (32 kHz, 44.1 kHz, or 48 kHz).
- Photos only supports sequential jpeg format.
- Do not disconnect the USB device while it is loading.
- MSC supports MP3 and JPEG files, and the PTP device supports JPEG files only.
- MTP (Media Transfer Protocol) is not supported.
- The playing duration of an mp3 file may be displayed as "00:00:00" if its playing time information is not found at the start of the file.
- The higher the resolution of the image, the longer it takes to display on the screen.
- The Photo or Music List displays up to 300 folders or files.
- Loading may take some time depending on the size of the file.
- MP3 files with DRM that have been downloaded from a non-free site cannot be played.
- Digital Rights Management (DRM) is a technology that supports the creation, distribution and management of the content in an integrated and comprehensive way, including the protection of the rights and interests of the content providers, the prevention of the illegal copying of contents, as well as managing billings and settlements.
- The power-saving mode of some external hard disk drives may be released automatically when connected to the TV.
- If a USB extension cable is used, the USB device may not be recognized or the files on the device may not be read.
- If a USB device connected to the TV is not recognized, the list of files on the device is corrupted or a file in the list is not played, connect the USB device to the PC, format the device and check the connection.

Advanced Features

Videos

Playing Video

1. Press the ◀ or ▶ button to select Videos, then press the ENTER button in the Media Play menu.
2. Press the ◀/▶/▲/▼ button to select the desired file in the file list.
3. Press the ENTER button.
 - The selected file is displayed on the top with its playing time.
 - If video time information is unknown, play time and progress bar are not displayed.



The displayed image may differ depending on the model.

Supported Subtitle Formats

– External

Name	Extension
MPEG-4 Timed text	.txt
SAMI	.smi
SubRip	.srt
SubViewer	.sub
Micro DVD	.sub or .txt
SubStation Alpha	.ssa
Advanced SubStation Alpha	.ass

– Internal

Name	File extension	Format
Xsub	AVI	Picture format
SubStation Alpha	MKV	Text Format
Advanced SubStation Alpha	MKV	Text Format
SubRip	MKV	Text Format
MPEG-4 Timed text	MP4	Text Format

Advanced Features

Supported Video Formats

File Extension	Container	Video Codec	Resolution	Frame rate(fps)	Bit rate(Mbps)	Audio Codec
*.mp4	MP4	Divx3.11/4.x/5.1/6.0	1920x1080	6~30	30Mbps	MP3 / ADPCM / AAC
		H264	1920x1080	6~30	30Mbps	
		AVC	1920x1080	6~30	30Mbps	
		MJPEG	640x480	6~30	10Mbps	
*.avi *.mkv	AVI MKV	Divx3.11/4.x/5.1/6.0	1920x1080	6~30	30Mbps	MP3 / AC3 / LPCM / ADPCM / DTS Core
		MPEG4 SP / ASP	1920x1080	6~30	30Mbps	
		H264	1920x1080	6~30	30Mbps	
		MJPEG	640x480	6~30	10Mbps	
*.asf *.wmv	ASF	Divx 3.11/4.x/5.1/6.0	1920x1080	6~30	30Mbps	MP3 / AC3 / LPCM / ADPCM / WMA / WMA Pro
		MPEG4 SP / ASP	1920x1080	6~30	30Mbps	
		H.264	1920x1080	6~30	30Mbps	
*.ts *.trp *.tp *.m2ts	TS	MPEG2	1920x1080	6~30	30Mbps	AC3 / AAC / MP3 / DD+ / HE-AAC
		H. 264 BP/MP/HP	1920x1080	6~30	30Mbps	
*.dat *.mpg *.mpeg *.vob	PS	MPEG1	1920x1080	24/25/30	30Mbps	AC3 / MPEG / LPCM / AAC
		MPEG2	1920x1080	24/25/30	30Mbps	
		H. 264 BP/MP/HP	1920x1080	6~30	30Mbps	
*.3gp	3GP	MPEG4 SP / ASP	1920x1080	6~30	30Mbps	MP3
		H.264	1920x1080	6~30	30Mbps	
*.flv *.swf	flash formats	H.264	1920x1080	6~30	30Mbps	MP3
		Sorenson H.263	1920x1080	6~30	30Mbps	

Other Restrictions

NOTE

- Video content will not play, or not play correctly, if there is an error in the content or the container.
- Sound or video may not work if the contents have a standard bit rate/ frame rate above the compatible Frame/sec listed in the table above.
- If the Index Table is in error, the Seek (Jump) function is not supported.
- The menu may take longer to appear if the video's bit rate exceeds 10Mbps.
- Video content can not be played, if there are many contents in one file.

Video Decoder	Audio Decoder
<ul style="list-style-type: none"> • Supports up to H.264, Level 4.1 • H.264 FMO / ASO / RS, VC1 SP / MP / AP L4 and AVCHD are not supported. • MPEG4 SP, ASP : <ul style="list-style-type: none"> – Below 1280 x 720: 60 frame max – Above 1280 x 720: 30 frame max • H.263 is not supported. • GMC is not support. 	<ul style="list-style-type: none"> • Supports up to WMA7, 8, 9 STD, 9 PRO, 10 PRO • WMA 9 PRO and WMA 10 PRO support 5.1 channel. • WMA Lossless is not supported.

Advanced Features

Music

Playing Music

1. Press the ◀ or ▶ button to select Music, then press the ENTER ↵ button in the Media Play menu.
2. Press the ◀/▶/▲/▼ button to select the desired file in the file list.
3. Press the ENTER ↵ button or ▶ (Play) button.
 - During playing the music, you can search using the ◀ and ▶ button.
 - ◀ (REW) and ▶ (FF) buttons do not function during play.

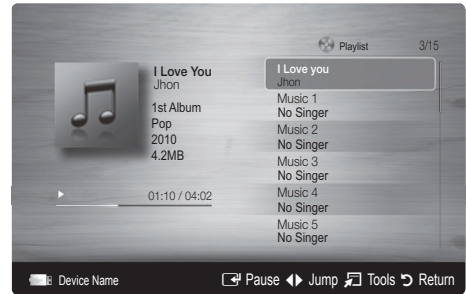

The displayed image may differ depending on the model.

Photos

Viewing a Photo (or Slide Show)

1. Press the TOOLS button to display the option **Slide Show, Detailed Information, Device Information**.
 2. Press the ▲ or ▼ button to select **Start Slide Show** then press the ENTER ↵ button.
 - During the slide show, files are displayed in order from the currently shown file.
 - MP3 files can be automatically played during the slide show if the Default **Background Music** is set to **On**.
- Press the Tools button during the photo view to set the following options **Stop Slide Show, Slide Show Speed, Background Music, Zoom, Rotate, Picture Mode, Sound Mode, Information**. Press the ▲ or ▼ button to select the option, then press the ENTER ↵ button.
- After setting the option press the ENTER ↵ button to make a change.



The displayed image may differ depending on the model.

Supported Photo Formats

Image	Photo	Resolution
JPEG	Base-line	15360 x 8704
	Progressive	1024 x 768

Other Restrictions

CMYK, YOCK Color space JPEG are not supported.

Advanced Features

Videos/Music/Photos Play Option menu

During playing a file, press the TOOLS button.

Category	Operations	Videos	Music	Photos
Title	You can move the other file directly.	✓		
Repeat Mode	You can play movie and music files repeatedly.	✓	✓	
Picture Size	You can adjust the picture size for preference.	✓		
Picture Mode	You can adjust the picture setting. (p. 24)	✓		✓
Sound Mode	You can adjust the sound setting. (p. 27)	✓	✓	✓
Stop Slide Show / Start Slide Show	You can start or stop a slide show.			✓
Slide Show Speed	You can select the slide show speed during the slide show.			✓
Background Music	You can set and select background music when watching a slide show.			✓
Zoom	You can zoom into images in full screen mode.			✓
Rotate	You can rotate images in full screen mode.			✓
Information	You can see detailed information about the played file.	✓	✓	✓

Settings

Using the Setting Menu

- **DivX® Video On Demand:** DivX® Video On Demand Shows the registration code authorized for the set. If you connect to the DivX web site and register, you can download the VOD registration file. If you play the VOD registration using Media contents, the registration is completed.
 For more information on DivX® VOD, visit "<http://vod.divx.com>".
- **Information:** Select to view information about the connected device.

Sports Mode

This mode provides optimized settings for watching sports.

 When the Sports Mode is On, the picture and sound mode are set to Stadium automatically.

Other Information

Attaching a Wall Mount/Desktop Stand

Preparing before installing Wall-Mount/Desktop Stand

1. Turn the product off and unplug the power cord from the wall outlet.
2. Place a soft cloth or cushion on a flat surface to protect the panel and place the product face down.
3. Pull the stand in the direction of the arrow as shown in the figure to separate it.

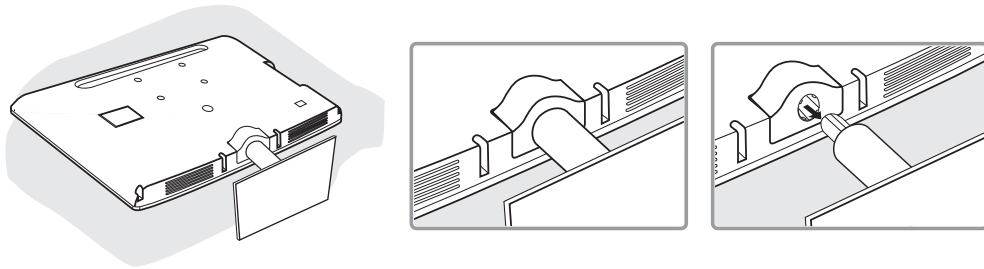

Attaching a Wall Mount/Desktop Stand

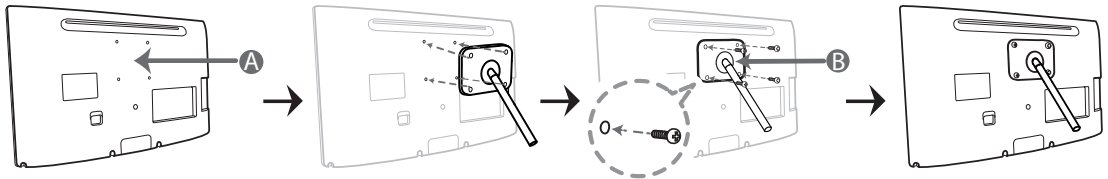

- A Wall/Desktop Stand Mount
- B Wall mount kit/desktop stand (not supplied)

4. Align wall mount/desktop stand to the Monitor/TV and firmly fix the wall mount/desktop stand by fastening the screw.
5. Align the groove of the part of the product that is to be connected to the stand with the groove in the stand (desk-top stand, wall mount stand or another stand) and firmly fix the stand by fastening the screw.

NOTE

- If you use screws that are longer than the standard specifications, the inside of the product may be damaged.
- For wall mounts that are not compatible with the standard VESA specifications, the length of the screw may differ depending on the corresponding specifications.
- Avoid using screws that are incompatible with the standard VESA specifications and avoid assembling them using excessive force. This may result in damage to the product or injury due to the product falling. Samsung shall not be held liable for any damage or injury.
- Samsung shall not be held liable for any damage to the product or injury caused by using a wall mount/desktop stand that is not compatible with the specifications or due to an installation not performed by an authorized installation engineer.
- Use the wall mount according to the international specifications.

Other Information



Do not install your Wall Mount Kit while your TV is turned on. It may result in personal injury due to electric shock.



Caution

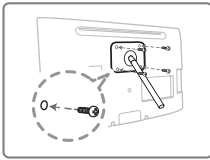

Important

For the installation of Wall-mount, please don't use screws longer than 10mm (L10) of longitude.

Anti-theft Kensington Lock

A Kensington Lock is a device you can use to physically fix your TV in place when using it in a public place. You wrap the Kensington Lock's cable around a large, immobile object and then attach the lock to the Kensington slot on the back of the TV.

The appearance and locking method may differ from the illustration below depending on the manufacturer. Refer to the manual provided with the Kensington Lock for additional information on proper use. The Kensington Lock is not supplied by Samsung.

 Please find a "K" icon on the rear of the TV. A kensington slot is beside the "K" icon.

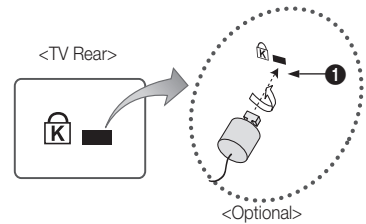

To lock the product, follow these steps:

1. Wrap the Kensington lock cable around a large, stationary object such as desk or chair.
2. Slide the end of the cable with the lock attached through the looped end of the Kensington Lock cable.
3. Insert the locking device into the Kensington slot on the product **1**.
4. Lock the lock.

 These are general instructions. For exact instructions, see the User manual supplied with the locking device.

 The locking device has to be purchased separately.

 The location of the Kensington slot may be different depending on the TV model.

Other Information

Troubleshooting

If the TV seems to have a problem, first review this list of possible problems and solution. If none of the troubleshooting tips apply, visit www.samsung.com/support or call Samsung customer Service at 1-800-SAMSUNG(1-800-726-7864).

Issues	Solutions and Explanations
PC Connection	
A Mode Not Supported message appears.	<ul style="list-style-type: none"> Set your PC's output resolution so it matches the resolutions supported by the TV (p. 19 ~ 20).
The video is OK but there is no audio.	<ul style="list-style-type: none"> If you are using an HDMI connection, check the audio output setting on your PC.
Poor picture	<p>First of all, please perform the Picture Test and confirm that your TV is properly displaying the test image. (go to MENU - Support - Self Diagnosis - Picture Test) (p. 32) If the test image is properly displayed, the poor picture may be caused by the source or signal.</p>
The TV image does not look as good as it did in the store.	<ul style="list-style-type: none"> If you have an analog cable/satellite box, upgrade to an HD digital set top box. Use HDMI or Component cables to deliver HD (high definition) picture quality. Cable/Satellite subscribers: Try HD stations from the channel line up. Antenna connection: Try HD stations after performing Auto program. <ul style="list-style-type: none"> Many HD channels are up scaled from SD(Standard Definition) contents. Adjust the Cable/Sat box video output resolution to 1080i or 720p. Make sure you are watching the TV at the minimum recommended distance based on the size and definition of the signal.
The picture is distorted: macro block error, small block, dots, pixelization.	<ul style="list-style-type: none"> Compression of video contents may cause picture distortion, especially in fast moving pictures such as sports and action movies. Low signal level can cause picture distortion. This is not a TV problem. Mobile phones used close to the TV (within 3.3ft) may cause noise in picture on analog and digital TV.
Color is wrong or missing.	<ul style="list-style-type: none"> If you're using Component connection, make sure the component cables are connected to the correct jacks. Incorrect or loose connections may cause color problems or a blank screen.
There is poor color or brightness.	<ul style="list-style-type: none"> Adjust the Picture options in the TV menu. (go to Picture mode / Color / Brightness / Sharpness) (p. 24) Adjust Energy Saving option in the TV menu. (go to MENU - Setup) (p. 31) Try resetting the picture to view the default picture settings. (go to MENU - Picture - Reset Picture) (p. 26)
There is a dotted line on the edge of the screen.	<ul style="list-style-type: none"> If the picture size is set to Screen Fit, change it to 16:9 (p. 25). Change cable/satellite box resolution.
The picture is black and white.	<ul style="list-style-type: none"> If you are using an AV composite input, connect the video cable (yellow) to the Green jack of component input on the TV.
When changing channels, the picture freezes or is distorted or delayed.	<ul style="list-style-type: none"> If connected to a cable box, please try to reset it. (reconnect the AC cord and wait until the cable box reboots. It may take up to 20 minutes) Set the output resolution of the cable box to 1080i or 720p.
Sound Problem	<p>First of all, please perform the Sound Test to confirm that your TV audio is properly operating. (go to MENU - Support - Self Diagnosis - Sound Test) (p. 32) If the audio is OK, the sound problem may be caused by the source or signal.</p>
There is no sound or the sound is too low at maximum volume.	<ul style="list-style-type: none"> Please check the volume of the device (Cable/Sat Box, DVD, Blu-ray etc) connected to your TV.
The speakers are making an inappropriate noise.	<ul style="list-style-type: none"> Check cable connections. Make sure a video cable is not connected to an audio input. For antenna or Cable connections, check the signal strength. Low signal level may cause sound distortion. Perform the Sound Test as explained above.

Other Information

Issues	Solutions and Explanations
No Picture, No Video	
The TV won't turn on.	<ul style="list-style-type: none"> • Make sure the AC power cord is securely plugged in to the wall outlet and the TV. • Make sure the wall outlet is working. • Try pressing the POWER button on the TV to make sure the problem is not the remote. If the TV turns on, refer to "Remote control does not work" below.
The TV turns off automatically.	<ul style="list-style-type: none"> • Ensure the Sleep Timer is set to Off in the Setup menu (p. 28). • If your PC is connected to the TV, check your PC power settings. • Make sure the AC power cord is plugged in securely to the wall outlet and the TV. • When watching TV from an antenna or cable connection, the TV will turn off after 10 - 15 minutes if there is no signal.
There is no picture/video.	<ul style="list-style-type: none"> • Check cable connections (remove and reconnect all cables connected to the TV and external devices). • Set your external device's (Cable/Sat Box, DVD, Blu-ray etc) video outputs to match the connections to the TV input. For example, if an external device's output is HDMI, it should be connected to an HDMI input on the TV. • Make sure your connected devices are powered on. • Be sure to select the TV's correct source by pressing the SOURCE button on the remote control. • Reboot the connected device by reconnecting the device's power cable.
RF(Cable/Antenna) Connection	
The TV is not receiving all channels.	<ul style="list-style-type: none"> • Make sure the coaxial cable is connected securely. • Please try Auto Program to add available channels to the channel list. Go to MENU - Channel - Auto Program then select Auto and make sure the correct Cable TV signal type is set in the menu. There are 3 options (STD, HRC and IRC) (p. 22). • Verify the Antenna is positioned correctly.
The picture is distorted: macro block error, small block, dots, pixelization.	<ul style="list-style-type: none"> • Compression of video contents may cause picture distortion, especially with fast moving pictures such as sports and action movies. • A low signal can cause picture distortion. This is not a TV problem.
Others	
Purple/green rolling horizontal bars and buzzing noise from the TV speakers with Component cable connection.	<ul style="list-style-type: none"> • Remove the left and right audio connections from the set-top-box. If the buzzing stops, this indicates that the set-top-box has a grounding issue. Replace the Component video cables with an HDMI connection.
A "Mode Not Supported" message appears.	<ul style="list-style-type: none"> • Check the supported resolution of the TV, and adjust the external device's output resolution accordingly. Refer to the resolution settings on page 12 of this manual.
Caption on TV menu is greyed out.	<ul style="list-style-type: none"> • Caption can not be selected in the TV menu when connected via HDMI or Component (p. 30). • Caption must be activated on the external device (p. 30).
There is a plastic smell from the TV.	<ul style="list-style-type: none"> • This smell is normal and will dissipate over time.
The TV Signal Strength is unavailable in the Self Diagnostic Test menu.	<ul style="list-style-type: none"> • This function is only available with digital channels from an Antenna / RF/Coax connection (p. 32).
The TV is tilted to the side.	<ul style="list-style-type: none"> • Remove the base stand from the TV and reassemble it.
The channel menu is greyed out (unavailable).	<ul style="list-style-type: none"> • The Channel menu is only available when the TV source is selected.
Your settings are lost after 30 minutes or every time the TV is turned off.	<ul style="list-style-type: none"> • If the TV is in the Store Demo mode, it will reset audio and picture settings every 30 minutes. Change the settings from Store Demo mode to Home Use mode in the Plug & Play procedure. Press the SOURCE button to select TV mode, and go to MENU → Setup → Plug & Play → ENTER (p. 16).
You have intermittent loss of audio or video.	<ul style="list-style-type: none"> • Check the cable connections and reconnect them. • Loss of audio or video can be caused by using overly rigid or thick cables. Make sure the cables are flexible enough for long term use. If mounting the TV to a wall, we recommend using cables with 90 degree connectors.

Other Information

Issues	Solutions and Explanations
You see small particles when you look closely at the edge of the frame of the TV.	<ul style="list-style-type: none">• This is part of the product's design and is not a defect.
POP (TV's internal banner ad) appears on the screen.	<ul style="list-style-type: none">• Select Home Use under Plug & Play mode. For details, refer to Plug & Play Feature (p. 16).
The remote control does not work.	<ul style="list-style-type: none">• Replace the remote control batteries with correct polarity (+/-).• Clean the transmission window located on the top of the remote control.• Try pointing the remote directly at the TV from 5-6 feet away.

 This panel uses a panel consisting of sub pixels which require sophisticated technology to produce. However, there may be a few bright or dark pixels on the screen. These pixels will have no impact on the performance of the product.

Storage and Maintenance

 If you attached some stickers on the TV screen, it remains some debris after removing the sticker. Please clean it to watch TV.

 The exterior and screen of the product can get scratched during cleaning. Be sure to wipe the exterior and screen carefully using the cloth provided or a soft cloth to prevent scratches.

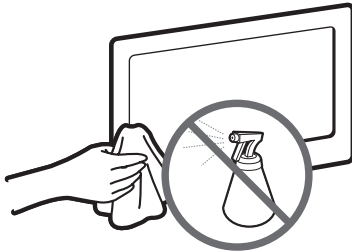

Do not spray water or a cleaning agent directly onto the product. Any liquid that goes into the product may cause a failure, fire, or electric shock.

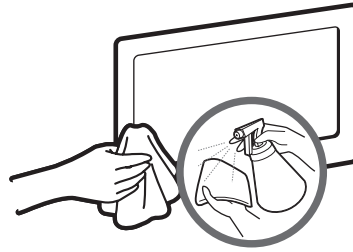

Clean the product with a soft cloth dampened with amount of water.

Other Information

License



Manufactured under license from Dolby Laboratories. Dolby and the double-D symbol are trademarks of Dolby Laboratories.



Manufactured under a license from U.S. Patent No's: 5,956,674, 5,974,380, 5,978,762, 6,487,535, 6,226,616, 7,212,872, 7,003,467, 7,272,567, 7,668,723, 7,392,195, 7,930,184, 7,333,929 and 7,548,853. DTS, the Symbol, and DTS and the Symbol together are registered trademarks & DTS Premium Sound is a trademark of DTS, Inc.
©2012 DTS, Inc. All Rights Reserved.



Manufactured under a license from U.S. Patent No's: 6,285,767, 8,027,477, 5,319,713, 5,333,201, 5,638,452, 5,771,295, 5,970,152, 5,912,976, 7,200,236, 7,492,907, 8,050,434, 7,720,240, 7,031,474, 7,907,736 and 7,764,802. DTS, the Symbol, and DTS and the Symbol together are registered trademarks & DTS Studio Sound is a trademark of DTS, Inc.
©2012 DTS, Inc. All Rights Reserved.

HDMI





Open Source License Notice

In the case of using open source software, Open Source Licenses are available on the product menu.
Open source used in this product can be found on the following webpage. (<http://opensource.samsung.com>)
Open source License Notice is written only English.

Other Information

Specifications

Environmental considerations	Operating	Temperature : 50°F ~ 104°F (10°C ~ 40°C) Humidity : 10 % ~ 80 %, non-condensing	
	Storage	Temperature : -4°F ~ 113°F (-20°C ~ 45°C) Humidity : 5 % ~ 95 %, non-condensing	
VESA Mounting Interface		75 mm x 75 mm	
Tilt		-1° (±2°) ~ 20° (±2°)	
Model Name		T19C350	T22C350
Screen Size (Diagonal)		18.5 inches (47cm)	21.5 inches (54cm)
Display Resolution		1366 x 768 @ 60Hz	1920 x 1080 @ 60Hz
Sound (Output)		5W x 2	
Dimensions (W x H x D)	(Without Stand)	17.5 x 10.7 x 1.6 inches (445.7 x 274.1 x 41.7 mm)	19.9 x 12.2 x 1.6 inches (507.6 x 310.2 x 41.7 mm)
	(With Stand)	17.5 x 14.6 x 7.4 inches (445.7 x 371.0 x 190.0 mm)	19.9 x 16.0 x 7.4 inches (507.6 x 408.0 x 190.0 mm)
Weight	(Without Stand)	5.4 lbs (2.45 kg)	7.2 lbs (3.3 kg)
	(With Stand)	6.1 lbs (2.80 kg)	8.1 lbs (3.7 kg)
Model Name		T24C350	T24C550
Screen Size (Diagonal)		23.6 inches (59cm)	23.6 inches (59cm)
Display Resolution		1920 x 1080 @ 60Hz	
Sound (Output)		5W x 2	
Dimensions (W x H x D)	(Without Stand)	22.3 x 13.4 x 1.6 inches (567.8 x 341.3 x 41.8 mm)	22.3 x 13.4 x 1.6 inches (567.8 x 341.3 x 41.8 mm)
	(With Stand)	22.3 x 17.2 x 7.8 inches (567.8 x 438.4 x 200 mm)	22.3 x 17.2 x 7.8 inches (567.8 x 438.4 x 200 mm)
Weight	(Without Stand)	8.5 lbs (3.9 kg)	8.5 lbs (3.9 kg)
	(With Stand)	9.4 lbs (4.3 kg)	9.4 lbs (4.3 kg)
Model Name		T24C730	T27C730
Screen Size (Diagonal)		24 inches (61cm)	27 inches (68cm)
Display Resolution		1920 x 1080 @ 60Hz	
Sound (Output)		5W x 2	
Dimensions (W x H x D)	(Without Stand)	21.8 x 13.3 x 1.5 inches (555.9 x 337.7 x 38.9 mm)	24.6 x 14.7 x 1.4 inches (624.6 x 374.9 x 37.1 mm)
	(With Stand)	21.8 x 17.1 x 7.8 inches (555.9 x 434.3 x 200 mm)	24.5 x 18.5 x 7.8 inches (624.6 x 471.1 x 200 mm)
Weight	(Without Stand)	7.8 lbs (3.55 kg)	9.4 lbs (4.3 kg)
	(With Stand)	8.7 lbs (3.95 kg)	10.3 lbs (4.7 kg)

-  Design and specifications are subject to change without prior notice.
-  This device is a Class B digital apparatus.
-  For information about power supply, and more about power consumption, refer to the label attached to the product.
-  Some models may not be available for purchase depending on the region.

(USA only)

Dispose unwanted electronics through an approved recycler.
To find the nearest recycling location, go to our website,
www.samsung.com/recyclingdirect, or call (877) 278 - 0799



Contacter SAMSUNG WORLDWIDE

If you have any questions or comments relating to Samsung products, please contact the SAMSUNG customer care center.

Country	Customer Care Center ☎	Web Site	Address
CANADA	1-800-SAMSUNG (726-7864)	www.samsung.com	Samsung Electronics Canada Inc., Customer Service 55 Standish Court Mississauga, Ontario L5R 4B2 Canada
U.S.A	1-800-SAMSUNG (726-7864)	www.samsung.com	Samsung Electronics America, Inc. 85 Challenger Road Ridgefield Park, NJ 07660-2112
MEXICO	01-800-SAMSUNG (726-7864)	www.samsung.com	C.P 11570 AV. Presidente Masaryk No.111, Int. 701 Col. Chapultepec Morales, Delegacion Miguel Hidalgo Mexico D.F

Free Manuals Download Website

<http://myh66.com>

<http://usermanuals.us>

<http://www.somanuals.com>

<http://www.4manuals.cc>

<http://www.manual-lib.com>

<http://www.404manual.com>

<http://www.luxmanual.com>

<http://aubethermostatmanual.com>

Golf course search by state

<http://golfingnear.com>

Email search by domain

<http://emailbydomain.com>

Auto manuals search

<http://auto.somanuals.com>

TV manuals search

<http://tv.somanuals.com>