

CTI613GI series

Induction Hob

user manual

imagine the possibilities

Thank you for purchasing this Samsung product.
To receive more complete service, please register
your product at

www.samsung.com/global/register



using this manual

Please take the time to read this owner's manual, paying particular attention to the safety information contained in the following section, before using your appliance. Keep this manual for future reference. If transferring ownership of the appliance, please remember to pass the manual on to the new owner.

THE FOLLOWING SYMBOLS ARE USED IN THE TEXT



This is the safety alert symbol.

Warning indicates information concerning your personal safety.

Important indicates information on avoiding damage to the appliance.



This symbol refers to measures that can be taken to help protect the environment.



This symbol indicates useful information and practical tips.

1. Numbers like these indicate step - by - step instructions for using the appliance.
2. ...
3. ...

This manual contains information on steps you can take yourself to diagnose and resolve problems that may arise. Refer to the section "Troubleshooting".

safety instructions

 The safety aspects of this appliance comply with all accepted technical and safety standards. However, as manufacturers we also believe it is our responsibility to familiarize you with the following safety instructions.

ELECTRICAL SAFETY

- Be sure the appliance is properly installed and grounded by a qualified technician.
- The appliance should be serviced only by qualified service personnel. Repairs carried out by unqualified individuals may cause injury or serious malfunction. If your appliance is in need of repair, contact your local service centre. Failure to follow these instructions may result in damage and void the warranty.
- Flush - mounted appliances may be operated only after they have been installed in cabinets and workplaces that conform to the relevant standards. This ensures sufficient protection against contact for electrical units as required by the essential safety standards.
- If your appliance malfunctions or if fractures, cracks or splits appear:
 - switch off all cooking zones;
 - disconnect the hob from the mains supply; and
 - contact your local service centre.

 If the surface is cracked, switch off the appliance to avoid the possibility of electric shock. Do not use your hob until the glass surface has been replaced.

CHILD SAFETY

 This appliance is not intended for use by young children or infirm persons without the adequate supervision of a responsible adult.

Young children should be supervised to ensure that they do not play with the appliance.

The cooking zones will become hot when you cook. Always keep small children away from the appliance.

SAFETY DURING USE

- Metallic objects such as knives, forks, spoons and lids should not be placed on the hob surface since they can get hot.
- After use, switch off the hob element by its control and do not rely on the pan detector.
- The appliance is not intended for use by persons (including children) with reduced physical, sensory or mental capabilities, or lack of experience and knowledge, unless they have been given supervision or instruction concerning use of the appliance by a person responsible for their safety.
- This appliance is to be used only for normal cooking and frying in the home. It is not designed for commercial or industrial use.
- Never use the hob for heating the room.
- Take care when plugging electrical appliances into mains sockets near the hob. Mains leads must not come into contact with the cooktop.
- Overheated fat and oil can catch fire quickly. Never leave surface units unattended when preparing foods in fat or oil, for example, when cooking chips.
- Turn the cooking zones off after use.
- Always keep the control panels clean and dry.
- Never place combustible items on the hob. It may cause fire.
- Do not use the hob to heat aluminium foil, products wrapped in aluminium foil or frozen foods packaged in aluminium cookware.
- There is the risk of burns from the appliance if used carelessly.
- Cables from electrical appliances must not touch the hot surface of the hob or hot cookware.
- Do not use the hob to dry clothes.
- Never store flammable materials such as aerosols and detergents in draws or cupboards under the hob.

 **Warning:** Users with Pacemakers and Active Heart Implants must keep their upper body at a minimum distance of 30cm from induction cooking zones when turned on. If in doubt, you should consult the manufacturer of your device or your doctor.

SAFETY WHEN CLEANING

- Always turn the appliance off before cleaning.
- For safety reasons do not clean the appliance with a steam jet or high - pressure cleaner.
- Clean the hob in accordance with the cleaning and care instructions contained in this manual.

disposal instructions

DISPOSING OF THE PACKAGING MATERIAL

All materials used to package the appliance are fully recyclable. Sheet and hard foam parts are appropriately marked. Please dispose of packaging materials and old appliances with due regard to safety and the environment.

PROPER DISPOSAL OF YOUR OLD APPLIANCE

 **Warning:** Before disposing of your old appliance, make it inoperable so that it cannot be a source of danger.

To do this, have a qualified technician disconnect the appliance from the mains supply and remove the mains lead.

- The appliance may not be disposed of in the household rubbish.
- Information about collection dates and public refuse disposal sites is available from your local refuse department or council.

contents

INSTALLING THE HOB

7

- 7 Regulations and compliance
- 7 Safety instructions for the installer
- 8 Connecting to the mains power supply
- 9 Installing into the countertop

PARTS AND FEATURES

11

- 11 Cooking zones
- 11 Control panel
- 12 Components
- 12 Induction heating
- 13 The key features of your appliance
- 14 Safety shutoff
- 14 Residual heat indicator
- 15 Temperature detection
- 15 Initial cleaning

BEFORE YOU BEGIN

15

HOB USE

16

- 16 Cookware for induction cooking zones
- 16 Suitability test
- 16 Size of pans
- 17 Using suitable cookware
- 17 Using the touch control sensors
- 18 Switching the appliance on
- 18 Select cooking zone and heat setting
- 18 Switching the appliance off
- 19 Switching a cooking zone off
- 19 Using the child safety lock
- 20 Timer
- 21 Power boost control
- 21 Bridge Control
- 22 Power Management
- 22 Suggested settings for cooking specific foods
- 23 Hob
- 24 Hob Frame (option)
- 24 To avoid damaging your appliance

CLEANING AND CARE

23

WARRANTY AND SERVICE

25

- 25 FAQs and troubleshooting
- 26 Service

TECHNICAL DATA

27

- 27 Technical data
- 27 Cooking rings

installing the hob

Important:

Be sure the new appliance is installed and grounded only by qualified personnel. Please observe this instruction. The warranty will not cover any damage that may occur as a result of improper installation.

Technical data is provided at the end of this manual.

REGULATIONS AND COMPLIANCE

This appliance meets the following standards:

- EN 60335 - 1 and EN 60335 - 2 - 6, relating to the safety of electrical appliances for household use and similar purposes;
- EN 60350, or DIN 44546 / 44547 / 44548, relating to the operating features of electric cookers, hobs, ovens, and grills for household use;
- EN 55014-1
- EN 55014-2
- EN 61000 - 3 - 2; and
- EN 61000 - 3 - 3, relating to basic requirements for electromagnetic compatibility (EMC).



This appliance complies with the following EU Directives:

- 2006/95/EC, Low Voltage Directive
- 2004/108/EEC, Electromagnetic Compatibility Directive

SAFETY INSTRUCTIONS FOR THE INSTALLER

- A device must be provided in the electrical installation that allows the appliance to be disconnected from the mains at all poles with a contact opening width of at least 3 mm. Suitable isolation devices include line protecting cut - outs, fuses (screw type fuses are to be removed from the holder), earth leakage trips and contactors.
- With respect to fire protection, this appliance corresponds to EN 60335 - 2 - 6. This type of appliance may be installed with a high cupboard or wall on one side.
- Drawers may not be fitted underneath the hob.
- The installation must guarantee shock protection.
- The kitchen unit in which the appliance is fitted must satisfy the stability requirements of DIN 68930.
- For protection against moisture, all cut surfaces are to be sealed with a suitable sealant.
- On tiled work surfaces, the joints in the area where the hob sits must be completely filled with grout.
- On natural, artificial stone, or ceramic tops, the snap action springs must be bonded in place with a suitable artificial resin or mixed adhesive.
- Ensure that the seal is correctly seated against the work surface without any gaps. Additional silicon sealant must not be applied; this would make removal more difficult when servicing.
- The hob must be pressed out from below when removed.
- A board is to be installed underneath the hob.
- The ventilation gap between the worktop and front of the unit underneath it must not be covered.

CONNECTING TO THE MAINS POWER SUPPLY

Before connecting, check that the nominal voltage of the appliance, that is, the voltage stated on the rating plate, corresponds to the available supply voltage. The rating plate is located on the lower casing of the hob.

⚠ Shut off power to circuit before connecting wires to circuit.

The heating element voltage is AC230 V~. The appliance also works perfectly on networks with AC220 V~ or AC240 V~.

The hob is to be connected to the mains using a device that allows the appliance to be disconnected from the mains at all poles with a contact opening width of at least 3 mm, eg. automatic line protecting cut - out, earth leakage trips or fuse.

A type H05RN - F cable or one of a higher grade must be used as the mains connecting cable.

	Rated current of appliance (A)	Nominal cross-sectional area (mm ²)
1N~	> 25 and ≤ 32	≥ 2.5
2N~	> 10 and ≤ 16	≥ 1.5

The connection must be carried out as shown in the diagram. The connecting links should be fitted according to the appropriate connection diagram.

The earth lead is connected to terminal. The earth lead must be longer than leads carrying electric current.

⚠ The cable connections must be made in accordance with regulations and the terminal screws tightened securely.

The connecting cable is to be secured with the mains cable cleat and the covering closed by pressing firmly (locking into place). Before switching on for the first time, any protective foil or stickers must be removed from the ceramic glass surface.

⚠ Once the hob is connected to the mains supply, check that all cooking zones are ready for use by briefly switching each on in turn at the maximum setting with suitable cookware.

📝 When the hob is powered on for the first time, all displays light and the child safety lock is activated.

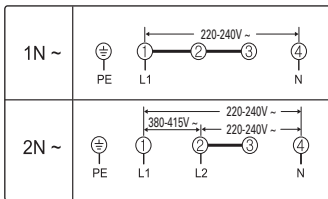

< IN ~ >

L: Brown

N: Blue

PE: Green

⚠ **Warning:** Pay attention (conformity) to phase and neutral allocation of house connection and appliance (connection schemes); otherwise, components can be damaged.

Warranty does not cover damage resulting from improper installation.

⚠ **Warning:** If the supply cord is damaged, it must be replaced by a special cord or assembly available from the manufacturer or its service agent.

INSTALLING INTO THE COUNTERTOP

 Make a note of the serial number on the appliance rating plate prior to installation. This number will be required in the case of requests for service and is no longer accessible after installation, as it is on the original rating plate on the underside of the appliance.

Pay special attention to the minimum space and clearance requirements. Secure the brackets at both sides with the provided screws before mounting the hob onto the brackets.

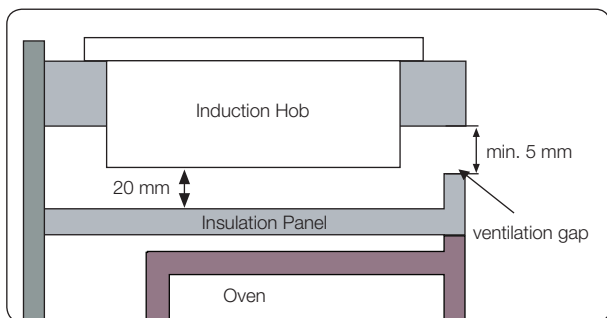
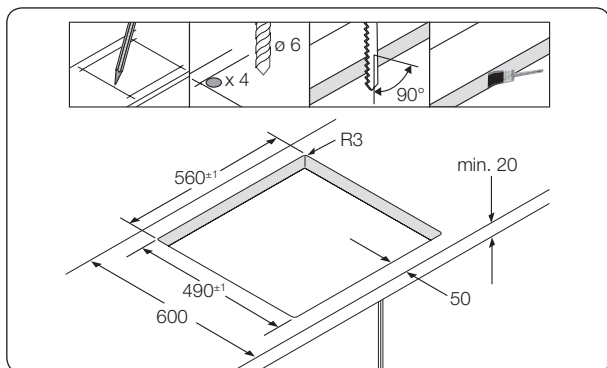
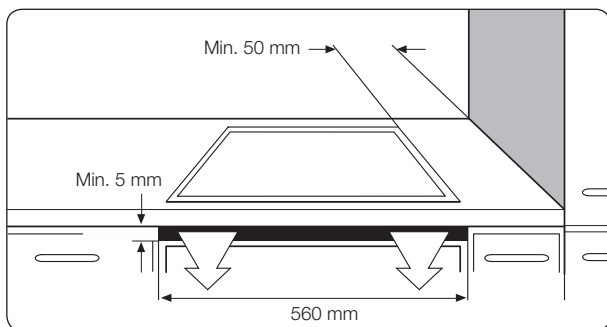

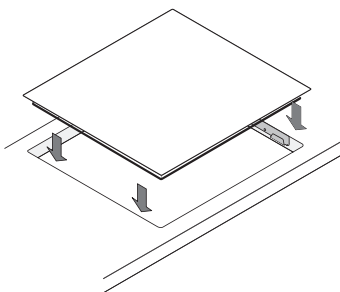
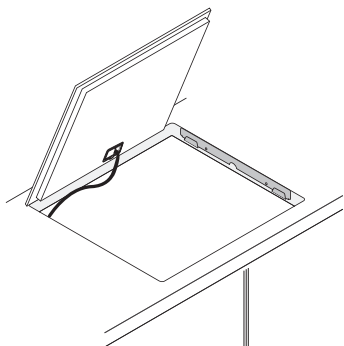
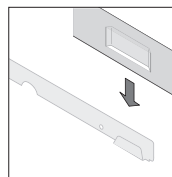
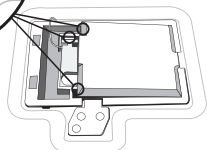
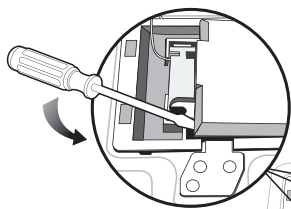
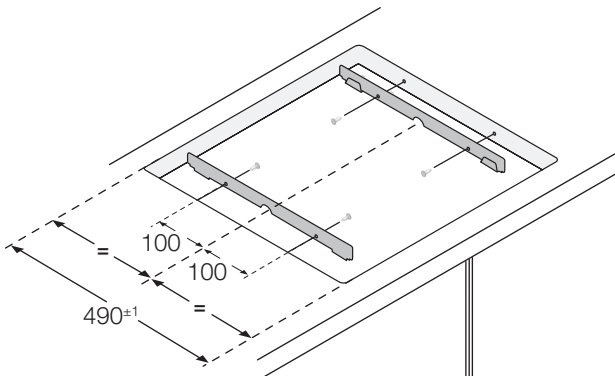
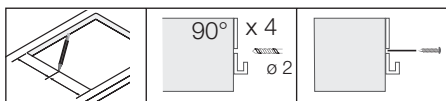

parts and features

COOKING ZONES

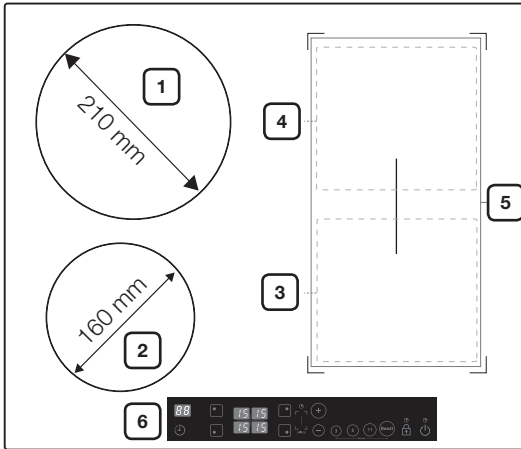

1. Induction cooking zone 2200W with Power Boost 3200W
2. Induction cooking zone 1400W with Power Boost 2000W
3. Induction front Bridge zone 1800W with Power Boost 2600W
4. Induction rear Bridge zone 1800W with Power Boost 2600W
5. Induction complete Bridge zone 3600W with Power Boost 5200W
6. Control panel

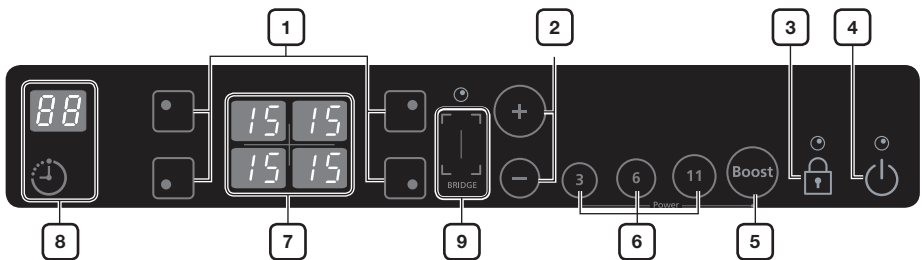

CONTROL PANEL

1. Cooking zone selectors
2. Heat setting selectors and Timer setting selectors
3. Lock control sensor
4. On/Off control sensor
5. Power Boost selector
6. Power Pre-selections
7. Indicators for heat settings and residual heat
8. Timer indicator and control sensor
9. Complete Bridge zone selector

COMPONENTS

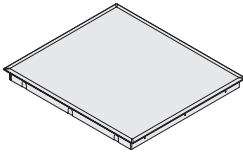

Induction Hob

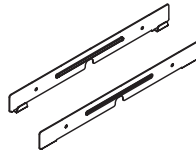

Installation Brackets

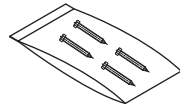

Screws

INDUCTION HEATING



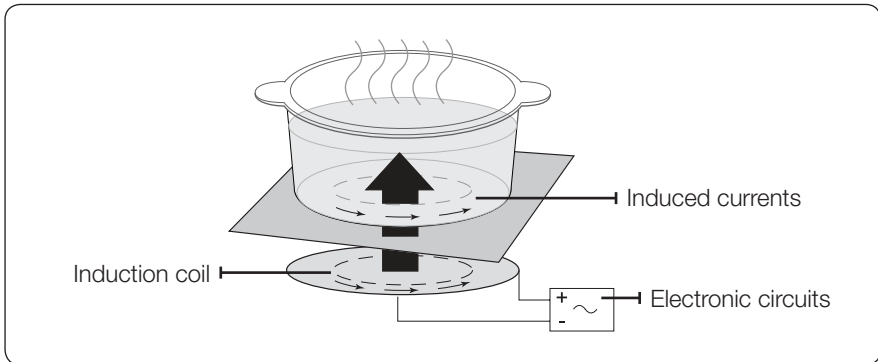



- **The Principle of Induction Heating:** When you place your cookware on a cooking zone and you turn it on, the electronic circuits in your induction hob produce "induced currents" in the bottom of the cookware which instantly raise cookware's temperature.















- **Greater speed in cooking and frying:** As the pan is heated directly and not the glass, the efficiency is greater than in other systems because no heat is lost. Most of the energy absorbed is transformed into heat.

THE KEY FEATURES OF YOUR APPLIANCE

- **Ceramic glass cooking surface:** The appliance has a ceramic glass cooking surface and four rapid - response cooking zones.
- **Touch control sensors:** Your appliance is operated using touch control sensors.
- **Easy cleaning:** The advantage of the ceramic glass cooking surface and the control sensors is their accessibility for cleaning. The smooth, flat surface is easy to clean.
- **On / Off sensor:** The "On / Off" control sensor provides the appliance with a separate mains switch. Touching this sensor switches the power supply on or off completely.
- **Control and function indicators:** Digital displays and indicator lights provide information about settings and activated functions, as well as the presence of residual heat in the various cooking zones.
- **Safety shutoff:** A safety shutoff ensures that cooking zones switch off automatically after a period of time if the setting has not been changed.
- **Residual heat indicator:** An icon for residual heat appears in the display if the cooking zone is so hot that there is a risk of burning.
- **Power Pre-selections:** You can choose pre-selected power conveniently.

	Heat setting 
	Heat setting 
	Heat setting 

- **Power Boost**  : Use this function to heat up the contents of the pan faster than maximum power level . (The display will show .)
- **Complete Bridge zone selector**  : Use this function to expand cooking zone into complete right side.
- **Auto Pan-Detection:** Each cooking zone incorporates an automatic pan-detection system, the system is calibrated in order to recognize pans of a diameter just slightly smaller than the cooking zone. Pans must always be placed centrally on each cooking zone. And you should use suitable cookware.
- **Digital displays:** The four display fields are assigned to the four cooking zones. They show the following information:
 -  the appliance has been switched on,
 -  to ,  selected heat settings,
 -  residual heat,
 -  the child lock is activated; and
 -  error message, the sensor has been touched for longer than 10 seconds.
 -  error message, when the hob is overheated because of abnormal operation. (example : operation with empty cookware)
 -  error message, cookware is unsuitable or too small or no cookware has been placed on the cooking zone.



SAFETY SHUTOFF

If one of the cooking zones is not switched off or the heat setting is not adjusted after an extended period of time, that particular cooking zone will automatically switch itself off.

Any residual warmth will be indicated with **H** (for “hot”) in the digital displays corresponding to the particular cooking zones.

The cooking zones switch themselves off at the following times.

Heat setting	Switch off
1-3	After 6 hours
4-6	After 5 hours
7-9	After 4 hours
10-15	After 1.5 hours

-  If the Hob is overheated because of abnormal operation, **H** will be displayed. And the Hob will be switched off.
-  If cookware is unsuitable or too small or no cookware has been placed on the cooking zone, **H** will be displayed. And after 5 minutes the corresponding cooking zone will be switched off.
-  Should one or more of the cooking zones switch off before the indicated time has elapsed, see the section “Troubleshooting”.

Other reasons why a cooking zone will switch itself off



All cooking zones will immediately switch themselves off if liquid boils over and lands on the control panel.

The automatic shutoff will also be activated if you place a damp cloth on the control panel. In both of these instances, the appliance will need to be switched on again using the main **On/Off control**  sensor after the liquid or the cloth has been removed .

RESIDUAL HEAT INDICATOR

When an individual cooking zone or the hob is turned off, the presence of residual heat is shown with an **H** (for “hot”) in the digital display of the appropriate cooking zones. Even after the cooking zone has been switched off, the residual heat indicator goes out only after the cooking zone has cooled.

You can use the residual heat for thawing or keeping food warm.

-  **Important:** As long as the residual heat indicator is illuminated, there is a risk of burns.
-  **Important:** If the power supply is interrupted, the **H** symbol will go out and information about residual heat will no longer be available. However, it may still be possible to burn yourself. This can be avoided by always taking care when near the hob.

TEMPERATURE DETECTION

If for any reason the temperatures on any of the cooking zones were to exceed the safety levels, should this happen then the cooking zone will automatically reduce to a lower power level.

When you have finished using the hob, the cooling fan will continue to run until the hob's electronics has cooled down. And the cooling fan switched itself on and off depending upon the temperature of the electronics.

before you begin

INITIAL CLEANING

Wipe the ceramic glass surface with a damp cloth and ceramic cooktop glass cleaner.



 **Important:** Do not use caustic or abrasive cleaners. The surface could be damaged.

COOKWARE FOR INDUCTION COOKING ZONES

The induction hob can only be turned on when a cookware with a magnetic base is placed on one of the cooking zones. You can use the following suitable cookware.

Cookware material

Cookware material	Suitable
Steel, Enamelled steel	Yes
Cast iron	Yes
Stainless steel	If appropriately labelled by the manufacturer
Aluminium, Copper, Brass	No
Glass, Ceramic, Porcelain	No

-  Cookware for induction hob is labelled as suitable by the manufacturer.
-  Certain cookware can make noise when being used on induction cooking zones. These noise are not a fault in the appliance and do not affect operation in any way.

SUITABILITY TEST

Cookware is suitable for induction cooking, if a magnet sticks to the bottom of the cookware.

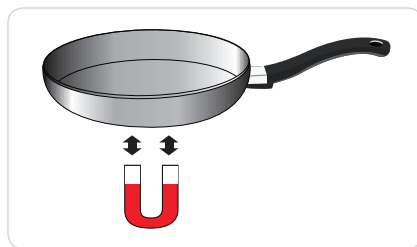

SIZE OF PANS

Induction cooking zones adapt automatically to the size of the bottom of the cookware up to a certain limit. However the magnetic part of the bottom of the cookware must have a minimum diameter depending upon the size of the cooking zone.

Diameter of cooking zones	Minimum diameter of the bottom of the cookware
210 mm	180 mm
160 mm	100 mm
Front or Rear Bridge	145 mm
Complete Bridge	180mm, oval, fish kettle

USING SUITABLE COOKWARE

Better pans produce better results.

- You can recognise good pans by their bases. The base should be as thick and flat as possible.
- When buying new pans, pay particular attention to the diameter of the base. Manufacturers often give only the diameter of the upper rim.
- Do not use pans which have damaged bases with rough edges or burrs. Permanent scratching can occur if these pans are slid across the surface.
- When cold, pan bases are normally bowed slightly inwards (concave). They should never be bowed outwards (convex).
- If you wish to use a special type of pan, for example, a pressure cooker, a simmering pan, or a wok, please observe the manufacturer's instructions.

Energy saving tips



You can save valuable energy by observing the following points.

- Always position pots and pans before switching on the cooking zone.
- Dirty cooking zones and pan bases increase power consumption.
- When possible, position the lids firmly on the pots and pans to cover completely.
- Switch the cooking zones off before the end of the cooking time to use the residual heat for keeping foods warm or for thawing.



Right!

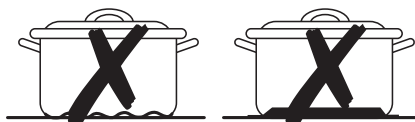

Wrong!

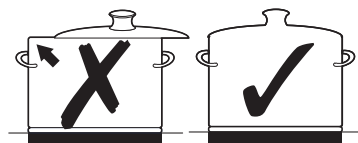

USING THE TOUCH CONTROL SENSORS

To operate the touch control sensors, touch the desired panel with the tip of your pointed finger until the relevant displays illuminate or go out, or until the desired function is activated.

Ensure that you are touching only one sensor panel when operating the appliance. If your finger is too flat on the panel, an adjacent sensor may be actuated as well.

SWITCHING THE APPLIANCE ON



1. Touch the **Lock control**  sensor for approximately 3 seconds.

2. The appliance is switched on using the **On/Off control**  sensor.

Touch the **On/Off control**  sensor for 1 second.

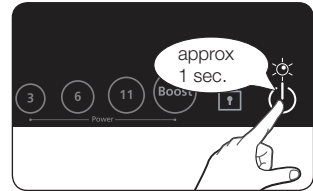
The digital displays will show .







 After the **On/Off control**  sensor has been actuated to switch on your appliance, a heat setting must be selected within approximately 10 seconds. Otherwise, the appliance will switch itself off for safety reasons.

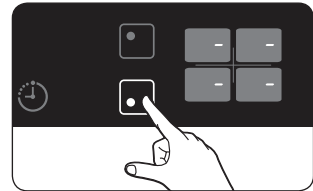

SELECT COOKING ZONE AND HEAT SETTING



1. For selecting the cooking zone, touch the corresponding cooking zone's key.

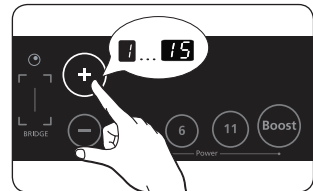

2. For setting and adjusting the power level ( to ) for cooking, touch the **Heat setting selectors** ( or ).



 For faster adjustment, keep your finger on the **Heat setting selectors** ( or ) until the required value is obtained.

If more than one sensor is pressed for longer than 10 seconds,  will show in the heat setting display. To reset, touch the **On/Off control**  sensor.

SWITCHING THE APPLIANCE OFF

To completely switch off the appliance, use the **On/Off control**  sensor.

Touch the **On/Off control**  sensor.

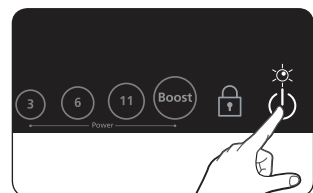

-  After switching off a single cooking zone or the entire cooking surface, the presence of residual heat will be indicated in the digital displays of the corresponding cooking zones in the form of an **H** (for “hot”).

SWITCHING A COOKING ZONE OFF

To switch off a cooking zone, return the setting to **0** by using the control panel's **0** control sensor.

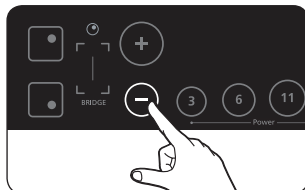

-  To switch off more quickly, touch the corresponding cooking zone's key twice.

USING THE CHILD SAFETY LOCK

You can use the child safety lock to safeguard against unintentionally turning on a cooking zone and activating the cooking surface.

Also the control panel, with the exception of the **On/Off control**  sensor, can be locked in order to prevent the settings from being changed unintentionally, for example, by wiping over the panel with a cloth.

Switching the child safety lock on / off

1. Touch the **Lock control**  sensor for approximately 3 seconds.
An acoustic signal will sound as confirmation.

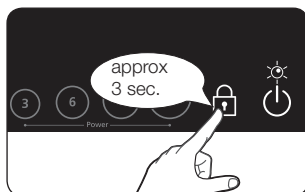

2. Touch **any control** sensor .
 will appear in the displays, indicating the child safety lock has been activated.

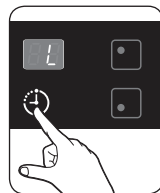

3. For switching the child safety lock off, touch the **Lock control**  sensor again for 3 seconds.
An acoustic signal will sound as confirmation.

TIMER

There are two ways to use the timer:

Using the timer as a safety shutoff:

If a specific time is set for a cooking zone, the cooking zone will shut itself off once this period of time has elapsed. This function can be used for multiple cooking zones simultaneously.

Using the timer to count down:

The countdown timer cannot be used if a cooking zone has been switched on.

Setting the safety shutoff

The cooking zone(s) for which you want to apply the safety shutoff must be switched on.

1. Using the **Timer control**  sensor, select the cooking zone for which the safety shutoff time is to be set.

After the first active cooking zone is selected, touching the timer's control sensor will cause the corresponding indicator to flash slowly.

For example, the front left indicator

corresponds to the front left cooking zone.  will appear in the timer display.

The next active cooking zone is selected by touching the **Timer control**  sensor again .



2. Use the **Timer setting selectors**  (+) or  (-) to set the desired amount of time, for example, 15 minutes,



after which the cooking zone will automatically switch itself off.

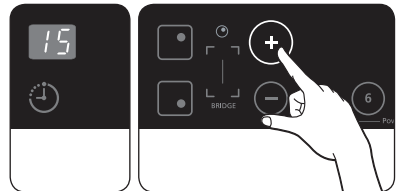

The safety shutoff is now activated.





To display the time remaining for any of the cooking zones, use the **Timer control**  sensor.

The corresponding control indicator will begin to blink slowly.

The settings are reset using the **Timer setting selectors**  (+) or  (-). After the set period of time has elapsed, the cooking zone automatically switches itself off, an acoustic signal sounds as confirmation and the timer display indicates .

-  To make the settings more quickly, touch any of the  (+) or  (-) **control** sensors until the desired value is reached.



If the  **control** sensor is touched first, the time setting will begin at 99 minutes; if the  **control** sensor is touched first, the time setting will begin at 1 minute.



Countdown timer

For the countdown timer to be used, the appliance must be switched on but all the cooking zones must be switched off.

1. Touch the **Timer control**  sensor.

 will appear in the timer display.

2. Set the desired period of time using the **Timer setting selectors**  or . The countdown timer function is now activated and the remaining time appears in the timer display.

To adjust the remaining time, touch the **Timer control**  sensor. and change the setting using the **Timer setting selectors**  or .

POWER BOOST CONTROL

The power boost function  makes additional power available to the each cooking zones. (example : bring a large volume of water to the boil)
The power boost function is activated for maximum 10 minutes for each cooking zones.

(for Complete Bridge zone power boost : maximum 5 minutes)

After these times, the cooking zones automatically return to power level 



 In certain circumstances, the Power boost function may be deactivated automatically to protect the internal electronic components of the hob.

BRIDGE CONTROL

The bridge function can operate complete right side cooking zone for using large size cookware. (example : oval cookware, fish kettle)

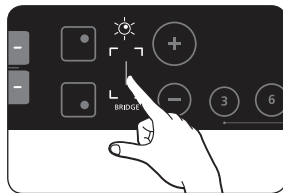
1. Touch the complete **Bridge** zone sensor key.



2. Touch the heat setting selectors  or . Heat setting display of right side(front, rear) will be changed together.

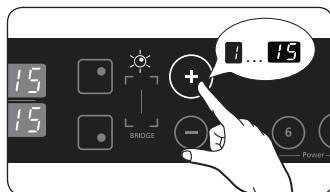

POWER MANAGEMENT

The cooking zones have a maximum power available to them.

If this power range is exceeded by switching on the power boost function, Power Management automatically reduced the heat setting of paired another cooking zone.

- Left side : No.1 and No.2 is paired cooking zone
- Right side : No.3 and No.4 is paired cooking zone

The indicator for this cooking zone changes from the heat setting set to maximum possible heat setting.

- Example

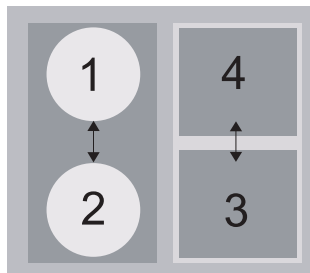

Last heat setting of cooking zone (No.3)	Paired another cooking zone's heat setting (No.4)	
	original heat setting	automatically changed heat setting
Power Boost	15 level	13 level

If the supply voltage is less than AC220V~, Power Management can be activated when the heat setting is **15**.

When the complete Bridge zone function is activated, Power Management automatically reduce the heat setting of left side(No.1 and No.2).

If the all left side(No.1 and No.2) cooking zones are used, maximum possible heat setting of complete Bridge zone is **15**.

To use the power boost function for complete Bridge zone, switch off one of the left side cooking zone.

SUGGESTED SETTINGS FOR COOKING SPECIFIC FOODS

The figures in the table below are guidelines. The heat settings required for various cooking methods depend on a number of variables, including the quality of the cookware being used and the type and amount of food being cooked.

Switch Setting	Cookingmethod	Examples for Use
14-15	Warming Sautéing Frying	Warming large amounts of liquid, boiling noodles, searing meat, (browning goulash, braising meat)
10-13	Intensive Frying	Steak, sirloin, hash browns, sausages, pancakes / griddle cakes
8-9	Frying	Schnitzel / chops, liver, fish, rissoles, fried eggs
6-7	Boiling	Cooking up to 1.5 l liquid, potatoes, vegetables
3-5	Steaming Stewing Boiling	Steaming and stewing of small amounts of vegetables, boiling rice and milk dishes
1-2	Melting	Melting butter, dissolving gelatine, melting chocolate

Note

- The heat settings indicated in the table above are provided only as guidelines for your reference.
- You will need to adjust the heat settings according to specific cookware and foods.

cleaning and care

HOB

 **Important:** Cleaning agents must not come into contact with a heated ceramic glass surface: All cleaning agents must be removed with adequate amounts of clean water after cleaning because they can have a caustic effect when the surface becomes hot. Do not use any aggressive cleaners such as grill or oven sprays, scouring pads or abrasive pan cleaners.

 Clean the ceramic glass surface after each use when it is still warm to the touch. This will prevent spillage from becoming burnt onto the surface. Remove scales, watermarks, fat drippings and metallic discolouration with the use of a commercially available ceramic glass or stainless steel cleaner.

Light Soiling

1. Wipe the ceramic glass surface with a damp cloth.
2. Rub dry with a clean cloth. Remnants of cleaning agent must not be left on the surface.
3. Thoroughly clean the entire ceramic glass cooking surface once a week with a commercially available ceramic glass or stainless steel cleaner.
4. Wipe the ceramic glass surface using adequate amounts of clean water and rub dry with a clean lint - free cloth.

Stubborn Soiling

1. To remove food that has boiled over and stubborn splashes, use a glass scraper.
2. Place the glass scraper at an angle to the ceramic glass surface.
3. Remove soiling by scraping with the blade.

 Glass scrapers and ceramic glass cleaners are available from specialty retailers.

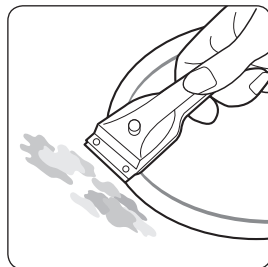

Problem Dirt

1. Remove burnt-on sugar, melted plastic, aluminium foil or other materials with a glass scraper immediately and while still hot.

 **Important:** There is a risk of burning yourself when the glass scraper is used on a hot cooking zone:

2. Clean the hob as normal when it has cooled down.

If the cooking zone on which something has melted has been allowed to cool, warm it up again for cleaning.

-  Scratches or dark blemishes on the ceramic glass surface, caused, for example, by a pan with sharp edges, cannot be removed. However, they do not impair the function of the hob.

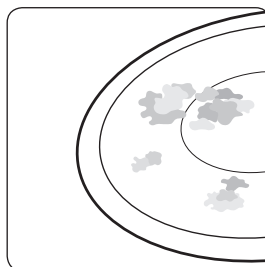

HOB FRAME (OPTION)

 **Important:** Do not use vinegar, lemon juice or scale remover on the hob frame; otherwise dull blemishes will appear.

1. Wipe the frame with a damp cloth.
2. Moisten dried debris with a wet cloth. Wipe and rub dry.

TO AVOID DAMAGING YOUR APPLIANCE

- Do not use the hob as a work surface or for storage.
- Do not operate a cooking zone if there is no pan on the hob or if the pan is empty.
- Ceramic glass is very tough and resistant to temperature shock, but it is not unbreakable.
It can be damaged by a particularly sharp or hard object dropping onto the hob.
- Do not place pans on the hob frame. Scratching and damage to the finish may occur.
- Avoid spilling acidic liquids, for example, vinegar, lemon juice and descaling agents, onto the hob frame, since such liquids can cause dull spots.
- If sugar or a preparation containing sugar comes into contact with a hot cooking zone and melts, it should be cleaned off immediately with a kitchen scraper while it is still hot. If allowed to cool, it may damage the surface when removed.
- Keep all items and materials that could melt, for example, plastics, aluminium foil and oven foils, away from the ceramic glass surface. If something of this nature melts onto the hob, it must be removed immediately with a scraper.

warranty and service

FAQS AND TROUBLESHOOTING

A fault may result from a minor error that you can correct yourself with the help of the following instructions. Do not attempt any further repairs if the following instructions do not help in each specific case.

 **Warning:** Repairs to the appliance are to be performed only by a qualified service technician. Improperly effected repairs may result in considerable risk to the user. If your appliance needs repair, please contact your customer service centre.

What should I do if the cooking zones are not functioning?

Check for the following possibilities:

- The fuse in the house wiring (fuse box) is intact. If the fuses trip a number of times, call an authorised electrician.
- The appliance is properly switched on.
- The control indicators in the control panel are illuminated.
- The cooking zone is switched on.
- The cooking zones are set at the desired heat settings.

What should I do if the cooking zones will not switch on?

Check for the following possibilities:

- A period of more than 10 seconds has elapsed between when the On / Off button was actuated and the desired cooking zone switches on (see the section “Switching the appliance on”).
- The control panel is partially covered by a damp cloth or liquid.

What should I do if the display except for the residual warmth indicator suddenly disappears?

This could be a result of one of two possibilities:

- The On / Off sensor was accidentally actuated.
- The control panel is partially covered by a damp cloth or liquid.

What should I do if, after the cooking zones have been switched off, residual warmth is not indicated in the display?

Check for the following possibility:

- The cooking zone was only briefly used and therefore did not become hot enough. If the cooking zone is hot, please call the customer service centre.

What should I do if the cooking zone will not switch on or off?

This could be due to one of the following possibilities:

- The control panel is partially covered by a damp cloth or liquid.
- The child safety lock is on.

What should I do if the display is illuminated?

Check for the following:

- The control panel is partially covered by a damp cloth or liquid. To reset, press the “On / Off” control sensor.

What should I do if the display is illuminated?

Check for the following:

- The hob is overheated because of abnormal operation.
- After hob is cooled down, press the “On / Off” control sensor for resetting.

What should I do if the display is illuminated?

Check for the following:

- Cookware is unsuitable or too small or no cookware has been placed on the cooking zone
- If you use suitable cookware, displayed message will automatically disappear.

If you request a service call because of an error made in operating the appliance, the visit from the customer service technician may incur a charge even during the warranty period.

SERVICE

Before calling for assistance or service, please check the section “Troubleshooting.” If you still need help, follow the instructions below.

Is it a technical fault?

If so, please contact your customer service centre.

Always prepare in advance for the discussion. This will ease the process of diagnosing the problem and also make it easier to decide if a customer service visit is necessary.

Please take note of the following information.

- What form does the problem take?
- Under what circumstances does the problem occur?

When calling, please know the model and serial number of your appliance. This information is provided on the rating plate as follows:

- Model description
- S / N code (10 digits)

We recommend that you record the information here for easy reference.

Model: _____

Serial number: _____

When do you incur costs even during the warranty period?

- if you could have remedied the problem yourself by applying one of the solutions provided in the section “Troubleshooting,”
- if the customer service technician has to make several service calls because he was not provided with all of the relevant information before his visit and as a result, for example, has to make additional trips for parts. Preparing for your phone call as described above will save you the cost of these trips.

technical data

TECHNICAL DATA

Appliance dimensions	Width	575 mm
	Depth	505 mm
	Height	62 mm
Worktop cut - out dimensions	Width	560 mm
	Depth	490 mm
	Corner radius	3 mm
Connection voltage		220 - 240 V ~ 50/60 Hz
Maximum connected load power		7.2 kW
Weight	Net	12.0 kg
	Gross	14.5 kg

COOKING RINGS

Position	Diameter	Power
Front left	160 mm	1400W / Boost 2000W
Rear left	210 mm	2200W / Boost 3200W
Front Bridge	-	1800W / Boost 2600W
Rear Bridge	-	1800W / Boost 2600W
Complete Bridge	-	3600W / Boost 5200W



QUESTIONS OR COMMENTS

COUNTRY	CALL	OR VISIT US ONLINE AT
AUSTRALIA	1300 362 603	www.samsung.com/au
New zealand	0800 SAMSUNG (0800-726-786)	www.samsung.com/nz
CHINA	800-810-5858 400-810-5858 010-6475 1880	www.samsung.com/cn
HONG KONG	3698-4698	www.samsung.com/hk
INDIA	3030 8282 1800 110011 1-800-3000-8282	www.samsung.com/in
INDONESIA	0800-112-8888	www.samsung.com/id
JAPAN	0120-327-527	www.samsung.com/jp
MALAYSIA	1800-88-9999	www.samsung.com/my
PHILIPPINES	1-800-10-SAMSUNG(726-7864) 1-800-3-SAMSUNG(726-7864) 02-5805777	www.samsung.com/ph
SINGAPORE	1800-SAMSUNG(726-7864)	www.samsung.com/sg
THAILAND	1800-29-3232 02-689-3232	www.samsung.com/th
TAIWAN	0800-329-999	www.samsung.com/tw
VIETNAM	1 800 588 889	www.samsung.com/vn

Code No.: DG68-00205A

Free Manuals Download Website

<http://myh66.com>

<http://usermanuals.us>

<http://www.somanuals.com>

<http://www.4manuals.cc>

<http://www.manual-lib.com>

<http://www.404manual.com>

<http://www.luxmanual.com>

<http://aubethermostatmanual.com>

Golf course search by state

<http://golfingnear.com>

Email search by domain

<http://emailbydomain.com>

Auto manuals search

<http://auto.somanuals.com>

TV manuals search

<http://tv.somanuals.com>