

ENGLISH

Digital Video Camcorder

Mini DV Digital Video Cassette

SCD103/D105

- AF** Auto Focus
- CCD** Charge Coupled Device
- LCD** Liquid Crystal Display

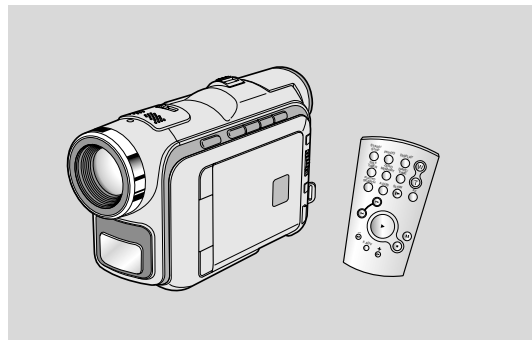

Owner's Instruction Book



Before operating the unit, please read this instruction book thoroughly, and retain it for future reference.

SAMSUNG

ELECTRONICS

US PATENT 4415844

ENGLISH**Notices and Safety Instructions****Safety Instructions**

	CAUTION RISK OF ELECTRIC SHOCK DO NOT OPEN	
<p>CAUTION: TO REDUCE THE RISK OF ELECTRIC SHOCK, DO NOT REMOVE COVER (OR BACK). NO USER SERVICEABLE PARTS INSIDE. REFER SERVICING TO QUALIFIED SERVICE PERSONNEL.</p>		

To prevent electric shock, match wide blade of plug to wide slot and fully insert.



This symbol is intended to alert the user to the presence of uninsulated dangerous voltage within the product's enclosure that may be of sufficient magnitude to constitute a risk of fire or electric shock.



This symbol is intended to alert the user to the presence of important operating and maintenance instructions in the literature accompanying this product.

1. READ INSTRUCTIONS:

All the safety and operating instructions should be read before the CAMCORDER is operated.

2. RETAIN INSTRUCTIONS:

The safety and operating instructions should be retained for future reference.

3. HEED WARNINGS:

All warnings on the CAMCORDER and in the operating instructions should be adhered to.

4. FOLLOW INSTRUCTIONS:

All operating and maintenance instructions should be followed.

5. CLEANING:

Unplug this CAMCORDER from the wall outlet before cleaning. Do not use liquid or aerosol cleaners. Use a dry cloth used for dusting cabinets.

6. ATTACHMENTS:

Do not use attachments not recommended by the CAMCORDER product manufacturer as they may be hazardous.

7. WATER AND MOISTURE:

Do not use this CAMCORDER near water; for example, near a bathtub, wash bowl, kitchen sink, laundry tub, in a wet basement, near a swimming pool or lake.

8. ACCESSORIES:

Do not place this CAMCORDER on an unstable cart, stand, tripod, bracket or table. The CAMCORDER may fall, causing serious injury to a child or adult, and serious damage to the unit.

Use only with a cart, stand, tripod, bracket, or table recommended by the manufacturer or sold with the CAMCORDER. Any mounting of the unit should follow the manufacturer's instructions and should use a mounting accessory recommended by the manufacturer.

A. An appliance and cart combination should be moved with care. Quick stops, excessive force and uneven surfaces may cause the appliance and cart combination to overturn.

PORTABLE CART WARNING
(Symbol provided by RETAC)



Notices and Safety Instructions

9. VENTILATION:

Slots and openings in the cabinet are provided for ventilation to ensure reliable operation of the CAMCORDER and to protect it from overheating. These openings must not be blocked or covered. Never place your CAMCORDER on a bed, sofa, rug, or other similar surface; on or near a radiator or heat register. This CAMCORDER should not be placed in a built-in installation such as a bookcase or rack unless proper ventilation is provided or the manufacturer's instructions have been adhered to.

10. POWER SOURCES:

The CAMCORDER should be operated only from the type of power source indicated on the label. If you are not sure of the type of power supply at your home, consult your appliance dealer or local power company. A CAMCORDER is intended to be operated from battery power, or other sources, refer to the operating instructions.

11. GROUNDING OR POLARIZATION:

This CAMCORDER may be equipped with either a polarized 2-wire AC line plug (a plug having one blade wider than the other) or a 3-wire grounding type plug, a plug having a third (grounding) pin.

If you are unable to insert the plug fully into the outlet, try reversing the plug. If the plug still fails to fit, contact your electrician to replace your outlet. Do not defeat the safety purpose of the polarized plug.

12. POWER-CORD PROTECTION:

Power-supply cords should be routed so that they are not likely to be walked on or pinched by items placed upon or against them, paying particular attention to cords or plugs, convenient receptacles, and the point where they exit from the unit.

13. OUTDOOR ANTENNA GROUNDING:

If an outside antenna or cable system is connected to the CAMCORDER, be sure the antenna or cable system is grounded to provide some protection against voltage surges and built-up static charges. Section 810 of the National Electrical Code, ANSI/NFPA No. 70-1984, provides information with respect to proper grounding of the mast and supporting structure, grounding of the lead-in wire and supporting structure, grounding of the mast and supporting structure, grounding of the lead-in wire to an antenna discharge unit, size of grounding to conductors, location of antenna-discharge unit, connection to grounding electrodes and requirements for the grounding electrode. See figure below.

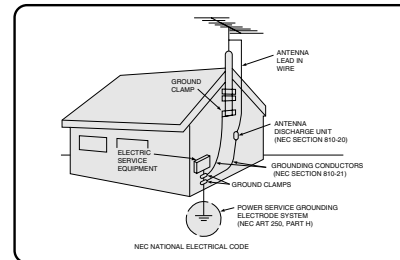

ENGLISH**Notices and Safety Instructions**

14. LIGHTNING:

For added protection of this CAMCORDER during a lightning storm or when it is left unattended and unused for long periods of time, unplug it from the wall outlet and disconnect the antenna or cable system.

This will prevent damage to the CAMCORDER due to lightning and power-line surges.

15. POWER LINES:

An outside antenna system should not be located in the vicinity of overhead power lines or other electric light or power circuits where it can fall into such power lines or circuits. When installing an outside antenna system, extreme care should be taken to keep from touching such power lines or circuits as contact with them might be fatal.

16. OVERLOADING:

Do not overload wall outlets and extension cords as this can result in a risk of fire or electric shock.

17. OBJECTS AND LIQUIDS:

Never push objects of any kind into this CAMCORDER through openings as they may touch dangerous voltage points or short out a part that could result in a fire or electric shock.

Never spill liquids of any kind onto the CAMCORDER. Should spillage occur, unplug unit and have it checked by a technician before use.

18. SERVICING:

Do not attempt to service this CAMCORDER yourself. Opening or removing covers may expose you to dangerous voltage or other hazards.

Refer all servicing to qualified service personnel.

19. DAMAGE REQUIRING SERVICE:

Unplug this CAMCORDER from the wall outlet and refer servicing to qualified service personnel under the following conditions:

- a. When the power-supply cord or plug is damaged.
- b. If any liquid has been spilled onto, or objects have fallen into the CAMCORDER.
- c. If the CAMCORDER has been exposed to rain or water.
- d. If the CAMCORDER does not operate normally by following the operating instructions, adjust only those controls that are covered by the operating instructions. Improper adjustment of other controls may result in damage and will often require extensive work by a qualified technician to restore the CAMCORDER to its normal operation.
- e. If the CAMCORDER has been dropped or the cabinet has been damaged.
- f. When the CAMCORDER exhibits a distinct change in performance, this indicates a need for service.

20. REPLACEMENT PARTS:

When replacement parts are required, be sure the service technician has used replacement parts specified by the manufacturer and having the same characteristics as the original part.

Unauthorized substitutions may result in fire, electric shock or other hazards.

21. SAFETY CHECK:

Upon completion of any service or repairs to this CAMCORDER, ask the service technician to perform safety checks to determine that the CAMCORDER is in safe operating order.

Notices and Safety Instructions

22. To prevent damage which may result in fire or shock hazard, do not expose this appliance to rain or moisture.
23. If this power supply is used at 240V ac, a suitable plug adapter should be use.

NOTE TO CATV SYSTEM INSTALLER:

This reminder is provided to call the CATV system installer's attention to Article 820-40 of the NEC that provides guidelines for proper grounding and, in particular, specifies that the cable ground shall be connected to the grounding system of the building as close to the point of cable entry as practical.

USER INSTALLER CAUTION:

Your authority to operate this FCC certified equipment could be voided if you make changes or modifications not expressly approved by this party responsible for compliance to part 15 FCC rules.

NOTE:

"Hg LAMP(S) INSIDE THIS PRODUCT CONTAIN MERCURY AND MUST BE RECYCLED OR DISPOSED OF ACCORDING TO LOCAL, STATE OR FEDERAL LAWS"

NOTE: This equipment has been tested and found to comply with the limits for a Class B digital device, pursuant to part 15 of the FCC Rules. These limits are designed to provide reasonable protection against harmful interference in a residential installation. This equipment generates, uses and can radiate radio frequency energy and, if not installed and used in accordance with the instructions, may cause harmful interference to radio communications. However, there is no guarantee that interference will not occur in a particular installation. If this equipment does cause harmful interference to radio or television reception, which can be determined by turning the equipment off and on, the user is encouraged to try to correct the interference by one or more of the following measures:

- Reorient or relocate the receiving antenna.
- Increase the separation between the equipment and receiver.
- Connect the equipment into an outlet on a circuit different from that to which the receiver is connected.
- Consult the dealer or an experienced radio/TV technician for help and for additional suggestions.

The user may find the following booklet prepared by the Federal Communications Commission helpful : "How to Identify and Resolve Radio-TV Interference Problems."

This Booklet is available from the U.S. Government Printing Office, Washington, D.C. 20402, Stock No. 004-000-00345-4.

FCC Warning

The user is cautioned that changes or modifications not expressly approved by the manufacturer could void the user's authority to operate the equipment.

FCC ID : A3L04DELTA2

This device complies with Part 15 of FCC Rules.

Operation is subject to the following two conditions;

- (1) This device may not cause harmful interference, and
- (2) This device must accept any interference received, including interference that may cause undesired operation.

ENGLISH**Contents**

Notes and Safety Instructions	6
Getting to Know Your Camcorder	11
Features	11
Accessories Supplied with camcorder	12
Front & Left View	13
Left side View	14
Right & Top View	15
Rear & Bottom View	16
Remote control (SCD105 only)	17
OSD (On Screen Display in CAMERA and PLAYER modes)	18
OSD (On Screen Display in M.REC and M.PLAY modes)	19
Turning the OSD on/off (On Screen Display)	19
Preparation	20
How to use the Remote Control (SCD105 only)	20
Battery Installation for the Remote Control	20
Self Record using the Remote Control	20
Lithium Battery Installation	21
Adjusting the Hand Strap	22
Hand strap	22
Shoulder Strap	22
Attaching the Lens Cover	22
Connecting a Power Source	23
To use the AC Power adapter and DC Cable	23
To select the CAMCORDER mode	23
Using the Lithium Ion Battery Pack	24
Charging the Lithium Ion Battery Pack	24
Table of continuous recording time based on model and battery type	25
Battery level display	26
Inserting and Ejecting a Cassette	27
BASIC Recording	28
Making your First Recording	28
Selecting OSD LANGUAGE	29
Record Search (REC SEARCH)	30
Hints for Stable Image Recording	31
Recording with the LCD monitor	31
Recording with the Viewfinder	31
Adjusting the LCD	32
Using the VIEWFINDER	33
Adjusting the Focus	33
Playing back a tape you have recorded on the LCD	34
Adjusting the LCD during PLAY	35
Controlling Sound from the Speaker	35

Contents

Advanced Recording	36
Use of various Functions	36
Setting menu items	36
Set the camcorder to CAMERA or PLAYER mode and M.REC or M.PLAY mode	37
Availability of functions in each mode	38
CLOCK SET	39
WL. REMOTE (SCD105 only)	40
DEMONSTRATION	41
PROGRAM AE	42
Setting the PROGRAM AE	43
WHT. BALANCE (WHITE BALANCE)	44
Zooming In and Out	45
Tele MACRO	45
Digital Zoom	46
DIS (Digital Image Stabilizer)	47
DSE (Digital Special Effects) SELECT	48
Selecting an effect	49
REC MODE	50
AUDIO MODE	51
WIND CUT	52
DATE/TIME	53
TV DISPLAY	54
Using Quick Menu	55
Setting the Quick menu	56
SHUTTER SPEED & EXPOSURE	57
SLOW SHUTTER(Low Shutter Speed)	58
EASY Mode (for Beginners)	59
AF/MF (Auto Focus/Manual Focus)	60
Auto Focusing	60
Manual Focusing	60
BLC (Back Light Compensation)	61
Fade In and Out	62
To Start Recording	62
To Stop Recording (use FADE IN / FADE OUT)	62
Audio dubbing (SCD105 only)	63
Dubbing sound	63
Dubbed Audio Playback	64
PHOTO Image Recording	65
Searching for a PHOTO picture	65
NITE PIX (0 lux recording)	66
POWER NITE PIX	67
Using the VIDEO LIGHT	68
Various Recording Techniques	69

ENGLISH**Contents**

Playback	70
Tape Playback	70
Playback on the LCD	70
Playback on a TV monitor	70
Connecting to a TV which has Audio/Video input jacks	70
Connecting to a TV which has no Audio and Video input jacks	71
Playback	71
Various Functions while in PLAYER mode	72
Playback pause	72
Picture search (Forward/Reverse)	72
Slow playback (Forward/Reverse) (SCD105 only)	72
Frame advance (To play back frame by frame) (SCD105 only)	73
X2 Playback (Forward/Reverse) (SCD105 only)	73
Reverse playback (SCD105 only)	73
ZERO MEMORY (SCD105 only)	74
PB DSE (Playback Digital Special Effects)	75
PB ZOOM	76
IEEE 1394 Data Transfer	77
Transferring IEEE1394 (i.LINK)-DV standard data connections	77
Connecting to a DV device	77
Connecting to a PC	77
System requirements	78
Recording with a DV connection cable	78
USB interface	79
Transferring a Digital Image through a USB Connection	79
System Requirements	79
Installing DVC Media 5.1 Program	80
Using the "PC camera" function	80
Using the "removable Disk" function	81
Using the "USB streaming" function	81
Connecting to a PC	81
Digital Still Camera mode	82
MEMORY STICK (Optional Accessory)	82
Memory Stick Functions	82

Contents

Inserting and ejecting the Memory Card	83
Structure of folders and files on the Memory Card	84
Image Format	84
Selecting the CAMCORDER mode	84
MEMORY FILE NUMBER	85
Selecting the image quality	86
Select the image quality	86
Number of images on the Memory Card	86
Recording Still images to a Memory Card in M.REC Mode	87
Recording images to a Memory Card	87
Recording an image from a cassette as a still image	88
Viewing Still images	89
To view a Single image.....	89
To view a slide show.....	89
To view the Multi Display	90
Copying still images from a cassette to Memory Card	91
Marking images for printing	92
Protection from accidental erasure	93
Deleting Still images	94
Formatting the Memory Card	95
Attention	95
MPEG RECORDING	96
Selecting the moving picture sizes	97
MPEG Playback	98
Maintenance.....	99
After finishing a recording	99
Cleaning and Maintaining the Camcorder.....	100
Cleaning the Video Heads	100
Using Your Camcorder Abroad	101
Power sources	101
Color system	101
Troubleshooting.....	102
Troubleshooting	102
Self Diagnosis Display	102
Moisture Condensation	102
Self Diagnosis Display in M.REC, M.PLAY mode	103
Specifications	105
INDEX	106
Warranty(SEA users only).....	107

ENGLISH

Notes and Safety Instructions

Notes regarding the rotation of the LCD screen

Please rotate the LCD screen carefully as illustrated.

Over rotation may cause damage to the inside of the hinge that connects the LCD screen to the Camcorder.

1. LCD screen closed.

2. Standard recording using the LCD screen.

- Open the LCD screen with your finger.

3. Recording when looking at the LCD screen from the top.

4. Recording when looking at the LCD screen from the front.

5. Recording with the LCD screen closed.

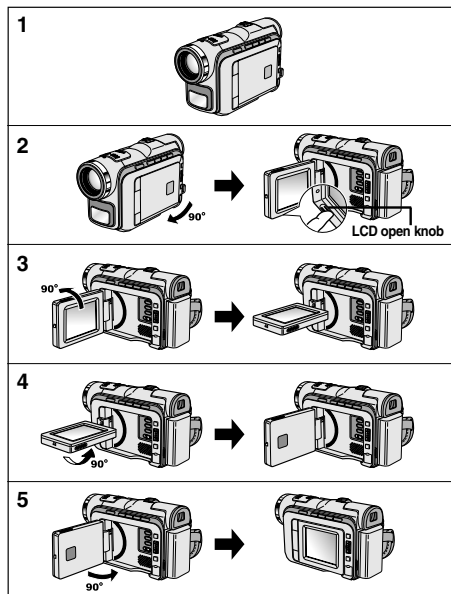

Notes and Safety Instructions

Notices regarding COPYRIGHT

Television programs, video tapes, DVD titles, films, and other program materials may be copyrighted. Unauthorized copying of copyrighted material may be against the law.

Notes regarding moisture condensation

1. A sudden rise in atmospheric temperature may cause condensation to form inside the camcorder.

for example:

- When you move the camcorder from a cold location to a warm location (e.g. from outside to inside during winter.)
 - When you move the camcorder from a cool location to a hot location (e.g. from inside to outside during the summer.)
2. If the  (DEW) protection feature is activated, leave the camcorder for at least two hours in a dry, warm room with the cassette compartment opened and the battery pack removed.

Notes regarding CAMCORDER

1. Do not leave the camcorder exposed to high temperature (above 60°C or 140°F).
For example, in a parked car in the sun or exposed to direct sunlight.
2. Do not let the camcorder get wet.
Keep the camcorder away from rain, sea water, and any other form of moisture. If the camcorder gets wet, it may get damaged.
Sometimes a malfunction due to exposure to liquids cannot be repaired.

ENGLISH**Notes and Safety Instructions*****Notes regarding the battery pack***

- Make sure that the battery pack is fully charged before starting to record.
- To preserve battery power, keep your camcorder turned off when you are not operating it.
- If your camcorder is in CAMERA mode, and it is left in STBY mode without being operated for more than 5 minutes with a tape inserted, it will automatically turn itself off to protect against unnecessary battery discharge.
- Make sure that the battery pack is fitted firmly into place.
Dropping the battery pack may damage it.
- A brand new battery pack is not charged.
Before using the battery pack, you need to charge it completely.
- It is a good idea to use the viewfinder rather than the LCD when making a long recording, because the LCD uses up more battery power.

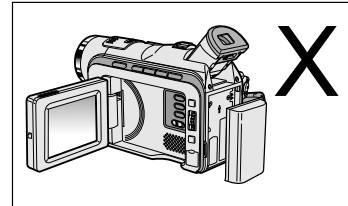

* When the battery reaches the end of its life, please contact your local dealer.
The batteries have to be dealt with as chemical waste.

Notes regarding the Video Head Cleaning

- To ensure normal recording and a clear picture, clean the video heads regularly.
If a square block-shape distorts playback, or only a blue screen is displayed, the video heads may be dirty.
If this happens, clean the video heads with a dry type cleaning cassette.
- Do not use a wet-type cleaning cassette. It may damage the video heads.

Notes and Safety Instructions

Note regarding the LENS

- Do not film with the camera lens pointing directly at the sun.
Direct sunlight can damage the CCD (Charge Coupled Device).

Notes regarding electronic viewfinder

1. Do not position the camcorder such that the viewfinder is pointing towards the sun.
Direct sunlight can damage the inside of the viewfinder. Be careful when placing the camcorder under sunlight or near a window exposed to sunlight.

Notes regarding 'Record' or 'Playback' using the LCD

1. The LCD display has been manufactured using high precision technology. However, there may be tiny dots (red, blue or green in color) that appear on the LCD display. These dots are normal and do not affect the recorded picture in any way.
2. When you use the LCD display under direct sunlight or outdoors, it may be difficult to see the picture clearly.
If this occurs, we recommend using the viewfinder.
3. Direct sunlight can damage the LCD monitor.



Notes regarding the hand strap

- To ensure a steady picture while filming, check that the hand strap is properly adjusted.
- Do not force your hand into the hand strap as you could damage it.

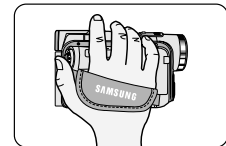

ENGLISH

Notes and Safety Instructions

Precautions regarding the Lithium battery

1. The lithium battery maintains the clock function and user settings; even if the battery pack or AC adapter is removed.
2. The lithium battery for the camcorder lasts about 6 months under normal operation from time of installation.
3. When the lithium battery becomes weak or dead, the date/time indicator will display “---” when you set the DATE/TIME to ON. When this occurs, replace the lithium battery with a new one (type CR2025).
4. There is a danger of explosion if battery is incorrectly replaced.
Replace only with the same or equivalent type.

Warning: Keep the LITHIUM BATTERY out of reach of children. Should a battery be swallowed, consult a doctor immediately.

Getting to Know Your Camcorder

Features

- **MULTI OSD LANGUAGE**
You can select the desired OSD Language among English, French, Spanish, Portuguese, German and Italian.
- **Digital data transfer function with IEEE1394**
By incorporating the IEEE 1394 (i.LINK™ : i.LINK is a serial data transfer protocol and interconnectivity system, used to transmit DV data) high speed data transport port, both moving and still images can be transferred to a PC, making it possible to produce or edit various images.
- **USB interface for digital image data transfer**
You can transfer images to a PC using the USB interface without an add-on card.
- **PHOTO**
The PHOTO function lets you capture an object as a still along with sound, while in Camera mode.
- **900x Digital zoom**
Allows you to magnify an image up to 900 times its original size.
- **Color TFT LCD**
A high-resolution color TFT LCD gives you clean, sharp images as well as the ability to review your recordings immediately.
- **Digital Image Stabilizer (DIS)**
The DIS compensates for any handshake, reducing unstable images particularly at high magnification.
- **Various digital effects**
The DSE (Digital Special Effects) allows you to give your films a special look by adding various special effects.
- **Back Light Compensation (BLC)**
The BLC function compensates for the bright background behind a subject you're recording.
- **Program AE**
The Program AE enables you to alter the shutter speed and aperture to suit the type of scene/action to be filmed.
- **NITE PIX**
The NITE PIX function enables you to record a subject in a dark place.
- **Digital Still Camera function**
 - Using Memory Card, you can easily record and playback standard still images.
 - You can transfer standard still images on the Memory Card to your PC using the USB interface.
- **MPEG Recording**
MPEG recording makes it possible to record video onto a Memory Card.
- **MULTI MEMORY CARD SLOT (SCD105 only)**
Multi Memory Card Slot is able to use the Memory Stick, the MMC and the SD.

ENGLISH**Getting to Know Your Camcorder****Accessories Supplied with camcorder**













Make sure that the following basic accessories are supplied with your digital video camera.

Basic Accessories

1. Lithium Ion Battery pack
2. AC Power Adapter (AA-E8 TYPE)
3. AC Cord
4. AUDIO/VIDEO Cable
5. Instruction Book
6. Lithium battery for Remote Control or Clock. (TYPE: CR2025)
7. Remote Control (SCD105 only)
8. USB cable
9. Software CD
10. Lens Cover
11. Shoulder strap

Optional Accessories

12. S-VIDEO Cable
13. Memory Stick

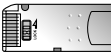
1. Lithium Ion Battery pack  AD43-00128A	2. AC Power Adapter (AA-E8 TYPE)  AD44-00090A	3. AC cord  AD39-00076A
4. AUDIO/VIDEO Cable  AD39-00001A	5. Instruction Book  INSTRUCTION BOOK	6. Lithium battery (CR2025)  AD43-10130H
7. Remote Control (SCD105 only)  AD59-00085A	8. USB cable  AD39-00073A	9. Software CD 
10. Lens Cover  AD97-08447A	11. Shoulder strap  AD72-00054B	
12. S-VIDEO Cable  AC39-42001Z	13. Memory Stick  1109-001221	

Getting to Know Your Camcorder

Front & Left View

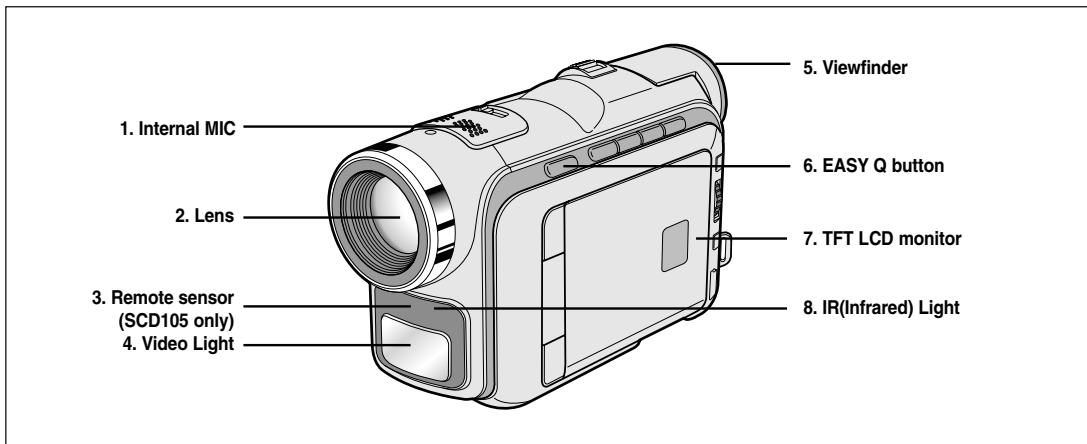

- 1. Internal MIC
- 2. Lens
- 3. Remote sensor (SCD105 only)
- 4. Video Light

- 5. Viewfinder (see page 33)
- 6. EASY Q button (see page 59)
- 7. TFT LCD monitor
- 8. IR(Infrared) Light

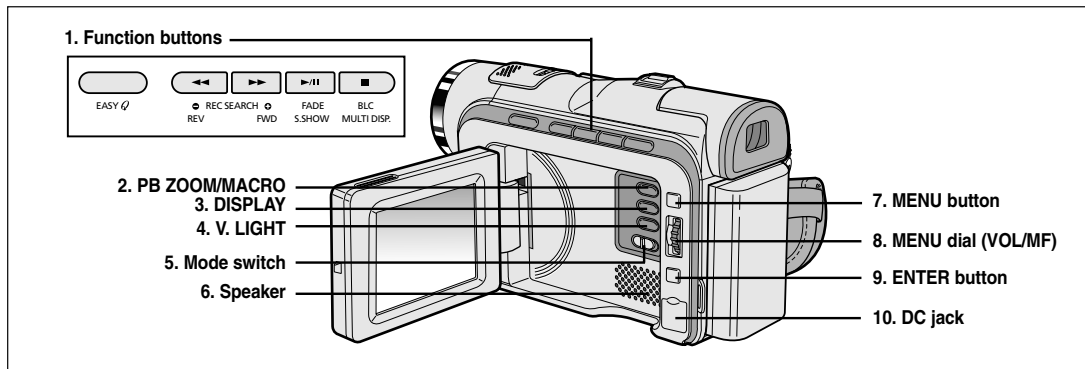
ENGLISH**Getting to Know Your Camcorder****Left Side View****1. Function buttons**

PLAYER	CAMERA	M.PLAY
-	EASY	-
◀◀ : (REW)	REC SEARCH -	REV
▶▶ : (FF)	REC SEARCH +	FWD
▶ : (PLAY/STILL)	FADE	SLIDE SHOW
■ : (STOP)	BLC	MULTI DISP.

- 2. PB ZOOM/MACRO**
- 3. DISPLAY**
- 4. V. LIGHT**
- 5. Mode switch (MEMORY CARD/TAPE)**
- 6. Speaker**
- 7. MENU button**
- 8. MENU dial(VOL/MF)**
- 9. ENTER button**
- 10. DC jack**

Getting to Know Your Camcorder

Right & Top View

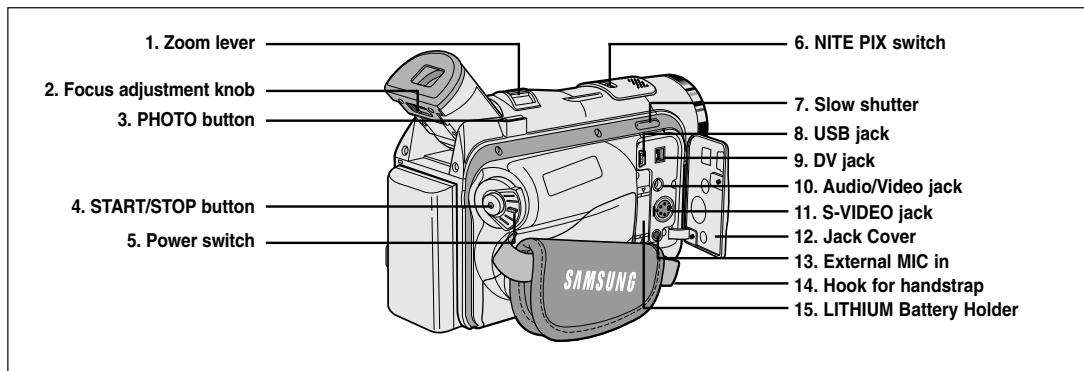

- | | |
|--------------------------|----------------------------|
| 1. Zoom lever | 6. NITE PIX switch |
| 2. Focus adjustment knob | 7. Slow shutter |
| 3. PHOTO button | 8. USB jack |
| 4. START/STOP button | 9. DV jack |
| 5. Power switch | 10. Audio/Video jack |
| | 11. S-VIDEO jack |
| | 12. Jack Cover |
| | 13. External MIC in |
| | 14. Hook for handstrap |
| | 15. LITHIUM Battery Holder |
-
- | | |
|------------------------------------|----------------------------|
| 1. Zoom lever | 8. USB jack |
| 2. Focus adjustment knob | 9. DV jack |
| 3. PHOTO button
(see page 65) | 10. Audio/Video jack |
| 4. START/STOP button | 11. S-VIDEO jack |
| 5. Power switch (CAMERA or PLAYER) | 12. Jack Cover |
| 6. NITE PIX switch | 13. External MIC in |
| 7. Slow shutter | 14. Hook for handstrap |
| | 15. LITHIUM Battery Holder |

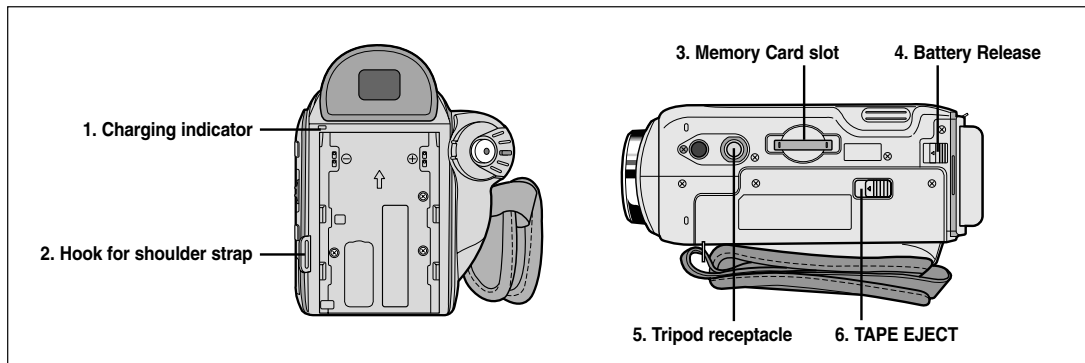
ENGLISH**Getting to Know Your Camcorder****Rear & Bottom View****Memory Card slot**

1. Charging indicator
2. Hook for shoulder strap
3. Memory Card slot
4. Battery Release
5. Tripod receptacle
6. TAPE EJECT

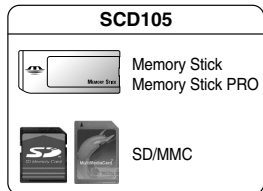
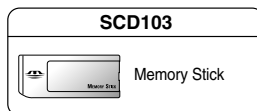

(Usable MEMORY CARD)

Getting to Know Your Camcorder

Remote control (SCD105 only)

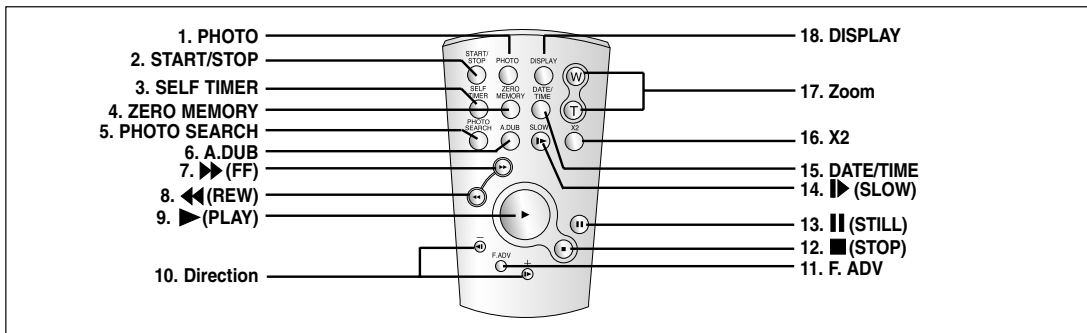

- | | |
|------------------------------|---|
| 1. PHOTO | 10. Direction (◀◀ , ►►) (see page 72) |
| 2. START/STOP | 11. F. ADV (see page 73) |
| 3. SELF TIMER (see page 20) | 12. ■ (STOP) |
| 4. ZERO MEMORY (see page 74) | 13. (STILL) |
| 5. PHOTO Search | 14. ►► (SLOW) |
| 6. A.DUB (see page 63) | 15. DATE/TIME |
| 7. ►► (FF) | 16. X2 (see page 73) |
| 8. ◀◀ (REW) | 17. Zoom |
| 9. ► (PLAY) | 18. Display |

ENGLISH**Getting to Know Your Camcorder*****OSD (On Screen Display in CAMERA and PLAYER modes)***

1. Battery level (see page 26)
2. Easy mode (see pages 59)
3. DSE (Digital Special Effects) mode (see page 48)
4. Program AE (see page 42)
5. White Balance mode (see page 44)
6. BLC (Back Light Compensation) (see page 61)
7. Manual focus (see page 60)
8. Shutter speed and EXPOSURE (see page 57)
9. Zoom position (see page 45)
10. NITE PIX (see page 66)
11. DATE/TIME (see page 53)
12. USB
13. WL. REMOTE (SCD105 only)
14. WIND CUT (see page 52)
15. Audio recording mode (see page 51)
16. Zero memory indicator (SCD105 only) (see page 74)
17. Remaining Tape (measured in minutes)
18. Tape Counter
19. Operating mode
20. Record speed mode
21. PHOTO mode
22. Self recording and waiting timer (SCD105 only) (see page 20)
23. DIS (see page 47)
24. Volume control (see page 35)
25. Audio playback channel
26. DV IN(DV data transfer mode) (see page 78)
27. DEW (see page 7)
28. Message Line
29. PB DSE (see page 75)
30. PB ZOOM/ENTER (see page 76)
31. POWER NITE PIX (see page 67)
32. Tele MACRO (see page 45)

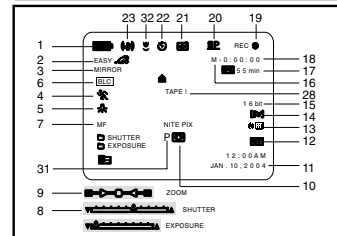
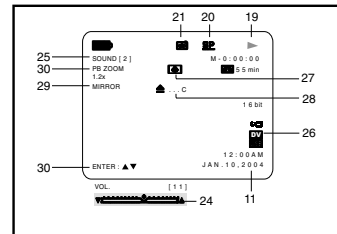
OSD in CAMERA mode***OSD in PLAYER mode***

Getting to Know Your Camcorder

OSD (On Screen Display in M.REC/M.PLAY modes)

- A. Folder number-file number (see page 84)
- B. Image counter
 - Current still image/Total number of recordable still images.
- C. CARD (MEMORY CARD) indicator
- D. Image recording and loading indicator
- E. Quality
- F. ERASE PROTECTION indicator (see page 93)
- G. Print Mark (see page 92)
- H. SLIDE SHOW
- I. MPEG4 SCREEN SIZE

Turning the OSD on/off (On Screen Display)

• Turning OSD on/off

Press the DISPLAY button on the left side panel.

- Each press of the button toggles the OSD function on and off.
- When you turn the OSD off,

In CAMERA mode: The STBY, REC, EASY.Q modes are always displayed on the OSD, even when the OSD is turned OFF and the key input is displayed for 3 seconds then turned off.

In PLAYER mode: When you press any Function button, the function is displayed on the OSD for 3 seconds before it turns off.

• Turning the DATE/TIME on/off

- The DATE/TIME is not affected when the OSD function is switched ON or OFF.
- To turn the DATE/TIME on or off, access the menu and change the DATE/TIME mode. (see page 53)
- You may also use the Quick Menu to turn the DATE/TIME ON or OFF. (see page 55) (only in CAMERA/M.REC mode)

OSD in M.REC mode

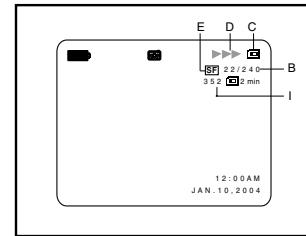

OSD in M.PLAY mode

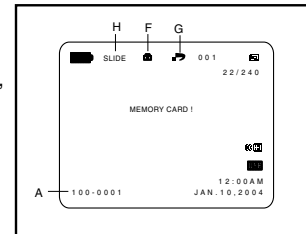

ENGLISH

Preparation

How to use the Remote Control (SCD105 only)

Battery Installation for the Remote Control

- ❖ You need to insert or replace the lithium battery when :
 - You purchase the camcorder.
 - The remote control doesn't work.
- ❖ Ensure that you insert the lithium battery correctly, following the + and - markings.
- ❖ Be careful not to reverse the polarity of the battery.

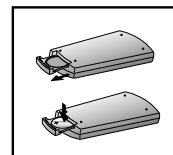

Self Record using the Remote Control

When you use the Self Timer function on the remote control, the recording begins automatically in 10 seconds.

1. Set the camcorder to CAMERA mode.
2. Press the SELF TIMER button until the appropriate indicator is displayed in the LCD.
3. Press the START/STOP button to start the timer.
 - Self Timer starts counting down from 10 with a beep sound.
 - In the last one second of the countdown, the beep sound gets faster, then recording starts automatically.
 - If you want to cancel the Self Timer function before recording, press the SELF TIMER button.
4. Press START/STOP again when you wish to stop recording.

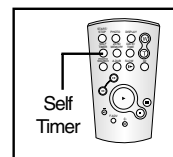

Preparation

Lithium Battery Installation

- ❖ The lithium battery maintains the clock function and preset contents of the memory; even if the battery pack or AC power adapter is removed.
- ❖ The lithium battery for the camcorder lasts about 6 months under normal operation from the time of installation.
- ❖ When the lithium battery becomes weak or dead, the date/time indicator will display "---" when you set the DATE/TIME to ON.
When this occurs, replace the lithium battery with CR2025 type.

1. Open the Jack Cover.
2. Take out the lithium battery holder from the lithium battery compartment.
3. Position the Lithium battery in the Lithium battery holder, with the positive (⊕) terminal face down.
4. Re-insert the Lithium battery holder into the lithium battery compartment until you can hear a "CLICK".

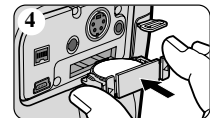
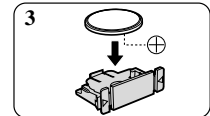
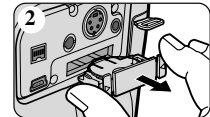

Note

The lithium battery must be inserted in the correct direction.

**Warning: Keep the LITHIUM BATTERY out of the reach of the children.
Should any battery be swallowed, consult a doctor immediately.**

ENGLISH**Preparation*****Adjusting the Hand Strap***

It is very important to ensure that the Hand strap has been correctly adjusted before you begin your recording.

The hand strap enables you to :

- Hold the camcorder in a stable, comfortable position.
- Press the Zoom and START/STOP button without having to change the position of your hand.

Hand strap

- a. Pull open the Hand Strap cover and release the Hand Strap.
- b. Adjust its length and stick it back onto the Hand Strap cover.
- c. Close the Hand Strap cover again.

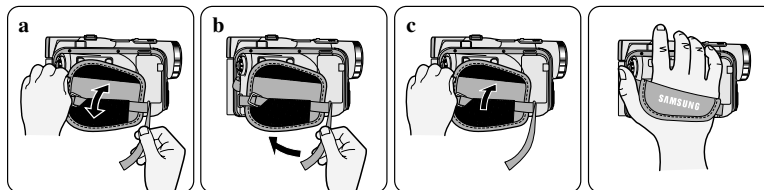
**Shoulder Strap**

The Shoulder Strap enables you to carry your camcorder around in complete safety.

1. Insert the end of strap into the Shoulder Strap hook on the camcorder.
Insert the other end of strap into ring inside hand strap.
2. Thread each end into the buckle, adjust the length of the strap and then pull it tight in the buckle.

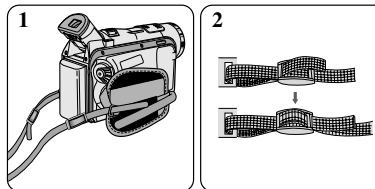
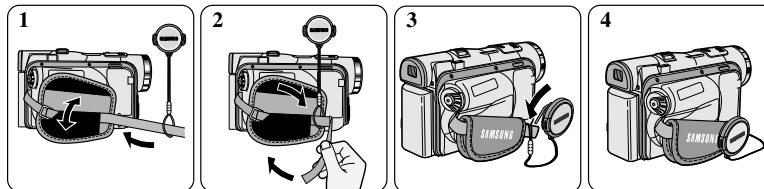
**Attaching the Lens Cover**

Preparation

Connecting a Power Source

There are two types of power source that can be connected to your camcorder.

- The AC Power Adapter and AC cord : used for indoor recording.
- The Battery Pack : used for outdoor recording.

To use the AC Power adapter and DC Cable

1. Connect the AC Power adapter to the AC cord.
2. Connect the AC cord to a wall socket.

Notes

- You must use the AC Power adapter of AA-E8 TYPE.
 - The plug and wall socket type may differ according to your resident country.
3. Connect the DC cable to the DC jack socket of the camcorder.
(When the battery is attached on the set, you should keep outside the projection of the DC cable.)
 4. Set the camcorder to each mode by holding down the tab on the power switch and turning it to the CAMERA or PLAYER mode.

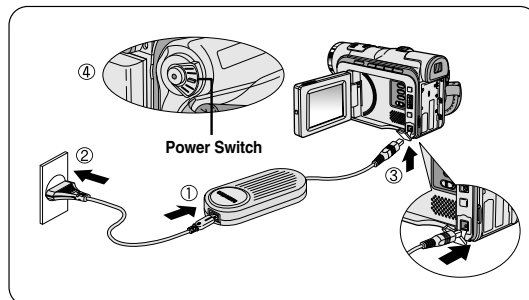

To select the CAMCORDER mode

- ❖ If you want to use this unit as a camcorder, set the mode switch to TAPE position.
- ❖ If you want to use this unit as a DSC (Digital Still Camera), set the mode switch to MEMORY CARD position.

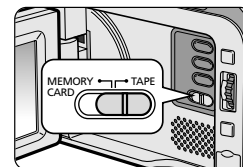

ENGLISH**Preparation****Using the Lithium Ion Battery Pack**

- ❖ The amount of continuous recording time available depends on
 - The type and capacity of the battery pack you are using.
 - How often the Zoom function is used.
 It is recommended that you have several batteries available.

Charging the Lithium Ion Battery Pack

1. Attach the battery pack to the camcorder.
2. Connect the AC Power adapter to an AC cord and connect the AC cord to a wall socket.
3. Connect the DC cable to the DC jack socket on the camcorder.
4. Turn the power switch to off, and the charging indicator will start to flash, showing that the battery is charging.

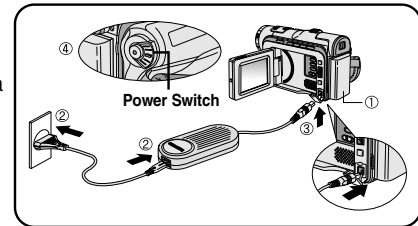

Blinking time	Charging rate
Once per second	Less than 50%
Twice per second	50% ~ 75%
Three times per second	75% ~ 90%
Blinking stops and stays on	90 ~ 100%
On for a second and off for a second	Error - Reset the battery pack and the DC cable

5. When the battery is fully charged, disconnect the battery pack and the AC Power adapter from the camcorder.
 - Even with the power switched off, the battery pack will still discharge if it is left connected to the camcorder.

Notes

- The battery pack may be charged a little at the time of purchase.
- To prevent reduction in the life and capacity of the battery pack, always remove it from the camcorder after it is fully charged.

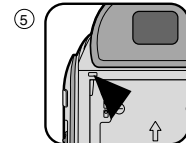

Preparation

Using the Lithium Ion Battery Pack

Table of continuous recording time based on model and battery type.

- ❖ If you close the LCD screen, it switches off and the viewfinder switches on automatically.
- ❖ The continuous recording time given in the table below are approximations.
Actual recording time depends on usage.

Battery	Time Charging time	Continuous recording time	
		LCD ON	VIEWFINDER ON
SB-LS110	Approx. 2hr	Approx. 1hr 30min	Approx. 2hr
SB-LS220	Approx. 3hr 30min	Approx. 3hr 10min	Approx. 4hr 10min

Notes

- The battery pack should be recharged in an environment of between 32°F (0°C) and 104°F (40°C).
- The battery pack should never be charged in a room temperature that is below 32°F (0°C).
- The life and capacity of the battery pack will be reduced if it is used in temperatures below 32°F (0°C) or left in temperatures above 104°F (40°C) for a long period, even when it is fully recharged.
- Do not put the battery pack near any heat sources (fire or flames, for example).
- Do not disassemble, process, press, or heat the Battery Pack.
- Do not allow the + and - terminals of the battery pack to be short-circuited.
It may cause leakage, heat generation, induce fire and overheating.

ENGLISH**Preparation****Battery level display**

- The battery level display indicates the amount of power remaining in the battery pack.

- Fully charged
- 20~40% used
- 40~80% used
- 80~95% used
- Completely used (flickers)
(The camcorder will turn off soon, change the battery as soon as possible)

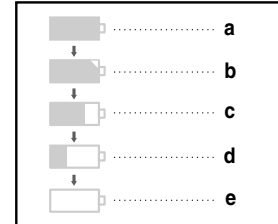

- ❖ Please refer to the table on page 25 for approximate continuous recording time.
- ❖ The recording time is affected by environmental temperature and conditions.
The recording time becomes very short in a cold environment.

The continuous recording time in the operating instructions are measured using a fully charged battery pack at 77°F(25°C). As the environmental temperature and conditions may differ when you actually use the camcorder, the remaining battery time may not be the same as the approximate continuous recording time given in these instructions.

Tips for Battery Identification

A charge mark is provided on the battery pack to help you remember whether it has been charged or not. Two colors are provided (red and grey)-you may choose which one indicates charged and which indicates discharged.

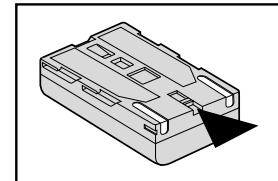
**Note**

- The charge mark setting does not affect the battery's charge status.

Preparation

Inserting and Ejecting a Cassette

- ❖ When inserting a tape or closing a cassette holder, do not apply excessive force. This may cause a malfunction.
 - ❖ Do not use any tapes other than Mini DV cassettes.
1. Connect a power source and slide the TAPE EJECT switch and open the cassette door.
 - The cassette holding mechanism rises automatically.
 2. Insert a tape into the cassette holder with the tape window facing outward and the protection tab bottom.
 3. Press the area marked PUSH on the cassette holding mechanism until it clicks into place.
 - The cassette is loaded automatically.
 4. Close the cassette door.
 - Close the door completely until you hear a "click".

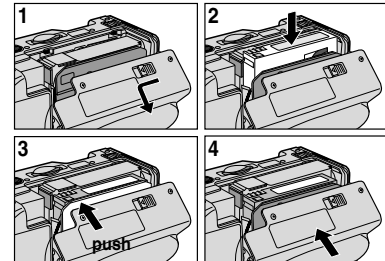

Note

When you have recorded something that you wish to keep, you can protect it so that it will not be accidentally erased.

a. Protecting a tape :

Push the safety tab on the cassette so that the hole is uncovered.

b. Removing the tape protection :

If you no longer wish to keep the recording on the cassette, push the safety tab back so that it covers the hole.

• How to store a tape

- a. Avoid places with magnets or magnetic interference.
- b. Avoid humidity and dust prone places.
- c. Keep the tape in an upright position and avoid storing it in direct sunlight.
- d. Avoid dropping or knocking your tapes.

a. SAVE



b. REC



ENGLISH**Basic Recording*****Making your First Recording***

1. Connect a Power source to the camcorder. (see page 23)
(A battery pack or a AC power adapter)
 - Insert a cassette. (see page 27)
2. Remove the LENS CAP.
3. Set the power switch to the CAMERA position.
 - Open the LCD monitor.
 - Set the mode switch to the TAPE position.
Make sure that STBY is displayed.
 - If the protection tab of the cassette is open, STOP and PROTECTION! will be displayed.
 - Make sure the image you want to record appears on the LCD monitor or viewfinder.
 - Make sure the battery level indicates that there is enough remaining power for your expected recording time.
4. To start recording, press the START/STOP button.
 - REC is displayed on the LCD.

To stop recording, press the START/STOP button again.

 - STBY is displayed on the LCD.

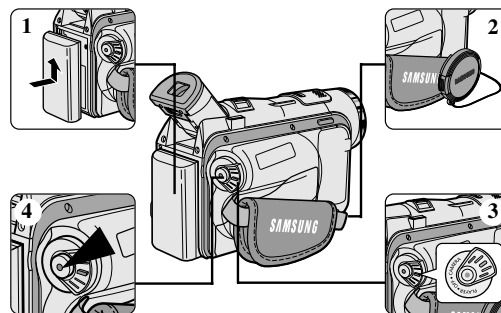

Basic Recording

Selecting OSD LANGUAGE

- ❖ Select the appropriate OSD Language among English, French, Spanish, Portuguese, German and Italian.
- ❖ The Language Function works in CAMERA, PLAYER, M.REC, M.PLAY modes.

1. Press the MENU button.
 - The menu list will appear.
2. Turn the MENU DIAL to highlight INITIAL and press the ENTER button.
3. Select LANGUAGE from the sub-menu and ENTER button.
4. Using the MENU DIAL, select the LANGUAGE and press the ENTER button.
 - Press the ENTER button to confirm the OSD LANGUAGE.
5. To exit, press the MENU button.
 - The OSD changes to the selected language.

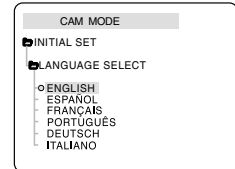
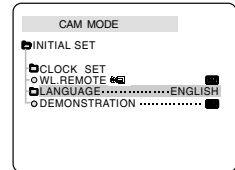
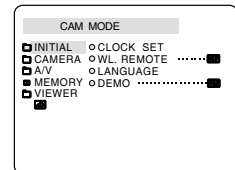

Notes

- OSD Language is initialized to the English when Lithium battery is exhausted or changed.
- "LANGUAGE" and "LANGUAGE SELECT" are always indicated in ENGLISH.

ENGLISH**Basic Recording**

When a cassette is loaded and the camcorder is left in the STBY mode for more than 5 minutes without being used, it will switch off automatically.

To use it again, push the START/STOP button or set the Power switch to OFF and then back to CAMERA.

This Auto Power off feature is designed to save battery power.

Record Search (REC SEARCH)

- ❖ You can view a recording using the REC SEARCH +, - function in STBY mode. REC SEARCH - enables you to play the recording backwards and REC SEARCH + enables you to play it forwards, for as long as you keep each button pressed down.
- ❖ If you press the REC SEARCH - button in STBY mode, your camcorder will play in reverse for 3 seconds and return to the original position automatically.

Note

Mosaic shaped distortion may appear on the screen while in Record Search mode.

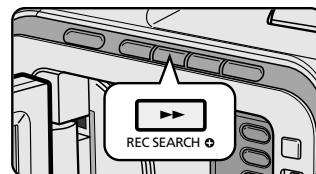
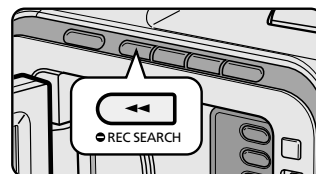

Basic Recording

Hints for Stable Image Recording

- While recording, it is very important to hold the camcorder correctly.
- Fix the LENS cap firmly by clipping it to the hand strap. (see page 22)

Recording with the LCD monitor

1. Hold the camcorder firmly using the hand strap.
2. Place your right elbow against your side.
3. Place your left hand under or beside the LCD to support and adjust it.
Do not touch the built-in microphone.
4. Choose a comfortable, stable position for the shots that you are taking.
You can lean against a wall or on a table for greater stability.
Do not forget to breathe gently.
5. Use the LCD frame as a guide to determine the horizontal plane.
6. Whenever possible, use a tripod.

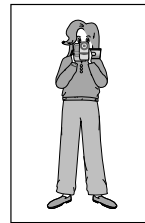

Recording with the Viewfinder

1. Hold the camcorder firmly using the hand strap.
2. Place your right elbow against your side.
3. Place your left hand under the camcorder to support it.
Be sure not to touch the built-in microphone.
4. Choose a comfortable, stable position for the shots that you are taking.
You can lean against a wall or on a table for greater stability.
5. Place your eye firmly against the viewfinder eyecup.
6. Use the viewfinder frame as a guide to determine the horizontal plane.
7. Whenever possible, use a tripod.



ENGLISH**Basic Recording*****Adjusting the LCD***

- ❖ Your camcorder is equipped with a 2.5 inch color Liquid Crystal Display(LCD) screen, which enables you to view what you are recording or playing back directly.
 - ❖ Depending on the conditions under where you are using the camcorder (indoors or outdoors for example), you can adjust ;
 - BRIGHT SELECT
 - BRIGHT ADJUST
 - COLOR ADJUST
1. Set the POWER switch to CAMERA position.
 - In the PLAYER mode, you may only setup the LCD while the tape is playing.
 2. Open the LCD screen, and the LCD switches on.
 3. Press the MENU button.
 4. Turn the MENU DIAL so that VIEWER is highlighted and then press the ENTER button.
 5. Turn the MENU DIAL so that LCD ADJUST is highlighted.
 6. Press the ENTER button to enter the sub-menu.
 7. Turn the MENU DIAL so that it highlights the menu item you want to adjust (BRIGHT SELECT, BRIGHT ADJUST, COLOR ADJUST).

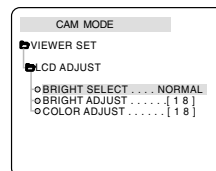
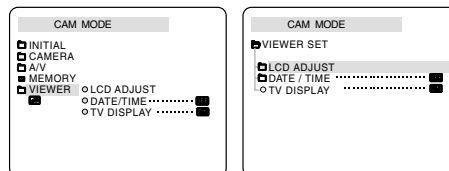
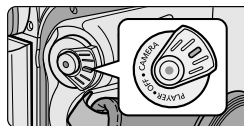

Basic Recording

8. Press the ENTER button again.
 - You may select NORMAL or SUPER in the BRIGHT SELECT feature and press the ENTER button to save the setting.
 - Use the MENU DIAL to adjust the value of BRIGHT ADJUST and COLOR ADJUST.
 - You can set values for BRIGHT ADJUST between 00 ~ 35 and COLOR ADJUST between 00 ~ 35.
9. Press the MENU button to finish the setting.

Using the VIEWFINDER

- ❖ In the PLAYER mode, the VIEWFINDER will work when the LCD is closed.
- ❖ In the CAMERA mode, the VIEWFINDER will work when the LCD is closed or rotated counterclockwise 180°.

Adjusting the Focus

Use the focus adjustment knob of the VIEWFINDER to focus the picture.
(refer to figure)

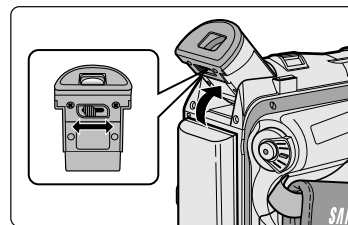

ENGLISH**Basic Recording*****Playing back a tape you have recorded on the LCD***

- ❖ You can monitor the playback picture on the LCD monitor.
- ❖ Make sure that the battery pack is in place.

1. Hold down the power switch tab and turn it to the PLAYER position.
2. Insert the tape you wish to view. (see page 27)
3. Open the LCD screen.
Adjust the angle of the LCD screen and set the brightness or color if necessary.
4. Press the ◀◀ (REW) button to rewind the tape to the starting point.
 - To stop rewinding, press the ■ (STOP) button.
 - The camcorder stops automatically after rewinding is complete.
5. Press the ▶▶ (PLAY/STILL) button to start playback.
 - You can view the picture you recorded on the LCD.
 - To stop the PLAY operation, press the ■ (STOP) button.

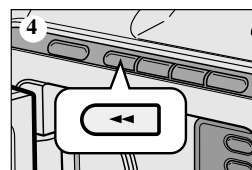
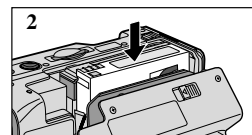
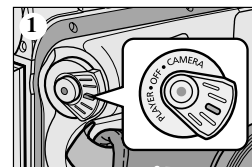
**Notes**

- You can also view the picture on a TV screen, after connecting the camcorder to a TV or VCR. (see page 70)
- Various functions are available in PLAYER mode. (see page 72)

Basic Recording

Adjusting the LCD during PLAY

- ❖ You can adjust the LCD during playback.
- ❖ The adjustment method is the same procedure as used in CAMERA mode. (see page 32)

Controlling Sound from the Speaker

The Speaker works in PLAYER mode only.

- When you use the LCD screen for playback, you can hear recorded sound from the built-in Speaker.
 - Follow the instructions below to decrease or mute speaker volume in the PLAYER mode.
 - Take the following steps to lower the volume or mute the sound while playing a tape on the camcorder.
1. Set the power switch to PLAYER mode.
 2. Press ►/II (PLAY/STILL) to play the tape.
 3. When you hear sounds once the tape is in play, use the MENU DIAL to adjust the volume.
 - A volume level display will appear on the LCD.
 - Levels may be adjusted from anywhere between 00 to 19 and you will not hear any sound when the volume is set on 00.
 - If you close the LCD while playing, you will not hear sound from the speaker.

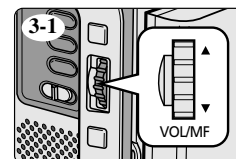
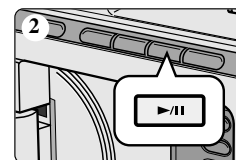

<3-2>

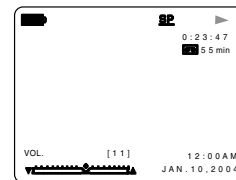

Notes

- When the cable is connected to the Audio/Video jack, you cannot hear sound from the speaker and cannot adjust the volume.
- You can hear sound from speaker by removing the connected cable from the Audio/Video jack.

ENGLISH

Advanced Recording

Use of various Functions

● Setting menu items

MENU	SUB MENU	FUNCTIONS	Available mode				Page
			CAMERA	PLAYER	M-REC	M-PLAY	
INITIAL	CLOCK SET	Setting the time	✓	✓	✓	✓	39
	WL. REMOTE (☆)	Using the Remote Control	✓	✓	✓	✓	40
	LANGUAGE SELECT	Selecting the OSD language	✓	✓	✓	✓	29
	DEMO	Demonstration	✓				41
CAMERA	PROGRAM AE	Selecting the PROGRAM AE Function	✓				42
	WHT. BALANCE	Setting White Balance	✓		✓		44
	D. ZOOM	Selecting Digital Zoom	✓				46
	DIS	Selecting the Digital Image Stabilizing	✓				47
	DSE SELECT	Setting the Digital special effect	✓				48
AV	REC MODE	Selecting the recording speed	✓				50
	PHOTO SEARCH	Searching pictures recorded in TAPE		✓			65
	PHOTO COPY	Copying pictures from TAPE onto the Memory Card		✓			91
	AUDIO MODE	Selecting Sound Quality for recording	✓				51
	AUDIO SELECT	Selecting the Audio playback channel		✓			64
	WIND CUT	Minimizing wind noise	✓	✓			52
	PB DSE	Selecting Digital Special Effect during the playback		✓			75

(☆) : This Function works on model SCD105 only.

Advanced Recording

MENU	SUB MENU	FUNCTIONS	Available mode				Page
			CAMERA	PLAYER	M. REC	M. PLAY	
MEMORY	M. PLAY SELECT	Selecting Storage Media (MPEG4, PHOTO) to playback				✓	98
	PHOTO QUALITY	Selecting Image Quality		✓	✓		86
	MPEG4 SIZE	Selecting Image Resolution			✓		97
	PRINT MARK	Print images recorded on a Memory Card				✓	92
	PROTECT	Preventing Accidental Erasure				✓	93
	FILE NO.	File Naming Options		✓	✓	✓	85
	DELETE	Deleting Files				✓	94
	FORMAT	Formatting the Memory Card				✓	95
VIEWER	LCD ADJUST	Setting the Brightness and colour Tones of the LCD	✓	✓	✓	✓	32
	DATE/TIME	Setting the Date and Time	✓	✓	✓	✓	53
	TV DISPLAY	Selecting OSD on/off of TV	✓	✓	✓	✓	54

(☆) : This Function works on model SCD105 only.

● Set the camcorder to CAMERA or PLAYER mode and M.REC or M.PLAY mode

1. Press the MENU button.
The MENU OSD is displayed. The cursor (**HIGHLIGHT**) indicates the feature you are currently adjusting.
2. Use the MENU DIAL and press the ENTER button on the left side panel to select and activate the item.
3. You can exit the menu mode by pressing the MENU button.

ENGLISH**Advanced Recording****● Availability of functions in each mode**

Operating Mode \ Requested Mode	Digital functions				Digital special effects	NITE PIX
	DIS	D.ZOOM	PHOTO (TAPE)	SLOW SHUTTER		
DIS		○	○	△	○	○
D.ZOOM	○		○	* △	○	○
PHOTO	×	×		×	×	○
SLOW SHUTTER	△	×	○		○	○
Digital Special Effects	○	○	○	○		△
NITE PIX	○	○	○	○	×	

○ : The requested mode will work in this operating mode.

× : You can not change the requested mode.

△ : The operating mode will be released and the requested mode will work.

* : The operating mode will be released and the requested mode will work.
(operating mode data will be backed up)

Notes

- When a menu item on the LCD is marked with an , that item cannot be activated.
- When you select an item that cannot be changed, an error message will be displayed.

Advanced Recording

● CLOCK SET

- ❖ CLOCK setup works in CAMERA, PLAYER, M.REC and M.PLAY modes.
- ❖ The DATE/TIME is automatically recorded onto a tape.
Before recording, please set the DATE/TIME.

1. Press the MENU button.
 - The menu list will appear.
2. Turn the MENU DIAL to highlight INITIAL and press the ENTER button.
3. Use the MENU DIAL to select CLOCK SET from the submenu.
4. Press the ENTER button to enter SETTING mode.
 - A blinking item indicates the item to be changed. The year will blink first.
5. Using the MENU DIAL, change the year setting.
6. Press the ENTER button.
 - The month will blink.
7. Using the MENU DIAL, change the month setting.
8. Press the ENTER button.
 - The day will blink.
9. You can set the day, hour and minute following the same procedure for setting the year and month.
10. Press the ENTER button after setting the minutes.
 - The word COMPLETE! will appear, and a few seconds later, the menu screen will automatically return to the sub menu.
11. To exit, press the MENU button.

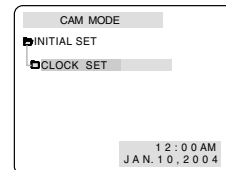
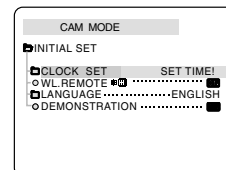
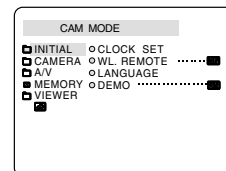

ENGLISH**Advanced Recording****● WL. REMOTE (SCD105 only)**

- ❖ The WL. REMOTE function works in CAMERA, PLAYER, M.REC, M.PLAY modes.
- ❖ The WL. REMOTE option allows you to enable or disable the remote control for use with the camcorder.

1. Press the MENU button.
 - The menu list will appear.
2. Turn the MENU DIAL to highlight INITIAL and press the ENTER button.
3. Use the MENU DIAL to select WL.REMOTE from the submenu.
4. Press the ENTER button to enable or disable the remote control.

The setting switches between ON/OFF each time you press the ENTER button.
5. To exit, press the MENU button.
 - If you set the remote to OFF in the menu and try to use it, the remote control icon will blink for 3 seconds and disappear on the LCD.

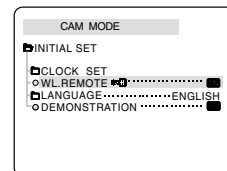
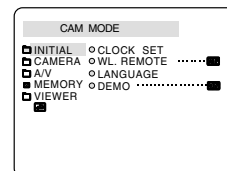

Advanced Recording

● DEMONSTRATION

- ❖ Demonstration automatically shows you the major functions that are included with your camcorder so that you may use them more easily.
- ❖ The DEMONSTRATION function may only be used in the CAMERA mode without a tape inserted in the camcorder.
- ❖ The demonstration operates repeatedly until the DEMONSTRATION mode switched OFF.

1. Set the camcorder to CAMERA mode.
2. Press the MENU button.
 - The menu list will appear.
3. Turn the MENU DIAL to highlight INITIAL and press the ENTER button.
4. Select DEMONSTRATION from the submenu and press the ENTER button.
5. To activate the DEMONSTRATION, set DEMONSTRATION ON.
 - Press the MENU button to quit the menu.
 - The demonstration will begin.
6. To end the DEMONSTRATION, set the DEMONSTRATION to OFF.

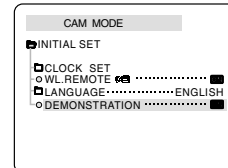
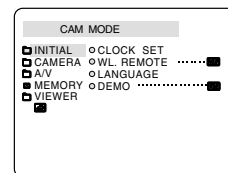

Notes

- The DEMONSTRATION function only works without a TAPE inserted.
- The DEMONSTRATION mode is automatically activated when the camcorder is left idle for more than 10 minutes after switching to the CAMERA mode (no tape is inserted in the camcorder).
- If you press other buttons (FADE, BLC, PHOTO, EASY) during the DEMONSTRATION mode, the DEMONSTRATION stops temporarily and resumes 10 minutes later if you do not operate any other functions.
- While setting the NITE PIX to ON, the DEMONSTRATION function does not work.

ENGLISH

Advanced Recording

● PROGRAM AE

- ❖ The PROGRAM AE function works in CAMERA mode only.
- ❖ The PROGRAM AE mode allows you to adjust shutter speeds and apertures to suit different recording conditions.
- ❖ They give you creative control over the depth of field.

■ AUTO mode

- Auto balance between the subject and the background.
- To be used in normal conditions.
- The shutter speed automatically varies from 1/60 to 1/250 per second, depending on the scene.

■ SPORTS mode (🏆)

- For recording people or objects moving quickly.

■ PORTRAIT mode (👤)

- For focusing on the background of the subject, when the background is out of focus.
- The PORTRAIT mode is most effective when used outdoors.
- The shutter speed automatically varies from 1/60 to 1/1000 per second.

■ SPOTLIGHT mode (🎤)

- For recording correctly when there is only light on the subject and not the rest of the picture.

■ SAND/SNOW mode (🏖️)

- For recording when people or objects are darker than the background because of reflected light from sand or snow.

■ High S. SPEED(High Shutter Speed) mode (🏏)

- For recording fast-moving subjects such as players in golf or tennis games.

Advanced Recording

Setting the PROGRAM AE

- Press the MENU button.
 - The menu list will appear.
- Turn the MENU DIAL to highlight CAMERA and press the ENTER button.
- Select PROGRAM AE from the submenu.
- Press the ENTER button to enter the submenu.
- Using the MENU DIAL, select the PROGRAM AE mode.
 - Press the ENTER button to confirm the PROGRAM AE mode.
- To exit, press the MENU button.

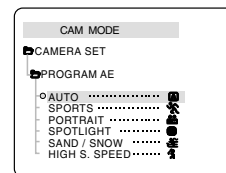
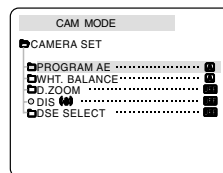
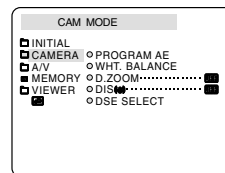

Notes

- While setting the NITE PIX to ON, the PROGRAM AE function does not work.
- The PROGRAM AE function will not operate in EASY mode.

ENGLISH**Advanced Recording****● WHT. BALANCE (WHITE BALANCE)**

- ❖ The WHITE BALANCE function works in CAMERA or M.REC mode only.
 - ❖ The WHITE BALANCE is a recording function that preserves the unique image color of the object in any recording condition.
 - ❖ You may select the appropriate WHITE BALANCE mode to obtain good quality color of the image.
 - AUTO (☺): This mode is generally used to control the WHITE BALANCE automatically.
 - HOLD (☼): This fixes the current WHITE BALANCE value.
 - INDOOR (☼): This controls the WHITE BALANCE according to the indoor ambience.
 - Under halogen or studio/video lighting
 - Subject is of one dominant color
 - Close up
 - OUTDOOR (☼): This controls the WHITE BALANCE according to the outdoor ambience.
 - In daylight, especially for close up and where the subject is of one dominant color.
1. Set the camcorder to CAMERA mode.
 2. Press the MENU button.
 - The menu list will appear.
 3. Turn the MENU DIAL to highlight CAMERA and press the ENTER button.
 4. Select WHT.BALANCE from the submenu.
 5. Press the ENTER button to enter the sub-menu.
 6. Using the MENU DIAL, select the WHITE BALANCE mode.
 - Press the ENTER button to confirm the WHITE BALANCE mode.
 7. To exit, press the MENU button.

Notes

- When NITE PIX is set to ON, the WHT.BALANCE function does not work.
- The WHT.BALANCE function will not operate in EASY mode.
- Turn the digital zoom off (if necessary) to set a more accurate white balance.
- Reset the white balance if lighting conditions change.
- During normal outdoor recording, setting to AUTO may provide better results.

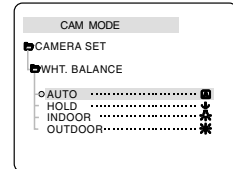
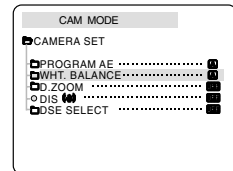
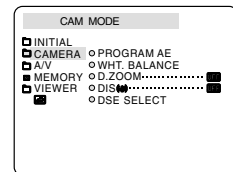

Advanced Recording

Zooming In and Out

- ❖ Zooming is a recording technique that lets you change the size of the subject in a scene.
For more professional looking recordings, do not use the zoom function too often.
 - ❖ You can zoom using variable zoom speeds.
 - ❖ Use these features for different shots. Please note that over-use of the zoom feature can lead to unprofessional looking results and a reduction of battery usage time.
1. Move the zoom lever slightly for a gradual zoom, move it further for a high-speed zoom.
Your zooming is monitored on the OSD.
 2. T(Telephoto) side: Subject appears closer.
 3. W(Wide angle) side: Subject appears farther away.
 - You can record a subject that is about 10mm (about 0.5 inch) away from the lens surface in the WIDE position.

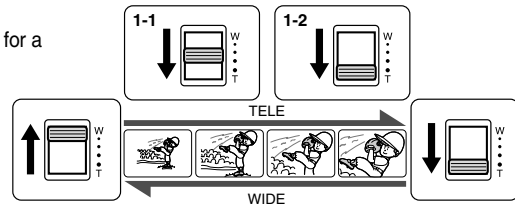

Tele MACRO

- ❖ Tele Macro Function works in both CAMERA and M.REC mode.
 - ❖ Effective focal distance in TELE MACRO mode is 50 Cm (19.7 inches) ~ 100 Cm (39.4 inches).
1. Press the MACRO button.
MACRO Icon () will be displayed.
 2. If you want to cancel the Tele Macro function, press the MACRO button again.

Notes

- When recording in TELE MACRO Mode, the FOCUS speed may be slow.
- When you operate the ZOOM function in the TELE MACRO mode, then the recording subject maybe out of focus.
- Use a tripod to prevent hand shake in the TELE MACRO mode.
- Avoid shadows when recording in the TELE MACRO mode.
- As the distance to the subject decreases, focusing area narrows.
- When you can not get proper focus, use the Zoom Lever.

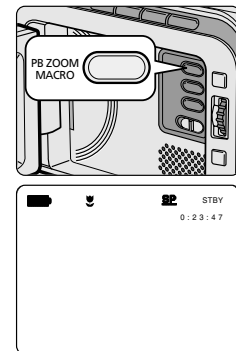

ENGLISH**Advanced Recording****Zooming In and Out with DIGITAL ZOOM**

- ❖ Zoom works in CAMERA mode only.

Digital Zoom

- ❖ Zooming more than 18x is achieved digitally.
- ❖ The picture quality may deteriorate depending on how much you zoom in on the subject.
- ❖ We recommend that you use the DIS feature with DIGITAL ZOOM for picture stability. (see page 47)

1. Set the camcorder to CAMERA mode.
2. Press the MENU button.
 - The menu list will appear.
3. Turn the MENU DIAL to CAMERA and press the ENTER button.
4. Select D.ZOOM from the submenu.
5. Press the ENTER button to setup the 100x, 200x, 400x, 900x digital zoom function or to turn the feature OFF.
6. To exit, press the MENU button.

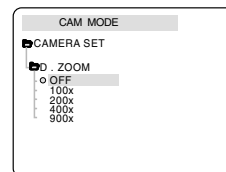
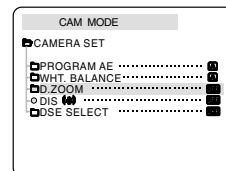
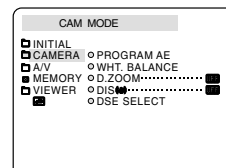

Advanced Recording

● DIS (Digital Image Stabilizer)

- ❖ The DIS function works in CAMERA mode only.
- ❖ DIS (Digital Image Stabilizer) is a function that compensates for any shaking or hand movement while holding the camcorder (within reasonable limits).
- ❖ It provides more stable pictures when:
 - Recording with the zoom
 - Recording a small object close-up
 - Recording and walking at the same time
 - Recording through the window of a vehicle

1. Set the camcorder to CAMERA mode.
2. Press the MENU button.
 - The menu list will appear.
3. Turn the MENU DIAL highlight to CAMERA and press the ENTER button.
 - The sub menu list will appear.
4. Turn the MENU DIAL to activate the DIS function, press the ENTER button.
 - The DIS menu is changed to ON.
 - If you do not want to use the DIS function, set the DIS menu to OFF.
5. To exit, press the MENU button.

Notes

- It is recommended that you deactivate the DIS function when using a tripod.
- If you use the DIS function, the picture quality may deteriorate.

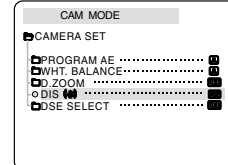
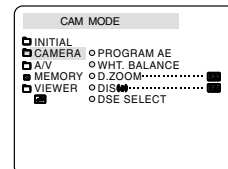

ENGLISH**Advanced Recording****● DSE(Digital Special Effects) SELECT**

- ❖ The DSE function works in CAMERA mode only.
- ❖ The digital effects enable you to give a creative look to your recording by adding various special effects.
- ❖ Select the appropriate digital effect for the type of picture that you wish to record and the effect you wish to create.
- ❖ There are 9 DSE modes.

- a. ART mode
This mode gives the images a coarse effect.
- b. MOSAIC mode
This mode gives the images a mosaic effect.
- c. SEPIA mode
This mode gives the images a reddish-brown pigment.
- d. NEGA mode
This mode reverses the colors, creating a negative image.
- e. MIRROR mode
This mode cuts the picture in half, using a mirror effect.
- f. BLK & WHT mode
This mode changes the images to black and white.
- g. EMBOSS mode
This mode creates a 3D effect (embossing).
- h. CINEMA mode
This mode covers the upper/lower portions of the screen to give a cinematic effect.
- i. MAKE - UP mode
This mode allows the images to be selected in red, green, blue or yellow.

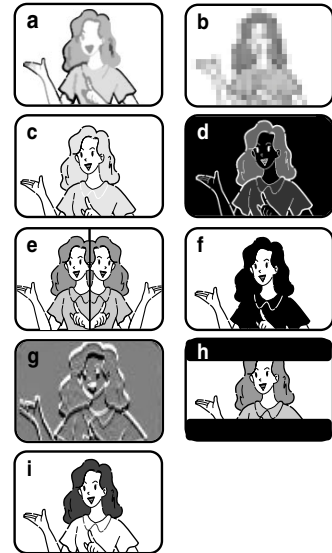

Advanced Recording

Selecting an effect

1. Set the camcorder to CAMERA mode.
2. Press the MENU button.
 - The menu list will appear.
3. Turn the MENU DIAL to highlight CAMERA and press the ENTER button.
4. Select DSE SELECT from the submenu.
5. Press the ENTER button to enter the submenu.
6. Using MENU DIAL, select the DSE mode.
 - Press the ENTER button to confirm the DSE mode.
7. To exit, press the MENU button.

Notes

- While setting the NITE PIX to ON, the DSE function does not work.
- The DSE function will not operate in EASY mode.

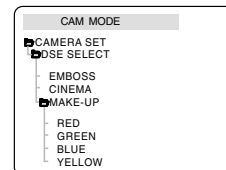
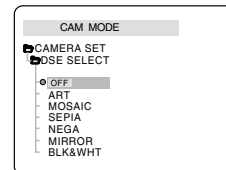
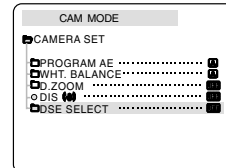
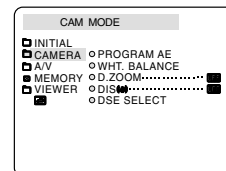

ENGLISH**Advanced Recording****● REC MODE**

- ❖ The REC MODE function works in CAMERA mode.
- ❖ This camcorder records and plays back in SP (standard play) mode and in LP (long play) mode.
 - SP (standard play): This mode permits 60 minutes of recording time with a DVM60 tape.
 - LP (long play): This mode permits 90 minutes of recording time with a DVM60 tape.

1. Set the camcorder to CAMERA mode.
2. Press the MENU button.
 - The menu list will appear.
3. Turn the MENU DIAL to highlight A/V and press the ENTER button.
4. Select REC MODE from the submenu and press the ENTER button.
 - The REC MODE toggles between SP and LP with each press.
5. To exit, press the MENU button.

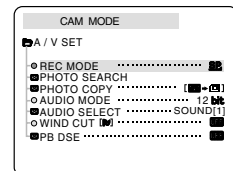
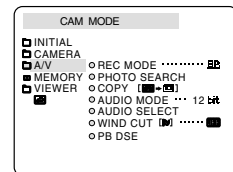
**Notes**

- We recommend that you use this camcorder to play back any tapes recorded on this camcorder. Playing back a tape recorded in other equipment may produce mosaic shaped distortion.
- When you record a tape in SP and LP modes, or LP mode only, the playback picture may be distorted or the time code may not be written properly between scenes.
- Record using SP mode for best picture and sound quality.

Advanced Recording

● AUDIO MODE

- ❖ The AUDIO MODE function works in CAMERA mode.
- ❖ This camcorder records sound in two ways. (12bit, 16bit)
 - 12bit : You can record two 12bit stereo sound tracks.
The original stereo sound can be recorded onto the MAIN (SOUND1) track.
Additional stereo sound can be dubbed onto the SUB (SOUND2) track.
 - 16bit : You can record one high quality stereo sound using the 16bit recording mode.
Audio dubbing is not possible when using this mode.

1. Set the camcorder to CAMERA mode.
2. Press the MENU button.
 - The menu list will appear.
3. Turn the MENU DIAL to highlight A/V and press the ENTER button.
4. Select the AUDIO MODE from the menu and press the ENTER button.
 - The AUDIO MODE toggles between 12bit-16bit with each push.
5. To exit, press the MENU button.

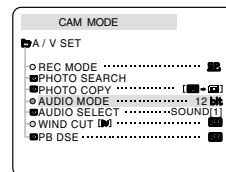
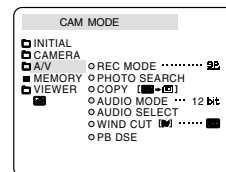

ENGLISH**Advanced Recording****● WIND CUT**

- ❖ The WIND CUT function works in CAMERA and PLAYER modes.
- ❖ The WIND CUT function minimizes wind noise or other noise while recording.
 - When the wind cut is on, some low sounds are eliminated along with the sound of the wind.

1. Set the camcorder to CAMERA mode.
2. Press the MENU button.
 - The menu list will appear.
3. Turn the MENU DIAL to highlight A/V and press the ENTER button.
4. Select WIND CUT from submenu.
5. This feature toggles ON/OFF each time you press the ENTER button.
 - **[W]** is shown in the display when you turn the WIND CUT on.
6. To exit, press the MENU button.

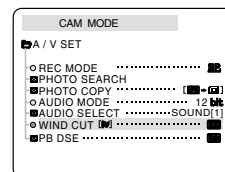
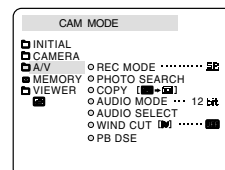
**Notes**

- Make sure WIND CUT is set to off when you want the microphone to be as sensitive as possible.
- Use the WIND CUT when recording in windy places such as the beach or near buildings.

Advanced Recording

● DATE/TIME

- ❖ The DATE/TIME function works in CAMERA, PLAYER, M.REC and M.PLAY modes.
 - ❖ The date and time are automatically recorded on a special data area of the tape.
1. Press the MENU button.
 - The menu list will appear.
 2. Turn the MENU DIAL to highlight VIEWER and press the ENTER button.
 3. Turn the MENU DIAL to highlight DATE/TIME.
 4. Press the ENTER button to select the sub-menu.
 5. Using the MENU DIAL, select the DATE/TIME mode.
 - You can choose to display - the OFF, DATE, TIME, DATE/TIME
 - OFF only
 - DATE only
 - TIME only
 - DATE & TIME
 - To return to the previous menu, highlight the DATE/TIME in the middle of OSD and press the ENTER button.
 6. To exit, press the MENU button.

Notes

- The DATE/TIME is not affected by the OSD ON/OFF (DISPLAY) button.
- The DATE/TIME will read "- -" in the following conditions.
 - During playback of a blank section of a tape.
 - If the tape was recorded before setting the DATE/TIME in the Camera's memory.
 - When the lithium battery becomes weak or dead.
- Before you use the DATE/TIME function, you must set the Clock. See CLOCK SET on page 39.

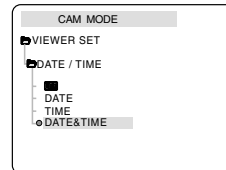
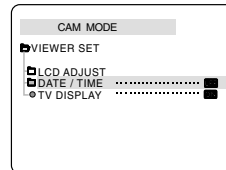
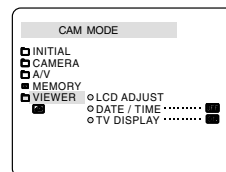

ENGLISH**Advanced Recording****● TV DISPLAY**

- ❖ The TV DISPLAY function works in CAMERA, PLAYER, M.REC and M.PLAY modes.
 - ❖ You can select the output path of the OSD (On Screen Display).
 - OFF: The OSD appears in the LCD screen only.
 - ON: The OSD appears in the LCD screen, View Finder and TV.
 - Use the DISPLAY button located at the left side of the camcorder to turn the OSD ON/OFF displayed on the LCD/View Finder/TV.
1. Set the camcorder to CAMERA, PLAYER, M.REC and M.PLAY mode.
 2. Press the MENU button.
 - The menu list will appear.
 3. Turn the MENU DIAL to highlight VIEWER and press the ENTER button.
 4. Select TV DISPLAY and press the ENTER button.
 - The DISPLAY mode switches between ON/OFF with each push.
 5. To exit, press the MENU button.

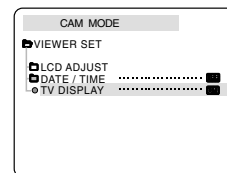
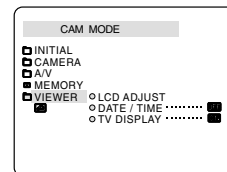

Advanced Recording

Using Quick Menu(Navigation Menu)

- ❖ Quick menu is available only in CAMERA and M.REC mode.
 - ❖ Quick menu is used to adjust camera functions by using the MENU DIAL.
This feature is useful for when you want to make simple adjustments without having to access the menus and submenus.
- **DATE/TIME (see page 53)**
 - Each time you select DATE/TIME and press the ENTER button, it will be displayed in the order of DATE - TIME - DATE/TIME - OFF.
 - **WL.REMOTE (📺) (SCD105 only)**
 - Each time you select WL.REMOTE and press the ENTER button, the WL.REMOTE is switched to either enabled (📺) or disabled (OFF) .
 - **DIS (🔒)**
 - Each time you select DIS and press the ENTER button, the DIS icon is displayed or set to OFF.
 - **DSE (Digital Special Effect) (see page 48)**
 - Each time you select DSE and press the ENTER button, the DSE preset values are applied or set to OFF.
DSE values will not switch between On and Off if they have not been preset in the menu.
 - **PROGRAM AE (see page 42)**
 - Each time you select PROGRAM AE and press the ENTER button, you can choose between the preset PROGRAM AE values and AUTO. You can't choose between Auto and the PROGRAM AE values if the values have not been preset in the regular menu.

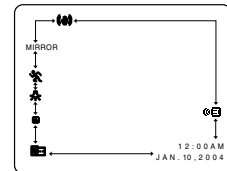

ENGLISH**Advanced Recording****■ WHT. BALANCE (see page 44)**

- Each time you select WHT. BALANCE and press the ENTER button, you can choose between preset WHT.BALANCE values and AUTO. As in PROGRAM AE, you can't choose between Auto and WHT.BALANCE values if they have not been preset.

■ FOCUS (Auto Focus/Manual Focus) (see page 60)

- Each time you select FOCUS and press the ENTER button, the FOCUS is switched to either Manual Focus (MF) or Auto Focus (**A**).

■ SHUTTER SPEED & EXPOSURE

- You can set values for SHUTTER SPEED and EXPOSURE by selecting (**☐**) icon and pressing the ENTER button. For more information, see the next page.

Setting the Quick menu

1. Set the camcorder to CAMERA mode.
2. Turn the MENU DIAL to select a function you want and then press the ENTER button to change the values.

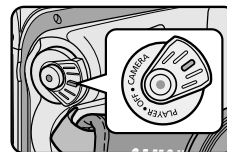

**Notes**

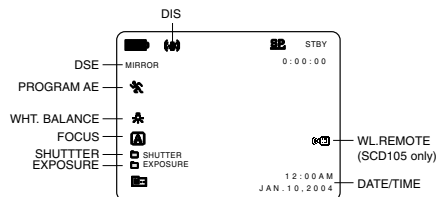
- Quick menu function will not operate in EASY mode.
- If you are using the M.FOCUS(MF) function, you cannot use the Quick menu. If you want to use the Quick menu function, release the M.FOCUS(MF) mode.



Advanced Recording

SHUTTER SPEED & EXPOSURE

- ❖ You can set SHUTTER SPEED only in CAMERA mode.
 - ❖ The EXPOSURE function works in both CAMERA and M.REC modes.
 - ❖ SHUTTER SPEED and EXPOSURE values can only be set in the Quick Menu.
 - ❖ SHUTTER SPEED and EXPOSURE are automatically switched and/or deactivated.
1. Set the power switch to CAMERA mode.
 2. Turn the MENU DIAL until you see the () icon, and then press the ENTER button.
 - You see a screen on which you can select SHUTTER SPEED and EXPOSURE.
 - Turn the MENU DIAL to select the item you want and then press the ENTER button.
 - SHUTTER SPEED can be set to 1/60, 1/100, 1/250, 1/500, 1/1000, 1/2000, 1/4000 or 1/10000.
 - EXPOSURE can be set between 00 and 29.
 3. To exit from the setting screen, select the icon () and press the ENTER button.

Recommended Shutter speeds when recording

- ❖ Outdoor sports such as golf or tennis : 1/2000 or 1/4000.
- ❖ Moving cars or trains or other rapidly moving vehicles such as roller coasters : 1/1000, 1/500 or 1/250
- ❖ Indoor sports such as basketball : 1/100

Notes

- If you want to use the selected shutter speed and exposure value, you should begin the recording with the shutter speed and the exposure adjustment screens displayed on the LCD.
- If you manually change the shutter speed and the exposure value when Auto-exposure option is selected, manual changes are applied first.
- The image may not seem as smooth when a high shutter speed is set.
- The camcorder returns to the auto shutter setting and auto exposure setting when you set the NITE PIX to ON, or change to the EASY, SLOW SHUTTER modes.
- When recording with a SHUTTER SPEED of 1/1000 or higher, make sure the sun is not shining into the lens.

ENGLISH

Advanced Recording

SLOW SHUTTER (Low Shutter Speed)

- ❖ The SLOW SHUTTER function works in CAMERA mode only.
- ❖ The shutter speed can be controlled, allowing you to record slow moving objects.

1. Set the power switch to CAMERA mode.
2. Press the SLOW SHUTTER button.
3. Each time you press the SLOW SHUTTER button, SHUTTER SPEED is changed to 1/30, 1/15, 1/8, off.
4. To exit, press the SLOW SHUTTER button.

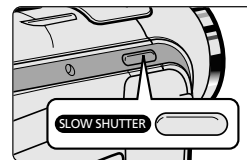
**Notes**

- When using "SLOW SHUTTER" the image takes on a slow motion like effect.
- The SLOW SHUTTER function will not operate in EASY mode.

Advanced Recording

EASY Mode (for Beginners)

- ❖ The EASY mode allows a beginner to easily make good recordings.
 - The EASY mode only operates in CAMERA mode.
1. Set the power switch to CAMERA mode.
 2. By pressing the EASY button, all functions on the camera will be set to off and the recording settings will be set to the following basic modes:
 - Battery level, recording mode, counter, DATE/TIME, and DIS (🔋) will be displayed.
 - The word "EASY.Q" will appear on the LCD at the same time.
However, the DATE/TIME will only be seen if it has been previously set. (see page 53)
 3. Press START/STOP to start recording.
 - Recording will begin using the basic automatic settings.
 4. Press the EASY button again in the STBY mode and then turn the EASY mode off.
 - The EASY function will not turn off while you are recording.
 - The camera will return to the settings that were set prior to activating EASY mode.

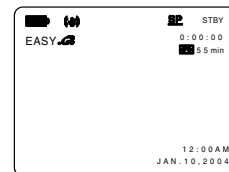
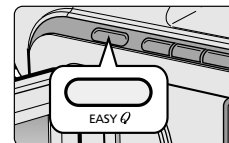

Notes

- In EASY mode, certain functions are not available, such as MENU, BLC, AF/MF.
 - If you want to use these functions, you must first switch the EASY mode off.
- The EASY mode settings are deleted when the battery pack is uninstalled from the camcorder and therefore, they must be reset when a battery pack has been replaced.

ENGLISH**Advanced Recording****AF/MF (Auto Focus/Manual Focus)**

- ❖ The AF/MF function works in CAMERA, M.REC mode only.
- ❖ In most situations, it is better to use the automatic focus feature, as it enables you to concentrate on the creative side of your recording.
- ❖ Manual focusing may be necessary under certain conditions that make automatic focusing difficult and/or unreliable.

Auto Focusing

- ❖ If you are inexperienced in the use of camcorders, we recommend that you make use of Auto Focus.

Manual Focusing

- ❖ In the following situations, you may obtain better results by adjusting the focus manually.
 - a. A picture containing several objects, some close to the camcorder, others further away.
 - b. A person enveloped in fog or surrounded by snow.
 - c. Very shiny or glossy surfaces like a car.
 - d. People or objects moving constantly or quickly like an athlete or a crowd.
1. Set the power switch to CAMERA mode.
 2. Turn the MENU DIAL up or down until the FOCUS is highlighted and then press the ENTER button.
 - M. FOCUS(MF) will display.
 3. Turn the MENU DIAL up or down until the object is in focus.
 - Zoom out a little if focusing is difficult.
 4. To return to AF (Auto Focus: **A**), press the ENTER button again.

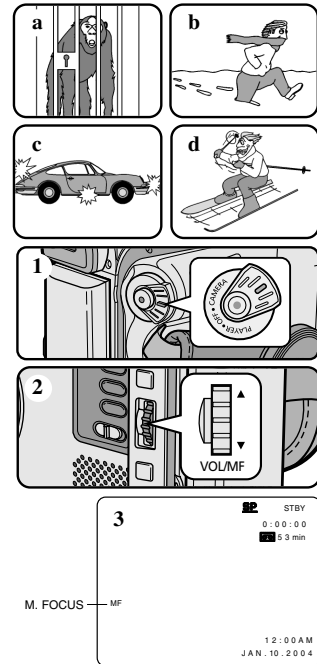

Advanced Recording

BLC (Back Light Compensation)

- ❖ BLC works in CAMERA/M.REC mode.
- ❖ Back lighting exists when the subject is darker than the background:
 - The subject is in front of a window.
 - The person to be recorded is wearing white or shiny clothes and is placed against a bright background; the person's face is too dark to distinguish his/her features.
 - The subject is outdoors and the background is overcast.
 - The light sources are too bright.
 - The subject is against a snowy background.

* BLC off

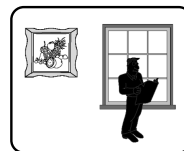

* BLC on

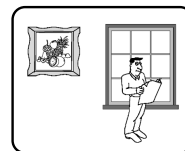

1. Set the power switch to CAMERA mode.
2. Press the BLC button.
 - Normal - BLC - Normal
 - BLC enhances the subject.

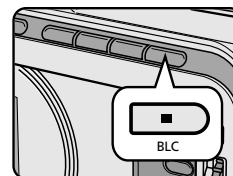

Notes

- When NITE PIX is set to ON, the BLC function does not work.
- The BLC function will not operate in EASY mode.

ENGLISH**Advanced Recording****Fade In and Out**

- ❖ The FADE function works in CAMERA mode only.
- ❖ You can give your recording a professional look by using special effects such as fade in at the beginning of a sequence or fade out at the end of a sequence.

To Start Recording

- Before recording, hold down the FADE button.
The picture and sound gradually disappear (fade out).
- Press the START/STOP button and at the same time release the FADE button.
Recording starts and the picture and sound gradually appear (fade in).

To Stop Recording (use FADE IN / FADE OUT)

- When you wish to stop recording, hold down the FADE button.
The picture and sound gradually disappear (fade out).
- When the picture has disappeared, press the START/STOP button to stop recording.

- FADE OUT**
(Approx. 4 seconds)

- FADE IN**
(Approx. 4 seconds)

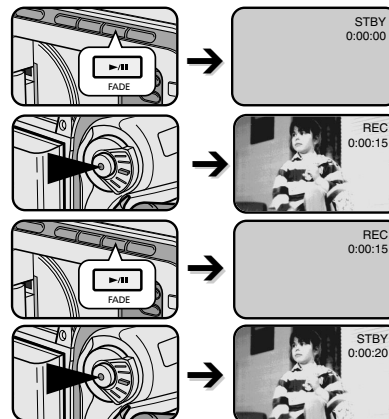

Hold down the FADE button *a. FADE OUT* *Gradual disappearance* →



← *Gradual appearance*

b. FADE IN

Release the FADE button

Advanced Recording

Audio dubbing (SCD105 only)

- ❖ The AUDIO DUBBING function only works in PLAYER Mode.
- ❖ You can add sound to the original sound on a pre-recorded tape recorded in SP mode with 12bit sound.
- ❖ Use the internal and external microphones or other audio equipment.
- ❖ The original sound will not be erased.

Dubbing sound

1. Set the camcorder to PLAYER mode.
 - If you want to use an external microphone, connect the microphone to the external MIC input jack on the camcorder.
2. Press the ►/|| (PLAY/STILL) button and find the timeframe of the scene to be dubbed.
3. Press the ►/|| (PLAY/STILL) button to pause the scene.
4. Press the A.DUB button on the Remote Control.
 - A.DUB will be displayed on the LCD.
 - The camcorder is in a ready-to-dub state for dubbing.
5. Press the ►/|| (PLAY/STILL) button to start dubbing.
 - Press the ■ (STOP) button to stop the dubbing.

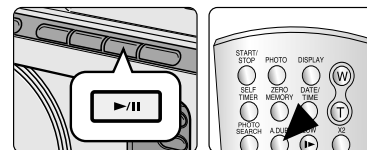
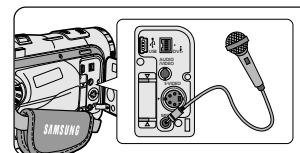

Notes

- You can not use the audio dubbing function while playing a write protected video tape.
- You can not dub sound on a pre-recorded tape in LP mode or 16 bit mode.

ENGLISH**Advanced Recording****Dubbed audio Playback**

1. Insert the dubbed tape and press MENU button.
2. Turn the MENU DIAL to highlight A/V.
3. Press the ENTER button to enter the sub-menu.
4. Use the MENU DIAL to select AUDIO SELECT from the submenu.
5. Press the ENTER button to enter the sub-menu.
6. Using the MENU DIAL, select the AUDIO playback channel.
 - Press the ENTER button to confirm the audio playback channel.
 - SOUND1 : play the original sound.
 - SOUND2 : play the dubbed sound.
 - MIX(1+2) : play back SOUND1 and 2 equally mixed.
7. To exit, press the MENU button.
8. Press the ►/|| (PLAY/STILL) button to playback the dubbed tape.

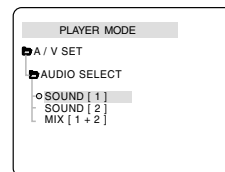
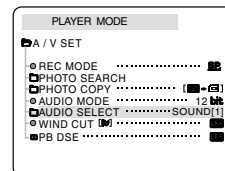
**Note**

When you playback added sound (SOUND2 or MIX mode), you may experience loss of sound quality.

Advanced Recording

PHOTO Image Recording

1. Set the power switch to the CAMERA mode.
2. Press the PHOTO button.
 - The still picture is recorded for about 6~7 seconds.
3. After the PHOTO has been recorded, the camcorder returns to STBY mode.

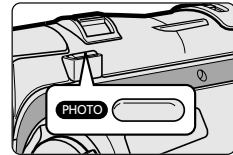

Searching for a PHOTO picture

- ❖ The PHOTO SEARCH works in PLAYER mode only.

1. Press the MENU button.
 - The MENU list will appear.
2. Turn the MENU DIAL to highlight A/V.
3. Press the ENTER button to enter the submenu.
4. Select PHOTO SEARCH from the submenu and press the ENTER button.
 - You can also press the PHOTO SEARCH button on the remote control. (SCD105 only)
5. Search the PHOTO using the ►► (FF) and ◀◀ (REW) buttons.
 - The PHOTO search process appears on the LCD while you are searching.
 - After completing the search, the camcorder displays the still image.
6. To exit, press the ■ (STOP) button.

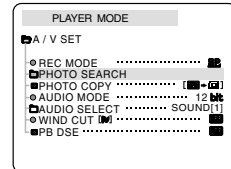
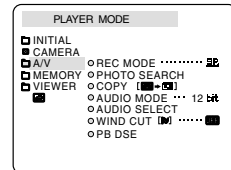

ENGLISH**Advanced Recording*****NITE PIX (0 lux recording)***

- ❖ The NITE PIX function works in CAMERA/M.REC mode.
- ❖ The NITE PIX function enables you to record a subject in darkness.

1. Set the camcorder to CAMERA mode.
2. Slide the NITE PIX switch to ON.
 -  (NITE PIX indicator) appears on the LCD monitor.
 - The infrared(invisible rays) light is turned on automatically.
3. To cancel the NITE PIX function, slide the NITE PIX switch to OFF.

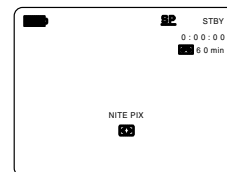
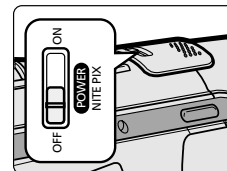
**Notes**

- The maximum recording distance using the infrared light is about 3 m (about 10 feet).
- If you use the NITE PIX function in normal recording situations (ex. outdoors by day), the recorded picture may be tinted green.
- In the NITE PIX mode, certain functions are not available, such as White Balance, Program AE, DSE, BLC.
- If focusing is difficult with the auto focus mode when using the NITE PIX function, focus manually.
- Do not cover the Infrared Light with the hand.

Advanced Recording

POWER NITE PIX

- ❖ The POWER NITE PIX function works in CAMERA mode.
 - ❖ The POWER NITE PIX function can record a subject more brightly in darkness than the NITE PIX function.
 - ❖ A POWER NITE PIX is displayed for three seconds by LCD if you press a SLOW SHUTTER button in state that a NITE PIX switch is turned on.
 - ❖ When you work in POWER NITE PIX mode, POWER NITE PIX icon appears on the LCD continuously.
1. Set the camcorder to CAMERA mode.
 2. Turn on the NITE PIX switch, and then press the SLOW SHUTTER button.
 3. Press the SLOW SHUTTER button to set shutter speed.
The SLOW SHUTTER function enables you to record a subject more brightly.
 4. When using POWER NITE PIX the image takes on a slow motion like effect.
 5. To cancel the POWER NITE PIX function, press the SLOW SHUTTER button to set to "off" and then turn off the NITE PIX switch.

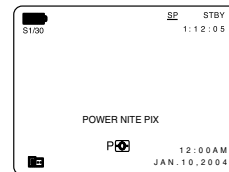
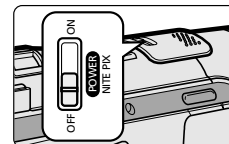

Notes

- The maximum recording distance using the infrared light is about 3 m (about 10 feet).
- If you use the POWER NITE PIX function in normal recording situations (ex. outdoors by day), the recorded picture may contain unnatural colors.
- In the POWER NITE PIX mode, certain functions are not available, such as White Balance, Program AE, DSE, BLC.
- When the subject is too bright, press the SLOW SHUTTER button (1/30 → 1/8) to obtain better quality recordings.

ENGLISH**Advanced Recording****Using the VIDEO LIGHT**

- ❖ VIDEO LIGHT works in CAMERA/M.REC mode only.
- ❖ Brightens the scene when natural lighting is too dim.
- ❖ The VIDEO LIGHT works in SP mode only.
 - If you turn on the LIGHT in LP mode, the LIGHT indicator and "LP" will blink on the LCD.

DANGER

- The VIDEO LIGHT can become extremely hot. Do not touch it while in operation or soon after turning it off, otherwise serious injury may result.
 - Do not place the camcorder into the carrying case immediately after using the VIDEO LIGHT, since it remains extremely hot for some time.
 - Do not use near flammable or explosive materials.
 - It is recommended that you consult your nearest SAMSUNG dealer for bulb replacement.
 - The life of the bulb is approximately 50 hours.
1. Set the camcorder to the CAMERA mode.
 2. Press the V.LIGHT button.
 - The VIDEO LIGHT indicator appears on the LCD and the light is turned on.
 3. If you want to turn off the VIDEO LIGHT, press the V.LIGHT button again.

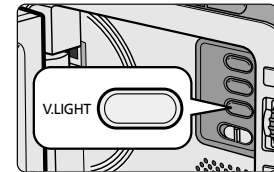
**Notes**

- The light is turned off automatically during ejecting or inserting.
- Even if the battery indicator does not blink when the battery pack's charge is low, the camcorder may turn off automatically when you turn on the light, or when you start recording with the light turned on.
- The built-in light is used as a subsidiary light, it may not be enough for outdoor lighting.
- The picture quality may deteriorate if you use the VIDEO LIGHT continuously for more than 20 minutes.

Advanced Recording

Various Recording Techniques

❖ In some situations different recording techniques may be required for more dramatic results.

Note

Please rotate the LCD screen carefully as excessive rotation may cause damage to the inside of the hinge that connects the LCD screen to the Camcorder.

1. General recording.

2. Downward recording.

Making a recording with a top view of the LCD screen.

3. Upward recording.

Making a recording viewing the LCD screen from below.

4. Self recording.

Making a recording viewing the LCD screen from the front.

5. Recording with the Viewfinder.

- In circumstances where it is difficult to use the LCD monitor, the viewfinder can be used as a convenient alternative.

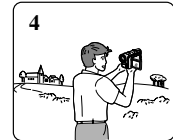
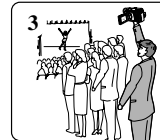
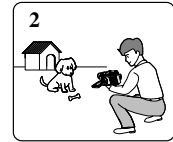

ENGLISH**Playback*****Tape Playback***

- ❖ The playback function works in PLAYER mode only.

Playback on the LCD

- ❖ It is practical to view a tape using the LCD when in a car or outdoors.

Playback on a TV monitor

- ❖ To play back a tape, the television must have a compatible color system.
- ❖ We recommend that you use the AC Power Adapter as the power source for the camcorder.

Connecting to a TV which has Audio/Video input jacks

1. Connect the camcorder and TV with the AUDIO/VIDEO cable.
 - The yellow plug : Video
 - The white plug : Audio(L)-mono
 - The red plug : Audio(R)
 - If you connect to a monaural TV or VCR, connect the yellow plug (Video) to the video input of the TV or VCR and the white plug (Audio L) to the audio input of the TV or VCR.
2. Set the power switch on the camcorder to PLAYER mode.
3. Turn on the TV and set the TV/VIDEO selector on the TV to VIDEO.
 - Refer to the TV or VCR user's manual.
4. Play the tape.

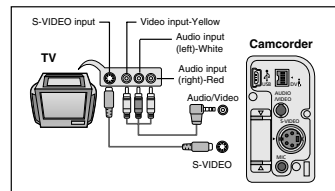
**Notes**

- You may use an S-VIDEO (optional) cable plug to obtain better quality pictures if you have a S-VIDEO connector on your TV.
- Even if you use an S-VIDEO (optional) cable, you need to connect an audio cable.
- If you connect the cable to the Audio/Video Jack, you will not hear sound from the Camcorder's speakers.

Playback

Connecting to a TV which has no Audio and Video input jacks

- ❖ You can connect your camcorder to a TV through a VCR.
1. Connect the camcorder and VCR with the AUDIO/VIDEO cable.
 - The yellow plug : Video
 - The white plug : Audio(L) - Mono
 - The red plug : Audio(R)
 2. Connect a TV to the VCR.
 3. Set the power switch on the camcorder to PLAYER mode.
 4. Turn on both the TV and VCR.
 - Set the input selector on the VCR to LINE.
 - Select the channel reserved for your VCR on the TV set.
 5. Play the tape.

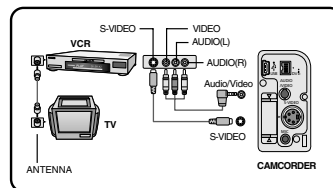

Playback

- ❖ You can play the recorded tape in PLAYER mode.
1. Connect a power source and set the power switch to PLAYER mode.
 2. Insert the tape you wish to play back.
 3. Using the ►► (FF) and ◀◀ (REW) buttons, find the first position you wish to play back.
 4. Press the ►/|| (PLAY/STILL) button.
 - The images you recorded will appear on the TV after a few seconds.
 - If a tape reaches its end while being played back, the tape will rewind automatically.



Note

- The playback mode (SP/LP) is selected automatically.

ENGLISH**Playback****Various Functions while in PLAYER mode**

- ❖ The PLAY/STILL, STOP, FF, REW buttons are located on the camcorder and the Remote Control.
- ❖ The F.ADV(Frame advance), X2, SLOW buttons are located on the Remote Control only. (SCD105 only)
- ❖ To prevent tape and head-drum wear, your camcorder will automatically stop if it is left in STILL or SLOW modes for more than 5 minutes.

Playback pause

- ❖ Press the ►/|| (PLAY/STILL) button during Playback.
- ❖ To resume playback, press the ►/|| (PLAY/STILL) button.

Picture search (Forward/Reverse)

- ❖ Press the ►► (FF) or ◀◀ (REW) buttons during Playback or Still mode.
To resume normal playback, press the ►/|| (PLAY/STILL) button.
- ❖ Keep pressing ►► (FF) or ◀◀ (REW) buttons during Playback or Still mode.
To resume normal playback, release the button.

Slow playback (Forward/Reverse) (SCD105 only)

- ❖ Forward Slow Playback
 - Press the SLOW button on the remote control during Playback.
 - To resume normal playback, press the ►/|| (PLAY/STILL) button.
- ❖ Reverse Slow Playback
 - Press the ◀◀ (-) button during Forward Slow Playback.
 - To resume forward slow playback, press the ►► (+) button.
 - To resume normal playback, press the ►/|| (PLAY/STILL) button.

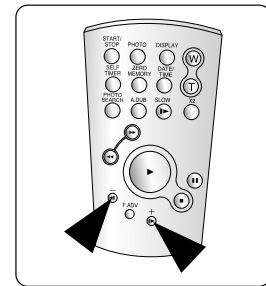
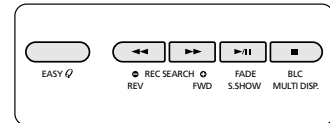

Playback

Frame advance (To play back frame by frame) (SCD105 only)

- Press the F.ADV button on the Remote Control while in Still mode. The F.ADV function works in still mode only.
- To resume normal playback, press the ►/|| (PLAY/STILL) button.
 - ❖ Forward frame advance
 - Press the F.ADV button on the remote control in Still mode.
 - ❖ Reverse frame advance
 - Press ◀ (-) the button on the remote control to change the direction in F.ADV mode.
 - Press the F.ADV button on the remote control.

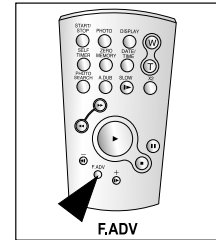

X2 Playback (Forward/Reverse) (SCD105 only)

- ❖ Forward X2 Playback
 - Press the X2 button on the Remote Control during Playback.
 - To resume normal playback, press the ►/|| (PLAY/STILL) button.
- ❖ Reverse X2 Playback
 - Press ◀ (-) the button during during Forward X2 Playback.
 - To resume normal playback, press the ►/|| (PLAY/STILL) button.

Reverse playback (SCD105 only)

- ❖ To playback in reverse at normal speed, press the ◀ (-) button during normal forward playback.
- ❖ Press the ►/|| (PLAY/STILL) or ►/|| (+) button to return to normal forward playback.

Notes

- Mosaic shaped distortion may appear on the screen while in some of the various playback modes.
 - Mosaic shaped distortion or noise may be experienced when you play back tapes recorded in LP which contain various playback functions.
- Sound will only be heard during normal SP or LP playback.

ENGLISH**Playback****ZERO MEMORY (SCD105 only)**

- ❖ The ZERO MEMORY function works in both CAMERA and PLAYER modes.
 - ❖ You can mark a point on a tape that you want to return to following playback.
1. Press the ZERO MEMORY button on the remote control before the recording or during playback at the point you wish to return.
 - The time code is changed to a tape counter that is set to zero memory with the **M** 0:00:00 (Zero memory indicator)
 - If you want to cancel the zero memory function, press the ZERO MEMORY button again.
 2. Finding the zero position.
 - When you have finished playback, fast forward or rewind the tape.
 - The tape stops automatically when it reaches the zero position.
 - When you have finished recording, press the power switch on the PLAYER and press the **◀◀** (REW) button.
 - The tape stops automatically when it reaches the zero position.
 3. The tape counter with the **M** (Zero memory indicator) disappears from the display and the tape counter is changed to the time code.

Notes

- In the following situations, ZERO MEMORY mode may be canceled automatically:
 - At the end of the section marked with the ZERO MEMORY function.
 - When the tape is ejected.
 - When you remove the battery pack or power supply.
- The zero memory may not function correctly where there is a break between recordings on the tape.

Playback

PB DSE (Playback Digital Special Effects)

- ❖ The PB DSE function works in PLAYER mode.
- ❖ The PB DSE function enables you to apply Digital Special Effects (DSE) to tape playback or still images.

1. Set the camcorder to the PLAYER mode and then play back a tape.
2. Press the MENU button and turn the MENU DIAL to highlight A/V.
3. Press the ENTER button to enter the sub-menu.
4. Select PB DSE from the sub-menu and press the ENTER button.
5. Select PB DSE item (off, mirror, mosaic) from the sub-menu and press the ENTER button.
6. To exit, press the MENU button.
7. To cancel the PB DSE function, set the PB DSE to off or press the STOP button.

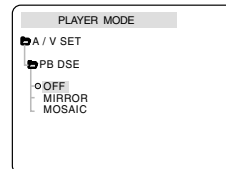
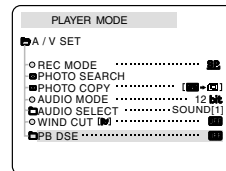
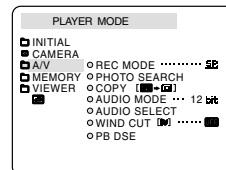

Notes

- You cannot apply the PB DSE function to the pictures which are being input from an external source.
- Once you modify an image using the PB DSE function, it cannot be imported to your PC from the camcorder's DV jack.

ENGLISH**Playback*****PB ZOOM***

- ❖ The PB ZOOM function works in PLAYER mode.
 - ❖ The PB ZOOM function enables you to magnify playback or still image.
1. Press the PB ZOOM button in playback mode or in playback still mode.
 2. The image is magnified starting from the center of image and arrows appear which allow you to move the image in four directions.
 3. You can zoom in from 1.2x to 8.0x by moving the zoom lever.
 4. You can move the image in the arrow directions using the MENU DIAL.
 5. You can change the arrow direction(vertical, horizontal) by pressing the ENTER button.
 6. To cancel the PB ZOOM function, press the PB ZOOM or STOP button.

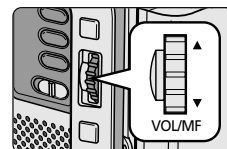
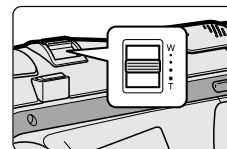
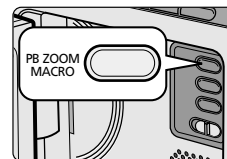
**Notes**

- You cannot apply the PB ZOOM function to pictures which are being input from an external video source.
- The PB ZOOM image cannot be imported to your PC from the camcorder's DV jack.

IEEE 1394 Data Transfer

Transferring IEEE1394 (i.LINK)-DV standard data connections

Connecting to a DV device

- ❖ Connecting with other DV standard products.
 - A standard DV connection is quite simple.
 - If a product has a DV port, you can transfer data by connecting to the DV port using the correct cable.
 - !!! Please be careful since there are two types of DV ports, (4pin, 6pin). This camcorder has a 4pin terminal.
- ❖ With a digital connection, video and audio signals are transmitted in digital format, allowing high quality images to be transferred.

Connecting to a PC

- ❖ If you want to transmit data to a PC, you must install a IEEE 1394 add-on card onto the PC. (not supplied)
- ❖ The frame rate recorded for video capturing is dependent on the capacity of the PC.

Notes

- When you transmit data from the camcorder to another DV device, some functions may not work.
 - If this occurs, please reconnect the DV cable or turn the power OFF and ON again.
- When you transmit data from the camcorder to PC, PC function button is not available in M.PLAY mode.
- Do not use the camcorder and IEEE1394 together as this will cause IEEE1394 to shut off.

ENGLISH**IEEE 1394 Data Transfer****● System requirements**

- CPU : faster Intel® Pentium III™ 450Mhz compatible.
- Operating system : Windows® 98SE, ME, XP, Mac OS (9.1~10.2)
- Main memory : more than 64 MB RAM
- IEEE1394 add-on card or built in IEEE1394 card

Recording with a DV connection cable

1. Set the power switch to PLAYER mode.
2. Connect the DV cable (not supplied) from the DV jack of the camcorder to the DV jack of the other DV device.
 - Make sure that DV IN appears on the screen.
3. Press the START/STOP button to begin REC PAUSE mode.
 - PAUSE is displayed on the OSD.
4. Start playback on the other DV device while you monitor the picture.
5. Press the START/STOP button to start recording.
 - If you want to pause recording momentarily, press the START/STOP button again.
6. To stop recording, press the ■ (STOP) button.

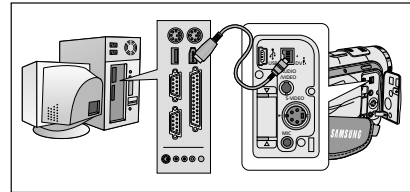
**Notes**

- When using this camcorder as a recorder, the pictures that appear on a monitor may seem uneven, however recorded pictures will not be affected.
- Operations are not guaranteed for all the recommended computer environments mentioned above.

USB interface

● Transferring a Digital Image through a USB Connection

- ❖ You can easily transfer a image from a MEMORY CARD to a PC without additional add-on cards via a USB connection.
- ❖ You can transfer an image to a PC via a USB connection.
- ❖ If you transfer data to a PC, you need to install the software (Driver, DVC Media 5.1, Windows Media Player 9.0, DirectX 9.0a) supplied with the camcorder.

System Requirements

- CPU : Intel® Pentium III™ 450 processor compatible or better
- Operating system : Windows® 98SE/ME/ 2000/XP
- RAM : 128 MB or more
- CD-ROM: 4x CD-ROM drive
- VIDEO : 65,000-color or better video display card
- Available USB port (V1.1)
- Hard Disc : 4GB (8GB recommended)



Notes

- Intel® Pentium III™ is a trademark of the Intel Corporation.
- Windows® is a registered trademark of the Microsoft® Corporation.
- All other brands and names are property of their respective owners.
- Operations are not guaranteed for all of the recommended computer environments mentioned above.

ENGLISH**USB interface****Installing DVC Media 5.1 Program**

- ❖ **DVC Media 5.1 User's Manual is included on the accompanying CD(D:\help\)** in adobe's Portable Document Format(PDF) The user's manual can be viewed using Acrobat Reader software, which is also included on the CD. **(The Acrobat Reader is a freeware product of AdobeSystems,Inc.)**
- ❖ Do not connect the camcorder to PC before installing the program.
- ❖ If another camera or scanner is connected, please disconnect it in advance.
- ❖ This explanation is based on Windows®98SE OS.

Program installation

1. Insert the software CD into CD-ROM drive.
 - Installation selection screen appears on the monitor.
2. If the installation selection screen does not appear after inserting the CD click "Run" on the Windows "Start" menu and execute SETUP.EXE file to begin installation.
 - When CD-ROM drive is set to "D:drive", type "D:/setup.exe" and press Enter.
3. Click the icons listed below to install the selected software.
 - The program automatically checks and installs the driver.
 - DVC Driver: USB removable Disk Driver (Windows® 98SE only)
USB PC CAMERA Driver
USB Streaming Driver
 - DVC Media 5.1
 - DirectX 9.0a
 - Windows Media Player 9.0
 - Editing Software

Using the "PC camera" function

- ❖ You can use this camcorder as a PC CAMERA.
 - ❖ When you connect to a Web site that can provide video chatting functions, you can use your camcorder for such functions.
 - ❖ When you use the voice input at video chatting (or net-meeting) function, connect the external microphone to the soundcard of PC.
 - ❖ Using the camcorder with PC installed Net-meeting program, you can conduct video conference.
 - ❖ The PC CAMERA's screen size is 160x120 pixels.
 - ❖ If PC is connected with the USB to the camcorder, the buttons which excepts the POWER SWITCH, MODE SWITCH, ZOOM SWITCH and NITE PIX SWITCH are not operated.
1. Set the mode switch to Tape, set the power switch to CAMERA.
 2. Connect one end of the USB cable to the USB jack on the camcorder and the other end to the USB connector on your computer.



USB interface

Using the "removable Disk" function

- ❖ You can easily transfer data from a Memory Card to a PC without additional add-on cards via a USB connection.
1. Set the mode switch to memory, set the power switch to CAMERA or PLAYER.
 2. Connect one end of the USB cable to the USB jack on the camcorder and the other end to the USB port on your computer.

Using the "USB streaming" function

- ❖ USB streaming data type is MPEG4.
- ❖ To use USB STREAMING, the DVC Media 5.1, DirectX 9.0a and Windows Media Player 9.0(included in the CD) programs must be installed in the PC.
- ❖ You can view CAMCORDER video on your PC using USB streaming.

You can also store it as a moving picture in the "asf" file format, or as a still image in the "jpg" file format on a PC.

1. Set the mode switch to TAPE, set the power switch to CAMERA or PLAYER.
2. Connect one end of the USB cable to the USB jack on the camcorder and the other end to the USB port on your computer.
3. Execute the DVC Media 5.1 program.

If you want the detailed description of USB streaming, refer to the DVC Media 5.1 User's Manual.

Connecting to a PC

1. Connect a USB cable to the USB port on the PC.
2. Connect the other end of the USB cable into the proper terminal on the camcorder. (USB jack)
 - If a PC is connected to the camcorder with a USB cable only, the Power Switch, Zoom Switch, mode switch and NITE PIX operate.

Disconnecting the USB cable

- ❖ After completing the data transmission, you must disconnect the cable in the following way:
1. Select the removable disc icon and click the right mouse button to select [Eject].
 2. Select [Confirm] and disconnect the USB cable when the Windows Splash screen appears.

Notes

- If you disconnect the USB cable from the PC or the camcorder while transferring, the data transmission will stop and the data may be damaged.
- If you connect the USB cable to a PC via a USB HUB or simultaneously connect the USB cable along with other USB devices, the camcorder may not work properly.
 - If this occurs, remove all USB devices from the PC and reconnect the camcorder.

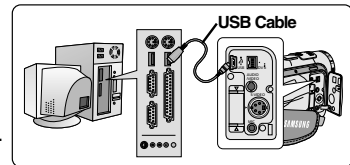

ENGLISH**Digital Still Camera mode****MEMORY STICK (Optional Accessory)**

- ❖ The Memory Stick stores and manages images recorded by the camera.

Memory Stick Functions

- ❖ Recording still images and MPEG4 movie
- ❖ Viewing still images and MPEG4 movie
 - Single
 - Slide show (Still images only)
- ❖ Multi display
- ❖ Protecting images against accidental erasure
- ❖ Deleting images recorded on a Memory Stick
- ❖ Print marking still images
- ❖ Formatting a Memory Stick

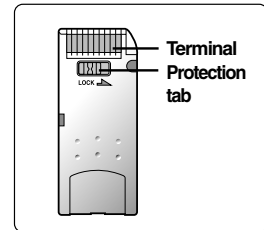
**Notes**

- You can use most of the camera's functions when recording to the Memory Stick.
- "▶▶▶ []" appears on the screen while recording to the Memory Stick.
- While recording or loading an image, do not eject or insert the Memory Stick.
 - Inserting or ejecting a Memory Stick while recording or loading an image can cause data damage.
- If you want to save all images on the Memory Stick, set the write protect tab on the Memory Stick to LOCK.



MEMORY STICK™

- "Memory Stick" and  are trademarks of Sony Corporation.
- All other product names mentioned herein may be the trademarks or registered trademarks of their respective companies. Furthermore, "™" and "®" are not mentioned in each case in this manual.
- "Memory Stick PRO" can not be used with the SCD103 MODEL.

Digital Still Camera mode

Inserting and ejecting the Memory Card

● Inserting the Memory Card

1. Turn the Power switch to OFF.
2. Insert the Memory Card in the direction of the arrow into the Memory Card slot located on the bottom of the camcorder.

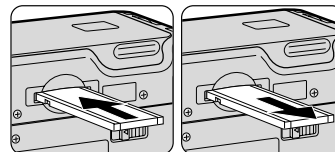

● Ejecting the Memory Card

1. Turn the Power switch to OFF.
 2. Push the Memory Card, then it comes out of the camcorder automatically.
 3. Pull out the Memory Card.
- ❖ Do not attempt to pull the Memory Card out without first pushing it in.

Notes

- Memory Stick Duo type or RS-MMC (SC-D105 MODEL only) should be inserted by using the ADAPTOR (not supplied).
 - If you set the camcorder to M.PLAY mode, the last recorded still image appears.
 - If there are no recorded images on the Memory Card, NO STORED PHOTO! or NO STORED MPEG4! and  will display on the screen.
 - While recording, loading, erasing or formatting, do not turn off the power or change the mode.
 - Please turn the power off before you insert or eject the Memory Card. You could lose data on the Memory Card.
- Do not allow metal substances to come in contact with the terminals of the Memory Card.
 - Do not bend, drop or apply strong shock to Memory Card.
 - After pulling the Memory Card out from the camcorder, please keep the Memory Card in a soft case to prevent static shock.
 - The stored contents may be changed or lost as a result of misuse, static electricity, electric noise or repair. Save important images separately.
 - Samsung is not responsible for data loss due to misuse.

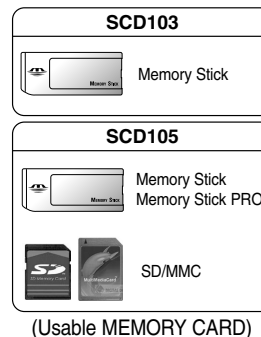

ENGLISH**Digital Still Camera mode****Structure of folders and files on the Memory Card**

- ❖ The still images that you recorded are saved in JPEG file format on the Memory Card.
- ❖ The moving images that you recorded are saved in MPEG4 file format on the Memory Card.
- ❖ Each file has a file number and all files are assigned to a folder.
 - A file number from DCAM0001 to DCAM9999 is sequentially assigned to each recorded image.
 - Each folder is numbered from 100SSDVC to 999SSDVC and recorded on the Memory Card.

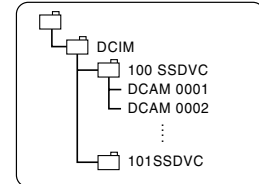
**Image Format**

- ❖ Still image
 - Images are compressed in JPEG (Joint Photographic Experts Group) format.
 - The number of pixels are 640×480 in each mode.
 - Amount of still images must be under 1.4MB.
- ❖ Moving Image
 - Images are compressed in MPEG (Moving Picture Experts Group) format.
 - The number of pixels are 320×240, 160×120 in each mode.

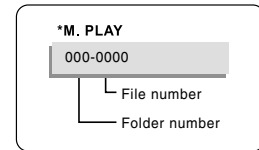
**Selecting the CAMCORDER mode**

- ❖ You can use this camcorder as a Digital Still Camera (DSC).
- ❖ You have to set the mode switch to MEMORY CARD position to use this camcorder as Digital Still Camera.
 - M.REC mode (Memory RECORD mode)
 1. Set the mode switch to MEMORY CARD.
 2. Set the power switch to CAMERA.
 - M.PLAY mode (Memory PLAYBACK mode)
 1. Set the mode switch to MEMORY CARD.
 2. Set the power switch to PLAYER.

Digital Still Camera mode

MEMORY FILE NUMBER

- ❖ File numbers will be given to images in order of recording when still images are stored on the Memory Card.
- ❖ MEMORY FILE NUMBERS may be set as follows:
 - SERIES: When there are existing files, the new image will be named as the next number in the sequence.
 - RESET
 - When there are no files stored on the Memory Card: The file numbering starts from 0001
 - When there are files stored on the Memory Card: File numbering will continue after the last file's number

1. Set the mode switch to MEMORY CARD and the power Switch to the CAMERA mode.
2. Press the MENU button.
 - The menu list will appear.
3. Turn the MENU DIAL to highlight MEMORY and press the ENTER button.
4. Turn the MENU DIAL to activate the FILE NO. and press the ENTER button.
5. To exit, press the MENU button.

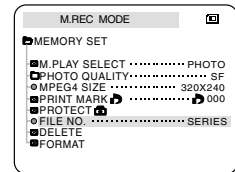
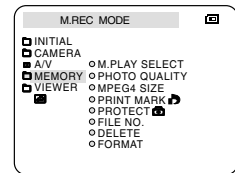

Notes

- When using a Memory Card that contains image files from another device, numbering the file will begin after the largest number that is memorized whether in the camera or the the Memory Card.
- Numbering the file starts from 0001 again when 9999 files have been saved.

ENGLISH**Digital Still Camera mode****Selecting the image quality**

- ❖ You can select the quality of a still images to be recorded.

Select the image quality

- Set the mode switch to MEMORY CARD.
- Set the power switch to the CAMERA mode.
- Press the MENU button.
 - The menu list will appear.
- Turn the MENU DIAL to highlight MEMORY.
- Press the ENTER button to enter the sub-menu.
- Turn the MENU DIAL to highlight PHOTO QUALITY in the submenu.
- Press the ENTER button.
- Using the MENU DIAL, select the image quality.
 - Press the ENTER button to confirm the image quality.
 - If you exit the sub-menu without pressing the ENTER button, the quality mode is not changed.
- To exit, press the MENU button.

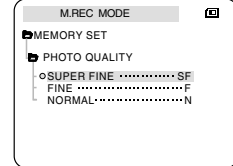
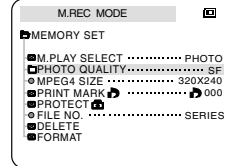
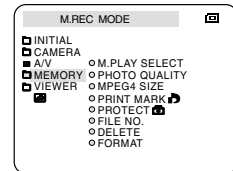
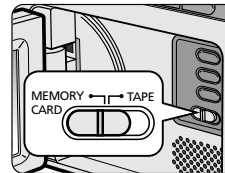

- **Number of images on the Memory Card**

QUALITY	8MB	16MB
SUPER FINE	Approx. 45	Approx. 90
FINE	Approx. 85	Approx. 170
NORMAL	Approx. 155	Approx. 310

- The actual number that you can record varies depending on the image size.

Digital Still Camera mode

Recording Still images to a Memory Card in M.REC Mode.

❖ Audio cannot be recorded with a still image onto the Memory Card.

Recording images to a Memory Card

1. Set the mode switch to MEMORY CARD.
2. Set the power switch to CAMERA.
3. Press the PHOTO button.
 - The still image is recorded to the Memory Card.
 - While the camcorder is recording the still image, "▶▶▶" appears on the screen.

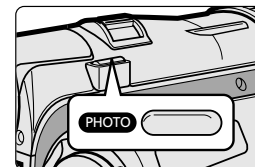
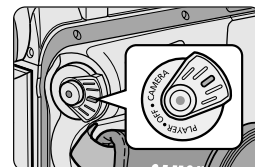
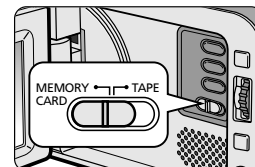

ENGLISH

Digital Still Camera mode

Recording an image from a cassette as a still image.

- ❖ You can record still image from a cassette on a Memory Card.
 - ❖ If you want to move recorded multiple still images from a cassette to a Memory Card, use the COPY function.
1. Set the mode switch to TAPE.
 2. Set the power switch to PLAYER mode.
 3. Play back the cassette.
 4. Press the PHOTO button.
 - The still image is recorded on the Memory Card.
 - While the camcorder is recording the still image, “▶▶▶” appears on the screen.

Digital Still Camera mode

Viewing Still images

- ❖ You can playback and view still images recorded on the Memory Card.
- ❖ There are 3 ways to view recorded images.
 - Single : To view an image frame by frame.
 - Slide show : To view all images automatically and in consecutive order.
 - Multi display : To view 6 images at once.

To view a Single image

1. Set the mode switch to MEMORY CARD.
2. Set the power switch to PLAYER mode.
 - The last recorded image appears.
 - If there are no recorded images on the Memory Card, NO STORED PHOTO! or NO STORED MPEG4! and  will display on the screen.
3. Using the **▶▶** (FWD) and **◀◀** (REV) buttons, search for the desired still image.
 - To view the next image : press the **▶▶** (FWD) button.
 - To view the previous image : press the **◀◀** (REV) button.
 - Pressing **▶▶** (FWD) when you are on the last image will take you to the first image and pressing **◀◀** (REV) when you are on the first image will take you to the last image.
 - Keep pressing **▶▶** (FWD) or **◀◀** (REV) to search for an image quickly.

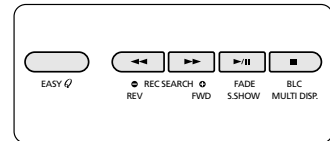

To view a slide show

1. Set the mode switch to MEMORY CARD.
2. Set the power switch to PLAYER mode.
 - The last recorded image appears.
3. Press the **▶/||** (S.SHOW) button.
 - All images will be played back consecutively for 3~4 seconds each.
4. To stop the slide show, press the **▶/||** (S.SHOW) button again.

ENGLISH**Digital Still Camera mode****To view the Multi Display**

1. Set the mode switch to MEMORY CARD.
2. Set the power switch to PLAYER mode.
 - The last recorded image appears.
3. To view six stored images on single screen, press the MULTI DISP. button.
 - A selection mark (▶) appears under the image.
 - Turn the MENU DIAL to select a image.
4. To return to single playback mode, press the MULTI DISP. button again.

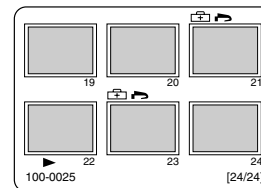
**Notes**

- To display the previous six images, press the ◀◀ (REV).
- To display the next six images, press the ▶▶ (FWD).

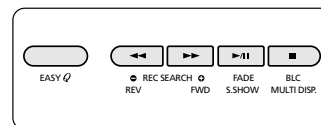

Digital Still Camera mode

Copying still images from a cassette to Memory Card

- ❖ You can copy still images recorded with PHOTO function on a cassette into a Memory Card.
- ❖ Rewind the TAPE to the point which you wants.

1. Set the power switch to the PLAYER mode.
2. Press the MENU button.
3. Turn the MENU DIAL to highlight A/V and press the ENTER button.
 - The submenu will appear.
4. Turn the MENU DIAL to highlight PHOTO COPY and press the ENTER button.
 - All still images that recorded on a cassette will be copied into a Memory Card.
5. The camcorder automatically performs the photo search to find still images and copy starts.
6. Press ■ (STOP) button to stop copying.
 - Copy stops when the cassette is finished or Memory Card is full.

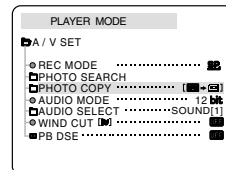
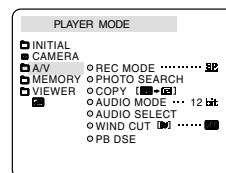

ENGLISH**Digital Still Camera mode****Marking images for printing**

- ❖ This camcorder supports the DPOF (Digital Print Order Format) print format.
- ❖ You can automatically print images recorded on a Memory Card with a printer supporting DPOF.
- ❖ There are 2 ways to make a PRINT MARK.
 - THIS FILE : You can set a print mark on the photo image displayed on the LCD.
 - ALL FILES : To print 1 copy each of all of the stored images.

1. Set the mode switch to MEMORY CARD.
2. Set the power switch to PLAYER.
 - The last recorded image appears.
3. Using the ►► (FWD) and ◀◀ (REV) buttons, search for the still image that you want to mark.
4. Press the MENU button.
5. Turn the MENU DIAL to highlight MEMORY and press the ENTER button.
 - The MEMORY SET submenu will appear.
6. Turn the MENU DIAL to highlight PRINT MARK, press the ENTER button.
7. Use the MENU DIAL to select either THIS FILE or ALL FILES and press the ENTER button.
8. Use the MENU DIAL to select the quantity and press the ENTER button.

Notes

- When you setup the PRINT MARK option to ALL FILES, 999 files from the current file are set to 1 or 0.
- The ALL FILES option may require extended operation time depending on the number of stored images.

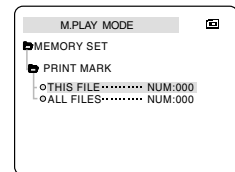
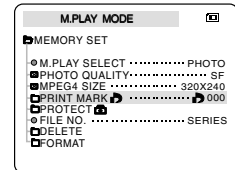
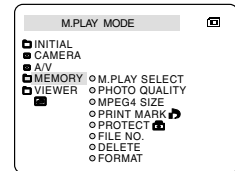

Digital Still Camera mode

Protection from accidental erasure

- ❖ You can protect important images from accidental erasure.
 - If you execute FORMAT, all images including protected images will be erased.

1. Set the mode switch to MEMORY CARD.
2. Set the power switch to PLAYER.
 - The last recorded image appears.
 - If there are no recorded images on the Memory Card, NO STORED PHOTO! or NO STORED MPEG4! and  will display on the screen.
3. Using the **▶▶** (FWD) and **◀◀** (REV) buttons, search for the still image that you want to protect.
4. Press the MENU button.
5. Turn the MENU DIAL to highlight MEMORY and press the ENTER button.
 - The submenu of MEMORY SET will appear.
6. Turn the MENU DIAL to highlight PROTECT and press the ENTER button.
7. Press the ENTER button to set PROTECT to ON or OFF.
 - THIS FILE : protects the currently selected file from erasure.
8. Using the **▶▶** (FWD) and **◀◀** (REV) buttons, search for the still image that you wish to protect.
9. To exit the menu, press the MENU button.

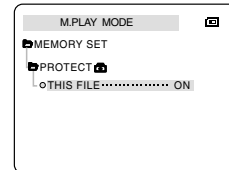
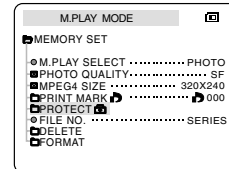
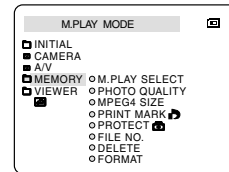

ENGLISH**Digital Still Camera mode*****Deleting Still images***

- ❖ You can erase the still images recorded on the Memory Card.
- ❖ If you want to delete protected images, you must first deactivate the image protection.
- ❖ An image which has been deleted cannot be recovered.

1. Set the mode switch to MEMORY CARD.
2. Set the power switch to PLAYER.
3. Using the ►► (FWD) and ◀◀ (REV) buttons, search for the still image that you want to delete.
4. Press the MENU button.
5. Turn the MENU DIAL to highlight MEMORY and press the ENTER button.
 - The MEMORY SET submenu will appear.
6. Turn the MENU DIAL to highlight DELETE and press the ENTER button.
 - Using the MENU DIAL, select either THIS FILE or ALL FILES and press the ENTER button.
 - THIS FILE : deletes only the file currently selected.
 - ALL FILES : deletes all files stored in the Memory Card.
7. A box will appear to verify whether you wish to delete the image(s).
 - Using the MENU DIAL, select the item.
 - EXECUTE : deletes the selected image(s).
 - CANCEL : does not delete the selected image(s) and returns to the previous menu.

Note

- If you try to delete a protected image, "PROTECT!" appears on the screen.

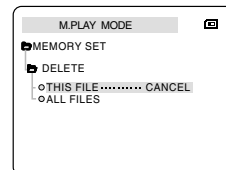
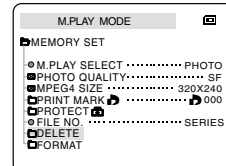
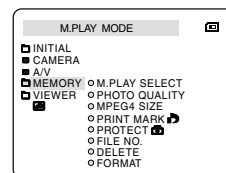

Digital Still Camera mode

Formatting the Memory Card

- ❖ You can use the MEMORY FORMAT functions to completely delete all images and options on the Memory Card, including protected images.
- ❖ The format function restores the Memory Card to its initial state.
- ❖ The Memory Card supplied with this camcorder has been formatted already.

Attention

- ❖ If you execute the MEMORY FORMAT function, all images will be erased completely and erased images cannot be recovered.
1. Set the mode switch to MEMORY CARD.
 2. Set the power switch to PLAYER mode.
 3. Press the MENU button.
 4. Turn the MENU DIAL to highlight MEMORY and press the ENTER button.
 - The sub menu will appear.
 5. Select FORMAT from the list and press the ENTER button.
 6. "ALL FILES ARE DELETED! FORMAT REALLY?" appears on the screen.
 7. Using the MENU DIAL, select the item.
 - NO : To return to previous menu
 - YES : To start formatting.
 8. Press the ENTER button.
If you selected the "YES", "COMPLETE!" is appeared on the screen when the MEMORY CARD formatting is finished.
 9. To exit the menu, push the MENU button.

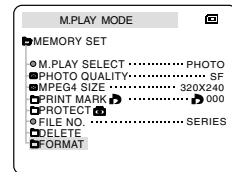
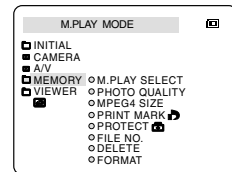

Note

- If you want to format the Memory Stick on your PC, use only the "MS formatter" supplied with the software CD.
- The MS formatter is exclusive program of the Memory Stick.

ENGLISH**Digital Still Camera mode****MPEG RECORDING**

- ❖ You can record moving picture images with audio on the Memory Card.

Saving the pictures captured by a camera as a moving picture file on MEMORY CARD

1. Check whether MEMORY CARD is inserted into the camcorder.
If it is not in the camcorder, insert it into the slot.
2. Set the mode switch to MEMORY CARD position.
3. Set the power switch to CAMERA mode.
4. Press the START/STOP button, the images are recorded on the MEMORY CARD in MPEG4.
 - You can record 10 ~ 20 seconds continuously in once by the recording object.
 - You can record a camera still image on Memory Card by pressing the Photo button instead of the START/STOP button.
5. Press the START/STOP button to stop the recording.

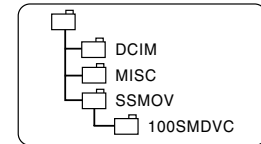
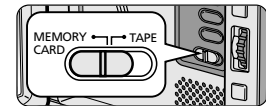
**Notes**

- Before using the MPEG REC function, check whether the MEMORY CARD is inserted into the camcorder.
- Moving pictures can be made in two sizes, 160 X 120 or 320 X 240 (Pixel).
- Moving images that you recorded are saved in *.asf file format on the Memory Card.
- The file that you recorded are saved in a following folder.
- The moving picture images on a Memory Card are smaller size and lower definition than one on Tape.
- The sound is recorded in type of mono.
- The following functions are not allowed in M.REC Mode.
 - DIS (Digital Image Stabilizer), Digital Zoom, Fade, Program AE, Digital Special Effect, Slow Shutter.
- While you record in Memory Card, don't insert or eject the tape as it may record noise.
- While you record in Memory Card, don't eject it or it might break the data on the Memory Card or Memory Card itself.

Digital Still Camera mode

Selecting the moving picture sizes

1. Set the mode switch to MEMORY CARD position.
2. Set the power switch to CAMERA mode.
3. Press the MENU button.
4. Turn the MENU DIAL to highlight MEMORY.
5. Press the ENTER button to enter the submenu.
6. Turn the MENU DIAL to highlight MPEG4 SIZE.
7. Press the ENTER button.
 - The MPEG4 SIZE toggles between 320 × 240 / 160 × 120 with each push.

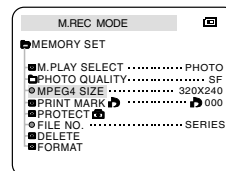
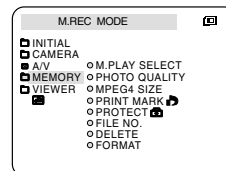

ENGLISH**Digital Still Camera mode****MPEG Playback**

- ❖ The MPEG Playback function works in M. PLAY mode only.
 - ❖ You can play the moving picture images on the Memory Card.
 - ❖ During the MPEG4 playback, you can hear sound at the PC speaker only.
(You cannot hear it from the speaker onto a camcorder and TV)
1. Set the mode switch to MEMORY CARD position.
 2. Set the power switch to PLAYER mode.
 3. Press the MENU button and turn the MENU DIAL to highlight MEMORY.
 4. Press the ENTER button to enter sub-menu.
 5. Use the MENU DIAL to select MPEG4 from the sub-menu. (M. PLAY SELECT)
 6. To exit the menu, push the MENU button.
 7. Using the ►► (FWD) and ◀◀ (REV) buttons, search for the moving picture that you want to playback.
 8. Press the PLAY/STILL button.
 - The moving pictures recorded on the MEMORY CARD are playing back.

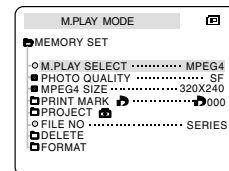
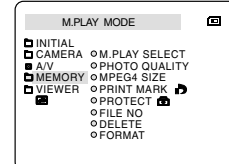
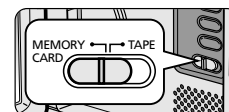
**Notes**

- There could be any broken or mosaic pictures while playing the MPEG4 moving picture images, but it is not malfunction.
- Sharp G.726 Audio Codec is automatically installed through Internet when you play the MPEG4 file.
- If sharp G.726 Audio Codec is not properly installed on your PC, it could not play Audio in the MPEG4 file.
- The moving picture images that you recorded on the Memory Card might not be allowed to play by the camcorder of another brands.
- The MPEG4 file recorded by another camcorder might not be allowed to play by this camcorder.
 - You need Microsoft Windows Media Player Version 9 or higher version and Sharp G.726 Audio Codec in order to play MPEG4 file on the Memory Card on your PC. (Microsoft Windows Media Player Version 9 (Eng) is included in the CD that is supplied.)
 - You can download the Microsoft Windows Media Player applied each languages on Microsoft Website, "<http://www.microsoft.com/windows/windowsmedia/download/default.asp>".

Maintenance

After finishing a recording

- ❖ At the end of a recording you must remove the power source.
 - ❖ When recording with a Lithium Ion Battery Pack, leaving the pack on the camcorder can reduce the life span of the battery. Hence, it should be removed from the camcorder.
1. Slide the TAPE EJECT switch in the direction of the arrow.
 - Opening the cassette door ejects the tape automatically.
 - Please wait while the tape is completely ejected.
 2. After removing the tape, close the door and store the camcorder in a dust free environment.
 - Dust and other foreign materials can cause square-shaped noise or jerky images.
 3. Set the power switch to the OFF mode.
 4. Disconnect the power source or remove the Lithium Ion Battery Pack.
 - Press the BATTERY RELEASE button and slide the battery pack in the direction of the arrow.

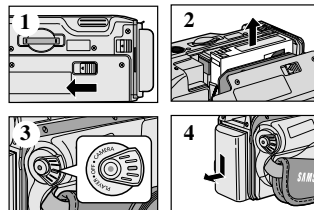

ENGLISH

Maintenance

Cleaning and Maintaining the Camcorder

Cleaning the Video Heads

To ensure normal recording and clear pictures, clean the video heads when the playback pictures display square block-shaped noise or distortion, or a blue screen appears.

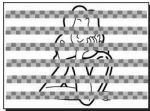

(blue screen)

1. Set the power switch to PLAYER mode.
2. Insert the cleaning tape.
3. Press the ►/II (PLAY/STILL) button.
4. Press the ■ (STOP) button after 10 seconds.

Notes

- Check the quality of the picture using a videocassette.
If the picture quality has not improved, repeat the operation.
If the problem continues, contact your local authorized service center.
- Clean the video heads with a dry type cassette cleaner.

Maintenance

Using Your Camcorder Abroad

- ❖ Each country or region has its own electric and color systems.
- ❖ Before using your camcorder abroad, check the following items.

Power sources

- You can use your camcorder in any country or area with the supplied AC Power Adapter within 100V to 240V, 50/60 Hz.
- Use a commercially available AC plug Adapter, if necessary, depending on the design of the local wall outlet.

Color system

- You can view your recording in the viewfinder.
However, to view it on a television or copy it to a videocassette recorder, the television or VCR must be NTSC-compatible and have the appropriate audio/video jacks.
Otherwise, you may need to use a transcoder.

● PAL-compatible Countries/Regions

Australia, Austria, Belgium, Bulgaria, China, CIS, Czech Republic, Denmark, Egypt, Finland, France, Germany, Greece, Great Britain, Holland, Hong Kong, Hungary, India, Iran, Iraq, Kuwait, Libya, Malaysia, Mauritius, Norway, Romania, Saudi Arabia, Singapore, Slovak Republic, Spain, Sweden, Switzerland, Syria, Thailand, Tunisia, etc.

● NTSC-compatible Countries/Regions

Bahamas, Canada, Central America, Japan, Korea, Mexico, Philippines, Taiwan, United States of America, etc.



Note

You can make recordings with your camcorder and view pictures on the LCD from anywhere in the world.

ENGLISH**Troubleshooting****Troubleshooting**

- ❖ Before contacting a Samsung authorized service center, perform the following simple checks. They may save you the time and expense of an unnecessary call.

Self Diagnosis Display

Display	Blinking	Informs that...	Action
	slow	the battery pack is almost discharged.	Change to a charged one.
TAPE END!	slow	When the remaining time on the tape is about 2 minutes	Prepare a new one.
TAPE END!	no	the tape reached its end.	Change to a new one.
TAPE!	slow	there is no tape in camcorder.	Insert a tape.
PROTECTION!	slow	the tape is protected from recording.	If you want to record, release the protection.
	slow	the camcorder has some mechanical fault.	1. Eject the tape. 2. Set to OFF. 3. Detach the battery. 4. Reattach the battery. * If unresolved contact your local service representative.
	slow	moisture condensation has formed in the camcorder.	see below.

Moisture Condensation

- ❖ If the camcorder is brought directly from a cold place to a warm place, moisture may condense inside the camcorder, on the surface of the tape, or on the lens. In this condition, the tape may stick to the head drum and be damaged or the unit may not operate correctly.
To prevent possible damage under these circumstances, the camcorder is fitted with a moisture sensor.
- ❖ If there is moisture inside the camcorder,  (DEW) is displayed. If this happens, none of the functions except cassette ejection will work.
Open the cassette compartment and remove the battery.
Leave the camcorder for at least two hours in a dry warm room.

Troubleshooting

Self Diagnosis Display in M.REC/M.PLAY mode

Display	Blinking	Informs that...	Action
MEMORY CARD!	slow	There is no Memory Card in the camcorder.	Insert a Memory Card.
MEMORY FULL!	slow	There is not enough memory to record.	Change to a new Memory Card. Erase recorded image.
NO STORED PHOTO! or NO STORED MPEG!	slow	There are no images recorded on the Memory Card.	Record new images.
WRITE PROTECT!	slow	The Memory Card is record protected.	Release the write protect tab on the Memory Card.
PROTECT!	slow	When you try to delete to protected image.	Cancel the protection of image.
READ ERROR!	slow	The camera can not playback.	Format a Memory Card or insert Memory Card recorded on this camcorder.
WRITE ERROR!	slow	The camera can not record.	Format a Memory Card or change to a new Memory Card.
NOT FORMATTED!	slow	The Memory Card needs to format.	Format a Memory Card. (see page 95)
NOW DELETE...	slow	When progressing FILE DELETE.	Wait until Delete has been finished.
NOW FORMAT...	slow	When progressing MEMORY FORMAT.	Wait until format has been finished.
NOW COPY...	slow	When progressing FILE COPY.	Wait until copy has been finished. Or press the stop button.

ENGLISH**Troubleshooting**

❖ If these instructions do not solve your problem, contact your nearest Samsung authorized service center.

Symptom	Explanation/Solution
You cannot switch the camcorder on.	Check the battery pack or the AC Power Adapter.
START/STOP button does not operate while recording.	Check the POWER switch is set to CAMERA. You have reached the end of the cassette. Check the record protection tab on the cassette.
The camcorder goes off automatically.	You have left the camcorder set to STBY for more than 5 minutes without using it. The battery pack is fully exhausted.
The battery pack is quickly exhausted.	The atmospheric temperature is too low. The battery pack has not been charged fully. The battery pack is completely dead, and cannot be recharged. Use another battery pack.
When you see a blue screen during playback.	The video heads may be dirty. Clean the head with a cleaning tape.
A vertical strip appears on the screen when recording a dark background.	The contrast between the subject and the background is too great for the camcorder to operate normally. Make the background bright to reduce the contrast or use the BLC function while you are recording brighter.
The image in the viewfinder is blurred.	The Viewfinder lens has not been adjusted. Adjust the viewfinder control lever until the indicators displayed on the viewfinder come into sharp focus.
Auto focus does not work.	Check the M.FOCUS menu. Auto focus does not work in the Manual Focus mode.
Play, FF or REW button does not work.	Check the POWER switch. Set the power switch to PLAYER. You have reached the beginning or end of the cassette.
When you see a broken block image during the RECORD SEARCH.	This is normal operation and it is not a failure or defect.

Specifications

Model name: SCD103/D105

System	
Video signal	NTSC
Video recording system	2 rotary heads, Helical scanning system
Audio recording system	Rotary heads, PCM system
Usable cassette	Digital video tape (6.35mm width): Mini DV cassette
Tape speed	SP: approx. 18.81mm/s LP: approx. 12.56mm/s
Tape recording time	SP: 60 minutes (when using DVM 60), LP: 90 minutes (when using DVM 60)
FF/REW time	Approx. 150 sec. (using DVM60 tape)
Image device	CCD (Charge Coupled Device)
Lens	F1.4 18x(Optical), 900x(Digital) Electronic zoom lens
Filter diameter	Ø30
LCD monitor/Viewfinder	
Size/dot number	2.5inchs 112k
LCD monitor Method	TFT LCD
Viewfinder	B/W LCD
Connectors	
Video output	1Vp-p (75Ω terminated)
S-video output	Y: 1Vp-p, 75Ω, C: 0. 286Vp-p, 75Ω
Audio output	-7.5dBs (600Ω terminated)
DV input/output	4pin special in/out connector
USB output	Mini-B type connector
External mic	Ø3.5 stereo

General	
Power source	DC 8.4V, Lithium Ion Battery Pack 7.4V
Power source type	Lithium Ion Battery Pack, Power supply (100V~240V) 50/60Hz
Power consumption (Recording)	5.0W(LCD), 4.6W(Viewfinder)
Operating temperature	0°~40°C (32°F~104°F)
Storage temperature	-20°C ~ 60°C (-4°F ~ 140°F)
External dimension	Height 3.44inches(87.5mm), Length 5.90inches(150mm), Width 2.16inches(55mm)
Weight	480g (Except for Lithium Ion Battery Pack and tape)
Built-in MIC	Omni-directional stereo condenser microphone
Remote control (SCD105 only)	Indoors: greater than 49ft(15m) (straight line), Outdoors: about 16.4ft(5m) (straight line)

- These technical specifications and design may be changed without notice.

ENGLISH**INDEX**

- A -	
Accessories	12
AF/MF	60
Audio dubbing	63
AUDIO MODE	51
- B -	
Battery Pack	24
BLC	61
- C -	
Cassette	27
Cleaning	100
CLOCK SET	39
Connecting	71
- D -	
DATE/TIME	53
DC Cable	23
Deleting	94
DEMONSTRATION	41
DIS	47
DSE	48
DV	77, 78
- E -	
EASY Mode	59
EXPOSURE	57
- F -	
Fade	62
Formatting	95
Frame advance	73
Functions buttons	14
- H -	
Hand Strap	22
- I -	
IEEE1394	77
- L -	
LCD	31, 32
- M -	
Memory Card	83
Memory Stick	82
MPEG RECORDING	96
MPEG SIZE	97

- O -	
OSD	18, 19
- P -	
PB DSE	75
PHOTO copy	91
PHOTO quality	86
PHOTO SEARCH	65
PROGRAM AE	42
Protection	93
- Q -	
Quick Menu	55
- R -	
REC MODE	50
REC Search	30
Remote control	17, 20
- S -	
SHUTTER SPEED	56
Sound	35
Speaker	35
Still images	89
- T -	
Tele MACRO	45
TV DISPLAY	54
- U -	
USB	79
- V -	
Viewfinder	31, 33
- W -	
WHT. BALANCE	44
WIND CUT	52
WL. REMOTE	40
- Z -	
ZERO MEMORY	74
Zoom	45, 46

Warranty (SEA users only)

SAMSUNG LIMITED WARRANTY

SAMSUNG Electronics America Inc. (SEA), warrants that this product is free from defective material and workmanship. SEA further warrants that if product fails to operate properly within the specified warranty period and the failure is due to improper workmanship or defective material, SEA will repair or replace the product at it's option.

All warranty repairs must be performed by a SEA authorized service center. The name and address of the location nearest you can be obtained by calling toll free: 1-800 SAMSUNG (1-800-726-7864).

Labor

90 days carry-in

Parts

1 year

On carry-in models, transportation to and from the service center is the customer's responsibility.

The original dated sales receipt must be retained by the customer and is the only acceptable proof of purchase. It must be presented to the authorized service center.

EXCLUSIONS (WHAT IS NOT COVERED)

This warranty does not cover damage due to accident, fire, flood and/or other acts of God; misuse, incorrect line voltage, improper installation, improper or unauthorized repairs, commercial use, or damage that occurs in shipping. Exterior and interior finish, lamps, and glass are not covered under this warranty.

Customer adjustments which are explained in the instruction manual are not covered under the terms of this warranty.

This warranty will automatically be voided for any unit found with a missing or altered serial number. This warranty is valid only on products purchased in the United States and Puerto Rico.

Some States do not allow the exclusions or limitations of incidental or consequential damages, or allow limitations on how long an implied warranty lasts, so the above limitations or exclusions may not apply to you.

This warranty gives you specific legal rights, and you may also have other rights which vary from State to State.

ENGLISH

THIS CAMCORDER IS MANUFACTURED BY:



SERVICE DIVISION
400 Valley Road, Suite 201, Mt. Arlington N.J. 07856
Tel: 1-800-SAMSUNG
(1-800-726-7864)

***Samsung Electronics' Internet Home Page**

<http://www.samsungusa.com>

AD68-00743R

Free Manuals Download Website

<http://myh66.com>

<http://usermanuals.us>

<http://www.somanuals.com>

<http://www.4manuals.cc>

<http://www.manual-lib.com>

<http://www.404manual.com>

<http://www.luxmanual.com>

<http://aubethermostatmanual.com>

Golf course search by state

<http://golfingnear.com>

Email search by domain

<http://emailbydomain.com>

Auto manuals search

<http://auto.somanuals.com>

TV manuals search

<http://tv.somanuals.com>