



DVD Player

DVD-HD960



Important Safety Instructions

- 1) Read these instructions.
- 2) Keep these instructions.
- 3) Heed all warnings.
- 4) Follow all instructions.
- 5) Do not use this apparatus near water.
- 6) Clean only with dry cloth.
- 7) Do not block any ventilation openings, Install in accordance with the manufacturer's instructions.
- 8) Do not install near any heat sources such as radiators, heat registers, or other apparatus (including amplifiers) that produce heat.
- 9) Do not defeat the safety purpose of the polarized or grounding- type plug. A polarized plug has two blades with one wider than the other. A grounding type plug has two blades and a third grounding prong. The wide blade or the third prong are provided for your safety. If the provided plug does not fit into your outlet, consult an electrician for replacement of the obsolete outlet.
- 10) Protect the power cord from being walked on or pinched particularly at plugs, convenience receptacles, and the point where they exit from the apparatus.
- 11) Only use attachments/accessories specified by the manufacturer.
- 12) Use only with cart, stand, tripod, bracket, or table specified by the manufacturer, or sold with the apparatus.
- 13) Unplug this apparatus. When a cart is used, use caution when moving the cart/apparatus combination to avoid injury from tip-over.
- 14) Refer all servicing to qualified service personnel. Servicing is required when the apparatus has been damaged in any way, such as power-supply cord or plug is damaged, liquid has been spilled or objects have fallen into the apparatus the apparatus has been exposed to rain or moisture, does not operate normally, or has been dropped.



Precautions



TO REDUCE THE RISK OF ELECTRIC SHOCK, DO NOT REMOVE THE COVER(OR BACK). NO USER-SERVICEABLE PARTS ARE INSIDE. REFER SERVICING TO QUALIFIED SERVICE PERSONNEL.



This symbol indicates “dangerous voltage” inside the product that presents a risk of electric shock or personal injury.



This symbol indicates important instructions accompanying the product.

Do not install this equipment in a confined space such as a bookcase or similar unit.

WARNING : To prevent damage which may result in fire or electric shock hazard, do not expose this appliance to rain or moisture.

CAUTION : DVD PLAYERS USE AN INVISIBLE LASER BEAM WHICH CAN CAUSE HAZARDOUS RADIATION EXPOSURE IF DIRECTED.
BE SURE TO OPERATE PLAYER CORRECTLY AS INSTRUCTED.

CAUTIONS

Caution: To prevent electric shock, match wide blade of plug to wide slot, fully insert.

Attention: Pour éviter les chocs électriques, introduire la lame la plus large de la fiche dans la borne correspondante de la prise et pousser jusqu'au fond.

This product satisfies FCC regulations when shielded cables and connectors are used to connect the unit to other equipment. To prevent electromagnetic interference with electric appliances, such as radios and televisions, use shielded cables and connectors for connections.

FCC NOTE (for U.S.A):

This equipment has been tested and found to comply with the limits for a Class B digital device, pursuant to Part 15 of the FCC rules. These limits are designed to provide reasonable protection against harmful interference in a residential installation. This equipment generates, uses and can radiate radio frequency energy and, if not installed and used in accordance with the instructions, may cause harmful interference to radio or television reception, which can be determined by turning the equipment off and on.

The user is encouraged to try to correct the interference by one or more of the following measures.

- Reorient or relocate the receiving antenna.
- Increase the separation between the equipment and receiver.
- Connect this equipment into an outlet on a circuit different from that to which the receiver is connected.
- Consult the dealer or an experienced radio/TV technician for help.

This class B digital apparatus meets all requirements of the Canadian Interference --
Causing Equipment Regulations.

CLASS 1 LASER PRODUCT
KLASSE 1 LASER PRODUKT
LUOKAN 1 LASER LAITE
KLASS 1 LASER APPARAT
PRODUCTO LÁSER CLASE 1

CAUTION

THIS PRODUCT UTILIZES A LASER. USE OF CONTROLS OR ADJUSTMENTS OR PERFORMANCE OF PROCEDURES OTHER THAN THOSE SPECIFIED HEREIN MAY RESULT IN HAZARDOUS RADIATION EXPOSURE. DO NOT OPEN COVER AND DO NOT REPAIR YOURSELF. REFER SERVICING TO QUALIFIED PERSONNEL.

Note:

- This unit can be used only where the power supply is AC 120V, 60Hz. It cannot be used elsewhere.
- This DVD player is designed and manufactured to respond to the Region Management Information. If the Region number of a DVD disc does not correspond to the Region number of this DVD player, the DVD player cannot play the disc.
- The product unit accompanying this user manual is licensed under certain intellectual property rights of certain third parties. In particular, this product is licensed under the following US patents: 5,991,715, 5,740,317, 4,972,484, 5,214,678, 5,323,396, 5,539,829, 5,606,618, 5,530,655, 5,777,992, 6,289,308, 5,610,985, 5,481,643, 5,544,247, 5,960,037, 6,023,490, 5,878,080, and under US Published Patent Application No. 2001-44713-A1.

This license is limited to private non-commercial use by end-user consumers for licensed contents. No rights are granted for commercial use. The license does not cover any product unit other than this product unit and the license does not extend to any unlicensed product unit or process conforming to ISO/IEC 11172-3 or ISO/IEC 13818-3 used or sold in combination with this product unit.

The license only covers the use of this product unit to encode and/or decode audio files conforming to the ISO/IEC 11172-3 or ISO/IEC 13818-3. No rights are granted under this license for product features or functions that do not conform to the ISO/IEC 11172-3 or ISO/IEC 13818-3.

Handling Cautions

- Before connecting other components to this player, be sure to turn them all off.
- Do not move the player while a disc is being played, or the disc may be scratched or broken, and the player's internal parts may be damaged.
- Do not put a flower vase filled with water or any small metal objects on the player.
- Be careful not to put your hand into the disc tray.
- Do not place anything other than the disc in the disc tray.
- Exterior interference such as lightning and static electricity can affect normal operation of this player. If this occurs, turn the player off and on again with the POWER button, or disconnect and then reconnect the AC power cord to the AC power outlet. The player will operate normally.
- Be sure to remove the disc and turn off the player after use.
- Disconnect the AC power cord from the AC outlet when you don't intend to use the player for long periods of time.
- Clean the disc by wiping in a straight line from the inside to the outside of the disc.

Disc Storage

Be careful not to harm the disc because the data on these discs is highly vulnerable to the environment.

- Do not keep under direct sunlight.
- Keep in a cool ventilated area.
- Store vertically.
- Keep in a clean protection jacket.

Maintenance of Cabinet

For safety reasons, be sure to disconnect the AC power cord from the AC outlet.

- Do not use benzene, thinner, or other solvents for cleaning.
- Wipe the cabinet with a soft cloth.

Before you start

Accessories



Remote Control
(AK59-00055D)



Batteries for Remote Control (AAA Size)
(AC43-12002H)

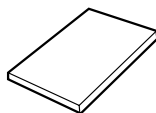

User's Manual
(AK68-01038D)



Video/Audio Cable
(AC39-42001R)

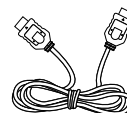

HDMI Cable
(MF39-00299A)

Install Batteries in the Remote control

1

Open the battery cover on the back of the remote control.

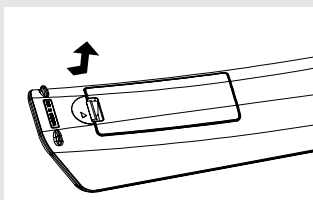

2

Insert two AAA batteries. Make sure that the polarities (+ and -) are aligned correctly.

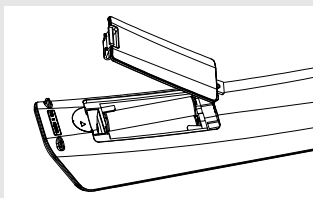

3

Replace the battery cover.

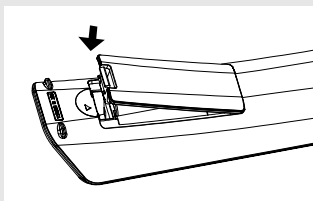

If the remote control doesn't operate properly:

- Check the polarity + - of the batteries (Dry-Cell)
- Check if the batteries are drained.
- Check if remote control sensor is blocked by obstacles.
- Check if there is any fluorescent lighting nearby.

TABLE OF CONTENTS

Important Safety Instructions	2
Precautions	3
Before you start	5
Chapter 1: Setup	
General Features	7
Disc Type and Characteristics	8
Description	9
Tour of the Remote Control	11
Chapter 2: Connections	
Choosing a Connection	12
Chapter 3: Basic Functions	
Playing a Disc	20
Using the Search and Skip Functions	22
Using the Display Function	23
Using the Disc and Title Menu	24
Using the Function Menu	25
Repeat Play	26
Slow Play	27
Chapter 4: Advanced Functions	
Adjusting the Aspect Ratio (EZ View)	28
Selecting the Audio Language	30
Selecting the Subtitle Language	31
Changing the Camera Angle	32
Using the Instant Replay/Skip Function	33
Using the Bookmark Function	34
Using the Zoom Function	36
Clips Menu for MP3/WMA/JPEG/MPEG4/CD Audio	37
Folder Selection	37
MP3/WMA/CD Audio Playback	38
MPEG4 Playback	40
Picture CD Playback	42
Chapter 5: Changing Setup Menu	
Using the Setup Menu	44
Setting Up the Language Features	45
Setting Up the Audio Options	50
Setting Up the Display Options	52
Setting Up the Parental Control	55
Chapter 6: Reference	
Controlling a TV with the Remote control	58
Firmware upgrade	59
Troubleshooting	60
Specifications	62

Chapter 1

SETUP

General Features

Excellent Sound

Dolby Digital, a technology developed by Dolby Laboratories, provides crystal clear sound reproduction.

Screen

Both regular and widescreen(16:9) pictures can be viewed.

Slow Motion

An important scene can be viewed in slow motion.

Parental Control (DVD)

The parental control allows users to set the level necessary to prohibit children from viewing harmful movies such as those with violence, adult subject matter, etc.

Various On-Screen Menu Functions

You can select various languages (Audio/Subtitle) and screen angles while enjoying movies.

Progressive Scan

Progressive scanning creates an improved picture with double the scan lines of a conventional interlaced picture.

EZ VIEW (DVD)

Easy View enables picture adjustment to match your TV's screen size (16:9 or 4:3).

Digital Photo Viewer (JPEG)

You can view Digital Photos on your TV.

Repeat

You can repeat a song or movie simply by pressing the REPEAT button.

MP3/WMA

This unit can play discs created from MP3/WMA files.

Instant Replay (DVD)

This function is used to replay the previous 10 seconds of a movie from the current position.

Instant Skip (DVD)

This function skips playback ahead 10 seconds.

MPEG4

This unit can play MPEG4 formats within an avi file.

HDMI (High Definition Multimedia Interface)

HDMI reduces picture noise by allowing a pure digital video/audio signal path from the player to your TV.

Note

- Discs which cannot be played with this player.
 - DVD-ROM
 - DVD-RAM
 - CD-ROM
 - CDV
 - CDI
 - CVD
 - Super Audio CD(except CD layer)
 - CDGs play audio only, not graphics.
- Ability to play back may depend on recording conditions.
 - DVD-R, +R
 - CD-RW
 - DVD+RW, -RW (V mode)
- The unit may not play certain CD-R, CD-RW and DVD-R due to the disc type or recording conditions.

COPY PROTECTION

Many DVD discs are encoded with copy protection. Because of this, you should only connect your DVD player directly to your TV, not to a VCR. Connecting to a VCR results in a distorted picture from copy-protected DVD discs.

This product incorporates copyright protection technology that is protected by methods claims of certain U.S. patents and other intellectual property rights owned by Macrovision Corporation and other rights owners. Use of this copyright protection technology must be authorized by Macrovision Corporation, and is intended for home and other limited viewing uses only unless otherwise authorized by Macrovision Corporation. Reverse engineering or disassembly is prohibited.

PROGRESSIVE SCAN OUTPUTS (525p)



"CONSUMERS SHOULD NOTE THAT NOT ALL HIGH DEFINITION TELEVISION SETS ARE FULLY COMPATIBLE WITH THIS PRODUCT AND MAY CAUSE ARTIFACTS TO BE DISPLAYED IN THE PICTURE, IF 525 PROGRESSIVE SCAN PICTURE PROBLEMS OCCUR, IT IS RECOMMENDED THAT THE USER SWITCH THE CONNECTION TO THE 'STANDARD DEFINITION' OUTPUT. IF THERE ARE QUESTIONS REGARDING YOUR TV SET COMPATIBILITY WITH THIS MODEL 525p DVD PLAYER, PLEASE CONTACT SAMSUNG'S CUSTOMER SERVICE CENTER."

ENG-7







SETUP

Disc Type and Characteristics

This DVD player is capable of playing the following types of discs with the corresponding logos:

Disc Types (Logos)	Recording Types	Disc Size	Max. Playing Time	Characteristics
DVD 	Audio + Video	5"	Single-sided 240 min. Double-sided 480 min.	<ul style="list-style-type: none"> - DVD contains excellent sound and video due to Dolby Digital and MPEG-2 system. - Various screen and audio functions can be easily selected through the on-screen menu.
		3 1/2"	Single-sided 80 min. Double-sided 160 min.	
VIDEO-CD 	Audio + Video	5"	74 min.	<ul style="list-style-type: none"> - Video with CD sound, VHS quality & MPEG-1 compression technology.
		3 1/2"	20 min.	
AUDIO-CD 	Audio	5"	74 min.	<ul style="list-style-type: none"> - CD is recorded as a Digital Signal with better audio quality, less distortion and less deterioration of audio quality over time.
		3 1/2"	20 min.	

Disc Markings

	Play Region Number
	NTSC broadcast system in U.S.A, Canada, Korea, Japan, etc.
	Dolby Digital disc
	Stereo disc
	Digital Audio disc
	DTS disc
	MP3 disc

You must only insert one DVD disc at a time. Inserting two or more discs will not allow playback and may cause damage to the DVD player.

Region Number

Both the DVD player and the discs are coded by region. These regional codes must match in order for the disc to play. If the codes do not match, the disc will not play.

The Region Number for this player is described on the rear panel of the player.

DivX Certification

DivX, DivX Certified, and associated logos are trademarks of DivXNetworks, Inc and are used under license.



SETUP

Description

Front Panel Controls

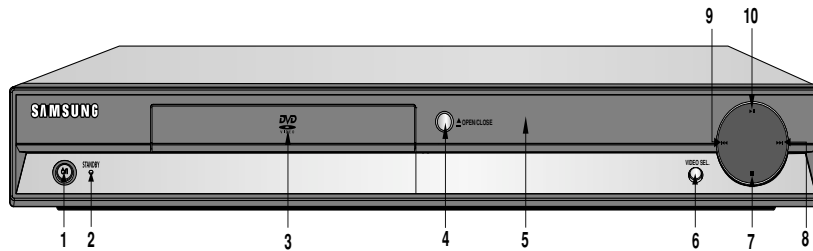

- 1. STANDBY/ON (⏻)**
When STANDBY/ON is pressed on, the indicator goes out and the player is turned on.
- 2. STANDBY Indicator**
When the unit is first plugged in, the indicator lights.
- 3. DISC TRAY**
Place the disc here.
- 4. OPEN/CLOSE (⏏)**
Press to open and close the disc tray.
- 5. DISPLAY**
Operation indicators are displayed here.
- 6. VIDEO SEL.**
Press to change Video output mode (Progressive ON or Progressive OFF).
- 7. STOP (■)**
Stops disc play.
- 8. SKIP (▶▶) / SEARCH**
Use to forward skip a scene or music.
- 9. SKIP (◀◀) / SEARCH**
Use to reverse skip a scene or music.
- 10. PLAY/PAUSE (▶||)**
Begin or pause disc play.

Front Panel Display

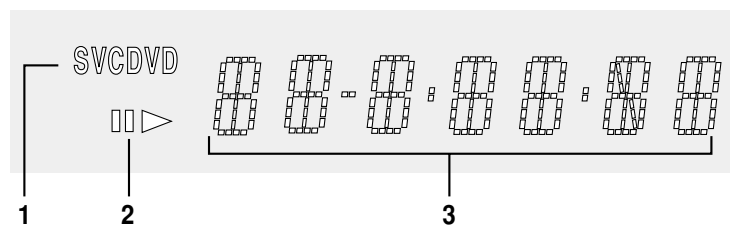

- 1. Disc type indicators**
- 2. Play / Pause**
- 3. Displays various messages concerning operations such as PLAY, STOP, LOAD ...**
no DISC: No disc loaded.
OPEN: The disc tray is open.
LOAD: Player is loading disc information.

SETUP

Rear Panel

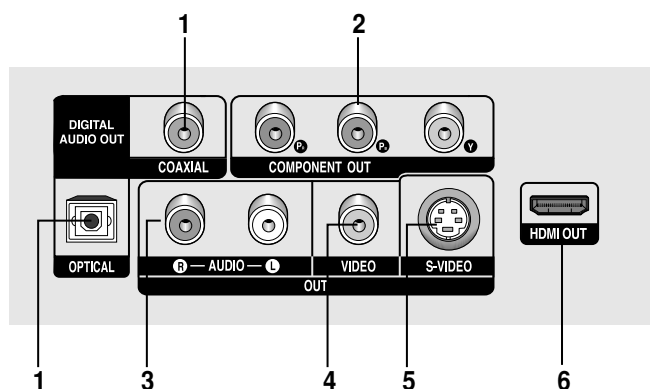

1. DIGITAL AUDIO OUT JACKS

- Use either an optical or coaxial digital cable to connect to a compatible Dolby Digital receiver.
- Use either an optical or coaxial digital cable to connect to an A/V Amplifier that contains a Dolby Digital, MPEG2 or DTS decoder.

2. COMPONENT VIDEO OUT JACKS

- Use these jacks if you have a TV with Component Video in jacks. These jacks provide P_R, P_B and Y video.
- If Progressive Out is set ON in Video Output of the Setup Menu, progressive scan mode will work.
- If Progressive Out is set OFF in Video Output of the Setup Menu, interlaced scan mode will work.

3. AUDIO OUT JACKS

Connect to the Audio input jacks of your television or audio/video receiver

4. VIDEO OUT JACK

- Use a video cable to connect to the Video input jack on your television.

5. S-VIDEO OUT JACK

- Use the S-Video cable to connect this jack to the S-Video jack on your television for higher picture quality.

6. HDMI OUT JACK

- Use the HDMI cable to connect this jack to the HDMI jack on your television for the best quality picture.
- If an HDMI cable is connected to an HDMI-compatible TV, HDMI will be output automatically a maximum of 10 seconds later.

Note

- Consult your TV User's Manual to find out if your TV supports Progressive Scan (P-SCAN). If Progressive Scan is supported, follow the TV User's Manual regarding Progressive Scan settings in the TV's menu system.
- If Progressive Out On Video Output is selected in Setup Menu, Video and S-Video Outputs do not work.
- The HDMI output of this unit can be connected to a DVI jack on a TV or other device using a conversion adapter. In this case, it is necessary to use a TV or display with an HDCP-compatible DVI input.
- There may be no image output if the DVD player is connected to a TV or display that is not compatible with the above format.
- Refer to the TV's instruction manual for detailed information regarding the HDMI terminal.
- See pages 52 ~ 54 to get more information on how to use the setup menu.

SETUP

Tour of the Remote Control

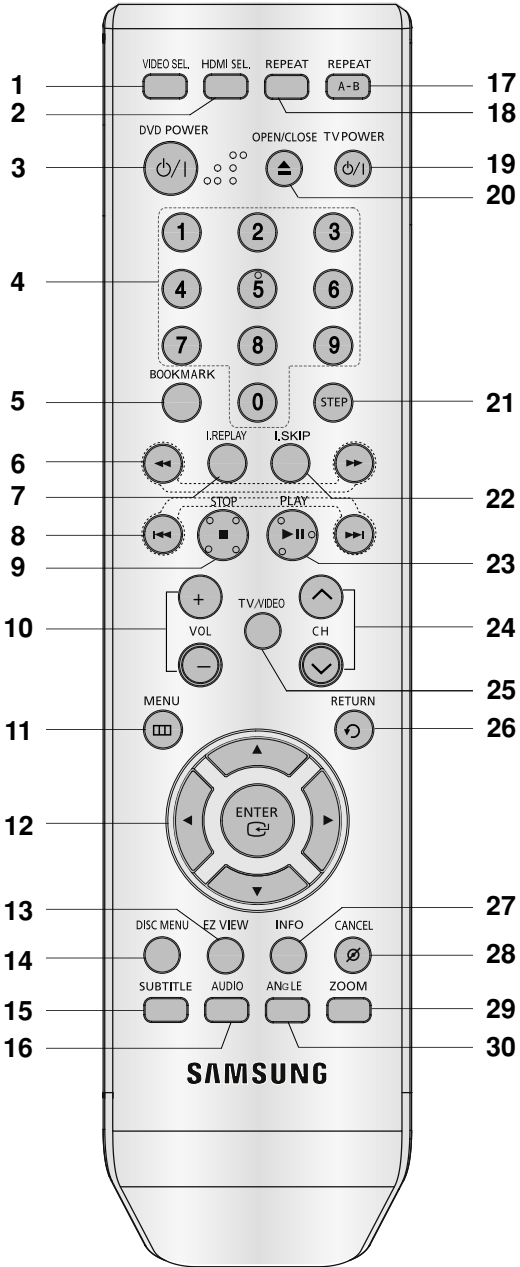

1. **VIDEO SEL. Button**
Selects video output formats
2. **HDMI SEL. Button**
HDMI Output resolution setup.
3. **DVD POWER Button**
Turns the power on or off.
4. **NUMBER Buttons**
5. **BOOKMARK Button**

6. **SEARCH Buttons (◀◀ / ▶▶)**
Allow you to search forward/backward through a disc.
7. **INSTANT REPLAY Button**
This function is used to replay the previous 10 seconds of a movie from the current position.
8. **SKIP Buttons (◀◀ / ▶▶)**
Use to skip the title, chapter or track.
9. **STOP Button (■)**
10. **VOL (+, -) Buttons**
Control volume.
11. **MENU Button**
Brings up the DVD player's menu.
12. **ENTER/▲/▼, ◀/▶ Buttons**
This button functions as a toggle switch.
13. **EZ VIEW Button**
The aspect ratio of a picture can easily be adjusted according to the screen size of your TV (16:9 or 4:3).
14. **DISC MENU Button**
Brings up the Disc menu.
15. **SUBTITLE Button**
16. **AUDIO Button**
Use this button to access various audio functions on a disc.
17. **REPEAT A-B Button**
Allows you to repeat play A-B disc
18. **REPEAT Button**
Allows you to repeat play a title, chapter, track, or disc.
19. **TV POWER Button**
Turns the TV's power on or off.
20. **OPEN/CLOSE (▲) Button**
To open and close the disc tray.
21. **STEP Button**
Advances play one frame at a time.
22. **INSTANT SKIP Button**
This function skips playback ahead 10 seconds.
23. **PLAY/PAUSE Button (▶||)**
Begin/Pause disc play.
24. **CH (▲, ▼) Buttons**
Channel selection.
25. **TV/VIDEO Button**
Press to display all of the available video sources (i.e., TV, Cable, Video)
26. **RETURN Button**
Returns to a previous menu.
27. **INFO Button**
Displays the current disc mode.
28. **CANCEL Button**
Use to remove menus or status displays from the screen.
29. **ZOOM Button**
Enlarges the DVD Picture
30. **ANGLE Button**
Use to access various camera angles on a DVD.

Chapter 2

CONNECTIONS

Choosing a Connection

The following shows examples of connections commonly used to connect the DVD player with a TV and other components.

Before Connecting the DVD Player

- Always turn off the DVD player, TV, and other components before you connect or disconnect any cables.
- Refer to the user's manual of the additional components (such as a TV) you are connecting for more information on those particular components.

Connection to a TV (Video)

1

Using video/audio cables, connect the **VIDEO (yellow)/AUDIO (red and white) OUT** terminals on the rear of the DVD player to the **VIDEO (yellow)/AUDIO (red and white) IN** terminals of your TV.

2

Turn on the DVD player and TV.

3

Press the input selector on your TV remote control until the Video signal from the DVD player appears on the TV screen.

4

You can also use the **VIDEO SEL.** button to change the Video Output mode. (See page 12)

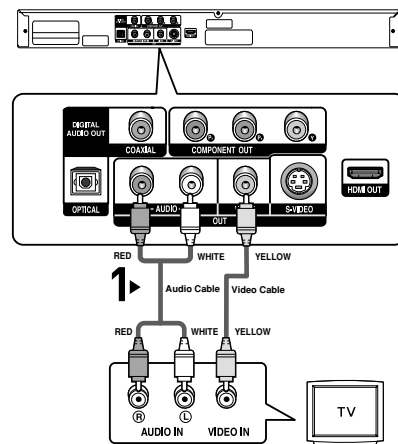

Note

- **Noise may be generated if the audio cable placed too close to the power cable.**
- If you want to connect to an Amplifier, please refer to the Amplifier connection page. (See pages 18 to 19)
- The number and position of terminals may vary depending on your TV set. Please refer to the user's manual of your TV.
- If there is one audio input terminal on the TV, connect it to the [AUDIO OUT][left] (white) terminal of the DVD player.
- If you press the VIDEO SEL. button when DVD Player is in stop mode or no disc is inserted, the Video Output mode changes in the following sequence: (Progressive : ON → Progressive : OFF).

CONNECTIONS

Connection to a TV (S-Video)

- Connecting to your TV using an S-Video cable.
- You will enjoy high quality images. S-Video separates the picture element into black and white(Y) and color(C) signals to present clearer images than regular video input mode. (Audio signals are delivered through the audio output.)

1

Using an S-Video cable (not included), connect the **S-VIDEO OUT** terminal on the rear of the DVD player to the **S-VIDEO IN** terminal of your TV.

2

Using the audio cables, connect the **AUDIO (red and white) OUT** terminals on the rear of the DVD player to the **AUDIO (red and white) IN** terminals of your TV. Turn on the DVD player and TV.

3

Press the input selector on your TV remote control until the S-Video signal from the DVD player appears on your TV screen.

4

Set the Video Output to **Progressive Out Off** in the Display Setup menu. (See pages 52 to 54)
You can use the **VIDEO SEL.** button to change the Video Output mode. (See page 12)

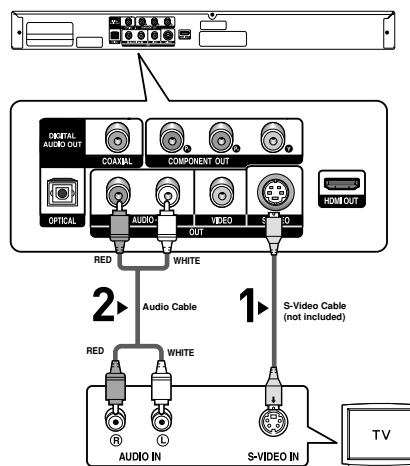

Note

- If you want to connect to an Amplifier, please refer to the Amplifier connection page. (See pages 18 to 19)
- The number and position of terminals may vary depending on the TV set. Please refer to the user's manual of your TV.
- Please do not connect S-Video and Component Video (Y, Pb, Pr) output simultaneously, as they may interfere and degrade both video output quality.

CONNECTIONS

Connection to a TV (Interlace)

- Connecting to your TV using Component video cables.
- You will enjoy high quality and accurate color reproduction images. Component video separates the picture element into black and white(Y), blue(P_B), red(P_R) signals to present clear and clean images. (Audio signals are delivered through the audio output.)

1

Using component video cables (not included), connect the **COMPONENT VIDEO OUT** terminals on the rear of the DVD player to the **COMPONENT IN** terminals of your TV.

2

Using the audio cables, connect the **AUDIO (red and white) OUT** terminals on the rear of the DVD player to the **AUDIO (red and white) IN** terminals of your TV. Turn on the DVD player and TV.

3

Press the input selector on your TV remote control until the Component signal from the DVD player appears on the TV screen.

4

Set the Video Output to **Progressive Out Off** in the Display Setup menu. (See pages 52 to 54)
You can use the **VIDEO SEL.** button to change the Video Output mode. (See page 12)

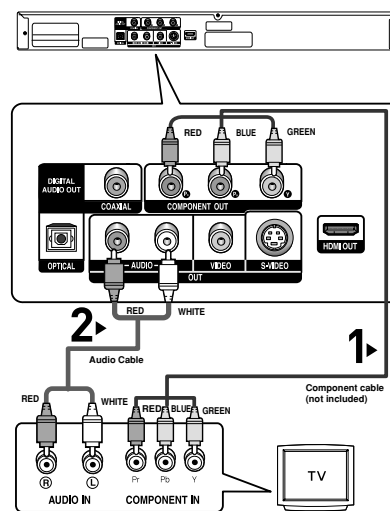

Note

- If you want to connect to an Amplifier, please refer to the Amplifier connection page. (See pages 18 to 19)
- The component terminal of your TV may be marked "R-Y, B-Y, Y" or "Cr, Cb, Y" instead of "P_R, P_B, Y" depending on the manufacturer. The number and position of terminals may vary depending on the TV set. Please refer to the user's manual of your TV.

CONNECTIONS

Connection to a TV (Progressive)

1

Using component video cables (not included), connect the **COMPONENT VIDEO OUT** terminals on the rear of the DVD player to the **COMPONENT IN** terminals of your TV.

2

Using the audio cables, connect the **AUDIO (red and white) OUT** terminals on the rear of the DVD player to the **AUDIO (red and white) IN** terminals of your TV. Turn on the DVD player and TV.

3

Press the input selector on your TV remote control until the Component signal from the DVD player appears on the TV screen.

4

Set the Video Output to **Progressive Out ON** in the Display Setup menu. (See pages 52 to 54)
You can use the **VIDEO SEL.** button to change the Video Output mode. (See page 12)

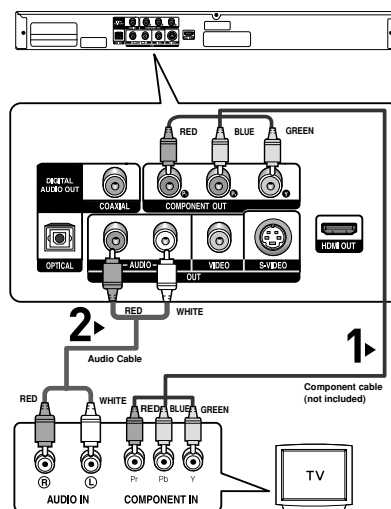

Connections

To see the progressive video output,

- Consult your TV User's Manual to find out if your TV supports Progressive Scan. If Progressive Scan is supported, follow the TV User's Manual regarding Progressive Scan settings in the TV's menu system.
- Depending on your TV, the connection method may differ from the illustration above.

Note

- What is "Progressive Scan"?
Progressive scan has twice as many scanning lines as the interlace output method. Progressive scanning method provides better and clearer picture quality.

CONNECTIONS

Connecting to a TV with DVI Jack

1

Using the HDMI-DVI cable (not included), connect the **HDMI OUT** terminal on the rear of the DVD player to the **DVI IN** terminal of your TV.

2

Using the audio cables, connect the **AUDIO (red and white) OUT** terminals on the rear of the DVD player to the **AUDIO (red and white) IN** terminals of your TV. Turn on the DVD player and TV.

3

Press the input selector on your TV remote control until the DVI signal from the DVD player appears on your TV screen.

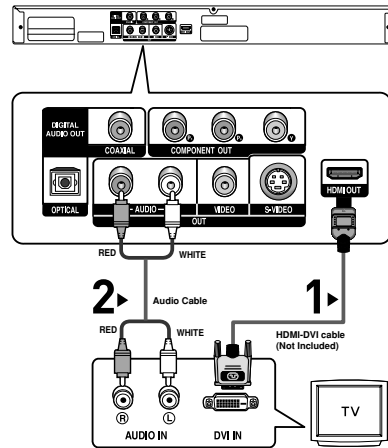

Connecting to a TV with HDMI Jack

1

Using the HDMI-HDMI cable connect the **HDMI OUT** terminal on the rear of the DVD player to the **HDMI IN** terminal of your TV.

2

Press the input selector on your TV remote control until the HDMI signal from the DVD player appears on your TV screen.

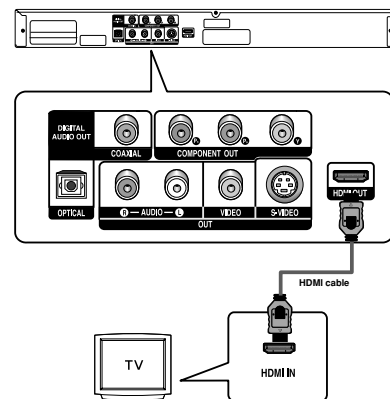

HDMI VIDEO Specifications

When you press the **HDMI SEL.** button, 480p, 720p, 1080i and 1080p are selected in order.

The first press of the **HDMI SEL.** button, brings up the current resolution.

The second press allows you to change the HDMI output resolution.

- Depending on your TV, certain HDMI output resolutions may not work.
- Please refer to the user's manual of your TV.
- If HDMI or HDMI-DVI cable is plugged into TV, the DVD player's output is set to HDMI/DVI automatically about 10 seconds later.
- If you set the HDMI output resolution to 720p, 1080i or 1080p, HDMI output provides better picture quality.
- If your TV cannot support current HDMI resolution setting, HDMI resolution is set to 480p automatically.

CONNECTIONS

- **HDMI (High Definition Multimedia Interface)**

HDMI is an interface to enable the digital transmission of video and audio data with just a single connector. Using HDMI, the DVD player transmits a digital video and audio signal and displays a vivid picture on a TV having an HDMI input jack.

- **HDMI connection description**

HDMI connector - Both uncompressed video data and digital audio data (LPCM or Bit Stream data).

- Though the player uses a HDMI cable, the player outputs only a pure digital signal to the TV.
- If TV does not support HDCP (High-bandwidth Digital content protection), snow noise appears on the screen.

- **Why does Samsung use HDMI?**

Analog TVs require an analog video/audio signal. However, when playing a DVD, the data transmitted to a TV is digital. Therefore either a digital-to-analog converter (in the DVD player) or an analog-to-digital converter (in the TV) is required. During this conversion, the picture quality is degraded due to noise and signal loss. HDMI technology is superior because it requires no D/A, A/D conversion and is a pure digital signal from the player to your TV.

- **What is the HDCP?**

HDCP (High-bandwidth Digital Content Protection) is a system for protecting DVD content outputted via DVI from being copied. It provides a secure digital link between a video source (PC, DVD. etc) and a display device (TV, projector . etc). Content is encrypted at the source device to prevent unauthorized copies from being made.

CONNECTIONS

Connection to an Audio System (2 Channel Amplifier)

1

Using the audio cables, connect the **AUDIO (red and white) OUT** terminals on the rear of the DVD player to the **AUDIO (red and white) IN** terminals of the Amplifier.

2

Using the video signal cable(s), connect the **VIDEO, S-VIDEO, COMPONENT** or **HDMI OUT** terminals on the rear of the DVD player to the **VIDEO, S-VIDEO, COMPONENT** or **HDMI-DVI IN** terminal of your TV as described on pages 12 to 16.

3

Turn on the DVD player, TV, and Amplifier.

4

Press the input select button of the Amplifier to select **external input** in order to hear sound from the DVD player. Refer to your Amplifier's user manual to set the Amplifier's audio input.

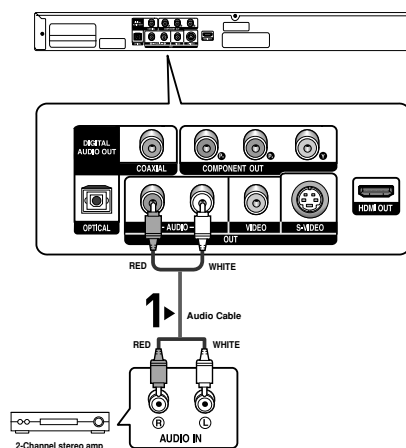

Note

- **Please turn the volume down when you turn on the Amplifier. Sudden loud sound may cause damage to the speakers and your ears.**
- Please set the audio in the menu screen according to the Amplifier. (See pages 50 to 51)
- The position of terminals may vary depending on the Amplifier. Please refer to the user's manual of the Amplifier.

CONNECTIONS

Connection to an Audio System (Dolby digital, MPEG2 or DTS Amplifier)

1

If using an optical cable (not included), connect the **DIGITAL AUDIO OUT (OPTICAL)** terminal on the rear of the DVD player to the **DIGITAL AUDIO IN (OPTICAL)** terminal of the Amplifier. If using a coaxial cable (not included), connect the **DIGITAL AUDIO OUT (COAXIAL)** terminal on the rear of the DVD player to the **DIGITAL AUDIO IN (COAXIAL)** terminal of the Amplifier.

2

Using the video signal cable(s), connect the **VIDEO**, **S-VIDEO**, **COMPONENT** or **HDMI OUT** terminals on the rear of the DVD player to the **VIDEO**, **S-VIDEO**, **COMPONENT** or **HDMI/DVI IN** terminals of your TV as described on pages 12 to 16.

3

Turn on the DVD player, TV, and Amplifier.

4

Press the input select button of the Amplifier to select **external input** in order to hear sound from the DVD player. Refer to your Amplifier's user manual to set the Amplifier's audio input.

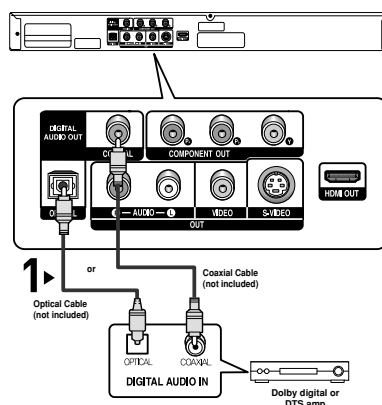

Note

- When you connect the DVD player to DTS Amplifier and play a DTS disc, set the DTS to On in Audio Setup menu. If it is set to Off, sound will not be heard, or there will be a loud sound.
- Please turn the volume down when you turn on the Amplifier. Sudden loud sound may cause damage to the speakers and your ears.
- Please set the audio in the menu screen according to the Amplifier. (See pages 50 to 51)
- The position of terminals may vary depending on the Amplifier. Please refer to the user's manual of the Amplifier.
- Please remove the dust cover before using the optical cable (not included) and put the cover on the cable again when it's not used.

Chapter 3

BASIC FUNCTIONS

Playing a Disc

Before Play

- Turn on your TV and set it to the correct Video Input on the TV's remote control.
- If you connected the DVD player to an external Audio System, turn on your Audio System and set it to the correct Audio Input.

After plugging in the player, the first time you press the DVD **POWER** button, this screen comes up: If you want to select a language, press a **NUMBER** button. (This screen will only appear when you plug in the player for the first time.) If the language for the startup screen is not set, the settings may change whenever you turn the power on or off. Therefore, make sure that you select the language you want to use. Once you select a menu language, you can change it by pressing the **▶▶** button on the front panel of the unit for more than 5 seconds with no disc in the unit. Then the **SELECT MENU LANGUAGE** window appears again where you can reset your preferred language.



Playback

1

Press the **OPEN/CLOSE** (**▲**) button. The **STANDBY** indicator light goes out and the tray opens.

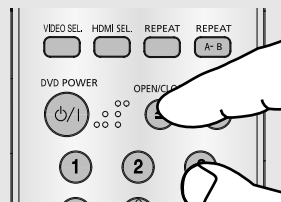

2

Place a disc gently into the tray with the disc's label facing up.



3

Press the **PLAY/PAUSE** (**▶||**) button or **OPEN/CLOSE** (**▲**) button to close the disc tray.

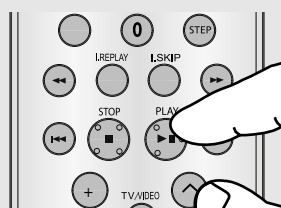

◀ RESUME function

When you stop disc play, the player remembers where you stopped, so when you press **PLAY/PAUSE** (**▶||**) button again, it will pick up where you left off.

BASIC FUNCTIONS

4

Stopping Play

Press the **STOP** (■) button during play.

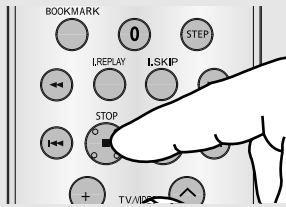

Note

- If the player is left in the stop mode for more than one minute without any user interaction, a screen saver will be activated. Press the PLAY/PAUSE (▶||) button to resume normal play.
- If the player is left in the stop mode for more than 30 minutes, the power will automatically turn off. (Automatic Power-Off Function)

5

Removing Disc

Press the **OPEN/CLOSE** (▲) button.

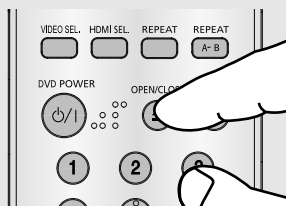

6

Pausing Play

Press the **PLAY/PAUSE** (▶||) or **STEP** button on the remote control during play.

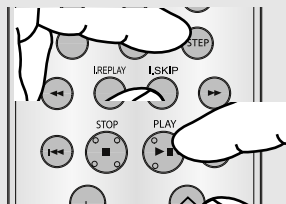

◀ Screen stops, no sound.

To resume, press the PLAY/PAUSE (▶||) button once again.

Note

If the player is left for about 5 minutes in pause mode, it will stop.

7

Step Motion Play (Except CD)

Press the **STEP** button on the remote control during play.



◀ Each time the button is pressed, a new frame will appear.

No sound is heard during STEP mode. Press the PLAY/PAUSE (▶||) button to resume normal play. You can only perform step motion play in the forward direction.

8

Slow Motion Play

Press the **SEARCH** (◀/▶) button to choose the play speed between 1/8, 1/4 and 1/2 of normal during PAUSE or STEP mode.



◀ No sound is heard during slow mode.

Press the PLAY/PAUSE (▶||) button to resume normal play.

Note

This (⊘) icon indicates an invalid button press.

BASIC FUNCTIONS

Using the Search and Skip Functions

During play, you can search quickly through a chapter or track, and use the skip function to jump to the next selection.

Searching through a Chapter or Track

During play, press the **SEARCH** (◀◀ or ▶▶) button on the remote control for more than 1 second.

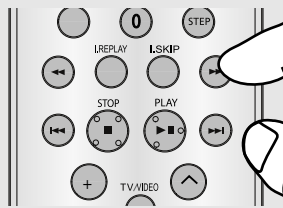

◀ If you want to search at a faster speed on the DVD, VCD or CD, press and hold the button.

DVD	2X, 4X, 64X, 128X
VCD	4X, 8X
CD	2X, 4X, 8X

Note

- The speed marked in this function may be different from the actual playback speed.
- No sound is hearing during search mode (Except CD).

Skipping Tracks

During play, press the **SKIP** (◀◀ or ▶▶) button.



- When playing a DVD, if you press the SKIP (▶▶) button, it moves to the next chapter. If you press the SKIP (◀◀) button, it moves to the beginning of the chapter. One more press makes it move to the beginning of the previous chapter.
- When playing a VCD 2.0 in Menu Off mode, or a VCD 1.1 or a CD, if you press the SKIP (▶▶) button, it moves to the next track. If you press the SKIP (◀◀) button, it moves to the beginning of the track. One more press makes it move to the beginning of the previous track.
- If a track exceeds 15 minutes when playing a VCD and you press the ▶▶ button, it moves forward 5 minutes. If you press the ◀◀ button, it moves backward 5 minutes.

Note

When VCD 2.0 is in Menu Off mode only, this function works. Select Menu Off by pressing the DISC MENU button.

BASIC FUNCTIONS

Using the Display Function

When Playing a DVD/VCD/MPEG4

1

During play, press the **INFO** button on the remote control.



◀ You can select Info in the function menu by pressing the MENU button.

2

Press the ▲/▼ buttons to select the desired item.

DVD



VCD



MPEG4

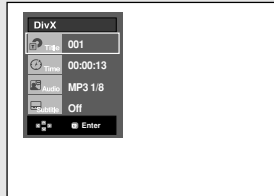

◀ When VCD 2.0 is in Menu Off mode only, this function works. Select Menu Off by pressing the DISC MENU button.

3

Press the ◀/▶ buttons to make the desired setup and then press the **ENTER** button.

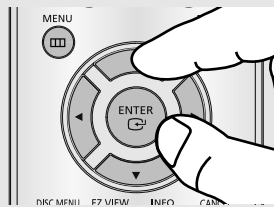

◀ You may use the number buttons of the remote control to directly access a title, chapter or to start the playback from a desired time.

4



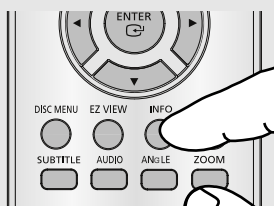



To make the screen disappear, press the **INFO** button again.



ENG-23

BASIC FUNCTIONS

Note

 Title	To access the desired title when there is more than one in the disc. For example, if there is more than one movie on a DVD, each movie will be identified.
 Chapter  Track	Most DVD discs are recorded in chapters so that you can quickly find a specific passage (similar to tracks on an VCD).
 Time	Allows playback of the film from a desired time. You must enter the starting time as a reference. The time search function does not operate on some discs.
 Audio	Refers to the film's soundtrack language. In the example, the soundtrack is played in English 5.1CH. A DVD disc can have up to eight different soundtracks.
 Subtitle	Refers to the subtitle languages available in the disc. You will be able to choose the subtitle languages or, if you prefer, turn them off from the screen. A DVD disc can have up to 32 different subtitles.
 Size	(DivX) File Size has a relationship with resolution of a title. The larger file size is, the higher resolution is displayed. If the file resolution is small, it scales up automatically. So you can see the larger screen.

Using the Disc and Title Menu

Using the Disc Menu

1

During the playback of a DVD disc, press the **MENU** button on the remote control.

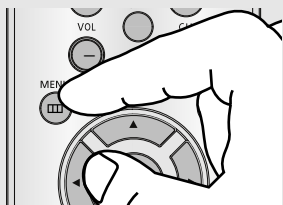

2

Press the **▲/▼** buttons to select **Disc Menu**, then press the **▶** or **ENTER** button.

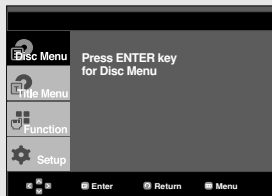

Note

- Depending on a disc, the Disc Menu may not work.
- You can also use select the Disc Menu, using the DISC MENU button on the remote control.
- In VCD 2.0 the DISC MENU button is used to select Menu On or Menu Off mode.

BASIC FUNCTIONS

Using the Title Menu

1

During the playback of a DVD disc, press the **MENU** button on the remote control.

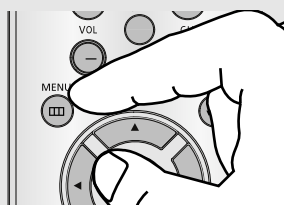

2

Press the **▲/▼** buttons to select **Title Menu**, then press the **▶** or **ENTER** button.



Note

- Depending on a disc, the Title Menu may not work.
- Title Menu will only be displayed if there are at least two titles in the disc.

Using the Function Menu

Using the Function Menu (DVD/VCD)

1

Press the **MENU** button during playback.

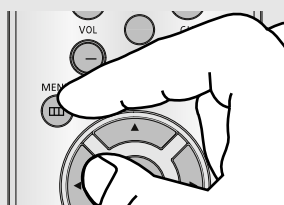

2

Press the **▲/▼** buttons to select **Function**, then press the **▶** or **ENTER** button.

- Info (See pages 23 to 24)
- Zoom (See page 36)
- Bookmark (See pages 34 to 35)
- Repeat (See pages 26)
- EZ View (See pages 28 to 29)
- Angle (See pages 32)

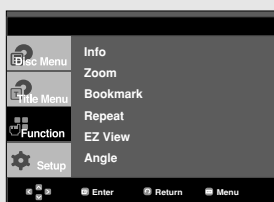

3

Press the **▲/▼** buttons to select one of the six functions. Then press the **▶** or **ENTER** button to access the function.

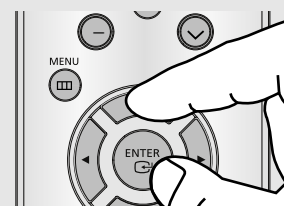

◀ You can also directly select these functions using their respective buttons on the remote control.

- Info
- Repeat
- Zoom
- EZ View
- Bookmark
- Angle

BASIC FUNCTIONS

Repeat Play

Repeat the current track, chapter, title, a chosen section (A-B), or all of the disc.

When playing a DVD/VCD

1

Press the **REPEAT** button on the remote control. Repeat screen appears.

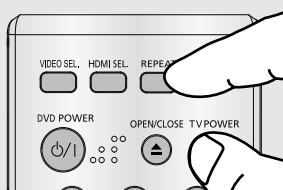

2

Press the ◀/▶ buttons to select **Chapter**, **Title** or **A-B**, then press the **ENTER** button.

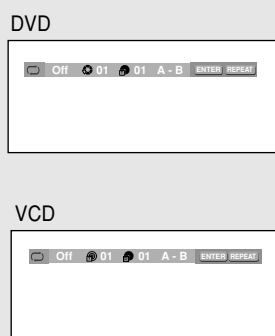

◀ DVD repeats play by chapter or title and VCD repeat play by disc or track.

Chapter (⌂): repeats the chapter that is playing.

Title (Ⓜ): repeats the title that is playing.

Disc (Ⓛ): repeats the disc that is playing.

Track (Ⓛ): repeats the track that is playing.

A-B: repeats a segment of the disc that you select.

Using the A-B Repeat function

1. Press the **REPEAT** button on the remote control.
2. Press the ◀/▶ button to select A-B button.
3. Press the **ENTER** button at the point where you want repeat play to start (A). B is automatically highlighted.
4. Press the **ENTER** button at the point where you want the repeat play to stop (B).
 - To return to normal play, press the CANCEL button.

Note

A-B REPEAT allows you to set point (B) directly after point (A) has been set.

3

To return to normal play, press **REPEAT** button again, then press the ◀/▶ buttons to select **Off** and press **ENTER** button.

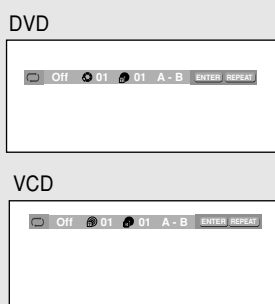

Note

- Depending on a disc, the Repeat function may not work.
- When VCD 2.0 is in Menu Off mode only, this function works. Select Menu Off by pressing the DISC MENU button.

BASIC FUNCTIONS

Slow Play

This feature allows you slowly to repeat scenes containing sports, dancing, musical instruments being played etc., so you can study them more closely.

When playing a DVD

1

During play, press the **PLAY/PAUSE** (▶||) button.

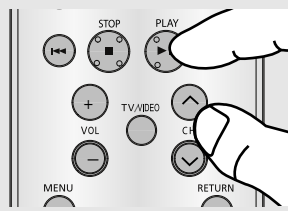

2

Press the **SEARCH** (◀▶) button to choose the play speed between 1/8, 1/4 and 1/2 of normal during PAUSE or STEP mode.

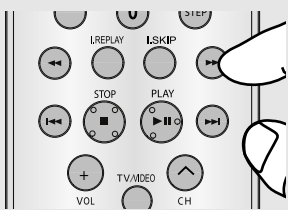

Chapter 4

ADVANCED FUNCTIONS

Adjusting the Aspect Ratio (EZ View)

To play back using aspect ratio (DVD)

Press the **EZ VIEW** button.

- The screen size changes when the button is pressed repeatedly.
- The screen zoom mode operates differently depending on the screen setting in the Display Setup menu.
- To ensure correct operation of the **EZ VIEW** button, you should set the correct aspect ratio in the Display Setup menu. (See pages 52 to 54).

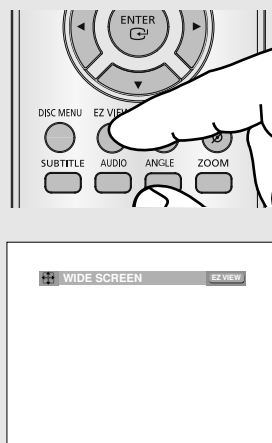

◀ To make the aspect ratio bar disappear, press the **CANCEL** button.

If you are using a 16:9 TV

For 16:9 aspect ratio discs

- **WIDE SCREEN**
Displays the content of the DVD title in 16:9 aspect ratio.
- **SCREEN FIT**
The top and bottom portions of the screen are cut off. When playing a 2.35:1 aspect ratio disc, the black bars at the top and bottom of the screen will disappear. The picture will look vertically stretched. (Depending on a type of disc, the black bars may not disappear completely.)
- **ZOOM FIT**
The top, bottom, left and right of the screen are cut off and the central portion of the screen is enlarged.

For 4:3 aspect ratio discs

- **Normal Wide**
Displays the content of the DVD title in 16:9 aspect ratio. The picture will look horizontally stretched.
- **SCREEN FIT**
The top and bottom portions of the screen are cut off and the full screen appears. The picture will look vertically stretched.
- **ZOOM FIT**
The top, bottom, left and right portions of the screen are cut off and the central portion of the screen is enlarged.
- **Vertical Fit**
When a 4:3 DVD is viewed on a 16:9 TV, black bars will appear at the left and right of the screen in order to prevent the picture from looking horizontally stretched.

ADVANCED FUNCTIONS

If you are using a 4:3 TV

For 16:9 aspect ratio discs

- 4:3 Letter Box

Displays the content of the DVD title in 16:9 aspect ratio. The black bars will appear at the top and bottom of the screen.

- 4:3 Pan&Scan

The left and right portions of the screen are cut off and the central portion of the 16:9 screen is displayed.

- SCREEN FIT

The top and bottom portions of the screen are cut off and a full screen appears. The picture will look vertically stretched.

- ZOOM FIT

The top, bottom, left and right of the screen are cut off and the central portion of the screen is enlarged.

For 4:3 aspect ratio discs

- Normal Screen

Displays the content of the DVD title in 4:3 aspect ratio.

- SCREEN FIT

The top and bottom portions of the screen are cut off and the full screen appears. The picture will look vertically stretched.

- ZOOM FIT

The top, bottom, left and right portions of the screen are cut off and the central portion of the screen is enlarged.

Note

This function may behave differently depending on the type of disc.

ADVANCED FUNCTIONS

Selecting the Audio Language

You can select a desired audio language quickly and easily with the AUDIO button.

Using the AUDIO button (DVD/VCD/MPEG4)

1

Press the **AUDIO** button. The Audio changes when the button is pressed repeatedly.
- The audio languages are represented by abbreviations.

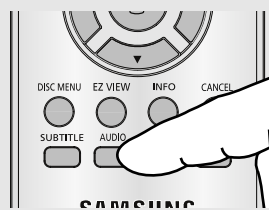

DVD



When playing a VCD, you can select among **Stereo, Right or Left**.

VCD

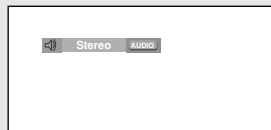

Press **AUDIO** button at remote repeatedly to select the desired Audio on a MPEG4 then press the **ENTER** button.

MPEG4



2

To remove the **AUDIO** icon, press the **CANCEL** or **RETURN** button.

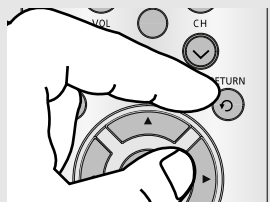
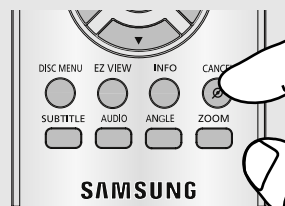

Note

- This function depends on audio languages are encoded on the disc and may not work.
- A DVD disc can contain up to 8 audio languages.
- To have the same audio language come up whenever you play a DVD; Refer to "Using the Audio Language" on page 47.

ADVANCED FUNCTIONS

Selecting the Subtitle Language

You can select a desired subtitle quickly and easily with the SUBTITLE button.

Using the SUBTITLE button (DVD/MPEG4)

1

Press the **SUBTITLE** button.
The subtitle changes when the button is pressed repeatedly.
The subtitle languages are represented by abbreviations.

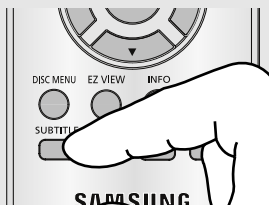

DVD



MPEG4

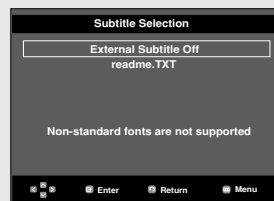

External subtitle option will appear, depends the DivX Disc.

Press **SUBTITLE** button at remote repeatedly to select the desired subtitle language on a MPEG4 then press the **ENTER** button.

MPEG4



2

To remove the **SUBTITLE** icon, press the **CANCEL** or **RETURN** button.

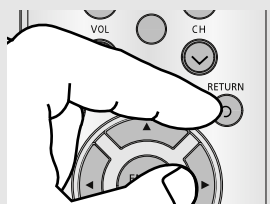
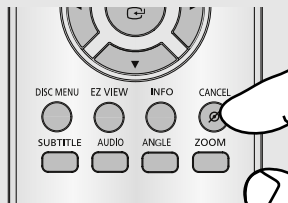

Note

- Depending on the DVD you may have to select the desired subtitle in the DVD's Disc Menu. Press the DISC MENU button.
- This function depends on what subtitles are encoded on the disc and may not work on all DVDs.
- A DVD disc can contain up to 32 subtitle languages.
- To have the same subtitle language come up whenever you play a DVD; Refer to "Using the Subtitle Language" on page 48.

ADVANCED FUNCTIONS

Changing the Camera Angle

When a DVD contains multiple angles of a particular scene, you can use the ANGLE function.

Using the ANGLE function (DVD)

If the disc contains multiple angles, the ANGLE mark appears on the screen.

1

During play, press the **MENU** button on the remote control.

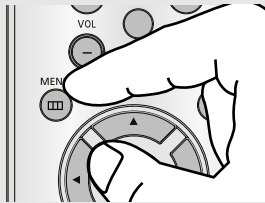

2

Press the ▲/▼ buttons to select **Function**, then press the ► or ENTER button.

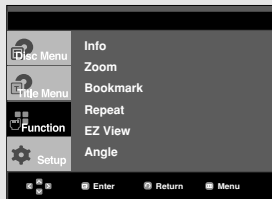

3

Press the ▲/▼ buttons to select **Angle**, then press the ► or ENTER button.

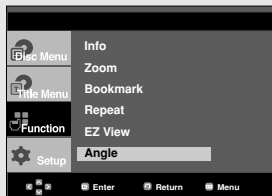

4

Press the ◀/▶ buttons or you can use the number buttons on the remote control to select the desired angle.



Note

- If the disc has only one angle, this feature won't work. Currently, very few discs have this feature.
- Depending on the disc, these functions may not work.

ADVANCED FUNCTIONS

Using the Instant Replay/Skip Function

Using the Instant Replay function (DVD)

If you miss a scene, you can see it again using this function.

Press the **INSTANT REPLAY** button.
- The current scene moves backward about 10 seconds, and plays back.



Using the Instant Skip function (DVD)

Use this function to skip playback about 10 seconds ahead of the current scene.

Press the **INSTANT SKIP** button.
- Playback will skip ahead 10 seconds.



Note

Depending on the disc, these functions may not work.

ADVANCED FUNCTIONS

Using the Bookmark Function

This feature lets you bookmark sections of a DVD, so you can quickly find them at a later time.

Using the Bookmark Function (DVD/VCD)

1

During play, press the **MENU** button on the remote control.

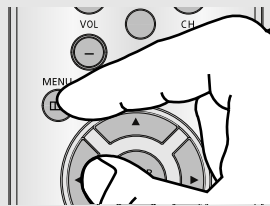

2

Press the **▲/▼** buttons to select **Function**, then press the **▶** or **ENTER** button.

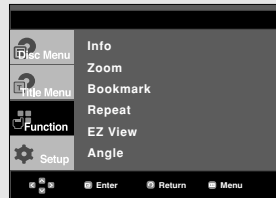

3

Press the **▲/▼** buttons to select **Bookmark**, then press the **▶** or **ENTER** button.

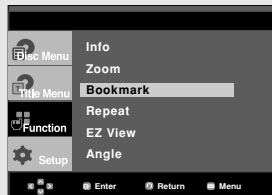

4

When you reach the scene you want to mark, press the **ENTER** button. Up to three scenes may be marked at a time.



Note

- When VCD 2.0 is in Menu Off mode only, this function works. Select Menu Off by pressing the DISC MENU button.
- Depending on a disc, the Bookmark function may not work.

ADVANCED FUNCTIONS

Recalling a Marked Scene

1

During play, press the **BOOKMARK** button on the remote control.



2

Press the ◀/▶ buttons to select a marked scene.

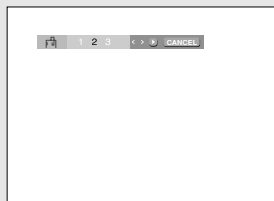

3

Press the **PLAY/PAUSE** (▶||) button to skip to the marked scene.



Clearing a Bookmark

1

During play, press the **BOOKMARK** button on the remote control..

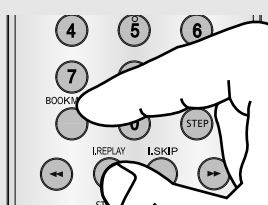

2

Press the ◀/▶ buttons to select the bookmark number you want to delete.



3

Press the **CANCEL** button to delete a bookmark number.

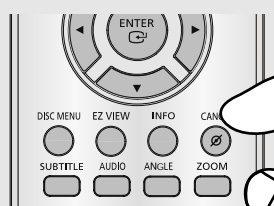

ADVANCED FUNCTIONS

Using the Zoom Function

Using the Zoom Function (DVD/VCD)

1

During play, press the **MENU** button on the remote control.

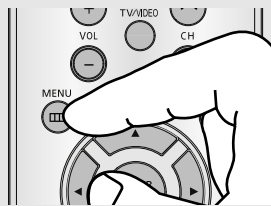

2

Press the **▲/▼** buttons to select **Function**, then press the **▶** or **ENTER** button.

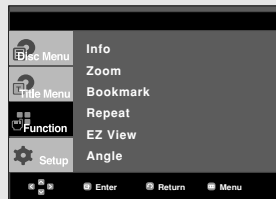

3

Press the **▲/▼** buttons to select **Zoom**, then press the **▶** or **ENTER** button.

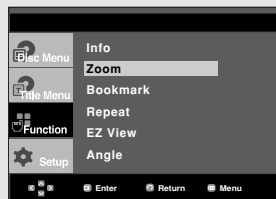

4

Press the **▲/▼** or **◀/▶** buttons to select the part of the screen you want to zoom in on. Press the **ENTER** button.

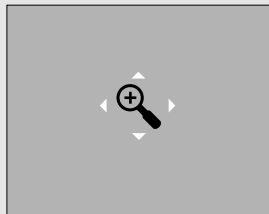

◀ During DVD play, press **ENTER** to zoom in 2X/4X/2X/Normal in order.

During VCD play, press **ENTER** to zoom in 2X/4X/2X/Normal in order.

ADVANCED FUNCTIONS

Clips Menu for MP3/WMA/JPEG/MPEG4/CD Audio

CD Audio or discs with MP3/WMA/JPEG/MPEG4 contain individual songs and/or pictures that can be organized into folders as shown below. They are similar to how you use your computer to put files into different folders.

Open the disc tray.
Place the disc on the tray.
Close the tray.
The tray closes and this screen displays.



- : Name of currently playing file.
- : Current Playback Time.
- : Current Playback Mode : There are four modes. They can be selected in order by pressing the **REPEAT** button.
 - Off: Normal Playback
 - Track: Repeats the current track.
 - Folder: Repeats the current folder.
 - Random: Files in the disc will be played in random order.
- : MP3 file icon.
- : WMA file icon.
- : JPEG file icon.
- : AVI file icon.
- : CD Audio file icon.
- : Folder icon.
- : Current Folder icon

Folder Selection

The folder can be selected both in Stop or Play mode.

- **To select the Parent Folder**
Press the **RETURN** button to go to the parent folder, or press the **▲/▼** buttons to select ".." and press **ENTER** to go to the parent folder.
- **To select the Peer Folder**
Press the **▲/▼** buttons to select the desired folder, then press **ENTER**.
- **To select the Sub-Folder**
Press the **▲/▼** buttons to select the desired folder, then press **ENTER**.

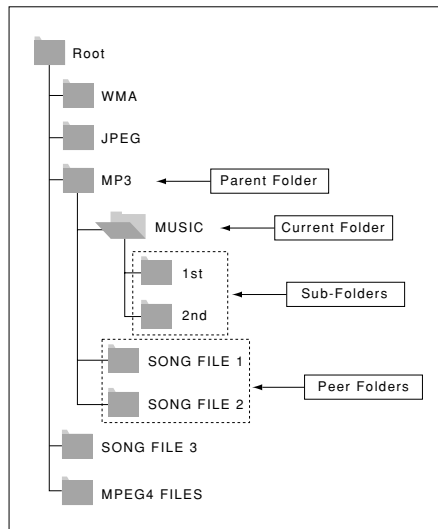

ENG-37

ADVANCED FUNCTIONS

MP3/WMA/CD Audio Playback

1

Open the disc tray.
Place the disc on the tray.
Close the tray.



◀ Only one kind of file is played back when a disc or a folder contains both MP3 and WMA files.

2

Press the ▲/▼ buttons to select a song file.
Press **ENTER** to begin playback of the song file.

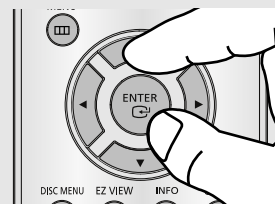

Repeat/Random playback

1

Press the **REPEAT** button to change the playback mode. There are four modes; **Off**, **Track**, **Folder** and **Random**.

- Off: Normal Playback
- Track: Repeats the current song file.
- Folder: Repeats the song files which have the same extension in the current folder.
- Random: Song files which have the same extension will be played in random order.

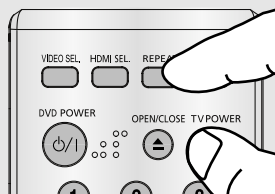

To resume normal play, press the **CANCEL** button.

ADVANCED FUNCTIONS

CD-R MP3/WMA file

When you record MP3 or WMA files on CD-R for playback in this unit, please refer to the following.

- Your MP3 or WMA files should be ISO 9660 or JOLIET format.

ISO 9660 format and Joliet MP3 or WMA files are compatible with Microsoft's DOS and Windows, and with Apple's Mac. This format is the most widely used.

- When naming your MP3 or WMA files, do not exceed 8 characters, and enter ".mp3, .wma" as the file extension.

General name format : Title.mp3. or Title.wma. When composing your title, make sure that you use 8 characters or less, have no spaces in the name, and avoid the use of special characters including: (,./,\,=,+).

- Use a decompression transfer rate of at least 128 Kbps when recording MP3 files.

Sound quality with MP3 files basically depends on the rate of compression/decompression you choose. Getting CD audio sound requires an analog/digital sampling rate, that is conversion to MP3 format, of at least 128 Kbps and up to 160 Kbps. However, choosing higher rates, like 192 Kbps or more, only rarely give better sound quality. Conversely, files with decompression rates below 128 Kbps will not be played properly.

- Use a decompression transfer rate of at least 64Kbps when recording WMA files.

Sound quality with WMA files basically depends on the rate of compression/decompression you choose.

Getting CD audio sound requires an analog/digital sampling rate, that is conversion to WMA format, of at least 64Kbps and up to 192Kbps.

Conversely, files with decompression rates below 64Kbps or over 192Kbps will not be played properly.

- Do not try recording copyright protected MP3 files.

Certain "secured" files are encrypted and code protected to prevent illegal copying. These files are of the following types: Windows Media™ (registered trade mark of Microsoft Inc) and SDMI™ (registered trade mark of The SDMI Foundation). You cannot copy such files.

- Important:

The above recommendations cannot be taken as a guarantee that the DVD player will play MP3 recordings, or as an assurance of sound quality. You should note that certain technologies and methods for MP3 file recording on CD-Rs prevent optimal playback of these files on your DVD player (degraded sound quality and in some cases, inability of the player to read the files).

- This unit can play a maximum of 500 files and 500 folders per disc.

ADVANCED FUNCTIONS

MPEG4 Playback

MPEG4 Play Function

AVI files are used to contain the audio and video data. Only AVI format files with the “.avi” extensions can be played.

1

Open the disc tray.
Place the disc on the tray.
Close the tray.



2

Press the ▲/▼ or ◀/▶ buttons to select an avi file (DivX/XviD), then press the **ENTER** button.

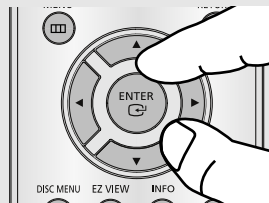

Repeat Playback

1

Press the **REPEAT** button to change playback mode.

There are 3 modes, such as **Off**, **Folder** and **Title**.

- Folder : Repeats the AVI files which have the same extension in the current folder.
- Title : repeats the title that is playing.



ADVANCED FUNCTIONS

MPEG4 Function Description

Function	Description	Reference page
Skip (⏮ or ⏭)	During play, press the ⏮ or ⏭ button, it moves forward or backward 5 minutes.	-
Search (⏪ or ⏩)	During play, press the SEARCH (⏪ or ⏩) button and press again to search at a faster speed. Allows you to search at a faster speed in an AVI file. (2X, 4X, 8X)	-
Slow Motion Play	Allows you to search at a slower speed in an AVI file. (1/8X, 1/4X, 1/2X)	P 21
Step Motion Play	Each time the STEP button is pressed, a new frame will appear.	P 21
ZOOM	2X/4X/2X/Normal in order	P 36

- These functions may not work depending on MPEG4 file.

CD-R AVI file

This unit can play the following video compression formats within the AVI file format:

- DivX 3.11 contents
- DivX 4 contents (Based on MPEG4 Simple Profile)
- DivX 5 contents (MPEG4 simple profile plus additional features such as bi-directional frames. Qpel and GMC are also supported.)
- XviD MPEG4 compliant Contents.

This unit supports all resolutions up to maximum below.

DivX3.11 & DivX4 & XviD	DivX5
Bitrate may fluctuate: Device may skip decoding the high bitrate portions and begin decoding again when Bitrate returns to normal.	720 x 480 @30fps 720 x 576 @25fps : Maximum bitrate : 4Mbps

Note

- Some MPEG4 files created on a personal computer may not be play back. That is why Codec Type, Version and Higher resolution over specification is not supported.
- This unit supports CD-R/RW written in MPEG4 in accordance with the "ISO9660 format".

ADVANCED FUNCTIONS

Picture CD Playback

1

Select the desired folder.
(See page 37)



2

Press the ▲/▼ buttons to select a Picture file in the clips menu and then press the **ENTER** button.

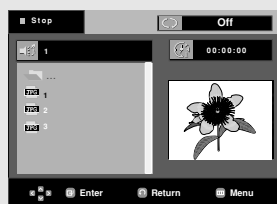

3

Press the **INFO** button to display the menu. Press the ◀/▶ buttons to select the menu you want to view, then press the **ENTER** button.

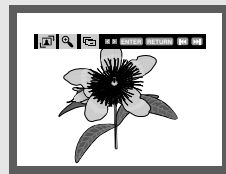

Note

- Press the STOP button to return to the clips menu.
- When playing a Kodak Picture CD, the unit displays the Photo directly, not the clips menu.

Rotation

 : Each time the **ENTER** button is pressed, the picture rotates 90 degrees clockwise.

Zoom



 : Press the ▲/▼ buttons to select the part of the screen you want to zoom in on. Press the **ENTER** button. Each time the **ENTER** button is pressed, the picture is enlarged up to 2X.

Slide Show

-  : The unit enters slide show mode.
- Before beginning the Slide Show, the picture interval must be set.

Note

- Depending on a file size, the amount of time between each picture may be different from the set interval time.
- If you don't press any button, the slide show will start automatically in about 10 seconds by default.

-  : The pictures change automatically with about a 6 second interval.
-  : The pictures change automatically with about a 12 second interval.
-  : The pictures change automatically with about a 18 second interval.

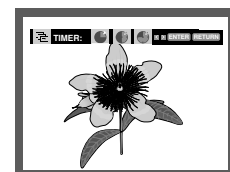

ADVANCED FUNCTIONS

MP3-JPEG Playback

You can play JPEG photo file using music as a background.

1

Press the ▲/▼ buttons to select an MP3 file in the clips menu and then press the **ENTER** button.

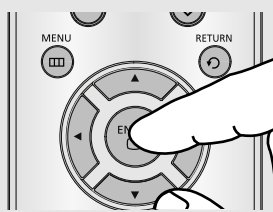

2

Press the ▲/▼ buttons to select a JPEG file in the clips menu and then press the **ENTER** button.

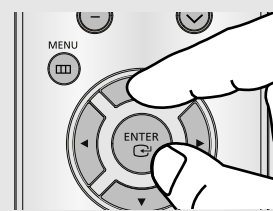

◀ Music will play from the beginning.

3

Press **STOP** button when you want to stop the playback.

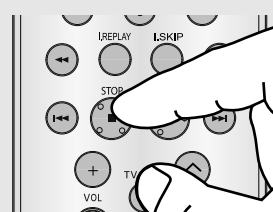

Note

MP3 and JPEG files have to be on the same disc.

CD-R JPEG Discs

- Only files with the ".jpg" and ".JPG" extensions can be played.
- If the disc is not closed, it will take longer to start playing and not all of the recorded files may be played.
- Only CD-R discs with JPEG files in ISO 9660 or Joliet format can be played.
- The name of the JPEG file may not be longer than 8 characters and should contain no blank spaces or special characters (. / = +).
- Only a consecutively written multi-session disc can be played. If there is a blank segment in the multi-session disc, the disc can be played only up to the blank segment.
- A maximum of 3000 images can be stored on a single CD.
- Kodak Picture CDs are recommended.
- When playing a Kodak Picture CD, only the JPEG files in the pictures folder can be played.
- Kodak Picture CD: The JPEG files in the pictures folder can be played automatically.
- Konica Picture CD: If you want to see the Picture, select the JPEG files in the clips menu.
- Fuji Picture CD: If you want to see the Picture, select the JPEG files in the clips menu.
- QSS Picture CD: The unit may not play QSS Picture CD.
- If the number of files in 1 Disc is over 500, only 500 JPEG files can be played.
- If the number of folders in 1 Disc is over 500, only JPEG files in 500 folders can be played.

Chapter 5

CHANGING SETUP MENU

Using the Setup Menu

The Setup menu lets you customize your DVD player by allowing you to select various language preferences, set up a parental level, even adjust the player to the type of television screen you have.

1

With the unit in Stop mode, press the **MENU** button on the remote control.

Press the **▲/▼** buttons to select **Setup**, then press the **▶** or **ENTER** button.

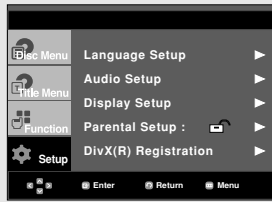

- ❶ Language Setup : Setup of the Language.
- ❷ Audio Setup : Setup of the Audio Options.
- ❸ Display Setup : Setup of the Display Options. Use to select which type of screen you want to watch and several display options.
- ❹ Parental Setup : Setup of the Parental Level. Allows users to set the level necessary to prevent children from viewing unsuitable movies such as those with violence, adult subject matter, etc.
- ❺ DivX(R) Registration : Please use the Registration code to register this player with the DivX(R) Video On Demand format. To learn more go to www.divx.com/vod.

2

Press the **▲/▼** buttons to access the different features. Press the **▶** or **ENTER** button to access the sub features.

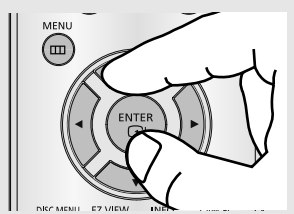

3

To make the setup screen disappear after setting up, press the **MENU** button again.

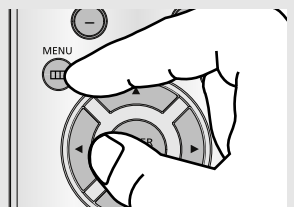

Note

Depending on the disc, some Setup menu selections may not work.

CHANGING SETUP MENU

Setting Up the Language Features

If you set the player menu, disc menu, audio and subtitle language in advance, they will come up automatically every time you watch a movie.

Using the Player Menu Language

1

With the unit in Stop mode, press the **MENU** button.

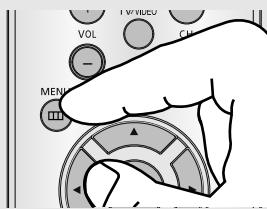

2

Press the **▲/▼** buttons to select **Setup**, then press the **▶** or **ENTER** button.



3

Press the **▲/▼** buttons to select **Language Setup**, then press the **▶** or **ENTER** button.



4

Press the **▲/▼** buttons to select **Player Menu**, then press the **▶** or **ENTER** button.



5

Press the **▲/▼** buttons to select the desired language, then press the **▶** or **ENTER** button.

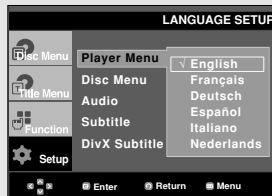

- ◀ - The language is selected and the screen returns to Language Setup menu.
- To make the setup menu disappear, press the **MENU** button.

CHANGING SETUP MENU

Using the Disc Menu Language

This function changes the text language only on the disc menu screens.

1

With the unit in Stop mode, press the **MENU** button.

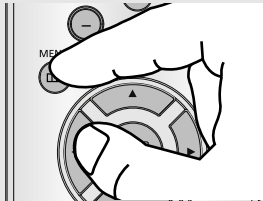

2

Press the ▲/▼ buttons to select **Setup**, then press the ► or **ENTER** button.



3

Press the ▲/▼ buttons to select **Language Setup**, then press the ► or **ENTER** button.



4

Press the ▲/▼ buttons to select **Disc Menu**, then press the ► or **ENTER** button.

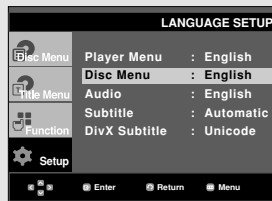

5

Press the ▲/▼ buttons to select the desired language, then press the ► or **ENTER** button.



- ◀ - If the selected language is not recorded on the disc, the original pre-recorded language is selected.
- The language is selected and the screen returns to Language Setup menu.
- To make the setup menu disappear, press the **MENU** button.

CHANGING SETUP MENU

Using the Audio Language

1

With the unit in Stop mode, press the **MENU** button.

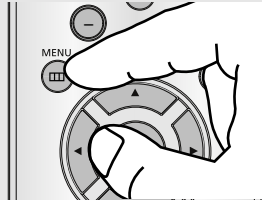

2

Press the **▲/▼** buttons to select **Setup**, then press the **▶** or **ENTER** button.



3

Press the **▲/▼** buttons to select **Language Setup**, then press the **▶** or **ENTER** button.



4

Press the **▲/▼** buttons to select **Audio**, then press the **▶** or **ENTER** button.



5

Press the **▲/▼** buttons to select the desired language, then press the **▶** or **ENTER** button.

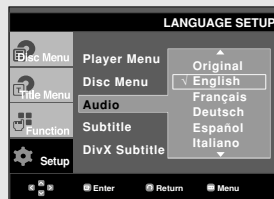

- ◀ - Select "Original" if you want the default soundtrack language to be the original language the disc is recorded in.
- If the selected language is not recorded on the disc, the original pre-recorded language is selected.
- The language is selected and the screen returns to Language Setup menu.
- To make the setup menu disappear, press the MENU button.

Changing
Setup Menu

CHANGING SETUP MENU

Using the Subtitle Language

1

With the unit in Stop mode, press the **MENU** button.

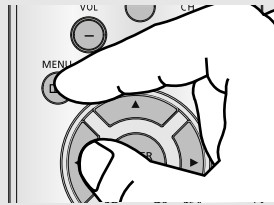

2

Press the ▲/▼ buttons to select **Setup**, then press the ► or **ENTER** button.



3

Press the ▲/▼ buttons to select **Language Setup**, then press the ► or **ENTER** button.

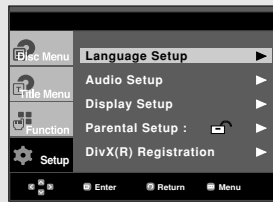

4

Press the ▲/▼ buttons to select **Subtitle**, then press the ► or **ENTER** button.



5

Press the ▲/▼ buttons to select the desired language, then press the ► or **ENTER** button.



- ◀ - Select "Automatic" if you want the subtitle language to be the same as the language selected as the audio language.
- Some discs may not contain the language you select as your initial language; in that case the disc will use its original language setting.
- The language is selected and the screen returns to setup menu.
- To make the setup menu disappear, press the MENU button.

CHANGING SETUP MENU

Using the DivX Subtitle Language

1

With the unit in Stop mode, press the **MENU** button.

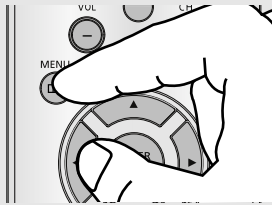

2

Press the **▲/▼** buttons to select **Setup**, then press the **▶** or **ENTER** button.



3

Press the **▲/▼** buttons to select **Language Setup**, then press the **▶** or **ENTER** button.

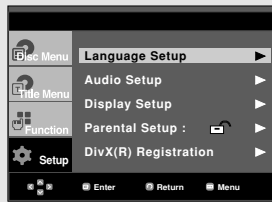

4

Press the **▲/▼** buttons to select **DivX Subtitle**, then press the **▶** or **ENTER** button.



5

Press the **▲/▼** buttons to select the desired language, then press the **▶** or **ENTER** button.



- ◀ - The language is selected and the screen returns to setup menu.
- To make the setup menu disappear, press the **MENU** button.

Changing
Setup Menu

CHANGING SETUP MENU

Setting Up the Audio Options

Audio Options allows you to setup the audio device and sound status settings depending on the audio system in use.

1

With the unit in Stop mode, press the **MENU** button.

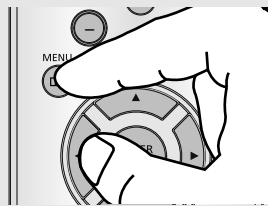

2

Press the **▲/▼** buttons to select **Setup**, then press the **▶** or **ENTER** button.



3

Press the **▲/▼** buttons to select **Audio Setup**, then press the **▶** or **ENTER** button.



4

Press the **▲/▼** buttons to select the desired item, then press the **▶** or **ENTER** button.

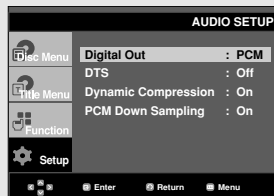

◀ To make the setup menu disappear, press the **MENU** button.

CHANGING SETUP MENU

① Digital Out

- PCM : Converts to PCM(2CH) audio.
- Bitstream : Outputs Dolby Digital via digital output.
Select Bitstream when connecting to a Dolby Digital Decoder.

② DTS

- Select On when connecting to DTS Decoder.
- On : Outputs DTS Bitstream via digital output.
 - Off : Doesn't output digital signal

Note

- There is no analog audio output when you play a DTS disc.

③ Dynamic Compression

- On : To select dynamic compression. This is useful for watching movies late at night, as it balances the load and quiet portions of a disc.
- Off : To select the standard range.

④ PCM Down Sampling

- On : Select this when the Amplifier connected to the player is not 96KHz compatible. In this case, the 96KHz signals will be down converted to 48KHZ.
- Off : Select this when the Amplifier connected to the player is 96KHz compatible. In this case, all signals will be output without any changes.

Note

Even when PCM Down sampling is Off

- Some discs will only output down sampled audio through the digital outputs.

HDMI

- If your TV is not compatible with compressed multi-channel formats (Dolby Digital, DTS, MPEG), you should set Digital Audio to PCM.
- If your TV is not compatible with LPCM sampling rates over 48kHz, you should set PCM Down sampling to On.

Note

- To make the Setup menu disappear, press the MENU button.

Manufactured under license from Dolby Laboratories. "Dolby" and the double-D symbol are trademarks of Dolby Laboratories.

"DTS" and "DTS Digital Out" are trademarks of Digital Theater Systems, Inc.

CHANGING SETUP MENU

Setting Up the Display Options

Display options enable you to set various video functions of the player.

1

With the unit in Stop mode, press the **MENU** button.

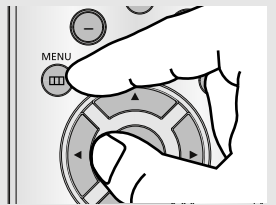

2

Press the **▲/▼** buttons to select **Setup**, then press the **▶** or **ENTER** button.



3

Press the **▲/▼** buttons to select **Display Setup**, then press the **▶** or **ENTER** button.

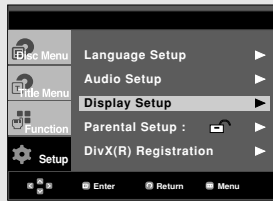

4

Press the **▲/▼** buttons to select the desired item, then press the **▶** or **ENTER** button.

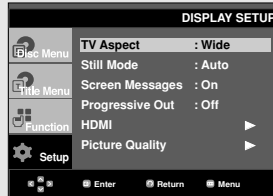

◀ To make the setup menu disappear, press the **MENU** button.

CHANGING SETUP MENU

❶ TV Aspect

Depending on a type of television you have, you may want to adjust the screen setting (aspect ratio).

- 4:3 Letter Box : Select when you want to see the total 16:9 ratio screen DVD supplies, even though you have a TV with a 4:3 ratio screen. Black bars will appear at the top and bottom of the screen.
- 4:3 Pan&Scan : Select this for conventional size TVs when you want to see the central portion of the 16:9 screen. (Extreme left and right side of movie picture will be cut off.)
- 16:9 Wide : You can view the full 16:9 picture on your wide screen TV.

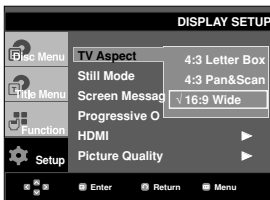

❷ Still Mode

These options will help prevent picture shake in still mode and display small text clearer.

- Auto : When selecting Auto, Field/Frame mode will be automatically adjusted.
- Field : Select this feature to minimize screen shaking.
- Frame : Select this feature when you want to read text more clearly on the screen .

❸ Screen Messages

Use to turn on-screen messages On or Off.

❹ Progressive Out

- ON : Select when you want to use the component (480p) progressive.

- OFF : Select when you want to use Video/S-Video/component interlace scan (480P)/HDMI (480p/720p/1080i/1080p) output.

❺ HDMI

This setting is used when the unit is connected by HDMI to Display devices (TV, Projector, etc.).

- Resolution Setting

The resolution setting is dependent on the capability of your TV or Monitor.

- Auto : Auto resolution setting
- Manual : Resolution setting manually

- Resolution

- 480p : 720 x 480
- 720p : 1280 x 720
- 1080i : 1920 x 1080
- 1080p : 1920 x 1080

For best video performance, check your TV's user manual for proper resolution setting.

- Format

You can use this function to set HDMI output's Format.

- TV - RGB : Select this when you want to connect to a RGB supported TV.
- Monitor : Select this when you want to connect to a monitor device.
- TV : Select this when you want to connect to standard TV.

- Contrast

This setting is defined as the ratio between the maximum and minimum Contrast values in a picture. (Level 1~ Level 5).

CHANGING SETUP MENU

- Sharpness

To adjust the picture smoothness (Level 1 ~ Level 5).

- Noise Reduction

This setting can be used to reduce image noise that spread out on the screen (Level 1 ~ Level 5).

- Edge Enhancement

To adjust the picture softness. This is a digital image processing filter that is used to make pictures look sharper than they really are. (Level 1 ~ Level 5).

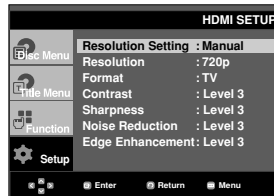

- If Video Output is set incorrectly, the screen may be blocked.
- The resolutions available for HDMI output depend on the connected TV or projector. For details, see the user's manual of your TV or projector.
- When the resolution is changed during playback, it may take a few seconds for a normal image to appear.
- If you have HDMI connected, better picture quality will be provided when the output is set to 720p, 1080i or 1080p.

- If you press the VIDEO SEL. button, Video output mode is changed in regular sequence.

(Progressive : ON → Progressive : OFF)

⑥ Picture Quality

- Black Level : Adjusts the brightness of the screen. (On or Off) It does not function in Progressive mode.
- Brightness : Level 1 ~ Level 5
- Color Saturation : Level 1 ~ Level 5

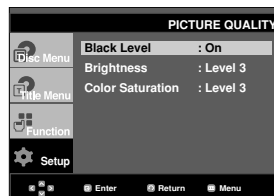

- Consult your TV User's Manual to find out if your TV supports Progressive Scan. If Progressive Scan is supported, follow the TV User's Manual regarding Progressive Scan settings in the TV's menu system.

CHANGING SETUP MENU

Setting Up the Parental Control

The Parental Control function works in conjunction with DVDs that have been assigned a rating, which helps you control the types of DVDs that your family watches. There are up to 8 rating levels on a disc.

Setting Up the Rating Level

1

With the unit in Stop mode, press the **MENU** button.

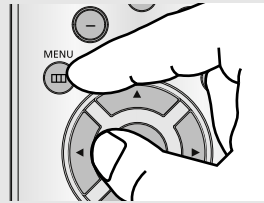

2

Press the **▲/▼** buttons to select **Setup**, then press the **▶** or **ENTER** button.



3

Press the **▲/▼** buttons to select **Parental Setup**, then press the **▶** or **ENTER** button.



4

Press the **▶** or **ENTER** button to select **Yes** if you want to use a password. The Enter Password screen appears.

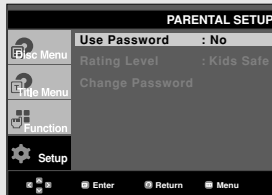

5

Enter your password.

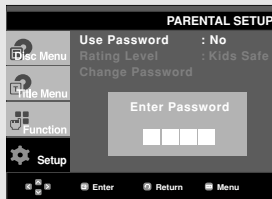

6

Press the **▲/▼** buttons to select the Use Password you want, then press the **▶** or **ENTER** button. e.g) Setting up in **No**.

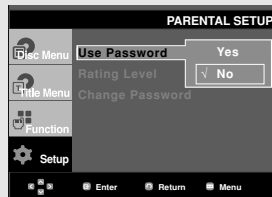

◀ To make the setup menu disappear, press the **MENU** button.

CHANGING SETUP MENU

1

With the unit in Stop mode, press the **MENU** button.

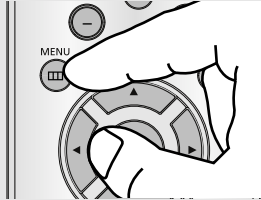

2

Press the ▲/▼ buttons to select **Setup**, then press the ► or **ENTER** button.

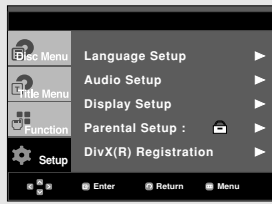

3

Press the ▲/▼ buttons to select **Parental Setup**, then press the ► or **ENTER** button.

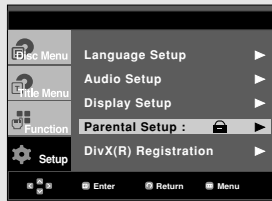

4

Press the ▲/▼ to select **Rating Level**, then press the ► or **ENTER** button. The Enter Password screen appears.

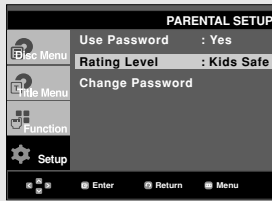

5

Enter your password.

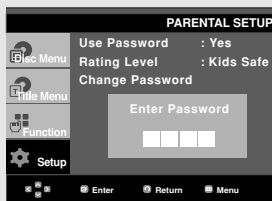

6

Press the ▲/▼ buttons to select the Rating Level you want, then press the ► or **ENTER** button.
e.g) Setting up in **Kids Safe**.

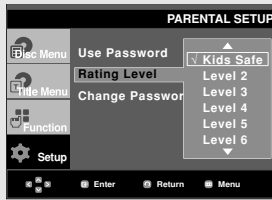

◀ To make the setup menu disappear, press the **MENU** button.

For example, if you select up to Level 6, discs that contain Level 7, 8 will not play.

CHANGING SETUP MENU

Changing the Password

1

With the unit in Stop mode, press the **MENU** button.

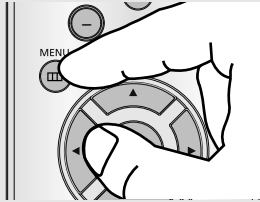

2

Press the **▲/▼** buttons to select **Setup**, then press the **▶** or **ENTER** button.



3

Press the **▲/▼** buttons to select **Parental Setup**, then press the **▶** or **ENTER** button.



4

Press the **▲/▼** button to select **Change Password**, then press the **▶** or **ENTER** button. Enter your password. Then enter your new password.

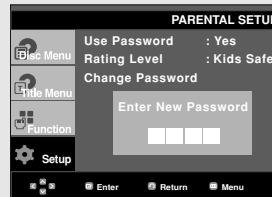
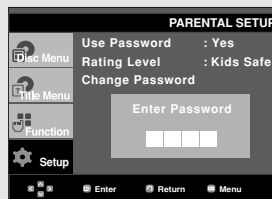
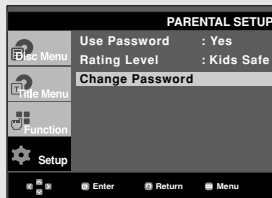

◀ To make the setup menu disappear, press the **MENU** button.

Note

If you have forgotten your password, see "Forgot Password" in the Troubleshooting Guide.

Chapter 6

REFERENCE

Controlling a TV with the Remote control

The remote control can also be set up to control most TVs. To program the remote control, use the code that corresponds to your brand.

TV Codes			
BRAND	CODE	BRAND	CODE
ANAM	10, 11, 12, 13, 14, 15, 16, 17, 18	NORDMENDE	72, 73
AIWA	82	NOKIA	74
BANG&OLUFSEN	57	PANASONIC	53, 54, 74, 75
BLAUPUNKT	71	PHILIPS	06, 55, 56, 57
BRANDT	73	PHONOLA	06, 56, 57
BRIONVEGA	57	PIONEER	58, 59, 73, 74, 75
CGE	52	RADIOLA	06, 56
CONTINENTAL EDISON	75	RADIOMARELLI	57
DAEWOO	19, 20, 23, 24, 25, 26, 27, 28, 29, 30, 31, 32, 33, 34	RCA	45, 46
		REX	74
EMERSON	64	SABA	57, 72, 73, 74, 75
FERGUSON	73	SALORA	74
FINLUX	06, 49, 57	SAMSUNG	01, 02, 03, 04, 05, 06, 07, 08, 09
FORMENTI	57	SANYO	41, 42, 43, 44, 48
FUJITSU	84	SCHNEIDER	06
GRADIENTE	70	SELECO	74
GRUNDIG	49, 52, 71	SHARP	36, 37, 38, 39, 48
HITACHI	60, 72, 73, 75	SIEMENS	71
IMPERIAL	52	SINGER	57
JVC	61, 79	SINUDYNE	57
LG	06, 19, 20, 21, 22, 78	SONY	35, 48
LOEWE	06, 69	TELEAVA	73
LOEWE OPTA	06, 57	TELEFUNKEN	67, 73, 75, 76
MAGNAVOX	40	THOMSON	72, 73, 75
METZ	57	THOMSON ASIA	80, 81
MITSUBISHI	06, 48, 62, 65	TOSHIBA	47, 48, 49, 50, 51, 52
MIVAR	52, 77	WEGA	57
NEC	83	YOKO	06
NEWSAN	68	ZENITH	63
NOBLEX	66		

1. Turn on the TV.
2. Point the DVD's remote control at the TV.
3. While holding the TV POWER button down, enter the code for your brand.
4. If the TV turns off, setup is complete. Enter other codes of the same brand if the first code does not work.

You can control the TV POWER, CH (\wedge , \vee), VOL (+, -) and TV/VIDEO functions of another manufacturer's TV.

- The remote control may not be able to control every model TV of the brands listed.
- If you replace the remote control's batteries, set the brand code again.

e.g) For Samsung TVs

While holding down the TV POWER button, enter 0 and then 1.

Firmware upgrade

Introduction

Samsung will often support the software upgrade to improve the performance of this unit to the latest status, through Samsung Internet Site (www.samsung.com).

Because the specially new mpeg4 codec continues and it is appearing. What improvements are made depends on the upgrade software you are using as well as the software that your DVD-player contained before the upgrade.

How to make an upgrade disc

Write the downloaded file onto a blank CD-R or CD-RW disc, using the following settings:

1

You have to download a new file through Download Center of Samsung Internet Site (www.samsung.com).

2

Write the file to Disc using CD-RW of your computer.

Note

- File System CD-ROM ISO Level
- Character set ISO 9660
- Finalized, single session
- Write speed low

Upgrade procedure

1

Open the disc tray.
Place the disc on the tray.
Close the tray.
The Firmware upgrade screen appears.



Firmware upgrade appears on the display

2

Press the ◀/▶ buttons to select **Total**, then press the **ENTER** button.



Firmware upgrade starts

3

Press the number buttons to select the desired language.



- ◀ - In the middle of the writing, the tray will open automatically. After taking out the disc, please wait for about 2 minutes.
- If the unit was successfully updated, the unit will turn off and on after closing the tray automatically. When the unit turns on, this screen will display.

Note

- If the “Select Menu Language” doesn't appear, please contact to “Samsung Service Center”.
- Do not press any button and unplug the power code during upgrade.
- The upgrade procedure may change, refer to the web site (www.samsung.com).

REFERENCE

Troubleshooting

Before requesting service, please check the following.

Problem	Action	Page
No operations can be performed with the remote control.	<ul style="list-style-type: none"> • Check the batteries in the remote control. They may need replacing. • Operate the remote control at a distance of no more than 20 feet. • Remove batteries and hold down one or more buttons for several minutes to drain the microprocessor inside the remote control to reset it. Reinstall batteries and try to operate the remote control again. 	P5
Disc does not play.	<ul style="list-style-type: none"> • Ensure that the disc is installed with the label side facing up. • Check the region number of the DVD. 	P8
5.1 channel sound is not being reproduced.	<ul style="list-style-type: none"> • 5.1 channel sound is reproduced only when the following conditions are met. : <ol style="list-style-type: none"> 1) The DVD player is connected with the proper Amplifier 2) The disc is recorded with 5.1 channel sound. • Check whether the disc being played has the "5.1 ch" mark on the outside. • Check if your audio system is connected and working properly. • In a SETUP Menu, is the Audio Output set to Bitstream? 	P19 P50~51
The  icon appears on screen.	<ul style="list-style-type: none"> • The features or action cannot be completed at this time because: <ol style="list-style-type: none"> 1. The DVD's software restricts it. 2. The DVD's software doesn't support the feature (e.g., angles). 3. The feature is not available at the moment. 4. You've requested a title or chapter number or search time that is out of range. 	
Disc Menu doesn't appear.	<ul style="list-style-type: none"> • Check if the disc has a Menu. 	
Play mode differs from the Setup Menu selection.	<ul style="list-style-type: none"> • Some of the functions selected in the Setup Menu may not work properly if the disc is not encoded with the corresponding function. 	P44~57
The screen ratio cannot be changed.	<ul style="list-style-type: none"> • The Screen Ratio is fixed on your DVDs. 	P52~54
No audio.	<ul style="list-style-type: none"> • Make sure you have selected the correct Digital Output in the Audio Options Menu. 	P50~51
The screen is blocked	<ul style="list-style-type: none"> • Press the ▶▶▶ button (on the front panel) for more than 5 seconds with no disc inside. All settings will revert to the factory settings. 	P20
Forgot password	<ul style="list-style-type: none"> • Press the ▶▶▶ button (on the panel) for more than 5 seconds with no disc inside. All settings including the password will revert to the factory settings. Don't use this unless absolutely necessary. 	P55~57
If you experience other problems.	<ul style="list-style-type: none"> • Go to the contents and find the section of the instruction book that contains the explanations regarding the current problem, and follow the procedure once again. • If the problem still cannot be solved, please contact your nearest Samsung authorized service center. 	
The picture is noisy or distorted	<ul style="list-style-type: none"> • Make sure that the disc is not dirty or scratched. • Clean the disc. 	P4

REFERENCE

Problem	Action	Page
No HDMI output.	<ul style="list-style-type: none">• Check the Video output is set to Progressive out off.• Check the connection between the TV and the HDMI jack of DVD player.• See if the TV supports this 480p/720p/1080i/1080P DVD player.	P16~17
Abnormal HDMI output screen.	<ul style="list-style-type: none">• If snow noise appears on the screen, it means that TV does not support HDCP (High-bandwidth Digital Content Protection).	P16~17
HDMI output Jitter	<ul style="list-style-type: none">• Check your TV system setup correctly.• Screen Jitter may occur when frame rate is converted from 50Hz to 60Hz for 720P/1080i/1080P HDMI (High Definition Multimedia Interface) Output.• Please refer to the user's manual of your TV.	P52~54

REFERENCE

Specifications

General	Power Requirements	AC 120V ~ 60 Hz
	Power Consumption	15 W
	Weight	2.3 Kg
	Dimensions	16.93" (W) X 8.07" (D) X 1.77" (H)
	Operating Temperature Range	+41°F to +95°F
	Operating Humidity Range	10 % to 75 %
Disc	DVD (DIGITAL VERSATILE DISC)	Reading Speed : 3.49 ~ 4.06 m/sec. Approx. Play Time (Single Sided, Single Layer Disc) : 135 min.
	CD : 12Cm (COMPACT DISC)	Reading Speed : 4.8 ~ 5.6 m/sec. Maximum Play Time : 74 min.
	CD : 8Cm (COMPACT DISC)	Reading Speed : 4.8 ~ 5.6 m/sec. Maximum Play Time : 20 min.
Video Output	Composite Video	1 channel : 1.0 Vp-p (75 Ω load) Y : 1.0 Vp-p (75 Ω load)
	Component Video	Pr : 0.70 Vp-p (75 Ω load) Pb : 0.70 Vp-p (75 Ω load)
	S-Video	Luminance Signal : 1.0 Vp-p (75 Ω load) Chrominance Signal : 0.3 Vp-p (75 Ω load)
	HDMI	480p, 720p, 1080i, 1080p
Audio Output	2 Channel	L(1/L), R(2/R)
	*Frequency Response	48 kHz Sampling : 4 Hz to 22 kHz 96 kHz Sampling : 4 Hz to 44 kHz
	*S/N Ratio	110 dB
	*Dynamic Range	100 dB
	*Total Harmonic Distortion	0.005 %

*: Nominal specification

- Samsung Electronics Co., Ltd reserves the right to change the specifications with out notice.
- Weight and dimensions are approximate.

Warranty

LIMITED WARRANTY TO ORIGINAL PURCHASER

This SAMSUNG brand product, as supplied and distributed by SAMSUNG ELECTRONICS AMERICA, INC. (SAMSUNG) and delivered new, in the original carton to the original consumer purchaser, is warranted by SAMSUNG against manufacturing defects in materials and workmanship for the following limited warranty period:

One (1) Year Parts / Ninety (90) Labor

This limited warranty begins on the original date of purchase, and is valid only on products purchased and used in the United States, and does not include transportation, installation, removal or reinstallation. Warranty repairs must be performed by SAMSUNG's authorized service center. To receive warranty service, the original dated bill of sale must be presented upon request as proof of purchase to SAMSUNG or SAMSUNG's authorized service center. Transportation to and from the service center is the responsibility of the purchaser.

SAMSUNG will repair or replace this product, at our option and at no charge with new or reconditioned parts, if found to be defective during the limited warranty period specified above. The product must be returned during the warranty period with transportation charges prepaid to SAMSUNG's designated service center. Prior to returning any product for warranty service, the purchaser must contact SAMSUNG for problem determination and service procedures. SAMSUNG does not warrant uninterrupted or error-free operation of the product. All replaced parts and products become the property of SAMSUNG and must be returned to SAMSUNG. Replacement parts and products assume the remaining original warranty, or ninety (90) days, whichever is longer.

This limited warranty covers manufacturing defects in materials and workmanship encountered in normal, noncommercial use of this product and shall not apply to the following, including, but not limited to: damage which occurs in shipment; applications and uses for which this product was not intended; failures or problems which are caused by products or equipment not supplied by SAMSUNG; accidents, misuse, abuse, neglect, misapplication, fire, water, lightning or other acts of nature; incorrect electrical line voltage, fluctuations or surges; damage caused by improper or faulty installation; improper connection with any peripheral; product alteration or modification; improper or unauthorized repair; cosmetic damage or exterior finish; product with altered serial numbers; failure to follow operating instructions, customer adjustments, maintenance and environmental instructions that are covered and prescribed in the instruction book; use of non-SAMSUNG or unauthorized parts, supplies, accessories or equipment which damage this product or result in service problems; failures or problems due to incompatibility with other equipment.

Contact SAMSUNG WORLD WIDE

If you have any questions or comments relating to Samsung products, please contact the SAMSUNG customer care centre.

Region	Country	Customer Care Center ☎	Web Site
North America	CANADA	1-800-SAMSUNG (7267864)	www.samsung.com/ca
	MEXICO	01-800-SAMSUNG (7267864)	www.samsung.com/mx
	U.S.A	1-800-SAMSUNG (7267864)	www.samsung.com
Latin America	ARGENTINE	0800-333-3733	www.samsung.com/ar
	BRAZIL	0800-124-421	www.samsung.com/br
	CHILE	800-726-7864(SAMSUNG)	www.samsung.com/cl
	COSTA RICA	0-800-507-7267	www.samsung.com/latin
	ECUADOR	1-800-10-7267	www.samsung.com/latin
	EL SALVADOR	800-6225	www.samsung.com/latin
	GUATEMALA	1-800-299-0013	www.samsung.com/latin
	JAMAICA	1-800-234-7267	www.samsung.com/latin
	PANAMA	800-7267	www.samsung.com/latin
	PUERTO RICO	1-800-682-3180	www.samsung.com/latin
	REP. DOMINICA	1-800-751-2676	www.samsung.com/latin
	TRINIDAD & TOBAGO	1-800-7267-864	www.samsung.com/latin
VENEZUELA	1-800-100-5303	www.samsung.com/latin	
Europe	BELGIUM	02 201 2418	www.samsung.com/be
	CZECH REPUBLIC	844 000 844	www.samsung.com/cz
	DENMARK	38 322 887	www.samsung.com/dk
	FINLAND	09 693 79 554	www.samsung.com/fi
	FRANCE	08 25 08 65 65 (0,15 /Min)	www.samsung.com/fr
	GERMANY	01805 - 121213 (0,12/Min)	www.samsung.de
	HUNGARY	06 40 985 985	www.samsung.com/hu
	ITALIA	199 153 153	www.samsung.com/it
	LUXEMBURG	02 261 03 710	www.samsung.lu
	NETHERLANDS	0900 20 200 88 (0.10/Min)	www.samsung.com/nl
	NORWAY	231 627 22	www.samsung.com/no
	POLAND	0 801 801 881	www.samsung.com/pl
	PORTUGAL	80 8 200 128	www.samsung.com/pt
	SLOVAKIA	0850 123 989	www.samsung.com/sk
	SPAIN	902 10 11 30	www.samsung.com/es
	SWEDEN	08 585 367 87	www.samsung.com/se
U.K	0870 242 0303	www.samsung.com/uk	
CIS	RUSSIA	8-800-200-0400	www.samsung.ru
	UKRAINE	8-800-502-0000	www.samsung.com/ur
Asia Pacific	AUSTRALIA	1300 362 603	www.samsung.com/au
	CHINA	800-810-5858, 010- 6475 1880	www.samsung.com.cn
	HONG KONG	2862 6001	www.samsung.com/hk
	INDIA	3030 8282 1600 1100 11	www.samsung.com/in
	INDONESIA	0800-112-8888	www.samsung.com/id
	JAPAN	0120-327-527	www.samsung.com/jp
	MALAYSIA	1800-88-9999	www.samsung.com/my
	PHILIPPINES	1800-10-SAMSUNG (7267864)	www.samsung.com/ph
	SINGAPORE	1800-SAMSUNG (7267864)	www.samsung.com/sg
	THAILAND	1800-29-3232 02-689-3232	www.samsung.com/th
TAIWAN	0800-329-999	www.samsung.com/tw	
VIETNAM	1 800 588 889	www.samsung.com/vn	
Middle East & Africa	SOUTH AFRICA	0860 7267864 (SAMSUNG)	www.samsung.com/za
	U.A.E	800SAMSUNG (7267864)	www.samsung.com/mea



Contact SAMSUNG WORLD WIDE

If you have any questions or comments relating to Samsung products,
please contact the SAMSUNG customer care centre.

☎ 1-800-SAMSUNG (7267864)/www.samsung.com

Samsung Electronics America, Inc.
105 Challenger Road
Ridgefield Park, NJ 07660-0511
1-800-SAMSUNG (7267864)
www.samsung.com

US

AK68-01038D

Free Manuals Download Website

<http://myh66.com>

<http://usermanuals.us>

<http://www.somanuals.com>

<http://www.4manuals.cc>

<http://www.manual-lib.com>

<http://www.404manual.com>

<http://www.luxmanual.com>

<http://aubethermostatmanual.com>

Golf course search by state

<http://golfingnear.com>

Email search by domain

<http://emailbydomain.com>

Auto manuals search

<http://auto.somanuals.com>

TV manuals search

<http://tv.somanuals.com>