

SAMSUNG

SAMSUNG

ELECTRONICS



DVD PLAYER

DVD-S128

DVD-S228

DVD-S328K

DVD-S428K

ENG

AK68-00015M

Precautions

1. Setting up

Ensure that the mains supply in your house complies with that indicated on the identification sticker located at the back of your play. Install your player horizontally, on a suitable base (furniture), with enough space around it for ventilation (7-10cm). Make sure the ventilation slots are not covered. Do not stack other, or heavy devices on top of the player. Do not place the player on amplifiers or other equipment which may become hot. Before moving the player ensure the disc tray is empty. This player is designed for continuous use. Switching off the DVD player to the stand-by mode does not disconnect the electricity supply. In order to separate the player completely from the mains, it has to be disconnected by unplugging the main plug, especially when left unused for a long period of time.

2. Caution

Protect the player from moisture (dripping or splashing and objects filled with liquids), and excess heat (e.g. fireplace) or equipment creating strong magnetic or electric fields (i.e. speakers...). Disconnect the power cable from the mains electricity supply if the player malfunctions. Your player is not intended for industrial use but for domestic purposes only. Use of this product is for personal use only. If your player or disc has been stored in a cold atmosphere for example during transportation in the winter, wait for approximately 2 hours until they have reached room temperature, before use.

3. For your safety

Never open the player or any of its components. It can be dangerous for you or certain fragile components. You could receive an electric shock or touch the laser beam. Do not place your eyes close to the opening of the disc tray or any other opening to look inside the player.

4. Disc

Be careful handle your discs with care. Hold a disc with finger on the border or hole. Always place disc with the label facing upward (in case of a single side disc). Always use a soft cloth to clean disc if necessary, wipe from the centre to the border. Always put disc back into their cases after playing and store in vertical position. Always place the disc properly into the tray using the proper guide area. Never use record cleaning sprays, benzene, static electricity liquids or any other solvent, if the disc surface is dirty. Wipe gently with a soft damp (water only) cloth, never wipe the disc in a circular motion, since circular scratches are likely to occur and could cause noise during playback.

5. Battery

The battery used in this product contains chemicals that are harmful to the environment. Do not dispose of batteries in the general household waster. It is recommended that the replacement of the battery should be done by a technician.

6. Maintenance of cabinet

For safety reasons, be sure to disconnect the AC power cord from the AC outlet.

- Do not use benzene, thinner, or other solvents for cleaning.
- Wipe the cabinet with a soft cloth.

2

Precautions

1

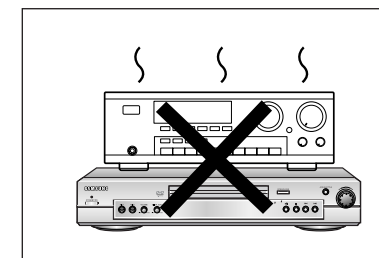
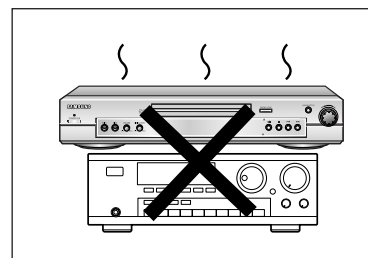
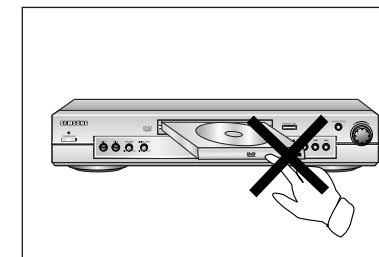
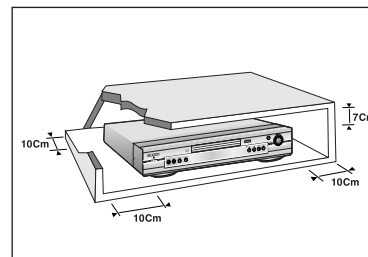

2

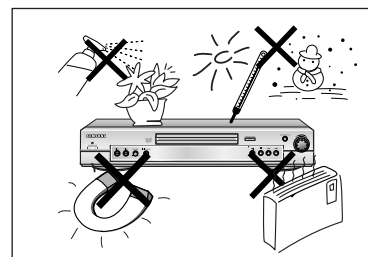

3

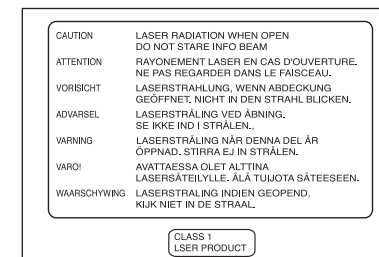

4

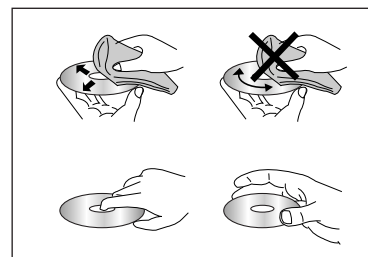

5

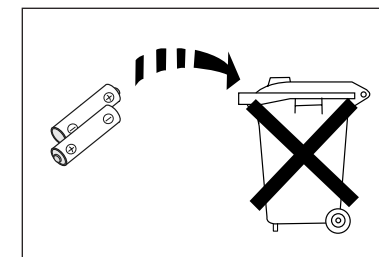

3

Before You Start

Accessories



Remote Control

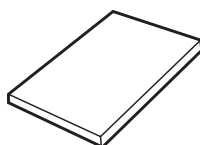

User's Manual



Batteries for
Remote Control (AA Size)

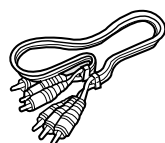

Video/Audio Cable

Install Batteries in the Remote

- 1 Open the battery cover on the back of the remote.
- 2 Insert two AA batteries. Make sure that the polarities (+ and -) are aligned correctly.
- 3 Replace the battery cover.

If remote doesn't operate properly:

- Check the polarity + - of the batteries (Dry-Cell)
- Check if the batteries are drained.
- Check if remote sensor is blocked by obstacles.
- Check if there is any fluorescent lighting nearby.

TABLE OF CONTENTS

General Features	6
Disc Type and Characteristics	7
Description-Front Panel	8
Display Indicators	10
Description-Rear Panel	11
Tour of the Remote Control.....	14
Choosing a Connection	20
Playing a Disc.....	22
Using the Search & Skip Functions	23
Using the Display Function.....	25
Repeat Play	26
Program Play & Random Play	27
S.FIT Play	28
Digest Play	29
Using the Disc View Function	30
Slow Repeat play	31
Selecting the Audio Language	32
Selecting the Subtitle Language	33
Changing the Camera Angle	34
Using the Instant Replay Function	35
Using the Bookmark Function.....	36
Using the Zoom & 3D Sound Functions	37
MP3 Play.....	38
Beginning Karaoke Functions.....	40
Reserving a Song	41
Vocal Function	42
Using the Setup Menu	43
Setting Up the Language Features	44
Setting Up the Parental Control	46
Setting Up the Audio Options	47
Surround Sound Speaker Setup	48
Setting Up the Display Options	49
Controlling a TV with the Remote	50
Troubleshooting.....	51
Specifications	52

SETUP

CONNECTIONS

BASIC
FUNCTIONS

ADVANCED
FUNCTIONS

KARAOKE
FUNCTIONS

CHANGING
SETUP MENU

REFERENCE

General Features

Excellent Sound

Dolby Digital, a technology developed by Dolby Laboratories provides crystal clear sound reproduction.

Screen

Video with MPEG-2 compression technology. Both regular and widescreen(16:9) pictures can be viewed.

Slow Motion

An important scene can be viewed in slow motion.

Programmed Play

You can program tracks to play in desired order.

Parental Control

The parental control allows users to set the level necessary to prohibit children from viewing harmful movies such as those with violence, adult subject matter, etc.

Various On-Screen Menu Functions

You can select various languages(Audio/Subtitle) and screen angles while enjoying movies.

Repeat

You can repeat a song or movie simply by pressing the REPEAT button.

MP3

This unit can play discs created from MP3 files.

Instant Replay

This function is used to replay the previous 10 seconds of the movie from the current position.

NOTE

* Discs which cannot be played with this player:



- DVD-ROM
- DVD-RAM
- CD-ROM
- CDV
- CDI
- HD layer of super Audio CD
- CDGs play audio only, not graphics.

* Ability to play back may depend on recording conditions:

- DVD-R
- DVD+RW, -RW
- CD-RW

Disc Type and Characteristics

This DVD player is capable of playing the following types of discs with the corresponding logos:

Disc Types (Logos)	Recording Types	Disc Size	Max. Playing Time	Characteristics
	Audio + Video	12 Cm	Single-sided 240 min. Double-sided 480 min.	<ul style="list-style-type: none"> • DVD contains excellent sound and video due to Dolby Digital and MPEG-2 system. • Various screen and audio functions can be easily selected through the on-screen menu.
		8 Cm	Single-sided 80 min. Double-sided 160 min.	
	Audio + Video	12 Cm	74 min.	<ul style="list-style-type: none"> • Video with CD sound, VHS quality & MPEG-1 compression technology.
		8 Cm	20 min.	
	Audio	12 Cm	74 min.	<ul style="list-style-type: none"> • CD is recorded as a Digital Signal with better audio quality, less distortion and less deterioration of audio quality over time.
		8 Cm	20 min.	

Disc Markings



• Play Region Number

PAL

• PAL broadcast system in U.K, France, Germany, etc.

DOLBY DIGITAL

• Dolby Digital disc

STEREO

• Stereo disc

DIGITAL SOUND

• Digital Audio disc

DTS

• DTS disc

MP3

• MP3 disc

Play Region Number

Both the DVD player and the discs are coded by region. These regional codes must match in order for the disc to play. If the codes do not match, the disc will not play.

The Region Number for this player is described on the rear panel of the player.

Description-Front Panel

DVD-S128/DVD-S228

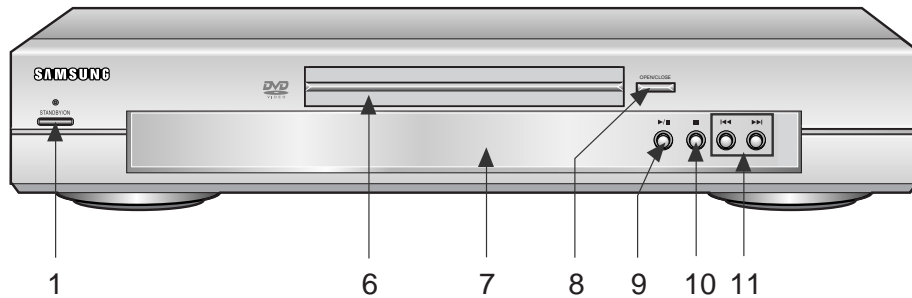

DVD-S328K

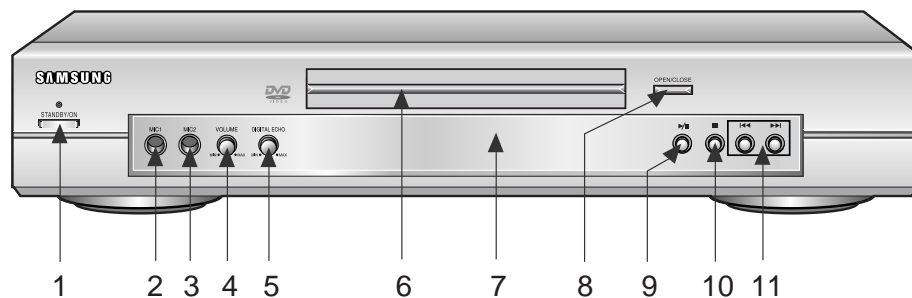

DVD-S428K

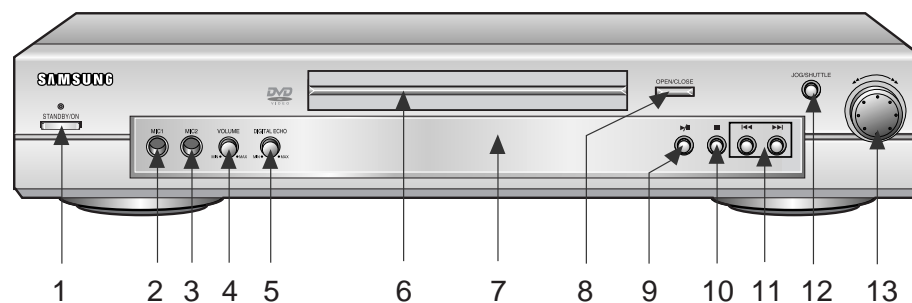

Description-Front Panel

Front Panel Controls

1. **STANDBY / ON**
 - When the unit is first plugged in, the indicator lights. When STANDBY/ON is pressed on again, the light goes out and the player is turned on.
2. **MIC 1**
 - Connect microphone 1 for Karaoke functions.
3. **MIC 2**
 - Connect microphone 2 for Karaoke functions.
4. **VOLUME**
 - Use to adjust microphone volume level.
5. **DIGITAL ECHO**
 - Use to adjust echo delay.
6. **DISC TRAY**
 - Load the disc here.
7. **DISPLAY**
 - Operation indicators are displayed here.
8. **OPEN/CLOSE**
 - Press to open and close the disc tray.
9. **PLAY/PAUSE**
 - Begin or pause disc play.
10. **STOP**
 - Stops disc play.
11. **SKIP**
 - Use to skip a scene or music.
12. **JOG**
 - Use to access certain Shuttle features with the Shuttle dial : When JOG is pressed, indicator lights up.
13. **SHUTTLE**
 - Use during DVD and CD play to fast forward or reverse. In JOG mode(JOG button pressed), used for frame advance/CD track selection.

Display Indicators

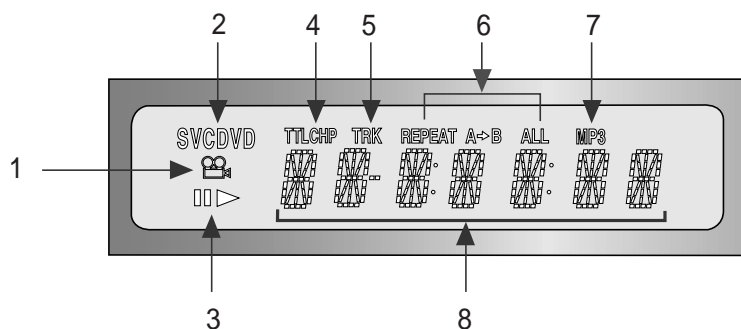

Front Panel Display

1. Angle indicator. You can select multiple angles of a scene recorded by different cameras.
2. Disc type indicators
3. Play / Pause / Forward play
4. DVD : Title, Chapter number.
5. Video/Audio CD : Track number
6. Repeat play mode
7. MP3 indicators
8. Displays various messages concerning operations such as PLAY, STOP, LOAD, ...
 - no DISC** : No disc loaded.
 - OPEN** : The disc tray is open.
 - LOAD** : Player is loading disc information.

Description-Rear Panel

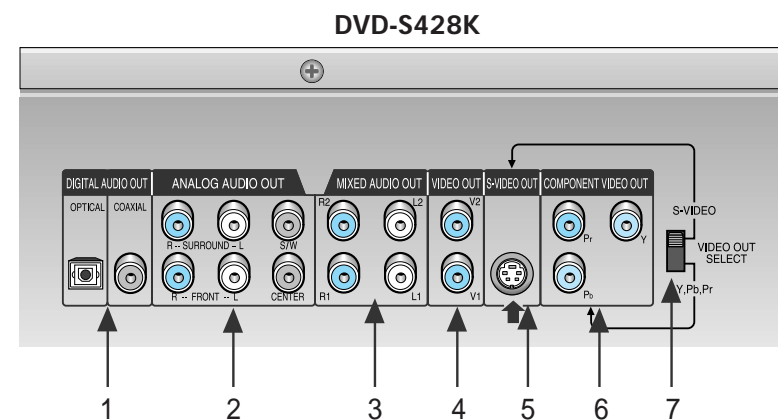

Rear Panel

1. **DIGITAL AUDIO OUT JACKS**
 - Use either an optical or coaxial digital cable to connect to a compatible Dolby Digital receiver. Use to connect to an A/V Amplifier that contains a Dolby Digital or DTS decoder.
2. **ANALOG AUDIO OUT JACKS**
 - Connect to an amplifier with 5.1ch analog input jacks.
3. **MIXED AUDIO OUT JACKS**
 - Connect to the Audio input jacks of your television, audio/video receiver, or VCR.
4. **VIDEO OUT JACKS**
 - Use a video cable to connect to the Video input jack on your television.
5. **S-VIDEO OUT JACK**
 - Use the S-Video cable to connect this jack to the S-Video jack on your television for a higher quality picture. The S-Video must be selected in the VIDEO OUT SELECT.
6. **COMPONENT VIDEO OUT JACKS**
 - Use these jacks if you have a TV with Component Video in jacks. These jacks provide Pr, Pb and Y video. Along with S-Video, Component Video provides the best picture quality. The Y, Pb, Pr must be selected in the VIDEO OUT SELECT.
7. **VIDEO OUT SELECT SWITCH**
 - Use the switch to set video out. If Y, Pb, Pr is selected, S-Video may not work. If S-Video is selected, Y, Pb, Pr may not work.

NOTE

- Select the VIDEO OUT SELECT switch in the Stop or Power Off mode.

Description-Rear Panel

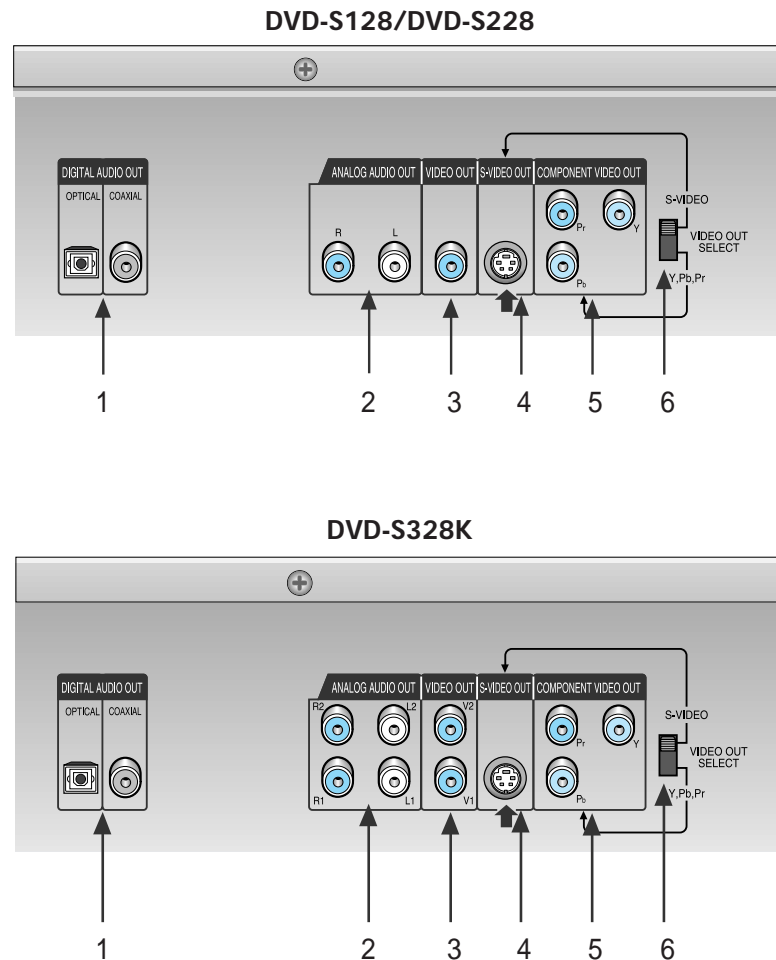

Description-Rear Panel

Rear Panel

1. DIGITAL AUDIO OUT JACKS

- Use either an optical or coaxial digital cable to connect to a compatible Dolby Digital receiver. Use to connect to an A/V Amplifier that contains a Dolby Digital or DTS decoder.

2. ANALOG AUDIO OUT JACKS

- Connect to the Audio input jacks of your television, audio/video receiver, or VCR.

3. VIDEO OUT JACKS

- Use a video cable to connect to the Video input jack on your television.

4. S-VIDEO OUT JACK

- Use the S-Video cable to connect this jack to the S-Video jack on your television for a higher quality picture. The S-Video must be selected in the VIDEO OUT SELECT.

5. COMPONENT VIDEO OUT JACKS

- Use these jacks if you have a TV with Component Video in jacks. These jacks provide Pr, Pb and Y video. Along with S-Video, Component Video provides the best picture quality. The Y, Pb, Pr must be selected in the VIDEO OUT SELECT.

6. VIDEO OUT SELECT SWITCH

- Use the switch to set video out. If Y, Pb, Pr is selected, S-Video may not work. If S-Video is selected, Y, Pb, Pr may not work.

NOTE

- Select the VIDEO OUT SELECT switch in the Stop or Power Off mode.

Tour of the Remote Control

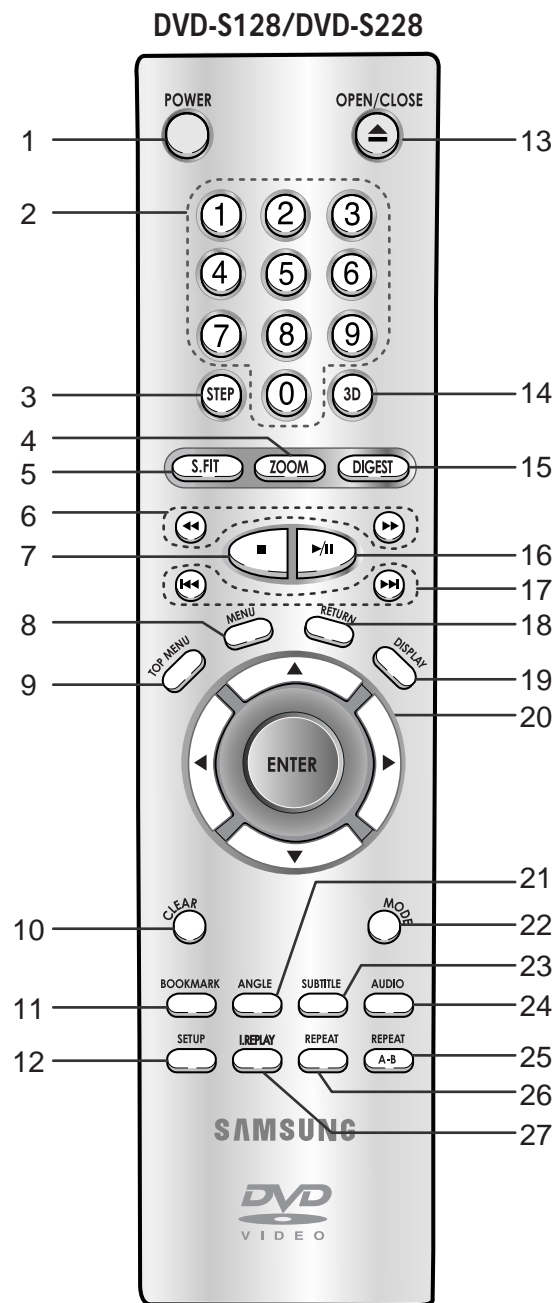

Tour of the Remote Control

DVD Function Buttons

1. **DVD POWER Button**
2. **NUMBER Buttons**
3. **STEP Button**
 - Advances play one frame at a time.
4. **ZOOM Button**
5. **S.FIT Button**
6. **SEARCH Buttons**
 - Allows you to search forward/backward through a disc.
7. **STOP Button**
8. **MENU Button**
 - Brings up the Disc menu.
9. **TOP MENU Button**
10. **CLEAR Button**
 - Use to remove menus or status displays from the screen.
11. **BOOKMARK Button**
12. **SETUP Button**
 - Brings up the DVD player's Setup menu.
13. **OPEN/CLOSE Button**
14. **3D Button**
15. **DIGEST Button**
16. **PLAY/PAUSE Button**
 - Begin/Pause disc play.
17. **SKIP Buttons**
 - Use to skip the title, chapter, or track.
18. **RETURN Button**
 - Returns to a previous menu.
19. **DISPLAY Button**
 - Displays the current disc mode.
20. **ENTER/DIRECTION Button (UP/DOWN or LEFT/RIGHT Buttons)**
 - This button functions as a toggle switch.
21. **ANGLE Button**
 - Use to access various camera angles on a DVD.
22. **MODE Button**
 - Allows you to program a specific order.
23. **SUBTITLE Button**
24. **AUDIO Button**
 - Use this button to access various audio functions on a disc.
25. **REPEAT A-B Button**
 - Use to mark a segment to repeat between A and B.
26. **REPEAT Button**
 - Allows you to repeat play a title, chapter, track, or disc.
27. **I.REPLAY Button**
 - This function is used to replay the previous 10 seconds of the movie from the current position.

Tour of the Remote Control

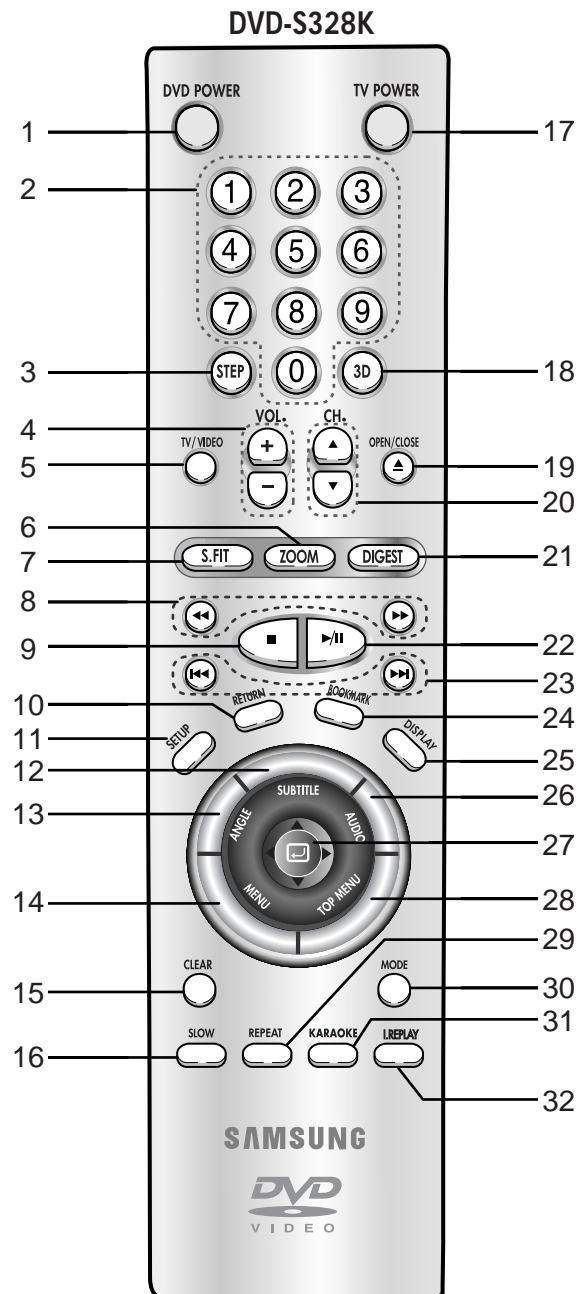

Tour of the Remote Control

DVD Function Buttons

1. DVD POWER Button
2. NUMBER Buttons
3. STEP Button
4. VOLUME Buttons
5. TV/VIDEO Button
6. ZOOM Button
7. S.FIT Button
8. SEARCH Buttons
 - Allows you to search forward/backward through a disc.
9. STOP Button
10. RETURN Button
 - Returns to a previous menu.
11. SETUP Button
 - Brings up the DVD player's Setup menu.
12. SUBTITLE Button
13. ANGLE Button
 - Use to access various camera angles on a DVD.
14. MENU Button
 - Brings up the Disc menu.
15. CLEAR Button
 - Use to remove menus or status displays from the screen.
16. SLOW Button
17. TV POWER Button
18. 3D Button
19. OPEN/CLOSE Button
20. CHANNEL Buttons
21. DIGEST Button
22. PLAY/PAUSE Button
 - Begin/Pause disc play.
23. SKIP Buttons
 - Use to skip the title, chapter, or track.
24. BOOKMARK Button
25. DISPLAY Button
 - Displays the current disc mode.
26. AUDIO Button
 - Use this button to access various audio functions on a disc.
27. ENTER/DIRECTION Button (UP/DOWN or LEFT/RIGHT Button)
 - This button functions as a toggle switch.
28. TOP MENU Button
29. REPEAT Button
 - Allows you to repeat play a title, chapter, track, or disc.
30. MODE Button
 - Allows you to program a specific order.
31. KARAOKE Button
 - Use to begin Karaoke functions.
32. I.REPLAY Button
 - This function is used to replay the previous 10 seconds of the movie from the current position.

Tour of the Remote Control

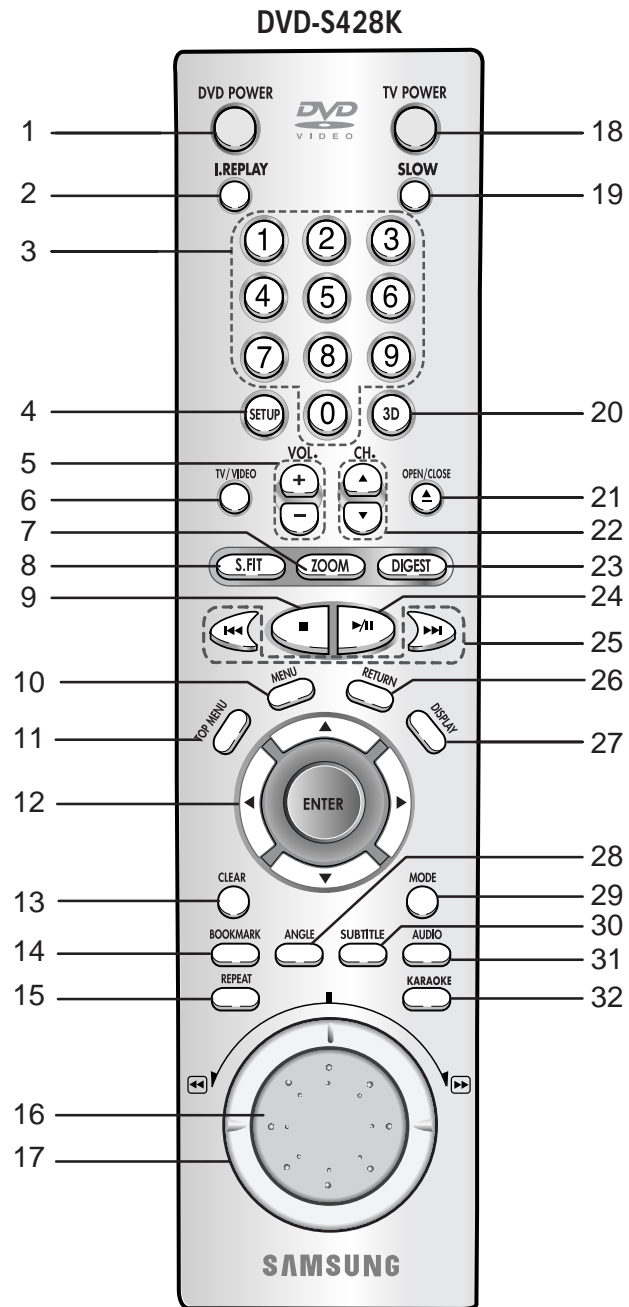

18

Tour of the Remote Control

DVD Function Buttons

1. **DVD POWER Button**
2. **I.REPLAY Button**
 - This function is used to replay the previous 10 seconds of the movie from the current position.
3. **NUMBER Buttons**
4. **SETUP Button**
 - Brings up the DVD player's Setup menu.
5. **VOLUME Buttons**
6. **TV/VIDEO Button**
7. **ZOOM Button**
8. **S.FIT Button**
9. **STOP Button**
10. **MENU Button**
 - Brings up the Disc menu.
11. **TOP MENU Button**
12. **ENTER/DIRECTION Button (UP/DOWN or LEFT/RIGHT buttons)**
 - This button functions as a toggle switch.
13. **CLEAR Button**
 - Use to remove menus or status displays from the screen.
14. **BOOKMARK Button**
15. **REPEAT Button**
 - Allows you to repeat play a title, chapter, track, or disc.
16. **JOG DIAL**
 - Operates frame by frame play. In CD mode, performs track search.
17. **SHUTTLE DIAL**
 - Performs fast or slow motion play.
18. **TV POWER Button**
19. **SLOW Button**
20. **3D Button**
21. **OPEN/CLOSE Button**
22. **CHANNEL Buttons**
23. **DIGEST Button**
24. **PLAY/PAUSE Button**
 - Begin/Pause disc play.
25. **SKIP Buttons**
 - Use to skip the title, chapter, or track.
26. **RETURN Button**
 - Returns to a previous menu.
27. **DISPLAY Button**
 - Displays the current disc mode.
28. **ANGLE Button**
 - Use to access various camera angles on a DVD.
29. **MODE Button**
 - Allows you to program a specific order.
30. **SUBTITLE Button**
31. **AUDIO Button**
 - Use this button to access various audio functions on a disc.
32. **KARAOKE Button**
 - Use to begin Karaoke functions.

SETUP

19

Choosing a Connection

The following show examples of connections commonly used to connect the DVD player with a TV and other components.

Before Connecting the DVD Player

- Always turn off the DVD player, TV, and other components before you connect or disconnect any cables.
- Refer to the owner's manual of the additional components you are connecting for more information on those particular components.

Connection to an Audio System

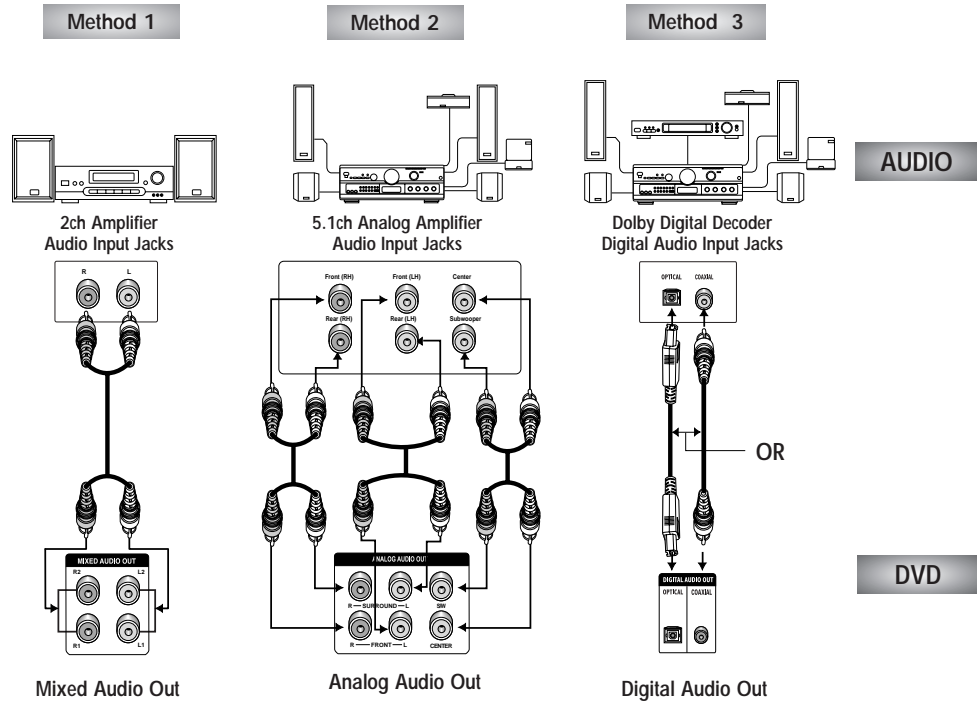

Choosing a Connection

Connection to a TV (For Video)

TV (Normal, Widescreen, Projection, etc..)

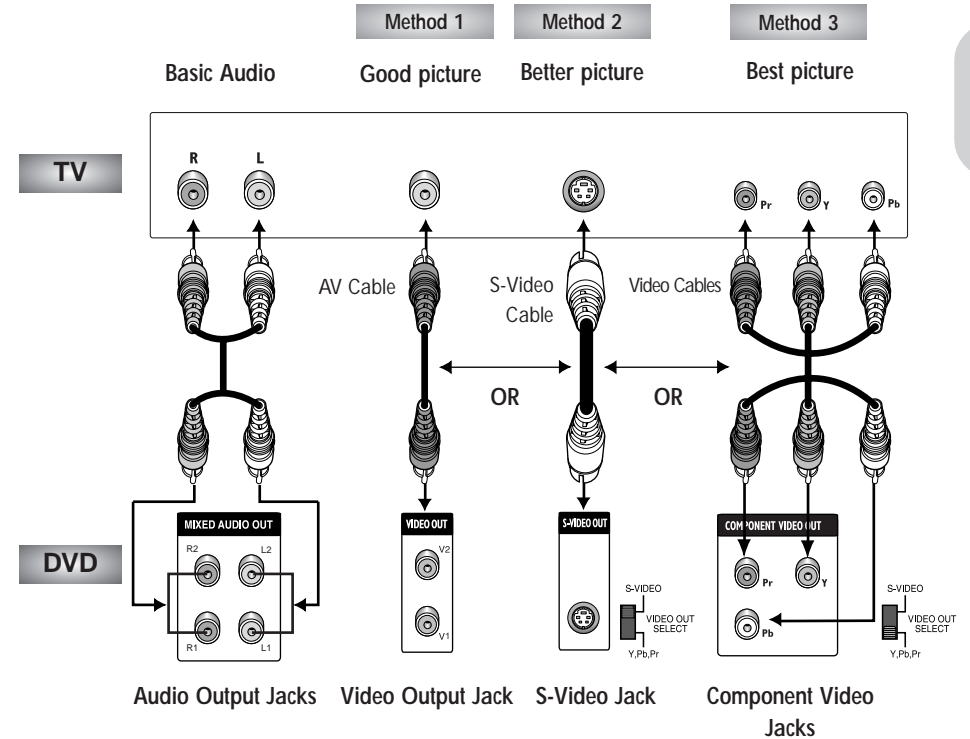

- **Method 1** DVD Player + TV with Video Input Jack
- **Method 2** DVD Player + TV with S-Video Input Jack (If S-Video is selected in the VIDEO OUT SELECT.)
- **Method 3** DVD Player + TV with Component Video Jacks (If Y, Pb or Pr is selected in the VIDEO OUT SELECT.)

NOTE

- If Y, Pb or Pr is selected, S-Video will not work.
- If S-Video is selected, Y, Pb or Pr will not work.

Playing a Disc

Before Play

- Turn on your TV and press the TV/VIDEO button to select the video mode.
- Turn on your Audio System and select AUX, CD or DVD.

After plugging in the player, the first time you press the DVD POWER button, this screen comes up :

If you want to select the language, press a NUMBER button.

(This screen will only appear the very first time you plug in the player.)

SELECT MENU LANGUAGE

Press	1	for English
Touche	2	pour Français
Drücke	3	für Deutsch
Pulsar	4	para Español
Premere	5	per Italiano
Toets	6	voor Nederlands

Play

- 1 Press the OPEN/CLOSE button.
The STANDBY indicator light goes out and the tray opens.
- 2 Place a disc gently into the tray with the disc's label facing up.
- 3 Press the PLAY/PAUSE button or OPEN/CLOSE button to close the disc tray.
- 4 Stopping Play
Press the STOP button during play.
- 5 Removing Disc
Press the OPEN/CLOSE button.
- 6 Pausing Play
Press the PLAY/PAUSE or STEP button on the remote during play.
 - Screen stops, no sound.
 - To resume again, press PLAY/PAUSE button once again.

Playing a Disc

7 Step Motion Play. (Except CD)

DVD-S428K : If turning JOG DIAL, you can view one by one.

DVD-S128/DVD-S228/DVD-S328K : Press the STEP button on the remote during play.

- Each time the button is pressed, a new frame will appear.
- No sound is heard during STEP mode.
- Press PLAY/PAUSE to resume normal play.
(You can only perform step motion play in the forward direction.)

8 Slow Motion Play. (Except CD)

DVD-S128/DVD-S228/DVD-S328K : Press the FWD SEARCH (▶▶) or REV SEARCH (◀◀) button on the remote during PAUSE or STEP mode. By pressing the FWD SEARCH (▶▶) or REV SEARCH (◀◀) button, you can select slow motion play for 1/8, 1/4 or 1/2 of normal speed.

DVD-S428K : Press and hold the forward SKIP button to choose the play speed between 1/8, 1/4, and 1/2 of normal.

- No sound is heard during slow mode.
- Press PLAY/PAUSE to resume normal play.
- When playing a VCD, the reverse slow motion play will not work.

RESUME function

When you stop disc play, the player remembers where you stopped, so when you press PLAY again, it will pick up where you left off (unless the disc is removed, the STOP button is pressed twice or the player is unplugged.).

NOTE

- If the player is left for 5 minutes in pause mode, it will stop.
- If the player is left in the stop mode for more than 30 minutes, the power will automatically shut off. (Automatic Power-Off Function) (DVD-S128/DVD-S228 only)
- If the player is left in the stop mode for more than one minute without any user interaction, a screen saver will be activated, and the TV screen will fade in and out repeatedly. Press the PLAY button to resume normal play.
- This  icon indicates an invalid button press.

Using the Search & Skip Functions

During play, you can search quickly through a chapter or track or use the skip function to jump to the next selection.

Searching through a Chapter or Track

1 DVD-S128/DVD-S228/DVD-S328K : Press the REVERSE or FORWARD SEARCH button on the remote and press again to search at a faster speed on the DVD, VCD, CD.

DVD-S428K : Turn the shuttle diad of remote control during disc play. Turn the Jog/Shuttle on the front can amultiple-speed operation if desiring to use the key on the front.

DVD	2X, 4X, 8X, 16X, 32X, 128X
VCD	4X, 8X
CD	2X, 4X, 8X

- Depending on the disc, audio may not be heard when a disc is in 2X play mode.

Skipping Tracks

1 During play, press the NEXT SKIP or BACK SKIP button.

- When playing a DVD, if you press the NEXT SKIP button, it moves to the next chapter. If you press the BACK SKIP button, it moves to the beginning of the chapter. One more press makes it move to the beginning of the previous chapter.
- When playing a VCD 2.0 in MENU OFF mode, a VCD 1.1 or a CD, if you press the NEXT SKIP button, it moves to the next track. If you press the BACK SKIP button, it moves to the beginning of the track. One more press makes it move to the beginning of the previous track.
- If a track exceeds 15 minutes when playing a VCD and you press the NEXT SKIP button, it moves forward 5 minutes. If you press the BACK SKIP button, it moves backward 5 minutes.
- When playing a VCD 2.0 in the MENU OFF or Track View function, if you press the NEXT SKIP button, it moves to the next MENU or the next Track View display.
If you press the BACK SKIP button, it moves to the previous MENU or the previous Track View display. (See page 30.)

Using the Display Function

When Playing a DVD

1 During play, press the DISPLAY button on the remote.

- Current title, chapter number, elapsed time, audio, subtitle and volume control will be displayed.
- Use the NUMBER buttons to enter a different title, then press the ENTER button.
- Use the LEFT/RIGHT or NUMBER buttons to enter a chapter number, then press the ENTER button.
- To enter the time from which you want to start, use the UP/DOWN buttons to select, then use the NUMBER buttons to enter the time. Then press the ENTER button.
- Use the LEFT/RIGHT buttons to change the values of the current audio, subtitle and volume.
- To make the screen disappear, press the DISPLAY button again.



When Playing a CD/VCD

1 During play, press the DISPLAY button on the remote.

- Current track NUMBER, elapsed time and volume control will be displayed.
- Use the UP/DOWN buttons to select a track. Use the LEFT/RIGHT buttons or NUMBER buttons to enter a different track number, then press the ENTER button.
- To enter the time from which you want to start, use the UP/DOWN buttons to select, then use the NUMBER buttons to enter the time. Press the ENTER button.
- To change the value of the volume, use the LEFT/RIGHT buttons.
- To make the screen disappear, press the DISPLAY button again.
- * In VCD 2.0 mode (MENU ON mode), only the volume control will appear on screen.

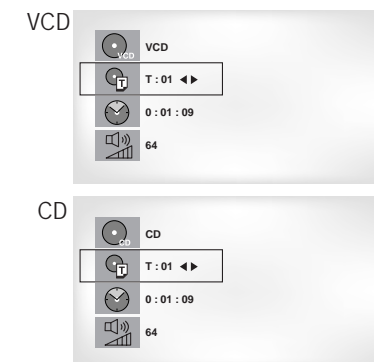

NOTE

What is a Chapter?

Each Title on a DVD is usually divided into chapters (similar to tracks on an audio CD).

What is a Title?

A DVD may contain several different titles. For example, if a disc contains four different movies, each might be considered a title.

Repeat Play

Repeat the current track, chapter, title, a chosen section (A-B), or all of the disc.

When playing a DVD

- 1 Press the REPEAT button on the remote. Repeat screen appears.
- 2 Select Chapter, Title or A-B using the LEFT/RIGHT buttons.
 - Repeat A-B
 - Press the REPEAT button. Select A-B on screen with the LEFT/RIGHT buttons or press the A-B button on the remote.
 - Press ENTER at the point where you want the repeat play to start (A). The B is automatically highlighted.
 - Press ENTER at the point where you want the repeat play to stop (B).
- 3 Press ENTER.
- 4 To return to normal play, press REPEAT again, then press the LEFT/RIGHT buttons to select Off and press ENTER.

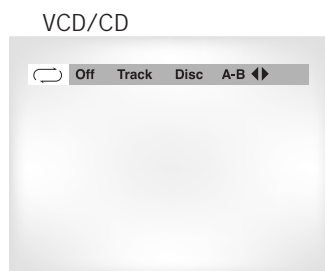
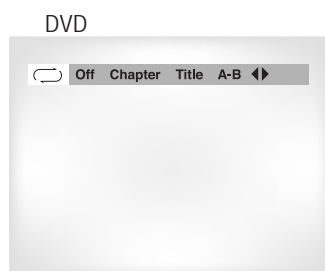

NOTE

- DVD repeats play by chapter or title, CD and VCD repeat play by disc or track. See page 34 to MP3 disc repeat play.
- Depending on the disc, the Repeat function may not work.
- If the title or track is completed before marking the end (B), the end of title or track becomes B automatically.
- When in VCD 2.0 mode (MENU ON mode), this function does not work.

Program Play & Random Play

Program Play (DVD/VCD/CD/MP3)

- 1 Press the MODE button.
- 2 Use the LEFT/RIGHT buttons to select PROGRAM. Press the ENTER button.
- 3 Use the LEFT/RIGHT buttons to select the first chapter (or track) to add to the program. Press the ENTER button. The selection numbers appear in the Program Order box.
- 4 Press the PLAY/PAUSE button. The disc will be played in programmed order.

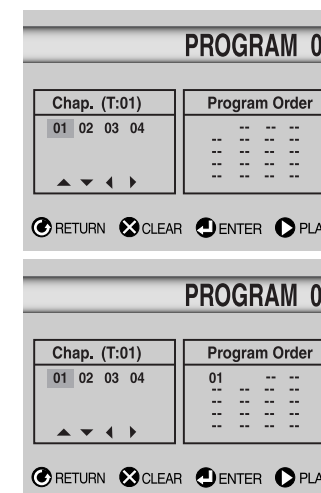

Random Play (DVD/VCD/CD/MP3)

- 1 Press the MODE button.
- 2 Use the LEFT/RIGHT buttons to select RANDOM. Press the ENTER button. The disc will be played in random order.



NOTE

- Depending on the disc, the Program and Random Play function may not work.
- When in VCD 2.0 mode (MENU ON mode), these functions do not work.
- To resume normal play, press the CLEAR button.

S.FIT Play

Screen Fit Play

- 1 During play, press S.FIT button on remote control.
 - Allows you to eliminate the black bars in the top and bottom of the screen when a movie is playing in the Widescreen format(16:9).
 - Screen Fit will not work when the Zoom mode is active. (you can not remove the black bars on the screen) However, Zoom mode will work when Screen Fit is active.

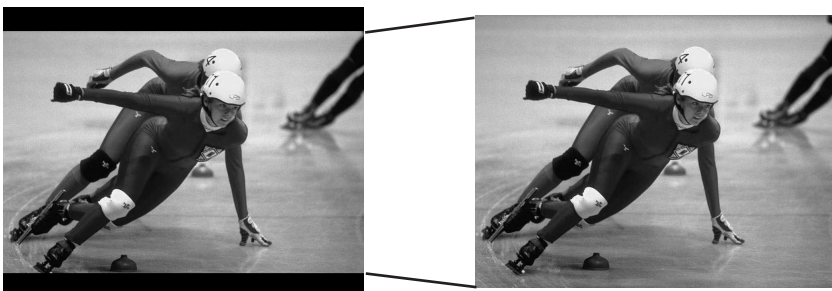

NOTE

- Various aspect ratios are available only in multiple screen format discs.
- This function does not work when a DVD has been recorded with a multi-camera angle format.
- On some DVDs, the black bars cannot be eliminated due to their aspect ratio.

Digest Play

Digest Play

- 1 During play, press the DIGEST button.
 - You'll see the 9 individual windows representing each of the chapters on the TV screen.
 - When each window is displayed, the first 3 seconds of the chapter will be played.
- 2 Press UP/DOWN/LEFT/RIGHT buttons or NUMBER buttons to select the window you'd like to see, and press the ENTER button.
 - Up to 9 windows(chapters) can be displayed on the screen at a time.
 - Press the 'Skip' button for the next 9 chapters if the movie has more than 9.

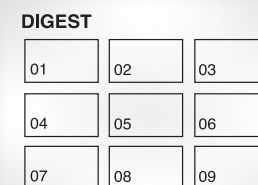

SKIP button



NOTE

- You can play the DVD player starting with the desired chapter after directly moving to the scene you want.
- 'DIGEST' may not operate depending on the disc in use.

Using the Disc View Function

Track View (VCD)

Displays the beginning view of each track and the track number.

- 1 During play, press the TOP MENU button.
- 2 Press the UP/DOWN buttons to select TRACK VIEW. Press the ENTER button.
- 3 Select the desired view by pressing the UP/DOWN or LEFT/RIGHT buttons.
- Press the SKIP button for the next 9 tracks if the movie has more than 9.
- 4 Press the ENTER button.

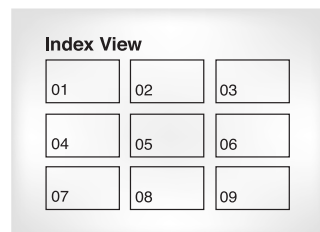
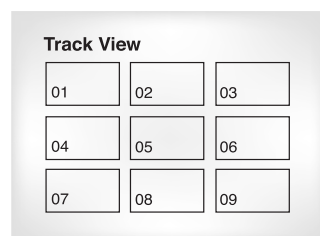
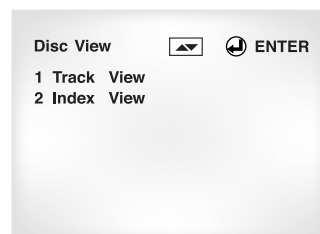

Index View (VCD)

Displays the equally divided 9 views of the current playing track.

- 1 During play, press the TOP MENU button.
- 2 Press UP/DOWN buttons to select INDEX VIEW. Press the ENTER button.
- 3 Select the desired view by pressing UP/DOWN or LEFT/RIGHT buttons.
- 4 Press the ENTER button.

NOTE

- When pressing the TOP MENU button with a DVD; the disc's TITLE MENU function comes up. A disc must have at least two titles for the TITLE MENU function to work.
- When pressing the TOP MENU button with a CD; the unit enters the INTRO mode. INTRO lets you listen to the beginning of each track for about 10 seconds.
- You can also operate it using the DIGEST button.

Slow Repeat play

This feature allows you slowly repeat scenes containing sports, dancing, musical instruments being played etc. so you can study them more closely.

When playing a DVD

- 1 Press the PLAY/PAUSE button.
- 2 Press and hold the SKIP button to choose the play speed between 1/8X, 1/4X, and 1/2X of normal. (DVD-S428K only)
Press the FORWARD SEARCH button to choose the play speed between 1/8X, 1/4X, and 1/2X of normal. (DVD-S128/DVD-S228/DVD-S328K only)
- 3 Press the "REPEAT A-B" of the remote control once at the first section to repeat while the multiple-speed is selected (A-point selection).
- 4 Press the "REPEAT A-B" button again (B-point selection).

NOTE

- The disc will play from A to B repeatedly at the speed you chose.
- To terminate the function, press the 'CLEAR' button or the 'REPEAT (A-B)' button again. Then press play to resume normal playback.
- A-B REPEAT does not allow you to set point (B) until at least 5 seconds has elapsed after point (A) has been set.

Selecting the Audio Language

You can select a desired language quickly and easily with the AUDIO button.

Using the AUDIO button

- 1 Press the AUDIO button.
- 2 Use the UP/DOWN buttons to select the desired language on a DVD.
- The audio languages are represented by abbreviations.
- 3 Use the UP/DOWN buttons to select Stereo, Right or Left. (On VCD/CD)

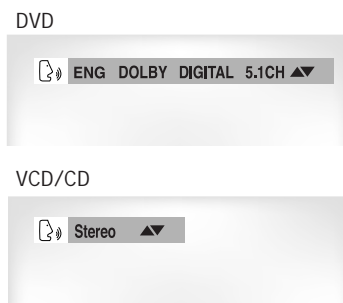

NOTE

- This function depends on what languages are encoded on the disc and may not work with all DVDs.
- A DVD disc can contain up to 8 audio languages.
- **How to have the same audio language come up whenever you play a DVD;**
Refer to "Setting Up the Language Features" on page 45.

Selecting the Subtitle Language

You can select a desired subtitle quickly and easily with the SUBTITLE button.

Using the SUBTITLE button

- 1 Press the SUBTITLE button.
- 2 Use the UP/DOWN buttons to select the desired subtitle language.
- 3 Use the LEFT/RIGHT buttons to determine whether or not the subtitle will be displayed.
- Initially, the subtitling will not appear on screen.
- The subtitle languages are represented by abbreviations.

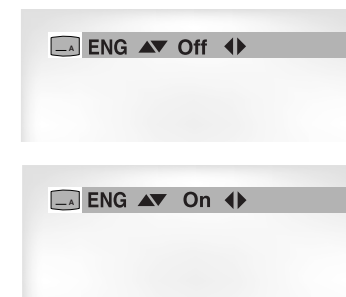

NOTE

- This function depends on what languages are encoded on the disc and may not work with all DVDs.
- A DVD disc can contain up to 32 subtitle languages.
- **How to have the same subtitle language come up whenever you play a DVD;**
Refer to "Setting Up the Language Features" on page 45.

Changing the Camera Angle

When a DVD contains multiple angles of a particular scene, you can select the Angle function.

Using the ANGLE button

Press the ANGLE button to see if an ANGLE () mark is present at the upper right hand corner of the screen.

- 1 When an ANGLE mark is shown, press the ANGLE button, then an ANGLE select icon will appear at the upper left hand corner of the screen.
- 2 Use the UP/DOWN buttons to select the desired screen angle.
- 3 To turn off the display, press the ANGLE button again.



Using the Instant Replay Function

Using the Instant Replay function (DVD)

If you miss a scene, you can see it again using this function.

- 1 If you press the I.REPLAY button, the current scene moves backward about 10 seconds, and plays back.

* Depending on the disc, the Instant Replay function may not work.

Instant Replay

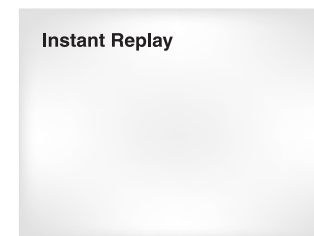

Using the Bookmark Function

The Bookmark function lets you select parts of a DVD or VCD (MENU OFF mode) so that you can quickly find the section at a later time.

Using the Bookmark Function (DVD/VCD)

- 1 During play, press the BOOKMARK button on the remote. The Bookmark icons will be displayed.
- 2 Use the LEFT/RIGHT buttons to move to the desired bookmark icon.
- 3 When you reach the scene you want to mark, press the ENTER button. The icon will change to a number (1, 2, or 3).
- 4 Press the BOOKMARK button to turn off the display.



Recalling a Marked Scene

- 1 During play, press the BOOKMARK button on the remote.
- 2 Use the LEFT/RIGHT buttons to select a marked scene.
- 3 Press the PLAY/PAUSE button to skip to the marked scene.



Clearing a Bookmark

- 1 During play, press the BOOKMARK button on the remote.
- 2 Use the LEFT/RIGHT buttons to select the bookmark number you want to delete.
- 3 Press the CLEAR button to delete a bookmark number. Press the BOOKMARK button to turn off display.

NOTE

- Up to three scenes may be marked at a time.
- When in VCD 2.0 mode (MENU ON mode), this function does not work.
- Depending on the disc, the Bookmark function may not work.

Using the Zoom & 3D Sound Functions

Using the Zoom Function (DVD/VCD)

- 1 During play or pause mode, press the ZOOM button on the remote. A square will be displayed on screen.
- 2 Use the UP/DOWN or LEFT/RIGHT button to select the part of the screen you want to zoom in on.
- 3 Press the ENTER button.
 - During DVD play, press ENTER to zoom in 2X/4X/2X/Normal in order.
 - During VCD play, press ENTER to zoom in 2X/normal in order.

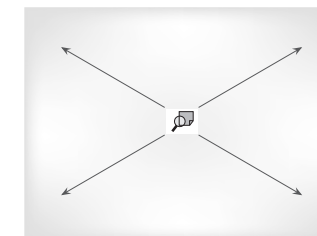

Using the 3D Sound Function

The simulated surround effect depends on the disc contents. If you connect the unit to your stereo system, you can enhance sound quality and produce a greater surround effect. This feature is useful when you are using the DVD player with a two channel stereo through the analog outputs. (Discs which are recorded with LPCM or DTS will not work. When the DIGITAL OUTPUT is set to BITSTREAM in the SETUP MENU, the 3D Sound function will not work.)

- 1 During play, press the 3D button. The 3D SOUND mark will be displayed on screen. (Be sure the DIGITAL OUTPUT is set to PCM.)
- 2 Press the UP/DOWN buttons to turn the 3D Sound feature on or off.

NOTE

- 3D Sound is possible only on discs recorded using DOLBY SURROUND or DOLBY DIGITAL. However, some of these discs do not contain rear channel sound signals.
- Depending on the disc, the Zoom and 3D Sound function may not work.



MP3 Play

When an MP3 Disc is inserted into the DVD PLAYER, the first song file of the first folder plays.

MP3 Play Function

1 Press STOP to stop playback of the first song file, then press RETURN to display the music folder menu on the right side of the screen. Up to 8 music folders can be displayed at a time. If you have more than 8 folders on a disc, press the LEFT/RIGHT buttons to bring them up on the screen.

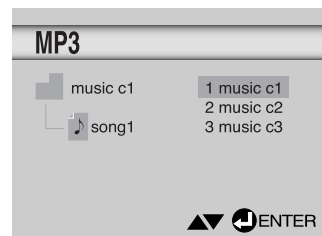

2 Use the UP/DOWN buttons to select the desired music folder, then press ENTER. Use the UP/DOWN buttons again to select a song file. Press ENTER to begin playback of the song file.

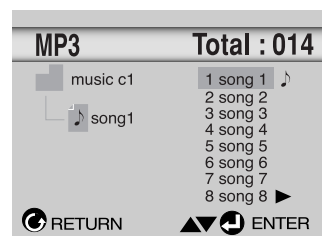

Program/Random playback

Press the MODE button to switch between the RANDOM and PROGRAM modes. See page 27 for more information on these modes.



NOTE

- Press the REPEAT button to hear a song file repeatedly. Press Repeat again to release the Repeat mode.

MP3 Play

CD-R MP3 disc requirements

When playing CD-R MP3 discs, please follow the recommendations below:

- **Your MP3 files should be ISO 9660 or JOLIET format.**
ISO 9660 format and Joliet MP3 files are compatible with Microsoft's DOS and Windows, and with Apple's Mac. These two formats are the most widely used.
- **When naming your MP3 files do not exceed 8 characters, and place ".mp3" as the file extension.**
General name format of: Title.mp3. When composing your title, make sure that you use 8 characters or less, have no spaces in the name, and avoid the use of special characters including: (.,/\,=,+).
- **Use a decompression transfer rate of at least 128 Kbps when recording MP3 files.**
Sound quality with MP3 files basically depends on the rate of compression/decompression you choose. Getting audio CD quality sound requires an analog/digital sampling rate (conversion to MP3 format) of at least 128 Kbps and up to 160 Kbps. However, choosing higher rates, like 192 Kbps or more, only rarely give better sound quality. Conversely, files with sampling rates below 128 Kbps will not be played properly.
- **Do not try recording copyright protected MP3 files.**
Certain "securized" files are encrypted and code protected to prevent illegal copying. These files are of the following types: Windows Media™ (registered trade mark of Microsoft Inc) and SDMI™ (registered trade mark of The SDMI Foundation). You cannot copy such files.
- **Your DVD player only accepts one level of file directory.**
Consequently you must choose:
 - either to save all your MP3 recording files at the root of the disc;
 - and/or create folders in the directory for each artist or music type (e.g.classical, rock, jazz, etc)
- **Important:** The above recommendations cannot be taken as a guarantee that the DVD player will play MP3 recordings, or as an assurance of sound quality.
You should note that certain technologies and methods for MP3 file recording on CD-Rs prevent optimal playback of these files on your DVD player (degraded sound quality and in some cases, inability of the player to read the files).

Beginning Karaoke Functions (DVD-S328K/DVD-S428K only)

Operation Sequence

- 1 Connect the Mixed Audio Out terminals with the TV or AMP.
- 2 Press the power button.
- 3 Connect Mic into Mic 1 or Mic 2 jack. Then the karaoke mode is transferred to ON mode.
- To disconnect the Mic makes the karaoke mode transfer to OFF mode automatically.

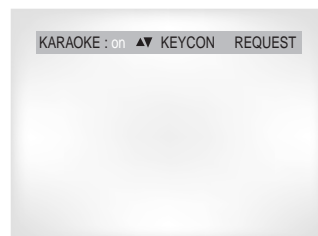

Key Control

- 1 Pressing the KARAOKE button makes the karaoke ON mode.
- 2 Select the "KEYCON" using the LEFT/RIGHT buttons.
- 3 By use of the LEFT/RIGHT buttons, change to the desired tone.
 ♭ : To let 7 scales down by half scale.
 ♮ : Original scale.
 # : To let 7 scales up by half scale.



NOTE

- Key control function is not applied to the Mic output.
- If you hear strange noises(squealing or howling) while using the karaoke feature, move the microphone away from the speakers. Turning down the microphone volume or the speaker volume is also effective.
- MIC does not operate when KARAOKE is in OFF mode.
- The next music plays if performing SEARCH with SCORE displayed in the SCORE ON MODE for CD or VCD.
- When playing MP3 disc, MIC & Karaoke functions are not operate.

Reserving a Song (DVD-S328K/DVD-S428K only)

It is the function to reserve the desired song in advance by use of Karaoke function

Sequence of reservation

- 1 Playback the Karaoke Disc containing the wanted songs.
- 2 After pushing the KARAOKE button of the remote transfer to the Karaoke ON mode using the UP/DOWN buttons.
- 3 Select the "REQUEST" using the LEFT/RIGHT buttons.
- 4 Input the number (Track No.) of the desired song into the flickering part(--).
- You can reserve up to 10 songs.
- 5 When you want the next reserved song during playing a song, press the SKIP button.



Cancellation of reservation

- 1 Cancel by pressing the CLEAR button of the remote.
- The last reserved song will be erased first.
- 2 Continuous pressing of the CLEAR button can cancel the next reserved song.
- 3 If the reservation is required again, input the song number in the flickering part.

NOTE

- Request function is available only when the Karaoke mode is "ON".
- When using "SKIP" button, it can not work at the last song.
- When using Request function, the "DISPLAY" and "REPEAT" function does not work.

Vocal Function

(DVD-S328K/DVD-S428K only)

Sequence of reservation

- 1** Pressing the KARAOKE button twice displays the following in Karaoke ON mode:

VOCAL FADER : off ◀▶
GUIDE MELODY : off
SCORE MODE : off

Vocal Fader

- The function to make the music only sound by cancelling vocal when playing a Karaoke disc.

	VOCAL FADER	Remark
↓	V1	CH1. Vocal Cancel
↓	V2	CH2. Vocal Cancel
↓	1 + 2	CH1, CH2. Vocal Cancel
↓	OFF	Vocal Fader Off

- In VCD, CVD or CD, you can select only the ON or OFF.

Guide Melody

- To guide melody through xylophone and piano help you sing easily.
- This function works only on the DVD Karaoke disc on which the guide melody is recorded.

Score Function

- Press KARAOKE button twice to turn the Score Mode On.
- Score will pop up whenever a song is completed.

CAUTIONS

- Make sure to turn the KARAOKE MODE to OFF to play a movie disc or play in a general mode. If you play a movie disc with the SCORE ON, a score will show up every time when a chapter is over.

Types of Karaoke disc

• DVD Karaoke Disc

Channel	Karaoke -Channel	5CH. DVD	2CH. DVD
1 CH	L	Left stereo music	Left stereo music + Vocal
2 CH	R	Right stereo music	Right stereo music + Vocal
3 CH	M	Guide melody	-
4 CH	V1	Vocal track	-
5 CH	V2	Vocal track	-

• CVD, VCD Karaoke Disc

Channel	Karaoke -Channel	CVD	VCD, CD
1 CH	CH1 LEFT	Left stereo music + Vocal	Left stereo music
1 CH	CH1 RIGHT	Right stereo music + Vocal	Right stereo music + Vocal
2 CH	CH2 LEFT	Left stereo music	-
2 CH	CH2 RIGHT	Right stereo music	-

Using the Setup Menu

The Setup menu lets you customize your DVD player by allowing you to select various language preferences, set up a parental level, even adjust the player to the type of television screen you have.

- 1** With the unit in Stop mode, press the SETUP button on the remote.

- 1 Player Menu** : Setup of the Display Language
Use the Player preference menu to select the language for the player's on-screen displays.
- 2 Disc Menu** : Setup of the Menu Language
Use the Menu preference menu to select the language you want a DVD's disc menu to be displayed in.
- 3 Audio** : Setup of the Audio Language
Use the Audio preference menu to select the soundtrack language.
- 4 Subtitle** : Setup of the Subtitle Language
Use the Subtitle preference menu to select the language the disc's subtitles are to be displayed in.
- 5 Parental** : Setup of the Parental Level
Allows users to set the level necessary to prevent children from viewing unsuitable movies such as those with violence, adult subject matter, etc.
- 6 Audio Options** : Setup of the Audio Options
- 7 Display Options** : Setup of the Display Options
Use to select which type of screen you want to watch and several display options.

- 2** Use the UP/DOWN buttons on the remote to access the different features.

- 3** Press the ENTER button to access the sub features.

To make the setup screen disappear after setting up, press the SETUP button again.

SETUP MENU

1 Player Menu English
2 Disc Menu English
3 Audio English
4 Subtitle Automatic
5 Parental Unlocked 
6 Audio Options
7 Display Options

 RETURN  ENTER

NOTE

- Depending on the disc, some Setup Menu selections may not work.

Setting Up the Language Features

If you set the player menu, disc menu, audio and subtitle language in advance, they will come up automatically every time you watch a movie.

Using the Player Menu Language

- 1 With the unit in Stop mode, press the SETUP button.
- 2 Use the UP/DOWN buttons to select the Player Menu.
- 3 Press the ENTER button.
- 4 Use the UP/DOWN buttons to select 'English'.
- 5 Press the ENTER button.
 - English is selected and the screen returns to SETUP MENU.
 - To make the SETUP MENU disappear, press the RETURN button.

e.g. Setting up in English.

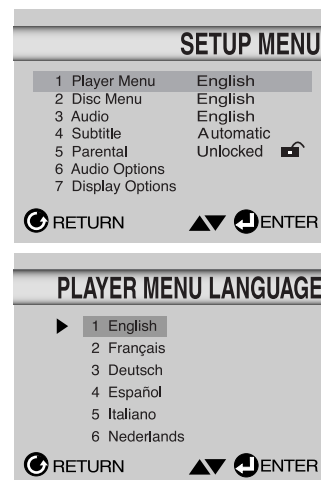

Using the Disc Menu Language

This function changes the text language only on the disc menu screens.

- 1 With the unit in Stop mode, press the SETUP button.
- 2 Use the UP/DOWN buttons to select Disc Menu.
- 3 Press the ENTER button.
- 4 Use the UP/DOWN buttons to select 'English'.
 - Select "Others" if the language you want is not listed.
- 5 Press the ENTER button.
 - English is selected and the screen returns to SETUP MENU.

e.g. Setting up in English.



Setting Up the Language Features

Using the Audio Language

- 1 With the unit in Stop mode, press the SETUP button.
- 2 Press the UP/DOWN buttons to move to Audio.
- 3 Press the ENTER button.
- 4 Press the UP/DOWN buttons to select 'English'.
 - Select "Original" if you want the default soundtrack language to be the original language the disc is recorded in.
 - Select "Others" if the language you want is not listed.
- 5 Press the ENTER button.
 - English is selected and the screen returns to SETUP MENU.



Using the Subtitle Language

- 1 With the unit in Stop mode, press the SETUP button.
- 2 Use the UP/DOWN buttons to select Subtitle.
- 3 Press the ENTER button.
- 4 Use the UP/DOWN buttons to select 'English'.
 - Select "Automatic" if you want the subtitle language to be the same as the language selected as the audio preference.
 - Select "Others" if the language you want is not listed. Some discs may not contain the language you select as your initial language; in that case the disc will use its original language setting.
- 5 Press the ENTER button.
 - English is selected and the screen returns to SETUP MENU.



NOTE

- If the selected language is not recorded on the disc, the original pre-recorded language is selected.
- How to make the SETUP MENU disappear or return to menu screen during set up; Press RETURN button.

CHANGING
SETUP MENU

Setting Up the Parental Control

The Parental Control function works in conjunction with DVDs that have been assigned a rating - which helps you control the types of DVDs that your family watches. There are up to 8 rating levels on a disc.

1 With the unit in Stop mode, press SETUP button. The Setup Menu screen appears.

2 Use UP/DOWN to select Parental. Press ENTER. The Parental Control screen appears.

3 Use LEFT/RIGHT to select Yes if you want to use a password. Press ENTER. The Enter Password screen appears.

4 Enter your password. The Re-enter Password screen appears to confirm the password. Enter your password again. The Parental Control screen appears.

5 About the Rating Level ;

The Rating Level will work only when Use Password is set to Yes. To unlock the player, use LEFT/RIGHT to select No. Use UP/DOWN to select Rating level. Press ENTER.

- Use UP/DOWN to select the level(e.g. Level 6) and press ENTER. Discs that contain Level 7 will now not play.

- To cancel the rating level, use LEFT/RIGHT to select No in Use Password.

6 About the Change Password ;

- Use UP/DOWN to select Change Password. The Change Password screen appears.

- Enter your new password. Re-enter the new password again.

NOTE

- How to make the SETUP MENU disappear or return to menu screen during set up; Press RETURN button.
- If you have forgotten your password, see Forget Password in the Troubleshooting Guide.

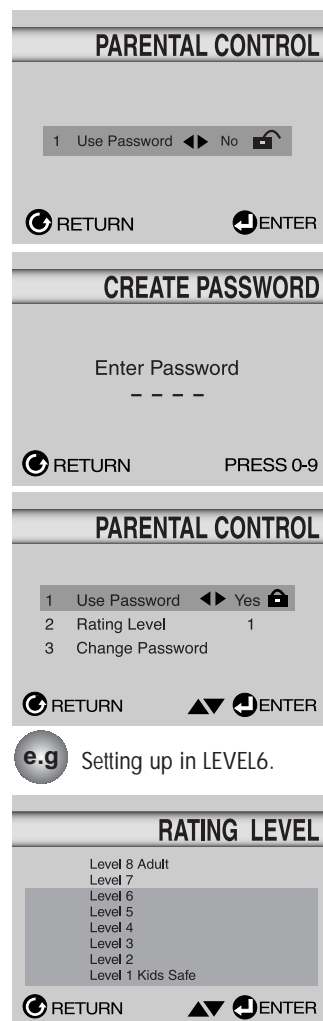

e.g. Setting up in LEVEL6.

Setting Up the Audio Options

1 With the unit in Stop mode, press the SETUP button.

2 Use the UP/DOWN buttons to select Audio Options. Then press the ENTER button.

3 Use the UP/DOWN buttons to select the desired item. Then press the LEFT/RIGHT buttons.

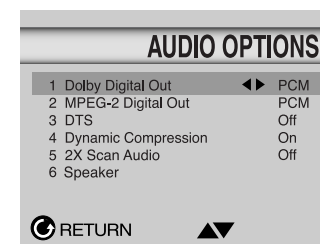

1 Dolby Digital Out

1. PCM :
Converts to PCM(2CH) audio.
Select PCM when using the Analog Audio Outputs.

2. Bitstream :
Converts to Dolby Digital Bitstream (5.1CH).
Select Bitstream when using the Digital Audio Output.

NOTE : Be sure to select the correct Digital Output or no audio will be heard.

3 DTS

1. Off : Doesn't output digital signal.
2. On : Outputs DTS Bitstream via digital output only.
Select DTS when connecting to a DTS Decoder.

5 2X Scan Audio

1. Off : Turns 2X audio off.
Though 2X Scan Audio is ON in the SETUP MENU, no sound will be heard on discs which are recorded with LPCM, DTS or MPEG-2 Audio.
2. On : Turns 2X audio on.

NOTE

- How to make the SETUP MENU disappear or return to menu screen during set up; Press RETURN button.
- Manufactured under license from Dolby Laboratories.
"Dolby" and the double-D symbol are trademarks of Dolby Laboratories.
- "DTS" and "DTS Digital Out" are trademarks of Digital Theater Systems, Inc.

2 MPEG-2 Digital Out

1. PCM :
Converts to PCM(2CH) audio.
Select PCM when using the Analog Audio Outputs.
2. Bitstream :
Converts to MPEG-2 Digital Bitstream (5.1CH or 7.1CH).
Select Bitstream when using the Digital Audio Output.

4 Dynamic Compression

1. On : To select dynamic compression.
2. Off : To select the standard range.

6 Speaker (DVD-S428K only)

Surround Sound Speaker Setup (DVD-S428K only)

- 1 Press the SETUP button in play or stop mode.
- 2 Press the UP/DOWN buttons to select Audio Options. Then press the ENTER button.
- 3 Use the UP/DOWN buttons to select Speaker SETUP. Then press the ENTER button.
- 4 Use the UP/DOWN or LEFT/RIGHT buttons to select the desired item. Then press the ENTER button.

Setting up SPEAKER MODE

- If you have connected the system to a speaker with low frequencies of 100Hz or below, select 'Found (Large illustration)'.
- If you have connected the system to a speaker without low frequencies of 100Hz or below, select 'Found (Small illustration)'. If you don't connect a subwoofer, always select 'Found (Large illustration)' for the Front Speakers(L/R).
- When you don't have a particular speaker connected, select 'Not found (No illustration visible)'.

Setting up DELAY TIME

- When 5.1CH Surround Sound is played, you can enjoy the best sound if the distance between you and each speaker is the same. You can set Delay Time in the Center/Surround Speaker to customize the sound to the acoustic of your room.

Setting CENTER SPEAKER

- If the distance of Dc is equal to or longer than the distance of Df in the left figure, set the mode as Oms. Otherwise, change the setting according to the table below.

$$(A) = Df - Dc$$

Distance of (A)(in)	Setting(ms)
0.00	0
0.34	1
0.68	2
1.02	3
1.36	4
1.70	5

Setting SURROUND SPEAKERS

- If the distance of Df is equal to the distance of Ds in the above, set the mode as Oms. Otherwise, change the setting according to the table on the right.

$$(B) = Df - Ds$$

Distance of (B)(in)	Setting(ms)
0.00	0
1.02	3
2.04	6
3.06	9
4.08	12
5.10	15

Setting up TEST

The test output signals come clockwise starting from the Front Speaker(L). Adjust Channel Balance to match to the volume of test signals memorized in the system.

FRONT(L) → CENTER → FRONT(R) → SUBWOOFER
SURROUND(R) → SURROUND(L)

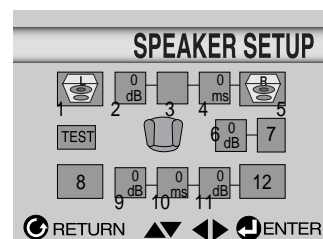

1. Speaker Mode(Front L)
2. Channel Balance(Center)OdB
3. Speaker Mode(Center)
4. Delay Time(Center)Oms
5. Speaker Mode(Front R)
6. Channel Balance(Subwoofer)OdB
7. Speaker Mode(Subwoofer)
8. Speaker Mode(Surround L)
9. Channel Balance(Surround L)OdB
10. Delay Time(Surround L/R)Oms
11. Channel Balance(Surround R)OdB
12. Speaker Mode(Surround R)

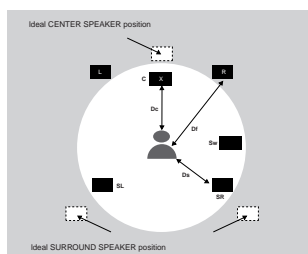

NOTE

- **How to make the SETUP MENU disappear or return to menu screen during set up.** Press RETURN button.
- The subwoofer test output signal is lower than the other speakers.
- The MPEG Multichannel logo is a trademark registered by PHILIPS Corporation.

Setting Up the Display Options

- 1 With the unit in Stop mode, press the SETUP button.
- 2 Use the UP/DOWN buttons to select Display Options. Then press the ENTER button.
- 3 Use the UP/DOWN buttons to select the desired item. Then press the LEFT/RIGHT buttons.

1 TV Aspect

Depending on the type of television you have, you may want to adjust the screen setting (aspect ratio).

1. 4:3 Letter Box :

Select when you want to see the total 16:9 ratio screen DVD supplies, even though you have a TV with a 4:3 ratio screen. Black bars will appear at the top and bottom of the screen.

2. 4:3 Pan-Scan :

Select this for conventional size TVs when you want to see the central portion of the 16:9 screen. (Extreme left and right side of movie picture will be cut off.)

3. 16:9 Wide :

You can view the full 16:9 picture on your widescreen TV.

2 Still Mode

These options will help prevent picture shake in still mode and display small text clearer.

1. Auto : When selecting Auto, Field/Frame mode will be automatically converted.
2. Field : Select this feature when the screen shakes in the Auto mode.
3. Frame : Select this feature when you want to see small letters more clearly in the Auto mode.

3 Screen Messages

Use to turn on-screen messages On or Off.

4 Front Display

Adjust the brightness of the unit's front panel display.

1. Auto Dim : Makes the Front Panel Display dim automatically when playing a DVD.
2. Bright : Makes the Front Panel Display bright.
3. Dim : Makes the Front Panel Display dim.

5 Black Level

Adjusts the brightness of the screen.(On/Off)

6 NTSC Disc Output

"NTSC" if the screen only has one NTSC-video entrance. If this is not the case, you can choose to leave "PAL 60Hz" as is.

DISPLAY OPTIONS

1 TV Aspect	4:3 L-Box
2 Still Mode	Auto
3 Screen Messages	On
4 Front Display	Auto Dim
5 Black Level	Off
6 NTSC Disc Output	PAL 60Hz



NOTE

- **How to make the SETUP MENU disappear or return to menu screen during set up;** Press the RETURN button.

Controlling a TV with the Remote (DVD-S328K/DVD-S428K only)

The remote can also be set up to control most TVs. To program the remote, use the code that corresponds to your brand.

TV Codes	
CODE	BRAND
01	SAMSUNG_4
02	SAMSUNG_6, LG, LOEWE, PHILIPS, FINLUX, YOKO, LOEWE OPTA, MITSUBISHI, PHONOLA, RADIOLA, SCHNEIDER
03	SAMSUNG_1
04	SAMSUNG_2
05	SAMSUNG_3
06	SAMSUNG_5
07	TOSHIBA
08	PANASONIC_4
09	GRUNDIG, BLAUPUNKT, SIEMENS
10	SHARP
11	HITACHI
12	SANYO, AKAI, FISHER
13	HITACHI, SABA, THOMSON, NORDMENDE
14	HITACHI, NORDMENDE, SABA, TELEFUNKEN, THOMSON, BRANDT, FERGLISON, PIONEER, TELEAVA
15	SONY
16	TOSHIBA, SANYO, SHARP, SONY, MITSUBISHI
17	TOSHIBA, GRUNDIG, FINLUX
18	TOSHIBA
19	TOSHIBA
20	PHILIPS, PHONOLA, RADIOLA
21	TOSHIBA, GRUNDIG, GGE, IMPERIAL, MIVAR
22	PHILIPS, SABA, BANG&OLUFSEN, BRIONVEGA, FINLUX, FORMENTI, LOEWE OPTA, METZ, WEGA, PHONOLA, RADIOMARELLI, SINGER, SINUDYNE
23	NOKIA, PANASONIC, SABA, PIONEER, REZ, SELECO, SALORA
24	HITACHI, NORDMENDE, PANASONIC, SABA, TELEFUNKEN, THOMSON, CONTINENTAL, EDISON
25	PANASONIC_2
26	PANASONIC_3
27	PANASONIC_6
28	TELEFUNKEN
29	MIVAL
30	LG_2
31	SHARP_2
32	JVC
33	THOMSON ASIA
34	THOMSON ASIA

- 1 Turn on the TV.
- 2 Point the DVD's remote at the TV.
- 3 While holding the TV POWER button down, enter the code for your brand.

e.g For SAMSUNG_4 TVs

While holding down the TV POWER button, enter 0 and then 1.

- 4 If the TV turns off, setup is complete. Enter other codes of the same brand if the first code does not work.
- 5 To operate the TV, use the "TV Function Buttons" described on page 17,19.

NOTE

- The remote may not be able to control every model TV of the brands listed.

Troubleshooting

Before requesting service (troubleshooting), please check the following.

Problem	Action	Page
No operations can be performed with remote.	<ul style="list-style-type: none"> Check the batteries in the remote. May need replacing. Operate the remote control at a distance of no more than 20 feet. Remove batteries and hold down one or more buttons for several minutes to drain the microprocessor inside the remote to reset it. Reinstall batteries and try remote again. 	P4
Disc does not play.	<ul style="list-style-type: none"> Ensure that the disc is installed with the label side facing up. Check the region number of the DVD. 	P 7
5.1 channel sound is not being reproduced.	<ul style="list-style-type: none"> 5.1 channel sound is reproduced only when the following conditions are met. : <ol style="list-style-type: none"> 1) The DVD player is connected with the proper amplifier 2) The disc is recorded with 5.1 channel sound. Check whether the disc being played has the "Dolby 5.1 ch" mark on the outside. Check if your audio system is connected and working properly. In a SETUP Menu, is the Audio Output set to Bitstream? 	P 20, 47-48
The  icon appears on screen.	<ul style="list-style-type: none"> The features or action cannot be completed at this time because: <ol style="list-style-type: none"> 1. The DVD's software restricts it. 2. The DVD's software doesn't support the feature (e.g., angles). 3. The feature is not available at the moment. 4. You've requested a title or chapter number or search time that is out of range. 	P 23
Disc Menu doesn't appear.	<ul style="list-style-type: none"> Check if the disc has a Menu. 	P 43-44
Play mode differs from the Setup Menu selection.	<ul style="list-style-type: none"> Some of the functions selected in the Setup Menu may not work properly if the disc is not encoded with the corresponding function. 	P 43-49
The screen ratio cannot be changed.	<ul style="list-style-type: none"> The Screen Ratio is fixed on your DVDs. 	P 49
No audio.	<ul style="list-style-type: none"> Make sure you have selected the correct Digital Output in the Audio Options Menu. 	P 47-48
Forgot password	<ul style="list-style-type: none"> Press power on from a cold start with no disc in the unit. Press the STOP and PLAY buttons simultaneously on the front panel for three seconds. The Select Menu Language display will appear. Select the desired language button. Press the SETUP button on the remote control to select the Parental Mode. The Parental Mode is now unlocked as indicated on the display. Press the DOWN button to select Parental. Press ENTER and the Create Password display will appear. You can now set your rating level and change your password to a new number. 	P 46
If you experience other problems.	<ul style="list-style-type: none"> Go to the contents and find the section of the instruction book that contains the explanations regarding the current problem, and follow the procedure once again. If the problem still cannot be solved, please contact your nearest authorized service center. 	

Specifications

Memo

General	Power Requirements	AC 110~240V, 50/60 Hz
	Power Consumption	13 W
	Weight	2.8 Kg
	Dimensions	430mm X 240mm X 79mm
	Operating Temperature Range	+5°C to +35°C
	Operating Humidity Range	10 % to 75 %
Disc	DVD (DIGITAL VERSATILE DISC)	Reading Speed : 3.49 m/sec. Approx. Play Time (Single Sided, Single Layer Disc) : 135 min.
	CD : 12Cm (COMPACT DISC)	Reading Speed : 1.2 to 1.4 m/sec. Maximum Play Time : 74 min.
	CD : 8Cm (COMPACT DISC)	Reading Speed : 1.2 to 1.4 m/sec. Maximum Play Time : 20 min.
	VCD : 12Cm	Reading Speed : 1.2 to 1.4 m/sec. Maximum Play Time : 74 min. (Video + Audio)
Video Output	Composite Video	1 channel : 1.0 Vp-p (75 Ω load)
	Component Video	Y : 1.0 Vp-p (75 Ω load) Pr : 0.70 Vp-p (75 Ω load) Pb : 0.70 Vp-p (75 Ω load)
	S-VIDEO	Luminance Signal : 1.0 Vp-p (75 Ω load) Chrominance Signal : 0.286 Vp-p (75 Ω load)
Audio Output	2 channel	L(1/L), R(2/R)
	*Frequency Response	48 kHz Sampling : 4 Hz to 22 kHz 96 kHz Sampling : 4 Hz to 44 kHz
	*S/N Ratio	110 dB (DVD-S128/DVD-S228) 105 dB (Karaoke off Mode DVD-S328K/DVD-S428K)
	*Dynamic Range	100 dB (DVD-S128/DVD-S228) 96 dB (Karaoke off Mode DVD-S328K/DVD-S428K)
	*Total Harmonic Distortion	0.004 % (DVD-S128/DVD-S228) 0.004 % (Karaoke off Mode DVD-S328K/DVD-S428K)

*: Nominal specification

- Samsung Electronics Co., Ltd reserves the right to change the specifications without notice.
- Weight and dimensions are approximate.

Free Manuals Download Website

<http://myh66.com>

<http://usermanuals.us>

<http://www.somanuals.com>

<http://www.4manuals.cc>

<http://www.manual-lib.com>

<http://www.404manual.com>

<http://www.luxmanual.com>

<http://aubethermostatmanual.com>

Golf course search by state

<http://golfingnear.com>

Email search by domain

<http://emailbydomain.com>

Auto manuals search

<http://auto.somanuals.com>

TV manuals search

<http://tv.somanuals.com>