

SAMSUNG

User's Manual

DVD-V5450

DVD-V5500

DVD-V6400

DVD-V6500

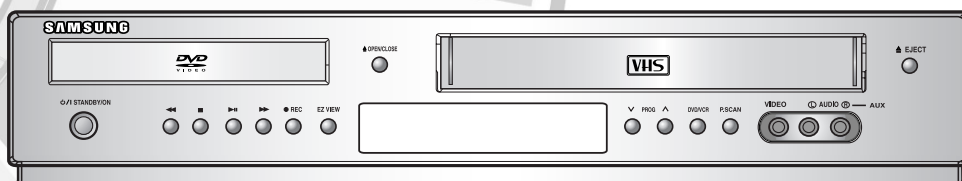

VHS

PAL

www.samsung.com

Safety Instructions



The following illustrations represent precautions.



The lightning bolt is a warning sign alerting you to dangerous voltage inside the product.

DO NOT OPEN THE DVD-VCR. Refer to service personnel.

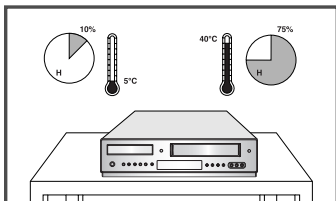

DO NOT expose the DVD-VCR to extreme temperature conditions (below 5°C and above 40°C) or to extreme humidity conditions (less than 10% and more than 75%).

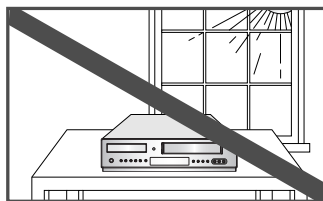

DO NOT expose the DVD-VCR to direct sunlight.

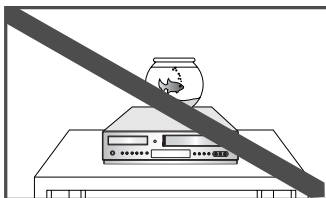

DO NOT expose the DVD-VCR to any liquids.

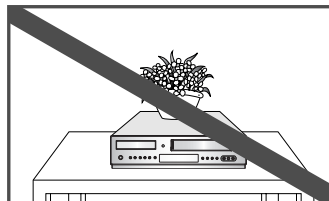

DO NOT place any objects on the DVD-VCR or remote control.

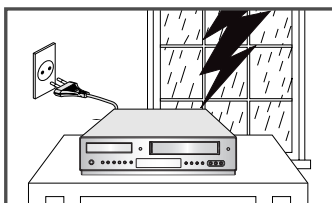

During a storm and/or lightning, unplug the DVD-VCR from the mains jack and aerial.

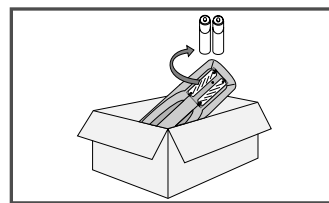

If the remote control is not used for a long period of time, remove the batteries and store it in a cool, dry place.



THIS DEVICE IS NOT FOR USE IN INDUSTRIAL ENVIRONMENTS

This product incorporates copyright protection technology that is protected by method claims of certain U.S. patents and other intellectual property rights owned by Macrovision Corporation and other rights owners. Use of this copyright protection technology must be authorized by Macrovision Corporation, and is intended for home and other limited viewing uses only unless otherwise authorized by Macrovision Corporation. Reverse engineering or disassembling is prohibited.

Disc Type and Characteristics









This DVD-VCR is capable of playing the following types of discs with the corresponding logos:

Disc Types (Logos)	Recording Types	Disc Size	Max. Playing Time	Characteristics
DVD 	Audio + Video	12 Cm	Single-sided 240 min. Double-sided 480 min.	- DVD contains excellent sound and video due to Dolby Digital, DTS and MPEG-2 system. - Various screen and audio functions can be easily selected through the on-screen menu.
		8 Cm	Single-sided 80 min. Double-sided 160 min.	
AUDIO-CD 	Audio	12 Cm	74 min.	- CD is recorded as a Digital Signal with better audio quality, less distortion and less deterioration of audio quality over time.
		8 Cm	20 min.	
VIDEO-CD 	Audio + Video	12Cm	74 min.	- Video with CD sound, VHS quality & MPEG-1 compression technology.
		8 Cm	20 min.	

- DO NOT play CD-ROM, CD-I and DVD-ROM in this player! (CDGs play audio only, not graphics.)
- It may not play CD-R, CD-RW and DVD-R, -RW, DVD+R, +RW in all cases due to the type of disc or condition of the recording.
- The recorded disc may not run as playback depends on the recording speed.
- Do not run the player with two discs loaded at the same time.

Disc Markings

	Play Region Number
	PAL colour system in Europe, Australia, New Zealand, etc.
	NTSC broadcast system in U.S.A, Canada, Korea, Japan, etc.
	Dolby Digital disc
	Stereo disc
	Digital Audio disc
	DTS disc
	Disc contains a Divx software product

Play Region Number

Both the DVD-VCR and the discs are coded by region. These regional codes must match in order for the disc to play. If the codes do not match, the disc will not be played.

The Region Number for this player is described on the rear panel of the player.

Contents



◆ Getting Started

Safety Instructions	2
Disc Type and Characteristics	3
Overviews	6
Front View of the DVD-VCR	6
Rear View of the DVD-VCR	7
Display Indicators	7
Accessories	8
Inserting Batteries in the Remote Control	8
Tour of the Remote Control	9

◆ Connections

Quick Overview	10
Connecting DVD-VCR to the TV using the RF Cable	11
Connecting DVD-VCR to the TV using the SCART Cable	11
Connecting DVD-VCR to a Satellite Receiver or Other Equipment	12
Connecting DVD-VCR to the TV using the Audio/Video Cable	12
Connecting DVD-VCR to the TV using the S-Video Cable (DVD Only)	13
Connecting DVD-VCR to the TV using the Component Video Cable (DVD Only)	13
AV Receiver Connections	14
Connecting an Audio/Video Input Cable (DVD-V5500/DVD-V6500)	15
Plug & Auto Setup	15

◆ Settings

Tuning Your Television for the DVD-VCR	17
Setting the Date and Time	18
Setting the Menu Language	19
Presetting the Stations Automatically	19
Presetting the Stations Manually	21
Clearing a Preset Station	22
Changing the Preset Station Table	23
Selecting the RF OUT Sound Mode (B/G-D/K) ..	24
Setting the VCR Output Channel	24

◆ VCR Functions

Selecting the Colour Mode	25
NICAM	26
Intelligent Picture Control	26
ShowView Extend (DVD-V6400/DVD-V6500) ..	27
Auto Power off	27
Screen Messages	28
Selecting the Cassette Type	28
Repeat Play	29
Selecting the Recording Speed	29
Protecting a Recorded Cassette	29
Recording a Programme Immediately	30
Recording a Programme with Automatic Stop	30
Recording from Another VCR or Camcorder	31
Using the Assemble Edit Function	31
Using the ShowView Feature (DVD-V6400/DVD-V6500)	32
Modifying ShowView Programming (DVD-V6400/DVD-V6500)	33
Using the Timer Programming Feature	34
Checking a Preset Recording	36
Cancelling a Preset Recording	37

◆ Playing Back

Playing a Cassette	38
Adjusting Picture Alignment Manually	38
Selecting the Audio Output Mode	39
Playing a Cassette in Slow Motion	39
Playing a Sequence Frame by Frame	39
Playing a Sequence at Variable Speeds	39
Searching for a Specific Sequence	40
Using the Tape Counter	42

◆ DVD Functions

Setting Up the Language Features	43
Setting Up the Audio Options	45
Setting Up the Display Options	46
Setting Up the Parental Control	47
DivX(R) Registration (DVD-V6400/DVD-V6500)	49
Firmware Upgrade (DVD-V6400/DVD-V6500)	49
Special Playback Features	51
Using the Display Function	52
Adjusting the Aspect Ratio (EZ View)	53
Selecting the Subtitle Language	54
Selecting the Audio Language	54
Changing the Camera Angle	55
Zoom	55
Marks	56
Repeat Chapter/Title	56
A to B Repeat	57
MP3/WMA Play	58
Program & Random Play (CD/MP3/WMA)	59
Picture CD Playback	60
DivX/MPEG4 Playback (DVD-V6400/DVD-V6500)	62
DivX/MPEG4 Special Playback Features (DVD-V6400/DVD-V6500)	62

◆ Reference

Technical Specifications	65
Troubleshooting Guide (VCR)	66
Troubleshooting Guide (DVD)	67

Overviews



Front View of the DVD-VCR (DVD-V5450/DVD-V6400)

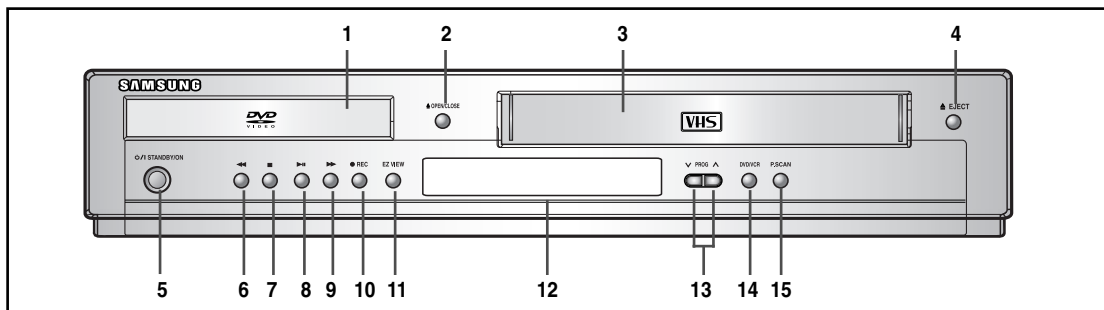

Front View of the DVD-VCR (DVD-V5500)

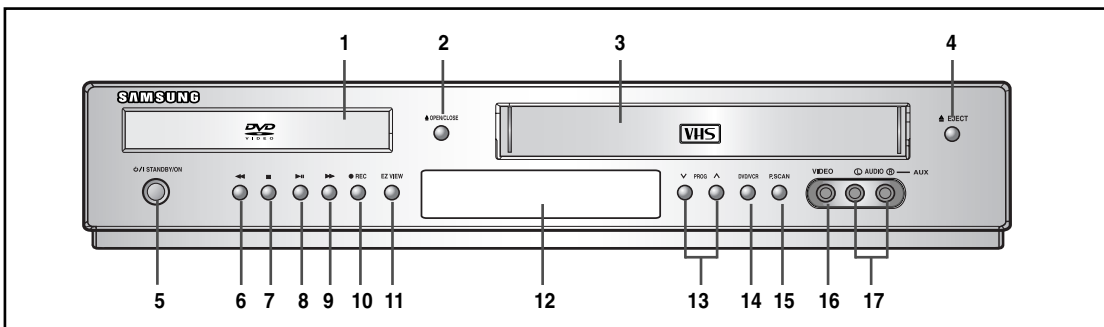

Front View of the DVD-VCR (DVD-V6500)

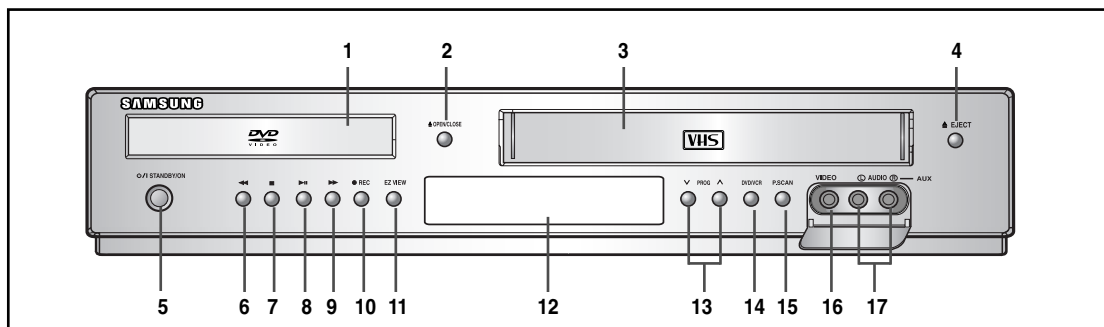

- | | |
|-------------------------------|------------------------------------|
| 1. DVD DECK | 9. FAST FORWARD / SKIP NEXT BUTTON |
| 2. OPEN/CLOSE BUTTON | 10. RECORD BUTTON |
| 3. VIDEO CASSETTE COMPARTMENT | 11. EZ VIEW BUTTON |
| 4. EJECT BUTTON | 12. FRONT PANEL DISPLAY |
| 5. STANDBY/ON BUTTON | 13. PROGRAMME SELECTION BUTTON |
| 6. REWIND/SKIP BACK BUTTON | 14. DVD/VCR SELECTION BUTTON |
| 7. STOP BUTTON | 15. PROGRESSIVE SCAN MODE BUTTON |
| 8. PLAY/STILL BUTTON | 16. AUX VIDEO INPUT JACK |
| | 17. AUX AUDIO L/R INPUT JACK |

Rear View of the DVD-VCR

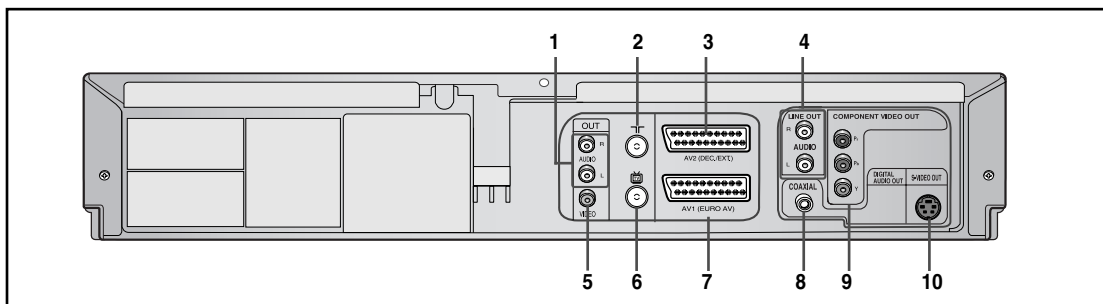

- | | |
|---|--|
| 1. AUDIO L, R OUT JACKS | 7. AV1 (EURO AV) IN/OUT SCART (EURO-21) JACK |
| 2. AERIAL IN CONNECTOR | 8. DIGITAL AUDIO OUT JACKS (COAXIAL) |
| 3. AV2 (DEC./EXT.) SCART (EURO-21) JACK | 9. COMPONENT VIDEO OUT JACKS |
| 4. AUDIO L, R OUT JACKS (DVD ONLY) | 10. S-VIDEO OUT JACK |
| 5. VIDEO OUT JACK | |
| 6. OUT TO TV CONNECTOR | |

Display Indicators

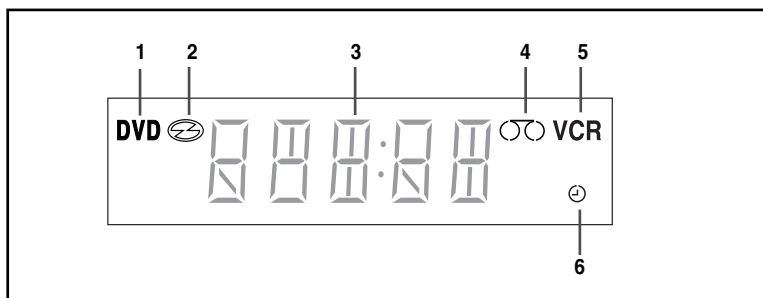

1. The DVD Deck is active.
2. Disc is loaded.
3. The time, counter position, current deck status is displayed.
4. VHS tape is inserted.
5. The VCR Deck is active.
6. A Timer Recording is programmed or in progress.

Accessories

You have just purchased a SAMSUNG DVD-VCR. Together with your DVD-VCR, you will find the following accessories in the box.

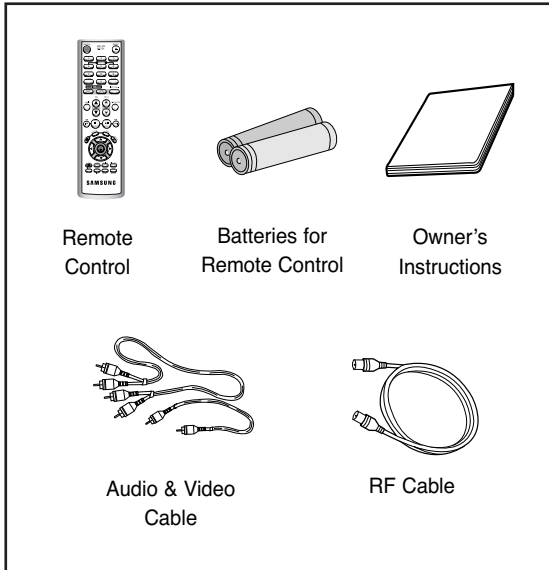

Inserting Batteries in the Remote Control

You must insert or replace the batteries in the remote control when you:

- Purchase the DVD-VCR
- Find that the remote control is no longer working correctly

- 1** Push the tab in the direction of the arrow to release the battery compartment cover on the rear of the remote control.

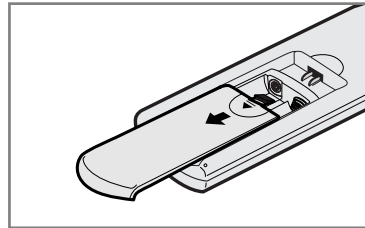

- 2** Insert two AAA, RO3 or equivalent batteries, taking care to respect the polarities:
 - + on the battery with + on the remote control
 - - on the battery with - on the remote control

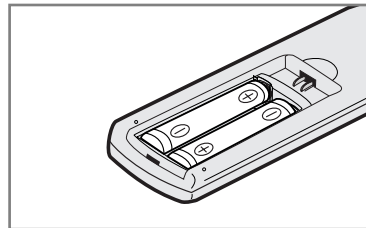

- Do not mix different battery types (manganese and alkaline for example).

- 3** Replace the cover by aligning it with the base of the remote control and pushing it back into place.

Tour of the Remote Control

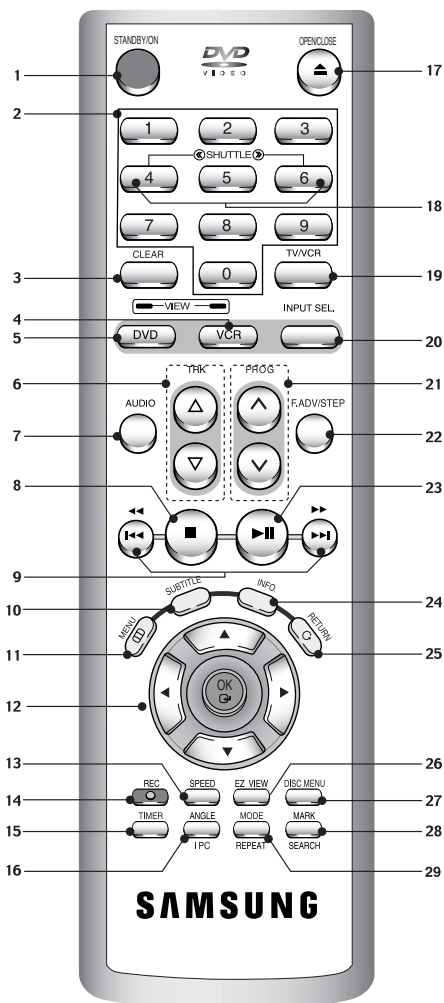

1. **STANDBY/ON**
Used to turn the power on or off.
2. **Number Buttons**
3. **CLEAR**
Used to clear a preset TV station.
Used to cancel a preset recording.
Used to cancel a preset mark.
Used to set the tape counter to zero.
Used to resume normal play during repeat play.
4. **VCR**
Used to operate VCR.
5. **DVD**
Used to operate DVD.
6. **TRK (▲ / ▼)**
Used to adjust picture alignment manually to obtain the best possible picture during playback.
7. **AUDIO**
Used to access various audio functions.
8. **STOP (■)**
Used to stop during playback.
9. **SEARCH/SKIP (◀◀ / ▶▶, ◀◀◀ / ▶▶▶)**
Used to search forward or backward through a disc.
Used to skip the title, chapter, or track.
10. **SUBTITLE**
Used to change the DVD's subtitle language.
11. **MENU**
Used to display the on-screen menu.
12. **OK ▲ / ▼, ◀ / ▶**
Used to control the cursor in the on-screen menu and confirm your choice.
13. **SPEED**
Used to select the recording speed.
14. **REC (●)**
Used to make a recording on cassette.
15. **TIMER**
Used to activate the timer recording of a programme.
16. **ANGLE**
Used to access various camera angles on a DVD.
IPC (Intelligent Picture Control)
Used to adjust the sharpness of the picture.
17. **OPEN/CLOSE**
Used to open and close the disc and video cassette tray.
18. **SHUTTLE**
Used to play a sequence at variable speeds.
19. **TV/VCR**
Used to select TV or VCR.
20. **INPUT SEL.**
Used to select a external input signal.
21. **PROG (▲ / ▼)**
Used to select a TV programme.
22. **F.ADV/STEP**
Used to advance a sequence frame by frame.
23. **PLAY/STILL (▶ / ||)**
Used to play or pause during playback.
24. **INFO.**
Used to display the current setting or disc status.
25. **RETURN**
Used to return to a previous menu.
26. **EZ VIEW**
Used to adjust the aspect ratio on a disc.
27. **DISC MENU**
Used to display a disc menu.
28. **MARK**
Used to mark a position during playback a disc.
SEARCH
Used to search for a specific sequence.
29. **MODE**
Used to select the programme or random play.
REPEAT
Used to allow the repeat play a title, chapter, track, disc or A-B.



Connections

- *Quick Overview* 10
- *Connecting DVD-VCR to the TV using the RF Cable* 11
- *Connecting DVD-VCR to the TV using the SCART Cable* 11
- *Connecting DVD-VCR to a Satellite Receiver or Other Equipment* 12
- *Connecting DVD-VCR to the TV using the Audio/Video Cable* 12
- *Connecting DVD-VCR to the TV using the S-Video Cable (DVD Only)* 13
- *Connecting DVD-VCR to the TV using the Component Video Cable (DVD Only)* 13
- *AV Receiver Connections* 14
- *Connecting an Audio/Video Input Cable (DVD-V5500/DVD-V6500)* 15
- *Plug & Auto Setup* 15



Quick Overview

A Quick overview presented in this guide will give you enough information to start using the DVD-VCR.

Connecting DVD-VCR to the TV using the RF Cable

Connecting DVD-VCR to the TV using the SCART Cable

Connecting DVD-VCR to a Satellite Receiver or Other Equipment

Connecting DVD-VCR to the TV using the Audio/Video Cable

Connecting DVD-VCR to the TV using the S-Video Cable (DVD Only)

Connecting DVD-VCR to the TV using the Component Video Cable (DVD Only)

AV Receiver Connections

Connecting an Audio/Video Input Cable (DVD-V5500/DVD-V6500)

Plug & Auto Setup

Connecting DVD-VCR to the TV using the RF Cable



To receive television programmes, a signal must be received from one of the following sources:

- An outdoor aerial
- An indoor aerial
- A cable television network
- A satellite receiver



Note

- Make sure that both the television and the DVD-VCR are switched off before connecting the cables.

- 1 Remove the aerial or network input cable from the television.
- 2 Connect this cable to the 75Ω coaxial jack marked  on the rear of your DVD-VCR.
- 3 Plug the RF Cable supplied into , the jack on your DVD-VCR.
- 4 Plug the other end of the RF Cable into the connector previously used for the aerial on the television.

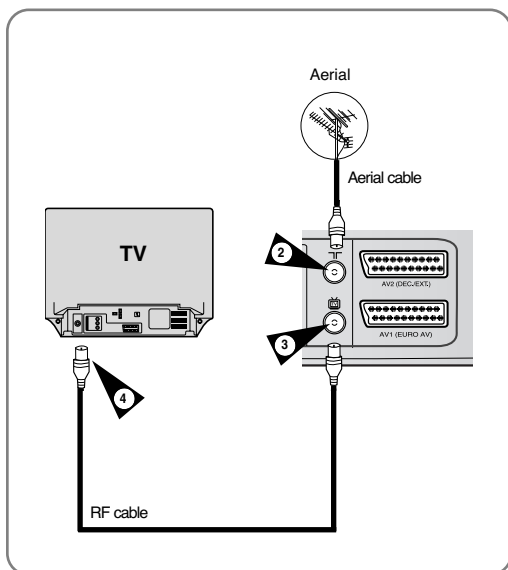

Connecting DVD-VCR to the TV using the SCART Cable

You can connect your DVD-VCR to the television using the SCART cable if the appropriate input is available on the television. You thus:

- Obtain better quality sound and pictures
- Simplify the setting up procedure of your DVD-VCR



Note

- Regardless of the type of connection chosen, you must always connect the RF Cable supplied. Otherwise, no picture will be visible on the screen when the DVD-VCR is switched off.
- Make sure that both the television and the DVD-VCR are switched off before connecting the cables.

- 1 Connect the Aerial Cable.
- 2 Connect one end of the SCART cable to the AV1 (EURO AV) jack on the rear of the DVD-VCR.
- 3 Plug the other end into the appropriate connector on the television.

Connecting the Audio Output Cable

You can connect your DVD-VCR to a Hi-Fi system.

Example: You wish to take advantage of the quality of your Hi-Fi stereo system when watching a disc play.

- 4 Plug the audio output cable into the audio connectors on the rear of your DVD-VCR.
- 5 Plug the other end of the audio cable into the appropriate input connectors on your Hi-Fi stereo system.

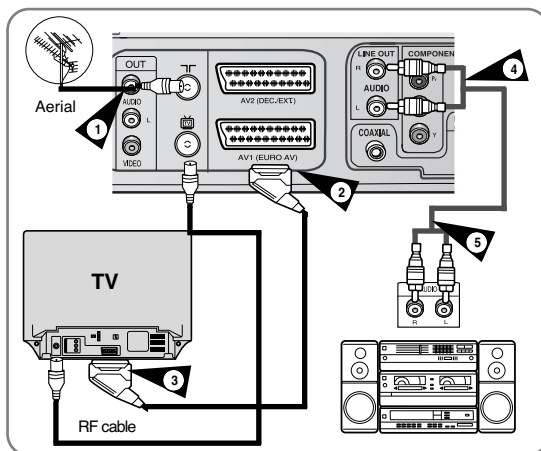

Connecting DVD-VCR to a Satellite Receiver or Other Equipment

You can connect your DVD-VCR to a Satellite receiver or other DVD-VCR using the SCART cable if the appropriate outputs are available on the equipment chosen. The following illustrations give a few examples of the connection possibilities.

1 AV2 IN: By means of 21-pin Scart Cable
Plug the SCART Cable with satellite receiver or other equipment into the AV2 (DEC./EXT.) jack on the rear of the DVD-VCR. After making this connection, select the source by pressing the **INPUT SEL.** button for the **AV2** input sources.

2 By means of RF Cable
After making this connection, you must preset the station received through the satellite tuner. RF output channel of the satellite receiver should be adjusted away from channel 36, which is used by the DVD-VCR, e.g. re-adjust to channel 33.

3 AV(EURO AV) : By means of 21-pin Scart Cable
Connect the end of the SCART cable to the AV1(EURO AV) jack on the rear of the DVD-VCR. Plug the other end into the appropriate connector on the television.

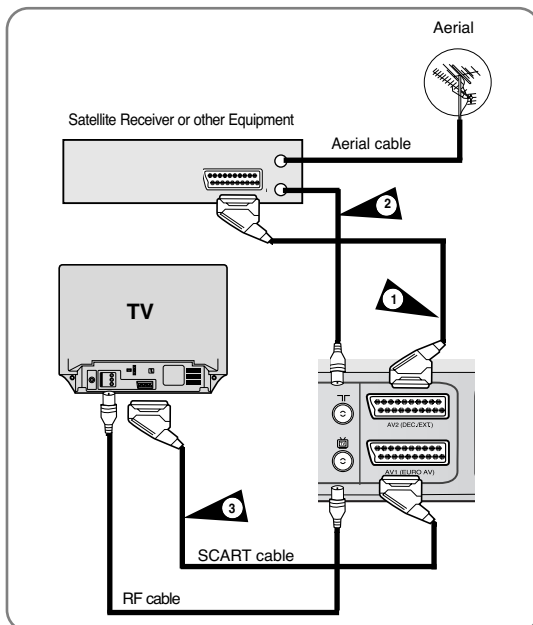

Connecting DVD-VCR to the TV using the Audio/Video Cable

You can connect your DVD-VCR to the television using the audio/video cable if the appropriate input is available on the television.

1 Connect one end of the video cable into the **VIDEO** output jack on the rear of the DVD-VCR.

2 Plug the other end of the video cable into the appropriate input connector on the television.

3 Connect one end of the audio cables supplied into the **AUDIO** output jacks on the rear of the DVD-VCR.
• Take care to respect the colour coding of the left and right channels.

4 Plug the other end of the audio cables into the appropriate input connectors on the television.

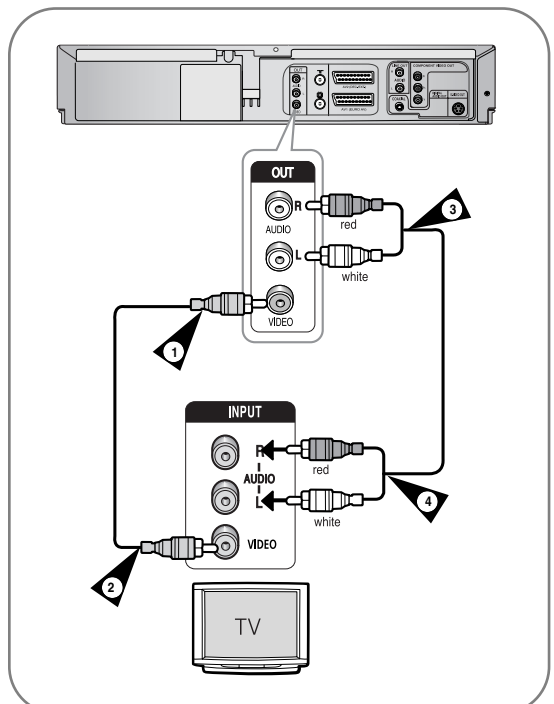

Connecting DVD-VCR to the TV using the S-Video Cable (DVD Only)

You will enjoy high quality images. S-Video separates the picture element into black and white(Y) and colour(C) signals to present clearer images than regular video input mode.

- 1** Connect one end of the S-Video cable into the **S-VIDEO** output jack on the rear of the DVD-VCR.
- 2** Plug the other end of the S-Video cable into the appropriate input connector on the television.
- 3** Connect one end of the audio cables supplied into the **AUDIO LINE** output jacks on the rear of the DVD-VCR.
 - Take care to respect the colour coding of the left and right channels.
- 4** Plug the other end of the audio cables into the appropriate input connectors on the television.

 **Note** ■ Use the S-Video connection method only for the DVD.

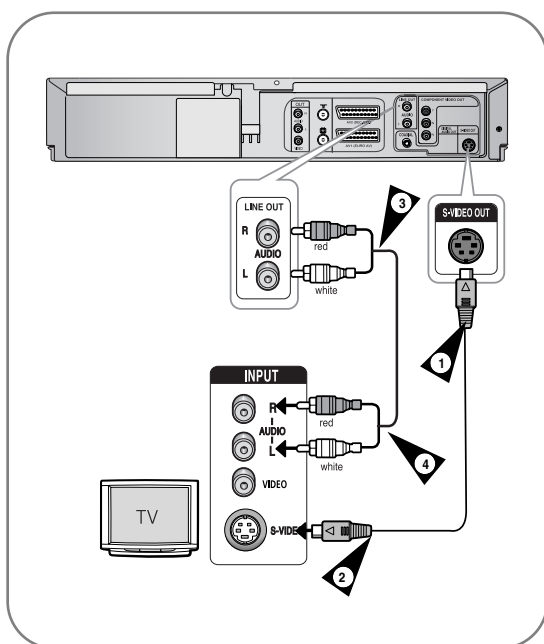

Connecting DVD-VCR to the TV using the Component Video Cable (DVD Only)

Your TV must support progressive scan input to allow you to watch component video output.

You will enjoy high quality accurate colour reproduction images. Component video separates the picture element into black and white(Y), blue(Pb), red(Pr) signals to present most clear and clean images.

- 1** Connect Component video cables between the **COMPONENT VIDEO OUT** jacks on the rear of the DVD-VCR and **COMPONENT VIDEO IN** jacks on the rear of the TV.
- 2** Connect audio cables between the **AUDIO LINE OUT** jacks on the rear of the DVD-VCR and **AUDIO IN** jacks on the rear of the TV.
 - Take care to respect the colour coding of the left and right channels.

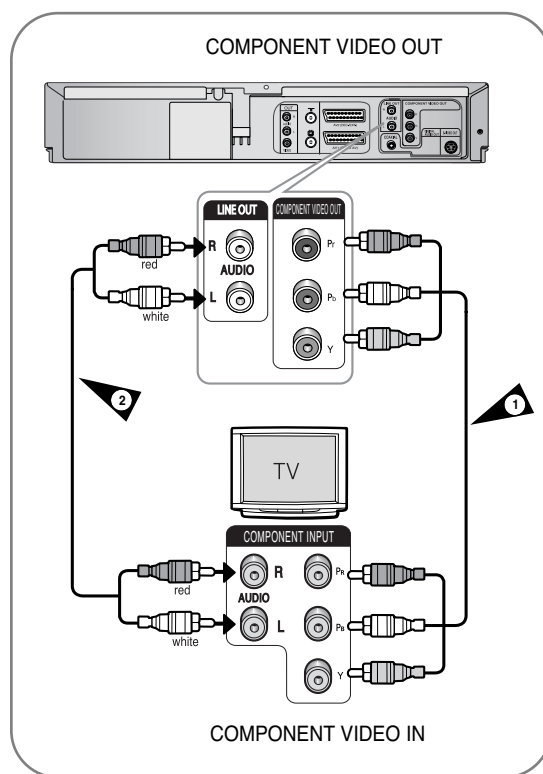

Progressive Scan

If the TV connected supports Progressive Scan, press the P.SCAN button on the front panel in stop mode.

- The Progressive Scan feature is only available for DVD. Activate it in DVD Stop mode.
- The message "Press OK to confirm Progressive scan mode. Otherwise press RETURN." will be displayed. If you want Progressive scan mode, select OK. Make sure that the disc has stopped completely before changing the mode.

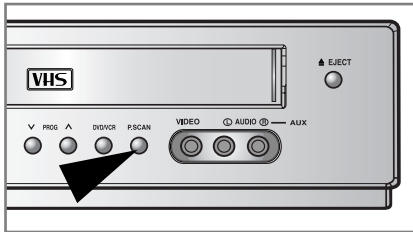

- To cancel the progressive scan mode, press the **P.SCAN** button in stop mode.
- Make sure that the colour coded connections match. That is, the Y, Pb and Pr component output jacks of your DVD -VCR should be connected to the exact corresponding component input jacks on your TV. Otherwise, red or blue images will be displayed on the TV screen.



Note

- If your TV does not have Progressive scan mode, there will be no signal on the screen. If you press the **P.SCAN** button, it will be changed to Interlace scan mode.
- See your TV User's Manual to find out if your TV supports Progressive Scan. If Progressive Scan is supported, follow the TV User's instructions regarding Progressive Scan settings in the TV's menu system.
- Depending on your TV, the method of connection may differ from the illustration above.
- What is "Progressive Scan"? Progressive scan has twice as many scanning lines as the interlace output method has. Progressive scanning method can provide better and clearer picture quality.
- You must connect the player to the component(s) before using the Progressive Scan feature.
- Use the Component Video connection method only for the DVD.
- NTSC DVD disk is not supported.

AV Receiver Connections

To take full advantage of the movie theater experience that DVD offers, you may want to connect your DVD-VCR to a complete Surround Sound system, including an A/V Receiver and six Surround Sound speakers. If your A/V receiver is equipped with a Dolby Digital Decoder, you have the option to bypass the DVD-VCR's built-in Dolby Digital Decoder. Use the Digital Audio Out connection below.

- 1 Connect a Digital Audio coaxial cable from the Digital Audio Out jacks on the panel of the DVD-VCR to their corresponding Digital Audio Input jacks on your A/V Receiver:

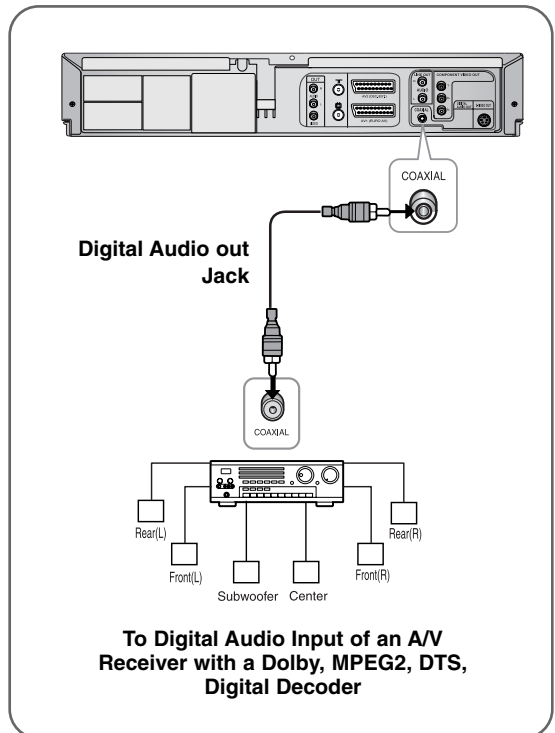

Connecting an Audio/Video Input Cable (DVD-V5500/DVD-V6500)

You can connect other audio/video equipment to your DVD-VCR using audio/video cables if the appropriate outputs are available on the equipment chosen.

- Examples :**
- You wish to copy a video cassette with the help of a second VCR.
 - You wish to play back and/or copy pictures taken with a camcorder
 - Make sure that both the external devices and the DVD-VCR are switched off before connecting the cables.

- 1 Connect one end of the video cable into the **VIDEO** input jack on the front of the DVD-VCR.
- 2 Plug the other end of the video cable into the appropriate output connector on the other system (VCR or Camcorder etc).
- 3 Connect one end of the audio cable supplied into the **AUDIO** input jacks on the front of the DVD-VCR.
 - Take care to respect the colour coding of the left and right channels.
- 4 Plug the other end of the audio cable into the appropriate output connectors on the other system (VCR, camcorder etc).

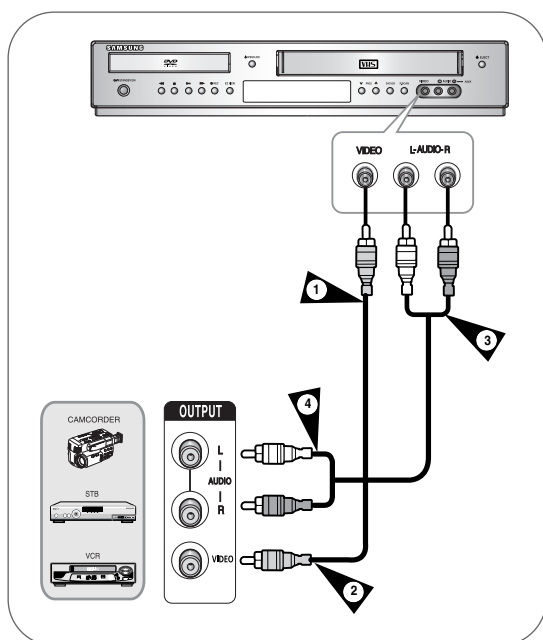

Plug & Auto Setup

Your DVD-VCR will automatically set itself up when it is plugged into the mains for the first time. TV stations will be stored in memory. The process takes a few minutes. Your DVD-VCR will then be ready for use.

- 1 Connect the RF Cable as indicated on page 11. (Connecting Your DVD-VCR to the TV using the RF Cable)

- 2 Plug the DVD-VCR into the mains.
 - "AUTO" in the front panel display flickers.



- 3 The Language Set menu is displayed. Press the **▲** or **▼** button, move the selection bar to select the desired language then press **OK** button.

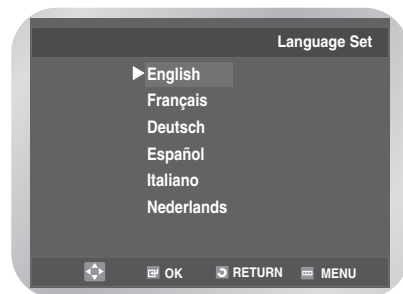

- 4 Start the auto setup.

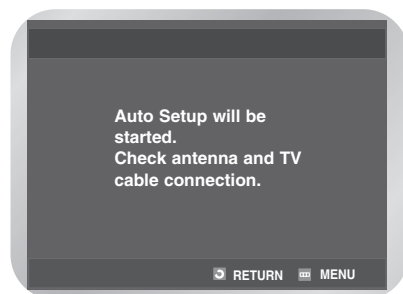

- 5** Start the auto scanning.
The number of stations automatically stored by the DVD-VCR depends on the number of stations that it has found.

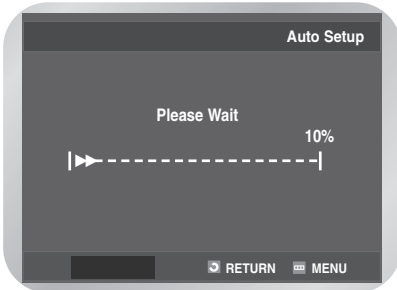

- 6** Check the date and time.

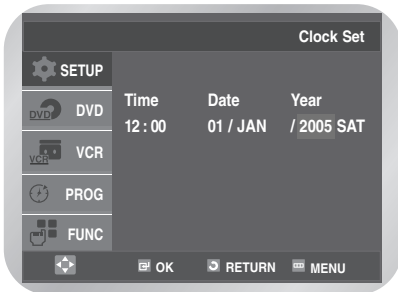

Refer to “Setting the Date and Time” to change the date and time. (See page 18).



Note

- Now, you only have to switch the DVD-VCR on and it is ready for use.
- Function for “Plug & Auto Set Up” is fixed already. So if you want to change this fixed one, you can change. (refer to “Presetting the Stations manually” page 21)

Settings

Tuning Your Television for the DVD-VCR

You must tune your television for the DVD-VCR only if you are using the RF cable. To view pictures from your DVD-VCR when a audio/video cable is used, the television must be set to the audio/video mode (AV).

- 1 Switch on the television.
- 2 Switch on the DVD-VCR by pressing the  **STANDBY/ON** on the front of the DVD-VCR or **STANDBY/ON** on the remote control.
- 3 Select a programme position on the television to be reserved for use with your DVD-VCR.
- 4 Insert the video cassette in the DVD-VCR. Check that the DVD-VCR starts reading the cassette; if not, press the **▶II** button.
- 5 Start a scan on your television or set the television to UHF channel 36.
- 6 Fine tune the television until the pictures and sound are obtained clearly.
- 7 When the picture and sound are perfectly clear, store this channel at the desired programme position on the television. That programme is now reserved for use with your DVD-VCR.

- *Tuning Your Television for the DVD-VCR* . . . 17
- *Setting the Date and Time* 18
- *Setting the Menu Language* 19
- *Presetting the Stations Automatically* 19
- *Presetting the Stations Manually* 21
- *Clearing a Preset Station* 22
- *Changing the Preset Station Table* 23
- *Selecting the RF OUT Sound Mode (B/G-D/K)* . 24
- *Setting the VCR Output Channel* 24

Setting the Date and Time

Your DVD-VCR contains a 24-hour clock and calendar used to:

- Automatically stop programme recording
- Preset your DVD-VCR to record a programme automatically

You must set the date and time when:

- You purchase the DVD-VCR.
- Do not forget to reset the time when you change clocks from winter to summer time and vice versa.

- 1 Press the **MENU** button, then press the **OK** or **▶** button.

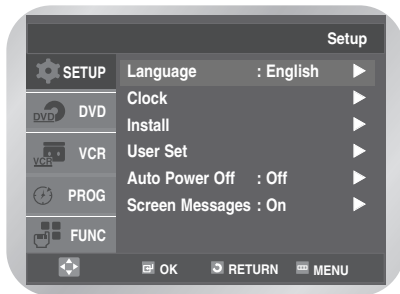

- 2 Press the **▲** or **▼** button to select **Clock**, then press the **OK** or **▶** button. The **Clock Set** menu is displayed.

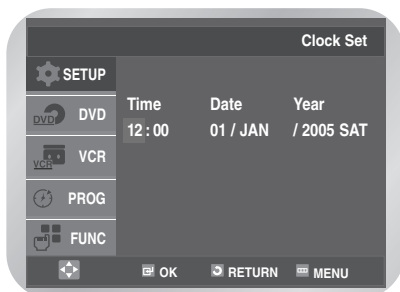

- 3 Press the **◀** or **▶** button to select the hour, minutes, day, month, and year. The selected option is highlighted. Press the **▲** or **▼** button to set them. The day of the week is displayed automatically. Press the **OK** button.

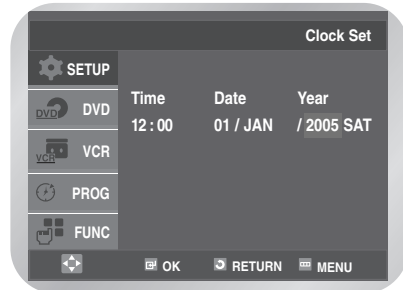

- You can hold the **▲** or **▼** button to scroll more quickly through the values.
- Press the **MENU** button to exit the menu.

Setting the Menu Language

- 1 Press the **MENU** button, then press the **OK** or **▶** button.
The **Language** is highlighted.

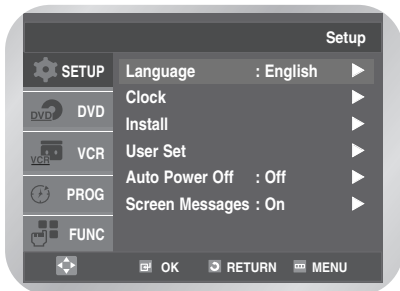

- 2 Press the **OK** or **▶** button again.
The **Language Set** menu is displayed.

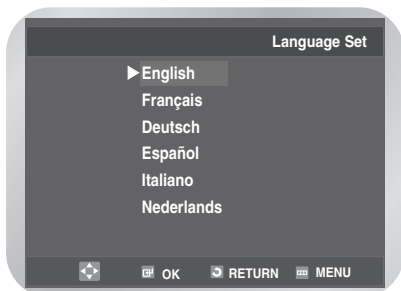

- 3 Press the **▲** or **▼** button to select desired language, then press the **OK** or **▶** button.
 - Press the **MENU** button to exit the menu.

Presetting the Stations Automatically

You do not need to preset the stations if you have already set them automatically (refer to “Plug & Auto Set Up” on page 15).

Your DVD-VCR contains a built-in tuner used to receive television broadcasts.

You must preset the stations received through the tuner. This can be done:

- Plug & Auto Set up (refer to page 15)
- Automatically
- Manually (refer to page 21)

You can store up to 80 stations.

- 1 Press the **MENU** button, then press the **OK** or **▶** button.

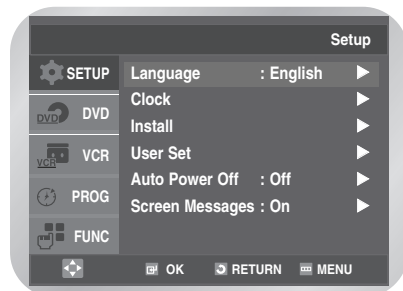

- 2 Press the **▲** or **▼** button to select **Install**, then press the **OK** or **▶** button.
The **Install** menu is displayed.

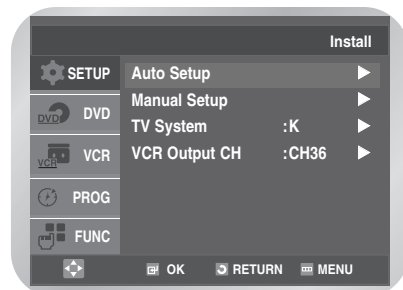

- 3** Press the ▲ or ▼ button to select **Auto Setup**. Press the **OK** button. A message is displayed, indicating that any channels already preset on your DVD-VCR will be deleted.

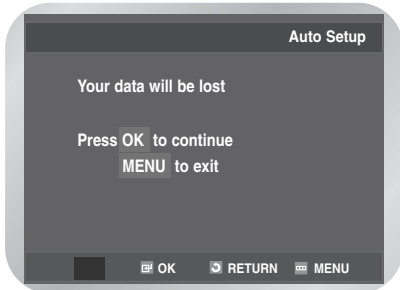

- 4** Press the **OK** button to start the auto scanning. The message **Please Wait** is displayed.

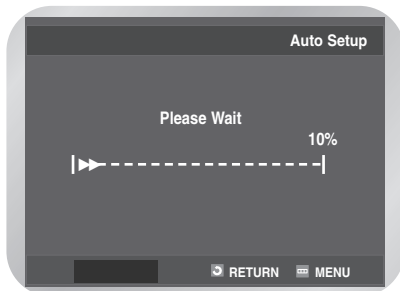

- The first frequency band is scanned and stored, then the DVD-VCR searches for the second station and so on. When the automatic scanning procedure has finished, the DVD-VCR switches automatically to programme 1.
- If you wish to cancel the auto scanning before the end, press the **MENU** button.



Note

- The number of stations automatically stored by the DVD-VCR depends on the number of stations that it has found.
- Once the auto scanning procedure has finished, some stations may have been stored more than once; select the stations with the best reception and delete the ones no longer required (refer to page 22).

Presetting the Stations Manually

You do not need to preset the stations manually if you have already set them automatically.

- 1** Press the **MENU** button, then press the **OK** or ► button.

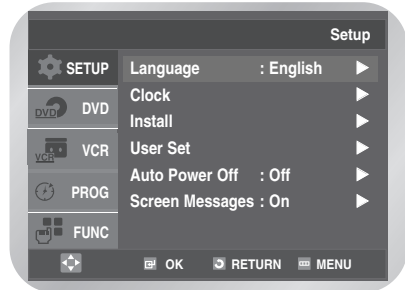

- 2** Press the ▲ or ▼ button to select **Install**, then press the **OK** or ► button. The **Install** menu is displayed.

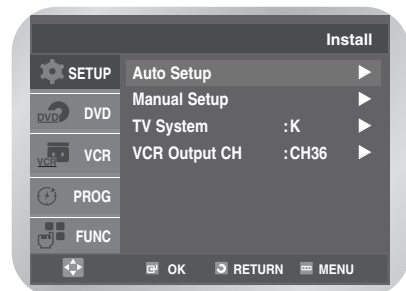

- 3** Press the ▲ or ▼ button to select **Manual Setup**, then press the **OK** or ► button. The **TV STATION TABLE** menu is displayed.

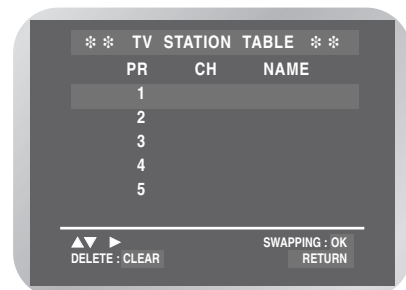

- 4** Press the ▲ or ▼ button to select the required programme number.
Press the ► button to preset the station.
The **MANUAL TUNING** menu will be displayed.

- 5** Press the ◀ or ▶ button to start scanning the channels.
The frequency band is scanned and the first station found is displayed.



- 6** If necessary, press the ▲ or ▼ button to select **MFT**, then press the ◀ or ▶ button to adjust the picture.

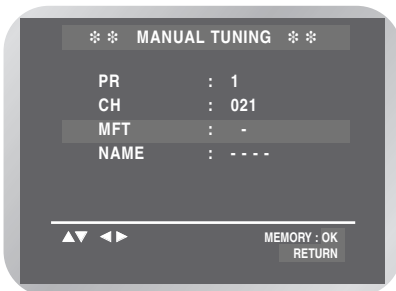

*** DVD-V6400/DVD-V6500**

- 7** Press the ▲ or ▼ button to select **DECODER**, then press the ◀ or ▶ button to select decoder **ON** or **OFF**.

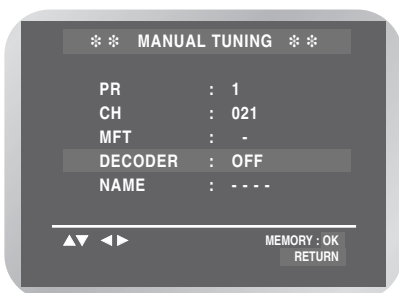

- 8** Press the ▲ or ▼ button to select **NAME**.
The station name is set automatically from the broadcast signal.

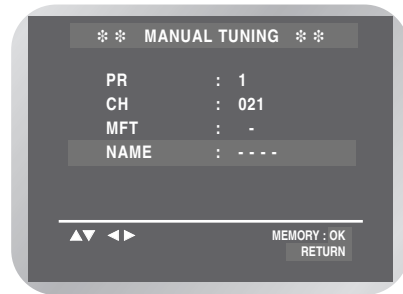

- To change the programme's name, press the ► button. The first letter of the name flashes.

To...	Then...
Select a character in the name	Press the ▲ or ▼ button until the required character is displayed (letters, numbers or "." character).
Move to the next previous or character	Press the ◀ or ▶ button respectively.

9

If you...	Then...
Wish to store the station displayed	• Press OK to store the station.
Do not wish to store the station displayed	• Press the ▲ or ▼ button until the CH is selected. • Press the ◀ or ▶ button to go on scanning the frequency band and display the next station.

- 10** Repeat this procedure from step 4 onwards, until all the required stations have been stored.

- 11** Press the **MENU** button to exit the menu.

Clearing a Preset Station

If you have stored a TV station:

- That you do not require
- At the wrong programme position, you can cancel it.

1 Press the **MENU** button, then press the **OK** or **▶** button.

2 Press the **▲** or **▼** button to select **Install**, then press the **OK** or **▶** button.
The **Install** menu is displayed.

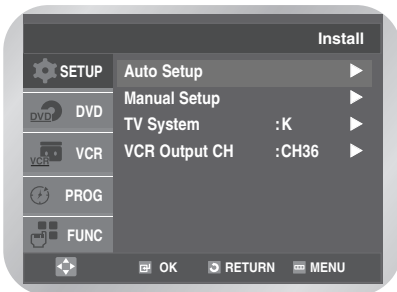

3 Press the **▲** or **▼** button to Select **Manual Setup**, then press the **OK** or **▶** button.
The **TV STATION TABLE** menu is displayed.

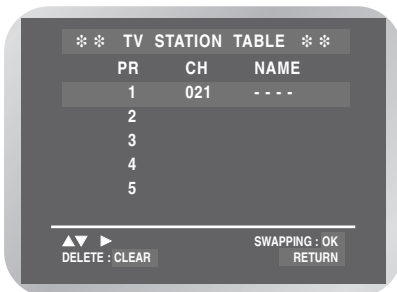

4 Press the **▲** or **▼** button to select required preset TV station.
Press the **CLEAR** button to delete.

5 Repeat the same procedure from step **4** onwards until all the required stations have been cleared.

Changing the Preset Station Table

You can rearrange the station table and give different programme numbers to the stations listed according to your own preferences.

1 Press the **MENU** button, then press the **OK** or **▶** button.

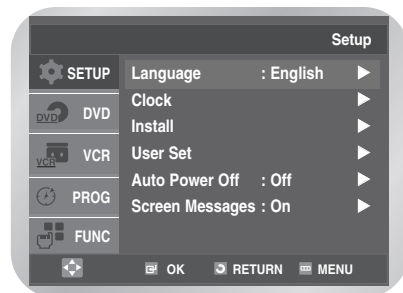

2 Press the **▲** or **▼** button to select **Install**, then press the **OK** or **▶** button.
The **Install** menu is displayed.

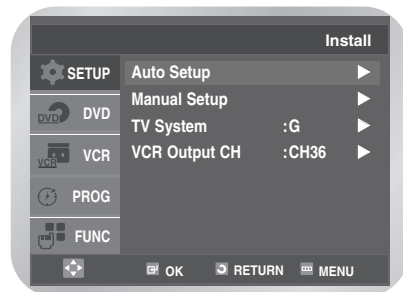

3 Press the **▲** or **▼** button to Select **Manual Setup**, then press the **OK** or **▶** button.
The **TV STATION TABLE** menu is displayed.

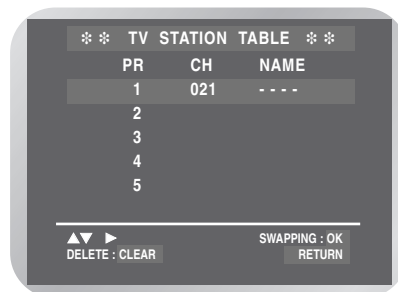

- 4** Press the ▲ or ▼ button to select required preset TV station.
The selected station is displayed at the same time on the television screen.

- 5** Press the **OK** button to change the programme number assigned to a station.

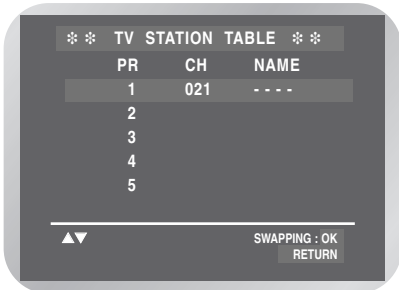

- 6** Press the ▲ or ▼ button to select required position, then press the **OK** button to swap the position.
For example, To move a TV station in programme 1 to programme 3.



- Press the **MENU** button to exit the menu.

Selecting the RF OUT Sound Mode (B/G-D/K)

You can choose the sound mode (B/G or D/K) according to the TV set connected to your VCR.

- 1** Press the **MENU** button, then press the **OK** or ► button.

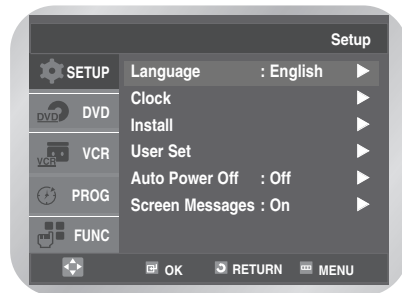

- 2** Press the ▲ or ▼ button to select **Install**, then press the **OK** or ► button.
The **Install** menu is displayed.

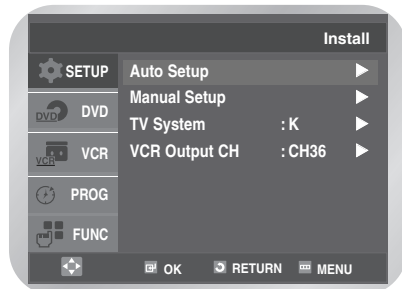

- 3** Press the ▲ or ▼ button to select **TV System**, then press the **OK** or ► button to select **G** or **K**.

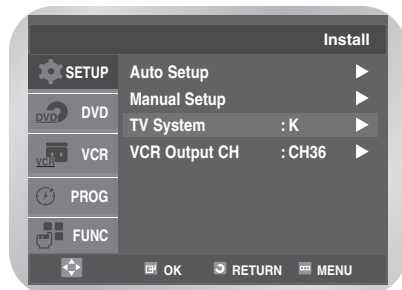

- Press the **MENU** button to exit the menu.

Setting the VCR Output Channel

Your DVD-VCR output channel may need to be changed if the pictures suffer from interference or if your TV cannot find the pictures.

- 1 Press the **MENU** button, then press the **OK** or **▶** button.
- 2 Press the **▲** or **▼** button to select **Install**, then press the **OK** or **▶** button.
The **Install** menu is displayed.

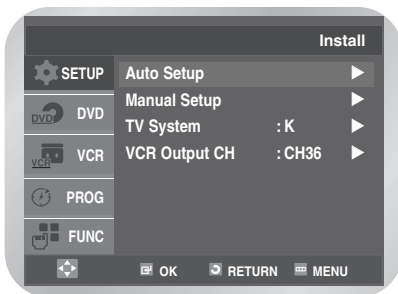

- 3 Press the **▲** or **▼** button to select **VCR Output CH**.

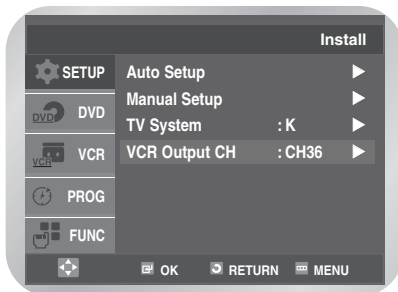

- 4 Press the **OK** or **◀** or **▶** button to select the required output channel (CH21~CH69).

→ CH21 → ..CH36 → ..CH69 →

- Press the **MENU** button to exit the menu.
Then tune your television again (see page 17).



Note

- You can select the required output channel directly by using the number button.

VCR Functions

- *Selecting the Colour Mode* 25
- *NICAM* 26
- *Intelligent Picture Control* 26
- *ShowView Extend (DVD-V6400/DVD-V6500)* . 27
- *Auto Power off* 27
- *Screen Messages* 28
- *Selecting the Cassette Type* 28
- *Repeat Play* 29
- *Selecting the Recording Speed* 29
- *Protecting a Recorded Cassette* 29
- *Recording a Programme Immediately* 30
- *Recording a Programme with Automatic Stop* . 30
- *Recording from Another VCR or Camcorder* ... 31
- *Using the Assemble Edit Function* 31
- *Using the ShowView Feature (DVD-V6400/DVD-V6500)* 32
- *Modifying ShowView Programming (DVD-V6400/DVD-V6500)* 33
- *Using the Timer Programming Feature* 34
- *Checking a Preset Recording* 36
- *Cancelling a Preset Recording* 37

Selecting the Colour Mode

Before recording or playing back a cassette, you can select the required system standard.

Otherwise, the system automatically selects the reception standard when you select AUTO.

- When playing back a cassette, the standard is automatically selected by the DVD-VCR.
- When you playback an NTSC-recorded tape on this DVD-VCR make a setting on the colour system according to your TV. If your TV is a PAL system only TV, set NTPB. If your TV is multi system TV (NTSC 4.43 compatible), set NT4.43 and you can record NT4.43.

- 1** Press the **MENU** button, then press the **OK** or **▶** button.

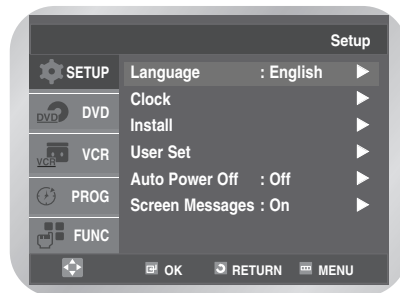

- 2** Press the **▲** or **▼** button to select **User Set**, then press the **OK** or **▶** button. The **User Set** menu is displayed.

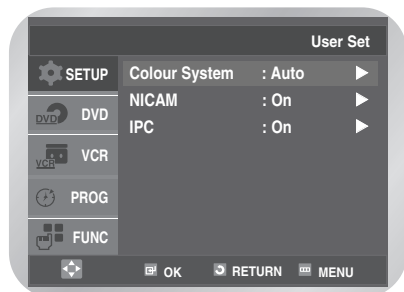

- 3** Press the **OK** or **▶** button to select required colour system. **Auto** → **PAL** → **MESECAM** → **B/W**
 - **Auto** : When playing back a cassette, the system standard is automatically selected by the DVD-VCR.
 - **B/W** : Black and White.

NICAM

NICAM programmes are divided into 3 types. NICAM Stereo, NICAM Mono and Bilingual (transmission in another language).

NICAM programmes are always accompanied by a standard mono sound broadcast and you can select the desired sound. Please refer to page 39.

- 1 Press the **MENU** button, then press the **OK** or **▶** button.

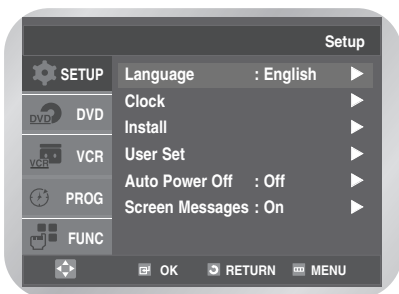

- 2 Press the **▲** or **▼** button to select **User Set**, then Press the **OK** or **▶** button. The **User Set** menu is displayed.

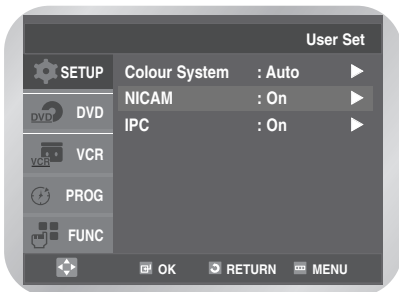

- 3 Press the **▲** or **▼** button to select **NICAM**, then press the **OK** or **▶** button to select **On** or **Off**.
 - **On** (for NICAM mode):
Normally set at this position
 - **Off** (for MONO mode):
Only set at this position to record the standard mono sound during a NICAM broadcast if the stereo sound is distorted due to inferior reception conditions.

Intelligent Picture Control

This feature allows you to adjust the sharpness of the image automatically, according to your own preferences.

- 1 During playback press the **MENU** button, then press the **OK** or **▶** button.
- 2 Press the **▲** or **▼** button to select **User Set**, then press the **OK** or **▶** button. The **User Set** menu is displayed.
- 3 Press the **▲** or **▼** button to select **IPC** (Intelligent Picture Control), then press the **OK** or **▶** button to select **IPC** option.

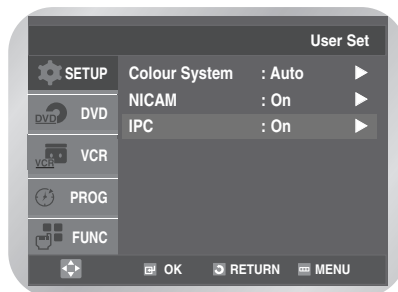

- You can select the modes simply by pressing the **IPC** button.

- 4 To adjust the sharpness manually, press the **▼** button to turn the IPC mode **OFF**. The sharpness of the picture is adjusted manually. Press the **◀** or **▶** buttons until the picture is displayed according to your preferences.

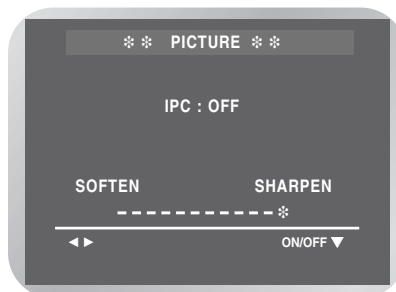

ShowView Extend (DVD-V6400/DVD-V6500)

To prevent delays or over-runs the VCR has a function called **ShowView Extend** allowing you to extend the recording time by up to 60 minutes.

- Only use if **PDC** is not available or set to **Off**.
- The View settings have been configured before running the Showview feature.

1 Press the **MENU** button, then press the **OK** or **▶** button.

2 Press the **▲** or **▼** button to select **User Set**, then press the **OK** or **▶** button.
The **User Set** menu is displayed.

3 Press the **▲** or **▼** button to select **ShowView Extend**.

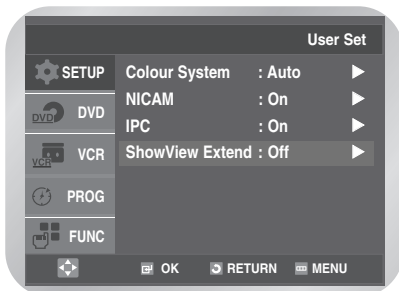

4 Press the **OK** or **▶** button to select the required time by increments of 10 minutes.

→ **Off** → 10 → 20 → 30 → 40 → 50 → 60 →

- Press the **MENU** button to exit the menu.

Auto Power off

This feature automatically turns off your DVD-VCR if no signal is received and you do not press any button for the selected time.

1 Press the **MENU** button, press the **OK** or **▶** button.

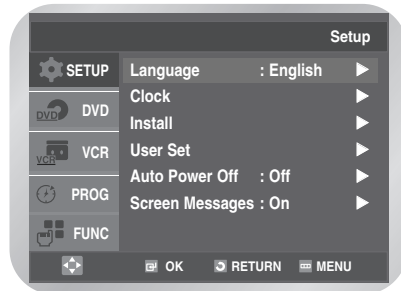

2 Press the **▲** or **▼** button to select **Auto Power Off**.

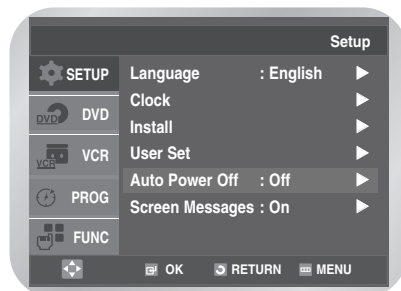

3 Press the **OK** or **▶** button to select the preset interval.

→ **Off** → 1 Hour → 2 Hour → 3 Hour →

- Press the **MENU** button to exit the menu.

Screen Messages

Your DVD-VCR displays most information both the DVD-VCR and the television.

You can choose to display or hide this information on the television screen (If you configure the Screen Message to Off, the Fast Forward and Rewind messages will not be displayed on the screen. However, the Search message will not be displayed on the screen regardless of the Screen Message configuration).

- 1 Press the **MENU** button, then press the **OK** or **▶** button.

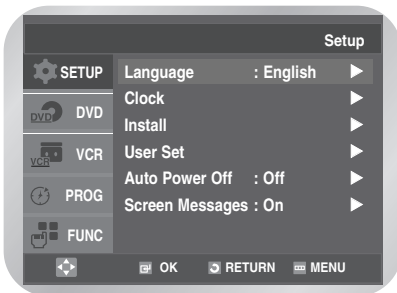

- 2 Press the **▲** or **▼** button to select **Screen Messages**.

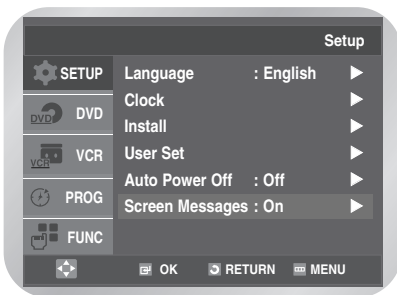

- 3 Press the **OK** or **▶** button to select **On** or **Off**.

- **On** : Select to display on-screen information.
- **Off** : Select to hide on-screen information.
- Press the **MENU** button to exit the menu.

Selecting the Cassette Type

If you wish to use the tape counter to display the time remaining on a cassette, you must indicate the type of cassette inserted.

- 1 Press the **MENU** button, then press the **▲** or **▼** button to select **VCR**.

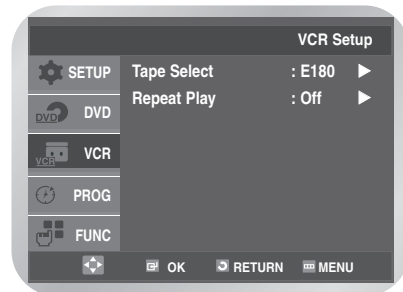

- 2 Press the **OK** or **▶** button. The **Tape Select** is highlighted.

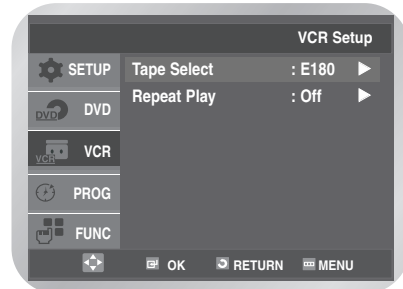

- 3 Press the **OK** or **▶** button to select the correct cassette length.

→ **E180** → **E240** → **E260** → **E300** →

- Press the **MENU** button to exit the menu.

Repeat Play

You can set repeat play to repeat the tape continuously from beginning to end.

- 1 Press the **MENU** button, then press the **▲** or **▼** button to select **VCR**.

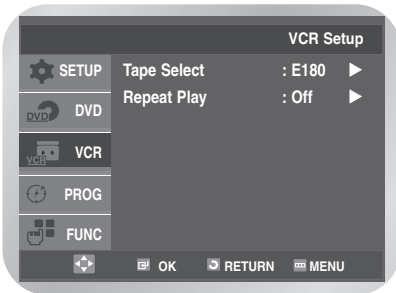

- 2 Press the **OK** or **▶** button. The **Tape Select** is highlighted.

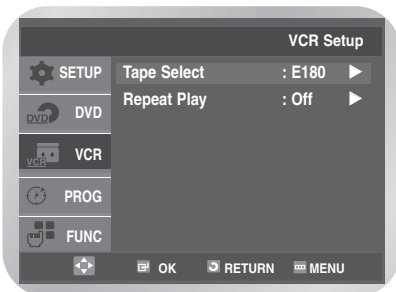

- 3 Press the **▲** or **▼** button to select **Repeat Play**. Press the **OK** or **▶** button to select **On** or **Off**.

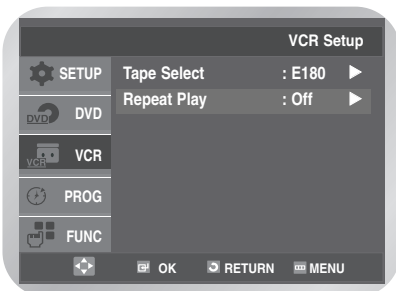

- **On** : Repeat play.
- **Off** : Do not wish to repeat play.

Selecting the Recording Speed

You can record a cassette at two different speeds:

- SP (Standard Play)
- LP (Long Play)

In Long Play modes:

- Each cassette lasts twice as long
- The recording is of a slightly lower quality

- 1 Press the **SPEED** button to select **SP** or **LP**.
 - The selected record speed will appear on the front panel display.

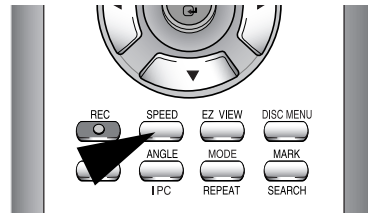

Type	Recording Time (in SP)
E180	180 mins. or 3 hours
E240	240 mins. or 4 hours
E260	260 mins. or 4 hours and 20 mins.
E300	300 mins. or 5 hours

Protecting a Recorded Cassette

Video cassettes have a safety tab to prevent accidental erasure. When this tab has been removed, you cannot record on the tape.

- 1 If you wish to protect a cassette, break off the tab using a small screwdriver.

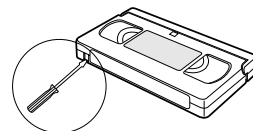

- 2 To re-record over a protected cassette (safety tab broken), cover the hole with adhesive tape.

Recording a Programme Immediately

Before recording a programme, you must have preset the corresponding station (unless you are recording via an external video source). If you have not done so, refer to pages 19~20.

- 1 Switch on the television.
- 2 Insert the video tape in to the VCR deck, with the window visible and the safety tab intact or the opening covered with adhesive tape. The DVD-VCR is switched on automatically.
- 3 Select the station by pressing the **PROG** \wedge or \vee button or select the source (AV1, AV2 or AUX (DVD-V5500/DVD-V6500)) by pressing the **INPUT SEL.** button for a satellite tuner or external video source. The station number is displayed and the programme can be seen on the television.
- 4 Select the recording speed by pressing the **SPEED** button as many times as required (refer to page 29).
- 5 Hold down the **REC** (●) button for a while to start recording.
The record indicator appears on the television and DVD-VCR display. An index is recorded on the tape (refer to page 40).
- 6 To stop recording, press the **■** button once.
 - If your DVD-VCR ejects the cassette when you start recording, check to make sure that the cassette's safety tab is intact or that the opening (created by a broken safety tab) is covered with adhesive tape.
 - If you reach the end of the tape while recording, the cassette rewinds automatically.

Recording a Programme with Automatic Stop

This function enables you to record up to nine hours (LP) of programmes.
Your DVD-VCR stops automatically after the requested length of time.

- 1 Switch on the television.
 - 2 Insert the cassette on which the programme is to be recorded, with the window visible and the safety tab intact or the opening covered with adhesive tape. The DVD-VCR is switched on automatically.
 - 3 Select the station to be recorded by pressing the **PROG** \wedge or \vee button or select the source (AV1, AV2 or AUX (DVD-V5500/DVD-V6500)) by pressing the **INPUT SEL.** button for a satellite tuner or external video source.
The station number is displayed and the programme can be seen on the television.
 - 4 Select the recording speed by pressing the **SPEED** button as many times as required (refer to page 29).
 - 5 Hold down the **REC** (●) button for a while to start recording.
The record indicator appears on the television screen and DVD-VCR display. An index is recorded on the tape (refer to page 40).
 - 6 Press the **REC** (●) button several times to increase the recording time in:
 - 30-minute intervals up to four hours
 - 1-hour intervals up to nine hours

The length is displayed on the television displays.
The selected programme is recorded for the length of time requested. At the end of that time, the DVD-VCR stops recording automatically and power off.
- LENGTH 2:30

SET LENGTH :
PRESS **REC** ●
- 7 If you wish to cancel the recording before the end, press the **STANDBY/ON** button.
 - If the end of the tape is reached while recording, the recording stops and power off.

Recording from Another VCR or Camcorder

You can copy a cassette to your DVD-VCR from another video source, such as another VCR or a Camcorder etc.

- It is an infringement of copyright laws to copy prerecorded cassettes or to re-record them in any form without the permission of the owners of the corresponding copyright.

1 Connect the output jack of your External devices to the SCART input connector or AUX(DVD-V5500/DVD-V6500) on the front or rear of the DVD-VCR.

2 Insert a blank cassette in your DVD-VCR.

3 Insert the pre-recorded cassette in the other video source (VCR or Camcorder etc).

4 Press the **INPUT SEL.** button to select the appropriate input on your DVD-VCR:

- AV1, AV2 for the SCART input
- AUX(DVD-V5500/DVD-V6500) for the RCA input

5 Start playing back the cassette to be copied.

6 Hold down the **REC (●)** button for a while to start recording on your DVD-VCR.

7 When you have finished recording, press the **■** button on both VCR and DVD-VCR.

- If you wish to view the cassette being copied, your DVD-VCR must be connected as usual to the television (refer to page 11 for further details).

Using the Assemble Edit Function

This function allows you to start a new recording at a specific position on the cassette while maintaining a very smooth scene change.

1 Insert the cassette to be edited in your DVD-VCR.

2 Press the **▶II** button to start playback.

3 When you reach the position from which you wish to start the new recording, press the **▶II** button.

4 Press the **F.ADV/STEP** button as often as necessary to advance frame by frame, until the exact recording position is located.

5 While the DVD-VCR is in still mode, hold down the **REC (●)** button for a while to activate the assemble edit function.

6 Select the source from which you wish to record by pressing:

- The **PROG** **▲** or **▼** button for television channels
- The **INPUT SEL.** button for the AV1, AV2 or AUX(DVD-V5500/DVD-V6500) input source.

7 Press the **▶II** button to start recording. When you have finished recording, press the **■** button.

Using the ShowView Feature (DVD-V6400/DVD-V6500)

Before presetting your DVD-VCR:

- Switch on both the television and your DVD-VCR
- Check that the date and time are correct
- Insert the cassette on which the programme is to be recorded (safety tab intact)

Up to six programmes can be preset.

- 1 Press the **MENU** button, then press the **▲** or **▼** button to select **PROG**, then press the **OK** or **▶** button.

The **Timer Method** menu is displayed.

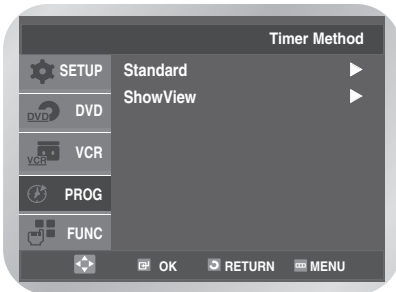

- 2 Press the **▲** or **▼** button to select **ShowView**, then press the **OK** or **▶** button.

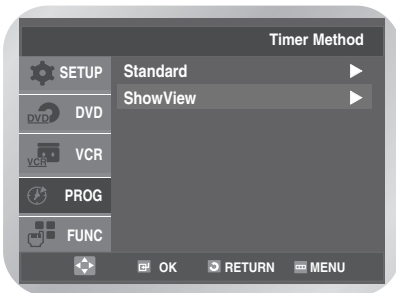

- It can be displayed simply by pressing the **TIMER** button on the remote control.



Note

- The Clock Settings menu will appear if the time was not set on the first run.

- 3 A message is displayed to allow you to enter the **ShowView** code.

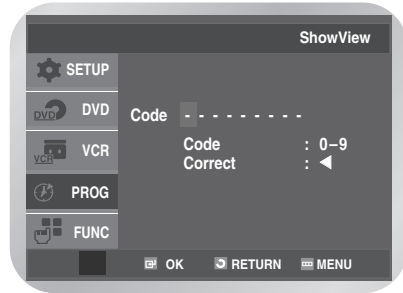

- If all six programmes have been set, the message **Timer is full** is displayed. Refer to page 36 if you wish to cancel a preset recording.

- 4 Press the number buttons to enter the code opposite the programme that you wish to record in your television magazine.

- If you wish to correct the **ShowView** code that you are entering:

- Press the **◀** button until the number to be corrected is cleared.
- Enter the correct number.

- 5 Press the **OK** button. The information concerning the programme is displayed.

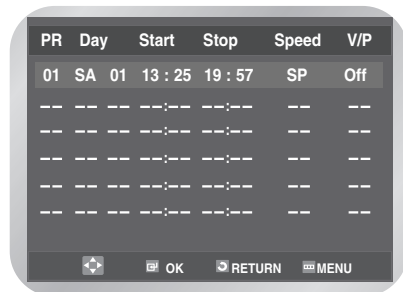

- When using the **ShowView** function for the first time with stored stations, the programme number flashes. This one time, you must enter the station number manually by pressing the **▲** or **▼** button. For more details, please refer to page 33.

6 If the programme and times are correct, press the **OK** button.

7 Press the **STANDBY/ON** button to activate the timer.

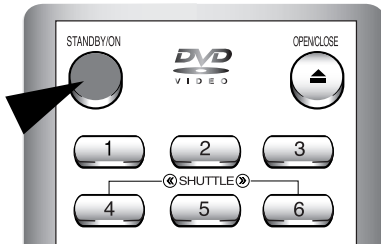

- The numbers next to each TV programme listing are **ShowView** code numbers, which allow you to programme your DVD-VCR instantly with the remote control. Tap in the **ShowView** code for the programme you wish to record.
- Refer to page 36~37 if you wish to:
 - Check that your DVD-VCR has been programmed correctly
 - Cancel a preset recording

ShowView is a trademark of Gemstar Development Corporation. The **ShowView** system is manufactured under licence from Gemstar Development Corporation.

Modifying ShowView Programming (DVD-V6400/DVD-V6500)

If you wish to correct the programme displayed or modify certain elements, such as the recording speed, you can do so before you press the **RETURN** button.

If you wish to...	Then...
Select an input source (AV1, AV2 or AUX(DVD-V6500)) other than the tuner	<ol style="list-style-type: none"> 1 Press the ◀ or ▶ button to select PR. 2 Press the INPUT SEL. button to select AV1, AV2, or AUX(DVD-V6500). <ul style="list-style-type: none"> • The input source must be selected before changing any other value.
Record a programme every day (Monday to Sunday) at the same time	<ol style="list-style-type: none"> 1 Press the ◀ or ▶ button to select Day. 2 Press the ▲ or ▼ button to select DLY (Daily).
Record a programme every week on the same day and at the same time	<ol style="list-style-type: none"> 1 Press the ◀ or ▶ button to select Day. 2 Press the ▲ or ▼ button to select the required day. <ul style="list-style-type: none"> DLY : Daily W-SU : Weekly Sunday W-MO : Weekly Monday W-TU : Weekly Tuesday W-WE : Weekly Wednesday W-TH : Weekly Thursday W-FR : Weekly Friday W-SA : Weekly Saturday SA 01 : Saturday 01
Extend the recording time	<ol style="list-style-type: none"> 1 Press the ◀ or ▶ button to select the recording stop time. 2 Press the ▲ or ▼ button to set the time.
Select the recording speed	<ol style="list-style-type: none"> 1 Press the ◀ or ▶ button to select Speed. 2 Press the ▲ or ▼ button to select the required speed. <ul style="list-style-type: none"> Auto → SP (Standard Play) → LP (Long Play)
Select the VPS/PDC recording	<ol style="list-style-type: none"> 1 Press the ◀ or ▶ button to select V/P (VPS/PDC). 2 Press the ▲ or ▼ button to select On. <ul style="list-style-type: none"> • Do not select V/P unless you are sure the programme you wish to record is broadcast with VPS/PDC. If you do set V/P to On, then you must set up the start-time exactly according to the published TV schedule. Otherwise the timer recording won't take place.

Using the Timer Programming Feature

The Timer Programming feature allows you to preset the DVD-VCR to record a programme up to one month before that programme is to be broadcast. Up to six programmes can be preset.

- Before presetting a recording, check that the date and time are correct.
- You must check that the cassette tape is loaded.

* DVD-V5450/DVD-V5500

- 1 Press the **MENU** button, then press the **▲** or **▼** button to select **PROG**, then press the **OK** or **▶** button.
The **Timer Method** menu is displayed.

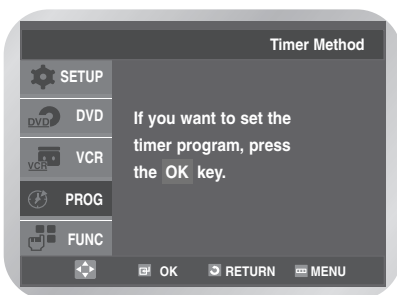

* DVD-V6400/DVD-V6500

- 1-1 Press the **MENU** button, then press the **▲** or **▼** button to select **PROG**, then press the **OK** or **▶** button.
The **Timer Method** menu is displayed.
Press the **▲** or **▼** button to select **Standard**, then press the **OK** or **▶** button.

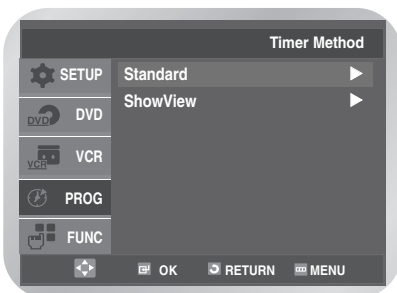

- 2 Press the **OK** or **▶** button again.
The timer programming menu is displayed.

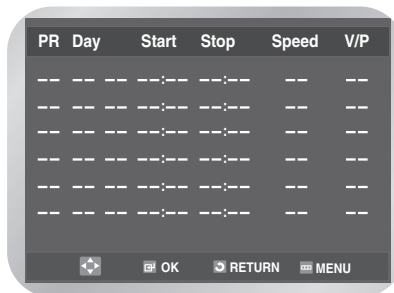

- It can be displayed simply by pressing the **TIMER** button on the remote control.

- 3 Press the **OK** or **▶** button to select **PR**, then press the **▲** or **▼** button to select the required station.

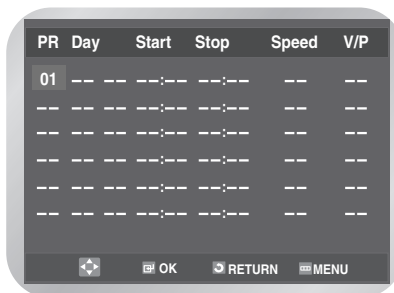

- Press the **INPUT SEL.** button to select an input source (AV1, AV2 or AUX(DVD-V5500/DVD-V6500)) other than the tuner.

- 4 Press the **▶** button to select **Day**, then press the **▲** or **▼** button to select the required day.

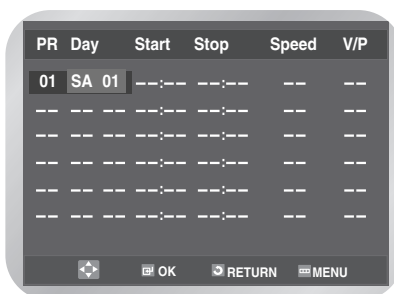

- **DLY** : Daily
- **W-SU** : Weekly Sunday
- **W-MO** : Weekly Monday
- **W-SA** : Weekly Saturday
- **SA 01** : Saturday 01

- 5** Press the ► button to select **Start** (recording start time).

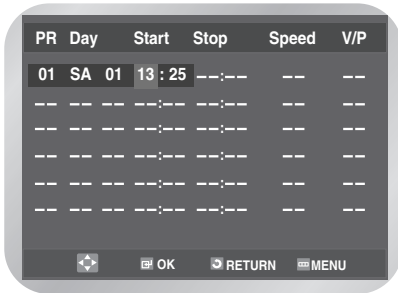

- Press the ◀ or ▶ button to select the hour or minute.
- Press the ▲ or ▼ button to set the stop time.

- 6** Press the ► button to select **Stop** (recording stop time).

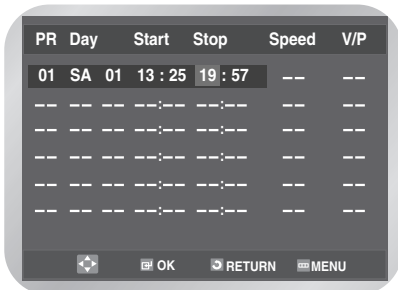

- Press the ◀ or ▶ button to select the hour or minute.
- Press the ▲ or ▼ button to set the stop time.

- 7** Press the ► button to select **Speed** (recording speed).

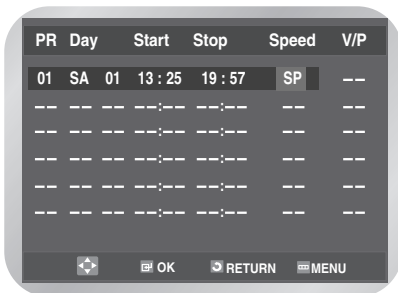

- Press the ▲ or ▼ button to select the required recording speed.
- **Auto** → **SP** (Standard Play) → **LP** (Long Play)
- **Auto Tape Speed Select**

The DVD-VCR's "Auto Tape Speed Select" function compares the duration of the timer recording to the actual recording time remaining on the tape loaded. If there is insufficient tape to complete a timer recording in **Auto** mode, the DVD-VCR automatically switches to **LP** mode to record the whole programme.

- 8** Press the ► button to select **V/P** (recording VPS/PDC).

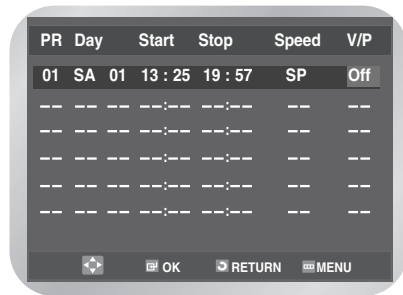

- Press the ▲ or ▼ button to select **On** or **Off**.

- 9** When you have finished, press the **OK** button to set the Timer Programming.

- 10** Press the **MENU** button to exit the menu.

- 11** Press the **STANDBY/ON** button to activate the timer.

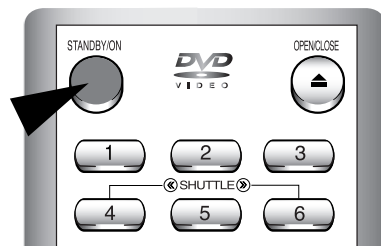

Before starting recording, the DVD-VCR compares the timer duration with the remaining time on the cassette.

Checking a Preset Recording

You can check your preset recordings:

- When you have finished presetting the DVD-VCR
- If you have forgotten which programmes will be recorded

* DVD-V5450/DVD-V5500

- 1 Press the **MENU** button, then press the **▲** or **▼** button to select **PROG**, then press the **OK** or **▶** button.
The **Timer Method** menu is displayed.

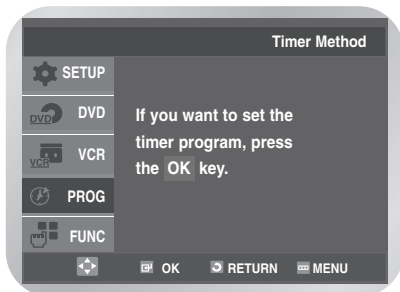

* DVD-V6400/DVD-V6500

- 1-1 Press the **MENU** button, then press the **▲** or **▼** button to select **PROG**, then press the **OK** or **▶** button.
The **Timer Method** menu is displayed.
Press the **▲** or **▼** button to select **Standard**, then press the **OK** or **▶** button.

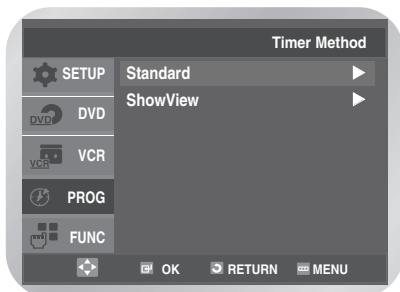

- 2 The list of preset recordings is displayed with the corresponding information.

PR	Day	Start	Stop	Speed	V/P
01	SA 01	13 : 25	19 : 57	SP	Off
--	--	-- : --	-- : --	--	--
--	--	-- : --	-- : --	--	--
--	--	-- : --	-- : --	--	--
--	--	-- : --	-- : --	--	--
--	--	-- : --	-- : --	--	--

- It can be displayed simply by pressing the **TIMER** button on the remote control.

- 3 To change any values, select the required programme by pressing the **▲** or **▼** button, then change any values as required. For more details refer to page 34. (Step 2 to 9)
• Press the **MENU** button to exit the menu.

Cancelling a Preset Recording

You can cancel any programmes that are:

- Incorrect
- No longer required

* DVD-V5450/DVD-V5500

- 1 Press the **MENU** button, then press the **▲** or **▼** button to select **PROG**, then press the **OK** or **▶** button.
The **Timer Method** menu is displayed.

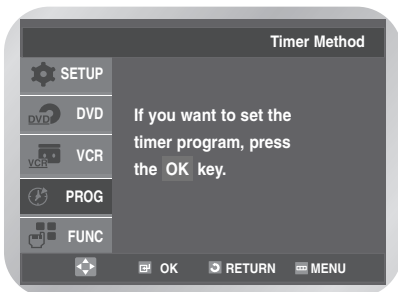

* DVD-V6400/DVD-V6500

- 1-1 Press the **MENU** button, then press the **▲** or **▼** button to select **PROG**, then press the **OK** or **▶** button.
The **Timer Method** menu is displayed.
Press the **▲** or **▼** button to select **Standard**, then press the **OK** or **▶** button.

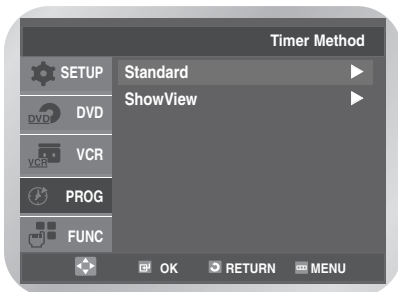

- 2 The list of preset recordings is displayed with the corresponding information.

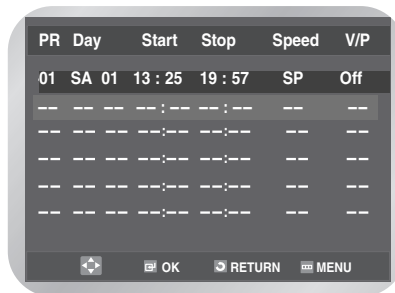

- It can be displayed simply by pressing the **TIMER** button on the remote control.

- 3 Press the **▲** or **▼** button to select the programme to be cancelled, then press the **CLEAR** button.

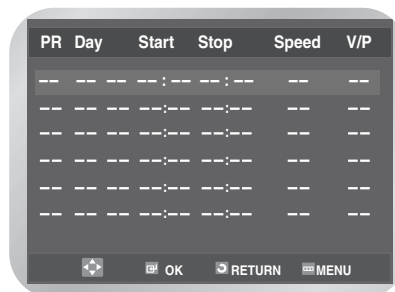

- All the recording information is deleted and the broadcast will not be recorded.
- Press the **MENU** button to exit the menu.

Playing Back

- *Playing a Cassette* 38
- *Adjusting Picture Alignment Manually* 38
- *Selecting the Audio Output Mode* 39
- *Playing a Cassette in Slow Motion* 39
- *Playing a Sequence Frame by Frame* 39
- *Playing a Sequence at Variable Speeds* 39
- *Searching for a Specific Sequence* 40
- *Using the Tape Counter* 41

Playing a Cassette

This function allows you to play back any pre-recorded cassette.

- 1** Switch on both the television and your DVD-VCR.
- 2** Insert the video cassette. If the safety tab on the cassette is intact, press the **▶||** (play/pause) button. Otherwise, the cassette is played automatically.
 - When a cassette is loaded, the tape position is optimized automatically to reduce disturbance (Digital Auto Tracking). When playing a cassette, if the end of the tape is reached, the cassette is rewound automatically. NTSC tapes can be played back but cannot be recorded with this DVD-VCR.
- 3** Press the **■** (stop) button to stop the playback. Press the **▲** (eject) button to eject the playback.

Adjusting Picture Alignment Manually

This feature allows you to adjust the alignment manually to obtain the best possible picture.

When noise bars or streaks appear during playback, adjust alignment manually by pressing the **TRK** (**△** or **▽**) button until the picture is clear and stable.

- ◆ The tracking bar appears.
- ◆ The image is adjusted.

Selecting the Audio Output Mode

You can select the mode in which the sound is reproduced on the loudspeakers and AV outputs. The following options are available.

Press the **AUDIO** button on the remote control until the required option is displayed.

Option	Description
L	Used to listen to the sound on the left Hi-Fi channel.
R	Used to listen to the sound on the right Hi-Fi channel.
MIX	Used to listen to the mixed sound of the Hi-Fi and normal channels.
MONO	Used to listen to the sound on the normal mono channel.
L R	Used to listen to Hi-Fi stereo sound on the left and right channels <ul style="list-style-type: none"> When playing back tapes recorded in Hi-Fi, the sound switches to Hi-Fi after five seconds of Mono.

To select the sound mode, simply press the **AUDIO** button on the remote control until the required option is displayed.

→ L → R → MIX → MONO → L R

Playing a Cassette in Slow Motion

You can play a cassette in slow motion.

- No sound is heard when playing back a cassette in slow motion.

- Press the :
 - ▶|| button to start playing the cassette.
 - ▶|| button again to make still mode.
 - ▶▶ button to start slow mode.
 - ◀◀ or ▶▶ button as many times as required to decrease or increase the speed respectively.
 - ▶|| button twice to return to the normal speed.
 - The slow motion feature does not support running video backwards.

- When playing back in slow motion, picture interference may occur. Press the **TRK** (△ or ▽) button to minimize this effect.
 - When you have been using the Slow Motion function for more than about two minutes, the DVD-VCR will automatically play to protect the:
 - Cassette
 - Video heads

Playing a Sequence Frame by Frame

You can

- Stop the cassette at a given frame (image)
- Advance one frame at a time

No sound is heard when playing back frame by frame.

- Press the :
 - ▶|| button to start playing the cassette.
 - ▶|| button again to make still mode.
 - F.ADV button to advance frame by frame.
 - ▶|| button to return to normal playback.
 - Vertical stability: When playing back frame by frame, interference may be seen on the screen. Press the **TRK** (△ or ▽) button to minimize this effect.

Playing a Sequence at Variable Speeds

You can vary the playback speed using the Shuttle function (up to nine times the normal speed).

Example: You wish to analyse a sportsperson's technique, movement by movement.

- No sound is heard when playing a sequence at variable speeds.

- Press the :
 - ▶|| button to start playing the cassette.
 - SHUTTLE** (<<) button to play the cassette backwards.
 - SHUTTLE** (>>) button to play the cassette forwards.

- Each time you press the **SHUTTLE** button, the speed is changed as shown in the following illustration.

REVERSE PLAY X9	REVERSE PLAY X5	REVERSE PLAY X3	STILL	SLOW MOTION X1/10	SLOW MOTION X1/5	PLAY X3	PLAY X5	PLAY X9
-----------------------	-----------------------	-----------------------	-------	-------------------------	------------------------	------------	------------	------------

Searching for a Specific Sequence

Each time you record a cassette on this DVD-VCR, an "index" is automatically marked on the tape when recording starts. The Search function allows you to fast-forward or rewind to a specific index and start playback from that point. Depending on the direction selected, the indexes are numbered as follows:

↓

etc.	Prev Seq.	Seq. being played	Next Seq.	etc.
2	1		1	2

- This DVD-VCR uses a standard indexing system (VISS). As a result, it will recognize any indexes marked by other VCRs using the same system and vice versa.

Go To [0:00:00] Stop

Use this feature when you want to search for the 0:00:00 counter position on a cassette. Press the **CLEAR** button at the point on the tape where you want to set the counter to 0:00:00. The VCR will rewind or fast forward, searching for the 0:00:00 counter position, and then automatically stop at that position.

- 1 Press the **MENU** button, then press the ▲ or ▼ button to select **FUNC**. Press the **OK** or ► button. The **Function** menu is displayed.

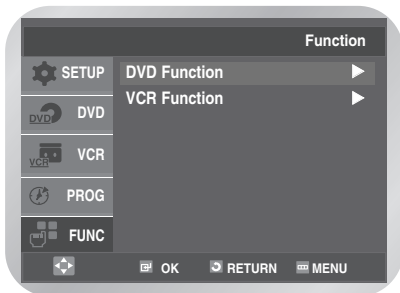

- 2 Press the ▲ or ▼ button to select **VCR Function**, then press the **OK** or ► button. The **VCR Function** menu is displayed with the **Go To [0:00:00]** selected.

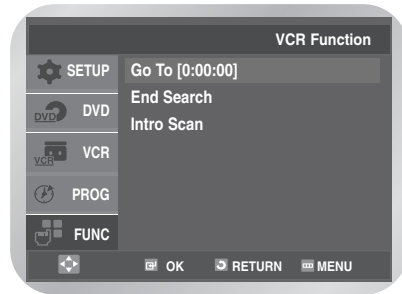

- It can be displayed simply by pressing the **SEARCH** button.

- 3 Press the **OK** or ► button again.

End Search

Use this feature when you want to search for a blank position to record a program on a cassette.

The VCR will fast forward, searching for a blank position, and then automatically stop at that position. If the VCR reaches the end of the tape during end search, the tape will be ejected.

- 1 Press the **SEARCH** button. The **VCR Function** menu is displayed. Press the ▲ or ▼ button to select **End Search**.

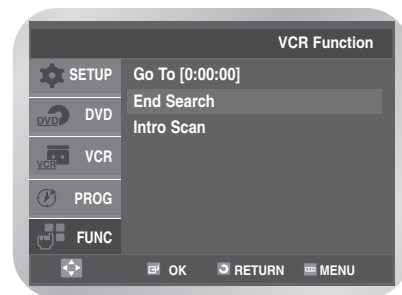

- 2 Press the **OK** or ► button.

Intro Scan

- 1 Press the **SEARCH** button.
The **VCR Function** menu is displayed.
Press the **▲** or **▼** button to select **Intro Scan**.

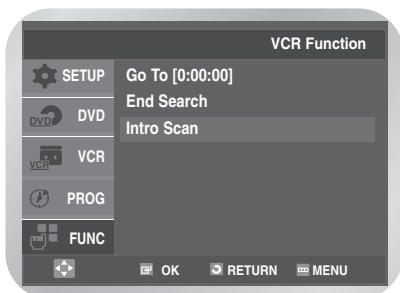

- 2 Press the **OK** or **▶** button.
- 3 Press the **◀◀** or **▶▶** button depending on the direction where your desired programme is located.

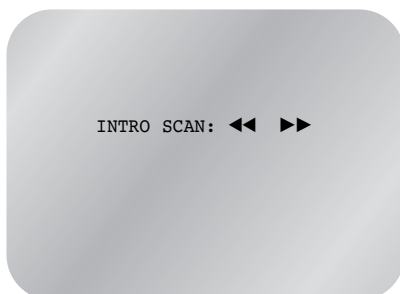

- 4 When an Index mark is found the DVD-VCR will playback the tape for 5 seconds, after which it will continue searching for the next Index mark.

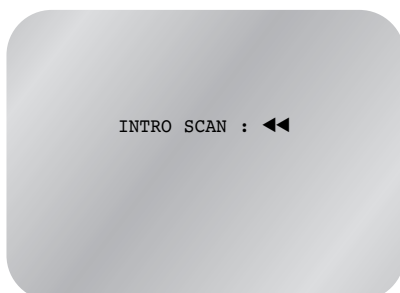

- 5 If you want to watch the tape from a particular Index, press the **▶||** button twice.

Index Skip Search

This feature will enable you to fast forward/rewind to a specific point on a tape: e.g. if you have recorded 3 different programmes on a tape and you have rewound the tape to the beginning, by using this feature you can go directly to the start of programme 2 simply by pressing the **SEARCH** button.

- 1 Press the **SEARCH** button.
The **VCR Function** menu is displayed.
Press the **▲** or **▼** button to select **Intro Scan**.

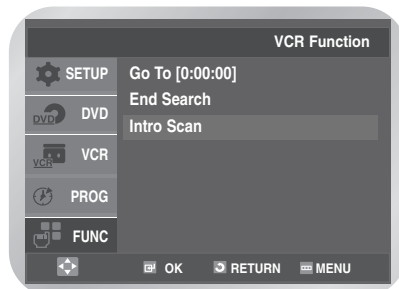

- 2 Press the **OK** or **▶** button.
- 3 Press the **◀◀** or **▶▶** button twice more.
- 4 These Index searches can be made forwards (press the **▶▶** button) or backwards (press the **◀◀** button).
(◀◀ -20 . . 0 . . +20 ▶▶)
This will take you directly to the start of the desired programme is located.

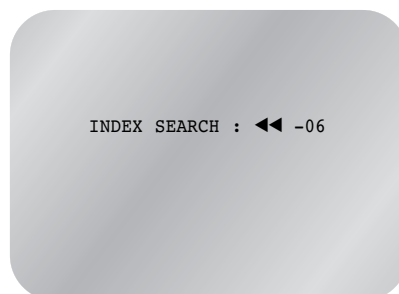

To cancel an Index search simply press the **▶||** or **■** button.

Using the Tape Counter



The tape counter:

- Indicates the elapsed time in the play and record modes (hours, minutes and seconds)
- Is reset when a cassette is inserted in the DVD-VCR
- Allows you to find the beginning of a sequence easily
- If the remaining time is to be calculated correctly, you must indicate the type of cassette being used.

- 1** Insert a cassette in your DVD-VCR.
To set the tape counter to zero at the beginning of a sequence:

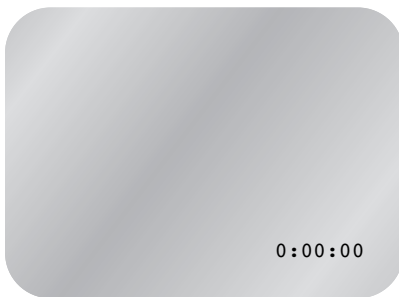

- Press the **INFO.** button twice to display the counter
- Press the **CLEAR** button when you want to set the tape counter to zero

- 2** When you are ready,
 - Start playback or Recording.
 - Press the **■** button.
 - To fast-forward or rewind to the sequence at which the counter was set to zero, press the **◀◀** or **▶▶** button.
 - Some DVD-VCR information, such as the counter, can be displayed on the television screen (unless you have deactivated the **Screen Messages** mode; refer to page 28).

Press the **INFO.** button:

- Once to display the current function, programme number, recording speed, date, time and counter
- Twice to display the counter only
- Three times to display the time remaining on the cassette
- Four times to clear the display

DVD Functions

- *Setting Up the Language Features* 43
- *Setting Up the Audio Options* 45
- *Setting Up the Display Options* 46
- *Setting Up the Parental Control* 47
- *DivX(R) Registration (DVD-V6400/DVD-V6500)* 49
- *Firmware Upgrade (DVD-V6400/DVD-6500)* . 49
- *Special Playback Features* 51
- *Using the Display Function* 52
- *Adjusting the Aspect Ratio (EZ View)* 53
- *Selecting the Subtitle Language* 54
- *Selecting the Audio Language* 54
- *Changing the Camera Angle* 55
- *Zoom* 55
- *Marks* 56
- *Repeat Chapter/Title* 56
- *A to B Repeat* 57
- *MP3/WMA Play* 58
- *Program & Random Play (CD/MP3/WMA)* . . . 59
- *Picture CD Playback* 60
- *DivX/MPEG4 Playback (DVD-V6400/DVD-V6500)* 62
- *DivX/MPEG4 Special Playback Features (DVD-V6400/DVD-V6500)* 62

Setting Up the Language Features

If you set disc menu, audio and subtitle language in advance, it will come up automatically every time you watch a movie.

Using the Disc Menu Language

- 1 Press the **MENU** button in the stop mode. Press the **▲** or **▼** button to select **DVD**, then press the **OK** or **▶** button.



- 2 Press the **OK** or **▶** button again. Press the **▲** or **▼** button to select **Disc Menu**, then press the **OK** or **▶** button.

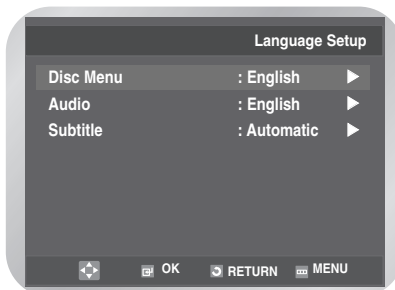

- 3 Press the **▲** or **▼** button to select the required language.

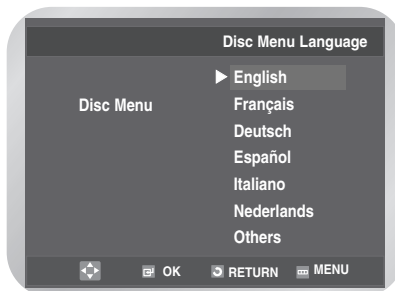

• Select **Others** if the language you want is not listed.

- 4 Press the **OK** button.

Using the Audio Language

- 1 Press the **MENU** button in the stop mode. Press the **▲** or **▼** button to select **DVD**, then press the **OK** or **▶** button.

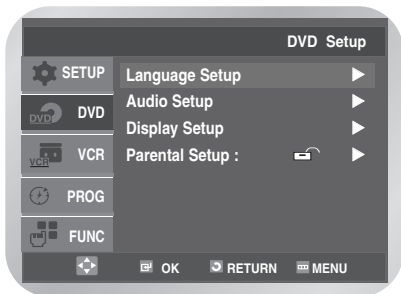

- 2 Press the **OK** or **▶** button again. Press the **▲** or **▼** button to select **Audio**, then press the **OK** or **▶** button.

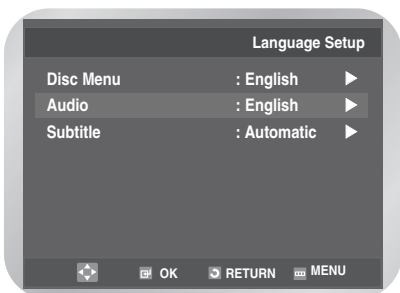

- 3 Press the **▲** or **▼** button to select the required language.

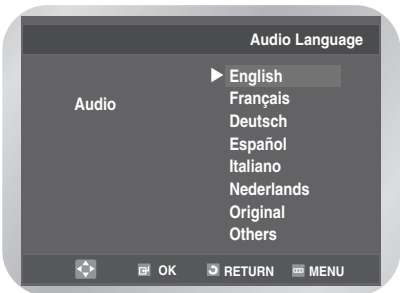

- Select **Original** if you want the default soundtrack language to be the original language the disc is recorded in.
- Select **Others** if the language you want is not listed.

- 4 Press the **OK** button.

Using the Subtitle Language

- 1 Press the **MENU** button in the stop mode. Press the **▲** or **▼** button to select **DVD**, then press the **OK** or **▶** button.

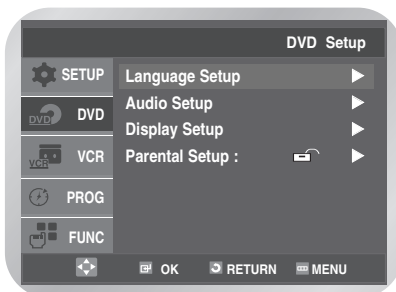

- 2 Press the **OK** or **▶** button again. Press the **▲** or **▼** button to select **Subtitle**, then press the **OK** or **▶** button.

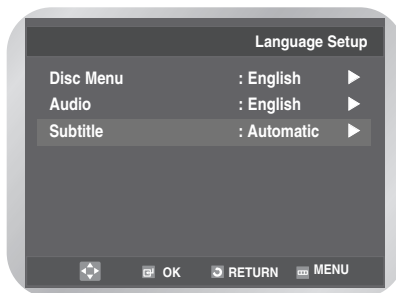

- 3 Press the **▲** or **▼** button to select the required language.

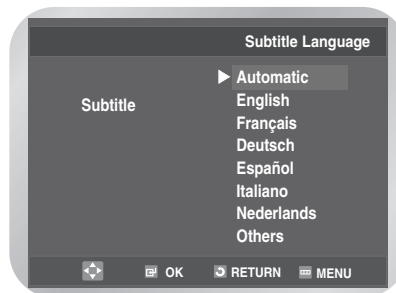

- Select **Automatic** if you want the subtitle language to be the same as the language selected as the audio language.
- Select **Others** if the language you want is not listed.

- 4 Press the **OK** button.



Note

- Some discs may not contain the language you select as your initial language; in that case the disc will use its original language setting.

Setting Up the Audio Options

- 1 Press the **MENU** button in the stop mode. Press the **▲** or **▼** button to select **DVD**, then press the **OK** or **▶** button.

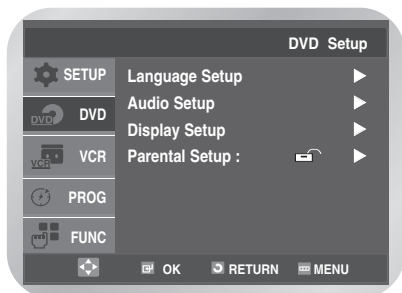

- 2 Press the **▲** or **▼** button to select **Audio Setup**, then press the **OK** or **▶** button.

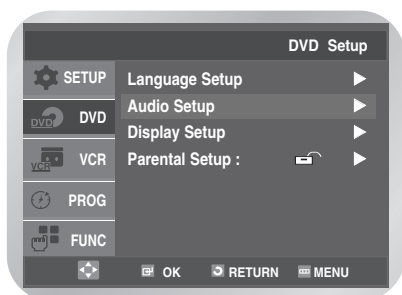

- 3 The **Audio Setup** menu is displayed.

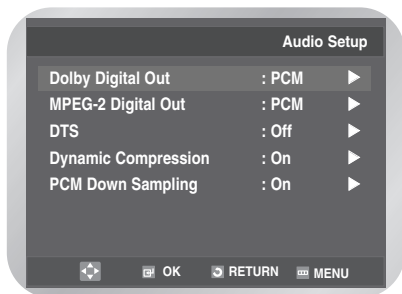

- 4 Press the **▲** or **▼** button to select the required item.

- 5 Press the **OK** or **▶** button to select the required option.

■ Dolby Digital Out

- **PCM** : Converts to PCM (2CH) audio. Select PCM when using the Analog Audio Outputs.
- **Bitstream** : Converts to Dolby Digital Bitstream (5.1CH). Select Bitstream when using the Digital Audio Output.



Note

Be sure to select the correct Digital Output or no audio will be heard.

■ MPEG-2 Digital Out

- **PCM** : Converts to PCM (2CH) audio. Select PCM when using the Analog Audio Outputs.
- **Bitstream** : Converts to MPEG-2 Digital Bitstream (5.1CH or 7.1CH). Select Bitstream when using the Digital Audio Output.

■ DTS

- **Off** : Doesn't output digital signal.
- **On** : Outputs DTS Bitstream via digital output only. Select DTS when connecting to a DTS Decoder.

■ Dynamic Compression

- **On** : To select dynamic compression.
- **Off** : To select the standard range.

■ PCM Down Sampling

- **On** : Select this when the amplifier connected to the player is not 96KHz compatible. In this case, the 96KHz signals will be down converted to 48KHz.
- **Off** : Select this when the amplifier connected to the player is 96KHz compatible. In this case, all signals will be output without any changes.



Note

■ How to make the **DVD** menu disappear or return to menu screen during set up; Press **RETURN** or **◀** button.

■ Manufactured under license from Dolby Laboratories. "Dolby" and the double-D symbol are trademarks of Dolby Laboratories.

■ "DTS" and "DTS Digital Out" are trademarks of Digital Theater Systems, Inc.

Setting Up the Display Options

- 1 Press the **MENU** button in the stop mode. Press the **▲** or **▼** button to select **DVD**, then press the **OK** or **▶** button.

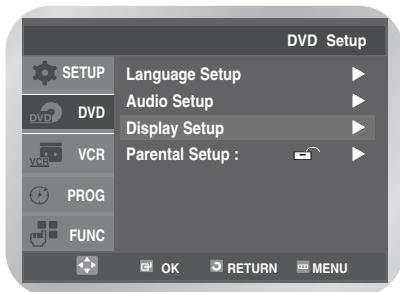

- 2 Press the **▲** or **▼** button to select **Display Setup**, then press the **OK** or **▶** button.

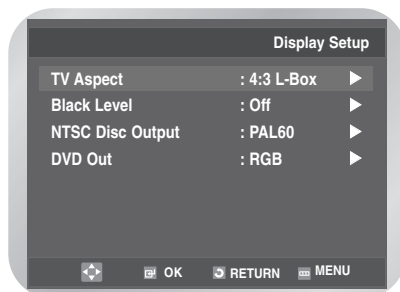

- 3 Press the **▲** or **▼** button to select **TV Aspect**, press the **OK** or **▶** button.

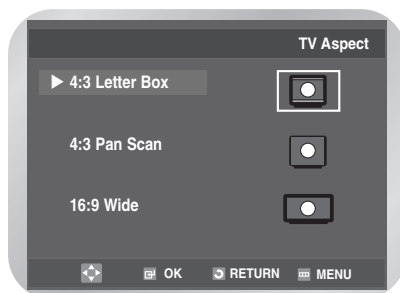

- 4 Press the **▲** or **▼** button to select the required item, then press the **OK** button to select the required option

TV Aspect

Depending on the type of television you have, you may want to adjust the screen setting (aspect ratio).

• 4:3 Letter Box :

Select when you want to see the total 16:9 ratio screen DVD supplies, even though you have a TV with a 4:3 ratio screen. Black bars will appear at the top and bottom of the screen.

• 4:3 Pan Scan :

Select this for conventional size TVs when you want to see the central portion of the 16:9 screen. (Extreme left and right side of movie picture will be cut off.)

• 16:9 Wide :

You can view the full 16:9 picture on your widescreen TV.

Black Level

Adjusts the brightness of the screen. (**On/Off**)

NTSC Disc Output

“**NTSC**” if the screen only has one NTSC-video entrance. If this is not the case, you can choose to leave “**PAL60**” as is.

DVD Out

- **RGB** : Sends RGB signal from the AV JACK (SCART terminal).
- **S-Video** : Sends S-VIDEO signal from the AV JACK (S-Video terminal).
- **Video** : Sends COMPOSITE VIDEO signal from the AV JACK (SCART terminal).

Setting Up the Parental Control

The Parental Control function works in conjunction with DVDs that have been assigned a rating - which helps you control the types of DVDs that your family watches. There are up to 8 rating levels on a disc.

- 1 Press the **MENU** button in the stop mode.
Press the **▲** or **▼** button to select **DVD**, then press the **OK** or **▶** button.
Press the **▲** or **▼** button to select **Parental Setup**.

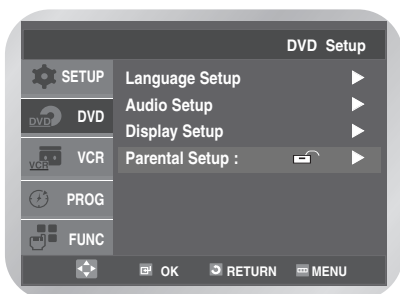

- 2 Press the **OK** or **▶** button.
The **Use Password** menu is displayed.

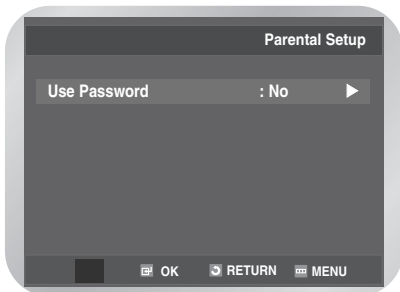

- 3 Press the **OK** or **▶** button again if you want to use a password.
The **Enter Password** menu is displayed.
Enter your password by pressing the number buttons.

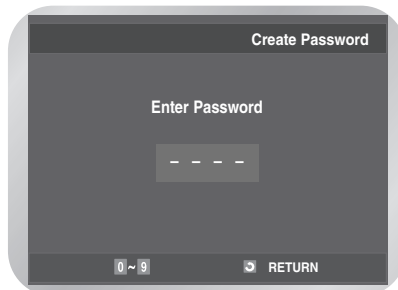

The **Re-enter Password** menu is displayed to confirm the password.

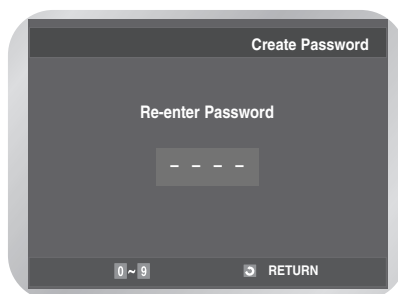

- 4 Enter your password again.
The **Use Password** is set to **Yes** and the **Parental Setup** menu is displayed.
The DVD-VCR is locked ().

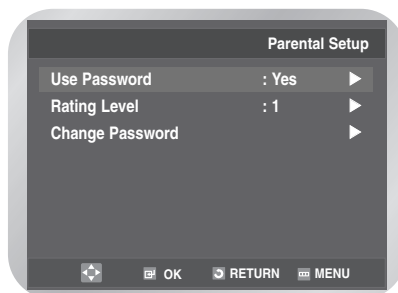

■ Setting up the Rating Level

- 5** Press the ▲ or ▼ button to select **Rating Level**, then press the **OK** or ► button.

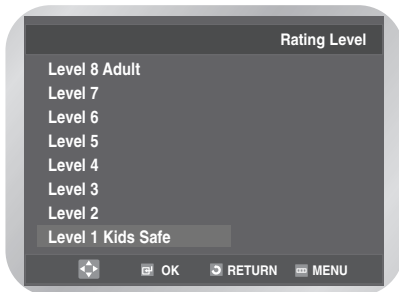
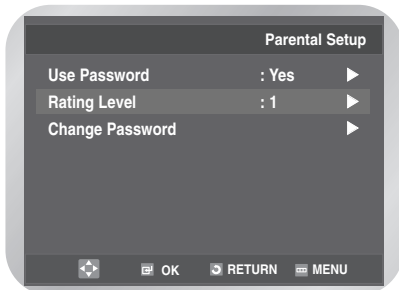

- 6** Press the ▲ or ▼ button to select the required level (e.g. **Level 6**). Press the **OK** or ► button.
- Discs that contain Level 7 will now not play.

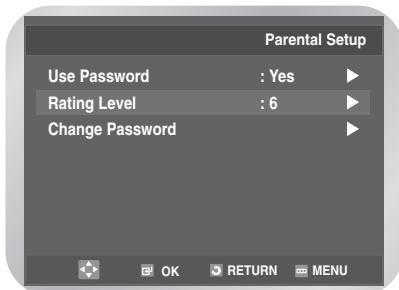

■ Changing the Password

- 5** Press the ▲ or ▼ button to select **Change password**.

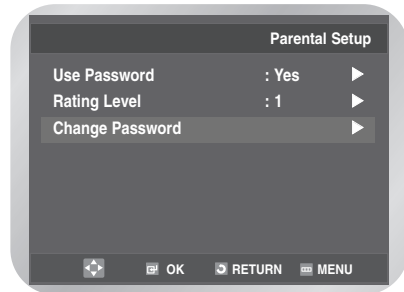

- 6** Press the **OK** or ► button. The **Enter New Password** is displayed. Enter your password by pressing the number buttons.

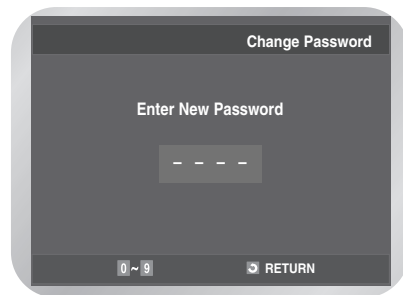

The **Re-enter Password** is displayed to confirm the password.

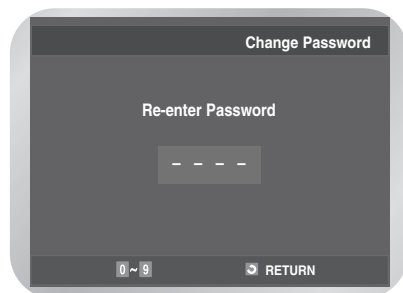

- 7** Enter your password again.
- How to make the **DVD** menu disappear or return to menu screen during set up; Press the **RETURN** or ◀ button.
 - If you have forgotten your password, refer to **Forgot Password** in the **Troubleshooting Guide** (See page 67).

DivX(R) Registration (DVD-V6400/DVD-V6500)

Please use your registration code to register this player with the DivX(R) Video On Demand service. This will allow you to rent and purchase videos using the DivX(R) Video On Demand format. To learn more go to www.divx.com/vod.

- 1 Press the **MENU** button in the stop mode. Press the **▲** or **▼** button to select **DVD**. The **DVD Setup** menu is displayed.

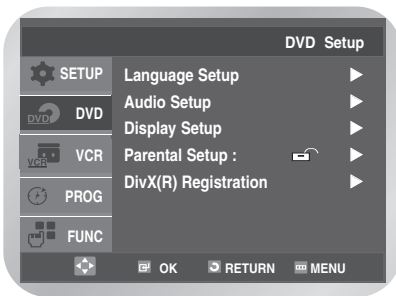

- 2 Press the **OK** or **▶** button. Press the **▲** or **▼** button to select **DivX(R) Registration**.



- 3 Press the **OK** or **▶** button. A message is displayed.

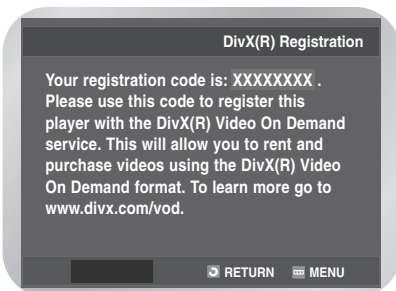

DivX, DivX Certified, and associated logos are trademarks of DivXNetworks, Inc and are used under license.



Firmware Upgrade (DVD-V6400/DVD-V6500)

Please read the below information before update procedure.

- 1 The following events may interrupt the update procedure and **may result in permanent damage to DVD-VCR**.
 - Unplugging the power cord.
 - Power Outage.
 - Dirt or Scratch in the discs.
 - Open a tray door during processing.

- 2 Playback can only support English Subtitle. If you have any question or any problem, please feel free to contact your nearest SAMSUNG Service Center and agency.

DivX Feature Table

- A DivX disc may not be playable as playback depends on the file format, the recording conditions, the recording method, etc.
- A video file that has not been interleaved supports only voice or video.
- Check the DivX disc format as this is not an error.
- Normal operation is only possible when the screen size is 720X480 pixels or less (width x height).
- A maximum of 65 characters for the caption title of a DivX disc is supported.
- Unsupported caption content will be displayed using asterisks (*).

DivX can be divided into Video and Audio.

Supported CODEC formats	DivX3, DivX4, DivX5 (GMC 1WP)
Supported file formats	*.avi, *.mpeg
Supported audio formats	AC3, MP3, WMA
Supported caption formats	*.SMI, *.SRT, *.SUB

How to make an update disc

Write the downloaded file onto a blank CD-R disc, using the following settings.

- Download the software update file from the Samsung Internet Site. (<http://www.samsung.com/Support/ProductSupport/Download/index.aspx>) After checking your DVD-VCR Model name on the rear, download a file using the **Search Your Model/Name** window.

- Write the file to disc using CD-R driver of your computer.
Software update file name: **sam98-b.rom**
Please do not change the file name.
If you change the file name, DVD-VCR do not recognize the update CD-R.



Note

- Recommended Application Program
 - Nero Burning / Easy CD Creator .. etc
- Option
 - Multisession ; No Multisession
 - CD close or Finalized CD
- In order to increase Disc Playability, add a dummy file (over 100MB) together with the update file in CD-R, not CD-RW. (The Dummy File can be used any kind of file except jpg, mp3, wma file. Zip file format is recommended.)

Update procedure

- Insert the update CD-R disc with the software update.
It takes about 30 seconds to load the update disc.

- READING** appears at the left upper side of the screen.

READING

- ERASE** and **WRITE** appears in turn at the same location for about 40 sec during firmware update.

ERASE
RETR 05

- It will be displayed **DONE** if the update is completed successfully.

DONE
RETR 05

- After update is completed, you have to power off the unit and eject the update disc by using the **OPEN/CLOSE** button once the unit turns on.

- Firmware update is ended. Turn on your player and enjoy a DivX movie.

Code Ver : XXXXXXXXX
Servo Ver : XXXXXXXXX

- In order to check new version like the upper, press the **INFO.** button after opening a tray.



Note

- The display can be changed depend on its version and without any notice.

Special Playback Features



During DVD/CD playback you can select from the following special playback options. To resume normal playback, press the ►|| button.

■ Still

Press the ►|| button during playback.

- The picture will still and the audio will mute.
- To resume playback, press the ►|| button.
- If the player is left in still mode for 5 minutes, it will stop automatically.

■ Frame Advance (Step)

While in playback mode, press the **F.ADV/STEP** button on the remote control to advance one frame at a time.

- Audio is muted during frame advance mode.
- Press the ►|| button to resume normal playback.



Note

- Frame Advance operates only in the forward direction.

■ Skip Forward/Back

While a CD or DVD disc is in play mode, press the I◀◀ or ▶▶I button to jump forward and backward through disc chapters/tracks.

- Skip Forward (▶▶I) will jump to the next chapter/track.
- Skip Back (I◀◀) will jump to the beginning of the current chapter/track.
- Press the I◀◀ button again to jump to the beginning of the previous chapter/track.

■ Search Forward/Back

While a disc is in play mode, press and hold the ◀◀ or ▶▶ button to visually search forward/backward at 2X - 4X - 8X - 16X - 32X - 128X speed.

Press the ►|| button to resume normal speed.

- CD : 2X - 4X - 8X - 16X - 32X

■ Slow Motion

During playback, press the ►|| button to still the image. Then press the ▶▶ button to play in slow motion at variable speeds.

- Each press increases the slow motion speed playback to 1/8, 1/4 or 1/2 normal speed.
- Audio is muted during slow motion playback.



Note

- Slow motion operates only in the forward direction. Slow motion is not available for CD.

■ Stop/Resume

- Press the ■ button once to stop playback. To resume the DVD/CD from the point where the disc stopped, press the ►|| button.
- Press the ■ button twice to completely stop playback. The next time you press the ►|| button, the disc will start over from the beginning.

Using the Display Function



To view the current Title, Chapter/Track, and counter position, press the **INFO.** button during DVD/VCD/CD playback. The Display screen can also be used to quickly choose a title, chapter/track, or playing time.

1 View the Display

During DVD/VCD/CD playback, press the **INFO.** button.

- To make the screen disappear, press the **INFO.** button again.

DVD

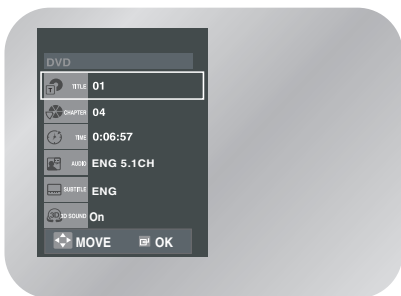

VCD

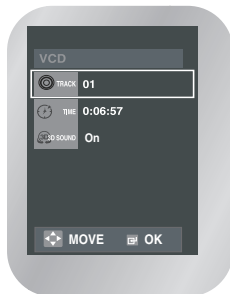

CD



To access the desired title when there is more than one in the disc. For example, if there is more than one movie on a DVD, each movie will be identified.

A DVD may contain several different titles. For example, if a disc contains four different movies, each might be considered a title.



Most of DVD discs are recorded in chapters so that you can quickly find a specific passage.

Each Title on a DVD is usually divided into chapters (similar to tracks on an audio CD).



Allows playback of the film from a desired time.



Refers to the language of the film soundtrack. In the example, the soundtrack is played in English 5.1CH. A DVD disc can have up to eight different soundtracks.



Refers to the subtitle languages available in the disc.

You will be able to choose the subtitles language or, if you prefer, turn them off from the screen.

A DVD disc can have up to 32 different subtitles.



A surround sound effect is generated using only two front speakers.



Note

- When in VCD 2.0 MODE (MENU ON), this function does not work. Use the DISC MENU button in the VCD 2.0 mode to select MENU ON or OFF.

2 Use the ▲ or ▼ button to select the desired item.

3 Use the ◀ or ▶ button to make the desired setup.
• You may use the number buttons of the remote control to directly access a title, chapter or to start the playback from the desired time.

4 To make the screen disappear, press the **INFO.** button again.

Adjusting the Aspect Ratio (EZ View)



This function may behave differently depending on the type of disc.

■ To play back using aspect ratio (DVD)

- 1 Press the **EZ VIEW** button.
 - The screen size changes when the button is pressed repeatedly.
 - The screen zoom mode operates differently depending on the screen setting in the initial DVD menu.
 - To ensure correct operation of the **EZ VIEW** button, you should set the correct aspect ratio in the initial setup.
-

■ If you are using a 16:9 TV

For 16:9 aspect ratio discs

- **Wide Screen**
Displays the content of the DVD title in 16:9 aspect ratio.
- **Screen Fit**
The top and bottom portions of the screen are cut off. When playing a 2.35:1 aspect ratio disc, the black bars at the top and bottom of the screen will disappear. The picture will look vertically stretched. (Depending on a type of disc, the black bars may not disappear completely.)
- **Zoom Fit**
The top, bottom, left and right of the screen are cut off and the central portion of the screen is enlarged.

For 4:3 aspect ratio discs

- **Normal Screen**
Displays the content of the DVD title in 16:9 aspect ratio. The picture will look horizontally stretched.
 - **Screen Fit**
The top and bottom portions of the screen are cut off and the full screen appears. The picture will look vertically stretched.
 - **Zoom Fit**
The top, bottom, left and right portions of the screen are cut off and the central portion of the screen is enlarged.
-

■ If you are using a 4:3 TV

For 16:9 aspect ratio discs

- **4:3 Letter Box**
Displays the content of the DVD title in 16:9 aspect ratio. The black bars will appear at the top and bottom of the screen.
- **4:3 Pan Scan**
The left and right portions of the screen are cut off and the central portion of the 16:9 screen is displayed.
- **Screen Fit**
The top and bottom portions of the screen are cut off and a full screen appears. The picture will look vertically stretched.
- **Zoom Fit**
The top, bottom, left and right portions of the screen are cut off and the central portion of the screen is enlarged.

For 4:3 aspect ratio discs

- **Normal Screen**
Displays the content of the DVD title in 4:3 aspect ratio.
 - **Screen Fit**
The top and bottom portions of the screen are cut off and the full screen appears. The picture will look vertically stretched.
 - **Zoom Fit**
The top, bottom, left and right portions of the screen are cut off and the central portion of the screen is enlarged.
-

Selecting the Subtitle Language

Some DVDs provide subtitles in one or more languages. You can use the **SUBTITLE** button to quickly view and change settings.

- 1 During playback, press the **SUBTITLE** button.



- 2 Press the ◀ or ▶ button to select the desired subtitle language
• The default is **Off**.

- 3 Press the ▲ or ▼ button to select **On**.



- To make the menu bar disappear, press the **SUBTITLE** button again.



Note

- The subtitle languages are represented by abbreviations.
- This function depends on what languages are encoded on the disc and may not work with all DVDs.
- A DVD disc can contain up to 32 subtitle languages.
- How to have the same subtitle language come up whenever you play a DVD; Refer to “Setting Up the Language Features” on page 44.

Selecting the Audio Language

Multiple language/audio setup options, such as Dolby Digital 5.1, Dolby Pro Logic or LPCM 2 Channel audio are available on some DVDs. You can use the **AUDIO** button to quickly view and select the options available on a disc.

- 1 During playback, press the **AUDIO** button.

DVD



VCD, CD



- Press the ◀ or ▶ button to select stereo Left or Right.

- 2 Press the ◀ or ▶ button to select the desired language or audio setup on the DVD.
• Languages are represented by abbreviations, e.g. **ENG** for English.



Note

- This function depends on what languages are encoded on the disc and may not work with all DVDs.
- A DVD disc can contain up to 8 audio languages.
- How to have the same audio language come up whenever you play a DVD ; Refer to “Setting Up the Language Features” on page 44.

Changing the Camera Angle

Some DVD Movies provide you with various camera angle views on the same scene while they are showing. To activate the feature press the **ANGLE** button.

1 You'll see the angle icon while watching a DVD with multi angles available.

2 When the angle icon comes up to the screen press the **ANGLE** button to see the angle menu.



3 Press the **◀** or **▶** button to select a camera angle you may wish to see.

Zoom

1 During playback, press the **MENU** button. Press the **▲** or **▼** button to select **FUNC**, then press the **OK** or **▶** button. The **Function** menu is displayed.

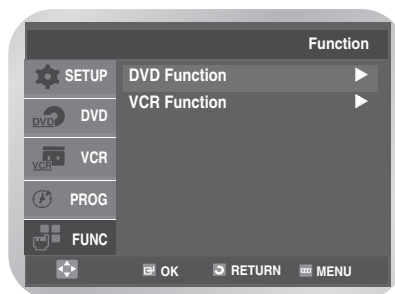

2 Press the **▲** or **▼** button to select **DVD Function**, then press the **OK** or **▶** button.

3 Press the **▲** or **▼** button to select **ZOOM**, then press the **OK** or **▶** button.

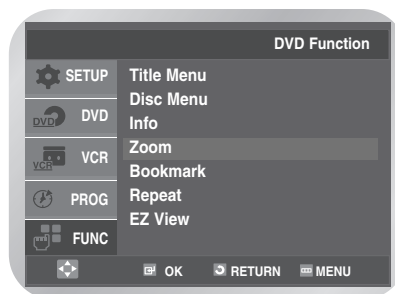

4 Press the **▲/▼** or **◀/▶** button to select the part of the screen you want to zoom in on, then press the **OK** button.

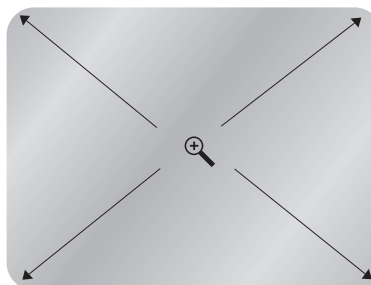

• Press the **OK** button to zoom in **2X/4X/2X/Normal** in order.



■ Depending on a disc, the Zoom function may not work.

Marks

Up to three Bookmarks can be inserted for a given DVD/VCD, allowing you to quickly jump to your favorite scene or song.

- 1 During playback, press the **MARK** button.



- 2 Press the ◀ or ▶ button to select one of the three mark placeholders (- - -). Keep on playing the DVD up to the scene you want to mark, then press the **OK** button. The placeholder (-) is changed to a number (1, 2 or 3).



- You may continue to set up to three marks. Press the **MARK** button when complete.

■ Recalling a Maked Scene

- 1 During playback, press the **MARK** button.
- 2 Press the ◀ or ▶ button to select the mark you want to delete.
- 3 Press the ▶II button to play the mark.

■ Clearing Mark

- 1 During playback, press the **MARK** button.
- 2 Press the ◀ or ▶ button to select the mark you want to delete.
- 3 Press the **CLEAR** button to play the mark.
 - Press the **MARK** button again to exit the mark menu.



Note

- Up to three scenes may be marked at a time.
- When in VCD 2.0 mode (MENU ON mode), this function does not work.
- Use the DISC MENU button in the VCD 2.0 mode to select MENU ON or OFF.
- Depending on the disc, the mark function may not work.

Repeat Chapter/Title

You can repeat a single chapter or a complete title.

- 1 Press the **REPEAT** button while in playback mode to open the repeat menu. The current repeat mode is displayed.

- 2 Press the ◀ or ▶ button to select **Chapter/Title**. Press the **OK** button to repeat the current chapter/Title.

DVD

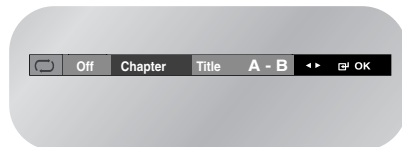

VCD, CD

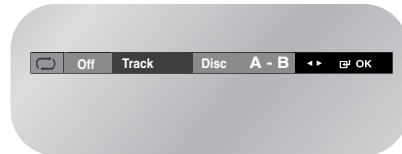

- The menu will display **Track** in place of **Chapter** if you are playing a VCD/CD.

■ Cancel Chapper/Title

- 1 Press the **REPEAT** button to open the repeat menu.
- 2 Press the ◀ or ▶ button to selected **Off**, then press the **OK** button.

DVD

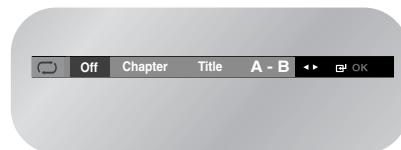

VCD, CD

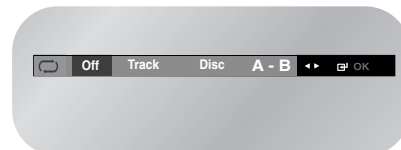

- It is available to press the **CLEAR** button in order to stop repeat play.

A to B Repeat



A to B Repeat feature enables you to repeat the designated section on a DVD or VCD/CD. To activate, mark where to start (A) and where to end (B) of the section you want to watch.

- 1 Press the **REPEAT** button while in playback mode, then press the ◀ or ▶ button to select **A-**.

DVD

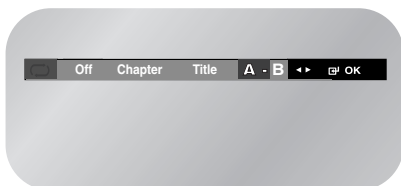

VCD, CD

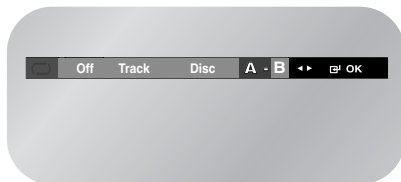

- 2 Press the **OK** button at the beginning of the segment you want to repeat (Point A). The **B** is selected.

DVD

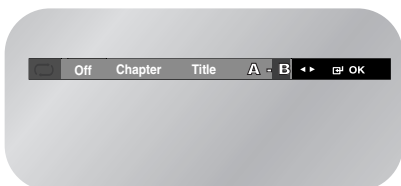

VCD, CD

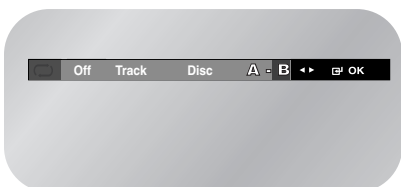

- The minimum A-B Repeat time is 5 seconds.

- 3 Press the **OK** button again at the end of the segment you want to repeat (Point B). The segment will begin repeating in a continuous loop.

Cancel A-B Repeat

- 1 Press the **REPEAT** button to open the repeat menu.

- 2 Press the ◀ or ▶ button to selected **Off**, then press the **OK** button.

DVD

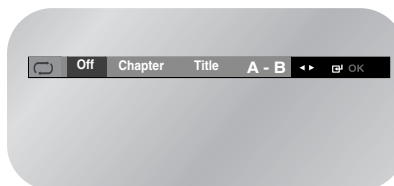

VCD, CD

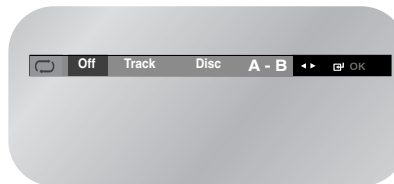

- It is available to press the **CLEAR** button in order to stop repeat play.



Note

- When in VCD 2.0 mode (MENU ON mode), this function does not work.
- Use the DISC MENU button in the VCD 2.0 mode to select MENU ON or OFF.

MP3/WMA Play



If you insert an MP3/WMA Disc into the DVD-VCR, you can see the folder directory.

MP3/WMA Play Function

- 1 Press the ▲ or ▼ button to select the desired music folder, then press the OK button.

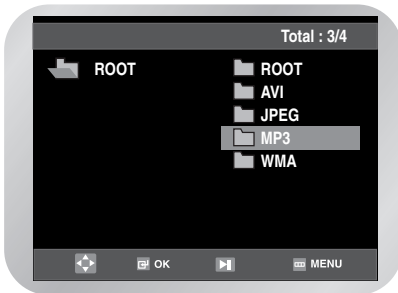

- Up to 8 music folders can be displayed at a time. If you have more than 8 folders on a disc, press the ▼ button to display them.

- 2 Press the ▲ or ▼ button again to select a music file. Press the OK button to begin playback of a music file.

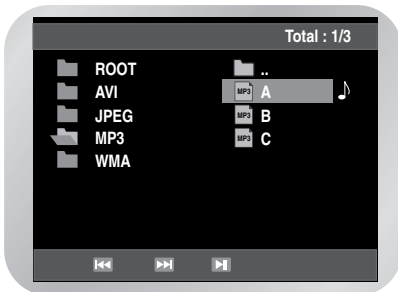

Repeat

- 1 Press the REPEAT button in play mode to hear only music continuously and press it once again to release.

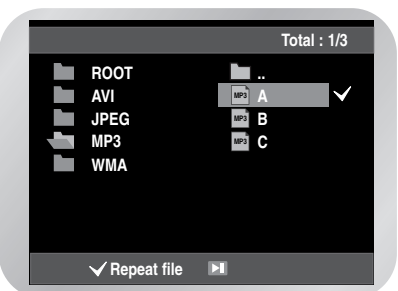

CD-R MP3/WMA discs

When playing CD-R/MP3 or WMA discs, please follow all the recommendations for CD-R above, plus the comments below:

Your MP3 or WMA files should be ISO 9660 or JOLIET format.

ISO 9660 format and Joliet MP3 or WMA files are compatible with Microsoft's DOS and Windows, and with Apple's Mac. These two formats are the most widely used.

When naming your MP3 or WMA files do not exceed 8 characters, and place ".mp3, .wma" as the file extension.

General name format of: Title.mp3. or Title.wma. When composing your title, make sure that you use 8 characters or less, have no spaces in the name, and avoid the use of special characters including: (,./,\,=,+).

Use a decompression transfer rate of at least 128Kbps when recording MP3 files.

Sound quality with MP3 files basically depends on the rate of compression/decompression you choose. Getting audio CD quality sound requires an analog/digital sampling rate, that is conversion to MP3 format, of at least 128Kbps and up to 160Kbps. However, choosing higher rates, like 192Kbps or more, only rarely give better sound quality. Conversely, files with decompression rates below 128Kbps will not be played properly.

Use a decompression transfer rate of at least 64Kbps when recording WMA files.

Sound quality with WMA files basically depends on the rate of compression/decompression you choose. Getting audio CD quality sound requires an analog/digital sampling rate, that is conversion to WMA format, of at least 64Kbps and up to 192Kbps. Conversely, files with decompression rates below 64Kbps or over 192Kbps will not be played properly.

Do not try recording copyright protected MP3 files.

Certain "securized" files are encrypted and code protected to prevent illegal copying. These files are of the following types: Windows Media™ (registered trade mark of Microsoft Inc) and SDMITM (registered trade mark of The SDMI Foundation). You cannot copy such files.

Important :

The above recommendations cannot be taken as a guarantee that the DVD-VCR will play MP3 recordings, or as an assurance of sound quality. You should note that certain technologies and methods for MP3 file recording on CD-Rs prevent optimal playback of these files on your DVD player (degraded sound quality and in some cases, inability of the player to read the files).

Program & Random Play (CD/MP3/WMA)

You can listen to songs randomly or in the desired sequence.

Program Play

- 1 Press the **MODE** button in the stop mode. Press the **◀** or **▶** button to select **PROGRAM**. Press the **OK** button.



- 2 Press the **▲/▼, ◀/▶** buttons to select the first track to add to the program. Press the **OK** button. The selection numbers are displayed in the **Program Order** box.

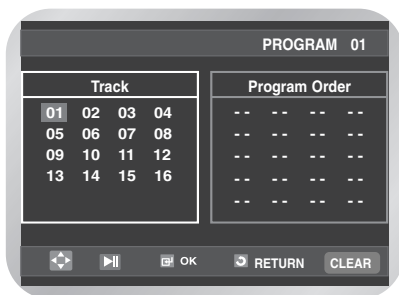

- 3 Press the **▶||** button. The disc will be played in programmed order.

Cancel Program play

During playback, press the **CLEAR** button.

Random Play

- 1 Press the **MODE** button in the stop mode.
- 2 Press the **◀** or **▶** button to select **RANDOM**. Press the **OK** button. The disc will be played in random order.

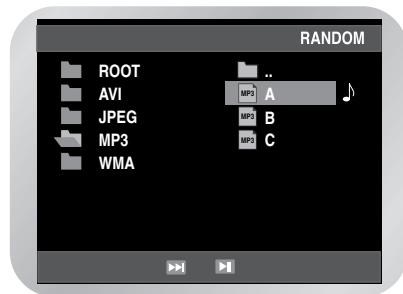

- Depending on the disc, the Program and Random Play functions may not work.
- To resume normal play, press the **CLEAR** button.

Picture CD Playback

If you insert a Picture (JPEG) CD Disc into the DVD-VCR, you can see the folder directory.

- 1 Press the ▲ or ▼ button to select the picture you want to view, then press the **OK** button. The selected picture is displayed.

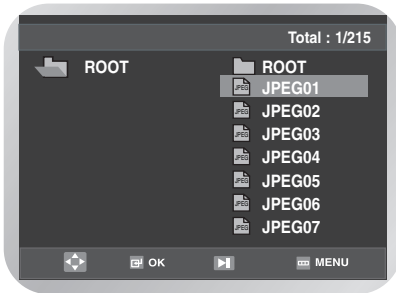

- 2 Press the I◀◀ or ▶▶I button to display the previous or next picture.

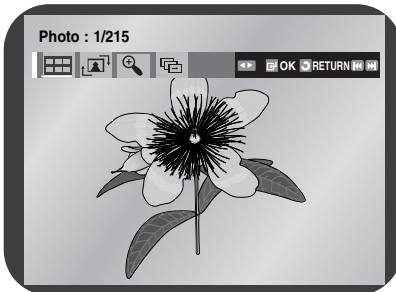

Note

- If no buttons on the remote control are pressed for 10 seconds, the menu bar will disappear. Press the **DISC MENU** button on the remote control to display the menu bar.

Album Mode

Press the ◀ or ▶ button to select .
Press the **OK** button.
The album mode is displayed.

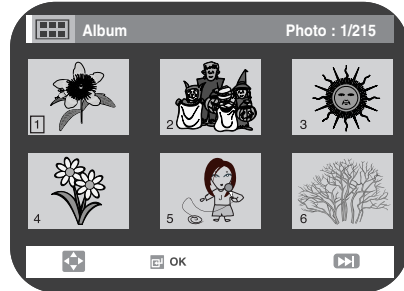

- Press the ▲▼,◀▶ buttons to select the required picture, then press the **OK** button. The selected picture is displayed.
- Press the I◀◀ or ▶▶I button to display the previous or next 6 pictures.

Rotation

Press the ◀ or ▶ button to select .
Each time the **OK** button is pressed, the picture rotates 90 degrees clockwise.

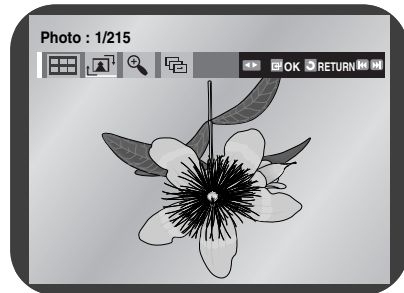

Zoom

Press the ◀ or ▶ button to select .
Each time the **OK** button is pressed, the picture is enlarged up to 4X.
(Normal → 2X → 4X → Normal)

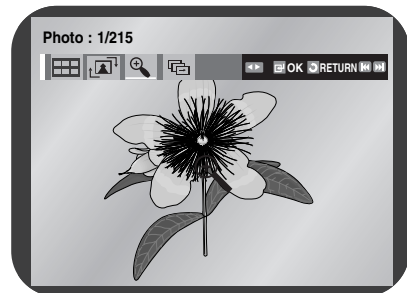

Slide show

Press the ◀ or ▶ button to select .
Press the **OK** button.
The 3 icons are displayed for time interval.

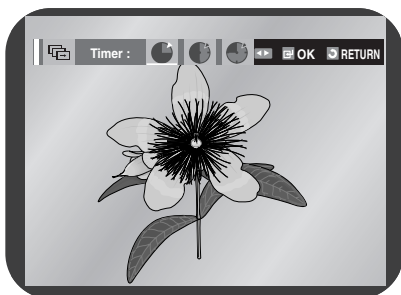
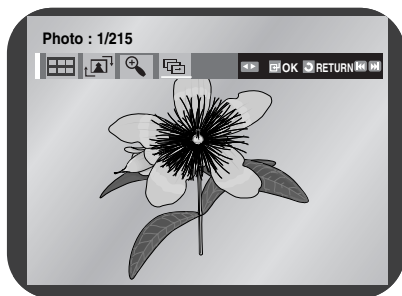

Press the ◀ or ▶ button to select one of these.
Press the **OK** button.



- The pictures change automatically with about an 6 second interval.
- The pictures change automatically with about an 12 second interval.
- The pictures change automatically with about an 18 second interval.



• Depending on the file size, each interval between images may take longer or shorter than the manual suggests.

CD-R JPEG Discs

- Only files with the “.jpg” and “.JPG” extensions can be played.
- If the disc is not closed, it will take longer to start playing and not all of the recorded files may be played.
- Only CD-R discs with JPEG files in ISO 9660 or Joliet format can be played.
- The name of the JPEG file may not be longer than 8 characters and should contain no blank spaces or special characters (. / = +).
- Only a consecutively written multisession disc can be played. If there is a blank segment in the multisession disc, the disc can be played only up to the blank segment.
- When playing a Kodak Picture CD, only the JPEG files in the pictures folder can be played.
- Picture discs other than Kodak Picture CD may take longer to start playing or may not play at all.

DivX/MPEG4 Playback (DVD-V6400/DVD-V6500)



1 When the disc is inserted, the file structure of the disc will be shown. Depending on the file format, a different icon will appear next to each file. The  and  files will have been highlighted.

Use  or  button to select the movie file, and then press OK or .

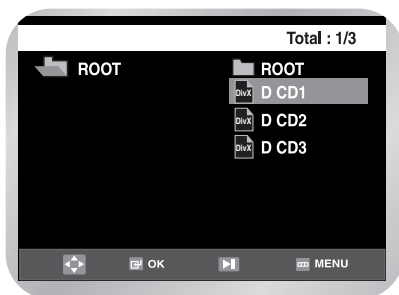
Result : When the 'Reading Index.....' message is displayed, wait for a second or two. The movie will be played back.



If the "Cannot support" message is displayed, the selected file cannot be played back.

1 To navigate to a specific time while viewing the movie, press the **INFO** button. The file format of the current file ( or ) and time information will be displayed.

2 Use the number buttons on the remote control to enter the time to jump to that time in the movie.





DivX/MPEG4 Special Playback Features (DVD-V6400/DVD-V6500)

During DivX/MPEG4 playback you can select from the following special playback options.

To resume normal playback, press the .

1 Still

Press the  button on the remote control during playback.

- The picture will still and the audio will mute.
- To resume playback, press the .
- If the player is left in Still mode for 5 minutes, it will stop automatically.

2 Frame Advance (Step)



While in playback mode, press the **F.ADV/STEP** button on the remote control to advance one frame at a time.

- Audio is muted during Frame Advance mode.
- Press  to resume normal playback.





- Frame Advance operates only in the forward direction.

3 Slow Motion

During playback, press the  button to Still the image. Then use the Search  to play in slow motion at variable speeds.

- Each press increases the slow motion speed playback to 1/8, 1/4 or 1/2 normal speed.
- Audio is muted during slow motion playback.
- The Search function may not operate depending on the condition of the disc.

4 Stop/Resume

- Press the  button once to stop playback. To resume the DivX/MPEG4 from the point where the disc stopped, press the .

5 Zoom

During play, press the MENU button on the remote control. Then press the ▲ or ▼ button to select the **FUNC**, then press the **OK** or ► button.

The **Function** menu is displayed.

Press the ▲ or ▼ button to select **DVD Function**.

Press the **OK** or ► button.

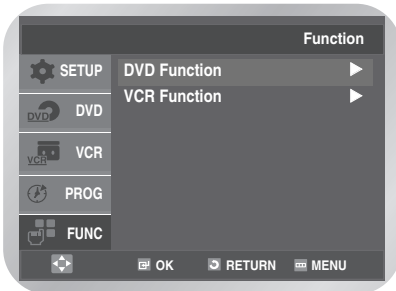

Press the ▲ or ▼ button to select **ZOOM**, then press the **OK** button.

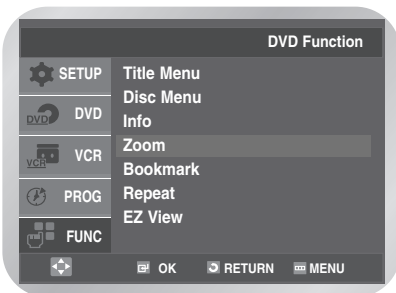

Auto Scaling : CIF(100kbps)~D1(784kbps) resolution. If the file resolution is small, it scales up to 2 times automatically. So you can see the more larger screen.



Reference

- *Technical Specifications* 65
- *Troubleshooting Guide (VCR)* 66
- *Troubleshooting Guide (DVD)* 67

Technical Specifications

Troubleshooting Guide (VCR)

Troubleshooting Guide (DVD)

Technical Specifications



General	Rated voltage	AC 220 - 240V, 50Hz
	Power consumption	19Watts
	Weight	3.9 Kg
	Size	430mm X 282mm X 82mm
	Operating ambient temperature	+5°C ~ +40°C
	Installation conditions	Operation position : Horizontal, Relative humidity : Below 75%
Input	Video input (Rear)	Euro Scart socket : 1.0Vp-p (unbalanced) 75Ω
	Audio input (Rear)	Euro Scart socket : -8dBm, 47Kohm unbalanced
	Input (Front)	RCA jack (DVD-V5500/DVD-V6500)
Output	RF out	UHF 21-69
	Audio (DVD, VCR)	RCA jack, Euro Scart socket
	Audio (DVD only)	COAXIAL, RCA jack
	Video (DVD, VCR)	RCA jack, Euro Scart socket
	Video (DVD only)	S-Video out, Component RGB out : Euro Scart socket
VCR	Tape format	VHS type video tape
	Colour system	PAL, MESECAM, NTSC4.43, NTSC playback on PAL TV
	Tuning system	B/G, D/K
	Video S/N	Above 43dB (standard recording)
	Resolution	Above 240 lines (standard recording)
	Audio S/N	Above 68dB (Hi-Fi), 39dB (Mono)
	Audio frequency characteristics	20Hz - 20KHz (Hi-Fi)
DVD	Disc	DVD, VCD, CD
	Audio S/N	100dB
	Audio dynamic range	95dB

Troubleshooting Guide (VCR)



Before contacting the Samsung after-sales service, perform the following simple checks.

If you are unable to solve the problem after reading the below instructions, note:

- The model and serial number on the rear of your DVD-VCR
- The warranty information
- A clear description of the problem

Then contact your nearest SAMSUNG after-sales service.

Problem	Solution
No power	<ul style="list-style-type: none">◆ Check that the power plug is connected to a wall outlet.◆ Have you pressed the STANDBY/ON button?
You cannot insert a video cassette	<ul style="list-style-type: none">◆ A video cassette can only be inserted with the window side up and the safety tab facing you.
The television programme was not recorded	<ul style="list-style-type: none">◆ Check the DVD-VCR aerial connections.◆ Is the DVD-VCR tuner properly set?◆ Check if the safety tab is intact on the cassette.
Timer recording was unsuccessful	<ul style="list-style-type: none">◆ Was the STANDBY/ON button pressed to activate the timer?◆ Re-check the recording start/stop time settings.◆ If there was a power failure or interruption during timer recording, the recording will have been cancelled.
No playback picture or the picture is distorted	<ul style="list-style-type: none">◆ Check to see if you are using a prerecorded tape.
You cannot see normal broadcasts	<ul style="list-style-type: none">◆ Check the tuner or external setting. It should be on tuner.◆ Check the TV or VCR aerial connections.
Noise bars or streaks on playback	<ul style="list-style-type: none">◆ Press the TRK (△ or ▽) buttons to minimize this effect.
When the ► button is pressed during playback, the still picture has severe "noise bars" streaks	<ul style="list-style-type: none">◆ A still picture may have "noise bars", depending on the condition of the tape. Press the TRK (△ or ▽) buttons during slow motion to minimize this effect.
Video Head Cleaning	<ul style="list-style-type: none">◆ If poor pictures appear on a variety of cassettes, the video heads may need cleaning. This is not a common problem and unless it appears, the heads should not be cleaned. When cleaning the video heads, read all instructions provided with the head cleaning cassette. Incorrect head cleaning can permanently damage the video heads.
If when tuning in your TV to the DVD-VCR TV does not find the Screen or the pattern when found suffers from interference, it may be due to the DVD-VCR output channel clashing with the normal TV transmissions in your area. To prevent this you will need to change the DVD-VCR output channel in the following way	<ol style="list-style-type: none">1. Remove the aerial input plug from the socket marked (aerial symbol) on the rear of the DVD-VCR.2. Carry out the instructions "Tuning Your Television for the DVD-VCR" (see page 17).3. Carry out the instructions "Setting the DVD-VCR output Channel" (see page 24), move the channel number several channels down from the original setting.(example: from 36 to 37).4. Replace the aerial plug into the socket marked (aerial symbol) on the rear of the DVD-VCR.5. Re-tune your TV to the DVD-VCR again by following instructions "Tuning Your Television for the DVD-VCR" (see page 17).6. If the problem still exists repeat steps 1 to 5 moving several more channels away from the original setting.

Troubleshooting Guide (DVD)



Problem	Solution	Page
Disc does not play.	<ul style="list-style-type: none"> ◆ Ensure that the disc is installed with the label side facing up. ◆ Check the region number of the DVD. ◆ This player cannot play CD-ROMs, DVD-ROMs, etc. Insert a DVD, or a CD. 	P3
5.1 channel sound is not being reproduced.	<ul style="list-style-type: none"> ◆ 5.1 channel sound is reproduced only when the following conditions are met. : <ol style="list-style-type: none"> 1) The DVD-VCR player is connected with the proper amplifier 2) The disc is recorded with 5.1 channel sound. ◆ Check whether the disc being played has the "5.1 ch" mark on the outside. ◆ Check if your audio system is connected and working properly. 	P14 P45
The  icon appears on screen.	<ul style="list-style-type: none"> ◆ The features or action cannot be completed at this time because: <ol style="list-style-type: none"> 1. The DVD's software restricts it. 2. The DVD's software doesn't support the feature (e.g., angles). 3. The feature is not available at the moment. 4. You've requested a title or chapter number or search time that is out of range. 	P43~61
Playback mode differs from the Setup menu selection.	<ul style="list-style-type: none"> ◆ Some of the functions selected in the Setup menu may not work properly if the disc is not encoded with the corresponding function. 	P43~48
The screen ratio cannot be changed.	<ul style="list-style-type: none"> ◆ The screen ratio is fixed on your DVDs. 	P46
No audio.	<ul style="list-style-type: none"> ◆ Make sure you have selected the correct Digital Output in the Audio Options Menu. 	P45
Forgot password	<ul style="list-style-type: none"> ◆ Press STANDBY/ON with no disc in the unit. Press the ◀◀ and ▶▶ buttons simultaneously on the front panel for five seconds. Power off and on the DVD-VCR by pressing STANDBY/ON button. The parental mode is now unlocked as indicated on the display. You can now set your rating level and change your password to a new number. 	P47~48
If you experience other problems.	<ul style="list-style-type: none"> ◆ Go to the contents and find the section of the instruction book that contains the explanations regarding the current problem, and follow the procedure once again. ◆ If the problem still cannot be solved, please contact your nearest authorized service center. 	

THIS APPLIANCE IS DISTRIBUTED BY

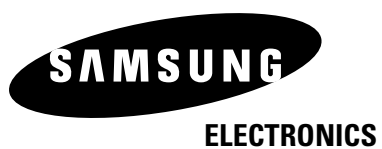

Free Manuals Download Website

<http://myh66.com>

<http://usermanuals.us>

<http://www.somanuals.com>

<http://www.4manuals.cc>

<http://www.manual-lib.com>

<http://www.404manual.com>

<http://www.luxmanual.com>

<http://aubethermostatmanual.com>

Golf course search by state

<http://golfingnear.com>

Email search by domain

<http://emailbydomain.com>

Auto manuals search

<http://auto.somanuals.com>

TV manuals search

<http://tv.somanuals.com>