



SAMSUNG

DVD-C500  
DVD-C550

# DVD Player

## User Manual

imagine the possibilities

Thank you for purchasing this Samsung product.

To receive more complete service, please register your product at

[www.samsung.com/global/register](http://www.samsung.com/global/register)



AK68-01848A(03)



# Getting Started

## Important Safety Instructions

- 1) Read these instructions.
- 2) Keep these instructions.
- 3) Heed all warnings.
- 4) Follow all instructions.
- 5) Do not use this apparatus near water.
- 6) Clean only with a dry cloth.
- 7) Do not block any ventilation openings. Install in accordance with the manufacturer's instructions.
- 8) Do not install near any heat sources such as radiators, heat registers, stoves, or other apparatus (including amplifiers) that produce heat.
- 9) Do not defeat the safety purpose of the polarized or grounding-type plug. A polarized plug has two blades with one wider than the other. A grounding type plug has two blades and a third grounding prong. The wide blade or the third prong are provided for your safety. If the provided plug does not fit into your outlet, consult an electrician for replacement of the obsolete outlet.
- 10) Protect the power cord from being walked on or pinched: particularly at plugs, convenience receptacles, and the point where they exit from the apparatus.
- 11) Only use attachments/accessories specified by the manufacturer.
- 12) Use only with cart, stand, tripod, bracket, or table specified by the manufacturer, or sold with the apparatus. When a cart is used, use caution when moving the cart/apparatus combination to avoid injury from tip-over.
- 13) Unplug this apparatus during lightning storms or when unused for long periods of time.
- 14) Refer all servicing to qualified service personnel. Servicing is required when the apparatus has been damaged in any way, such as the power-supply cord or plug is damaged, liquid has been spilled or objects have fallen into the apparatus, the apparatus has been exposed to rain or moisture, does not operate normally, or has been dropped.



## Precautions



This symbol indicates that dangerous voltage consisting a risk of electric shock is present within this unit.



This symbol indicates that there are important operating and maintenance instructions in the literature accompanying this unit.

Do not install this equipment in a confined space such as a bookcase or similar unit.

**WARNING :** TO REDUCE THE RISK OF FIRE OR ELECTRIC SHOCK, DO NOT EXPOSE THIS APPARATUS TO RAIN OR MOISTURE.

### Note to CATV system installer :

This reminder is provided to call CATV system installer's attention to Article 820-40 of the National Electrical Code (Section 54 of Canadian Electrical Code, Part I) that provides guidelines for proper grounding and, in particular, specifies that the cable ground shall be connected to the grounding system of the building as close to the point of cable entry as practical.

**Caution :** FCC regulations state that any unauthorized changes or modifications to this equipment may void the user's authority to operate it.

- Apparatus shall not be exposed to dripping or splashing and no objects filled with liquids, such as vases, shall be placed on the apparatus.
- If this power supply is used at 240V ac, a suitable plug adapter should be used.

### FCC NOTE (for U.S.A):

This equipment has been tested and found to comply with the limits for a Class B digital device, pursuant to Part 15 of the FCC rules. These limits are designed to provide reasonable protection against harmful interference in a residential installation. This equipment generates, uses and can radiate radio frequency energy and, if not installed and used in accordance with the instructions, may cause harmful interference to radio or television reception, which can be determined by turning the equipment off and on. The user is encouraged to try to correct the interference by one or more of the following measures.

- Reorient or relocate the receiving antenna.
  - Increase the separation between the equipment and receiver.
  - Connect this equipment into an outlet on a circuit different from that to which the receiver is connected.
  - Consult the dealer or an experienced radio/TV technician for help.
- This class B digital apparatus meets all requirements of the Canadian Interference Causing Equipment Regulations.

### FDA Laser :

"Complies with 21CFR 1040.10 except for deviations pursuant to Laser Notice No. 50, dated June 24, 2007."

### CALIFORNIA USA ONLY :

This Perchlorate warning applies only to primary CR (Manganese Dioxide) Lithium coin cells in the product sold or distributed ONLY in California USA "Perchlorate Material - special handling may apply", See [www.dtsc.ca.gov/hazardouswaste/perchlorate](http://www.dtsc.ca.gov/hazardouswaste/perchlorate).

### CAUTION

THIS PRODUCT UTILIZES A LASER. USE OF CONTROLS OR ADJUSTMENTS OR PERFORMANCE OF PROCEDURES OTHER THAN THOSE SPECIFIED HEREIN MAY RESULT IN HAZARDOUS RADIATION EXPOSURE. DO NOT OPEN COVER AND DO NOT REPAIR YOURSELF. REFER SERVICING TO QUALIFIED PERSONNEL.

CLASS 1	LASER PRODUCT
KLASSE 1	LASER PRODUKT
LUOKAN 1	LASER LAITE
KLASS 1	LASER APPARAT
PRODUCTO	LASER CLASE 1

### Notes:

- This unit can be used only where the power supply is AC 120V, 60Hz. It cannot be used elsewhere.
- This DVD player is designed and manufactured to respond to the Region Management Information. If the Region number of a DVD disc does not correspond to the Region number of this DVD player, the DVD player cannot play the disc.

### Handling Cautions

- Before connecting other components to this player, be sure to turn them all off.
- Do not move the player while a disc is being played, or the disc may be scratched or broken, and the player's internal parts may be damaged.
- Do not put a flower vase filled with water or any small metal objects on the player.
- Be careful not to put your hand into the disc tray.
- Do not place anything other than the disc in the disc tray.
- Exterior interference such as lightning and static electricity can affect normal operation of this player. If this occurs, turn the player off and on again with the POWER button, or disconnect and then reconnect the AC power cord to the AC power outlet. The player will operate normally.
- Be sure to remove the disc and turn off the player after use.
- Disconnect the AC power cord from the AC outlet when you don't intend to use the player for long periods of time.
- Clean the disc by wiping in a straight line from the inside to the outside of the disc.
- The Main plug is used as a disconnect device and shall stay readily operable at any time.

## Disc Storage

Use care when storing discs. The data on the discs is highly vulnerable to mishandling.

- Do not expose to direct sunlight.
- Keep in a cool, ventilated area.
- Store vertically.
- Keep in a clean protection jacket.

## Maintenance of Cabinet

For safety reasons, be sure to disconnect the AC power cord from the AC outlet.

- Do not use benzene, thinner, or other solvents for cleaning.
- Wipe the cabinet with a soft cloth.

## Accessories

- Remote Control (AK59-00084V/AK59-00110A)
- Batteries for Remote Control (AAA Size) (AC43-12002H)
- User's Manual (AK68-01848A)
- Video/Audio Cable (AC39-42001U & AC39-22017Z)

## Contents

### GETTING STARTED

Precautions .....	2
General Features .....	3
Description .....	4
Tour of the Remote Control .....	4

### CONNECTIONS

Choosing a Connection .....	5
Connecting to a TV Using the HDMI Jack .....	5
Connecting to a TV with a DVI Jack .....	5
Connecting to a TV Using the Component Jacks (Progressive/Interlace) .....	5
Connecting to a TV Using the Video Jack (Video) ...	5
Connecting to an Audio System (2 Channel, Dolby Digital, MPEG2, or DTS Amplifier) .....	5

### BASIC FUNCTIONS

Playing a Disc .....	6
Using the Search and Skip Functions .....	6
Using the Display Function .....	6
Using the Disc and Title Menu .....	7
Repeat Play .....	7
Slow Play .....	7

### ADVANCED FUNCTIONS

Adjusting the Aspect Ratio (EZ View) .....	7
Selecting the Audio Language .....	7
Selecting the Subtitle Language .....	7
Changing the Camera Angle .....	8

## General Features

### Excellent Sound

Dolby Digital, a technology developed by Dolby Laboratories, provides crystal clear sound reproduction.

### Screen

You can view video in both regular (4:3) and wide-screen (16:9).

### Slow Motion

You can watch scenes in slow motion.

Using the Bookmark Function .....	8
Using the Zoom Function .....	8
Clips Menu for MP3/WMA/JPEG/MPEG4/CD Audio .....	8
Folder Selection .....	8
MP3/WMA/CD Audio Playback .....	8
MPEG4 Playback (DVD-C550 Only) .....	9
Playing Media Files using the USB HOST feature (DVD-C550 Only) .....	9
CD Ripping (DVD-C550 Only) .....	10
Picture CD Playback .....	10
Picture CD Playback for HD-JPEG .....	10

### NAVIGATING THE SETUP MENU

Using the Setup Menu .....	11
Setting Up the Display Options .....	11
Setting Up the Audio Options .....	12
Setting Up the System Options .....	12
Setting Up the Language Features .....	13
Setting Up the Security Options .....	13
Setting Up the General Options .....	13
Setting Up the Support Options .....	13

### REFERENCE

Firmware upgrade .....	14
Troubleshooting .....	14
Specifications .....	15

### 1080p Playback

This player upconverts regular DVDs for playback on 1080p TVs.

### Parental Control (DVD)

The parental control allows you to set the level necessary to prevent children from viewing harmful movies such as those with violence, adult subject matter, etc.

## Various On-Screen Menu Functions

You can select various languages (Audio/Subtitle) and screen angles while enjoying movies.

### Progressive Scan

Progressive scan provides an improved picture with double the scan lines of a conventional interlaced picture.

### EZ VIEW (DVD)

Easy View enables picture adjustment to match your TV's screen size (16:9 or 4:3).

### Digital Photo Viewer (JPEG)

You can view Digital Photos on your TV.

### Repeat

You can repeat a song or movie simply by pressing the REPEAT button.

### MP3/WMA

This unit can play discs created from MP3/WMA files.

### MPEG4 (DVD-C550 Only)

This unit can play MPEG4 formats within an avi file.

### HDMI (High Definition Multimedia Interface)

HDMI reduces picture noise by allowing a pure digital video/audio signal path from the player to your TV.

### CD Ripping (DVD-C550 Only)

This feature lets you copy audio files from a disc into MP3 format on a USB device. (Audio CD only (CD DA)).

### Note

- These disc formats cannot be played on this player.
  - DVD-ROM
  - DVD-ROM
  - CD-ROM
  - CDI
  - CDGs (Plays audio only, not graphics. The ability to play back may depend on recording conditions.)
  - DVD-R, +R
  - CD-RW
  - DVD+RW, -RW (V mode)
- The unit may not play certain CD-R, CD-RW and DVD-R due to the disc type or recording conditions.

## COPY PROTECTION

Many DVD discs are encoded with copy protection. Because of this, you should only connect your DVD player directly to your TV, not to a VCR. Connecting to a VCR results in a distorted picture from copy-protected DVD discs.







This product incorporates copyright protection technology that is protected by methods claims of certain U.S. patents and other intellectual property rights owned by

Rovi Corporation and other rights owners. Use of this copyright protection technology must be authorized by Rovi Corporation, and is intended for home and other limited viewing uses only unless otherwise authorized by Rovi Corporation. Reverse engineering or disassembly is prohibited.

## PROGRESSIVE SCAN OUTPUTS (480p, 720p, 1080p)

YOU SHOULD NOTE THAT NOT ALL HIGH DEFINITION TELEVISION SETS ARE FULLY COMPATIBLE WITH THIS PRODUCT AND MAY CAUSE ARTIFACTS TO BE DISPLAYED IN THE PICTURE. IF PROGRESSIVE SCAN PICTURE PROBLEMS OCCUR, WE RECOMMEND THAT YOU SWITCH THE CONNECTION TO THE 'STANDARD DEFINITION' (VIDEO) OUTPUT. IF THERE ARE QUESTIONS REGARDING YOUR TV SET'S COMPATIBILITY WITH THIS DVD PLAYER, PLEASE CONTACT SAMSUNG'S CUSTOMER SERVICE CENTER.

## Disc Markings

	Play Region Number
	NTSC broadcast system in U.S.A, Canada, Korea, Japan, etc.
	Dolby Digital disc
	Stereo disc
	Digital Audio disc
	DTS disc
	MP3 disc

## Region Number

Both the DVD player and your DVD discs are coded by region. These regional codes must match in order for the disc to play. If the codes do not match, the disc will not play.

The Region Number for this player is described on the rear panel of the player.

## DivX Certification (DVD-C550 Only)

DivX, DivX Certified,  and associated logos are trademarks of DivXNetworks, Inc and are used under license. "DivX Certified to play DivX video, including premium content."

## Description

### Front Panel Controls

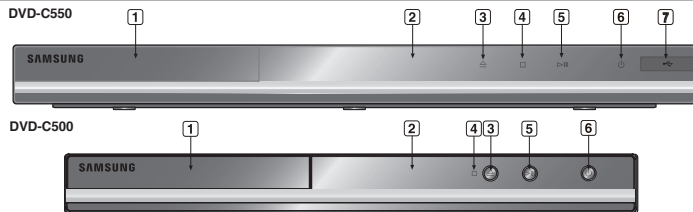

- 1. DISC TRAY**  
Place the disc here.
- 2. DISPLAY**  
Operation indicators are displayed here.
- 3. OPEN/CLOSE (▲)**  
Press to open and close the disc tray.
- 4. STOP (■)**  
Stops disc play.
- 5. PLAY/PAUSE (▶||)**  
Begin or pause disc play.
- 6. STANDBY/ON (⏻)**  
Turn On/Off the DVD Player.
- 7. USB HOST (DVD-C550 Only)**  
Connect a digital still camera, MP3 player, memory stick, Card reader or other removable storage devices.

### Rear Panel

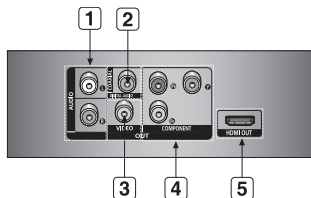

- 1. AUDIO OUT JACKS**  
- Use audio cables to connect to the Audio input jacks of your television or audio/video receiver
- 2. DIGITAL AUDIO JACK**  
- Use a coaxial digital cable to connect to a Dolby Digital receiver or A/V Amplifier that contains a Dolby Digital, MPEG2, or DTS decoder.
- 3. VIDEO OUT JACK**  
- Use a video cable to connect to the Video input jack on your television.
- 4. COMPONENT VIDEO OUT JACKS**  
- Use these jacks if you have a TV with Component Video in jacks. These jacks provide P<sub>R</sub>, P<sub>B</sub> and Y video.
- 5. HDMI OUT JACK**  
- If P-SCAN is set to "ON" in Video Output of the General Menu, progressive scan mode will work.  
- If I-SCAN is set to "ON" in Video Output of the General Menu, interlaced scan mode will work.

## Tour of the Remote Control

DVD-C550

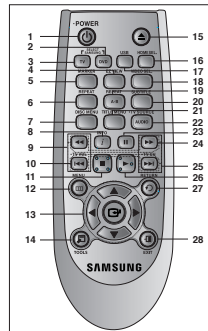

DVD-C500

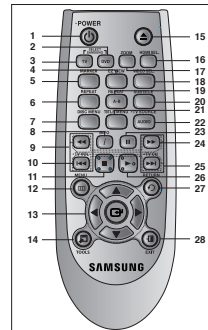

- 1. DVD POWER Button**  
Turns the power on or off.
- 2. DVD Button**  
Use to select the DVD player for operation.
- 3. TV Button**  
Use to put the remote in TV mode in order to operate a Samsung TV.
- 4. EZ VIEW Button**  
Lets you easily adjust the aspect ratio of a picture according to the screen size of your TV (16:9 or 4:3).
- 5. MARKER Button**
- 6. REPEAT Button**  
Allows you to repeat play a title, chapter, track, or disc.
- 7. DISC MENU Button**  
Brings up the Disc menu.

- 8. INFO Button**  
Used to displays playback info banner.
- 9. TV VOL (+, -) Buttons**  
Controls the volume on a Samsung TV.
- 10. SKIP Buttons (◀/▶)**  
Use to skip the title, chapter or track.
- 11. STOP Button (■)**
- 12. MENU Button**  
Brings up the DVD player's menu.
- 13. ENTER/▲/▼, ◀/▶ Buttons**  
This button functions as a toggle switch.
- 14. TOOLS Button**  
Displays the current disc mode. It also lets you access the Display function.
- 15. OPEN/CLOSE (▲) Button**  
To open and close the disc tray.
- 16. HDMI SEL. Button**  
HDMI Output resolution setup.
- 17. USB Button (DVD-C550 Only)/ ZOOM Button (DVD-C500 Only)**  
Enlarges the DVD Picture.
- 18. VIDEO SEL. Button**  
Changes video output mode.
- 19. REPEAT A-B Button**  
Allows you to repeat play a chosen section (A-B) on a disc.
- 20. SUBTITLE Button**
- 21. TITLE MENU Button**  
Brings up the Title menu.
- 22. AUDIO/TV SOURCE Button**  
Use this button to access various audio functions on a disc. Use this button to select an available source on a Samsung TV (TV mode).
- 23. PAUSE Button (||)**  
Pauses disc play.
- 24. SEARCH Buttons (◀◀/▶▶)**  
Allows you to search forward/backward through a disc.
- 25. TV CH (↖, ↗) Buttons**  
Use to select channels on a Samsung TV.
- 26. PLAY Button (▶)**  
Begins disc play.
- 27. RETURN Button**  
Returns to a previous menu.
- 28. EXIT Button**  
Exits the on-screen menu.

### Install Batteries in the Remote Control

- Open the battery cover on the back of the remote control.
- Insert two AAA batteries. Make sure that the polarities (+ and -) are aligned correctly.
- Replace the battery cover.

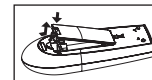

# Connections

## Choosing a Connection

The following explains how to make connections commonly used to connect the DVD player with a TV and other components. A diagram showing these connections is on the next page.

### Before Connecting the DVD Player

- Always turn off the DVD player, TV, and other components before you connect or disconnect any cables.
- Refer to the user's manual of the additional components (such as a TV) you are connecting for more information on those particular components.

### A. Connecting to a TV Using the HDMI Jack

HDMI provides the best picture quality of all the connections.

1. Using an HDMI-HDMI cable (not included), connect the **HDMI OUT** jack on the rear of the DVD player to the **HDMI IN** jack of your TV.
2. Press the input selector button on your TV remote control until the HDMI signal from the DVD player appears on your TV screen.

### Connecting to a TV with a DVI Jack

1. Using an HDMI-DVI cable (not included), connect the **HDMI OUT** jack on the rear of the DVD player to the **DVI IN** jack of your TV.
2. Using the audio cables, connect the **AUDIO (red and white) OUT** jacks on the rear of the DVD player to the **AUDIO (red and white) IN** jacks of your TV. Turn on your DVD player and TV.
3. Press the input selector button on your TV remote control until the DVI signal from the DVD player appears on your TV screen.

### HDMI VIDEO Specifications

When you press the **HDMI SEL.** button, the 480p, 720p, 1080i and 1080p resolutions are selected in order.

The first press of the **HDMI SEL.** button brings up the current resolution.

The second press allows you to change the HDMI output resolution.

- Depending on your TV, certain HDMI output resolutions may not work. Please refer to your TV user's manual to determine the output resolutions of the player that will work on your TV.
- If an HDMI or HDMI-DVI cable is plugged into your TV, the DVD player's output is set to HDMI automatically about 10 seconds later.
- For better picture quality, set the HDMI output resolution to 720p, 1080i or 1080p.
- This player upconverts regular DVDs for playback on 1080p TVs. It does not play HD DVDs or Blu-Ray discs.
- If you connect an HDMI cable between a Samsung TV and this DVD player, you can operate this DVD player using your TV remote control if the Samsung TV supports Anynet+(HDMI-CEC).
- If your TV has an **Anynet+** logo, then it supports the Anynet+ function.

### HDMI (High Definition Multimedia Interface)

HDMI enables you to make a digital video and audio connection with a single cable. Using HDMI, the DVD player transmits a digital video and audio signal which displays a vivid picture on a TV having an HDMI input jack.

### HDMI connection description

- HDMI connector - Video and audio are transferred digitally without compression (LPCM or Bit Stream data).
- The player outputs a pure digital signal to the TV through an HDMI cable.
- If your TV does not support HDCP (High-bandwidth Digital Content Protection), snow noise appears on the screen.

### Why does Samsung use HDMI?

Analog TVs require an analog video/audio signal. However, when this player plays a DVD, it initially creates a digital signal. For an analog TV to use this signal, it must be converted to an analog signal, using either a digital-to-analog converter in the DVD player or an analog-to-digital converter in the TV. During this conversion, the picture quality is degraded due to noise and signal loss. HDMI technology is superior because it requires no conversion and is a pure digital signal from the player to your TV.

### What is HDCP?

HDCP (High-bandwidth Digital Content Protection) is a system for protecting DVD content outputted via HDMI/DVI from being copied. It provides a secure digital link between a video source (PC, DVD, etc) and a display device (TV, projector, etc). Content is encrypted at the source device to prevent unauthorized copies from being made.

### B. Connecting to a TV Using the Component Jacks (Progressive/ Interlace)

- Connecting through the Component jacks lets you view video at the 480p (Progressive Scan) resolution.
- What is "Progressive Scan"?  
Progressive scan has twice as many scanning lines per frame as interlaced (480i) output and provides better and clearer picture quality.

1. Using Component video cables (not included), connect the **COMPONENT VIDEO OUT** (PR, PB and Y) jacks on the rear of the DVD player to the **COMPONENT IN** (PR, PB and Y) jacks of your TV.
2. Using the audio cables, connect the **AUDIO (red and white) OUT** jacks on the rear of the DVD player to the **AUDIO (red and white) IN** jacks of your TV. Turn on the DVD player and TV.
3. Set the Video Output to **P-SCAN/ I-SCAN** in the Display Setup menu. You can also use the **VIDEO SEL.** button to change the Video Output mode.
4. Press the input selector button on your TV remote control until the Component signal from the DVD player appears on the TV screen.

### C. Connecting to a TV Using the Video Jack (Video)

1. Using Video/Audio cables, connect the **VIDEO (yellow)/AUDIO (red and white) OUT** jacks on the rear of the DVD player to the **VIDEO (yellow)/AUDIO (red and white) IN** jacks of your TV.
2. Turn on your DVD player and TV.
3. Press the input selector button on your TV remote control until the Video signal from the DVD player appears on the TV screen.

### Notes

- **Noise may be generated if the audio cable is placed too close to the power cable.**
- If you want to connect to an Amplifier, please refer to the Amplifier connection section below.
- The number and position of the jacks on your TV may vary depending on your TV set. Please refer to the user's manual of your TV.
- If there is one audio input terminal on the TV, connect it to the [AUDIO OUT] [left] (white) jack of the DVD player.
- If you press the VIDEO SEL. button when the DVD Player is in stop mode or no disc is inserted, the Video Output mode changes in the following sequence: I-SCAN → P-SCAN (Interlaced) → Progressive.

### D. Connecting to an Audio System (2 Channel, Dolby Digital, MPEG2, or DTS Amplifier)

1. Using the audio cables, connect the **AUDIO (red and white) OUT** jacks on the rear of the DVD player to the **AUDIO (red and white) IN** jacks of the Amplifier. If using a Coaxial cable, connect the **DIGITAL AUDIO (COAXIAL)** jack on the rear of the DVD player to the **DIGITAL AUDIO IN (COAXIAL)** jack of the Amplifier.
2. Using the video signal cable(s), connect the **HDMI, COMPONENT or VIDEO OUT** jacks on the rear of the DVD player to the **HDMI/DVI, COMPONENT or VIDEO IN** jack of your TV.
3. Turn on your DVD player, TV, and Amplifier.
4. Press the input select button of the Amplifier to select the audio input your DVD player is connected to in order to hear sound. Refer to your Amplifier's user manual to set the Amplifier's audio input.

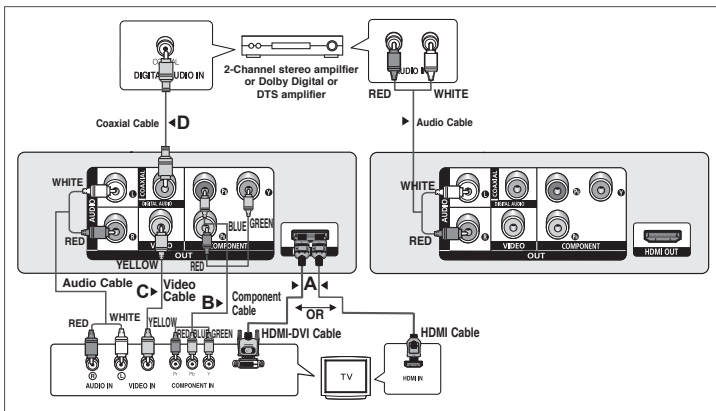

DVD	2X, 4X, 8X, 16X, 32X
CD	2X, 4X, 8X, 16X, 32X

**Notes**

- The speed marked in this function may be different from the actual playback speed.
- No sound is heard during search mode (Except CD).

### Skipping Tracks

During play, press the **SKIP** (◀◀ or ▶▶) button.

- When playing a DVD, if you press the **SKIP** (▶▶) button, it moves to the next chapter. If you press the **SKIP** (◀◀) button, it moves to the beginning of the chapter. Pressing the Skip button twice makes the DVD move to the beginning of the previous chapter.
- When playing a CD, if you press the **SKIP** (▶▶) button, it moves to the next track. If you press the **SKIP** (◀◀) button, it moves to the beginning of the track. Pressing the Skip button twice makes the CD move to the beginning of the previous track.

### Using the Display Function

#### When Playing a DVD/MPEG4

1. During play, press the **TOOLS** button on the remote control.
2. Press the ▲/▼ buttons to select the desired item.
3. Press the ◀/▶ buttons to make the desired setup.
4. To make the screen disappear, press the **TOOLS** button again.

The functions when using the Display function are listed in the table below.

	To access the desired title when there is more than one in the disc. For example, if there is more than one movie on a DVD, each movie will be identified.
	Most DVD discs are recorded in chapters so that you can quickly find a specific passage (similar to tracks on an audio CD).
	Allows playback of the film from a desired time. You must enter the starting time as a reference. The time search function does not operate on some discs.
	Refers to the film's soundtrack language. In the example, the soundtrack is played in English 5.1CH. A DVD disc can have up to eight different soundtracks.
	Refers to the subtitle languages available in the disc. You will be able to choose the subtitle languages or, if you prefer, turn them off from the screen. A DVD disc can have up to 32 different subtitles.
	User will be able to choose EZ-View type
	Press enter to activate the Zoom function.
	To access the desired Angle function. Some DVD disc are have more than one recorded angle.

## Basic functions

### Playing a Disc

#### Before Play

- Using your TV's remote control, turn on your TV and set it to the Video Input your DVD player is connected to.
- If you connected the DVD player to an external Audio System, turn on your Audio System and set it to the correct Audio Input.

After plugging in the player, the first time you press the DVD **POWER** button, the screen to the right appears: If you want to select a language, press the ▲/▼ button, and then press the **ENTER** button. (This screen will only appear when you plug in the player for the first time.) If the language for the startup screen is not set, the settings may change whenever you turn the power on or off. Therefore, make sure that you select the language you want to use.



Once you select a menu language, you can change it by pressing the **■/▶||** button on the front panel of the unit for more than 5 seconds with no disc in the unit. Then the **SELECT MENU LANGUAGE** window appears again where you can reset to your preferred language.

### Using the Search and Skip Functions

During play, you can search quickly through a chapter or track, and use the skip function to jump to the next selection.

#### Searching through a Chapter or Track

- During play, press the **SEARCH** (◀◀ or ▶▶) button on the remote control for more than 1 second
- If you want to search at a faster speed on the DVD or CD, press the **SEARCH** button.

## Using the Disc and Title Menu

During the playback of a DVD disc, press the **DISC MENU/TITLE MENU** button on the remote control.

### Notes

- Depending on a disc, the Disc Menu/Title Menu may not work.
- You can also select the Disc Menu, using the **DISC MENU** button on the remote control.
- Title Menu will only be displayed if there are at least two titles in the disc.

## Repeat Play

Repeat the current track, chapter, title, a chosen section (A-B), or all of the disc.

### When playing a DVD

1. Press the **REPEAT** button on the remote control. The repeat screen appears.
2. Press the **REPEAT** or **▲/▼** button to change the playback mode. A DVD repeats play by chapter, title.
  - Chapter : repeats the chapter that is playing.
  - Title : repeats the title that is playing.
  - Off

### Using the A-B Repeat function

1. Press the **REPEAT A-B** button on the remote control.
  2. Press the **REPEAT A-B** at the point where you want repeat play to start (A).
  3. Press the **REPEAT A-B** at the point where you want repeat play to start (B).
3. To return to normal play, press the **REPEAT A-B** button until the display shows Repeat : Off.

### Notes

- A-B REPEAT allows you to set point (B) directly after you have set point (A).
- Depending on the disc, the Repeat function may not work.

## Slow Play

This feature allows you to repeat scenes containing sports, dancing, musical instruments being played etc. in slow motion, so you can study them more closely.

### When playing a DVD

1. During play, press the **PAUSE (||)** button.
2. Press the **SEARCH (◀/▶)** button to choose the play speed between 1/2, 1/4, 1/8 and 1/16 of normal speed.

## Advanced functions

### Adjusting the Aspect Ratio (EZ View)

The Aspect ratio is the relation between the width and height of a picture. The two most common are 4:3 (Standard) and 16:9 (Widescreen). Follow the instructions below for the best aspect ratio setting for your TV.

### Changing the Aspect Ratio (DVD)

1. During play, press the **EZ VIEW** button on the remote control.
2. Press the **EZ VIEW** or **▲/▼** buttons to select the screen size. Each time you press the **▲/▼** button, the screen size changes. For graphics of the screen sizes and the sequence in which the sizes change, see the next column.
3. Press the **EXIT** button to exit EZ View.

- 4:3 Letter Box



- 4:3 Pan&Scan



- 16:9 Wide



### If you are using a 16:9 TV

#### For 16:9 aspect ratio discs

- WIDESCREEN
- SCREEN FIT
- ZOOM FIT

#### For 4:3 aspect ratio discs

- Normal Wide
- SCREEN FIT
- ZOOM FIT
- Vertical Fit

### Note

This function may behave differently depending on the type of disc.

### If you are using a 4:3 TV

#### For 16:9 aspect ratio discs

- 4:3 Letter Box
- 4:3 Pan&Scan
- SCREEN FIT
- ZOOM FIT

#### For 4:3 aspect ratio discs

- Normal Screen
- SCREEN FIT
- ZOOM FIT

## Selecting the Audio Language

You can select a desired audio language available on a disc quickly and easily with the **AUDIO** button.

### Using the AUDIO Button (DVD/MPEG4)

1. During play, press the **AUDIO** button. Change the audio language by pressing the **AUDIO** or **▲/▼** button.
  - The audio languages are represented by abbreviations.
2. To remove the **AUDIO** icon from the screen, press the **EXIT** button

### Notes

- MPEG4 is a compressed video format designed to deliver DVD quality video at lower data rates and smaller file sizes.  
Types of MPEG4 files are DivX or Xdiv. These files have an .avi extension.
- This function depends on audio languages that are encoded on the disc. This function may not work with all DVDs.
- A DVD disc can contain up to 8 audio languages.

## Selecting the Subtitle Language

You can select a desired language subtitles quickly and easily with the **SUBTITLE** button.

### Using the SUBTITLE Button (DVD/MPEG4)

1. During play, press the **SUBTITLE** button.
2. Press the **SUBTITLE** or **▲/▼** buttons to change the language. Each time you press the **SUBTITLE** or **▲/▼** buttons, the language changes.
3. Press the **EXIT** button to exit the Subtitle function.

### Notes

- The subtitle languages are represented by abbreviations.
- Depending on the DVD, you may have to select the desired subtitle in the DVD's Disc Menu. Press the **INFO** button.
- This function depends on what subtitles are encoded on the disc. This function may not work with all DVDs.
- A DVD disc can contain up to 32 subtitle languages.

## Changing the Camera Angle

When a DVD contains multiple angles of a particular scene, you can use the ANGLE function.

### Using the ANGLE function (DVD)

If the disc contains multiple angles, the ANGLE mark appears on the screen.

1. During play, press the **TOOLS** button on the remote control.
2. Press the **▲/▼** buttons to select . When the angle screen is displayed, press the **◀/▶** buttons on the remote control to select the desired angle option.

## Using the Bookmark Function

This feature lets you bookmark sections of a DVD, so you can quickly find them at a later time.

### Using the Bookmark Function (DVD)

1. During play, press the **MARKER** button on the remote control.
2. When you reach the scene you want to mark, Press the **◀/▶** or **▲/▼** buttons, and then press **MARKER** button. You can bookmark up to 12 scenes at a time.

#### Note

- Depending on the disc, the Bookmark function may not work.

### Recalling a Marked Scene

1. During play, press the **MARKER** button on the remote control.
2. Press the **◀/▶** or **▲/▼** buttons to select a marked scene.
3. Press the **PLAY (▶)** button to skip to the marked scene.

### Clearing a Bookmark

1. During play, press the **MARKER** button on the remote control.
2. Press the **◀/▶** or **▲/▼** buttons to select the bookmark number you want to delete.
3. Press the **ENTER** button to delete a bookmark number.

## Using the Zoom Function

### Using the Zoom Function (DVD)

1. During play, press the **TOOLS** or **ZOOM** button on the remote control.
2. Press the **▲/▼** buttons to select  icon, and then press the **ENTER** button to zoom in X1,X2,X3,X4.

## Clips Menu for MP3/WMA/JPEG/MPEG4 CD Audio

CD Audio or discs with MP3/WMA/JPEG/MPEG4 contain individual songs and/or pictures. These discs are organized into folders on this unit as shown to the right. The folder function much like the folders you use on your computer.

To go access these folders and the files in them, follow these steps :

1. Open the disc tray. Place the disc on the tray.
2. Close the tray. The tray closes and the Parent Folder Menu screen appears (top screen image.) Parent folders contain all the Peer folders that have the same kind of content: Videos, music, photos, etc.
3. Press the **◀/▶** buttons to select the Parent folder of your choice, and then press **ENTER**. A screen displaying the Peer folders appears. The Peer folders contain all the folders with the same kind of content (videos, music, photos, etc.) that are in the Parent folder.



## Folder Selection

You can select a folder both in Stop or Play mode.

- **To select the Parent Folder**  
Press the **RETURN** button to go to the parent folder, or press the **▲/▼** buttons to select “..” and then press **ENTER** to go to the parent folder.
- **To select the Peer Folder**  
Press the **▲/▼** buttons to select the desired folder, and then press **ENTER**.
- **To select the Sub-Folder**  
Press the **▲/▼** buttons to select the desired folder, and then press **ENTER**.

## MP3/WMA/CD Audio Playback

1. Open the disc tray. Place the disc on the tray. Close the tray.
2. Press the **◀/▶** buttons to select a Music folder, and then press **ENTER**. Press the **▲/▼** to select a song file, and then press **ENTER**. Press **▲/▼** to begin playback of the song file, and then press the **ENTER** button.

### Repeat/Random playback

1. Press the **REPEAT** button to change the playback mode. There are four modes; **Off**, **Track**, **Folder** and **Random**.
  - **Off (⇌)**: Normal Playback
  - **Track (□)**: Repeats the current song file.
  - **Folder (■)**: Repeats the song files which have the same extension in the current folder.
  - **Random (⇄)**: Plays the song files which have the same extension in random order.
2. To resume normal play, press the **REPEAT** button until the Repeat : Off.

### CD-R MP3/WMA file

When you record MP3 or WMA files on a CD-R for playback in this unit, please refer to the following.

- **Your MP3 or WMA files should be in ISO 9660 or JOLIET format.**  
ISO 9660 format and Joliet MP3 or WMA files are compatible with Microsoft's DOS and Windows, and with Apple's Mac. This format is the most widely used.
- **When naming your MP3 or WMA files, do not exceed 8 characters, and enter “.mp3, .wma” as the file extension.**  
General name format : Title.mp3. or Title.wma. When composing your title, make sure that you use 8 characters or less, have no spaces in the name, and avoid the use of special characters including: (,./\|=,+) .
- **Use a decompression transfer rate of at least 128 Kbps when recording MP3 files.**  
Sound quality with MP3 files depends on the rate of compression/decompression you choose. Getting CD audio sound requires an analog/digital sampling rate, that is conversion to MP3 format, of at least 128 Kbps and up to 160 Kbps. However, choosing higher rates, like 19 2Kbps or more, only rarely gives better sound quality. Files with decompression rates below 128 Kbps will not be played properly.
- **Use a decompression transfer rate of at least 64Kbps when recording WMA files.**  
Sound quality with WMA files depends on the rate of compression/decompression you choose. Getting CD audio sound requires an analog/digital sampling rate, that is conversion to WMA format, of at least 64Kbps and up to 192Kbps. Files with decompression rates below 64Kbps or over 192Kbps will not be played properly. The sampling rate that can be supported for WMA files is >30 Khz.
- **Do not try recording copyright protected MP3 files.**  
Windows Media™ files (a registered trade mark of Microsoft Inc) and SDMI™ files (a registered trade mark of The SDMI Foundation) are encrypted and code protected to prevent illegal copying. You cannot copy these files.



**- Important:**

The recommendations on the previous page cannot be taken as a guarantee that the DVD player will play MP3 recordings, or as an assurance of sound quality. You should note that certain technologies and methods for MP3 file recording on CD-Rs prevent optimal playback of these files on your DVD player (degraded sound quality and in some cases, inability of the player to read the files).

- This unit can play a maximum of 500 files and 500 folders per disc.

## MPEG4 Playback (DVD-C550 Only)

### MPEG4 Play Function

MPEG4 is a compressed video format designed to deliver DVD quality video at lower data rates and smaller file sizes. Types of MPEG4 files are DivX or Xvid. These files have an .avi extension. AVI files are used to contain the audio and video data. This unit can only play AVI format files with the ".avi" extension.

1. Open the disc tray. Place the disc on the tray. Close the tray.
2. Press the **◀▶** buttons to select a Videos Menu, and then press the **ENTER** button. Press the **▲▼** to select an avi file (DivX/XviD), and then press the **ENTER**. Press the **▲▼**, and then press the **ENTER** button.

### Repeat and Repeat A-B Playback

1. Press the **REPEAT** button, and then press the **REPEAT** or **▲▼** buttons to change playback mode. There are 3 modes Off, Title, Folder,
  - Folder : repeats the AVI files which have the same extension in the current folder.
  - Title : repeats the title that is playing.
  - Off : No Repeat mode.
2. Press the **REPEAT A-B** button on the remote control.
3. Press the **REPEAT A-B** button to set the point where you want repeat play to start (A).
4. Press the **REPEAT A-B** button again at the point where you want the repeat play to stop (B).
  - To return to normal play, press the **REPEAT A-B** button until the display shows Repeat:Off.

**Note**

A-B REPEAT allows you to set point (B) directly after you have set point (A).

### MPEG4 Function Description

Function	Description
Skip (◀◀ or ▶▶)	During play, press the  ◀◀ or ▶▶  button, it moves to next or previous track.
Search (◀◀ or ▶▶)	During play, press the SEARCH (◀◀ or ▶▶) button and press again to search at a faster speed. Allows you to search at a faster speed in an AVI file. (2X, 4X, 8X, 16X, 32X)
Slow Motion Play	Allows you to search at a slower speed in an AVI file. (1/2, 1/4, 1/8, 1/16)
ZOOM	Will zoom in X1/X2/X3/X4/Normal

- Depending on the MPEG4 file, these functions may not work.

### CD-R AVI file

This unit can play the following video compression formats within the AVI file format:

- DivX 3.11 contents
- DivX 4 contents (Based on MPEG-4 Simple Profile)
- DivX 5 contents (MPEG-4 simple profile plus additional features such as bi-directional frames. Qpel and GMC are also supported.)
- XviD MPEG-4 compliant contents.

### DVD-RW & DVD+R

Supported DivX file formats :

- Basic DivX format DivX3.11 / 4.12/ 5.x
- Xvid (MPEG-4 compliant video codec) and DivX Pro
- File format : \*.avi, \*.div, \*.divx.

This unit supports all resolutions for AVI up to maximum shown below.

DivX5
720 x 480 @30fps
720 x 576 @25fps
: Maximum bit rate : 4Mbps

Possible warning messages that may appear when trying to play DivX/AVI files are :

1. No Authorization
  - File with bad registration code.
2. Unsupported Codec
  - Files with certain Codec Types, Versions (ex. MP4, AFS and other proprietary codecs) are not supported by this player.
3. Unsupported Resolution
  - Files containing resolutions higher than the player's specification are not supported.

**Notes**

- The DVD-C550 can support resolutions up to 720 x 480 @30 frames and 720 x 576 @25 frames for DivX discs.
- This unit supports CD-R/RWs written in MPEG4 in accordance with the "ISO9660 format".

## Playing Media Files Using the USB Host feature (DVD-C550 Only)

You can enjoy media files such as pictures, movies, and tunes saved in an MP3 player, USB memory stick or digital camera by connecting them to the USB port of the DVD Player.

### Using the USB HOST Feature

1. Connect the USB device to the USB port on the front of the unit.
2. The USB Menu screen appears. Press the **◀▶** button to select Menu, and then press **ENTER**.
3. Press the **▲▼** buttons to select a file in the USB device. Press **ENTER** to open the file.

**Notes**

- When you press the USB button on the remote control, a screen displaying the USB device selection appears.
- "USB loading" appears on the display screen.
- Depends on the file size and clip duration, loading time on USB may take longer than using CD or DVD media.
- The USB MENU screen appears on the TV screen and the saved file is played.
- If there is a Disc in the unit, pressing the DVD button will make the player exit the USB menu and load the disc.



## Safe USB Removal

1. Press the DVD button to return to disc mode or the main screen.
2. Press the STOP (■) button
3. Remove the USB cable/device.

## Skip Forward/Back

During playback, press the (◀◀ / ▶▶) button.

- If there is more than one file, when you press the ▶▶ button, the next file is selected.
- If there is more than one file, when you press the ◀◀ button, the previous file is selected.

## Fast playback

To play back the disc at a faster speed, press (◀◀ / ▶▶) during playback.

- Each time you press either button, the playback speed will change as follows : 2X → 4X → 8X → 16X → 32X.

## Compatible Devices

1. USB devices that support USB Mass Storage v1.0. USB devices that operate as a removable disk in Windows (2000 or later) without additional driver installation.
2. MP3 Player: Flash type MP3 player.
3. Digital camera: Cameras that support USB Mass Storage v1.0.
  - Cameras that operate as a removable disk in Windows (2000 or later) without additional driver installation.
4. USB Flash Drive: Devices that support USB 2.0 or USB 1.1.
  - You may experience a difference in playback quality when you connect a USB 1.1 device.
5. USB card Reader: One slot USB card reader and Multi slot USB card reader
  - Depending on the manufacturer, the USB card reader may not be supported.
  - If you install multiple memory devices into a multi card reader, you may experience problems.
6. If you use a USB extension cable, the USB device might not be recognized.
  - CBI (Control/Bulk/Interrupt) is not supported.
  - Digital Cameras that use PTP protocol or require additional program installation when connected to a PC are not supported.
  - A device using NTFS file system is not supported. Only FAT 16/32 (File Allocation Table 16/32) file systems are supported.
  - Some MP3 players, when connected to this product, may not operate depending on the sector size of their file system.
  - The USB HOST function is not supported if a product that transfers media files by its manufacturer-specific program is connected.
  - Does not operate with Janus enabled MTP (Media Transfer Protocol) devices.
  - The USB host function of this product does not support all USB devices.

## CD Ripping (DVD-C550 Only)

This feature lets you copy audio files from a CD onto a USB device in MP3 format.

1. Open the disc tray. Place the Audio CD (CD DA) disc on the tray, and then close the tray. Connect the USB device to the USB port on the front of the unit. Press the DVD button.
2. Press the **TOOLS** button to display the Ripping screen.
3. Press the ▲/▼ buttons, then press the **ENTER** button to select a file for ripping.
  - To deselect a file, highlight the file, and then press the **ENTER** button again.
4. Press the ◀ and ▼ button to select **START**, and then press the **ENTER** button to begin ripping.

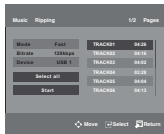

The Ripping menu contain the following buttons:

- **Mode** (Fast/Normal)
- **Bitrate**. Press **ENTER** to change : 128kbps → 192kbps → 128kbps ...
  - Standard : 128kbps
  - Better Quality : 192kbps
- **Device selection**. Press **ENTER** to change between partitions on the USB device (max 4).
- **Select - Unselect**. Press **ENTER** to change from Select all (files) or Select none.

## Notes

- To cancel copying in progress, press the **ENTER** button.
- To return to the CDDA screen, press the **TOOLS** button again.
- While the CD is being ripped, the player will automatically enter stop mode.
- The ripping process is 2.6 times of normal speed.
- The DVD player can only rip Audio CD (CD DA) discs.
- The USB button does not work while you're in the Ripping menu.
- CD ripping function may not supported for some MP3 players device.

## Picture CD Playback

1. Select the desired folder.
2. Press the ▲/▼ buttons to select a Picture file in the clips menu and then press the **ENTER** button.

## Notes

- Press the **STOP** button to return to the clips menu.
- When playing a Kodak Picture CD, the unit displays the Photo directly, not the Clips menu.

## Rotation

- Press the **TOOLS** button to select Rotate, and then press **ENTER** button.
- Each time the ◀/▶ buttons are pressed, the picture rotates 90 degrees clockwise.
- Each time the ▲ button is pressed, the picture will turn upside down to show a mirror image.
- Each time the ▼ button is pressed, the picture will reverse to the right side to show a mirror image.

## Zoom

- Press the **TOOLS** button to select Zoom, and then press **ENTER** button.
- Each time you press the **ENTER** button, the picture is enlarged. Zoom mode : X1-X2-X3-X4-X1.

## Slide Show

- If you press **PLAY** when viewing a JPEG file, the DVD player goes to full screen mode and the slide show automatically starts.

## Notes

- Depending on the file size, the amount of time each picture takes to load may be different.
- If you don't press any button, the slide show starts automatically in about 8 seconds.

## Picture CD Playback for HD-JPEG

To enjoy HD-JPEG, you must have connected to your TV using HDMI and set the resolution to 720p, 1080i or 1080p.

1. Select the desired folder.
2. Press the ▲/▼ buttons to select a Picture file in the Clips menu, and then press the **ENTER** button.
  - Press the **STOP** (■) button to return to the clips menu.
  - When playing a Kodak Picture CD, the unit displays the Photo directly, not the Clips menu.

#### - Rotation

Press the **TOOLS** button to select Rotate, and then press **ENTER** button. Press ◀▶ button to rotate the screen 90 degrees to the left/right.

#### - Skip Picture

Press the |◀◀ or ▶▶| button to select the previous or next picture.

#### - Slide Show

Press the **PLAY** (▶) button to start the SLIDE show.

Press the **PAUSE** (||) button to stop the SLIDE show.

#### Notes

- Depending on the file size, the amount of time each picture takes to load may be different.
- The image may be displayed at a smaller size depending on the TV picture resolution you've selected when displaying images in HD-JPEG mode.
- If you have a Samsung TV with BD Wise, we recommend you set BD Wise to "Off" when the JPEG image file you want to play back is bigger than the 720 X 480 pixel size.

#### MP3-JPEG Playback

You can display a JPEG photo file with background music.

1. Press the ▲/▼ buttons to select an MP3 file in the Clips menu, and then press the **ENTER** button. To return to the menu screen, press the **RETURN** or **MENU** buttons.
2. Press the ◀/▶ buttons to select Photos Menu, and then press the **ENTER** button. Press the ▲/▼ buttons to select a JPEG file in the Clips menu, and then press the **ENTER** button.
  - Music will continue playing.
3. Press the **STOP** button when you want to stop playback.

#### Note

MP3 and JPEG files have to be on the same disc.

#### CD-R JPEG Discs

- The DVD player can only display files with the ".jpg" and ".JPG" extensions.
- If the disc is not closed, it will take longer to start playing and all the recorded files may not play.
- The DVD player can only play CD-R discs with JPEG files in ISO 9660 or Joliet format.
- The name of the JPEG file may not be longer than 8 characters and should contain no blank spaces or special characters (. / = +).
- The DVD player can only play a consecutively written multi-session disc. If there is a blank segment in the multi-session disc, the DVD player can only play the disc only up to the blank segment.
- A maximum of 500 images can be stored on a single CD.
- Kodak Picture CDs are recommended.
- When playing a Kodak Picture CD, the DVD player can only play the JPEG files in the pictures folder.
- Kodak Picture CD: The DVD player can play the JPEG files in the pictures folder automatically.
- Konica Picture CD: If you want to see the pictures, select the JPEG files in the Clips menu.
- Fuji Picture CD: If you want to see the pictures, select the JPEG files in the Clips menu.
- QSS Picture CD: The unit may not play QSS Picture CDs.
- If the number of files in one Disc is over 500, the DVD player can play only the first 500 JPEG files.
- If the number of folders in one Disc is over 500, only the first JPEG files in 500 folders can be played.

## Navigating the setup menu

### Using the Setup Menu

The Setup menu lets you customize your DVD player by allowing you to select various language preferences, set up the parental level, and even adjust the player to the type of television screen you have.

1. With the unit in Stop mode, press the **MENU** button on the remote control. Press the ◀/▶ buttons to select **SETTINGS**, and then press the **ENTER** button.
2. Press the ▲/▼ buttons to select a Setup Menu, and then press the ▶ or **ENTER** to bring up the sub-menu.
3. Press the ▲/▼ buttons to select a sub-menu option, and then press the ▶ or **ENTER**.
4. To make the Setup screen disappear after setting up, press the **RETURN** button.
  - ① Display Setup : Setup of the Display Options. Use to select which type of screen you want to watch and several display options.
  - ② Audio Setup : Setup of the Audio Options.
  - ③ System Setup : Setup of the System Options.
  - ④ Language Setup : Setup of the Language.
  - ⑤ Security Setup : Setup of the Parental Level. Allows users to set the level necessary to prevent children from viewing unsuitable movies such as those with violence, adult subject matter, etc.
  - ⑥ General Setup : Setup of the General Options.
  - ⑦ Support Setup : Setup of the Support Options.

#### Note

Depending on the disc, some Setup menu selections may not work.

### Setting Up the Display Options

Display Setup options let you to set various video functions of the player.

1. With the unit in Stop mode, press the **MENU** button. Press the ◀/▶ buttons to select **SETTINGS**, and then press the **ENTER** button.
2. Press the ▲/▼ buttons to select **DISPLAY**, and then press the ▶ or **ENTER** button.
3. Press the ▲/▼ buttons to select the desired item, and then press the ▶ or **ENTER** button.

- Consult your TV User's Manual to find out if your TV supports Progressive Scan. If Progressive Scan is supported, follow the TV User's Manual regarding Progressive Scan settings in the TV's menu system.
- If Video Output is set incorrectly, the TV screen may be blank.

The following describes each option found in the Display Setup Menu.

#### ① TV Aspect

Depending on a type of television you have, you may want to adjust the screen setting (aspect ratio).

- **4:3 Pan & Scan** : Select this for conventional size TVs when you want to see the central portion of the 16:9 screen. (Extreme left and right side of movie picture will be cut off.)
- **4:3 Letter Box** : Select when you want to see the total 16:9 ratio screen DVD supplies, even though you have a TV with a 4:3 ratio screen. Black bars will appear at the top and bottom of the screen.
- **16:9 Wide** : You can view the full 16:9 picture on your widescreen TV.

#### ② BD Wise

When the player is connected to a SAMSUNG TV which supports "BD Wise", you can enjoy optimized Picture Quality by setting the "BD Wise" function to "On".

#### ③ HDMI

Use this setting when the unit is connected by HDMI to Display devices (TV, Projector, etc.).

- **Auto**: Auto resolution setting.

The player will auto detect the highest resolution of TV

#### - Resolution:

- 480p : 720 x 480
- 1080i : 1920 x 1080
- 720p : 1280 x 720
- 1080p : 1920 x 1080

## Setting Up BD Wise

1. With the unit in Stop mode, press the **MENU** button. Press the ◀/▶ buttons to select **SETTINGS**, and then press the **ENTER** button.
2. Press the ▲/▼ buttons to select **DISPLAY**, and then press the ▶ or **ENTER** button.
3. Press the ▲/▼ buttons to select **BD WISE**, and then press the ▶ or **ENTER** button.  
Press the ▲/▼ buttons to select **ON/OFF**, then press the **ENTER** button.
  - Please choose **"Yes"** to continue, otherwise choose **"No"** to keep current setting.
  - The HDMI resolution will be changed to maximum resolution supported by your TV.

### Notes

- The resolutions available for HDMI output depend on the connected TV or projector you have connected. For details, see the user's manual of your TV or projector.
- When the resolution is changed during playback, it may take a few seconds for a normal image to appear.
- If you have HDMI connected, you will get better picture quality when the output resolution is set to 720p, 1080i or 1080p.
- If you have connected the player via HDMI to a TV that supports "BD Wise", the first time you turn on this product, the "BD Wise" function will be automatically set to "On".
- If you turn off the DVD player when the "BD Wise" function is "On", the player will retain the "BD Wise" On menu setting as long as it is connected to TV that supports "BD Wise".
- If the HDMI cable is removed when the "BD Wise" function is "On" and then plugged into another TV which does not support "BD Wise", the HDMI Resolution will be automatically change to "Auto".
- We recommend that you set the "BD Wise" to "Off" when the JPEG image file you want to play back is bigger than the 720 X 480 pixel size.

## Setting Up the Audio Options

Audio Setup options let you to set up the audio device and sound status settings depending on the audio system you are using.

1. With the unit in Stop mode, press the **MENU** button. Press the ◀/▶ buttons to select **SETTINGS**, and then press the **ENTER** button.
2. Press the ▲/▼ buttons to select **AUDIO**, and then press the ▶ or **ENTER** button.
3. Press the ▲/▼ buttons to select the desired item, and then press the ▶ or **ENTER** button.

The following describes each option found in the Audio Setup Menu.

- ① **Dolby Digital Out**
  - PCM : Converts to PCM(2CH) audio.
  - Bitstream : Outputs Dolby Digital via digital output.  
Select Bitstream when connecting to a Dolby Digital Decoder.
- ② **MPEG2 Digital Output**
  - PCM : Converts to PCM(2CH) audio.
  - Bitstream : Converts to MPEG-2 Digital Bitstream (5.1CH).  
Select Bitstream when using the Digital Audio Output.
- ③ **Dynamic Range Comp.**
  - On : To select dynamic range compression. This is useful for watching movies late at night, as it balances the loud and quiet portions of a disc.
  - Off : To select the standard range.
- ④ **PCM Down Sampling**
  - On : Select this when the amplifier connected to the player is not 96KHz compatible.  
In this case, the 96KHz signals will be down converted to 48KHz.
  - Off : Select this when the amplifier connected to the player is 96KHz compatible. In this case, all signals will be output without any changes.

### Notes

- When play a disc that has MPEG Audio and you have Bitstream selected in the Audio Options menu, the Digital Audio jack may not output audio
- There is no output from the analog audio jacks when you play a DTS sound disc.
- Even when PCM Down sampling is Off, some discs will only output down sampled audio through the digital output.

### HDMI

- **If your TV is not compatible with compressed multi-channel formats (Dolby Digital, DTS, MPEG), you should set Digital Audio to PCM.**
- **If your TV is not compatible with LPCM sampling rates over 48kHz, you should set PCM Down sampling to On.**

Manufactured under license from Dolby Laboratories. "Dolby" and the double-D symbol are trademarks of Dolby Laboratories.

"DTS" and "DTS Digital Out" are trademarks of Digital Theater Systems, Inc.

## Setting Up the System Options

1. With the unit in Stop mode, press the **MENU** button. Press the ◀/▶ buttons to select **SETTINGS**, and then press the **ENTER** button.
2. Press the ▲/▼ buttons to select **SYSTEM**, and then press the ▶ or **ENTER** button.
3. Press the ▲/▼ buttons to select the desired item, and then press the ▶ or **ENTER** button.

The following describes each option found in the System Setup Menu.

- ① **Anynet+(HDMI-CEC)**: To setup the Anynet+(HDMI-CEC) Options.  
Anynet+ is a function that can be used to operate this DVD Player using a Samsung TV remote control. This is done by connecting the DVD player to a SAMSUNG TV using an HDMI Cable. This is only available with SAMSUNG TVs that support Anynet+. To operate Anynet+, you must turn Anynet+(HDMI-CEC) On in the System Setup menu.
- ② **DivX(R) Registration** : Please use the Registration code to register this player with the DivX(R) Video On Demand format.
- ③ **DivX(R) Deactivation**

### Setting Up Anynet+(HDMI-CEC)

1. With the unit in Stop mode, press the **MENU** button. Press the ◀/▶ buttons to select **SETTINGS**, and then press the **ENTER** button.
2. Press the ▲/▼ buttons to select **SYSTEM**, and then press the ▶ or **ENTER** button.
3. Press the ▲/▼ buttons to select **ANYNET+(HDMI-CEC)**, and then press the ▶ or **ENTER** button.
4. Set the Anynet+(HDMI-CEC) to "On" on your DVD Player., then press the **ENTER** button.
5. Set the Anynet+ function on your Samsung TV. (See your TV instruction manual for more information.).
  - When you press Anynet+ button on the TV remote control, the OSD to the right will appear.

#### Notes

- While watching TV, your TV screen will change to the play screen when you press the **PLAY** button of the DVD player.
- If you play a DVD when the TV power is off, the TV will power On.
- If you turn the TV off, the DVD Player will power off automatically.
- If you change from HDMI to other sources (Composite, Component, ... etc) while playing a DVD disc, the DVD Player will stop playing.

## Setting Up the Language Features

If you set the player menu, disc menu, audio, and subtitle language in advance, they will come up automatically every time you watch a movie.

### Using the Player Language Menu

1. With the unit in Stop mode press the **MENU** button. Press the ◀/▶ buttons to select **SETTINGS**, and then press the **ENTER** button.
2. Press the ▲/▼ buttons to select **LANGUAGE**, and then press the ▶ or **ENTER** button.
3. Press the ▲/▼ buttons to select the desired language, and then press the ▶ or **ENTER** button.

#### Notes

- After you select the language, the screen returns to the Language Setup Page.
- To make the Setup menu disappear, press the **MENU** button.
- If the language you selected is not recorded on the disc, the player selects the original, pre-recorded language.
- Select "Original" if you want the default soundtrack language to be the original language the disc is recorded in.
- Select "Automatic" if you want the subtitle language to be the same as the language you selected for the audio language.
- Some discs may not contain the language you select. In that case, the disc will use its original language setting.

## Setting Up the Security Options

The Parental Control function works in conjunction with DVDs that have been assigned a rating, which helps you control the types of DVDs that your family watches. There are up to 8 rating levels on a disc.

### Setting Up the Rating Level and Changing the Password

1. With the unit in Stop mode, press the **MENU** button. Press the ◀/▶ buttons to select **SETTINGS**, and then press the **ENTER** button.
2. Press the ▲/▼ buttons to select **SECURITY**, and then press the ▶ or **ENTER** button.  
Enter your password.
3. Press the ▲/▼ buttons to select **PARENTAL/CHANGE PASSWORD**, and then press the ▶ or **ENTER** button.
4. Press the ▲/▼ buttons to select the rating level you want, and then press the **ENTER** button.  
e.g) Setting up in **KID SAFE**
  - For example, if you select the Kids Safe level, discs that contain level 2 or higher will not play.
5. Enter your password. If this is the first time, enter 0000. Then, enter a new password. The new password must be a number other than 0000 to activate the parental control function. Then, re-enter the new password.

#### Security Levels:

- ❶ **KID SAFE**
- ❷ **G (General Audiences)** : All Ages Admitted
- ❸ **PG (Parental Guidance suggested)** : Some material may not be suitable for young children.
- ❹ **PG 13 (PG-13 Parents strongly cautioned)** : Some material may be inappropriate for children under 13.
- ❺ **PGR (Parental Guidance Recommended)** : These are not necessarily unsuitable for children, but viewer discretion is advised, and parents and guardians are encouraged to supervise younger viewers.
- ❻ **R (Restricted)** : Under 17 requires accompanying adult
- ❼ **NC17 (NC-17)** : No one 17 and under admitted.
- ❽ **ADULT**

#### Note:

- If you have forgotten your password, see "Forgot Password" in the Troubleshooting section.

## Setting Up the General Options

1. With the unit in Stop mode, press the **MENU** button. Press the ◀/▶ buttons to select **SETTING**, and then press the **ENTER** button.
2. Press the ▲/▼ buttons to select **GENERAL**, and then press the ▶ or **ENTER** button.
3. Press the ▲/▼ buttons to select the desired item, and then press the ▶ or **ENTER** button.

The following describes each option found in the General Setup Menu.

#### ❶ Screen Message

Use to turn on-screen messages On or Off.

#### ❷ Black Level

Adjusts the brightness of the screen (On or Off). This feature only functions in Video Composite mode. It does not have any effect in HDMI and Component modes.

#### ❸ Picture Quality

- Brightness : Level 1 ~ Level 5
- Contrast : Level 1 ~ Level 5
- Color Saturation : Level 1 ~ Level 5

#### ❹ Video Output

Select Video Output.

- **P-SCAN (Progressive)** : Select when you want to use Component Out.
- **I-SCAN (Interlaced)** : Select when you want to use Video or Component Out.

#### Note

- When connected via HDMI, you do not need to make a Video Output setting. The output is set when the HDMI Display options are made.

## Setting Up the Support Options

Support option enable you to check your DVD player information such as the model code, Software Version, The serial and version numbers can be found on the back side of your DVD-Player.

1. With the unit in Stop mode, press the **MENU** button. Press the ◀/▶ buttons to select **SETTINGS**, then press the **ENTER** button.
2. Press the ▲/▼ buttons to select **SUPPORT**, then press the ▶ or **ENTER** button.
3. Select **PRODUCT INFORMATION**, then press the ▶ or **ENTER** button.

## Firmware upgrade

### Introduction

Upgrading the Firmware will keep your DVD player up to date.

The latest firmware version for this unit is provided on the Samsung Website.(www.samsung.com).

### How to make an upgrade disc

You must burn the latest firmware version onto a blank CD-R or CD-RW disc:

1. Download a new file from Samsung's website (www.samsung.com) Download Center.
2. Write the file to disc using CD-RW drive of your computer as data disc.

### Notes

The CD should be burned following the specs below.

- File System CD-ROM ISO Level.
- Character set ISO 9660.
- The burned CD has to be Finalized.
- Please make sure the filename C550/C500.BIN
- Please make sure the root folder rename as MEDIATEK
- Please burn the CD at a low speed.

### Upgrade procedure

1. Open the disc tray of your DVD C550/C500. Place the burned disc on the tray. Close the tray. The Firmware upgrade screen will appear.

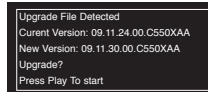

Firmware upgrade menu appears

2. Press the **ENTER** or **PLAY** to start upgrade.

- Press any other buttons on the remote control or eject the disc to cancel the upgrade.
  - During the firmware upgrade process, the tray will open. Please remove the disc and wait for about 2 minutes.
  - If the DVD player was successfully updated, the disc tray will close and the unit will turn off and on.
- When the unit turns on, the Select Menu Language screen will appear.

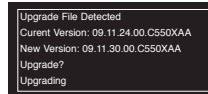
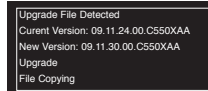

Firmware upgrade starts

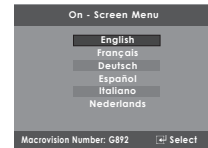

3. Press the **▲/▼** buttons to select the desired language, and then press the **ENTER** button.

### Notes

- If the "Select Menu Language" doesn't appear, please contact Samsung Customer Service.
- Do not press any button or unplug the power cord during the upgrade.
- The upgrade procedure may change, refer to the web site (www.samsung.com).
- When software is upgraded, video and audio settings you have made will return to their default (factory) settings. We recommend you write down your settings so that you can easily reset them after the upgrade.
- Samsung do not assure all freeware disc burner that burn file upgrade into a disc which will played on the player.

## Troubleshooting

Before requesting service, please check the following.

Problem	Action
The screen is blocked.	<ul style="list-style-type: none"> <li>• Press the <b>■▶  </b> button (on the front panel) for more than 5 seconds with no disc inside. All settings will revert to the factory settings.</li> </ul>
Forgot password.	<ul style="list-style-type: none"> <li>• Press the <b>■▶  </b> button (on the panel) for more than 5 seconds with no disc inside. All settings including the password will revert to the factory settings (0000). Don't use this unless absolutely necessary.</li> </ul>
No HDMI output	<ul style="list-style-type: none"> <li>• Check if the Video output is set to HDMI.</li> <li>• Check the connection between the TV and the HDMI jack of DVD player.</li> <li>• See if the TV supports 480p/ 720p/1080i/1080p.</li> </ul>
Abnormal HDMI output screen.	<ul style="list-style-type: none"> <li>• If snow noise appears on the screen, it means that TV does not support HDCP (High-bandwidth Digital Content Protection).</li> </ul>
HDMI output Jitter	<ul style="list-style-type: none"> <li>• Check if your TV is setup correctly.</li> <li>• Screen Jitter may occur when frame rate is converted from 50Hz to 60Hz for 720P/1080i/ 1080p HDMI (High Definition Multimedia Interface) Output.</li> <li>• Please refer to the user's manual of your TV.</li> </ul>

## Specifications

Memo

General	Power Requirements	AC 120V ~ 60 Hz
	Power Consumption	6W (ON), 1W (OFF)
	Weight	DVD-C500 : 2.6 lbs
		DVD-C550 : 3.3 lbs
	Dimensions	DVD-C500 : 14.4" (W) X 8.15" (D) X 1.65" (H)
		DVD-C550 : 17" (W) X 8.15" (D) X 1.65" (H)
Operating Temperature Range	+41°F to +95°F	
Operating Humidity Range	10 % to 75 %	
Video Output	Composite Video	1 channel : 1.0 Vp-p (75 Ω load) 60Hz
	Component Video	Y : 1.0 Vp-p (75 Ω load) Pr : 0.70 Vp-p (75 Ω load) Pb : 0.70 Vp-p (75 Ω load) I-SCAN & P-SCAN 480i, 480p
	HDMI	480p, 720p, 1080i, 1080p
Audio Output	Output terminal	RCA
	Maximum Output Level	2Vrms
	Frequency Response	20Hz ~ 20kHz
	Digital Audio Output	Coaxial terminal (S/PDIF)

# Warranty

## LIMITED WARRANTY TO ORIGINAL PURCHASER

This SAMSUNG brand product, as supplied and distributed by SAMSUNG ELECTRONICS AMERICA, INC. (SAMSUNG) and delivered new, in the original carton to the original consumer purchaser, is warranted by SAMSUNG against manufacturing defects in materials and workmanship for the following limited warranty period:

### One (1) Year Parts / Ninety days (90) Labor

This limited warranty begins on the original date of purchase, and is valid only on products purchased and used in the United States, and does not include transportation, installation, removal or reinstallation. Warranty repairs must be performed by SAMSUNG's authorized service center. To receive warranty service, the original dated bill of sale must be presented upon request as proof of purchase to SAMSUNG or SAMSUNG's authorized service center. Transportation to and from the service center is the responsibility of the purchaser.

SAMSUNG will repair or replace this product, at our option and at no charge with new or reconditioned parts, if found to be defective during the limited warranty period specified above. The product must be returned during the warranty period with transportation charges prepaid to SAMSUNG's designated service center. Prior to returning any product for warranty service, the purchaser must contact SAMSUNG for problem determination and service procedures. SAMSUNG does not warrant uninterrupted or error-free operation of the product. All replaced parts and products become the property of SAMSUNG and must be returned to SAMSUNG. Replacement parts and products assume the remaining original warranty, or ninety (90) days, whichever is longer.

This limited warranty covers manufacturing defects in materials and workmanship encountered in normal, non-commercial use of this product and shall not apply to the following, including, but not limited to: damage which occurs in shipment; applications and uses for which this product was not intended; failures or problems which are caused by products or equipment not supplied by SAMSUNG; accidents, misuse, abuse, neglect, misapplication, fire, water, light-ning or other acts of nature; incorrect electrical line voltage, fluctuations or surges; damage caused by improper or faulty installation; improper connection with any peripheral; product alteration or modification; improper or unauthorized repair; cosmetic damage or exterior finish; product with altered serial numbers; failure to follow operating instructions, customer adjustments, maintenance and environmental instructions that are covered and prescribed in the instruction book; use of non-SAMSUNG or unauthorized parts, supplies, accessories or equipment which damage this product or result in service problems; failures or problems due to incompatibility with other equipment.

### QUESTIONS OR COMMENTS?

COUNTRY	CALL	OR VISIT US ONLINE AT	WRITE
IN THE US	1-800-SAMSUNG (7267864)	www.samsung.com	Samsung Electronics America, Inc. 105 Challenger Road Ridgely Park, NJ 07660-0511

### Contact SAMSUNG WORLD WIDE

If you have any questions or comments relating to Samsung products, please contact the SAMSUNG customer care center.

Region	Area	Contact Center ☎	Web Site
North America	Canada	1-800-SAMSUNG (726-7864)	www.samsung.com/ca
	Mexico	01-800-SAMSUNG (726-7864)	www.samsung.com/mx
	U.S.A.	1-800-SAMSUNG (726-7864)	www.samsung.com/us
	Argentina	0800-333-3733	www.samsung.com/ar
	Brazil	0800-124-421, 4004-0000	www.samsung.com/br
Latin America	Chile	800-SAMSUNG (726-7864)	www.samsung.com/cl
	Nicaragua	00-1800-5077267	www.samsung.com/latin
	Honduras	800-791267	www.samsung.com/latin
	Costa Rica	0-800-507-7267	www.samsung.com/latin
	Ecuador	1-800-10-7267	www.samsung.com/latin
	El Salvador	800-6225	www.samsung.com/latin
	Guatemala	1-800-299-0013	www.samsung.com/latin
	Jamaica	1-800-234-7267	www.samsung.com/latin
	Panama	800-7267	www.samsung.com/latin
	Puerto Rico	1-800-682-3180	www.samsung.com/latin
Europe	Rep. Dominica	1-800-751-2676	www.samsung.com/latin
	Trinidad & Tobago	1-800-SAMSUNG (726-7864)	www.samsung.com/latin
	Venezuela	0-800-100-5303	www.samsung.com/latin
	Colombia	01-8000112112	www.samsung.com.co
	Belgium	02 201 2418	www.samsung.com/be (Dutch) www.samsung.com/be_fr (French)
	Czech Republic	800-SAMSUNG (800-726786)	www.samsung.com/cz
	Denmark	8-SAMSUNG (7267864)	www.samsung.com/dk
	Finland	30-8227 515	www.samsung.com/fin
	France	01 4863 0000	www.samsung.com/fr
	Germany	01805-SAMSUNG (726-7864 € 0,14/Min)	www.samsung.de
	Hungary	06-80-SAMSUNG (726-7864)	www.samsung.com/hu
	Italy	800-SAMSUNG (726-7864)	www.samsung.com/it
	Luxembourg	02 261 03 710	www.samsung.com/lu
	Netherlands	0900-SAMSUNG (0900-7267864) (€ 0,10/Min)	www.samsung.com/nl
	Norway	3-SAMSUNG (7267864)	www.samsung.com/no
	Poland	0 801 1SAMSUNG (172678), 022-607-93-33	www.samsung.com/pl
	Portugal	80820-SAMSUNG (726-7864)	www.samsung.com/pt
Slovakia	0800-SAMSUNG (726-7864)	www.samsung.com/sk	
Spain	902-1-SAMSUNG (902 172 678)	www.samsung.com/es	
Sweden	0771 726 7864 (SAMSUNG)	www.samsung.com/se	
U.K.	0845 SAMSUNG (7267864)	www.samsung.com/uk	
Eire	0818 717 100	www.samsung.com/ie	
Austria	0810-SAMSUNG (7267864, € 0.07/min)	www.samsung.com/at	
Switzerland	0848-SAMSUNG (7267864, CHF 0.08/min)	www.samsung.com/ch www.samsung.com/ch_fr (French)	
CIS	Russia	8-800-555-55-55	www.samsung.ru
	Kazakhstan	8-10-800-500-55-500	www.samsung.com/kz_ru
	Uzbekistan	8-10-800-500-55-500	www.samsung.com/kz_ru
	Kyrgyzstan	00-800-500-55-500	www.samsung.com/ky
	Tadikistan	8-10-800-500-55-500	www.samsung.com/td
	Ukraine	8-800-502-0000	www.samsung.ua
	Belarus	810-800-500-55-500	www.samsung.com/ua_ru
	Moldova	00-800-500-55-500	www.samsung.com/ro
	Lithuania	8-800-7777	www.samsung.com/lt
	Latvia	8000-7267	www.samsung.com/lv
Estonia	800-7267	www.samsung.com/ee	
Asia Pacific	Australia	1300 362 603	www.samsung.com/au
	New Zealand	0800 SAMSUNG (0800 726 786)	www.samsung.com/nz
	China	400-810-5888, 010-6475 1880	www.samsung.com/cn
	Hong Kong	3698-4698	www.samsung.com/hk www.samsung.com/hk_en/
	India	3030 8282, 1800 110011, 1800 3000 8282	www.samsung.com/in
	Indonesia	0800-112-8888	www.samsung.com/id
	Japan	0120-327-527	www.samsung.com/jp
	Malaysia	1800-88-9999	www.samsung.com/my
	Philippines	1-800-10-SAMSUNG (726-7864), 1-800-3-SAMSUNG (726-7864), 1-800-8-SAMSUNG (726-7864), 02-5805777	www.samsung.com/ph
	Singapore	1800-SAMSUNG (726-7864)	www.samsung.com/sg
Thailand	1800-29-3232, 02-689-3232	www.samsung.com/th	
Taiwan	0800-329-999	www.samsung.com/tw	
Vietnam	1 800 588 889	www.samsung.com/vn	
Middle East & Africa	Turkey	444 77 11	www.samsung.com/tr
	South Africa	0860-SAMSUNG (726-7864)	www.samsung.com/za
	U.A.E	800-SAMSUNG (726-7864), 8000-4726	www.samsung.com/ae

AK68-01848A(03)



## Free Manuals Download Website

<http://myh66.com>

<http://usermanuals.us>

<http://www.somanuals.com>

<http://www.4manuals.cc>

<http://www.manual-lib.com>

<http://www.404manual.com>

<http://www.luxmanual.com>

<http://aubethermostatmanual.com>

Golf course search by state

<http://golfingnear.com>

Email search by domain

<http://emailbydomain.com>

Auto manuals search

<http://auto.somanuals.com>

TV manuals search

<http://tv.somanuals.com>