

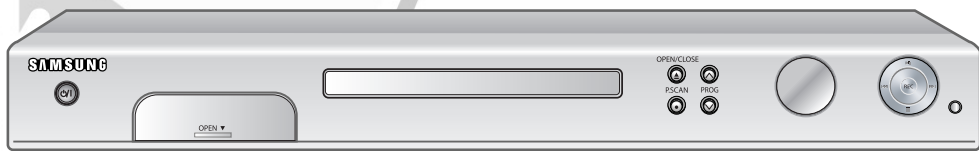

Instruction Manual

DVD-R125



AK68-00842A-01

Warning

TO REDUCE THE RISK OF ELECTRIC SHOCK, DO NOT REMOVE THE COVER(OR BACK). NO USER-SERVICEABLE PARTS ARE INSIDE. REFER SERVICING TO QUALIFIED SERVICE PERSONNEL.



This symbol indicates “dangerous voltage” inside the product that presents a risk of electric shock or personal injury.



This symbol indicates important instructions accompanying the product.

Do not install this equipment in a confined space such as a bookcase or similar unit.

WARNING : To prevent damage which may result in fire or electric shock hazard, do not expose this appliance to rain or moisture.

CAUTION : DVD RECORDER USES AN INVISIBLE LASER BEAM WHICH CAN CAUSE HAZARDOUS RADIATION EXPOSURE IF DIRECTED.
BE SURE TO OPERATE RECORDER CORRECTLY AS INSTRUCTED.

CAUTION

THIS PRODUCT UTILIZES A LASER.
USE OF CONTROLS OR ADJUSTMENTS OR PERFORMANCE OF PROCEDURES OTHER THAN THOSE SPECIFIED HEREIN MAY RESULT IN HAZARDOUS RADIATION EXPOSURE.
DO NOT OPEN COVERS AND DO NOT REPAIR YOURSELF. REFER SERVICING TO QUALIFIED PERSONNEL.

This product satisfies CE regulations when shielded cables and connectors are used to connect the unit to other equipment. To prevent electromagnetic interference with electric appliances, such as radios and televisions, use shielded cables and connectors for connections.

IMPORTANT NOTE

The mains lead on this equipment is supplied with a moulded plug incorporating a fuse. The value of the fuse is indicated on the pin face of the plug. If it requires replacing, a fuse approved to BS1362 of the same rating must be used.

Never use the plug with the fuse cover omitted if the cover is detachable. If a replacement fuse cover is required, it must be of the same colour as the pin face of the plug. Replacement covers are available from your dealer.

If the fitted plug is not suitable for the power points in your house or the cable is not long enough to reach a power point, you should obtain a suitable safety approved extension lead or consult your dealer for assistance.

However, if there is no alternative to cutting off the plug, remove the fuse and then safely dispose of the plug. Do not connect the plug to a mains jack, as there is a risk of shock hazard from the bared flexible cord.

The product unit accompanying this user manual is licensed under certain intellectual property rights of certain third parties. This license is limited to private non-commercial use by end-user consumers for licensed contents.

No rights are granted for commercial use.

The license does not cover any product unit other than this product unit and the license does not extend to any unlicensed product unit or process conforming to ISO/IEC 11172-3 or ISO/IEC 13818-3 used or sold in combination with this product unit. The license only covers the use of this product unit to encode and/or decode audio files conforming to the ISO/IEC 11172-3 or ISO/IEC 13818-3. No rights are granted under this license for product features or functions that do not conform to the ISO/IEC 11172-3 or ISO/IEC 13818-3.

Precaution

Important Safety Instructions

Read these operating instructions carefully before using the unit. Follow all the safety instructions listed below. Keep these operating instructions handy for future reference.

- 1) Read these instructions.
- 2) Keep these instructions.
- 3) Heed all warnings.
- 4) Follow all instructions.
- 5) Do not use this apparatus near water.
- 6) Clean only with dry cloth.
- 7) Do not block any ventilation openings, Install in accordance with the manufacturer's instructions.
- 8) Do not install near any heat sources such as radiators, heat registers, stoves, or other apparatus (including amplifiers) that produce heat.
- 9) Do not defeat the safety purpose of the polarized or grounding- type plug. A polarized plug has two blades with one wider than the other. A grounding-type plug has two blades and a third grounding prong. The wide blade or the third prong are provided for your safety. If the provided plug does not fit into your outlet, consult an electrician for replacement of the obsolete outlet.
- 10) Protect the power cord from being walked on or pinched particularly at plugs, convenience receptacles, the point where they exit from the apparatus.
- 11) Only use attachments/accessories specified by the manufacturer.
- 12) Use only with the cart, stand, tripod, bracket, or table specified by the manufacturer, or sold with the apparatus. When a cart is used, use caution when moving the cart/apparatus combination to avoid injury from tip-over.
- 13) Unplug this apparatus during lightning storms or when unused for long periods of time.
- 14) Refer all servicing to qualified service personnel. Servicing is required when the apparatus has been damaged in any way, such as power-supply cord or plug is damaged, liquid has been spilled or objects have fallen into the apparatus, the apparatus has been exposed to rain or moisture, does not operate normally, or has been dropped.

Handling Cautions

- Before connecting other components to this recorder, be sure to turn them all off.
- Do not move the recorder while a disc is being played, or the disc may be scratched or broken, the recorder's internal parts may be damaged.
- Do not put a flower vase filled with water or any small metal objects on the recorder.
- Be careful not to put your hand into the disc tray.
- Do not place anything other than the disc in the disc tray.
- Exterior interference such as lightning and static electricity can affect normal operation of this recorder. If this occurs, turn the recorder off and on again with the **STANDBY/ON** button, or disconnect and then reconnect the AC power cord to the AC power outlet. The recorder will operate normally.
- Be sure to remove the disc and turn off the recorder after use.
- Disconnect the AC power cord from the AC outlet when you don't intend to use the recorder for long periods of time.
- Clean the disc by wiping in a straight line from the inside to the outside of the disc.

Maintenance of Cabinet

For safety reasons, be sure to disconnect the AC power cord from the AC outlet.

- Do not use benzene, thinner, or other solvents for cleaning.
- Wipe the cabinet with a soft cloth.

Disc Handling

- Use discs with regular shapes. If an irregular disc (a disc with a special shape) is used, this DVD recorder may be damaged.

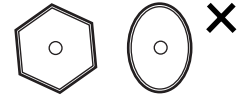

Holding discs

- Avoid touching the surface of a disc where recording is performed.



DVD-RAM, DVD-RW and DVD-R

- Clean with an optional DVD-RAM/PD disc cleaner (LF-K200DCA1 where available). Do not use cleaners or cloths for CDs to clean DVD-RAM/DVD-RW/DVD-R discs.



DVD-Video, Audio CD

- Wipe off dirt or contamination on the disc with a soft cloth.

Cautions on handling discs

- Do not write on the printed side with a ball-point pen or pencil.
- Do not use record cleaning sprays or antistatic. Also, do not use volatile chemicals, such as benzene or thinner.
- Do not apply labels or stickers to discs. (Do not use discs fixed with exposed tape adhesive or leftover peeled-off stickers.)
- Do not use scratch-proof protectors or covers.
- Do not use discs printed with label printers available on the market.
- Do not load warped or cracked discs.

Disc Storage

Be careful not to harm the disc because the data on these discs is highly vulnerable to the environment.

- Do not keep under direct sunlight.
- Keep in a cool ventilated area.
- Store vertically.
- Keep in a clean protection jacket.
- If you move your DVD recorder suddenly from a cold place to a warm place, condensation may generate on the operating parts and lens and cause abnormal disc playback. If this occurs, remove the disc and wait for one to two hours with the power on before attempting playback.

Disc Specifications

DVD-Video

- A digital versatile disc (DVD) can contain up to 135-minutes of images, 8 audio languages and 32 subtitle languages. It is equipped with MPEG-2 picture compression and Dolby digital surrounding, allowing you to enjoy vivid and clear theater quality images in the comfort of your own home.
- When switching from the first layer to the second layer of a dual-layered DVD Video disc, there may be momentary distortion in the image and sound. This is not a malfunction of the unit.
- Once a DVD-R/RW recorded in Video Mode is finalised, it becomes DVD-Video.

Audio CD

- An audio disc on which 44.1kHz PCM Audio is recorded
- Plays CD-DA format audio CD-R and CD-RW discs. The unit may not be able to play some CD-R or CD-RW discs due to the condition of the recording.

CD-R/RW

MP3 CD-R/RW

- Only CD-R discs with MP3 files recorded with ISO9660 or JOLIET format can be played back
- Only MP3 files with the ".mp3", ".MP3" extension can be used.
- For MP3 files recorded with a VBR(Variable Bit Rates), from 32 Kbps to 320 Kbps, the sound may cut in out.
- Playable bitrate range is from 56Kbps to 320Kbps.
- The unit can handle a maximum of 500 files and 100 folders.

JPEG CD-R/RW

- Only JPEG files with the ".jpg", ".JPG" extension can be used.
- The unit can handle a maximum of 500 files and 100 folders.
- Maximum size of progressive JPEG is 3M pixels.
- MOTION JPEG is not supported.

Using CD-R/RW

- Use a 700MB(80 minutes) CD-R/RW disc. If possible, do not use a 800MB(90 minutes) or above disc, as the disc may not play back.
- If the CD-R/RW disc was not recorded as a closed session, you may experience a delay in the early playback time, all recorded files may not play.
- Some CD-R/RW discs may not be playable with this unit, depending on the device which was used to burn them. For contents recorded on CD-R/RW media from CDs for your personal use, playability may vary depending on contents and discs.

Using MPEG4 disc

- Disc : CD-R/RW, DVD-R/RW/RAM
- MPEG4 File with following extensions can be played : .avi, .divx, .AVI, .DIVX
- MPEG4 Codec format : DivX 3.11 DivX 4.x DivX 5.x DivX-Pro (without QPEL and GMC)
- Available Audio Format : "MP3", "MPEG", "WMA", "LPCM", "AC3"
- Supported subtitle file formats: .smi, .srt, .sub, .psb, .txt, .ass

DVD-R Disc Playback and Recording

- Once a DVD Recorder in Video Mode is finalised, it becomes DVD-Video.
- You can record onto the available space on the disc and perform editing functions such as giving titles to discs and programmes and erasing programmes before finalising.
- When programming is erased from a DVD-R, that space does not become available. Once an area on a DVD-R is recorded on, that area is no longer available for recording, whether the recording is erased or not.
- It takes about 30 seconds for the unit to complete recording management information after recording finishes.
- This product optimizes the DVD-R for each recording. Optimizing is carried out when you start recording after inserting the disc or turning on the unit. Recording onto the disc may become impossible if optimizing is carried out too many times.
- Playback may be impossible in some cases due to the condition of recording.
- This unit can play back DVD-R discs recorded and finalised with a Samsung DVD video recorder. It may not be able to play some DVD-R discs depending on the disc and the condition of the recording.

DVD-RW Disc Playback and Recording

- Recording and playback can be performed on DVD-RW discs in both the Video and VR Modes.
- Once a DVD-RW recorded in both the Video and VR Modes is finalised, you cannot perform additional recording.
- Once a DVD-RW recorded in Video Mode is finalised, it becomes DVD-Video.
- In both modes, playback can be performed before and after finalisation, but additional recording, deleting and editing can not be performed after finalisation.
- If you want to record the disc in VR Mode and then record in V Mode, be sure to execute Format. Be careful when executing Format because all the recorded data may be lost.

- A DVD-RW blank disc is initialized to VR Mode when first initialized.
- **DVD-RW (VR mode)**
 - This is a format that is used for recording data on a DVD-RAM or DVD-RW disc.
You can record multiple titles, edit, delete, partial delete, create a playlist, etc.
 - A disc that is recorded in this mode may not be played by existing DVD Recorder.
- **DVD-RW (Video mode)**
 - This is a format that is used for recording data on a DVD-RW or DVD-R disc. The disc can be played by existing DVD Recorder once it has been finalised.
 - If a disc that has been recorded in Video Mode by a different maker's recorder but has not been finalised, it cannot be played or additionally be recorded by this recorder.

DVD-RAM Disc Playback and Recording

- Ensure that the recording mode is set to VR mode. Otherwise, this product will not be able to play the recording.
- You cannot play a DVD-RAM in most DVD components due to compatibility issues.
- Only DVD-RAM standard Version 2.0. discs can be played in this unit.
- DVD-RAM recorded on this unit may not work with other DVD components. To determine compatibility with these DVD-RAM discs, refer to the user's manual for the DVD recorder.
- For cartridge type DVD-RAM discs, remove the cartridge and use the disc only.

COPY PROTECTION

- Many DVD discs are encoded with copy protection. Because of this, you should only connect your DVD recorder directly to your TV, not to a VCR. Connecting to a VCR results in a distorted picture from copy-protected DVD discs.
- This product incorporates copyright protection technology that is protected by methods claims of certain U.S. patents and other intellectual property rights owned by Macrovision Corporation and other rights owners. Use of this copyright protection technology must be authorised by Macrovision Corporation, is intended for home and other limited viewing uses only unless otherwise authorised by Macrovision Corporation. Reverse engineering or disassembly is prohibited.

Protection

This DVD Recorder can allow you to protect the contents of your discs, as described below.

- Programme-protected: See page 71 "Locking(Protecting) a Title"
- Disc-protected: See page 83 "Disc Protection"

- * DVD-RAM/DVD-RW/DVD-R discs that are incompatible with the DVD-VIDEO format cannot be played with this product.
- * For more information on DVD recording compatibility, consult your DVD-RAM/DVD-RW/DVD-R manufacturer.

- * Use of poor quality DVD-RAM/DVD-RW/DVD-R discs may cause following unexpected problems including, without limitation, recording failure, loss of recorded or edited materials or damage to the recorder.

Do not use the following discs!

- LD, CD-G, CD-I, CD-ROM, DVD-ROM, DVD+R and DVD+RW discs should not be used in this product.
[Note]
Disc types that can be played : CD/CD-R/CD-RW/MP3/JPEG/DVD-Video/DVD-RAM/DVD-RW/DVD-R. For a DVD-R/DVD-RW disc, which has been recorded in Video Mode on another component, it can play only when finalised.
- Some commercial discs and DVD discs purchased outside your region may not be playable with this product. When these discs are played, either "No disc." or "Please check the regional code." will be displayed.
- If your DVD-RW disc is an illegal copy or is not in DVD video format, it may also not be playable.

- * We recommend using one of the discs in the table as they have been confirmed to be compatible with this unit. Other discs may not perform correctly.

Media	Disc	SPEED
DVD-R	TDK	4x
	Beall	4x
	That's	4x
	Maxell	4x
	Panasonic	4x
DVD-RW	TDK	2x
	Maxell	2x
	Optodisc	2x
	Radius	2x
DVD-RAM	Verbatim	2x
	Maxell	3x
	Fujifilm	3x
	TDK	2x
	Panasonic	3x

Disc	Maximum no. of recordings by disc type
DVD-RAM	100,000
DVD-RW	1,000
DVD-R	1

- We take no responsibility and offer no compensation for any recording failure, loss of recorded or edited material and/or damage to the recorder arising from usage of unrecommended discs.

Contents



Getting Started

Warning	2
Precaution	3
Important Safety Instructions.....	3
Handling Cautions.....	3
Maintenance of Cabinet.....	3
Disc Handling	3
Disc Storage	4
Disc Specifications	4
General Features	8
Before reading the user's manual	9
How to use the DVD Recorder	9
Unpacking	11
Accessories.....	11
Preparing the Remote Control.....	11
Setting the Remote Control	11
Description	13
Front Panel.....	13
Front Panel Display.....	13
Rear Panel.....	14
Tour of the Remote Control.....	15
Connecting & Setting Up	
<hr/>	
Quick Overview	16
Connecting the DVD-Recorder	17
Additional connections	17
Other type of connecting the Video output cable ...	18
Case 1 : Connecting to a Video (Composite) output jack.....	18
Case 2 : Connecting to an S-Video output jack.....	19
Case 3 : Component Video output jacks.....	19
Other type of connecting the Audio output cable ..	20
Case 1 : Connecting to your TV.....	20

Case 2 : Connecting to a stereo amplifier with AV output jacks.....	20
Case 3: Connecting to an AV amplifier with a digital output jack	20

Connecting HDMI/DVI to a TV.....21

Case 1 : Connecting to a TV with HDMI Jack	21
Case 2 : Connecting to a TV with DVI Jack	21

Connecting to AV 3 IN, DV input jack.....22

Case 1 : Connecting a VCR, Set-Top Box(STB), DVD recorder or Camcorder to the AV 3 IN jacks ...	22
Case 2 : Connecting a Camcorder to the DV IN jack ...	22

System Setup

On-Screen Menu Navigation.....23

Plug & Auto Setup

Setting the Clock.....25

Presetting Channels with the Auto Setup function.....26

Presetting Channels with the Manual Setup function

Setting up the Language Options.....28

EP Mode Time Setting.....29

Automatic Chapter Creation

Setting up the Front Display Options.....31

Setting up NICAM Options

DivX(R) Registration.....32

Setting up the Audio Options

Audio Options.....	33
--------------------	----

Setting up Video Output Options.....33

Setting up the Progressive scan.....34

Canceling the Progressive scan

Setting up the Display(Video) Options.....35

Display(Video) Options	36
------------------------------	----

Output selection	36
------------------------	----

Setting up the Parental Control.....37

If you forgot your password.....	37
----------------------------------	----

About the Rating Level	38
------------------------------	----

About the Change Password	38
---------------------------------	----

Recording

Before Recording	39
Recordable discs.....	39
Recording Formats	40
Recording Mode.....	40
Unrecordable video.....	40
About INFO Key.....	41
Checking the available disc space (Disc Information)...	41
Recording the current TV programme you are watching	41
Recording from external equipment you are watching	43
Copying from a Camcorder	44
Making a One Touch Recording (OTR)	45
Making a Timer Recording	46
Flexible Recording (for Timer recording only) ..	47
Editing the Scheduled Record List	47
Deleting the Scheduled Record List	48
Using the Video Plus+ Feature	49
Video Plus+ Extended	50
Recording the Standard Timer List	50

Playback

Before Playing	51
Region code (DVD-Video only).....	51
Disc types that can be played	51
Discs that cannot be played	51
Playing a Disc	52
Using the Disc & Title Menu	53
Using the Search Functions	53
Slow Motion Play.....	54
Step Motion Play.....	54
About ANYKEY	54
Using the Repeat Function.....	55
Selecting the Subtitle	57
Selecting the Audio language.....	58
Changing the Camera Angle.....	58

Zooming-In.....	59
Using Bookmarks	59
Using Markers	60
Playing an Audio CD/MP3	61
Playing an Audio CD (CD-DA)/MP3	61
Playing a Picture	65
Playing an MPEG4	66
Playing the Title List	67

Editing

Basic Editing (Title List)	70
Renaming(Labeling) a Title.....	70
Locking(Protecting) a Title	71
Deleting a Title	71
Deleting a Section of a Title	72
Advanced Editing (Playlist)	74
Creating a Playlist	74
Playing Entries in the Playlist	75
Renaming a Playlist Entry	76
Editing a Scene for the Playlist	77
Copying a Playlist Entry to the Playlist	80
Deleting a Playlist Entry from the Playlist.....	81
Disc Manager	82
Editing the Disc Name	82
Disc Protection	83
Formatting a Disc	83
Delete All Title Lists	84
Finalising a disc.....	85
Unfinalising a disc (V/VR mode)	86

Additional Information

Troubleshooting	87
Specifications	91

General Features



The DVD Recorder allows you to record and play high quality digital video on DVD-RAM/DVD-RW/DVD-R discs. You can record and edit digital images on DVD-RAM/DVD-RW/DVD-R discs as if they were VCR tapes.

High quality digital audio and video recording and playback

Record up to 16-hours of video with a double sided 9.4 GB DVD-RAM disc, up to 8-hours of images with a 4.7 GB DVD-RAM/DVD-RW/DVD-R disc, depending on the recording mode.

Selectable Recording Mode

You can set your recorder to one of four different recording speeds, each varying in recording quality and length. EP(6Hr or 8Hr) mode yields the most recording time, LP & SP modes provide less recording time with higher quality recording, XP mode gives you the highest quality recording.

Automated Quality Adjustment for Timer Recording

If FR mode is selected, the video quality is adjusted automatically so that all video for the scheduled time can be recorded onto the free disc space. (See page 47.)

Creating a DVD video title using DVD-RW/DVD-R disc

With the DVD Recorder, you can create your own DVD Video titles on 4.7 GB DVD-RW/DVD-R discs.

Copying data from a digital camcorder using a DV input jack

Record DV Device video onto DVD-RAM or DVD-RW, DVD-R discs using the DV input jack (IEEE 1394-4pin/4pin). (See page 44.)

High quality progressive scan

Progressive scanning provides high resolution and flicker free video. The 10-bit 54-MHz DAC and 2D Y/C Separating Circuitry provides the highest image playback and recording quality. (See pages 19, 34~35)

A variety of functions with an easy-to-use user interface

The integrated menu system and the messaging function allow you to perform desired operations both easily and conveniently. With a DVD-RAM or DVD-RW disc, you can edit recorded video, create a playlist, edit video in a specific sequence according to your requirements.

MPEG4 playback

This DVD Recorder can play MPEG4 formats within an avi file.

DivX Certification

DivX, DivX Certified, and associated logos are trademarks of DivXNetworks Inc. and are used under license.















HDMI (High Definition Multimedia Interface)

HDMI reduces picture noise by allowing a pure digital video/audio signal path from the DVD recorder to your TV.

Before reading the user's manual

Make sure to check the following terms before reading the user's manual.

Icons that will be used in manual

Icon	Term	Definition
	DVD	This involves a function available in DVD or DVD-R/DVD-RW discs that have been recorded and finalised in Video Mode.
	RAM	This involves a function available in DVD-RAM.
	RW	This involves a function available in DVD-RW.
	R	This involves a function available in DVD-R.
	CD	This involves a function available in a data CD (CD-R or CD-RW).
	JPEG	This involves a function available in CD-R/-RW or DVD-R/-RW/-RAM discs.
	MP3	This involves a function available in CD-R/-RW or DVD-R/-RW/-RAM discs.
	MPEG4	This involves a function available in CD-R/-RW or DVD-R/-RW/-RAM discs.
	Caution	This involves a case where a function does not operate or settings may be cancelled.
	NOTE	This involves tips or instructions on the page that help each function operate.
	One-Touch button	A function that can be operated by using only one button.
	ANYKEY button	A function that can be operated by using ANYKEY button.

About the use of this user's manual

- 1) Be sure to be familiar with Safety Instructions before using this product. (See pages 2-5)
- 2) If a problem occurs, check for Troubleshooting. (See pages 87-90)

Copyright

©2005 Samsung Electronics Co.
All rights reserved; No part or whole of this user's manual may be reproduced or copied without the prior written permission of Samsung Electronics Co.

How to use the DVD Recorder

Step 1 Select the disc type

This unit can record on the following types of discs. If you want to repeatedly record on the same disc or you want to edit the disc after recording, select a rewritable DVD-RW or DVD-RAM type disc. If you want to save recording without any change, choose a non-rewritable DVD-R.



Step 2 Format the disc to start recording

Unlike a VCR, the recorder automatically starts formatting when an unused disc is inserted. This is required for the preparation of recording on a disc.

Using a DVD-RAM

This type of disc can be formatted in DVD-Video Recording format (VR mode). You can edit recorded image and create a playlist and edit images in a specific sequence according to your requirements.

Using a DVD-RW

This type of disc can be formatted in either DVD-Video format (Video mode) or DVD-Video Recording format (VR mode). For an unused disc, a message that asks whether to format in VR Mode or not is displayed. You can play a Video mode disc on various DVD components. A VR mode disc allows more varied editing.

Using a DVD-R

This type of disc can be formatted in DVD Video format. After formatting is complete, you can record on the disc. You can play this type of discs on various DVD components only when they have been finalised.



NOTE

- You can only use either the VR or Video mode on a DVD-RW, but not both at the same time.
- You can change the DVD-RW format to another format by reinitializing. It should be noted that the disc's data will be lost when changing formats.

Step 3 Recording

There are two different recording methods, Direct Recording and Timer Recording. Timer recording is classified as a Date : Once(dd/mm(MON)), Every Day, MON-SAT, MON-FRI, Every SAT, etc.
Recording mode : XP (high quality mode), SP (standard quality mode), LP (long recording mode), and EP (extended mode) according to the recording mode. When recording is set in the FR mode, the best quality picture is recorded with regards to the remaining time on the disc.



Step 4 Playing

You can select the title you want to play in a displayed menu and then immediately start playback.
A DVD consists of sections called titles, and sub sections called chapters.
During recording, a title is created between two points where you start and stop recording. Chapters will be created automatically when you finalise recording on DVD-R / DVD-RW discs in Video mode.
The chapter's length (interval between chapters) varies according to the recording mode.



Step 5 Editing a recorded disc

Editing on discs is easier than conventional video tapes. The recorder supports many different edit functions, possible only with DVDs.

With a simple and easy edit menu, you can operate various edit functions, such as delete, copy, rename, lock, etc., on a recorded title.

Creating a playlist (DVD-RAM/-RW in VR mode)

With this recorder, you can create a new playlist on the same disc and edit it without the change of the original recording.



Step 6 Finalising & Playing on other DVD components

To play your DVD on other DVD components, finalising may be necessary. First, finish all editing and recording operations, then finalise the disc.

When using a DVD-RW disc in VR Mode

Although finalising is generally unnecessary when playing the disc on a VR Mode compatible component, a finalised disc should be used for playback.

When using a DVD-RW disc in Video Mode

The disc should be finalised first to enable playback on anything other than this recorder. No more editing or recording can be made on the disc once it has been finalised.

When using a DVD-R disc

You should finalise the disc to play it on a component other than this recorder. You cannot edit or record on the disc once it has been finalised.

Unpacking

Accessories

Check for the supplied accessories below.

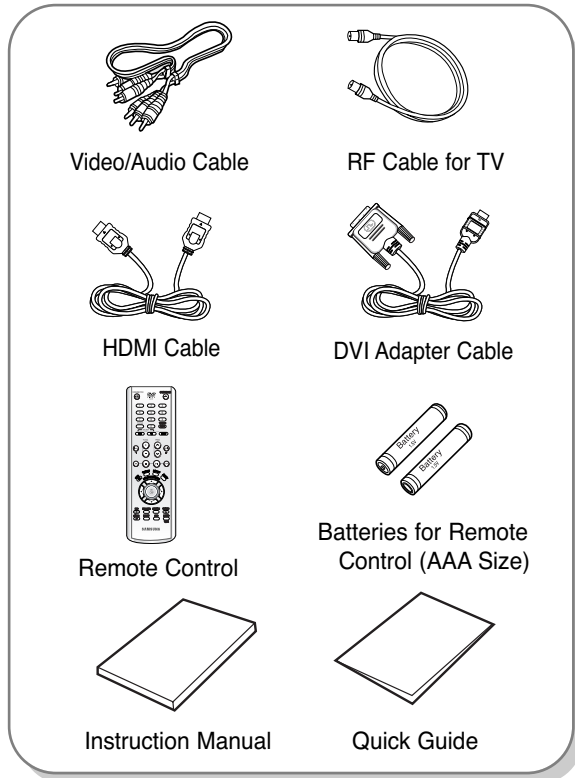

Setting the Remote Control

You can control certain functions of another manufacturer's TV with this remote control. Control function buttons involve: STANDBY/ON, PROG \wedge / \vee , TV VOL \pm -, Direct Number buttons, TV MUTE, INPUT button.



Preparing the Remote Control

Install Batteries in the Remote Control

- Open the battery cover on the back of the remote control.
- Insert two AAA batteries. Make sure that the polarities (+ and -) are aligned correctly.
- Replace the battery cover.

If the remote does not operate properly:

- Check the polarity + - of the batteries (Dry-Cell)
- Check if the batteries are drained.
- Check if remote sensor is blocked by obstacles.
- Check if there is any fluorescent lighting nearby.

Dispose of batteries according to local environmental regulations. Do not put them in the household trash.

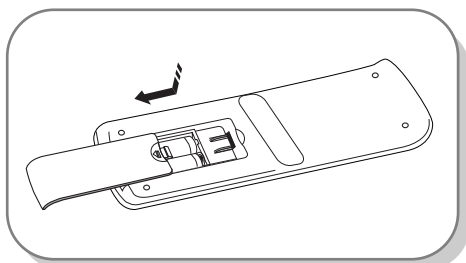

To determine whether your television is compatible, follow the instructions below.

1. Switch your television on.
2. Point the remote control towards the television.
3. Press and hold the **STANDBY/ON** button and enter the two-figure code corresponding to the brand of your television, by pressing the appropriate number buttons.

Controllable TV Codes

BRAND	BUTTON
SAMSUNG	01, 02, 03, 04, 05, 06, 07, 08, 09
AIWA	82
ANAM	10, 11, 12, 13, 14, 15, 16, 17, 18
BANG & OLUFSEN	57
BLAUPUNKT	71
BRANDT	73
BRIONVEGA	57
CGE	52
CONTINENTAL EDISON	75
DAEWOO	19, 20, 23, 24, 25, 26, 27, 28, 29, 30, 31, 32, 33, 34
EMERSON	64
FERGUSON	73
FINLUX	06, 49, 57
FORMENTI	57
FUJITSU	84
GRADIENTE	70
GRUNDIG	49, 52, 71
HITACHI	60, 72, 73, 75
IMPERIAL	52
JVC	61, 79
LG	06, 19, 20, 21, 22, 78
LOEWE	06, 69
LOEWE OPTA	06, 57
MAGNAVOX	40
METZ	57
mitsubishi	06, 48, 62, 65
MIVAR	52, 77
NEC	83
NEWSAN	68
NOBLEX	66
NOKIA	74
NORDMENDE	72, 73, 75
PANASONIC	53, 54, 74, 75
PHILIPS	06, 55, 56, 57
PHONOLA	06, 56, 57
PIONEER	58, 59, 73, 74
RADIOLA	06, 56
RADIOMARELLI	57
RCA	45, 46
REX	74
SABA	57, 72, 73, 74, 75
SALORA	74
SANYO	41, 42, 43, 44, 48
SCHNEIDER	06

BRAND	BUTTON
SELECO	74
SHARP	36, 37, 38, 39, 48
SIEMENS	71
SINGER	57
SINUDYNE	57
SONY	35, 48
TELEAVA	73
TELEFUNKEN	67, 73, 75, 76
THOMSON	72, 73, 75
THOMSON ASIA	80, 81
TOSHIBA	47, 48, 49, 50, 51, 52
WEGA	57
YOKO	06
ZENITH	63

Result: If your television is compatible with the remote control, it will switch off.

It is now programmed to operate with the remote control.



NOTE

- If several codes are indicated for your television brand, try each one in turn until you find one that works.
- If you replace the remote control's batteries, you must set the brand code again.

Then you can control the television using the following buttons after the TV button.

Button	Function
STANDBY/ON	Used to switch the television on and off.
INPUT	Used to select an external source.
TV VOL (+ or -)	Used to adjust the volume of the television.
PROG (^ or v)	Used to select the desired channel.
TV MUTE	Used to toggle the sound on and off.
0~9	Used to input number directly.



NOTE

- The various functions will not necessarily work on all televisions. If you encounter problems, operate the television directly.

Description

Front Panel

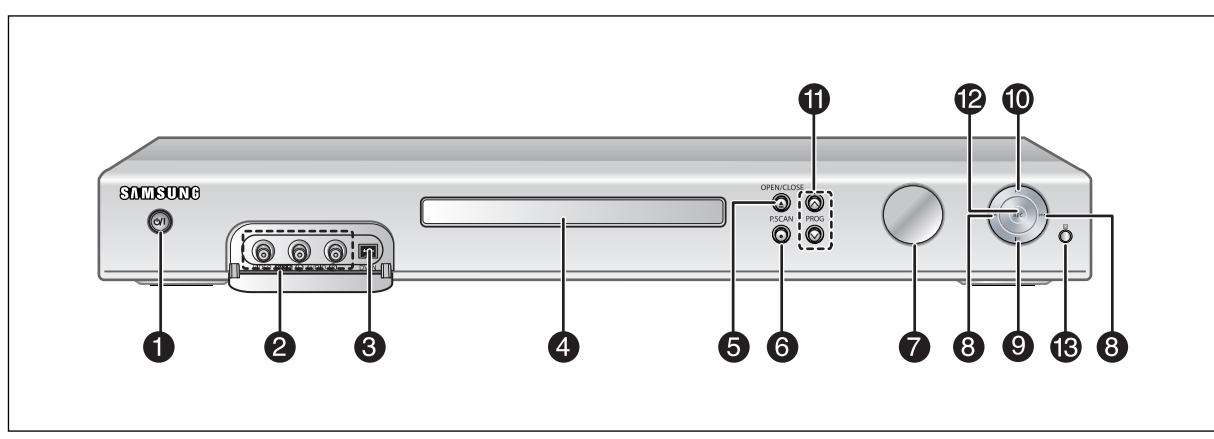

- | | |
|---|--|
| <ol style="list-style-type: none"> 1. STANDBY/ON
Turns the recorder on and off. 2. AV3 INPUT
Connect external equipment. 3. DV-INPUT
Connect external digital equipment with a DV jack. (such as a camcorder) 4. DISC TRAY
Opens to accept a disc. 5. OPEN/CLOSE
Opens and closes the disc tray. 6. P.SCAN
Selects the progressive scan mode. | <ol style="list-style-type: none"> 7. DISPLAY
Displays the playing status, title/ chapter/ time, etc. 8. SEARCH/SKIP
Goes to the next title/chapter/track or goes back to the previous title/chapter/track. 9. STOP
Stops disc playback. 10. PLAY/PAUSE
Plays a disc or pauses playback or recording. 11. PROG (^v)
Select TV preset Channels.
Same as PROG button on the remote control. 12. REC
Starts recording. 13. Remote Control Receiver |
|---|--|

Front Panel Display

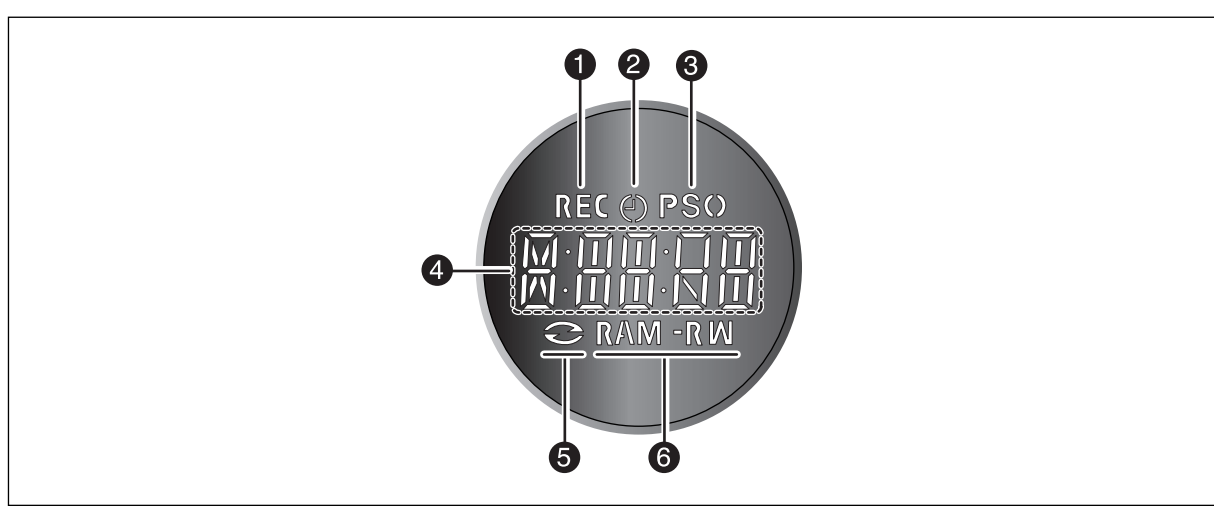

- | | |
|--|---|
| <ol style="list-style-type: none"> 1. Lights in the record mode. 2. Lights to indicate the timer record mode. 3. Lights in the progressive scan mode. | <ol style="list-style-type: none"> 4. Playing time/clock/current status indicator. 5. Lights when a disc is loaded. 6. Lights when a -R/RW/RAM disc is loaded. |
|--|---|

Rear Panel

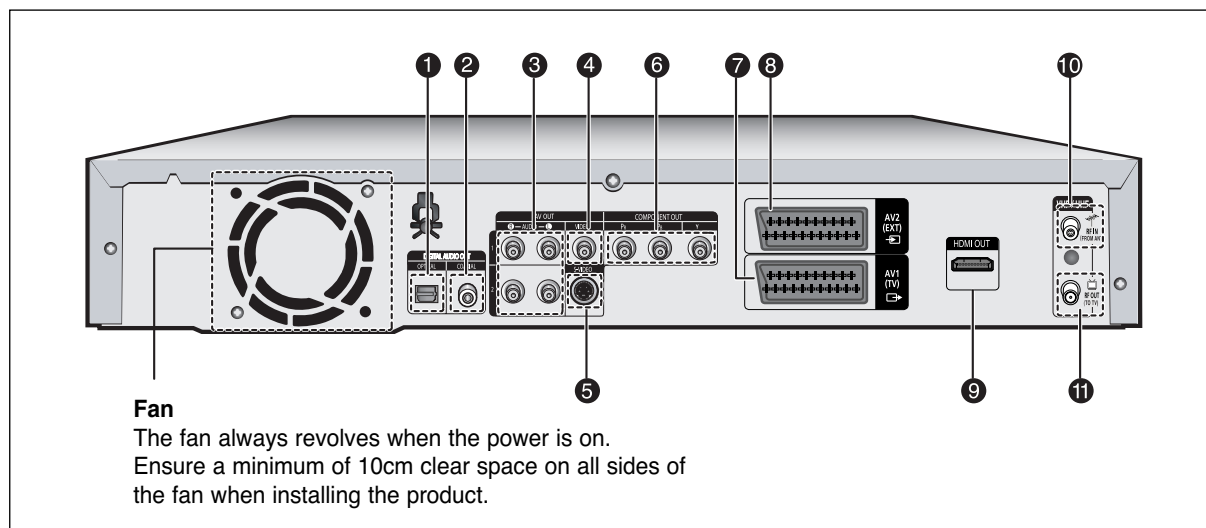

1. DIGITAL AUDIO OUT(OPTICAL)

Connects to an amplifier having a digital optical audio input jack.

2. DIGITAL AUDIO OUT(COAXIAL)

Connects to an amplifier having a digital coaxial audio input jack.

3. AUDIO OUT

Connects to the audio input of external equipment using audio cables.

4. VIDEO OUT

Connects the input of external equipment using a Video cable.

5. S-VIDEO OUT

Connects the input of external equipment using an S-Video cable.

6. COMPONENT VIDEO OUT

Connects to equipment having Component video output.

7. AV1(TV) OUTPUT SCART Connector

8. AV2(EXT) INPUT SCART Connector

9. HDMI OUT

10. In from aerial connector

11. Out to TV connector



NOTE

- The Antenna connection does not pass output signal of DVD. To watch a DVD on your TV, you must connect audio/video or Scart cables.

Tour of the Remote Control

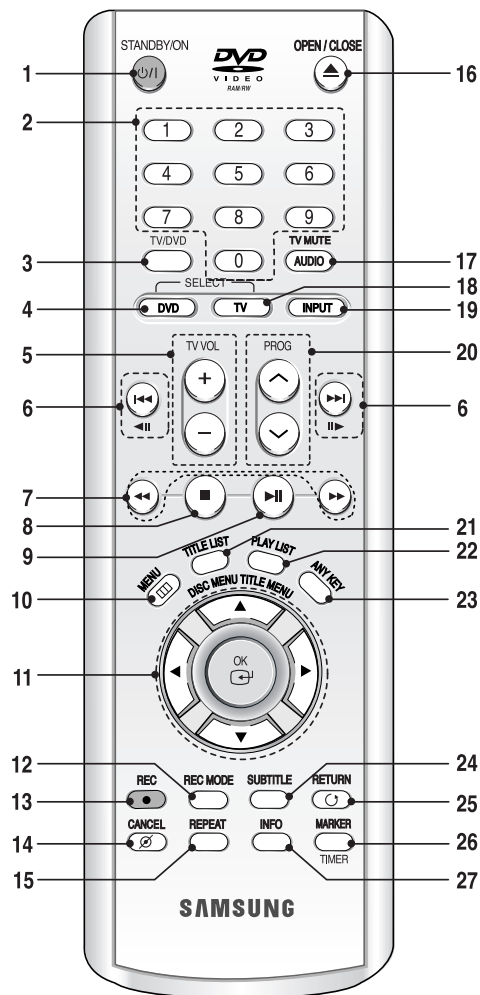

1. **STANDBY/ON Button**
2. **Number Buttons**
3. **TV/DVD Button**
4. **DVD Button**
Press this when you use a DVD Recorder.
5. **TV VOL Buttons**
TV volume adjustment.
6. **Reverse/Forward Skip Buttons**
Press to skip a disc backwards or forwards. These buttons also function as **STEP** buttons. Each press will play one-frame forward or reverse (see page 54).
7. **Reverse/Forward Search Buttons**
Press to search a disc backwards or forwards.
8. **Stop Button**
Press to stop a disc.
9. **Play/Pause Button**
Press to play/pause a disc.

10. **MENU Button**
Brings up the DVD recorder's setup menu.
11. **OK/DIRECTION Buttons (▲▼◀▶ Buttons)**
12. **REC MODE Button**
This will display the recording status.(XP/SP/LP/EP)
13. **REC Button**
Use to make a recording on DVD-RAM/-RW/-R discs.
14. **CANCEL Button**
15. **REPEAT Button**
Allows you to repeat a title, chapter, track or disc.
16. **OPEN/CLOSE Button**
To open and close the disc tray.
17. **AUDIO/TV MUTE Button**
Use this to access various audio functions on a disc.(DVD mode)
This operates as Sound Mute. (TV mode)
18. **TV Button**
Press this to operate TV.
19. **INPUT Button**
Select line input signal in external input mode (PROG, AV input or DV INPUT)
20. **PROG Button**
Select preset channels in a specific order. Same as **PROG** buttons in front panel.
21. **TITLE LIST/DISC MENU Button**
Use this to enter the View Recording list/Disc menu.
22. **PLAY LIST/TITLE MENU Button**
Use this to return to the Title menu, or to view the recorded files list.
23. **ANYKEY Button**
Use this to view the status of the disc that is being played.
24. **SUBTITLE Button**
Press this to switch the DVD's subtitle language.
25. **RETURN Button**
Returns to a previous menu.
26. **MARKER/TIMER Button**
Use this to bookmark a position while playing a disc.
Press to directly enter the Timer Recording Mode menu while stopping a disc.
27. **INFO Button**
This will display current settings or disc status.

Connecting & Setting Up

This section involves various methods of connecting the DVD Recorder to other external components and required initial setting modes.

Quick Overview.....	16
Connecting the DVD-Recorder	17
Additional connections	17
Other type of connecting the Video output cable.....	18
Other type of connecting the Audio output cable....	20
Connecting to HDMI/DVI to a TV	21
Connecting to AV3 IN, DV input jack.....	22

Quick Overview

A Quick Overview presented in this guide will give you enough information to start using the recorder.

Connecting the DVD-Recorder



Additional connections



Other type of connecting the Video output cable



Other type of connecting the Audio output cable



Connecting to HDMI/DVI to a TV



Connecting to AV3 IN, DV input jack

Connecting the DVD-Recorder

You can connect your DVD Recorder to the television using the SCART cable if the appropriate input is available on the television.

1. Connect the RF cable as shown.
2. Connect one end of the SCART cable to the AV1 socket on the rear of the DVD Recorder.
3. Plug the other end into the appropriate connector on the television.
4. Plug in the DVD Recorder and TV
5. Turn on the DVD Recorder and TV.
6. Press the **INPUT** button on your TV remote control until the Video signal from the DVD Recorder appears on the TV screen.

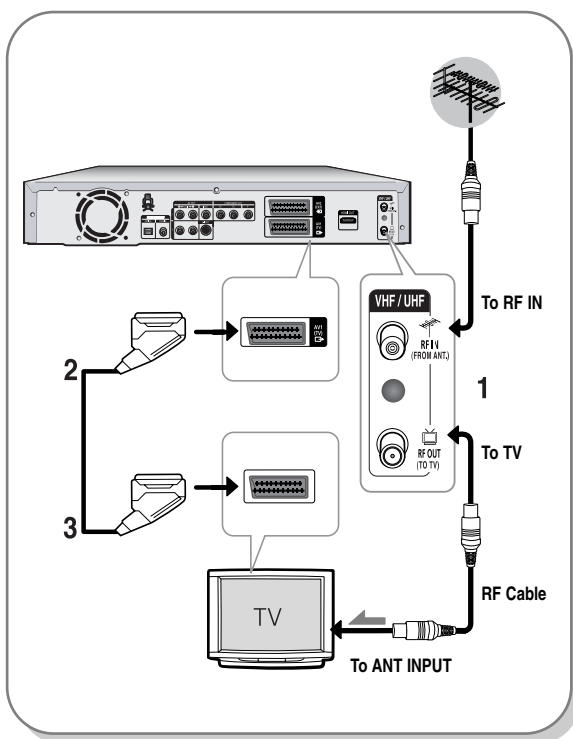

NOTE

- The RF cable connection of this product sends only signals of TV. You must connect SCART cable or Audio/Video cables to watch a DVD from your DVD Recorder.
- TV mode
Press the **TV/DVD** button on remote control, then "TV" appear on Front LED display (or turn off DVD Recorder). Then you can watch programmes received through RF cable.

Additional connections

You can connect your DVD Recorder to a satellite or digital tuner.

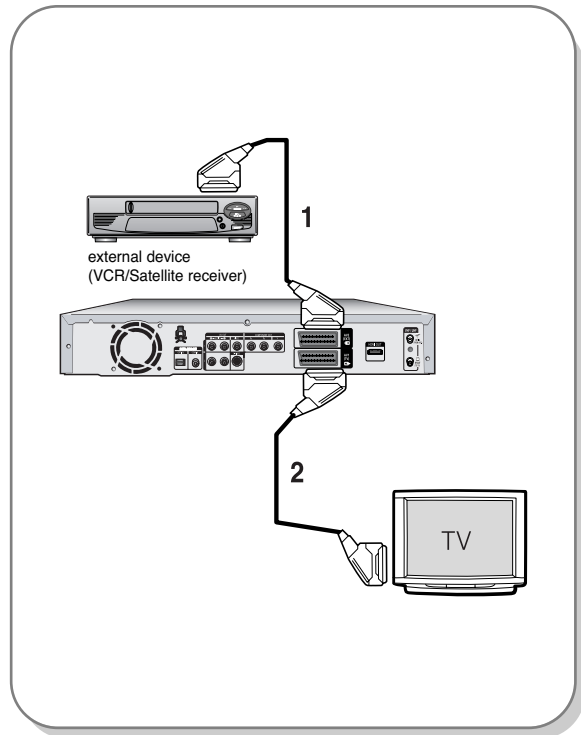

- DVD mode

1. Connect the AV2 connector of DVD Recorder and VCR/Satellite receiver or digital tuner using a SCART cable.
2. Connect the AV1 connector to the SCART AV connector on TV.
3. Turn on the DVD Recorder, VCR/Satellite receiver or digital tuner and TV.
4. Set Input mode on AV2.

- TV mode

1. Press the **TV/DVD** button on remote control, then "TV" appear on Front LED display. (or turn off DVD Recorder.)
2. You can watch programmes from a satellite or digital tuner connected to this DVD Recorder, even when the DVD Recorder is turned off.

Other type of connecting the Video output cable

There are several ways to output video signal not using scart cables. Select one of the following video connecting that best suits you below.

- **Case 1** : Connecting to a Video (Composite) output jack
- **Case 2** : Connecting to an S-Video output jack
- **Case 3** : Component Video output jacks

S-Video, Component video and Progressive Output Modes

- S-Video and Component video output are available only if your TV supports S-Video input or Component video input, respectively. If S-Video or Component video output does not work, check the TV connections and the TV input selection settings.
- Compared to standard interlaced video, progressive scan doubles the amount of video lines fed to your TV, resulting in a more stable, flicker-free, clear image than interlaced video.
This is only available with TVs that support progressive scan.
- Progressive Scan Output (576p)
Consumers should note that not all high definition television sets are fully compatible with this product and may cause artifacts to be displayed in the picture, in case of 576 progressive scan picture problems, It is recommended that the user switch the connection to the 'standard definition' output. If there are questions regarding our TV set compatibility with this model 576p DVD Recorder, please contact our customer service centre.

Case 1 : Connecting to a Video (Composite) output jack

1. Connect a video(yellow) cable between the VIDEO (yellow) OUT jack on DVD Recorder and VIDEO (yellow) INPUT jack on your TV (or AV amplifier).
 - You will enjoy regular quality images.
2. Connect audio cables (white and red) between the AUDIO OUT jacks on the DVD Recorder and AUDIO IN jacks on TV (or AV amplifier).

(See page 20)

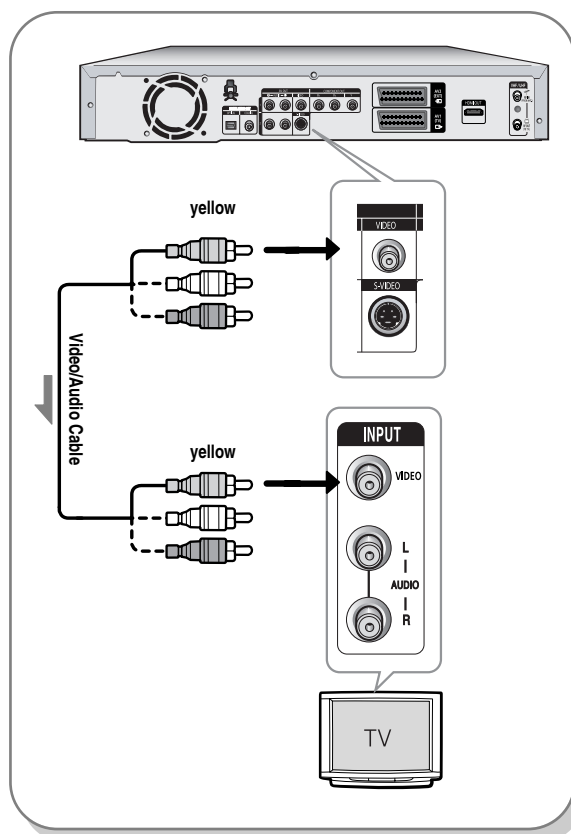

Case 2 : Connecting to an S-Video output jack

1. Connect an S-Video cable (not included) between the S-VIDEO OUT jack on DVD Recorder and S-VIDEO INPUT jack on your TV (or AV amplifier).
2. Connect audio cables (white and red) between the AV AUDIO OUT jacks on DVD Recorder and AUDIO IN jacks on TV (or AV amplifier).
 - You will enjoy high quality images.

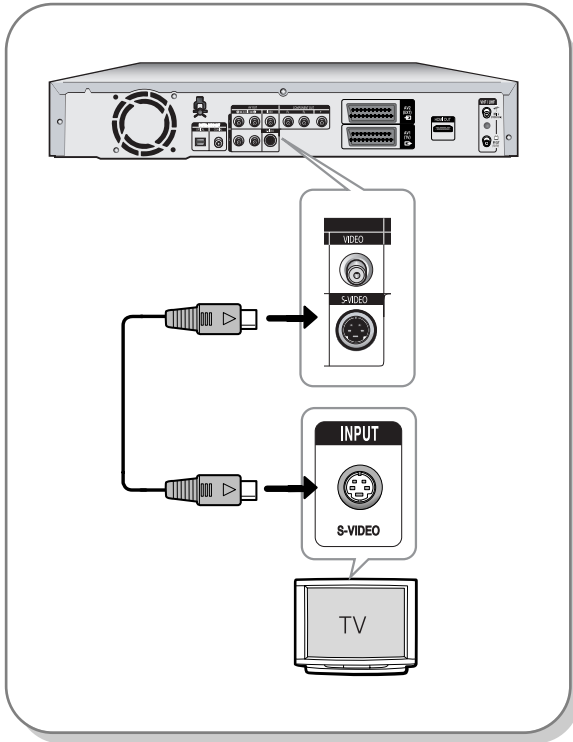

Case 3 : Component Video output jacks

1. Connect Component video cables(not supplied) between the COMPONENT OUT(Y,P_B,P_R) jacks on DVD Recorder and COMPONENT IN(Y,P_B,P_R) jacks on your TV.
2. Connect audio cables (white and red) between the AUDIO OUT jacks on the DVD Recorder and AUDIO IN jacks on TV (or AV amplifier). (See pages 20).
 - Press the input selection on your TV remote control until the Component signal from the DVD Recorder appears on your TV screen.
3. After connecting, refer to the page 33 to 35.
 - You will enjoy high quality and accurate colour reproduction images.

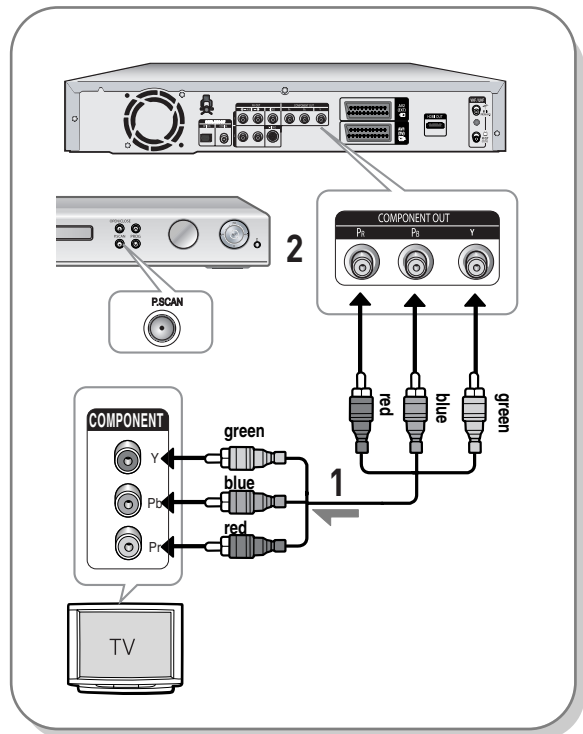

- The Component jacks will not output video resolutions above 576p. To view 720p and 1080i connect the DVD Recorder to your TV with the supplied HDMI cable. With HDMI connected, press the **P.SCAN** button to alternate between all available resolutions. (See page 34)



- Make sure that the colour coded connections match. The Y, P_B, P_R component output jacks of your DVD Recorder must be connected to the exact corresponding component input jacks on your TV.
- Progressive setting is only available when the Video Out is set to Component. (See pages 34~35)

Other type of connecting the Audio output cable

There are several ways to output audio signal not using scart cables. Select the audio connection that best suits you below.

- **Case 1** : Connecting to your TV
- **Case 2** : Connecting to a stereo amplifier with AV output jacks
- **Case 3** : Connecting to an AV amplifier with a digital output jack

Manufactured under license from Dolby Laboratories. "Dolby" and the double-D symbol are trademarks of Dolby Laboratories.

"DTS" and "DTS Digital Out" are trademarks of Digital Theatre Systems, Inc.

Case 1 : Connecting to your TV

If your TV has audio input jacks, use this connection.

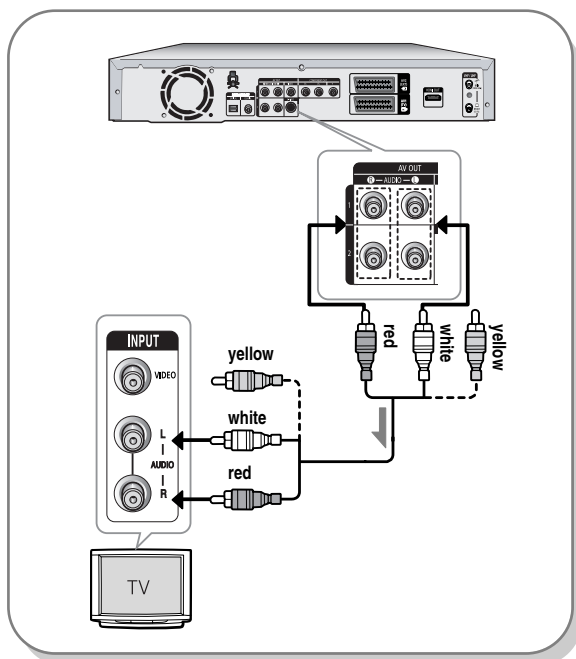

Case 2 : Connecting to a stereo amplifier with AV output jacks

If your stereo amplifier only has AUDIO INPUT jacks(L and R), use the AUDIO OUT jacks.

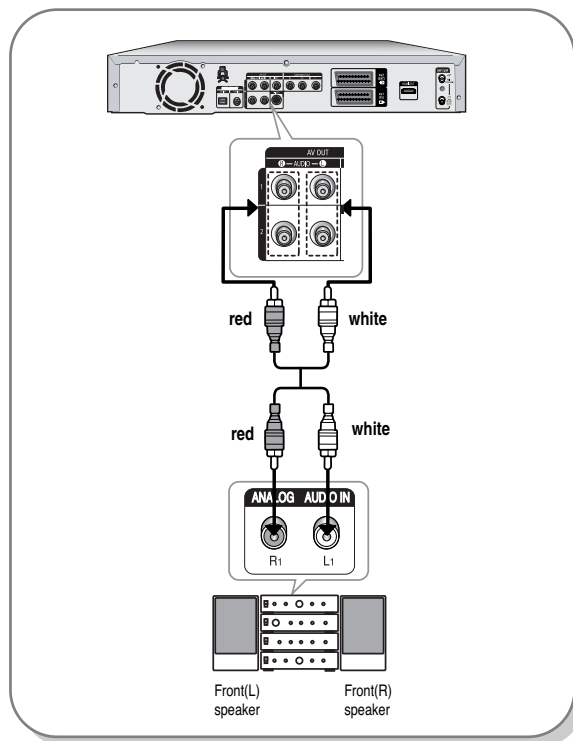

Case 3: Connecting to an AV amplifier with a digital output jack

If your AV amplifier has a Dolby Digital, MPEG2 or DTS decoder and a digital input jack, use this connection. To enjoy Dolby Digital, MPEG2 or DTS sound, you will need to set up the audio settings. (See page 33)

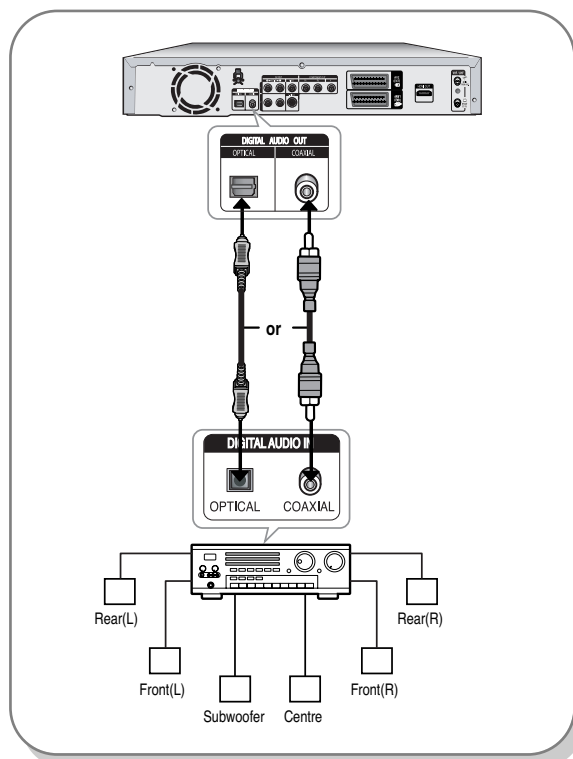

Connecting HDMI/DVI to a TV

If your TV has a HDMI/DVI input, connect HDMI/DVI Adapter cable to a TV. You will enjoy the best quality images and sounds.

- **Case 1** : Connecting to a TV with HDMI Jack
- **Case 2** : Connecting to a TV with DVI Jack

Case 1 : Connecting to a TV with HDMI Jack

- Using the HDMI cable connect the **HDMI OUT** jack on the rear of the DVD Recorder to the **HDMI IN** jack of your TV.
- Press the input selector on your TV remote control until the HDMI signal from the DVD Recorder appears on your TV screen.

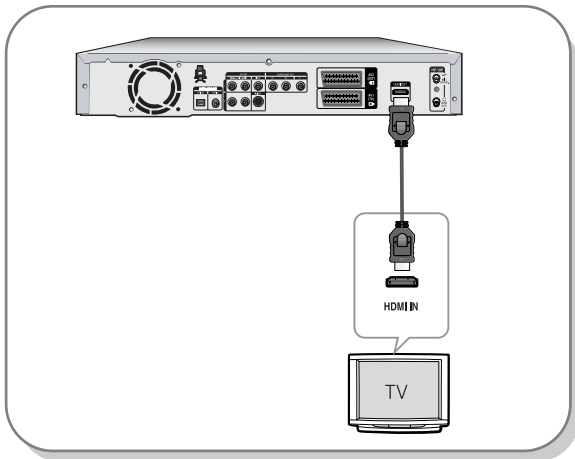

Case 2 : Connecting to a TV with DVI Jack

- Using the DVI Adapter Cable, connect the **HDMI OUT** jack on the rear of the DVD Recorder to the **DVI IN** jack of your TV.
- Using the audio cables, connect the **AUDIO (red and white) OUT** jacks on the rear of the DVD Recorder to the **AUDIO (red and white) IN** jacks of your TV. Turn on the DVD recorder and TV.
- Press the input selector on your TV remote control until the DVI signal from the DVD Recorder appears on your TV screen.



CAUTION

- To watch through the HDMI output, set the digital audio output to PCM. See page 32~33.
- Depending on the HDMI device (TV/HDMI Receiver) you use, audio may not be supported. If TV does not support Dolby digital/DTS, Audio output is not available when you set Digital output as Bitstream or select DTS On in Audio setup menu. In this case, set the digital audio output to PCM or DTS off.

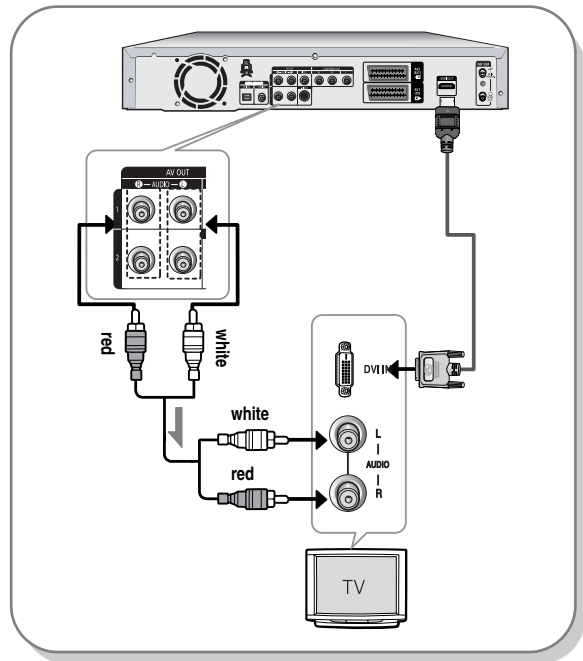

NOTE

- To change HDMI output resolution, see page 36.
- **HDMI (High Definition Multimedia Interface)**
HDMI is an interface to enable the digital transmission of video and audio data with just a single connector. Since HDMI is based on DVI, it is completely compatible with DVI. The only difference between HDMI and DVI is that HDMI supports multi-channel audio.
Using HDMI, the DVD recorder transmits a digital video and audio signal and displays a vivid picture on a TV having an HDMI input jack.
- **HDMI connection description**
HDMI connector - Both uncompressed video data and digital audio data (LPCM or Bit Stream data).
 - Though the DVD recorder uses a HDMI cable, the DVD recorder outputs only a pure digital signal to the TV.
 - If TV does not support HDCP (High-bandwidth Digital Content Protection), snow noise appears on the screen.
- **Why does Samsung use HDMI?**
Analog TVs require an analog video/audio signal. However, when playing a DVD, the data transmitted to a TV is digital. Therefore either a digital-to-analog converter (in the DVD Recorder) or an analog-to-digital converter (in the TV) is required. During this conversion, the picture quality is degraded due to noise and signal loss. HDMI technology is superior because it requires no D/A conversion and is a pure digital signal from the DVD recorder to your TV.
- **What is the HDCP?**
HDCP (High-bandwidth Digital Content Protection) is a system for protecting DVD content outputted via HDMI from being copied. It provides a secure digital link between a video source (PC, DVD, etc) and a display device (TV, projector, etc). Content is encrypted at the source device to prevent unauthorized copies from being made.

Connecting to AV3 IN, DV input jack

This allows you to connect your DVD Recorder to other external devices and view or record their outputs.

- **Case 1** : Connecting a VCR, Set-Top Box(STB), DVD recorder or Camcorder to the AV3 IN jacks
- **Case 2** : Connecting a DV Device to the DV IN jack

Case 1 : Connecting a VCR, Set-Top Box(STB), DVD recorder or Camcorder to the AV3 IN jacks

Connecting a VCR or external device to AV3 IN jacks of the DVD Recorder.

You can record from connected equipment (VCR, STB, DVD recorder or Camcorder).

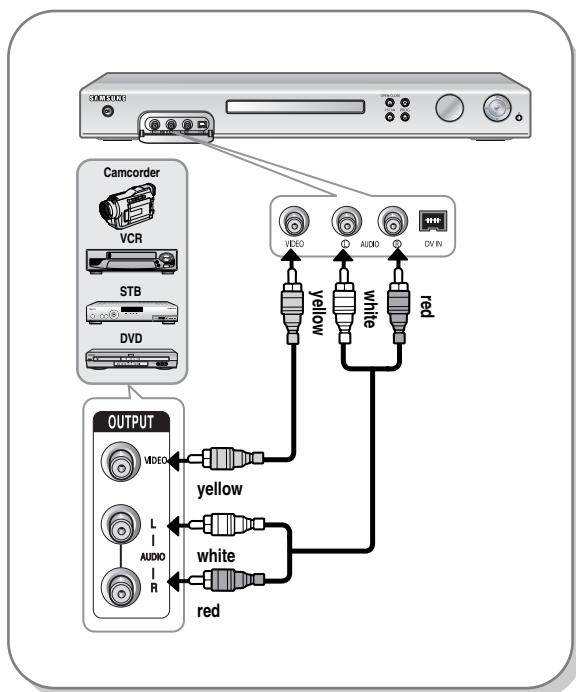

NOTE

- AV 3 in selection will be automatically done. If the input is not selected automatically, use **INPUT** button to select proper input.
- Copy protected content cannot be recorded.

Case 2 : Connecting a Camcorder to the DV IN jack

If your digital camcorder has a DV output jack, connect it to the DV input jack of your DVD Recorder.

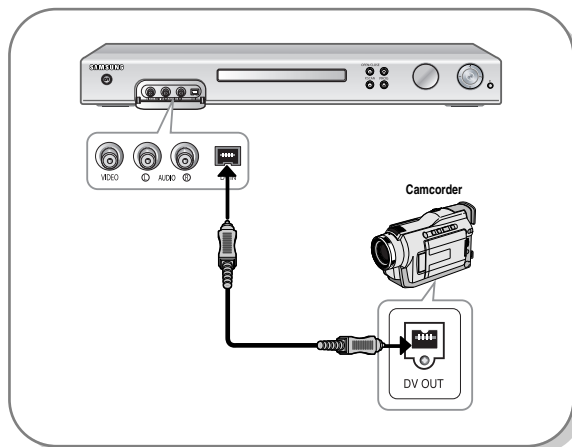

NOTE

- If the input is not selected automatically, use **INPUT** button to select proper input.

System Setup

On-Screen Menu Navigation

The on-screen menus allow you to enable or disable various functions on your DVD Recorder. Use the following buttons to open and navigate through the on-screen menus.

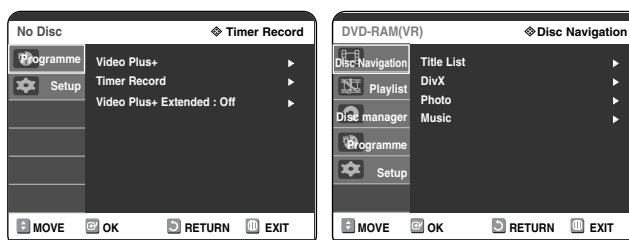

1 MENU Button

Press this button on the remote control to open the on-screen MENU.
Press again to exit the on-screen MENU.

2 ▲▼, ◀▶ Buttons

Press these buttons on remote control to move the selection bar ▲▼, ◀▶ to cycle through the menu options.

3 OK Button

Press this button on the remote control to confirm any new settings.

4 RETURN Button

Press this button on the remote control to return to the Previous MENU screen displayed or to exit the on-screen MENU.

On-Screen Menu Navigation	23
Plug & Auto Setup	24
Setting the Clock	25
Presetting Channels with the Auto Setup function	26
Presetting Channels with the Manual Setup function	27
Setting up the Language Options	28
EP Mode Time Setting	29
Automatic Chapter Creation	30
Setting up the Front Display Options	31
Setting up NICAM Options	31
DivX(R) Registration	32
Setting up the Audio Options	32
Setting up Video Output Options	33
Setting up the Progressive scan	34
Canceling the Progressive scan	35
Setting up the Display(Video) Options	35
Setting up the Parental Control	37

Plug & Auto Set up

Your DVD Recorder will automatically set itself up when it is plugged in for the first time. TV stations and clock will be stored in memory. The process takes a few minutes. Your DVD Recorder will then be ready for use.

- 1 Connect the RF cable as indicated on page 17.
(Connecting Your DVD Recorder to the TV Using the RF Cable and scart cable.)

- 2 Plug the DVD Recorder into the mains.
"AUTO" in the front panel display flickers.

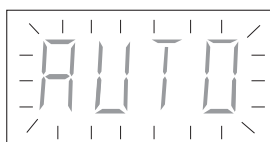

- 3 Start the auto setup.

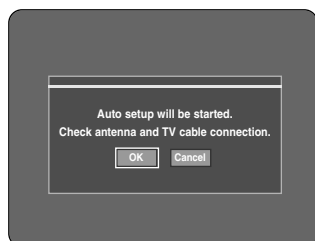

- 4 Auto Channel scan will be started.

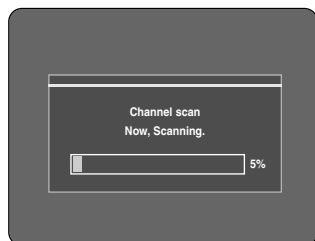

- The number of stations automatically stored by the DVD Recorder depends on the number of stations that it has found.

- 5 After Auto Channel Scan is completed, Auto Clock Setting will be started automatically in 10 seconds. If you want to start Auto Clock Setting immediately, press **OK** button. If you do not want to do Auto Clock Setting, press **CANCEL** or **MENU** button.

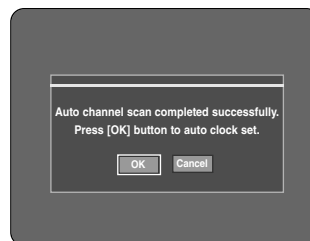

- 6 Wait until current date and time are displayed automatically. If you want to exit Auto clock setting, press **MENU** button.

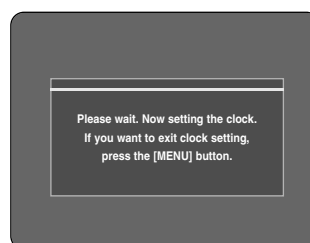

- 7 Check the date and time.

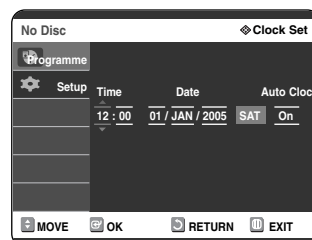

- if it is : Correct, press **OK** button then the date and time will be saved. If you don't press the **OK** button, the date and time will be saved automatically after 5 seconds.
- if it is : Incorrect, input correct Time, Date, Year using **▼▲◀▶** buttons or number buttons. Press **OK** button then the date and time will be saved. When you need to change clock setting, you can set up it manually. (see page 25)



- Now, DVD Recorder is ready for use. Function for "Plug & Auto Setup" is fixed already. So if you want to change this fixed one, you can change it by Presetting the Stations in OSD "Presetting Channels with the Manual set up function" menu. (see page 27)
- Auto Set up function can be performed by pressing **■ (STOP)** on the DVD recorder continuously for 5 seconds or more during power off with no disc inserted.

Setting the Clock

This menu is used to set the current time.
You need to set the time to use timer recording.

- 1 With the unit in Stop mode/No Disc mode, press the **MENU** button.

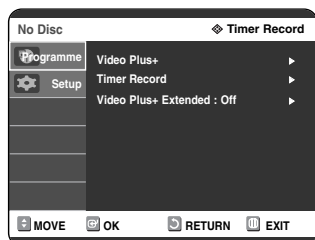

- 2 Press the **▲▼** buttons to select **Setup**, then press the **OK** or **▶** button.

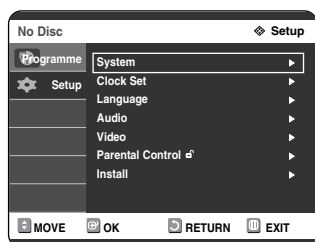

- 3 Press the **▲▼** buttons to select **Clock Set**, then press the **OK** or **▶** button.
Use navigation **▲▼◀▶** buttons to input Time, Date or Year. Use number buttons to input clock data directly. The day of the week is displayed automatically.

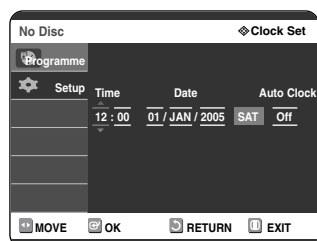

- 4 Press the **▲▼** buttons to select **On** for the Auto Clock.

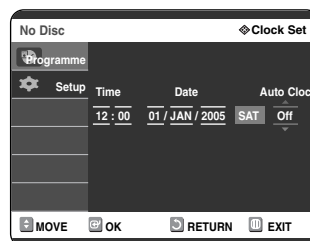

- 5 Press the **OK** button, then the date and time will be saved.
If you don't press the **OK** button, it will not be saved.



NOTE

- You must have the RF cable connected to set the Auto Clock. See page 17.
- The DVD Recorder automatically sets the clock according to the time signal broadcast between the channels PR1 to PR5. If you do not need the Auto clock set function, select Off.

Presetting Channels with the Auto Setup function

This feature allows you to manually set the DVD Recorder tuner band to Antenna or Cable, whichever you connected to the Antenna In jack during initial setup.

- 1 With the unit in Stop mode/No Disc mode, press the **MENU** button.

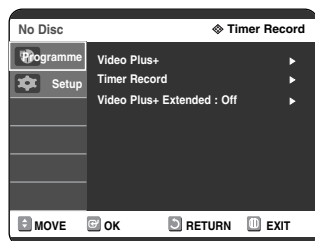

- 2 Press the **▲▼** buttons to select **Setup**, then press the **OK** or **▶** button.

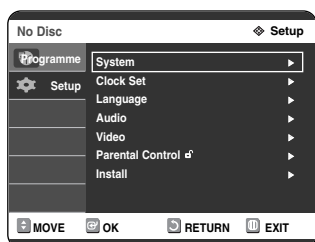

- 3 Press the **▲▼** buttons to select **Install**, then press the **OK** or **▶** button.

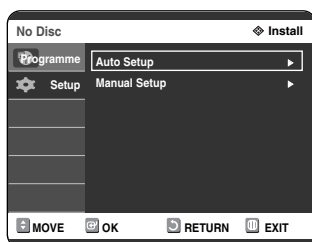

- 4 Press the **▲▼** buttons to select **Auto Setup**, then press the **OK** or **▶** button. The message "Your data will be lost. Press [OK] to continue, [MENU] to exit." is displayed.

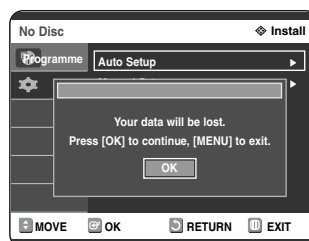

- 5 Press the **OK** button to continue. If you want to exit, press the **MENU** button.

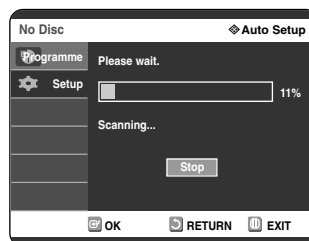

- 6 Channel scan will be started. Press the **OK** button to stop the Auto Setup.

Presetting Channels with the Manual Setup function

You can add preset channel that Auto Channel Search missed. And you can delete a channel you wish to remove. You can programme the order of channels.

1 With the unit in Stop mode/No Disc mode, press the **MENU** button.

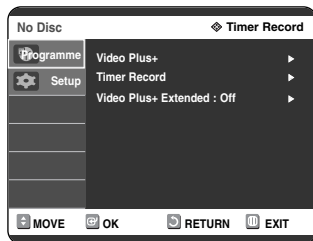

2 Press the **▲▼** buttons to select **Setup**, then press the **OK** or **▶** button.

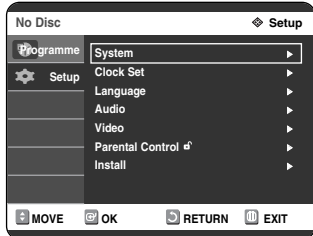

3 Press the **▲▼** buttons to select **Install**, then press the **OK** or **▶** button.

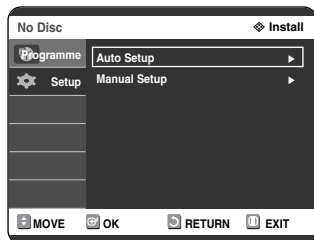

4 Press the **▲▼** buttons to select **Manual Setup**, then press the **OK** or **▶** button.

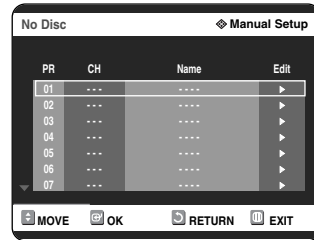

5 Press the **▲▼** buttons to select a **PR** (programme) you wish to edit, delete, or swap, then press the **OK** or **▶** button. Select **Edit**, **Delete** or **Swap**.

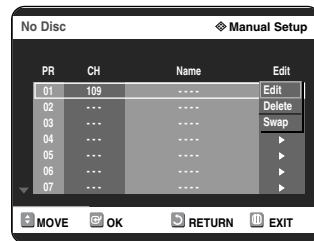

• **In case of Edit** : you can add or edit PR(programme) After change PR informations(CH, Name, Decoder, MFT), select **Save**, then press the **OK** button.

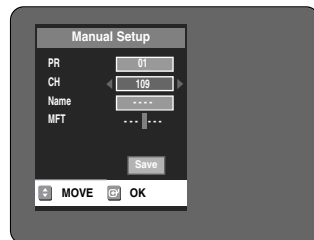

- **CH** : Tune the channel using **◀▶** buttons.
 - **Name** : Display station name automatically detected in broadcasting signal. If not detected, you can edit name by using **▲▼◀▶** buttons.
 - **MFT** : You can tune up the channel frequency better using **◀▶** buttons.

• **In case of Delete** : the channel information of selected PR(programme) will be removed.

• **In case of Swap** : You can swap the channel information of two PR(programme). For example, if you wish to swap PR2 and PR5, select swap at PR2, then press the **OK** or **▶** button at PR5.

Setting up the Language Options

If you set the audio, subtitle, disc menu, on-screen menu and DivX subtitle language in advance, they will come up automatically every time you watch a movie.

If the selected language is not recorded on the disc, the original pre-recorded language is selected.

- 1 With the unit in Stop mode/No Disc mode, press the **MENU** button.

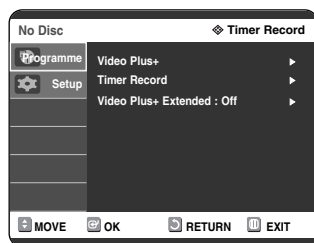

- 2 Press the **▲▼** buttons to select **Setup**, then press the **OK** or **▶** button.

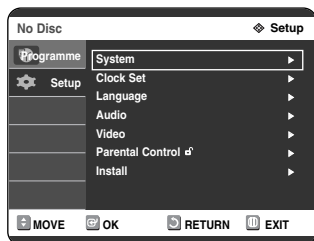

- 3 Press the **▲▼** buttons to select **Language**, then press the **OK** or **▶** button. Language setup menu will be displayed.

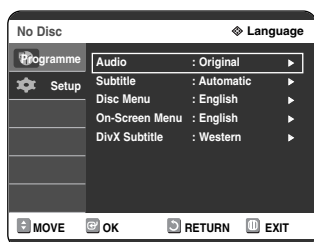

- 4 Press the **▲▼** buttons to select the desired language option, then press the **OK** or **▶** button.

- **Audio Language:** For the speaker sound.
- **Subtitle Language:** For the disc subtitles.
- **Disc Menu Language:** For the disc menu contained on the disc
- **On-Screen Menu Language:** For the Player Menu of your DVD Recorder
- **DivX Subtitle:** Selecting a supported DivX subtitle language by region

Western	English, Breton, Catalan, Danish, Dutch, Faroese, Finnish, French, Gaelic, German, Icelandic, Irish, Italian, Norwegian, Portuguese, Spanish and Swedish
Central	English, Albanian, Croatian, Czech, Hungarian, Polish, Romanian, Slovak, Slovene and Serbian(Latin)
Greek	English and modern Greek

- 5 Press the **▲▼** buttons to select the desired Language, then press the **OK** or **▶** button.

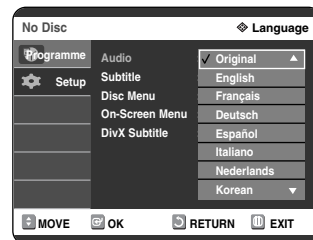

NOTE

- Press the **RETURN** or **◀** button to return to the previous menu. Press the **MENU** button to exit the menu.
- The selected language will only appear if it is supported on the disc.
- If the subtitle language is displayed in broken fonts, change DivX Subtitle to the appropriate region. If it still does not work, the format is not supported.

EP Mode Time Setting

You can select one of four recording modes by pressing the **REC MODE** button repeatedly. EP mode is one of four REC Mode (XP,SP,LP,EP). In EP(Extended Play) mode, you can set recording time to 6 or 8 hours by this setting.

- 1 With the unit in Stop mode/No Disc mode, press the **MENU** button.

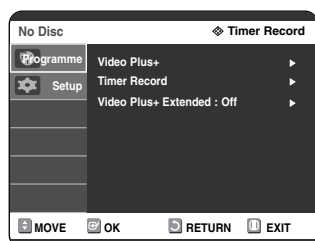

- 2 Press the **▲▼** buttons to select **Setup**, then press the **OK** or **▶** button.

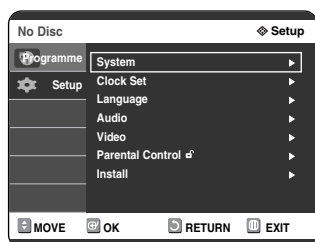

- 3 Press the **▲▼** buttons to select **System**, then press the **OK** or **▶** button. System menu will be displayed.

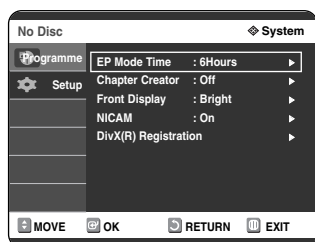

- 4 Press the **▲▼** buttons to select **EP Mode Time**, then press the **OK** or **▶** button.

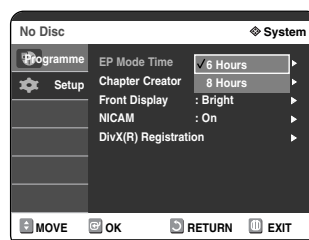

- 5 Press the **▲▼** buttons to select the desired time, then press the **OK** or **▶** button.

Automatic Chapter Creation

A DVD-Video consists of 'Titles' and 'Chapters'. When you record one programme, it makes one Title. If you use this function, the Title will be divided into Chapters.



(V mode)

- 1 With the unit in Stop mode/No Disc mode, press the **MENU** button.

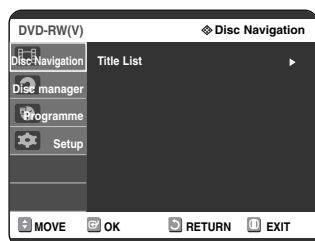

- 2 Press the **▲▼** buttons to select **Setup**, then press the **OK** or **▶** button.

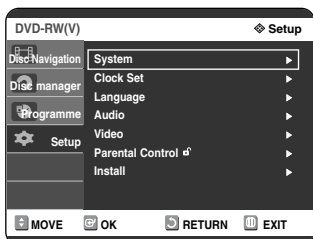

- 3 Press the **▲▼** buttons to select **System**, then press the **OK** or **▶** button. System menu will be displayed.

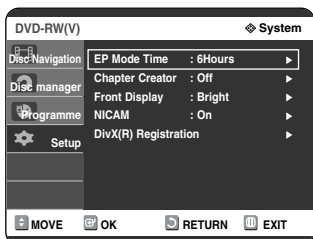

- 4 Press the **▲▼** buttons to select **Chapter Creator**, then press the **OK** or **▶** button.

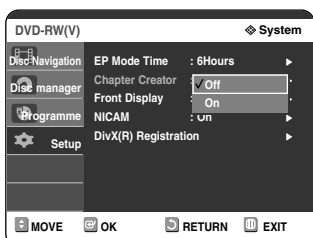

- 5 Press the **▲▼** buttons to select **On** or **Off**, then press the **OK** or **▶** button.
 - Off: Select this option when you do not want (Automatic Chapter Creation).
 - On: Select this option when you want (Automatic Chapter Creation).

- 6 Press the **REC** button to start recording. (See page 42 about how to set recording speed) The message "Do you want to create the chapter menu after this recording?" is displayed.

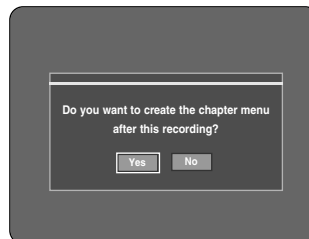

- 7 Press the **◀▶** buttons to select **Yes** and press the **OK** button.
 - A new chapter is created according to the selected recording mode. A chapter will be about 5 minutes long in XP and SP, and about 15 minutes long in LP and EP mode.

- 8 Press the **STOP** button to stop recording.

- 9 To display the created chapters, finalise the disc (see page 85) and then press the **DISC MENU** button. The chapter menu will be displayed.

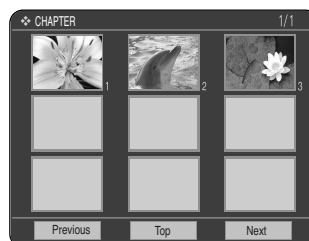

- The Automatic Chapter Creation function does not work during Timer Recording or when you turn the power off.
- DVD-R discs cannot be unfinalised.

Setting up the Front Display Options

Adjust the brightness of the DVD recorder front panel display.

- 1 With the unit in Stop mode/No Disc mode, press the **MENU** button.

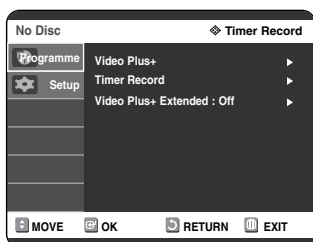

- 2 Press the **▲▼** buttons to select **Setup**, then press the **OK** or **▶** button.

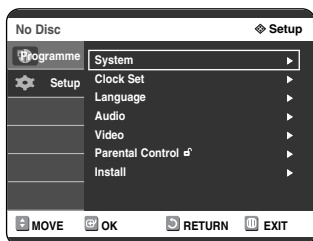

- 3 Press the **▲▼** buttons to select **System**, then press the **OK** or **▶** button. System menu will be displayed.

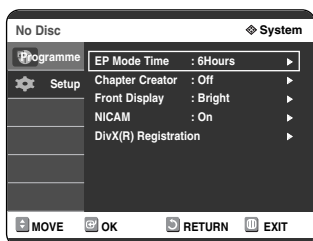

- 4 Press the **▲▼** buttons to select **Front Display**, then press the **OK** or **▶** button.

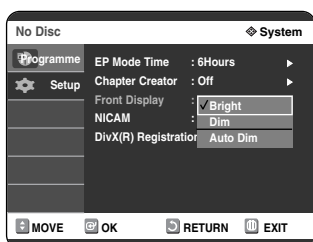

- 5 Press the **▲▼** buttons to select the desired item, then press the **OK** or **▶** button.
 - Bright : Makes the Front Panel Display bright.
 - Dim : Makes the Front Panel Display dim.
 - Auto Dim : Makes the Front Panel Display dim automatically when during power off.

Setting up NICAM Options

NICAM programmes are divided into 3 types. NICAM Stereo, NICAM Mono and Bilingual (transmission in another language). NICAM programmes are always accompanied by a standard mono sound broadcast and you can select the desired sound by setting NICAM on or off.

- 1 With the unit in Stop mode/No Disc mode, press the **MENU** button.

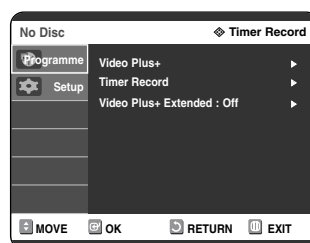

- 2 Press the **▲▼** buttons to select **Setup**, then press the **OK** or **▶** button.

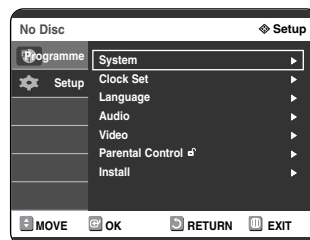

- 3 Press the **▲▼** buttons to select **System**, then press the **OK** or **▶** button. System menu will be displayed.

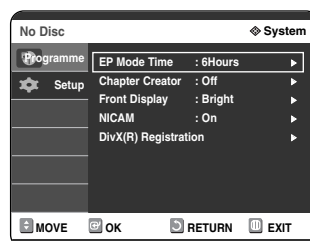

- 4 Press the ▲▼ buttons to select **NICAM**, then press the **OK** or ► button.

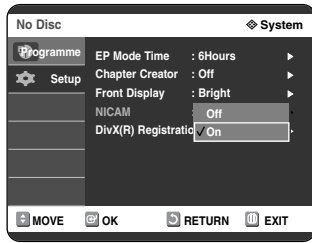

- 5 Press the ▲▼ buttons to select **On** or **Off**, then press the **OK** or ► button.

- Off: Only set at this position to record the standard mono sound during a NICAM broadcast if the stereo sound is distorted due to inferior reception conditions.
- On: NICAM mode

DivX(R) Registration

Please use the Registration code to register this DVD Recorder with the DivX(R) Video On Demand format. To learn more, visit www.divx.com/vod.

Setting up the Audio Options

You can connect the DVD Recorder to an external amp or Home Theatre.

Allow you to setup the Audio device and sound status depending on the audio system in use.

- 1 With the unit in Stop mode/No Disc mode, press the **MENU** button.

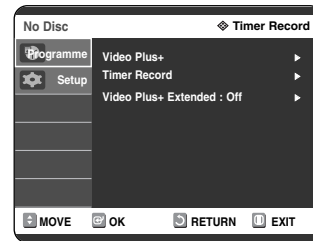

- 2 Press the ▲▼ buttons to select **Setup**, then press the **OK** or ► button.

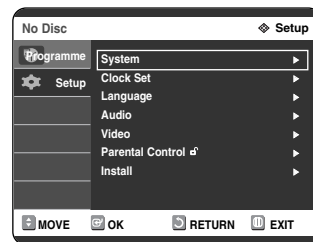

- 3 Press the ▲▼ buttons to select **Audio**, then press the **OK** or ► button. Audio setup menu will be displayed.

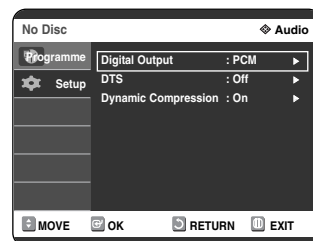

- 4 Press the ▲▼ buttons to select the desired audio option, then press the **OK** or ► button.

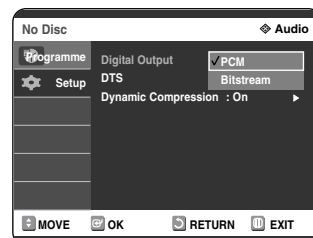

- 5 Press the ▲▼ buttons to select the desired item, then press the OK or ► button.



NOTE

- Press the RETURN or ◀ button to return to the previous menu.
Press the MENU button to exit the menu.

Audio Options

Digital Output

1. PCM : Select this when you have no equipment that can decode Dolby Digital (or MPEG-2) signal. When you play Dolby Digital (or MPEG-2) sound track, the digital output are converted to PCM Stereo.
2. Bitstream : Output Dolby Digital (or MPEG-2) audio as bitstream. Select this when your AV receiver or AV amplifier have Dolby Digital (or MPEG-2) Decoder.



NOTE

- Digital output setting is equally applied to both Dolby Digital and MPEG-2 audio. LPCM sound track is always outputted as PCM. It has no relation with Digital Output setting.
- Be sure to select the correct Digital Output or you will hear no sound or loud noise.

DTS

1. Off : Doesn't output DTS signal.
Select this when your AV receiver or AV amplifier does not have DTS decoder.
2. On : Outputs DTS Bitstream via digital output when you play DTS track.
Select this only when your AV receiver (or AV amplifier) have DTS decoder.



NOTE

- When DTS soundtrack is played, sound does not output from AV Audio Output.

Dynamic Compression

This is only active when a Dolby Digital signal is detected.

1. Off : You can enjoy the movie with the standard Dynamic Range.
2. On : When Movie soundtracks are played at low volume or from smaller speakers, the system can apply appropriate compression to make low-level content more intelligible and prevent dramatic passages from getting too loud.

Setting up Video Output Options

You can enjoy high quality image through RGB or Component video connections.

- 1 With the unit in Stop mode/No Disc mode, press the MENU button.

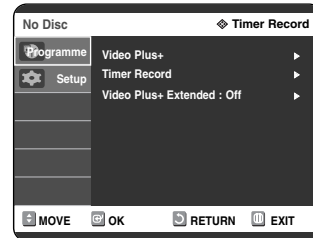

- 2 Press the ▲▼ buttons to select Setup, then press the OK or ► button.

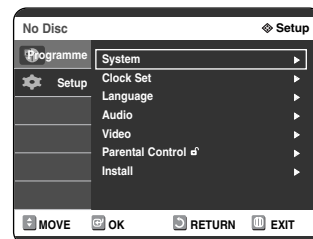

- 3 Press the ▲▼ buttons to select Video, then press the OK or ► button.
Video setup menu will be displayed.

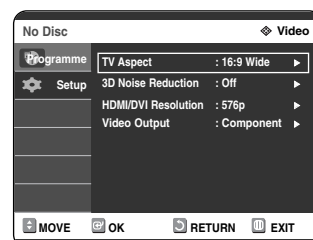

4 Press the ▲▼ buttons to select **Video Output**, then press the **OK** or ► button.

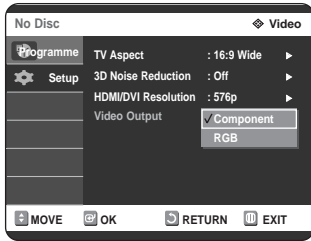

Component	Select this when the Recorder is connected to a TV with Component jack.
RGB	Select this when the Recorder is connected to your TV using SCART cable.

5 Press the ▲▼ buttons to select the desired item, then press the **OK** or ► button.

In Component mode, you can set video output to Progressive(P.SCAN) or Interlace, see page 35.

When the HDMI cable is not connected, available video output jacks are as follow.

Available Video Output Jack

Setting mode Output jack	Component mode		RGB Mode
	P.SCAN off mode (Interlace mode)	P.SCAN on mode (TV in progressive mode)	
Component Output (Y, Pb, Pr)	0	0	X
AV1 Scart	R, G, B	X	0
	Composite	0	X
AV2 Scart	Composite	0	X
Composite Video out	0	X	0
S-Video out	0	X	0

NOTE ■ When the HDMI cable is connected, other A/V output does not operate.

Setting up the Progressive scan

If the TV supports Progressive Scan, press the **P.SCAN** button on the front of the DVD Recorder to enjoy.

1 With the unit in Stop mode, press the **P.SCAN** button on the front of the DVD Recorder.
The message "Press [Yes] to confirm Progressive scan mode. Otherwise press [No]" will appear. Press the ◀▶ buttons to select **Yes**, and then press the **OK** button.

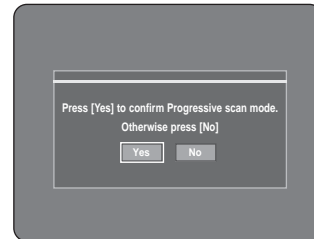

2 The message "Please set your TV to Progressive input. To deactivate, press [STOP] key." will appear. Press the **OK** button.



3 The message "Video Output Mode Progressive Scan" will appear.

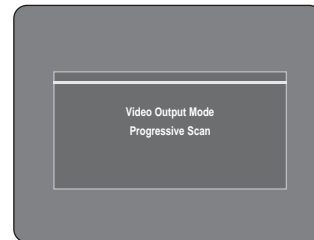

NOTE

- When the HDMI cable is connected, this screen is not displayed.
- Progressive setting is only available when the Video Out is set to Component.
- Progressive setting is only available when the DVD recorder is in stop mode.
- If the **P.SCAN** button on the DVD recorder's front panel is pressed during playback, the message "This function is possible only on stop mode" appears on the screen.

Canceling the Progressive scan

- 1 With the unit in Stop mode, press the **P.SCAN** button on the front of the DVD Recorder.
The message "Press [Yes] to confirm Interlace scan mode. Otherwise press [No]" will appear.
Press the ◀▶ buttons to select **Yes**, and then press the **OK** button.

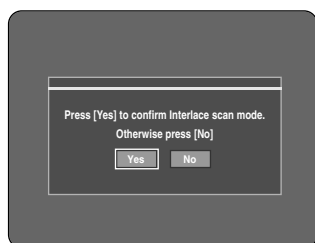

- 2 The message "Please set your TV to Interlace input. To deactivate, press [STOP] key." will appear. Press the **OK** button.



- 3 The message "Video Output Mode Interlace Scan" will appear.

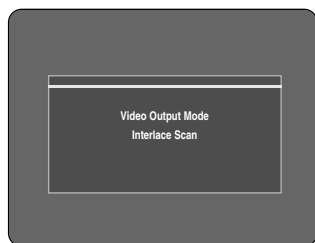

NOTE

- Do not press the **P.SCAN** button if you are using a TV that does not support Progressive mode. Nothing will be displayed on the screen if pressed.
- If you press the **P.SCAN** button by mistake when your TV does not support Progressive mode, you need to release the Progressive mode. To release the Progressive mode, press the **P.SCAN** button on the front panel 3 times. The screen will recover after the **PSO** LED on the front panel display turns off.

Setting up the Display(Video) Options

This function allows you to setup the TV screen settings.

- 1 With the unit in Stop mode/No Disc mode, press the **MENU** button.

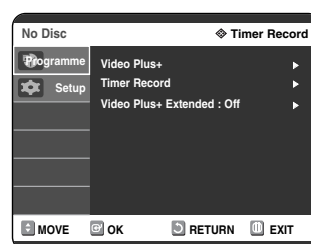

- 2 Press the ▲▼ buttons to select **Setup**, then press the **OK** or ▶ button.

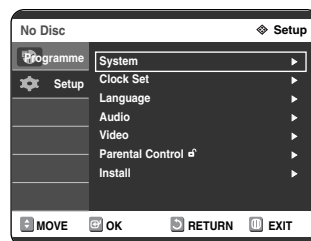

- 3 Press the ▲▼ buttons to select **Video**, then press the **OK** or ▶ button.
Video setup menu will be displayed.

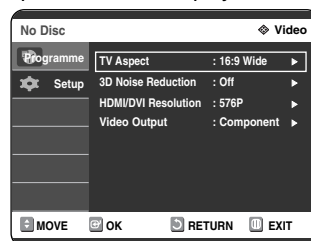

- 4 Press the ▲▼ buttons to select the desired video option, then press the **OK** or ▶ button.

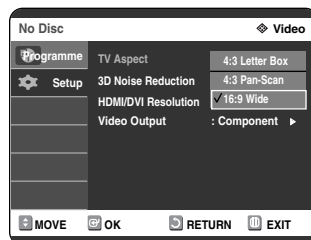

- 5 Press the ▲▼ buttons to select the desired item, then press the **OK** or ▶ button.



NOTE

- Press the **RETURN** or ◀ button to return to the previous menu. Press the **MENU** button to exit the menu.

Display(Video) Options

This function depends on disc type. It may not work for some disc types.

TV Aspect

Depending on the type of television you have, you may want to adjust the screen setting. (aspect ratio)

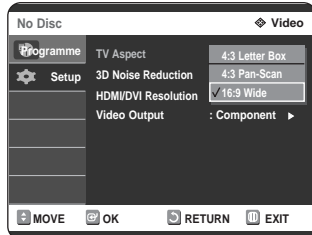

- **4:3 Letter Box** : Select when you want to see the total 16:9 ratio screen DVD supplies, even though you have a TV with a 4:3 ratio screen. Black bars will appear at the top and bottom of the screen.
- **4:3 Pan - Scan** : Select this for conventional size TV when you want to see the central portion of the 16:9 screen. (Extreme left and right side of movie picture will be cut off.)
- **16:9 Wide** : You can view the full 16:9 picture on your widescreen TV.

3D Noise Reduction (motion adaptive noise reduction)

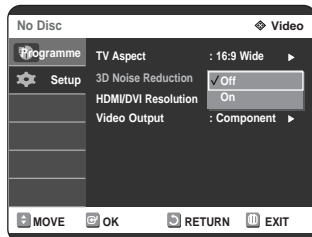

- **On** : Provides a clear picture through noise reduction (for recording).
- **Off** : Normal

HDMI/DVI Resolution

This setting is used when the DVD recorder is connected by HDMI or DVI with Display devices (TV, projector, etc).

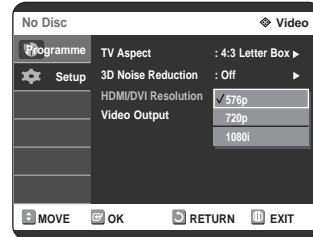

- **576p** : 720 x 576
- **720p** : 1280 x 720
- **1080i** : 1920 x 1080



NOTE

- Menu screen will zoom out to 2/3 at 1080i.

Output selection

- Connect the DVD Recorder to your TV via HDMI. Set your TV's input to HDMI.
- Press the **P.SCAN** button while the unit is in Stop mode to select the HDMI output resolution as follows: 576p → 720p → 1080i.



NOTE

- Progressive scan automatically activates when HDMI is connected.
- There will be no HDMI video and audio outputs unless progressive scan function is activated.
- Consult your TV User's Manual to find out if your TV supports Progressive Scan. If Progressive Scan is supported, follow the TV User's Manual regarding Progressive Scan settings in the TV's menu system.
- If Video Output is set incorrectly, the screen may be blocked.
- The resolutions available for HDMI/DVI output depend on the connected TV or projector. For details, see the user's manual of your TV or projector.
- When the resolution is changed it may take a few seconds for a normal image to appear.
- If you set the HDMI output resolution 720p or 1080i, HDMI output provides better picture quality.
- DivX playback screen output can only be done in 576p.

Setting up the Parental Control

The Parental Control function works in conjunction with DVDs that have been assigned a rating which helps you control the types of DVDs that your family watches. There are up to 8 rating levels on a disc.



- 1 With the unit in Stop mode/No Disc mode, press the **MENU** button.

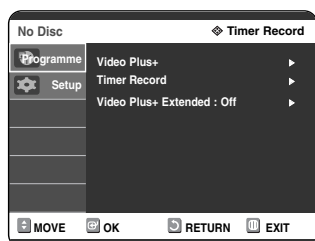

- 2 Press the **▲▼** buttons to select **Setup**, then press the **OK** or **▶** button.

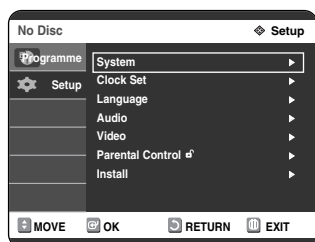

- 3 Press the **▲▼** buttons to select **Parental Control**, then press the **OK** or **▶** button.

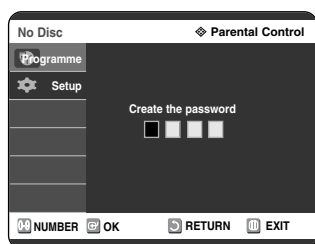

- 4 Enter the 4-digit password using the **0** to **9** buttons on the remote control. The 'Confirm the password.' message will be displayed. Enter your password again.

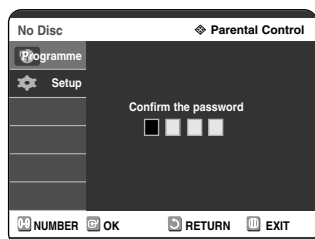

- 5 Press the **OK** or **▶** button to select **Password**.

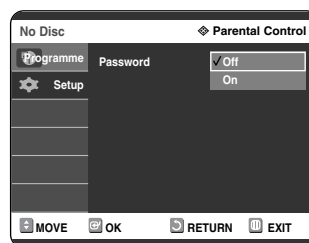

- 6 Press the **▲▼** buttons to select **On** or **Off**, then press the **OK** or **▶** button.



NOTE

- Press the **RETURN** or **◀** button to return to the previous menu. Press the **MENU** button to exit the menu.

If you forgot your password

- 1 Remove the disc.
- 2 Press and hold **▶▶I (FF)** on the front panel for 5 seconds or more.

About the Rating Level

- 1 Press the ▲▼ buttons to select **Rating Level**.

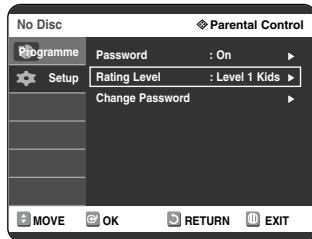

- 2 Press the **OK** or ► button. The rating level will be displayed.

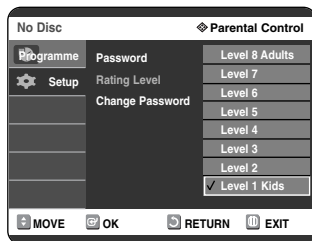

- 3 Press the ▲▼ buttons to select Rating Level you want, then press the **OK** or ► button. For example, if you select up to Level 6, discs that contain Level 7, 8 will not play. A larger number indicates that the programme is intended for adult use only.

About the Change Password

- 1 Press the ▲▼ buttons to select **Change Password**.

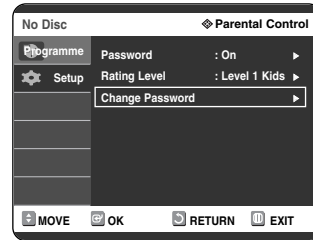

- 2 Press the **OK** or ► button. The 'Enter the password.' message will be displayed.

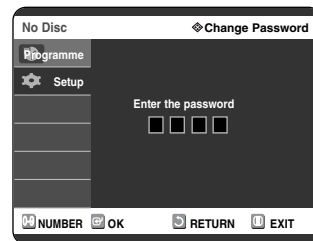

- 3 Enter the 4-digit password using the **0** to **9** buttons on the remote control. The 'Confirm the password.' message will be displayed. Enter your password again.

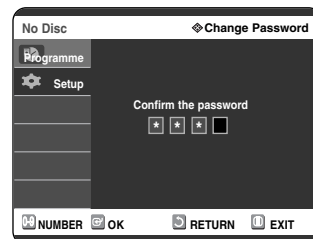

NOTE

- See page 37 if you forgot your password.

Recording

This section shows various DVD recording methods.

Before Recording	39
Recording the current TV programme you are watching	41
Recording from external equipment you are watching	43
Copying from a Camcorder	44
Making a One Touch Recording (OTR).....	45
Making a Timer Recording	46
Flexible Recording (for Timer recording only) ..	47
Editing the Scheduled Record List.....	47
Deleting the Scheduled Record List.....	48
Using the Video Plus+ Feature	49
Video Plus+ Extended.....	50
Recording the Standard Timer List	50

Before Recording

This DVD recorder can record on various types of discs. Before recording, read the following instructions and select the disc type according to your preference.

Recordable discs

This recorder can record on the following discs.

DVD-RAM	DVD-RW	DVD-R
		

- DVD-RWs and DVD-RAMs are rewritable.
- DVD-Rs are non-rewritable

Compatibility between Samsung and Other Company's Recorder

Disc Types	Recording format	Recording Device	Finalising	Additional Recording in Samsung Recorder
DVD-RAM	VR Mode	Samsung	X	Recordable
		Other Company	X	Recordable
DVD-RW	VR Mode	Samsung	finalised	Not recordable
			not finalised	Recordable
	Other Company	finalised	Not recordable	
		not finalised	Recordable	
	V Mode	Samsung	finalised	Not recordable
			not finalised	Recordable
Other Company	finalised	Not recordable		
not finalised	Not recordable			
DVD-R	V Mode	Samsung	finalised	Not recordable
			not finalised	Recordable
		Other Company	finalised	Not recordable
			not finalised	Not recordable



NOTE

- Finalise
 - This closes the DVD-R/RW so no additional recording can be done.
- Unfinalise
 - This allows additional recording on a DVD-RW disc originally recorded on the DVD Recorder.
 - A DVD-RW disc that has been recorded by DAO(Disc At Once) in a PC cannot be unfinalised.
 - A DVD-RW disc that has been recorded in Video Mode of a different maker's recorder cannot be unfinalised.
 - A DVD-R disc cannot be unfinalised.

Recording Formats

Since available functions differ depending on the disc type, select a disc that best fits your preferences; When you insert an unused disc, the following message appears.
 DVD-RAM: Use after formatting the disc.

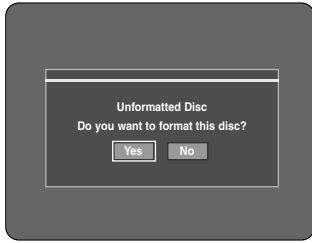

DVD-RW: When a blank disc is first inserted, the message "Do you want to initialize this disc?" will appear.
 When **Yes** is selected, the disc will be formatted in VR Mode.



If you want to format in either VR Mode or Video Mode, refer to Formatting a Disc on page 83.



DVD-R: Formatting DVD is unnecessary and only Video Mode Recording is supported

DVD-RW(Video mode)-R

- Chapters will be created automatically when you finalise recording on DVD-R / DVD-RW discs in Video mode. The chapter's length (interval between chapters) varies according to the recording mode.
- Simple editing (erasing titles/changing title name)

DVD-RW(VR mode)-RAM

- This mode allows multiple editing functions (such as deletion of the whole title, partial deletion of a title, etc.)
- Various editing options using a created Playlist

Recording Mode

Select one of four recording modes by pressing the **REC MODE** button repeatedly while the DVD recorder is in Stop mode for the desired recording time and picture quality. In general, picture quality improves as the recording time decreases. In FR mode, the most suitable record mode is adjusted automatically, according to remaining time on the disc and length of the timer recording.

This function is selected only one mode in XP, SP, LP and EP modes and you can use this mode for timer recording.

Mode	Characteristic	Recording Times Data Rates
XP (high quality mode)	Select when the video quality is important.	Approx. 1 hour about 8 Mbps
SP (standard quality mode)	Select to record in standard quality.	Approx. 2 hours about 4 Mbps
LP (long recording mode)	Select when a long recording time is required.	Approx. 4 hours about 2 Mbps
EP (extended mode)	Select when a longer recording time is required.	Approx. 6 hours/ about 1.2 Mbps Approx. 8 hours/ about 0.8 Mbps
FR (Flexible Recording)	for timer recording only see page 47.	Approx 60 to 480 Min Approx 0.8 to 8Mbps

Unrecordable video

Video with copy protection cannot be recorded on this DVD Recorder.
 When the DVD Recorder receives a copy guard signal while recording, recording stops and the following message appears on the screen.

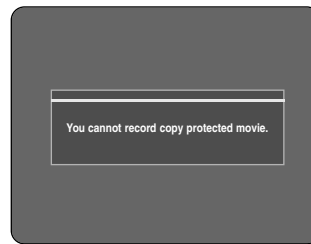

Concerning Copy Control Signals

TV broadcasts that contain copy control signals may have one of the following three signal types, Copy-Free, Copy-Once and Copy-Never. If you want to record a copy-once type programme, use DVD-RW with CPRM in VR Mode and DVD-RAM.

Media	Signal type	Copy-Free	Copy-Once	Copy-Never
DVD-RW(Ver.1.1)		○	-	-
DVD-RW(Ver.1.1) with CPRM				
VR mode		○	○*	-
Video mode		○		-
DVD-R		○		-
DVD-RAM(Ver.2.0)		○	○*	-

Once "Copy Once" has been recorded, recording cannot be done anymore.

- Content Protection for Recordable Media (CPRM)

CPRM is a mechanism that ties a recording to the media on which it is recorded. It is supported by some DVD recorders, but not by many DVD players. Each blank recordable DVD has a unique 64-bit media ID etched in the BCA. When protected content is recorded onto the disc, it can be encrypted with a 56-bit C2 (Cryptomeria) cipher derived from the media ID. During playback, the ID is read from the BCA and used to generate a key to decrypt the contents of the disc. If the contents of the disc are copied to other media, the ID will be absent or wrong and the data will not be decryptable.

About INFO Key

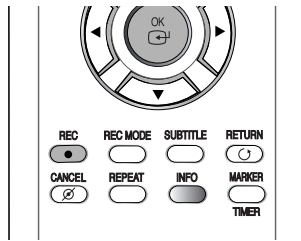

The INFO function allows you to view the current status and progress of playback and recording. Depending on the disc type and status, the displayed screen may be different.

Checking the available disc space (Disc Information)

When recording on an used disc, make sure that there is enough disc space for recording. With DVD-RWs or DVD-RAMs, you can free up disc space by erasing titles.

- Press the **INFO** button.
The display window of disc information appears. Items in the display differ depending on the disc type or recording format.

DVD-RAM(VR)	Disc Info
Disc Name	Disc
Total Title	15
Total Playlist	2
Recordable Time	02:12 SP
Protection	Not Protected
Screen	Recording : PR 1 [SP]
01 JAN 2005 SAT	12:00

1. Disc Type
2. Current information display status
3. Disc Name
4. Total Titles : Total number of titles
5. Total Playlist : Total number of Playlists
6. Recordable Time : The longest continuous recording time in each of the recording modes(approximately)
7. Date : Current date and time

Recording the current TV programme you are watching



Before you start

Check that the disc has enough available space for the recording. Adjust the recording mode.

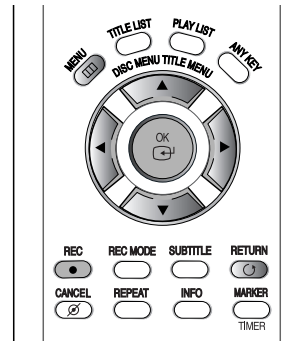

- 1 Press the **OPEN/CLOSE** button and place a recordable disc on the disc tray.

- 2 Press the **OPEN/CLOSE** button to close the disc tray.

Wait until "LOAD" disappears from the front panel display.

If an unused DVD-RAM disc is used, you will be prompted to format first. Make your selection using the ◀▶ buttons, then press **OK** button. (See page 40.)



If an unused DVD-RW disc is used, whether to initialize or not will be asked first. Make your selection, then press the **OK** button. (See page 40.)



3 Press the **PROG** (⊖/⊕) or **number** (⓪~⓪) buttons to select the current programme you want to record.

4 Press the **REC MODE** button repeatedly, (or press the **REC MODE** button, then press the **▲▼** button) to select the recording speed(quality).

→ **SP** → **LP** → **EP** → **XP** →



5 Press the **REC** button. Information concerning the channel is displayed on the screen, then recording begins. Icon(⓪) is displayed on the front panel.



To view the current status of the disc and progress of recording : Press the **INFO** button, the information about the disc will appear.

DVD-RAM(VR)		Disc Info
Disc Name		
Total Title	15	
Total Playlist	2	
Recordable Time	02:12 SP	
Protection	Not Protected	
Screen	Recording : PR 1 [SP]	
01 JAN 2005 SAT		12:00

Press the **INFO** button once again to view information about the recording.

DVD-RAM(VR)		Recording Info
Name	01/JAN/2005 12:00 PR	
	1	
Recording Title	15	
Created Time	01/JAN/2005 12:00	
Recording Time	00:02:05	
01 JAN 2005 SAT		12:00

To stop recording

Press the **STOP** (⊘) button to stop or finish a recording in progress.

- When using DVD-RAM/DVD-RW/DVD-R discs, the message 'Updating the information of disc. Please wait for a moment' is displayed.



NOTE

- You can not change the recording mode and the PROG while recording.
- Recording will stop automatically if there is no free space left for recording.
- Up to 99 titles can be recorded onto a disc.
- Recording will stop automatically if a copy protected image is selected.
- DVD-RAM/DVD-RW discs must be formatted before starting to record. Most new discs are sold unformatted.
- Do not use DVD-R authoring discs with this DVD recorder.

Recording from external equipment you are watching



Before you start

Check that the disc has enough available space for the recording. Adjust the recording mode.

1 Press the **OPEN/CLOSE** button, place a recordable disc on the disc tray.

2 Press the **OPEN/CLOSE** button to close the disc tray.

Wait until "LOAD" disappears from the front panel display.

If an unused DVD-RAM disc is used, whether to format or not will be asked first. (See page 40)

If an unused DVD-RW disc is used, whether to initialize or not will be asked first. (See page 40)

3 Press the **INPUT** button to select the input source according to the connection you made.

The front panel display changes in the following sequence:

→ **PR Number** → **AV1** → **AV2** → **AV3** → **DV** →

If you connect a digital camcorder, press the **INPUT** button to select **DV**. (See page 44)

4 Press the **REC MODE** button repeatedly, (or press the **REC MODE** button, then press the **▲▼** button) to select the recording speed(quality).

→ **SP** → **LP** → **EP** → **XP** →



5 Press the **REC** button.

To pause recording

Press the **⏸** button to pause a recording in progress.

- Press the **⏪** button again to resume recording.
- You can switch channels by pressing the **PROG** (**⏪/⏩**) buttons while recording pauses.

To stop recording

Press the **STOP** (**⏹**) button to stop or finish a recording in progress.

- When using DVD-RAM/DVD-RW/DVD-R discs, the message 'Updating the information of disc. Please wait for a moment' is displayed.



NOTE

- You can not change the recording mode and input source while recording or Pause.
- Recording will stop automatically if there is no free space left for recording.
- Up to 99 titles can be recorded onto a disc.
- Recording will stop automatically if a copy protected image is selected.
- DVD-RAM/DVD-RW discs must be formatted before starting to record. Most new discs are sold unformatted.
- Do not use DVD-R authoring discs with this DVD recorder.

Copying from a Camcorder

You may control the Camcorder using the IEEE1394 (DV) interface.



Before you start

Check that the disc has enough available space for the recording. Adjust the recording mode.

1 Press the **OPEN/CLOSE** button, place a recordable disc on the disc tray.

2 Press the **OPEN/CLOSE** button to close the disc tray.

Wait until "LOAD" disappears from the front panel display.

If an unused DVD-RAM disc is used, whether to format or not will be asked first. (See page 40.)

If an unused DVD-RW disc is used, whether to initialize or not will be asked first. (See page 40.)

3 Press the **REC MODE** button repeatedly, (or Press the **REC MODE** button, then press the **▲▼** button) to select the recording speed (quality).

→ SP → LP → EP → XP →

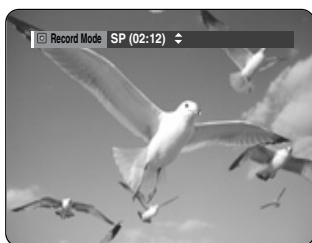

4 Press the **INPUT** button to select **DV**.
If the input is set to DV, a playback/record menu that enables camcorder control appears on the top of the screen.



5 Select the Play icon on the upper part of the screen to playback the camcorder and find the starting position to copy.

You can press the **PLAY** button of the remote control to play the camcorder.

6 To start recording, use the **◀▶** to select (●) icon in the top side of the screen, then press the **OK** button.

You can press the **REC** button of the remote control to start recording. To display playback related icons on the screen, press any direction button on the remote control.

To stop recording

Press the **STOP (⊙)** button to stop or finish a recording in progress.

- When using DVD-RAM/DVD-RW/DVD-R discs, the message 'Updating the information of disc. Please wait for a moment' is displayed



NOTE

- You can not change the recording mode and input source while recording.
- Recording will stop automatically if there is no free space left for recording.
- Up to 99 titles can be recorded onto a disc.
- Recording will stop automatically if a copy protected image is selected.
- DVD-RAM/DVD-RW discs must be formatted before starting to record. Most new discs are sold unformatted.
- Do not use DVD-R authoring discs with this DVD recorder.

Making a One Touch Recording (OTR)



You can set the DVD Recorder to record in 30-minute increments by pressing the **REC** button.

- 1 If you want to record a TV channel, press the **PROG** (◀/▶) or number buttons to select a desired channel. If you want to record through a connected external component, press the **INPUT** button to select an appropriate external input (**AV1**, **AV2**, **AV3** or **DV**).
 - TV PROGRAMME: 1 to 99

- 2 Press the **REC** button to start recording.

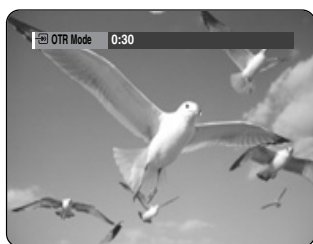

- 3 Press the **REC** button repeatedly to adjust the desired recording time.

→ 0:30 → 1:00 → ... 8:00 → Off



NOTE

- The timer counter decreases by the minute from 8:00 to 0:00, then the DVD Recorder stops recording.

To view the current status of the disc and progress of recording : Press the **INFO** button, and information about the disc will appear.

DVD-RAM(VR) Disc Info	
Disc Name	
Total Title	15
Total Playlist	2
Recordable Time	02:12 SP
Protection	Not Protected
Screen	Recording : PR 1 [SP]
01 JAN 2005 SAT	12:00

Press the **INFO** button once again. Then you can check the information about the title being recorded.

DVD-RAM(VR) Recording Info	
Name	01/JAN/2005 12:00 PR
	1
Recording Title	15
Created Time	01/JAN/2005 12:00
Recording Time	00:02:05
01 JAN 2005 SAT	12:00

30 seconds before the recording is done, a message asking whether you want the recorder to power off when the recording is done, will appear on your screen.

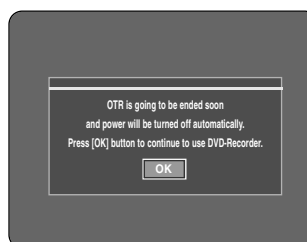

To stop recording

Press the **STOP** (⏻) button. The message “Do you want to stop recording?” is displayed.



- Press the ◀ ▶ buttons to select **Yes**, then press the **OK** button.
- Or press the **STOP** button again.

Making a Timer Recording

Before you start

1. Check the antenna cable is connected.
2. Check the remaining time of the disc.
3. Check the date and time are correct.
Make sure the Clock (Setup-Clock Set) must be set before you proceed with a timer recording.
(See page 25)

- 1 With the unit in Stop mode, press the **TIMER** button.

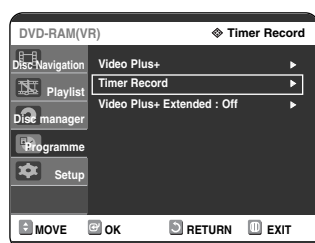

Using the MENU button.

- With the unit in Stop mode, press the **MENU** button.
- Press the ▲▼ buttons to select **Programme**, then press the **OK** or ► button.
- Press the ▲▼ buttons to select **Timer Record**.

- 2 Press the **OK** or ► button.
 - The Timer Recording screen is displayed.

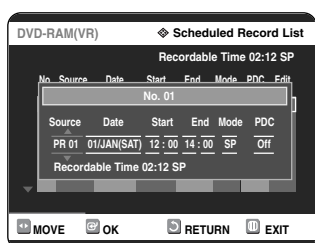

- 3 Set timer recording option.
 - Fill the input items using the arrow buttons and number buttons.
 - ◀▶ : Moves to the previous/next item,
 - ▲▼, Number buttons : Sets a value.

- **Source** : The video input source (“AV1”, “AV2”, “AV3”), or the broadcasting channel you want to make a timer recording from.

- **Date** : Timer Recording allows setting the recording time within one month period. Set the recording day. (day/month)

01/JAN(SAT)	Every Day
02/JAN(SUN)	MON-SAT
03/JAN(MON)	MON-FRI
⋮	⋮
30/JAN(SUN)	Every SAT
31/JAN(MON)	Every SUN

- **Start/End Time** : Start and end time of the timer recording.

- **Mode (Recording Mode)** :

- FR (Flexible Recording) : In FR mode, the most suitable record mode is adjusted automatically, according to remaining time on the disc and length of the timer recording. This function is selected only one mode in XP, SP, LP and EP modes.
- XP (high quality) : Select when video quality is important. (Approx. 1 hour)
- SP (standard quality) : Select to record in standard quality. (Approx. 2 hours)
- LP (low quality) : Select when a long recording time is required. (Approx. 4 hours)
- EP (extended) : Select when a longer recording time is required. (Approx. 6 hours or 8 hours)

- **PDC** : PDC(Programme Delivery Control) function.

- If you set this function on, you can control the starting and ending time of recording by special signal included in the broadcasting signal. If a TV programme is shortened or starts earlier or later than scheduled, this function synchronizes the starting and ending time of recording with the actual broadcasting time automatically.
- Set up the start-time EXACTLY according to the published TV schedule. Otherwise the timer recording will not operate.
- Do not select PDC unless you are sure the programme you wish to record is broadcast with PDC.



- When you are recording at EP mode on a DVD-RW(V)-R disc, it may not record the full 6 or 8 hours because the DVD recorder uses the VBR(Variable Bit Rate) ENCODING system. For example, if you record a programme with a lot of action, it uses a higher bit rate which in turn consumes more disc memory.

- 4** Press the **OK** button.
-  will appear on the front panel. It means that a timer recording is registered.

If the timer settings overlap

The programmes are recorded in order of priority. If timer recording is set for the first programme and then again for the second programme and both programmes overlap, the following message will appear on the screen: "This setting is identical with 1" The message shows that the first programme has priority. After recording of the first programme is complete, the second programme starts being recorded.

To exit without saving the current setting

Press the **MENU** button.

To return to the previous menu

Press the **RETURN** button if you don't want to set a timer recording.

- 5** Turn the power off to finish the Timer Recording setting. Timer Recording will not work when the power is on.
-  will blink if disc is not inserted.



NOTE

- The timer recording time may differ from the set time depending on disc status and overall timer recording status (for example, recording times overlapping, or when the previous recording ends within 2 minutes before the start time of the next recording.)
- You can make the Timer Recording up to 12 programmes.

Flexible Recording (for Timer recording only)



In FR mode, the most suitable record mode is adjusted automatically, according to remaining time on the disc and length of the timer recording. This function is selected only one mode in XP, SP, LP and EP modes and you can use this mode for timer recording.

The FR mode recording setup is the same as Timer Recording. When setting the mode in step 3, set FR Mode.

Editing the Scheduled Record List



Follow these directions to edit the scheduled record list.

- 1** With the unit in Stop mode, press the **TIMER** button.

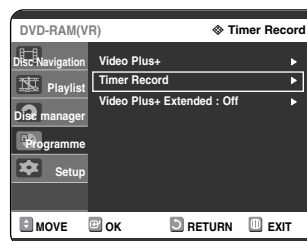

Using the MENU button.

- With the unit in Stop mode, press the **MENU** button.
- Press the **▲▼** buttons to select **Programme**, then press the **OK** or **▶** button.
- Press the **▲▼** buttons to select **Timer Record**.

- 2** Press the **OK** or **▶** button.

- 3** Press the **RETURN** button to close the Timer Recording screen.

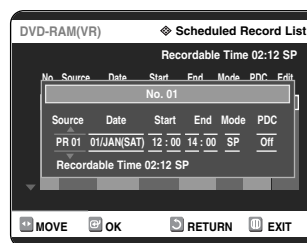

- 4** Press the **▲▼** buttons to select the number of the timer recording you want to edit, then press the **OK** or **▶** button.

- The Edit and Delete items are displayed.

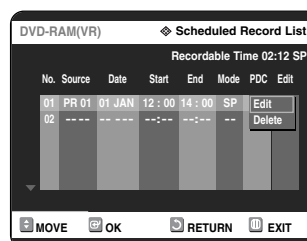

- 5** Press the **▲▼** buttons to select **Edit**, then press the **OK** or **▶** button.
- The Timer Record Input item is displayed. Edit the items you want to modify. See the “Making a Timer Recording” section for more information on Timer Recording Input items.

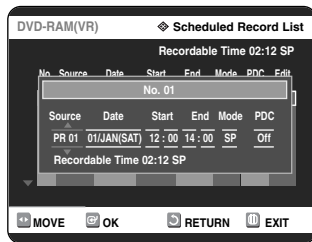

- 6** Press the **OK** button to confirm the edited setting.

- 7** Press the **MENU** button after finishing the operation. The menu screen will disappear.

- 3** Press the **RETURN** button to close the Timer Recording screen.

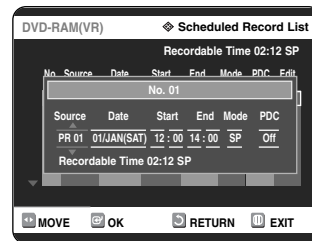

- 4** Press the **▲▼** buttons to select the number of the timer recording you want to delete, then press the **OK** or **▶** button.
- The **Edit** and **Delete** items are displayed.

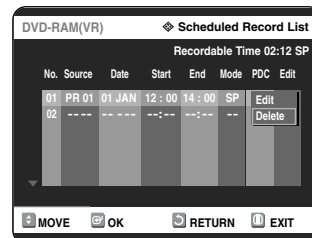

- 5** Press the **▲▼** buttons to select **Delete**, then press the **OK** or **▶** button.
- You will be prompted with the delete confirm message such as ‘Do you want to delete No.01?’.

- 6** Press the **◀▶** buttons to select **Yes**, then press the **OK** button.
- The selected entry will be deleted from the list.

- 7** Press the **MENU** button after finishing the operation. The menu screen will disappear.

Deleting the Scheduled Record List



Follow these directions to delete an entry from the scheduled record list.

- 1** With the unit in Stop mode, press the **TIMER** button.

Using the MENU button.

- With the unit in Stop mode, press the **MENU** button.
- Press the **▲▼** buttons to select **Programme**, then press the **OK** or **▶** button.
- Press the **▲▼** buttons to select **Timer Record**.

- 2** Press the **OK** or **▶** button.

Using the Video Plus+ Feature

Before presetting your DVD Recorder:

- Switch on both the television and your DVD Recorder.
 - Check that the date and time are correct.
- Up to twelve programmes can be preset.

1 With the unit in Stop mode, press the **TIMER** button. Press the **▲▼** buttons to select **Video Plus+**, then press the **OK** or **▶** button.

- A message is displayed to allow you to enter the Video Plus+ code.

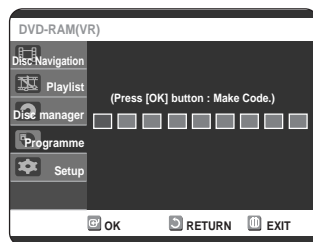

Using the MENU button.

- With the unit in Stop mode, press the **MENU** button.
- Press the **▲▼** buttons to select **Programme**, then press the **OK** or **▶** button twice.

2 Press the number buttons to enter the code of the programme that you want to record in your television magazine.

- If you want to correct the Video Plus+ code that you are entering:
- Press the **◀** button until the digit to be corrected is cleared.
- Enter the correct digit.

3 Press the **OK** button.

- The information concerning the programme is displayed.
- When using the Video Plus+ function for the first time with stored stations, the programme number flashes. This one time, you must enter the PR number manually by pressing the **▲▼** buttons or number buttons.

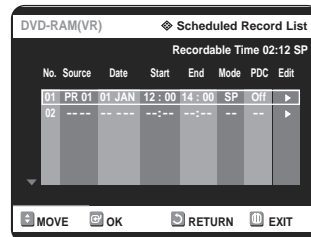
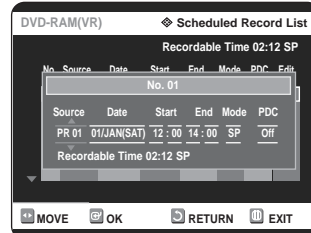

4 If the programme and times are correct, press the **OK** button.

5 Turn the power off by pressing the **STANDBY/ON** button to activate the timer recording setting.

6 Refer to pages 46~48 if you want to:

- Check whether the timer Recording has set correctly or not.
- Cancel a preset recording.



NOTE

- The numbers next to each TV programme listing in the magazines or newspapers are Video Plus+ code numbers, which allow you to programme your DVD Recorder instantly with the remote control. Enter the Video Plus+ code for the programme you wish to record.
- Video Plus+ is a trademark of Gemstar Development Corporation. The Video Plus+ system is manufactured under license from Gemstar Development Corporation.

Video Plus+ Extended

To prevent delays or overruns, DVD Recorder has a function called Video Plus+ Extended allowing you to extend the recording time by up to 60 minutes.

- 1 With the unit in Stop mode, press the **MENU** button.

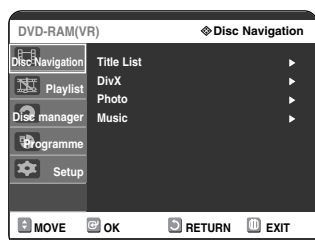

- 2 Press the **▲▼** buttons to select **Programme**, then press the **OK** or **▶** button.

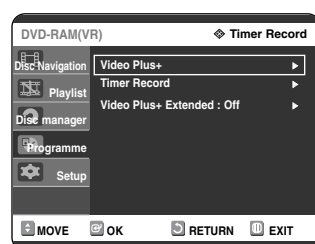

- 3 Press the **▲▼** buttons to select **Video Plus+ Extended**, then press the **OK** or **▶** button

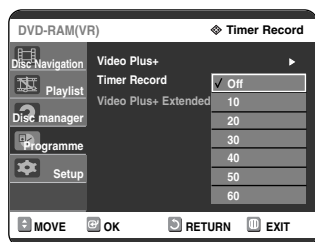

- 4 Press the **▲▼** buttons to select Video Plus+ Extended time, then press the **OK** or **▶** button.

- 5 Press the **MENU** button after finishing the operation.

Recording the Standard Timer List

When the start time in the Scheduled record list reaches while the set is in power off, the set will be powered on and start the recording automatically.

- 1 When the scheduled recording is operating, the programme being recorded will not display on TV.
 - Press the **TV/DVD** button if you want to see the programme being recorded on TV.
 - Press the **TV/DVD** button again if you don't want to see the programmed being recorded on TV.

To stop Recording

Press the **STOP** (⏻) button, and a message that asks whether to end recording or not will be displayed.



- When **Yes** is selected: Recording stops
- When **No** is selected: Recording continues



NOTE

- If there is not enough disc space or a copy prevention signal is received during recording, recording will stop.

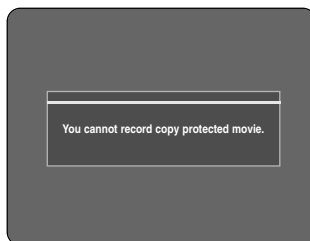

- If there is no free disc space or the disc is not recordable, recording will not operate. (You can record after replacing the disc.)

Playback

This section introduces basic functions of playback and playback by disc type.



Before Playing.....	51
Playing a Disc	52
Playing an Audio CD/MP3	61
Playing a Picture CD	65
Playing an MPEG4.....	66
Playing the Title List.....	67

Before Playing

Read the following information before playing a disc.

Region code (DVD-Video only)



Both the DVD recorder and the discs are coded by region. These regional codes must match in order for the disc to play. If the codes do not match, the disc will not play. The Region Number for this DVD Recorder is described on the rear panel of the DVD Recorder.

Disc types that can be played

Disc Types	Disc Logo	Recorded content	Disc Shape	Max. Playing Time
DVD-VIDEO		AUDIO + VIDEO	Single sided(12cm)	240
			Double sided(12cm)	480
			Single sided(8cm)	80
			Double sided(8cm)	160
AUDIO-CD		AUDIO	Single sided(12cm)	74
			Single sided(8cm)	20
DVD-RAM		AUDIO + VIDEO	Single-sided 12cm (4.7GB)	1 (XP: Excellent Quality) 2 (SP: Standard Quality) 4 (LP: Long Playback) 6 or 8 (EP: Extended)
			Double-sided 12cm (9.4GB)	2 (XP: Excellent Quality) 4 (SP: Standard Quality) 8 (LP: Long Playback) 12 or 16 (EP: Extended)
DVD-RW		AUDIO + VIDEO	12cm (4.7GB)	1 (XP: Excellent Quality) 2 (SP: Standard Quality) 4 (LP: Long Playback) 6 or 8 (EP: Extended)
DVD-R		AUDIO + VIDEO	12cm (4.7GB)	1 (XP: Excellent Quality) 2 (SP: Standard Quality) 4 (LP: Long Playback) 6 or 8 (EP: Extended)
CD-R/RW DVD-R/RW/RAM		JPEG MP3 MPEG4	-	-



NOTE

- Depending on the disc type, it may take up to one minute to load.

Discs that cannot be played

- DVD-Video with a region number other than "2" or "ALL"
- 12cm 2.6 GB and 5.2 GB DVD-RAM
- 3.9 GB DVD-R Disc for Authoring.
- DVD-RAM, DVD-RW(VR mode) not recorded following the Video Recording Standard
- Unfinalised DVD-R, unfinalised DVD-RW(V mode) recorded on other equipment.
- DVD-ROM/DVD+RW/PD/MV-Disc, etc
- CVD/CD-ROM/CDV/CD-G/CD-I



NOTE

- This DVD recorder can only operate with discs that are compatible with DVD-RAM Standard Version 2.0.
- Playback and/or recording may not work for some types of discs, or when specific operations, such as angle change and aspect ratio adjustment, are being performed. Information about the discs is written in detail on the box. Please refer to this if necessary.
- Do not allow the disc to become dirty or scratched. Fingerprints, dirt, dust, scratches or deposits of cigarette smoke on the recording surface may make it impossible to use the disc for recording.
- DVD-RAM/RW/R discs may not be able to play on some DVD Recorders, depending on the DVD recorder, disc and the condition of the recording.

2 Place a disc gently into the tray with the disc's label facing up.

3 Press the **OPEN/CLOSE** button to close the disc tray.

- Your DVD Recorder closes the disc tray and plays the disc automatically.
- The recorder does not play discs automatically after the initial power on.
- When the recorder is powered on and a disc is in the tray, the DVD recorder will be activated and wait in stop status.
- Press the **PLAY** button to start playback.
- If you insert a MP3 Disc, your DVD Recorder will display the file list on the screen and start playing.
- If you insert a JPEG Disc, folders and files are displayed in the thumbnail picture.
- If you want the DVD recorder to play automatically when it is powered on with a disc in the DVD recorder, power on with the **PLAY** button.

4 Press the **STOP** button to stop playback.

Playing a Disc

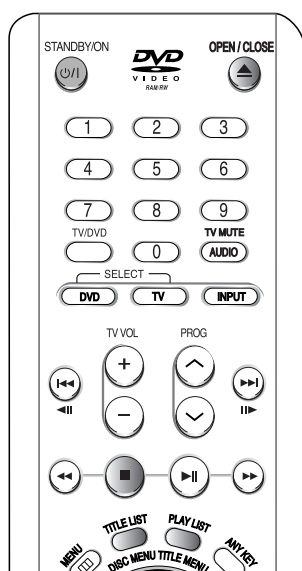

1 Press the **OPEN/CLOSE** button.



NOTE

- When you stop playing disc, the recorder remembers where you stopped. When you press the **PLAY** button again, it will pick up where you left off. (unless the disc is removed or the DVD Recorder is unplugged, or if you press the **STOP** button twice.)



CAUTION

- Do not move your DVD Recorder while playing, as this may cause damage to the disc.
- Make sure to press the **OPEN/CLOSE** button to open or close the disc tray.
- Do not push the disc tray while it is being opened or closed, as this may cause a product malfunction.
- Do not place foreign materials on or in the disc tray.
- Some functions may perform differently or be disabled depending on the disc type. If this occurs, refer to the instructions written on the disc case.
- Be especially careful that children's fingers are not caught between the disc tray and the tray chassis when it closes.
- You must only insert one DVD disc at a time. Inserting two or more discs will not allow playback and may cause damage to the DVD recorder.

Using the Disc Menu & Title Menu

Some discs contain a dedicated menu system that allow you to select special functions for the title, such as chapters, audio tracks, subtitles, film previews, information on characters, etc.

For DVD-VIDEO discs



- 1 Press the **DISC MENU** button to enter the disc menu of the disc.
 - Move to the setup menu related to the playback operation.
 - You can select the audio languages and the subtitles provided by the disc.

- 2 Press the **TITLE MENU** button to move to the title menu of the disc.
 - Use this button if the disc contains more than one title. Some type of discs may not support the title menu function.

For DVD-RAM/RW/R discs



- 1 Press the **TITLE LIST** button to move to the Title List.



NOTE

- **Title List:** Title List shows a list to help you select a title. Since the title list consists of the information on video that is actually recorded, if one title is deleted, that title cannot be played again.
- **Play List:** This refers to a DVD recorder of playback, which is made by selecting a desired scene in the entire Title List. When one playlist is played, only the scene selected by the user will play and then stop. Since only the information necessary for playing a desired scene is included in a playlist, even if that playlist is deleted, the original recording will not be deleted. (only VR mode)

Using the Search Functions

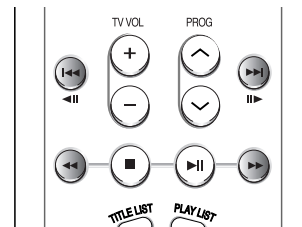

Searching through a Chapter or Track



- 1 During play, press the **SEARCH** (↶↷) button on the remote control.

DVD-VIDEO/ DVD-RAM/ DVD-RW/DVD-R	▶▶ Fast X 2 → ▶▶ Fast X 4 → ▶▶ Fast X 8 → ▶▶ Fast X 16 → ▶▶ Fast X 32 → ▶▶ Fast X 128 → ▶▶ Fast X 2
MPEG4 AUDIO CD (CD-DA)	▶▶ X 2 → ▶▶ X 4 → ▶▶ X 8 → ▶▶ X 2

- You can scan the programme in reverse.
To return to normal speed playback, press the (⏪) button.
- When you press and hold the **SEARCH** button. (↶↷), playback is done at the default speed of 4X. If you release the **SEARCH** button, playback is performed at a normal speed.
- The speed marked in this function may be different from the actual playback speed.



NOTE

- No sound is heard during Scan(Search) mode, except CDs (CD-DA).

Skipping Chapters or Tracks

- During play, you can search quickly through a chapter or track.

1 During play, press the **SKIP** () button on the remote control.

- If you press the **I◀◀** button, it moves to the beginning of the chapter or track or marker(DVD-RAM, DVD-RW(VR mode)). Pressing the button once again within 3 seconds returns to the beginning of the previous chapter or track or marker(DVD-RAM, DVD-RW(VR mode)).

- If you press the **▶▶I** button, it moves to the next chapter or track or marker (DVD-RAM, DVD-RW(VR mode)).

Slow Motion Play



1 In pause or step mode, press the **SEARCH** () button on the remote control.

- If you press the **▶▶** button,
▶ Slow 1/8 → ▶ Slow 1/4 → ▶ Slow 1/2

- If you press the **◀◀** button,
◀ Slow 1/8 → ◀ Slow 1/4 → ◀ Slow 1/2

- To return to normal speed playback, press the **⏪** button.

Press and hold the **SEARCH** () button during pause, the disc will play slowly at a 1/4 speed. If the button is released, the pause operation will resume.



NOTE

- The speed marked in this function may be different from the actual playback speed.
- Slow motion operates only in the forward direction on MPEG 4 discs.

Step Motion Play



1 Press the **◀** () button on the remote control in the still mode.

- Each time the button is pressed, a new frame will appear.
When **◀** is pressed, the previous frame will be activated.
When **▶** is pressed, the next frame will be activated.
- To return to normal speed playback, press the **⏪** button.



NOTE

- Step motion operates only in the forward direction on MPEG 4 discs.

About ANYKEY

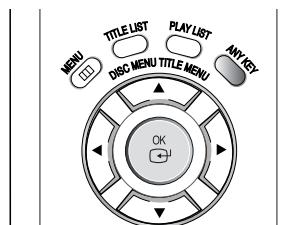

The ANYKEY function allows you to easily search for a desired scene by accessing title, chapter, track, time. You can also change the subtitle and audio settings and set some features including Repeat, Angle, Zoom.

Moving to a scene directly using the ANYKEY

- If you want to move to a title, a chapter or a track to find a desired scene.

1 Press the **ANYKEY** button during playback.



2 Press the **▲▼** buttons to select **Title, Chapter or Track**.



3 Press the **◀▶** or number (0~9) buttons to select the desired scene. Press the **OK** button.

- If you want to move to a desired time to help you find a scene.

1 Press the **ANYKEY** button during playback.



2 Press the **▲▼** buttons to select **Time**.



3 Enter the time in the sequence of hours, minutes, seconds using the number buttons, then press the **OK** button.



NOTE

- This may not work for some discs. When an audio CD(CD-DA) or an MP3 disc is inserted, according to a disc type, the information display may not be appear.
- The Time Search function does not operate in some discs.
- To make the screen disappear, press the ANYKEY again

Using the Repeat Function

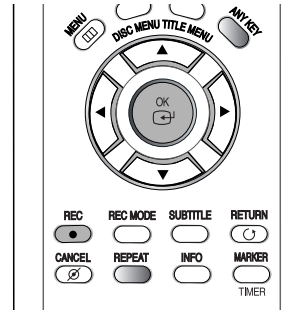

Playing Repeatedly(Repeat Playback)



Using the REPEAT button

1 Press the **REPEAT** button during playback.

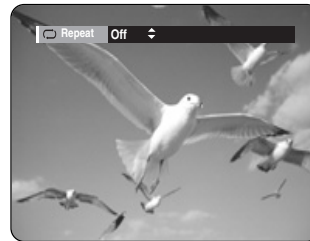

2 Press the **REPEAT** or **▲▼** buttons to select **Title** or **Chapter** you want to play repeatedly. Press the **OK** button.

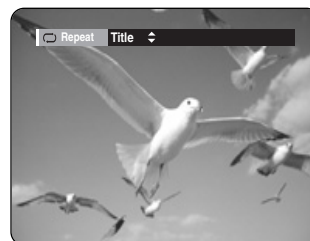

Chapter : Repeats the chapter that is playing.
Title : Repeats the title that is playing.

- To return to normal playback -

3 Press the **REPEAT** buttons to select **Off**, then press the **▲▼** or **REPEAT** button and press **OK** button.
 Press the **CANCEL** button to return to normal playback.

ANYKEY Using the ANYKEY button

- 1 Press the **ANYKEY** button during playback.



- 2 Press the **▲▼** buttons to select **Repeat**, then press the **◀▶** buttons to select **Title** or **Chapter** you want to play repeatedly. For A-B Repeat, refer to page 57.



- 3 Press the **OK** button. To make the screen disappear, press the **ANYKEY** or **RETURN** button. Repeat play allows you to repeat a title or chapter.



- DVD-RAM, DVD-RW(VR mode), unfinalised DVD-R and unfinalised DVD-RW (Video mode) do not repeat a chapter.

Playing Repeatedly(Repeat Playback)



Using the REPEAT button

- 1 Press the **REPEAT** button during playback.

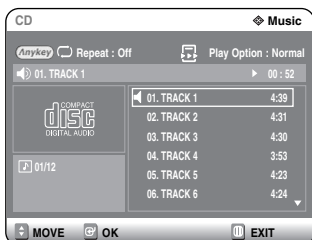

- 2 Press the **REPEAT** button repeatedly to select **Track** or **Disc** you want to play repeatedly.

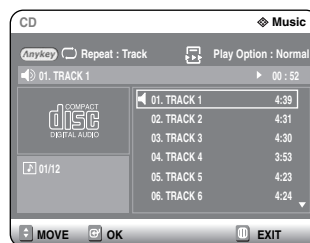

To return to normal playback

- 3 Press the **REPEAT** button repeatedly to select **Off**. Press the **CANCEL** button to return to normal playback.

ANYKEY Using the ANYKEY button

- 1 Press the **ANYKEY** button during playback. Repeat is highlighted.

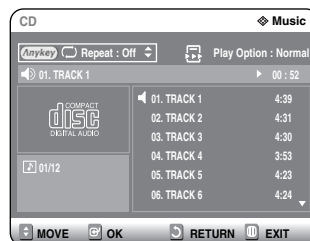

- 2 Press the **REPEAT** or **▲▼** buttons to select **Track** or **Disc** you want to play repeatedly. Press the **OK** button. For MP3 discs, you can select **Track**, **Folder** or **Disc**.

- To return to normal playback -

- 3 Press the **REPEAT** button repeatedly to select **Off**. Press the **CANCEL** button to return to normal playback.

Playing a Certain section Repeatedly(A-B Repeat Playback)



Using the ANYKEY button

- 1 Press the **ANYKEY** button during playback.



- 2 Press the **▲▼** buttons to select **Repeat**, then press the **▶** button to select **A-B**.



- 3 Press the **OK** button.

- 4 Press the **OK** button at the point where you want the repeat play to start (A), then press it again at the point where you want the repeat play to stop (B).
Repeat playback of the A-B section starts.

- To return to normal playback -

Select "Off" on the Repeat item.
Press the **CANCEL** button to return to normal playback.



- If you set point (B) before five seconds has lapsed, the prohibition mark (⊘) will appear.
- Audio CDs(CD-DA), MP3 and MPEG4 discs do not support the Repeat A-B function.

Selecting the Subtitle

Subtitle languages may not work depending on the disc type. This is only available during playback.



(VR mode)



Using the SUBTITLE button

- 1 Press the **SUBTITLE** button during playback.

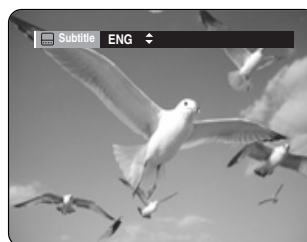

- 2 Press the **SUBTITLE** or **▲▼** buttons to select the desired subtitle language.
To make the screen disappear, press the **CANCEL** or **RETURN** button.



Using the ANYKEY button

- 1 Press the **ANYKEY** button during playback.



- 2 Press the **▲▼** buttons to select **Subtitle**, then press the **◀▶** buttons to select the desired subtitle language.



- The subtitle display may be different depending on the disc type.
- Some discs allow you to select the language for the disc menu only.

Selecting the Audio language

Audio languages may not work depending on the disc type. This is only available during playback.



(VR mode)



Using the AUDIO button

- 1 Press the **AUDIO** button during playback.



- 2 Press the **AUDIO** or **▲▼** buttons to select the desired audio language.



Using the ANYKEY button

- 1 Press the **ANYKEY** button during playback.



- 2 Press the **▲▼** buttons to select **Audio**, then press the **◀▶** buttons to select the desired audio language.



NOTE

- Audio languages may be different depending on the disc type.
- Some discs allow you to select the audio language for the disc menu only.

Changing the Camera Angle

When a DVD-VIDEO contains multiple angles of a particular scene, you can select the Angle function. This is only available during playback.

If the disc contains multiple angles, the **ANGLE** mark appears on the screen.



- 1 Press the **ANYKEY** button during playback.



- 2 Press the **▲▼** buttons to select **Angle**, then press the **◀▶** or number buttons to select the desired angle.



NOTE

- This function is disc-dependent, may not work on all DVDs.
- This function does not work when a DVD has not been recorded with a multi-camera angle system.

Zooming-In



- 1 Press the **ANYKEY** button during playback or pause.



- 2 Press the **▲▼** buttons to select **Zoom**, then press the **OK** button. (🔍) will be displayed.



- 3 Press the **▲▼◀▶** buttons to move to the area you want to enlarge.

- 4 Press the **OK** button. The screen will be enlarged to twice the normal size. If you press the **OK** button again after the screen was enlarged to twice the normal size, the screen size will be enlarged to four times the normal size.

→ normal size → 2X → 4X → 2X



NOTE

- When the recording is done in EP mode, the Zoom function is not supported except when the recording has been done in V mode.

Using Bookmarks

This feature lets you bookmark sections of a DVD-VIDEO or DVD-R/-RW(V mode), so you can quickly find them.



- 1 Press the **MARKER** button during playback.

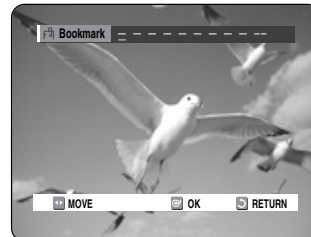

- 2 Press the **OK** button when the desired scene appears. The number 1 is displayed and the scene is memorized.



- 3 Press the **◀▶** button to move to the next position.

- 4 Press the **OK** button when the desired scene appears. The number 2 is displayed and the scene is memorized.

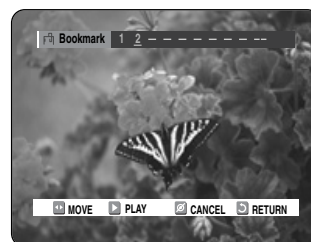

- Repeat above to bookmark other positions.
- You can bookmark up to 10 scenes.



NOTE

- When the disc tray is opened and then closed, bookmarks will disappear.

Playing back a bookmark

- 1 Press the **MARKER** button during playback.
- 2 Press the ◀▶ buttons to select a bookmarked scene.

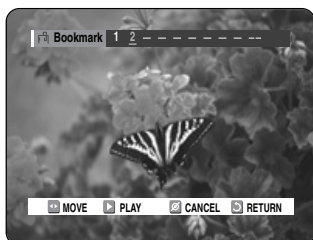

- 3 Press the **OK** or ⏵ button to start playing from the selected scene.

Clearing a bookmark

- 1 Press the **MARKER** button during playback.
- 2 Press the ◀▶ buttons to select a bookmarked scene.

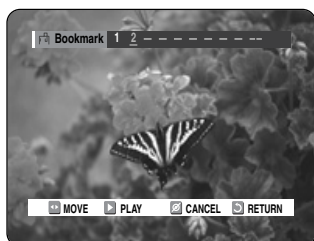

- 3 Press the **CANCEL** button to delete the selected bookmark.

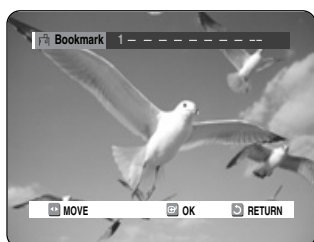

Using Markers



(VR mode)

- 1 Press the **MARKER** button during playback.

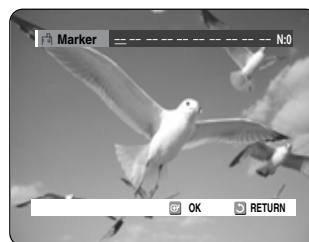

- 2 Press the **OK** button when the desired scene appears. The number 01 is displayed and the scene is memorized.

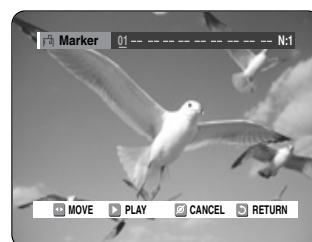

- 3 Press the ◀▶ button to move to the next position.

- 4 Press the **OK** button when the desired scene appears. The number 02 is displayed and the scene is memorized.

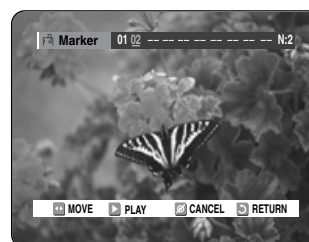

- DVD-RAM or DVD-RW (VR Mode) discs have the Marker function instead of the Bookmark function. The Marker function allows you to mark up to 99 scenes. Since the scenes may be displayed as many different pages, numbering is necessary. If a disc in use is encoded with Disc Protection, Markers cannot be set or deleted. Only playback is available.

Playing back a Marker

- 1 Press the **MARKER** button during playback.
- 2 Press the ◀▶ buttons to select a bookmarked scene.

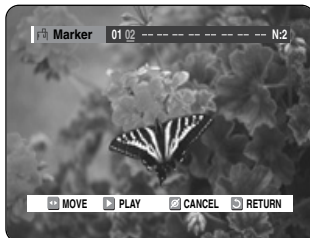

- 3 Press the **OK** or ⏪ button to start playing from the selected scene.

- If you press the ⏪ button, it moves to the beginning of the marker. Pressing the button once again within 3 seconds returns to the beginning of the previous marker.
- If you press the ⏩ button, it moves to the next marker.

Clearing a Marker

- 1 Press the **MARKER** button during playback.
- 2 Press the ◀▶ buttons to select a bookmarked scene. Press the **CANCEL** button to delete the selected bookmark.

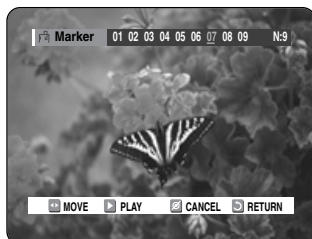

- When a marker is cleared while DVD-RAM/-RW (VR mode) is playing, marker numbers will change. For example, if the 7th marker is cleared after ten markers are registered, the marker numbers after the eighth will automatically move ahead by one and the 8th marker becomes the 7th.

Playing an Audio CD/MP3

Playing an Audio CD (CD-DA)/MP3

Each disc has a variety of menu functions available.



Playing an Audio CD(CD-DA)

- 1 Insert an audio CD (CD-DA) into the disc tray. The audio CD menu appears and the tracks (songs) are played automatically.



- 2-1 Press the ▲▼ buttons to select the track you want to hear, then press the **OK** or ▶ button.

- 2-2 Press the number buttons to select the track (song) and the track (song) is played automatically.

Audio CD(CD-DA) Screen Elements

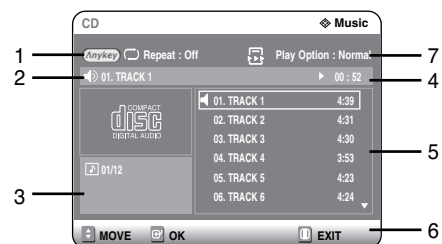

1. **Repeat mode:** Repeat off/Repeat Track/Repeat Disc
2. **Current track (song):** Displays the number of the track currently being played.
3. Displays the current play index and total track number.
4. This shows the operating state of a disc and a playback time corresponding to a portion that is currently played.
5. Displays the track list (song list) and the playing time of each track.
6. Button display.
7. **Play Option:** Normal, Random, Intro or Playlist

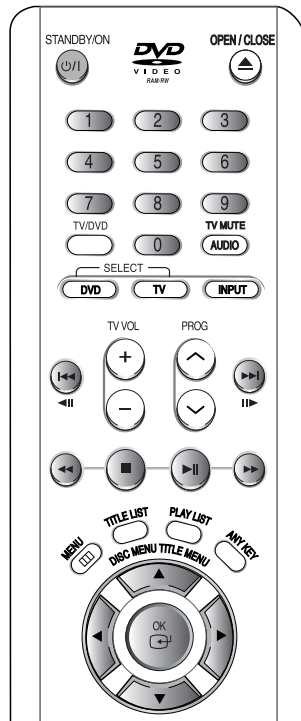

1. **▲▼, 0~9:** Selects a track (song).
2. **▶:** Plays the selected track (song).
3. **OK button:** Plays the selected track (song).
4. **(⏸) button:** Plays the next track.
5. **(⏮) button:** Returns to the beginning of the current track when pressed during playback. If pressed again, your DVD recorder moves to and plays the previous track.
If you press the this button within three seconds after playback starts, the previous track will be played.
If you press the this button after three seconds, the current track will be replayed from the beginning.
6. **Press the (⏮/⏭) button:** Fast Play (X2, X4, X8)
7. **(⏸) button:** Stops a track(song).
8. **(⏮) button:** Plays a track(song) or pauses playback.
9. **ANYKEY button:** To select the top menu on screen display (Repeat or Play Option).



- 1 Insert an MP3 Disc into the disc tray.

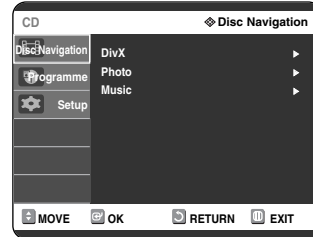

- 2 Press the **▲▼** buttons to select the **Disc Navigation**, and then press the **OK** or **▶** button.

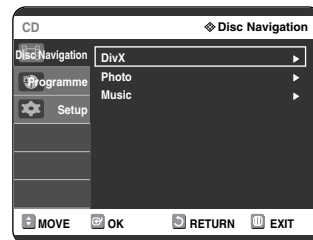

- 3 Press the **▲▼** buttons to select the **Music**, and then press the **OK** or **▶** button.

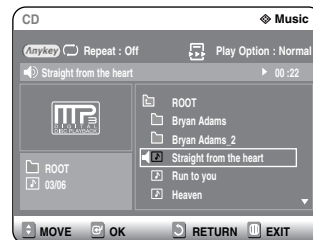

The MP3 menu appears and the tracks(songs) are played automatically.

- 4-1 Press the **▲▼** buttons to select the track (song) you want to hear, then press the **OK** or **▶** button.

- 4-2 Press the number buttons to select the track (song) and the track (song) is played automatically.

MP3 Screen Elements

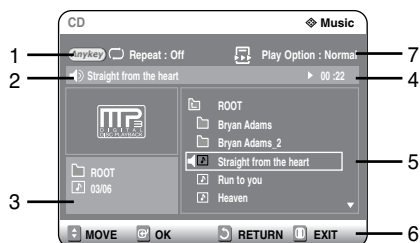

1. **Repeat mode:** Repeat off, Repeat Track, Repeat Folder or Repeat Disc
2. **Current track (song):** Displays the name of the track being played.
3. Displays the current folder and play index.
4. This shows the operating state of a disc and a playback time corresponding to a portion that is currently played.
5. Displays the information for the folder and its tracks.
6. Button display.
7. **Play Option :** Normal, Random, Intro or Playlist

Buttons on the Remote Control used for MP3 playback

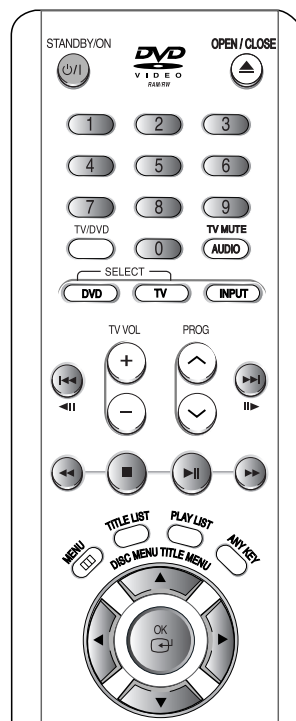

1. **▲▼, 0~9:** Selects a track (song).
2. **▶ :** Plays the selected track (song).
3. **OK button:** Plays back the selected track (song) or displays the files in the selected folder.
4. **RETURN button:** Moves to the folder to which the current song belongs.
5. **(⏸) button:** Plays the next track.
6. **(⏮) button:** Returns to the beginning of the current track when pressed while playing. If pressed again, your DVD recorder moves to and plays the previous track.
If you press the this button within three seconds, the previous track will be played.
If you press the this button after three seconds, the current track will be replayed from the beginning.
7. **(⏹) button:** Stops a track(song).
8. **(⏪) button:** Plays a track(song) or pauses playback.
9. **ANYKEY button:** To select the top menu on screen display (Repeat or Play Option).



NOTE

- Files of one type: List of files and folders appears in a defined order.
- Files of multiple types: Topmost GUI menu screen (DISC NAVIGATION) appears.

Play Option Mode

The Play Option can be used with an audio CD or MP3 in the Play or Stop mode.



- 1 Press the **ANYKEY** button during playback. Repeat Mode will be highlighted.

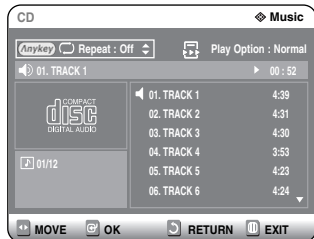

- During Stop, Play Option will be highlighted.

- 2 Press the **◀▶** buttons to select **Play Option**, then press the **▲▼** buttons to select the desired play option (Normal, Random, Intro or Playlist).

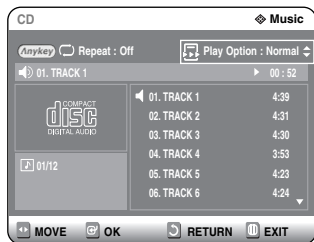

- 3 Press the **OK** button.

- **Normal:** Tracks on a disc are played in the order in which they were recorded on the disc.
- **Random:** The Random option plays a disc's tracks in random order. After a random list is generated and played completely, another random list is generated and played. Random Play is continued until the play option is changed.
- **Intro:** The first 10 seconds of each track will be played. If you want to listen to the music that you have selected, press the **OK** or **↻** button. The play option will be changed to Normal Play. When Intro Play is completed, Normal Play is performed.
- **Playlist:** The Playlist playback option allows you to select the order in which you want tracks to play.

To Programme Tracks

You can register a maximum of 30 tracks in the playlist.

- 1 Press the **ANYKEY** button during playback. Repeat Mode will be highlighted.

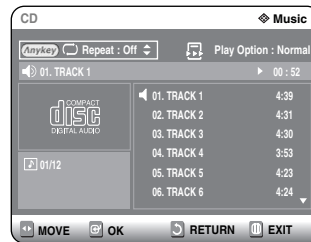

- 2 Press the **◀▶** buttons to select Play Option.

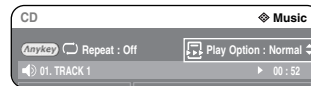

- 3 Press the **▲▼** buttons to select Playlist and then press the **OK** button.

- 4 Press the **▲▼** buttons to select Tracks in the order in which you want them to play and then press **OK** button.

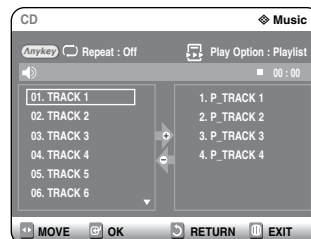

- 5 If you playlisted a wrong track, press the **▶** button, then press the **▲▼** buttons to select wrong track, then press the **CANCEL** button.

The wrong track will be removed.



- 6 Press the **PLAY** button to playback the playlist.

Playing a Picture



1 Insert a JPEG into the disc tray.

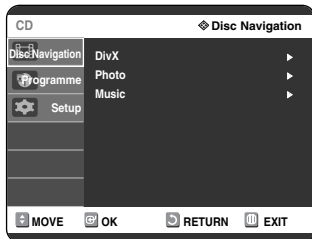

2 Press the ▲▼ buttons to select the **Disc Navigation**, and then press the OK or ► button.

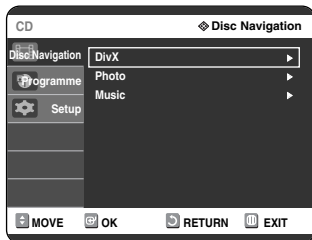

3 Press the ▲▼ buttons to select the **Photo**, and then press the OK or ► button.

4 Press the ▲▼◀▶ buttons to select a picture.

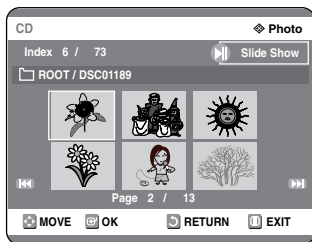

- To see the next 6 pictures, press the ⏸ button.
- To see the previous 6 pictures, press the ⏮ button.

5-1 If you press the **PLAY**(▶) button, the Slide show screen will appear. Press the ◀▶ buttons to set the slide show speed, then press the **OK** button.

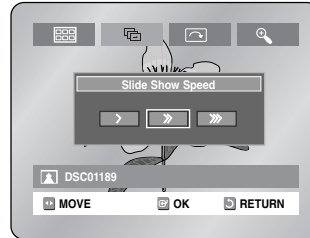

5-2 Press the ◀▶ buttons to select a picture file in Album screen, then press the **OK** button.

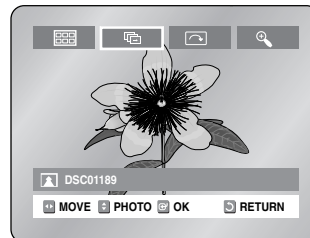

- ⏮ : Returns to the Album screen.
- ▶ : The DVD recorder enters slide show mode. Before the slide show can begin, the picture interval (Slide show speed) must be set.
- ⏸ : Each time the **OK** button is pressed, the picture rotates 90 degrees clockwise.
- 🔍 : Each time the **OK** button is pressed, the picture is enlarged up to 4X(Four times the normal size). (Normal → Zoom 2X → Zoom 4X → Zoom 2X → Normal)
- Press the **ANYKEY** button to display or clear menus.

Playing an MPEG4

MPEG4 File is used to contain the audio and video data.
MPEG4 File with following extensions can be played.
- .AVI, .DIVX

1 Insert an MPEG4 Disc into the disc tray.

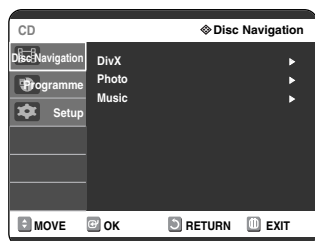

2 Press the ▲▼ buttons to select the **Disc Navigation**, and then press the OK or ► button.

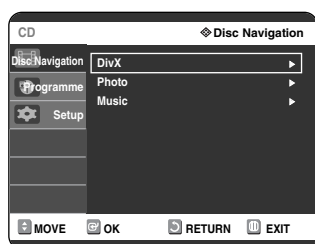

3 Press the ▲▼ buttons to select the **DivX**, and then press the OK or ► button.

4 Press the ▲▼ buttons to select the avi file (DivX), then press the OK, ► or ►|| button.

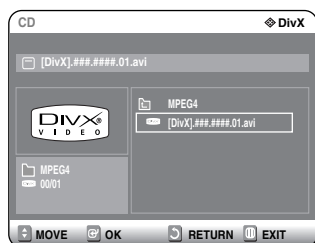

5 When MPEG4 file is played, you can use following functions.
Pressing the **STOP** button once during playback will display the file list, pressing the button again will exit the menu screen.

MPEG4 Function Description

Function	Description
Skip (◀◀ or ▶▶)	During play, press the ◀◀ or ▶▶ button, it moves forward or backward 5 minutes.
Search (◀◀ or ▶▶)	During play, press the SEARCH (◀◀ or ▶▶) button and press again to search at a faster speed. (2X, 4X, 8X)
Slow Motion Play	In pause or step mode, press the SEARCH ⏪ button on the remote control. (1/8X, 1/4X, 1/2X)
Step Motion Play	Press the ⏸ button on the remote control in the still mode.



NOTE

- This DVD recorder can play the following video compression formats,
 - MPEG4 Codec format : DivX 3.11 DivX 4.x DivX 5.x DivX-Pro (without QPEL and GMC)
 - Audio format : .MP3, .MPEG, .WMA, .LPCM, .AC3
- Supported subtitle file formats: .smi, .srt, .sub, .psb, .txt, .ass (The subtitle file should have exactly the same name to corresponding MPEG4 file name)
- Some MPEG4 files created on a personal computer may not be play back. That is why Codec Type, Version and Higher resolution over specification is not supported.

Playing the Title List



Follow these instructions to play back a scene from the Title List.



Using the TITLE LIST button

- 1 Press the **TITLE LIST** button.
The Title List screen is displayed.

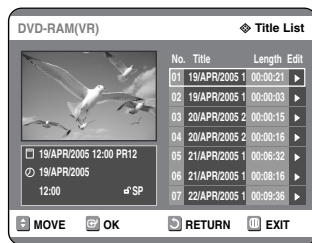

- 2 Press the **▲▼** buttons to select an entry you want to play from Title List, then press the **PLAY (⏪)** button.
The selected entry (title) will be played back.

- 3 To stop title play, press the **STOP** button.
To return the title list screen, press the **TITLE LIST** button.

Using the MENU button

- 1 Press the **MENU** button.

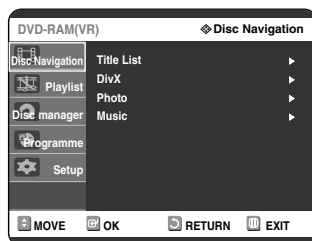

- 2 Press the **▲▼** buttons to select **Disc Navigation**, then press the **OK** or **▶** button twice.
The Title List screen is displayed.

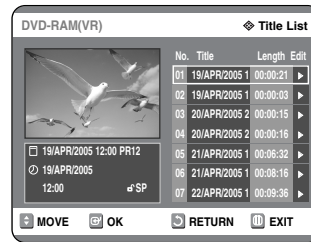

- 3 Press the **▲▼** buttons to select **Title**, then press the **OK** or **▶** button.
The Edit menu is displayed on the right.

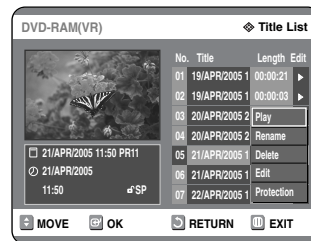

(Play, Rename, Delete, Edit, Protection : See pages 70~73)

- 4 Press the **▲▼** buttons to select **Play** to play the title list, then press the **OK** button.
The selected entry (title) will be played back.

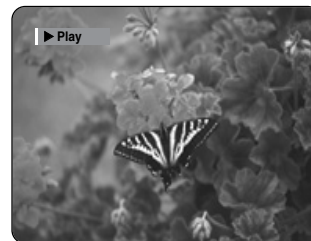

Playback

To view the current status of the disc and progress of playback : Press the **INFO** button, the information about the disc will appear.

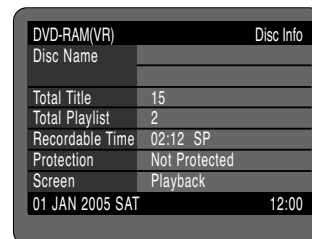

Press the **INFO** button once again. Then you can check the information about the title under playback.



- 5** To stop title play, press the **STOP** button. To return the title list screen, press the **TITLE LIST** button.



NOTE

- You can also play a recorded programme by pressing the **ANYKEY** button during playback.

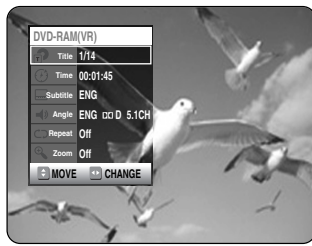

- Press the **▲▼** buttons to select Title.
- Press the **◀▶** buttons to select to play the title list, then press the **OK** button.

Title List Screen Elements

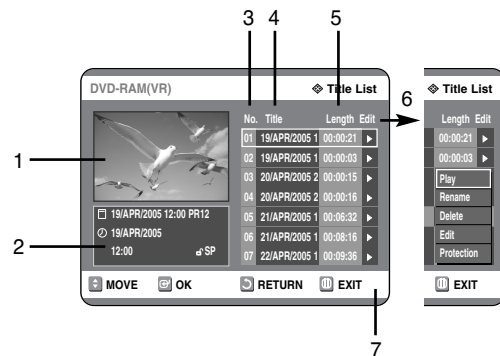

- Playback screen for recorded entries.
- Information window for the selected entry:
Title name, recording date, recording time, lock status, recording mode
- Recorded entry No.
- Recorded entry title
- Recording length (i.e., the playing time)
- Title list edit items
Play: Plays the selected entry.
Rename: Renames the title of a selected entry.
Delete: Deletes the selected entry from the list.
Edit: Deletes a section of titles.
Protection: Locks or unlocks the selected entry.
- Button display.



NOTE

- This may depend on the the disc type.
- DVD-R/DVD-RW(Video) has limited editing function.



Editing

This section introduces basic functions of DVD editing and explains both edit functions for the recording on a disc and edit functions for the entire disc.

Basic Editing (Title List)	70
Advanced Editing (Playlist)	74
Disc Manager	82

- Title List**
 A title is a section of recorded video and audio. Title List shows a list to help you select a title. Since the title list consists of the information on stream that is actually recorded, if one title is deleted, that title cannot be played again.
- Play List**
 This refers to a DVD recorder of playback, which is made by selecting a desired scene in the entire Title List. When one playlist is played, only the scene selected by the user will play and then stop. Since only the information necessary for playing a desired scene is included in a playlist, even if that playlist is deleted, the original stream will not be deleted.

Recording or editing might not be completed if an error, such as a sudden power failure occurs.

Please be aware that a material that has been damaged is unable to be retrieved to its original content.

Basic Editing (Title List)

Renaming(Labeling) a Title

Follow these instructions to rename a title list entry, i.e., to edit the title of a recorded programme.



Using the TITLE LIST button

- 1 Press the **TITLE LIST** button.
The Title List screen is displayed

Using the MENU button

- Press the **MENU** button.
- Press the **▲▼** buttons to select **Disc Navigation**, then press the **OK** or **▶** button twice.

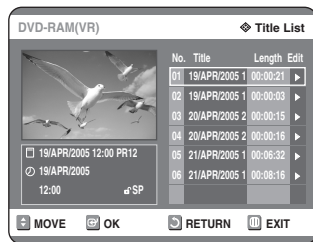

- 2 Press the **▲▼** buttons to select an entry you want to rename from the **Title List**, then press the **OK** or **▶** button.

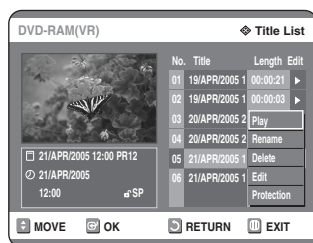

- 3 Press the **▲▼** buttons to select **Rename**, then press the **OK** button.
The Rename screen is displayed.



- 4 Press the **▲▼◀▶** buttons to select the desired characters, then press the **OK** button.

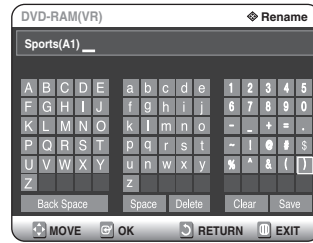

- **Back Space:** Deletes and moves the cursor backwards by one position.
(Equivalent to the **CANCEL** button)
- **Space:** Enters a blank and moves the cursor one forward (to the right).
- **Delete:** Deletes the character at the cursor position.
- **Clear:** Deletes all the character inputs.
- **Save:** Registers the character inputs.

- 5 Press the **▲▼◀▶** buttons to select **Save**, then press the **OK** button.
The changed title name is displayed on the title item of the selected entry.

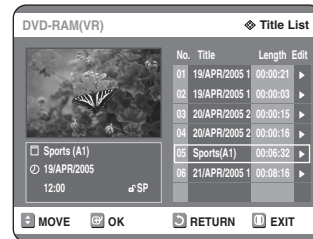

Locking(Protecting) a Title

Follow these instructions to lock an entry to protect it from accidental deletion.



Using the TITLE LIST button



- 1 Press the **TITLE LIST** button.
The Title List screen is displayed

Using the MENU button

- Press the **MENU** button.
- Press the **▲▼** buttons to select **Disc Navigation**, then press the **OK** or **▶** button twice.

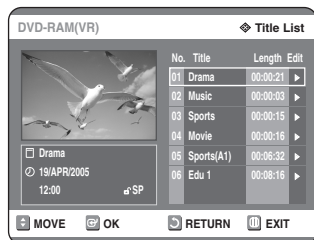

- 2 Press the **▲▼** buttons to select an entry you want to protect in the **Title List**, then press the **OK** or **▶** button.

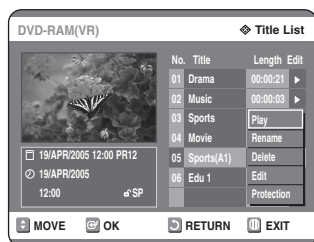

- 3 Press the **▲▼** buttons to select **Protection**, then press the **OK** or **▶** button.

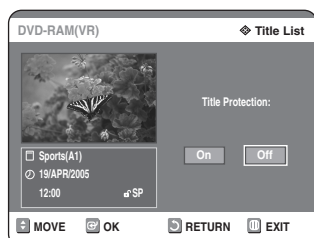
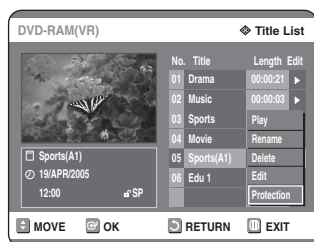

- 4 Press the **◀▶** buttons to select **On**, then press the **OK** button. The key icon on the information window for the selected entry changes to the locked status. (🔒→🔒)

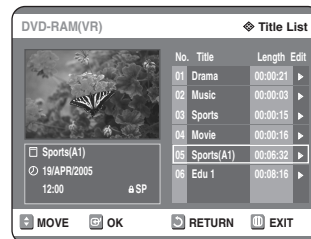

Deleting a Title

Follow these instructions to delete an entry from the Title List.



Using the TITLE LIST button

- 1 Press the **TITLE LIST** button.
The Title List screen is displayed

Using the MENU button

- Press the **MENU** button.
- Press the **▲▼** buttons to select **Disc Navigation**, then press the **OK** or **▶** button twice.

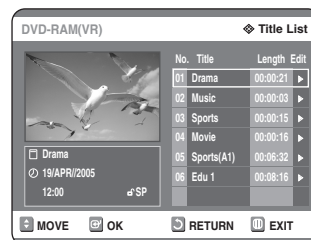

- 2 Press the **▲▼** buttons to select an entry you want to delete in the Title List, then press the **OK** or **▶** button.

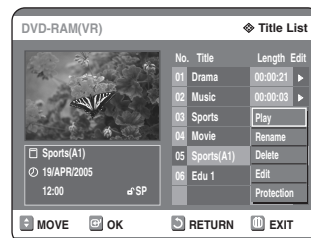

- 3 Press the ▲▼ buttons to select **Delete**, then press the **OK** or ► button.

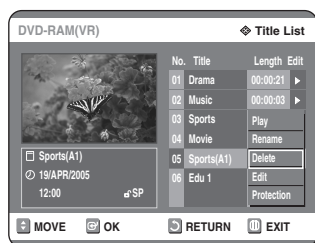

You will be prompted with a confirmation message.

DVD-RAM(VR), DVD-RW(VR mode):
Since Playlist is present, the message 'Do you want to delete?(Related Playlists may be deleted.)' is displayed.



DVD-RW(Video mode), DVD-R: Since Playlist is not present, the message 'Do you want to delete?' is displayed.

- The message may depend on the type of disc.

- 4 Press the ◀▶ buttons to select **Yes**, then press the **OK** button.



NOTE

- You cannot delete a protected entry. If you want to delete a protected entry, select "Off" in the Title Protection menu. (See page 71)
- When the Disc Protection has been set to Protected, you cannot delete titles. (See page 83)
- Once an entry is deleted from the Title List it cannot be recovered.
- Once DVD-R, DVD-RW is finalised, it cannot be deleted.
- With DVD-R, titles are only deleted from the menu however, the Title remains physically on the disc.

Deleting a Section of a Title

Follow these instructions to delete a section of a Title List entry.



Using the TITLE LIST button

- 1 Press the **TITLE LIST** button.
The Title List screen is displayed

Using the MENU button

- Press the **MENU** button.
- Press the ▲▼ buttons to select **Disc Navigation**, then press the **OK** or ► button twice.

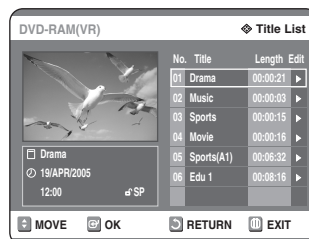

- 2 Press the ▲▼ buttons to select an entry you want to edit from the Title List, then press the **OK** or ► button.

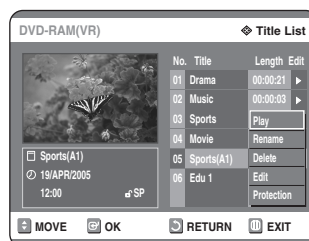

- 3 Press the ▲▼ buttons to select **Edit**, then press the **OK** or ► button.
The Edit Title List screen is display

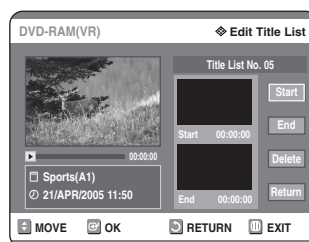

- 4** Press the **OK** button at the starting point. The image and starting point time are displayed in the section deletion starting point window.

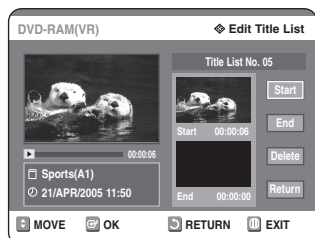

Edit Title List Screen Elements

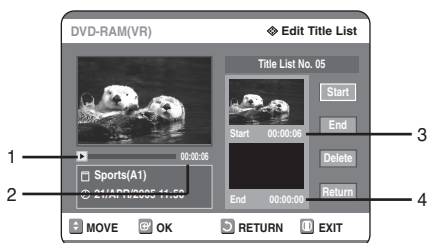

1. Playback bar
2. Playtime
3. Section deletion starting point window and time
4. Section deletion end point window and time
 - Select the start and end points of the section you want to delete using the playback related buttons.
 - Playback related buttons: (◀, ▶, ⏪, ⏩).

- 5** Press the **OK** button at the end point. The image and end point time are displayed in the Section deletion ending point window.

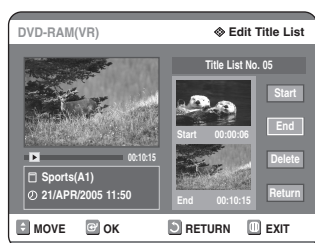

- 6** Press the **OK** button to select the **Delete**.

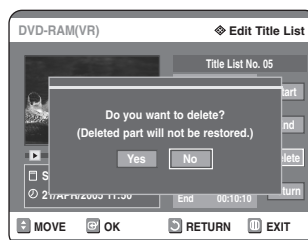
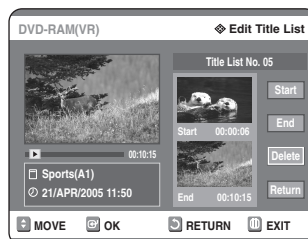

- 7** Press **◀▶** buttons to select **Yes**, then press the **OK** button. The selected section has been deleted. To return to the Title List screen, press the **▲▼** buttons to select Return.



NOTE

- The length of the section to be deleted must be at least 5 seconds long.
- If the length of the section to be deleted is less than 5 seconds, you will be prompted with the message 'The range is too short.'
- If the end time precedes the starting point, you will be prompted with the message 'End point cannot be marked earlier than start point'.
- The section cannot be deleted when it includes a still picture.
- Press the **MENU** button after the operation has finished. The Edit Title List screen will disappear.

Advanced Editing (Playlist)

Creating a Playlist

Follow these instructions to create a new playlist entry from a recorded title.



1 With the unit in Stop mode, press the **MENU** button.

2 Press the **▲▼** buttons to select **Playlist**, then press the **OK** or **▶** button.

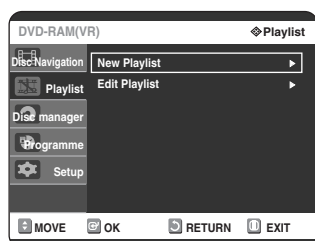

3 Press the **▲▼** buttons to select **New Playlist**, then press the **OK** or **▶** button. The Make Scene screen is displayed.

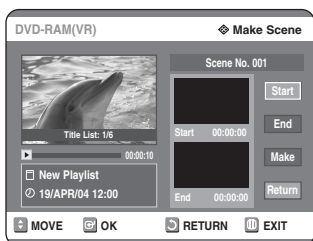

4 Press the **OK** button at the start point.

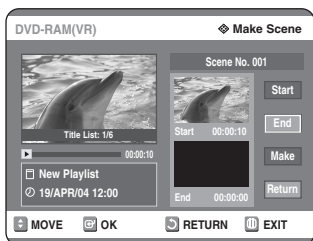

- The image and time at the start point are displayed on the Start window.
- The yellow-coloured selection bar moves to the End item.
- Select the starting point of the section from which you want to create a new scene using the playback related buttons (◀, ⏪, ⏩, ▶).

5 Press the **OK** button at the end point.

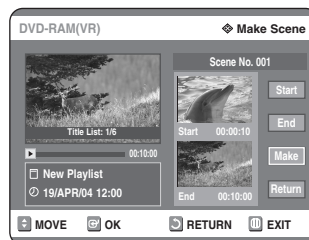

- The image and end point time are displayed in the End window.
- The yellow-coloured selection bar moves to the Make item.

- To make a new playlist -

6 Press the **OK** button to select the **Make**. A new Scene will be added to the current Playlist. A new Make Scene screen is displayed.



- You can check and see all the scenes on Edit Playlist screen.
- Repeat steps 1~6 if you want to make a new playlist.
- Repeat steps 4~6 if you want to make scenes of the playlist.

- To return to Edit Playlist menu -

7 Press the **▲▼** buttons to select **Return**, then press the **OK** button. The Edit Playlist screen is displayed.

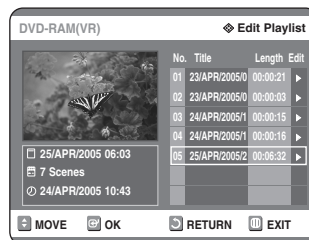

8 Press the **MENU** or **PLAY LIST** button after the operation has finished. The Edit Playlist screen will disappear.



- You can create up to 99 playlist entries.
- Depending on the kind of disc, the displayed screen may have a slight difference.

Playing Entries in the Playlist

Follow these instructions to play the playlist entries.



1 With the unit in Stop mode, press the **PLAY LIST** button.

The Edit Playlist screen is displayed.

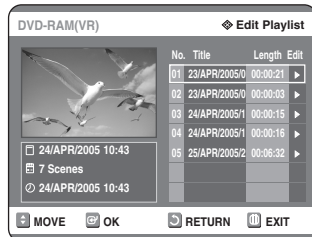

Using the MENU button

- With the unit in Stop mode, press the **MENU** button.
- Press the **▲▼** buttons to select **Playlist**, then press the **OK** or **▶** button.
- Press the **▲▼** buttons to select **Edit Playlist**, then press the **OK** or **▶** button.

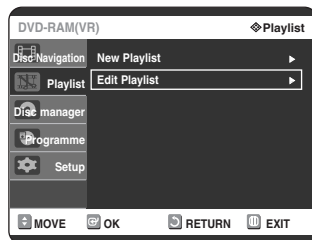

2 Press the **▲▼** buttons to select the title you want to edit from the Playlist, then press the **OK** or **▶** button.

The Edit Playlist menu is displayed : Play, Rename, Edit Screen, Copy, Delete.

3 Press the **▲▼** buttons to select **Play**, then select the **OK** button.

The playlist entries will be played.

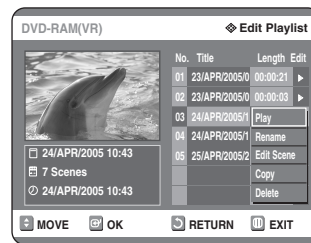

- To view the current status of the disc and progress of playback : Press the **INFO** button, and the information about the disc will appear.

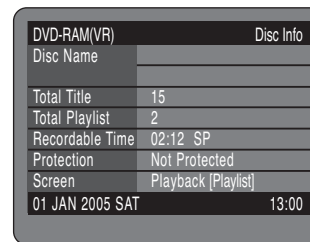

- Press the **INFO** button once again. Then you can check the information about the playlist currently playing back.



- The screen returns to the Edit Playlist screen when the playback has finished.

4 Press the **STOP** button to stop playing. The screen returns to the Edit Playlist screen.

Renaming a Playlist Entry

Follow these instructions to rename a playlist entry, i.e. to edit the title of a playlist entry.



- 1 With the unit in Stop mode, press the **PLAY LIST** button.
The Edit Playlist screen is displayed.

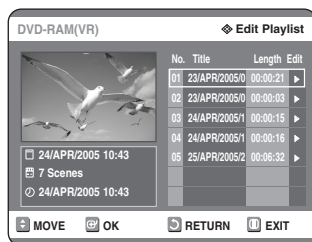

Using the MENU button

- With the unit in Stop mode, press the **MENU** button.
- Press the **▲▼** buttons to select **Playlist**, then press the **OK** or **▶** button.
- Press the **▲▼** buttons to select **Edit Playlist**, then press the **OK** or **▶** button.

- 2 Press the **▲▼** buttons to select the title you want to edit from the Playlist, then press the **OK** or **▶** button.
The Edit Playlist menu is displayed: Play, Rename, Edit Scene, Copy, Delete

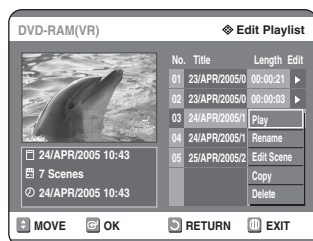

- 3 Press the **▲▼** buttons to select **Rename**, then press the **OK** button.
The Rename screen is displayed.

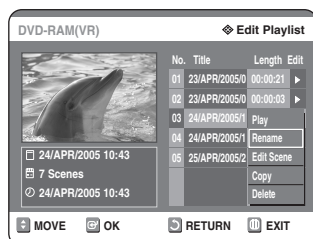

- 4 Enter the desired characters using the **▲▼◀▶** buttons.



- This function is the same as the Rename function in renaming the title list. (See page 70.)
- The maximum number of characters that can be entered is 31. All 31 characters can be displayed by pressing the **INFO** button twice.

- 5 Press the **▲▼◀▶** buttons to select **Save**, then press the **OK** button.
The changed title is displayed in the title field of the selected playlist entry.

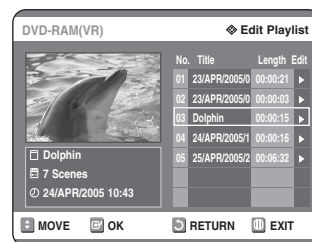

Editing a Scene for the Playlist

Follow these instructions to edit scenes for a playlist.



- 1 With the unit in Stop mode, press the **PLAY LIST** button.
The Edit Playlist screen is displayed.

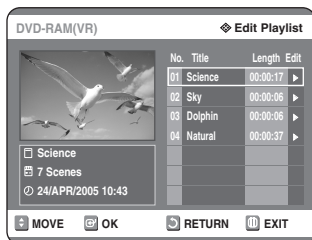

Using the MENU button

- With the unit in Stop mode, press the **MENU** button.
- Press the **▲▼** buttons to select **Playlist**, then press the **OK** or **▶** button.
- Press the **▲▼** buttons to select **Edit Playlist**, then press the **OK** or **▶** button.

- 2 Press the **▲▼** buttons to select the title you want to edit from the Playlist, then press the **OK** or **▶** button.

The Edit Playlist menu is displayed.:Play, Rename, Edit Scene, Copy, Delete

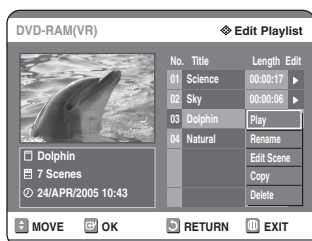

- 3 Press the **▲▼** buttons to select **Edit Scene**, then press the **OK** button.

The Edit Scene screen is displayed.

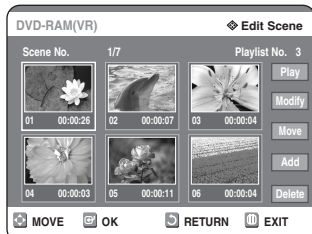
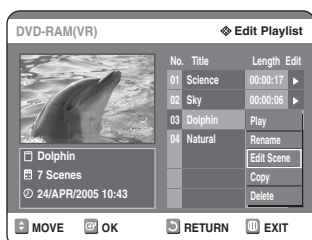

Playing a Selected Scene

- 4 Press the **▲▼◀▶** buttons to select the scene you want to play, then press the **OK** button.
The playlist entry to be played is selected.

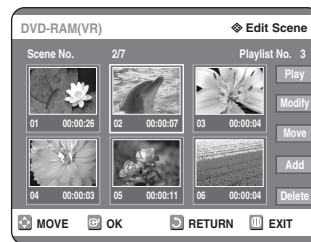

- 5 Press the **OK** button.
The selected scene is played.

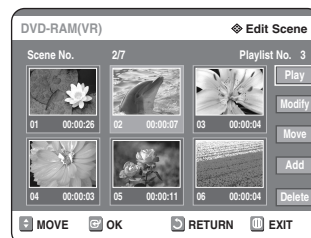

- To stop scene play, press the **STOP** button.

Modifying a Scene (Replacing a Scene)

To setup, follow steps 1 to 3 in page 77.

- 4 Press the ▲▼◀▶ buttons to select the scene you want to modify, then press the **OK** button.

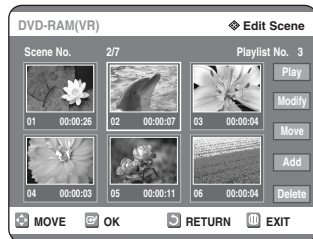

- 5 Press the ▲▼ buttons to select **Modify**, then press the **OK** button. The Modify Scene screen is displayed.

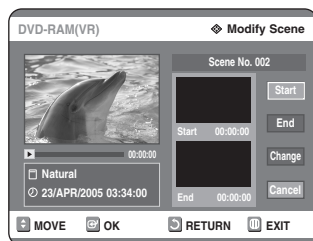

- 6 Press the **OK** button at the start point of the scene.

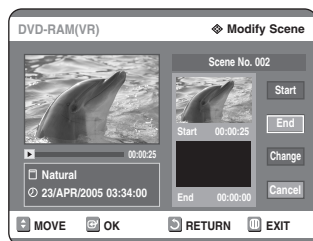

- The image and starting point time are displayed on the Start window.
- Select the starting or ending point of the section you want to modify using the playback related buttons (⏪, ⏩, ⏮, ⏭).

- 7 Press the **OK** button at the end point of the scene.

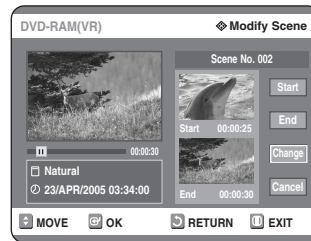

- The image and ending point time are displayed in the End window.

- 8 Press the ▲▼ buttons to select **Change**, then press the **OK** button.

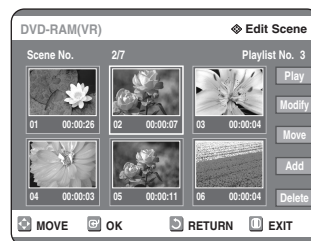

- The scene you want to modify is changed with the selected section.

Moving a Scene (Changing the Position of a Scene)

To setup, follow steps 1 to 3 in page 77.

- Press the ▲▼◀▶ buttons to select the scene you want to move (change the position), then press the **OK** button.

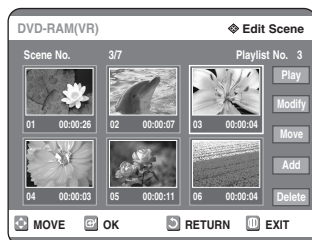

- Press the ▲▼ buttons to select **Move**, then press the **OK** button.

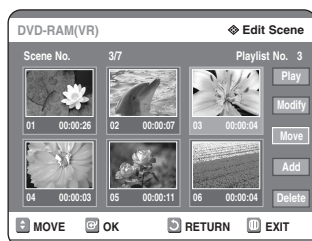

- A yellow selection window is displayed on the scene to be moved.

- Press the ▲▼◀▶ buttons to select the position to which you want to move the selected scene, then select the **OK** button.

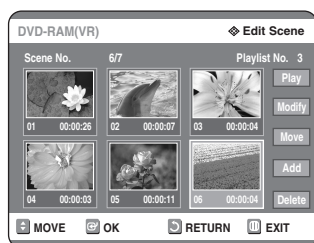

- The selected scene is moved to the selected position.

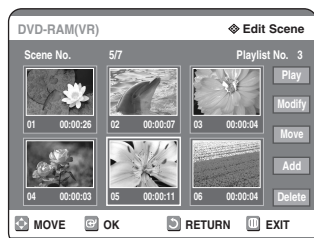

NOTE

- You cannot move the selected scene to the position of the next scene, because the selected scene should be inserted before that position, which requires no action.
- Depending on the kind of disc, the displayed screen may have a slight difference.

Adding a Scene

To setup, follow steps 1 to 3 in page 77.

- Press the ▲▼◀▶ buttons to select the scene that will have a new scene inserted before it, then press the **OK** button.
A yellow selection window is displayed on the scene to be added as the new scene.

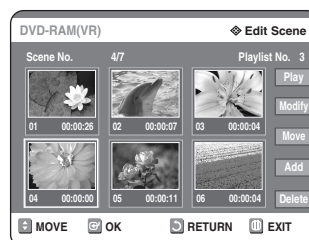

- Press the ▲▼ buttons to select **Add**, then press the **OK** button.

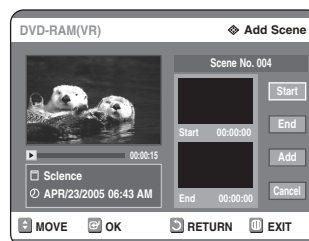

- Press the **OK** button at the starting point of the scene.

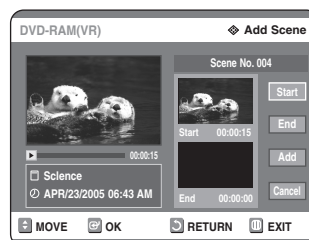

- The image and starting point time are displayed in the Start window.
- Select the end point of the section where you want to add the new scene using the playback related buttons (◀, ⏪, ⏩, ▶).

- Press the **OK** button at the end point of the scene.

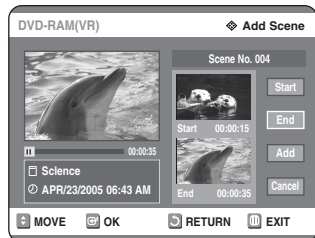

- The image and time of the end point are displayed in the End window.
- To cancel, press the **▲▼** buttons to select cancel, then press the **OK** button.

- Press the **▲▼** buttons to select **Add**, then press the **OK** button.

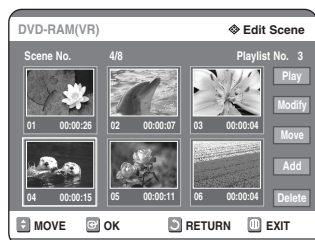

- The section you want to add is inserted prior to the scene selected in step 4.

Deleting a Scene

To setup, follow steps 1 to 3 in page 77.

- Press the **▲▼◀▶** buttons to select the scene you want to delete, then press the **OK** button.

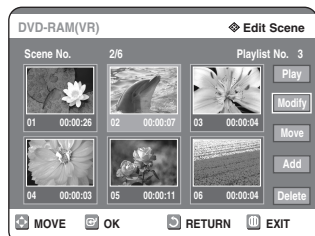

- Press the **▲▼** buttons to select **Delete**, then press the **OK** button.

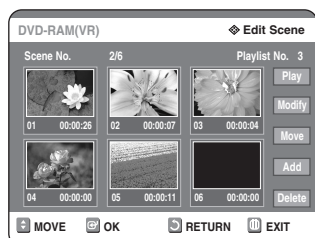

Copying a Playlist Entry to the Playlist



Using the PLAY LIST button

- With the unit in Stop mode, press the **PLAY LIST** button.

The Edit Playlist screen is displayed.

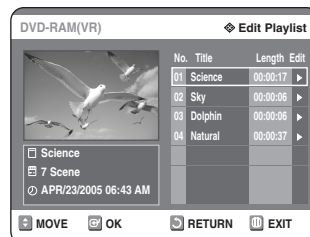

Using the MENU button

- With the unit in Stop mode, press the **MENU** button.
- Press the **▲▼** buttons to select **Playlist**, then press the **OK** or **▶** button.
- Press the **▲▼** buttons to select **Edit Playlist**, then press the **OK** or **▶** button.

- Press the **▲▼** buttons to select the title you want to copy to the Playlist, then press the **OK** or **▶** button.

The Edit Playlist menu is displayed.:Play, Rename, Edit Scene, Copy, Delete

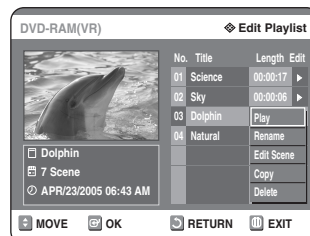

- Press the **▲▼** buttons to select **Copy**, then press the **OK** button.

Playlist that has been selected will be copied.

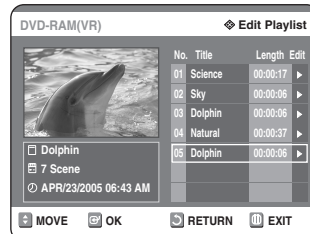
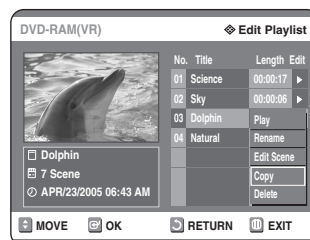



NOTE

- You can create up to 999 scenes on one disc. In some cases, this may be different from the actual numbers.
- Press the **MENU** button after the operation has finished. The Edit Playlist screen will disappear.

3 Press the **▲▼** buttons to select **Delete**, then press the **OK** button.

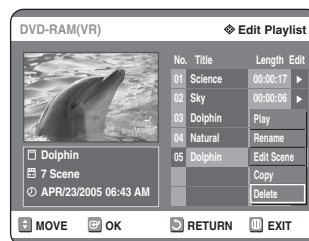

Deleting a Playlist Entry from the Playlist



Using the **PLAYLIST** button

1 With the unit in Stop mode, press the **PLAY LIST** button. The Edit Playlist screen is displayed.

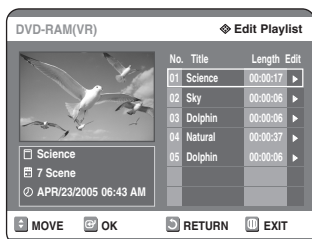

- You will be prompted with the delete confirmation message 'Do you want to delete?'.

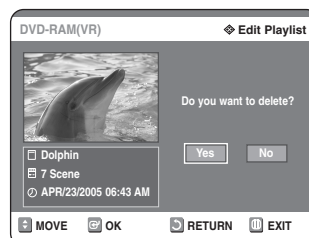

4 Press the **◀▶** buttons to select **Yes**, then press the **OK** button. It automatically returned to the Edit Playlist screen after the delete operation has finished.

Using the **MENU** button

- With the unit in Stop mode, press the **MENU** button.
- Press the **▲▼** buttons to select **Playlist**, then press the **OK** or **▶** button.
- Press the **▲▼** buttons to select **Edit Playlist**, then press the **OK** or **▶** button.

2 Press the **▲▼** buttons to select the title you want to delete from the Playlist, then press the **OK** or **▶** button.

The Edit Playlist menu is displayed.:Play, Rename, Edit Scene, Copy, Delete

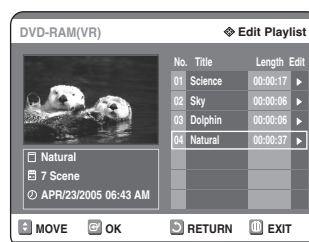
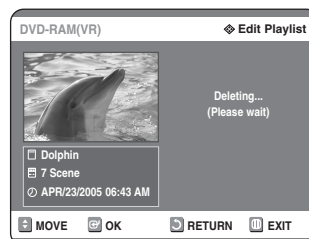
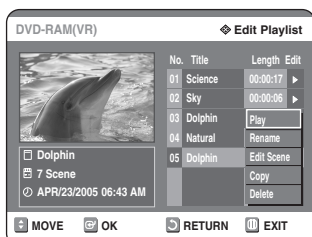

Disc Manager

Editing the Disc Name

Follow these instructions to give a name to a disc.



- 1 With the unit in Stop mode, press the **MENU** button.

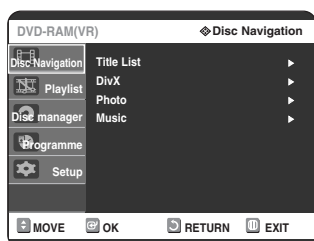

- 2 Press the **▲▼** buttons to select **Disc Manager**, then press the **OK** or **▶** button.

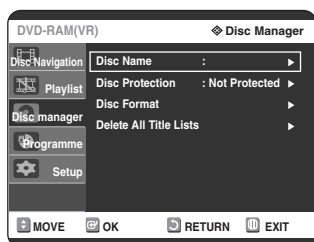

- 3 Press the **▲▼** buttons to select **Disc Name**, then press the **OK** or **▶** button. The Edit Name screen is displayed.



- 4 Enter the desired characters press the **▲▼** **◀▶** buttons.

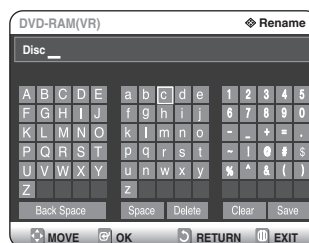

- This function is the same as the Rename function in renaming the title list. (See page 70.)
- The maximum number of characters that can be entered is 31. All 31 characters can be displayed by pressing the **INFO** button.

- 5 Press the **▲▼** **◀▶** buttons to select **Save**, then press the **OK** button. A disc name is given to the disc.

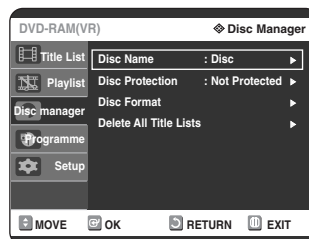

NOTE

- You may need to clear disc protect before beginning editing.
- Depending on the kind of disc, the displayed screen may be different.

Disc Protection

Disc Protection allows you to protect your discs from being formatted or deleted due to unintended operations.



- 1 With the unit in Stop mode, press the **MENU** button.

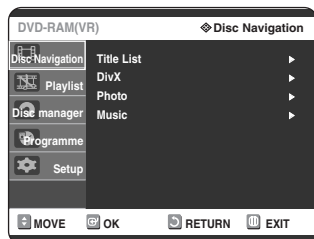

- 2 Press the **▲▼** buttons to select **Disc Manager**, then press the **OK** or **▶** button.



- 3 Press the **▲▼** buttons to select **Disc Protection**, then press the **OK** or **▶** button.

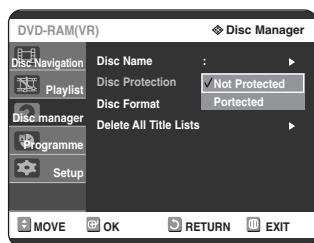

- 4 Press the **▲▼** button to select **Protected**, then Press the **OK** button.

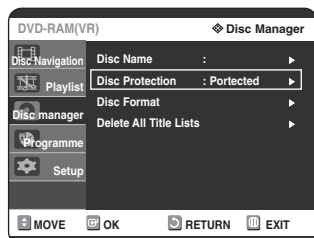

Formatting a Disc

Use these instructions to format a disc. The Disc Protection should also be cleared.



- 1 With the unit in Stop mode, press the **MENU** button.

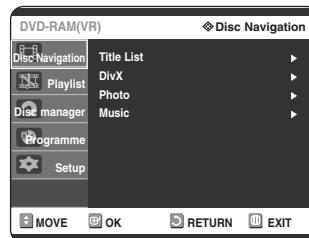

- 2 Press the **▲▼** buttons to select **Disc Manager**, then press the **OK** or **▶** button.

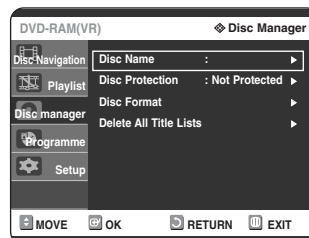

- 3 Press the **▲▼** buttons to select **Disc Format**, then press the **OK** or **▶** button.

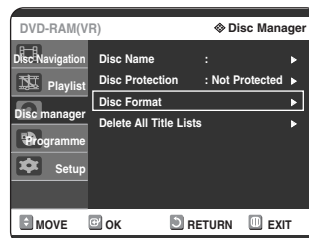

DVD-RAM

- You will be prompted with the confirmation message 'Do you want to format disc?'.

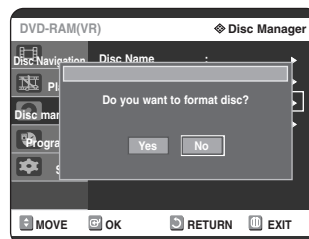

- You will be prompted with the confirmation message 'All data will be deleted. Do you want to continue?'.

DVD-RW

- You will be prompted with the confirmation message 'Choose the recording format for DVD- RW.'

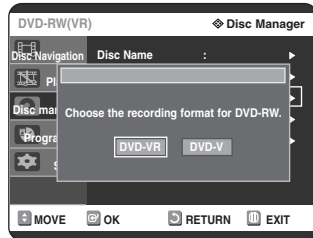

- Press the ◀▶ buttons to select **Yes**, then press the **OK** button. The disc is formatted.

DVD-VR and DVD-V are defined according to their recording format.

	DVD-VR	DVD-V
DISC	DVD-RAM DVD-RW	DVD-RW DVD-R

Delete All Title Lists



- With the unit in Stop mode, press the **MENU** button.

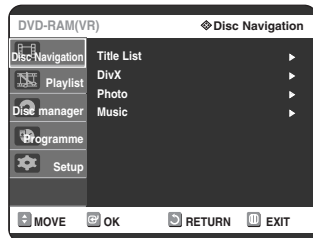

- Press the ▲▼ buttons to select **Disc Manager**, then press the **OK** or ▶ button.

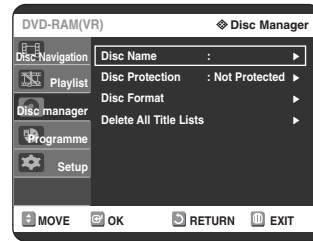

- Press the ▲▼ button to select **Delete All Title Lists**, then press the **OK** or ▶ button.

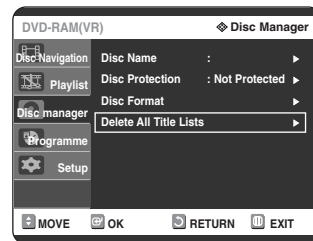

- You will be prompted with the confirmation message 'Do you want to delete all title lists?.'

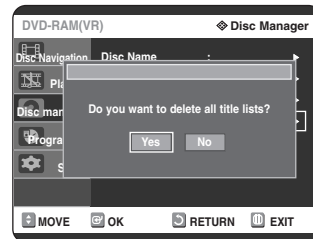

- When Protected Entry exists: The Delete All Title List function will not operate. If there is a title containing a still picture, however, that function will not operate. If you want to delete a protected entry, disable Protect for it on the Lock item.

- Press the ◀▶ buttons to select **Yes**, then press the **OK** button. All title lists are deleted.

Finalising a disc

After you record titles onto a DVD-RW/DVD-R disc with your DVD recorder, it needs to be finalised before it can be played back on external devices.



- 1 With the unit in Stop mode, press the **MENU** button.

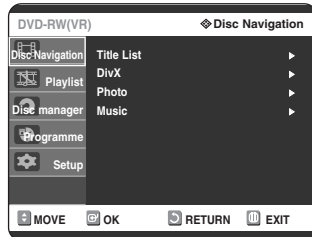

- 2 Press the **▲▼** buttons to select **Disc Manager**, then press the **OK** or **▶** button.

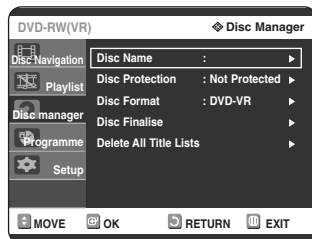

- 3 Press the **▲▼** button to select **Disc Finalise**, then press the **OK** or **▶** button.

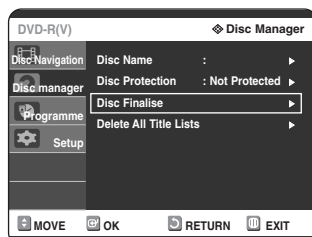
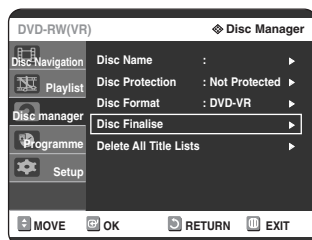

You will be prompted with the message 'Do you want to finalise disc?'.

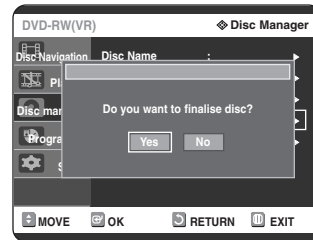

If you select Yes, you will be prompted again with the message 'Disc will be finalised. Do you want to continue?'.

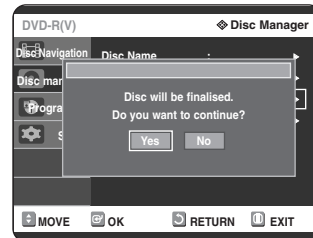

- 4 Press the **◀▶** buttons to select **Yes**, then press the **OK** button.
The disc is finalised.



NOTE

- Once a disc is finalised, you cannot delete entries from the record list.
- After being finalised, the DVD-R/DVD-RW(video mode) operates in the same manner as a DVD-Video.
- Depending on the disc type, the displayed screen may be different.
- Finalising time may be different depending on the amount of data recorded on the disc.
- Data on the disc will be damaged if the recorder is powered off during finalise process.

Unfinalising a disc (V/VR mode)



- 1 With the unit in Stop mode, press the **MENU** button.

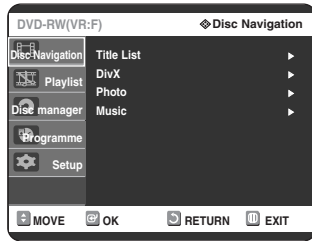

- 2 Press the **▲▼** buttons to select **Disc Manager**, then press the **OK** or **▶** button.

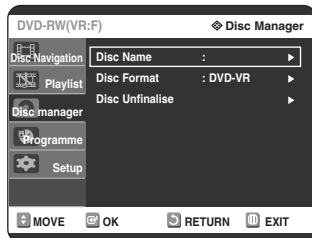

- 3 Press the **▲▼** button to select **Disc Unfinalise**, then press the **OK** or **▶** button. You will be prompted with the message 'Do you want to unfinalise disc?'.

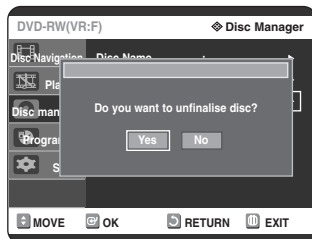

If you select Yes, you will be prompted again with the message 'Disc will be unfinalised. Do you want to continue?'

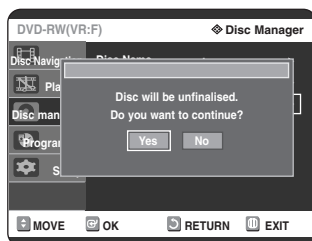

- 4 Press the **◀▶** buttons to select **Yes**, then press the **OK** button. The disc is unfinalised.



NOTE

- A DVD-RW can be finalised or unfinalised in Video mode.

	Finalise	Unfinalise
Mark	DVD-Video(RW)	DVD-RW(V)
Operation	Same as DVD-Video	Additional recording, protection and deletion are possible.

- A DVD-RW can be finalised or unfinalised in VR mode.

	Finalise	Unfinalise
Mark	DVD-RW(VR:F)	DVD-RW(VR)
Operation	Additional recording, deletion, editing, and protection are impossible.	Additional recording, deletion, editing, and protection are possible.

Additional Information

Troubleshooting

If your product malfunctions, go through the checkpoints below before contacting a Samsung authorised service centre.

Power

The input is displayed for a while when the power is turned on.



- Checkpoint 1** ▶ The DVD recorder requires some time to initialize and the input will be displayed for approx. 10 seconds after it is turned on.

Recording

Cannot record TV programmes.



- Checkpoint 1** ▶ Check whether the power cord is securely plugged into the power outlet.
- Checkpoint 2** ▶ Did you set the DVD recorder channel settings correctly?
- Checkpoint 3** ▶ Check the free space on your DVD-RAM/DVD-RW/DVD-R discs.

I pressed the **REC** button but there is no response.



- Checkpoint 1** ▶ Recording is possible for DVD-RAM/DVD-RW/DVD-R discs only. If a programme is copy protected, it cannot be recorded.

Troubleshooting	87
Specifications	91

Playback

Cannot play the disc.



Checkpoint 1 Check whether the disc is inserted correctly with the label facing up.

Checkpoint 2 Check the regional code of the DVD disc.

Checkpoint 3 This DVD recorder cannot play some types of discs. (See page 51)

⊘ icon appears on the screen.



Checkpoint 1 You cannot use this operation or function due to one of the following reasons:

- (1) Your DVD disc restricts it.
- (2) Your DVD disc does not support this feature (for example: angles)
- (3) The feature is not available at the moment.
- (4) You've requested a title, chapter, or scan time that is out of range.

Play mode settings are different from the settings configured in the Settings menu.



Checkpoint 1 The disc does not support all selected functions. In this case, some settings configured in the settings menu may not work properly.

Cannot change the aspect ratio.



Checkpoint 1 The aspect ratio is fixed for DVD discs. (See pages 35~36.)

The angle operation does not work while playing a DVD disc.



Checkpoint 1 The angle operation is available only when the disc contains images captured from different angles.

The selected audio and/or subtitle language is not played.



Checkpoint 1 Audio and subtitle languages are disc-specific. Only the sound and subtitle languages contained on the DVD disc are available and displayed in the disc menu.

Video

The disc revolves, but no image or bad quality images are displayed.



Checkpoint 1 Be sure that the Video Setting is properly set. (See pages 33~36).

Checkpoint 2 Check whether there is damage to or any foreign material on your disc.

Checkpoint 3 Some low quality discs may not play properly.

Checkpoint 4 If scenes change from dark to bright suddenly, the screen may shake vertically temporarily, but this is not a fault.

Sound

No sound.



Checkpoint 1 Are you watching a programme in slow or skip mode?
If you are playing a programme at a speed other than normal speed, sound will not be heard.

Checkpoint 2 Check the connections and settings.

Checkpoint 3 Check whether the disc is damaged.
Clean the disc, if necessary.

Checkpoint 4 Check whether the disc is inserted correctly with the label facing up.

No audio output.



Checkpoint 1 Check whether you have selected the correct digital output options in the Audio Output Options menu.
(See pages 32~33)

Timer Recording

Timer lamp flickers.



Checkpoint 1 Check there is enough space in the disc for recording.

Checkpoint 2 Check whether the current disc is recordable or not.
Make sure to check before the start time of recording.

Timer recording does not work properly.



Checkpoint 1 Re-check the recording time and the end time settings again.

Checkpoint 2 Recording will be cancelled if the power is interrupted due to a power failure or another similar reason while recording.

HDMI

No HDMI output.



Checkpoint 1 Check the Video output is HDMI enabled.

Checkpoint 2 Check the connection between the TV and the HDMI jack of the DVD Recorder.

Checkpoint 3 See if your TV supports this 576p/720p/1080i DVD Recorder.

Abnormal HDMI output screen.



Checkpoint 1 If snow noise appears on the screen, it means that TV does not support HDCP (High-bandwidth Digital Content Protection).

HDMI output Jitter



- Checkpoint 1** Check your TV system setup correctly.
- Checkpoint 2** Screen Jitter may occur when the frame rate is converted from 50Hz to 60Hz for 720p/1080i HDMI (High Definition Multimedia Interface) Output.
- Checkpoint 3** Please refer to the user's manual of your TV.

Remote Control

The remote control doesn't work.



- Checkpoint 1** Point the remote control at the remote control sensor on your DVD recorder. Allow for proper distance. Remove obstacles between your DVD recorder and the remote control.
- Checkpoint 2** Check whether the batteries are empty.
- Checkpoint 3** Check for the **TV/DVD** selection button.

Other

I forgot my password for parental supervision.



- Checkpoint 1** Press the **▶▶** button on the front panel of the Recorder for more than 5 seconds with no disc in the DVD recorder. All settings including the password will revert to the factory settings. Do not use this unless absolutely necessary. (Note that this function is possible only when no disc is inserted.)

Is it possible to change a subtitle and an audio signal on a recorded disc?



- Checkpoint 1** A recorded disc is played with only the subtitle and the audio signal which were selected during recording.

Other problems.



- Checkpoint 1** Read the table of contents and then find and read the section describing your problem, follow the instructions given.
- Checkpoint 2** Turn your DVD recorder off and on.
- Checkpoint 3** If the problem still persists, contact a nearby Samsung service centre.

Specifications



General	Power requirements	220-240V AC, 50Hz
	Power consumption	35 Watts
	Weight	2,9Kg
	Dimensions	430mm(W) x 245mm(D) x 59mm(H)
	Operating temp.	+5°C to +35°C
	Other conditions	Keep level when operating. Less than 75% operating humidity
Input	Video	Composite Video : 1,0 V p-p at 75Ω load, sync negative
	Audio	Max.Audio Input Level : 2Vrms
	DV Input	IEEE 1394(4p) compatible jack
	Receivable Channels	PAL I
	Scart Jack	AV1 (Scart TV)
AV2 (Scart Ext)		Video : Composite, RGB Audio: analogue
Output	Audio	Analogue output jacks x 2
		Optical/Coaxial digital audio output
	Video	Composite Video : Video output jack x 1
		S-Video output x 1 (Y:1,0Vp-p, C:0,286Vp-p at 75Ω load)
		Component output x 1 (Y: 1,0Vp-p, Pb: 0,70Vp-p, Pr: 0,70Vp-p at 75Ω load)
		HDMI/DVI (576p, 720p, 1080i)
Scart Jack	AV1 (Scart TV)	Video : Composite, RGB Audio: analogue
Recording	Picture Compression format	MPEG-II
	Audio Compression format	Dolby Digital 2ch/256Kbps, MPEG-II
	Recording Quality	XP (about 8 Mbps), SP (about 4 Mbps), LP (about 2 Mbps),
		EP (about 1,2 Mbps or about 0,8 Mbps)
Audio Frequency Response	20 Hz ~ 20 kHz	

Audio Output For DVD discs, audio signals recorded at 96kHz sampling frequency are converted and output at 48kHz.

Disc Type	DVD	AUDIO CD(CD-DA)
Analogue Audio Output	48 / 96kHz	44,1kHz
Digital Audio Output	48kHz	44,1kHz



UNITED KINGDOM

This Samsung product is warranted for the period of twelve (12) months from the original date of purchase, against defective materials and workmanship. In the event that warranty service is required, you should return the product to the retailer from whom it was purchased.

However, Samsung Authorised Dealers and Authorised Service Centres in other EC Countries will comply with the warranty on the terms issued to purchasers in the country concerned.

In case of difficulty, details of our Authorised Service Centres are available from:

**Samsung Electronics (U.K.) Ltd.,
Euro Service Centre,
Stafford Park 12,
TELFORD, Shropshire TF3 3BJ,
Tel: 0870) 242 0303,
Fax: 01952) 297617**

■ WARRANTY CONDITIONS

1. The warranty is only valid if, when warranty service is required, the warranty card is fully and properly completed and is presented with the original invoice or sales slip or confirmation, and the serial number on the product has not been defaced.
2. Samsung's obligations are limited to the repair or, at its discretion, replacement of the product or the defective part.
3. Warranty repairs must be carried out by Authorised Samsung Dealers or Authorised Service Centres. No re-imburement will be made for repairs carried out by non Samsung Dealers and, any such repair work and damage to the products caused by such repair work will not be covered by this warranty.



REPUBLIC OF IRELAND

4. This product is not considered to be defective in materials nor workmanship by reason that it requires adaptation in order to conform to national or local technical or safety standards in force in any Country other than the one for which the product was originally designed and manufactured. This warranty will not cover, and no re-imburement will be made for such adaptation nor any damage which may result.
5. This warranty covers none of the following:
 - a) Periodic check ups, maintenance and repair or replacement of parts due to normal wear and tear.
 - b) Cost relating to transport, removal or installation of the product.
 - c) Misuse, including the failure to use this product for its normal purposes or incorrect installation.
 - d) Damage caused by Lightning, Water, Fire, Acts of God, War, Public Disturbances, incorrect mains voltage, improper ventilation or any other cause beyond the control of Samsung.
6. This warranty is valid for any person who legally acquired possession of the product during the warranty period.
7. The consumers statutory rights in any applicable national legislation whether against the retailer arising from the purchase contract or otherwise are not affected by this warranty. Unless there is national legislation to the contrary, the rights under this warranty are the consumers sole rights and Samsung, its subsidiaries and distributors shall not be liable for indirect or consequential loss or any damage to records, compact discs, videos or audio taper or any other related equipment or material.

SAMSUNG ELECTRONICS (U.K.) LTD.



**Correct Disposal of This Product
(Waste Electrical & Electronic Equipment)**



(Applicable in the European Union and other European countries with separate collection systems)

This marking shown on the product or its literature, indicates that it should not be disposed with other household wastes at the end of its working life. To prevent possible harm to the environment or human health from uncontrolled waste disposal, please separate this from other types of wastes and recycle it responsibly to promote the sustainable reuse of material resources.

Household users should contact either the retailer where they purchased this product, or their local government office, for details of where and how they can take this item for environmentally safe recycling.

Business users should contact their supplier and check the terms and conditions of the purchase contract. This product should not be mixed with other commercial wastes for disposal.

AK68-00842A-01

Free Manuals Download Website

<http://myh66.com>

<http://usermanuals.us>

<http://www.somanuals.com>

<http://www.4manuals.cc>

<http://www.manual-lib.com>

<http://www.404manual.com>

<http://www.luxmanual.com>

<http://aubethermostatmanual.com>

Golf course search by state

<http://golfingnear.com>

Email search by domain

<http://emailbydomain.com>

Auto manuals search

<http://auto.somanuals.com>

TV manuals search

<http://tv.somanuals.com>