

SAMSUNG

삼성테크윈

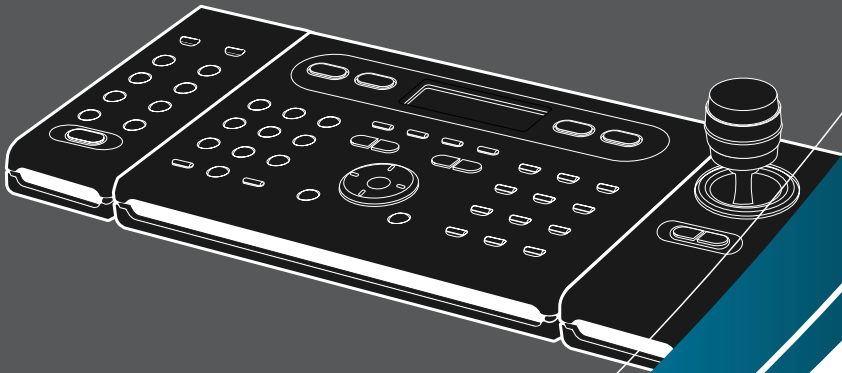

SYSTEM CONTROLLER

USER'S MANUAL

SCC-3000

Thank you for buying a Samsung SYSTEM CONTROLLER.

This manual will guide you through using the SYSTEM CONTROLLER. Please read this manual carefully before using the SYSTEM CONTROLLER.

Download from Www.Somanuals.com. All Manuals Search And Download.

Contents

● Important Safety Instructions	3	(5-1) TOUR Setup	19
● Major Functions and Features		(5-2) TOUR Operation	19
(1) Overview	5	(6) MODEL	21
(2) Features	5	(7) TRACE	22
● Product Components	5	(7-1) TRACE Memory	22
● System Overview	6	(7-2) TRACE Operation	23
● Names and Functions of Each Part		(8) AF	23
(1) Camera Setup Section	7	(9) OSD	24
(2) Number Pad	8	● DVR Mode	25
(3) External Device Selectors	8	● Controller Mode	
(4) Universal Controller	9	(1) Controller Setup Mode	26
(5) DVR Controller	9	(2) Controller ID Setup	27
(6) Camera Controller	11	(3) SERIAL Setup	27
(7) Junction Box	11	(4) DATA COPY	28
● Before Operation		(5) RESPONSE	29
(1) Power-On	12	(6) PASSWORD	31
(2) Initial Screen Display	12	(6-1) PASSWORD Setup	31
(3) Camera ID Setup	12	(6-2) Applying Password-Setup Mode	32
(4) Joystick/Camera Control Button	13	(6-3) Applying Password-Power	32
(5) Camera Movement Speed Control	14	(6-4) Entering Password	32
(6) Camera Zoom Control	14	(7) PRIORITY	33
(7) Camera Focus Control	14	(8) DEFAULT	34
● PTZ Mode		● REFERENCE	
(1) PTZ Setup Mode	15	(1) Swing, Group Movement Speed	35
(2) PRESET	16	(2) System Connections	36
(2-1) PRESET Setup	16	(2-1) Connecting Controller and Junction Box	36
(2-2) PRESET Movement	16	(2-2) Connecting Junction Box and	
(3) SWING	17	External Devices	36
(3-1) SWING Setup	17	(3) RS-485/422 Pin Layout (D_SUB_FEMALE)	37
(3-2) SWING Operation	17	(4) RS-232C Pin Layout (D_SUB_MALE)	37
(4) GROUP	18	(5) Controller Specifications	38
(4-1) GROUP Setup	18	(6) RS-485/422 Specifications	38
(4-2) GROUP Operation	18	(7) Junction Box DIP Switch	38
(5) TOUR	19		

Important Safety Instructions

Warning

- All work related to the installation of this appliance must be performed by qualified service personnel or system installers.
 - If the product is connected or installed improperly, electric shock, fire, severe injury, and/or damage can result.
- Please install the product on a completely flat floor.
 - Always check the strength and stability of the installation location.
 - Do not drop the appliance on the floor. This may result in damage or injury.
- Do not attempt to disassemble the appliance. To prevent electric shock, do not remove screws or covers.
 - There are no user-serviceable parts inside. Contact qualified service personnel for maintenance.
- Never use the appliance in places where there are flammable materials.
 - Never use the appliance in places where flammable materials such as gas are used. This may result in fire, explosion, and other serious accidents.
- Never touch un-insulated parts with wet hands.
 - Touching un-insulated parts with wet hands may result in serious electric shock.
- Never expose the appliance to water or moisture.
 - If the appliance gets wet, immediately turn the power off.
 - Stop using the appliance if it gets wet. Contact the manufacturer immediately.
- Stop using the appliance if there appears to be any operational problem.
 - Immediately turn the power off to the appliance if there is any abnormal condition such as smoke or unusual smells.
 - Continuing to use the appliance under abnormal conditions may result in serious damage.
- Always use the recommended power.
 - Using incorrect power source ratings may result in fire, electric shock, or damage.
- Always handle the connection cable with care.
 - Never damage or modify the connection cable.
 - Do not pull, expose to heat, or place heavy objects on the connection cable.
 - Non-observance of these warnings may result in fire, electric shock or damage.

Caution

- Use the appliance indoors only.
 - Do not place the appliance outdoors or expose it to rain or moisture.
 - If dropped in water, the appliance may be corroded and damaged.
- Do not use the appliance where there is excessive dust, smoke, or moisture.
 - Using the appliance under such conditions may result in fire, electric shock or serious damage.
- Do not operate the appliance in temperatures beyond those specified.
 - Excessive heat or cold may damage the appliance.
 - Always operate the appliance within the recommended temperature range of 0°C ~ 40°C.
- Do not place the appliance in direct sunlight.
 - This may discolor the appliance.
- Do not apply excessive shock to the appliance.
 - Excessive shock may damage the appliance.

Important Safety Instructions

Maintenance and Repair

- If the controller body gets dirty, turn the power off and wipe the surface with a soft cloth.
 - Do not use chemical agents such as alcohol or benzene.
- For detailed information on upgrading the firmware, please direct your inquiries to the installation vendor.

Refer all work related to the installation of this appliance to qualified service personnel or system installers.

This equipment has been tested and found to comply with the limits for a Class A digital device, pursuant to Part 15 of the FCC Rules.

These limits are designed to provide reasonable protection against harmful interference when the equipment is operated in a commercial environment. This equipment generates, uses, and can radiate radio frequency energy and, if not installed and used in accordance with the instruction manual, may cause harmful interference to radio communications.

Operation of this equipment in a residential area is likely to cause harmful interference, in which case the user will be required to correct the interference at his own expense.

Major Functions and Features

(1) Overview

This product is designed for use only with the Speed Dome camera, CCTV receiver, and Samsung Digital Video Recorder.

- Speed Dome camera : Samsung Techwin (SPD-1600/2200/2500), PELCO-D, PANASONIC (WV-CS854A), SAMSUNG ELECTRONICS (SCC-643-641)
- CCTV Receiver : SRX-100B
- DVR : Samsung Techwin (SVR-1630/1620/430)

(2) Features

- It is possible to totally control the 255 Speed Dome camera, CCTV Receiver and Samsung Digital Video Recorder.
- If the Speed Dome is set to one-way reception (RESPONSE OFF), it is possible to connect a maximum of 16 sub-controllers, including the master controller.
- If the Speed Dome is set to two-way reception (RESPONSE ON), it is possible to connect a maximum of 12 sub-controllers, including the master controller.
- Camera control with the joystick, zoom buttons, and focus buttons
- Easy camera preset location setup and movement
- Camera control without an operator through automatic operation mode
- ※ Different surveillance cameras may have different names for the same functions, depending on the manufacturer. Some functions may not be available for certain models.
- ※ If the Speed Dome (SPD-1600/2200/2500) DIP switch is set to one-way reception, each sub-controller can be controlled independently. If it is set to two-way reception, sub-controllers cannot be controlled independently.
- ※ The SPD-1600/2500 is set to two-way reception and the SPD-2200 is set to one-way reception by factory default.
- ※ Sub-controllers cannot be controlled if the master controller is in use.

Product Components

- SCC-3000 Controller

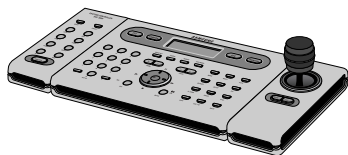

- Junction Box

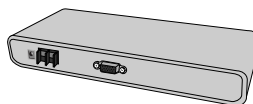

- Controller Connection Cable



- Power Adaptor (DC 12V)



- User's Manual



Names and Functions of Each Part

(1) Camera Setup Section

- ① RESET : Resets camera power.
- ② PRESET : Moves camera to the preset location (see p.16).
- ③ LIGHT : Toggles the lights around the camera on and off.
- ④ AUX : Toggles the camera's external case AUX on and off.
- ⑤ TOUR : Sets more than 1 group for tour and performs continuous group action (see p.19).
- ⑥ SALVO : Not used; will be applied to F/W in the future.
- ⑦ SWING : Continuously travels between two assigned locations horizontally (pan) or vertically (tilt) (see p.17).
- ⑧ GROUP : Repeats sequential surveillance of assigned preset locations with preset movement rates and intervals (see p.18).
- ⑨ AF : Sets the focus to automatic or manual after operating the camera (see p.23).
- ⑩ OSD : Displays the camera OSD menu (see p. 24).
- ⑪ FUNCTION : Used to perform 2 functions or more at the same time (see p.8).

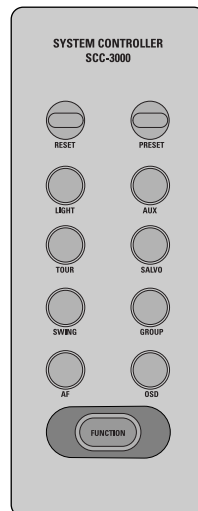

※ Some buttons in the camera setup section may not be supported or may be used differently depending on the camera manufacturer. Please refer to the table below for the buttons supported by the major camera manufacturers.

	SPD-1600	SPD-2200	SPD-2500	PELCO-D	PANASONIC (WV-CS854A)	SAMSUNG ELECTRONICS (SCC-643/641)
RESET	O	O	O	O	O	X
PRESET	O	O	O	O	O	O
TOUR	O	O	O	X	X	X
SALVO	Not used; will be applied to F/W in the future.					
SWING	O	O	O	X	O(AUTO-PAN)	
GROUP	O	O	O	X	O (AUTO-SEQ)	O (SCAN)
AF	O	O	O	O	O	O
OSD	O	O	O	O	O	O
LIGHT	Applies only to systems with housing and receivers that support the light function. (SRX-100B only)					
AUX	Applies only to systems with AUX terminals. (SRX-100B only)					

Names and Functions of Each Part

(2) Number Pad

* 'F' in the table below refers to the Function button.

- ① 0 ~ 9 : Used for entering camera ID, channel number, monitor number, DVR ID, etc. (see p.23).
- ② F + 0 : Activates the system setup menu (see p.24).
- ③ ▲ / ▼ : Used for increasing or decreasing menu values in detailed setup menus.

* When using functions that are performed by a combination of the function button and numeric keys, the setup may be different depending on the camera manufacturer. Please refer to the table below for the setup for major camera manufacturers.

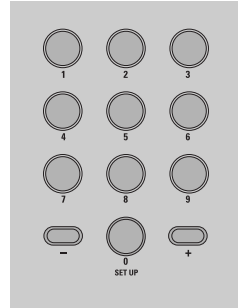

	SPD-1600	SPD-2200	SPD-2500	PELCO-D	PANASONIC (WV-CS854A)	SAMSUNG ELECTRONICS (SCC-643/641)
F+1	TRACE RUN	TRACE RUN	TRACE RUN	TRACE RUN (PATTERN)	TRACE RUN (PATTERN)	TRACE RUN (PATTERN 1)
F+2	TRACE MEMORY	TRACE MEMORY	TRACE MEMORY	-	F2(SPECIAL 2)	TRACE RUN (PATTERN 2)
F+3	TRACE MEMORY STOP	TRACE MEMORY STOP	TRACE MEMORY STOP	-	F3	TRACE RUN (PATTERN 3)
F+4	AUTO POWER ON	AUTO POWER ON	AUTO POWER ON	-	AUTO-SORT	-
F+5	AUTO POWER OFF	AUTO POWER OFF	AUTO POWER OFF	-	-	-

* Use the AUTO POWER ON setting to allow the camera to resume the tasks in its memory upon power supply, even if they were previously aborted as a result of power failure, etc.

(3) External Device Selectors



- ① PTZ : Selects the PTZ mode (see p.15~24).
- ② DVR : Selects the DVR mode (see p.25).
- ③ CAMERA : Enter camera number and press the CAMERA button to set the camera ID (PTZ mode) or set the channel (DVR mode).
- ④ MONITOR : Not used; will be applied to F/W in the future).

Names and Functions of Each Part

(4) Universal Controller

- ① ZOOM W/T : Performs camera zoom action (wide and telephoto).
- ② FOCUS +/- : Used for manual focus adjustment.
- ③ II : Used for moving the menu cursor up (when menu is active), pausing DVR playback, or playing stills.
- ④ ■ : Used for moving the menu cursor down (when menu is active) or stopping DVR playback.
- ⑤ I| : Used for moving the menu cursor left (when menu is active) or Slow Playback.
- ⑥ ▶▶ : Used for moving the menu cursor right (when menu is active) or Fast Playback
- ⑦ ▶ : Used for playing recorded video.
- ⑧ REC / ESC : Used for starting surveillance screen recording, canceling entered values, or moving to the previous stage.
- ⑨ ENTER / DIR : Used for executing the entered values, performing setups (PTZ mode and DVR mode), or playing recorded video in the reverse direction.

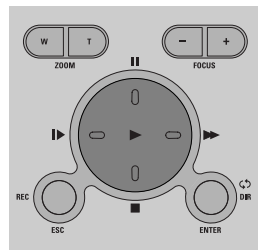

INFORMATION

- It is possible to use all the functions except menu cursor movement of ③ ~ ⑨ buttons in only PLAY MODE for SVR-900/1620. When the user presses the PLAY MODE button of the controller, PLAY MODE is on. When PLAY MODE is on, [P-MODE] appears on the LCD monitor. Press the PLAY MODE button once again to release PLAY MODE.

(5) DVR Controller

※ Please refer to the DVR product manual for the buttons without reference pages.
Some functions may not be supported by certain models.

- ① QUICK SET : The Quick Setup menu is displayed in the DVR monitor.
- ② STATUS : The current DVR status is displayed in the DVR monitor.
- ③ SEARCH : Used for searching the DVR recording list.
- ④ PLAY MODE : Used for recording and playing the DVR with the controller.
(SVR-900/1620 only)
- ⑤ MENU : The DVR menu is displayed in the DVR monitor.
- ⑥ MULTI : Used for switching the DVR monitor from single screen playback mode to multiple screen playback mode.
- ⑦ AUTO : displays the sequence of cameras connected to the DVR on the monitor.
- ⑧ ALARM RESET : Used for resetting the alarm and event display, turning the relay on and off, and closing the event notification window.
- ⑨ LIST : Shows the event list saved in the DVR storage device.
- ⑩ PIP : Used for performing the PIP (Picture In Picture) function.
- ⑪ DIGITAL ZOOM : Used for zooming in the monitor screen when in single screen playback mode.
- ⑫ FREEZE : Used for pausing the video when displaying a surveillance video.
- ⑬ SPOT : Used to switch to spot monitor.
- ⑭ COPY : Used for copying, backing up, or deleting saved video.
- ⑮ LIVE / PLAY BACK : Used for toggling the surveillance screen and playback screen.
- ⑯ RELAY : Used for manual control of replay output.

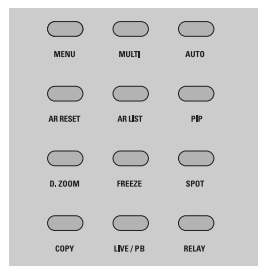
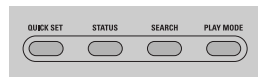

Names and Functions of Each Part

※ Some DVR controller buttons may not be supported or may be used differently than as described in this manual, depending on the DVR model. Please refer to the table below for the buttons supported by major DVR model manufacturers. The DVR button with multiple functions works in the same way on the controller.

	SVR-430	SVR-900	SVR-1620	SVR-1630
QUICK SET	○	-	-	-
STATUS	○	○	○	-
SEARCH	○	○	○	○
PLAY MODE	-	○	○	-
FOCUS -	○	○	○	○
FOCUS +	○	○	○	-
⏪	○	○ Jog(PLAY MODE)	○ Jog(PLAY MODE)	○ Jog
▶▶	○	○ Fast Forwarding (PLAY MODE)	○ Fast Forwarding (PLAY MODE)	○
■	○	○ Pause (PLAY MODE)	○ Pause (PLAY MODE)	○
⏩	Jog	○ Slow Playback (PLAY MODE)	○ Slow Playback (PLAY MODE)	○
ENTER / DIR	○	○ Direction Switching (PLAY MODE)	○ Direction Switching (PLAY MODE)	○
REC / ESC	○ Record function for Surveillance (LIVE) screen	○ Record function for Surveillance (LIVE) screen	○ Record function for Surveillance (LIVE) screen	○ Record function for Surveillance (LIVE) screen
MENU	○	○	○	○
MULTI	○	○	○	○
AUTO	○	○	○	○
ALARM RESET	○	○	○	○
LIST	-	○	○	-
PIP	○	○	○	-
DIGITAL ZOOM	○	○	○	○
FREEZE	-	○	○	-
SPOT	-	○	○	○ (A/B)
COPY	○	○	○	○
LIVE/PLAY BACK	○	Screen Selection	Screen Selection	-
RELAY	-	-	-	○
-/+	○	○	○	-

Names and Functions of Each Part

(6) Camera Controller

- ① Joystick: Used for moving the camera up, down, left, and right, and for zoom control (see p.13).
 - 1) Tilt up (Up button): Moves the camera up.
 - 2) Tilt down (Down button): Moves the camera down.
 - 3) Tilt left (Left button): Moves the camera left.
 - 4) Tilt right (Right button): Moves the camera right.
 - 5) Turn stick clockwise: Performs telephoto-zoom.
 - 6) Turn stick counter-clockwise: Performs wide zoom.
- ② SLOW : Sets the camera movement (up, down, left, and right) speed slow.
- ③ FAST : Sets the camera movement (up, down, left, and right) speed fast.



[Joystick]

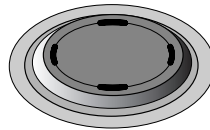

[Camera Control Button]

(7) Junction Box

[Front]

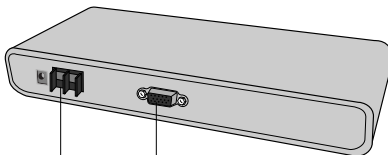

Power Input
Connector

Junction Box
Connector

[Back]

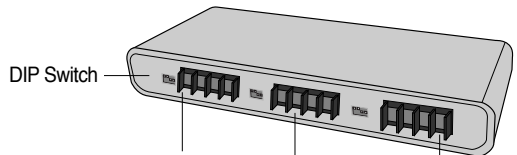

DIP Switch

PTZ/DVR
Connector

Sub-Controller
Connector

Reversed
Connector

Before Operation

(1) Power-On

- ① Power on the connected external devices before turning the controller on.
- ② Press the power button at the back of the controller to power on the controller.
- ③ The [SYSTEM Controller] message and F/W version will be displayed in the LCD monitor, and the message will disappear when the controller is ready for use.

- The [JOYSTICK ERROR] error will be displayed in the LCD monitor if the joystick is not placed in the center during power-on.

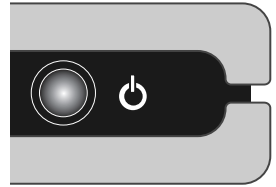

[power button]

(2) Initial Screen Display

- ① CAM ID : Shows the currently selected camera ID. Default is 1.
- ② SPD : Shows the currently selected camera model name. Default is SPD.
- ③ MONITOR : Not used; will be applied to F/W in the future.
- ④ [- -] : Shows the numbers (ID) entered when entering numbers with the number pad.
- ⑤ ID : Shows the current controller ID. If the ID is 1, it acts as the master controller. If the ID is 2 or higher, it acts as a sub-controller. Sub-controllers cannot be used independently without a master controller.

- Always assign a unique ID to ensure that the controller IDs do not conflict with each other.
- SPD : SPD-1600/ SPD-2200/ SPD-2500(Samsung Techwin Co., Ltd.)

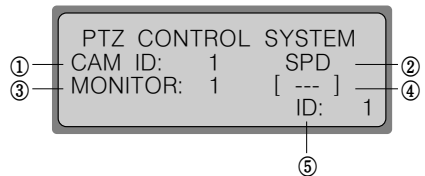

(3) Camera ID Setup

- ① Enter a number using the number pad.
- ② The number entered will be shown in the [- -] display.

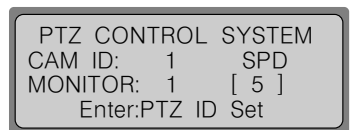

- ③ Press the CAMERA or ENTER button to set the camera ID with the number entered.
 - Any number from 1 to 255 can be selected. If the number entered is not within the selectable range, the last entered number is taken as the first number.

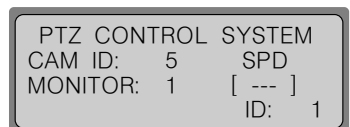

Before Operation

(4) Joystick/Camera Control Button

- The joystick can be used to control the camera's left and right (pan) and up and down (tilt) movements.

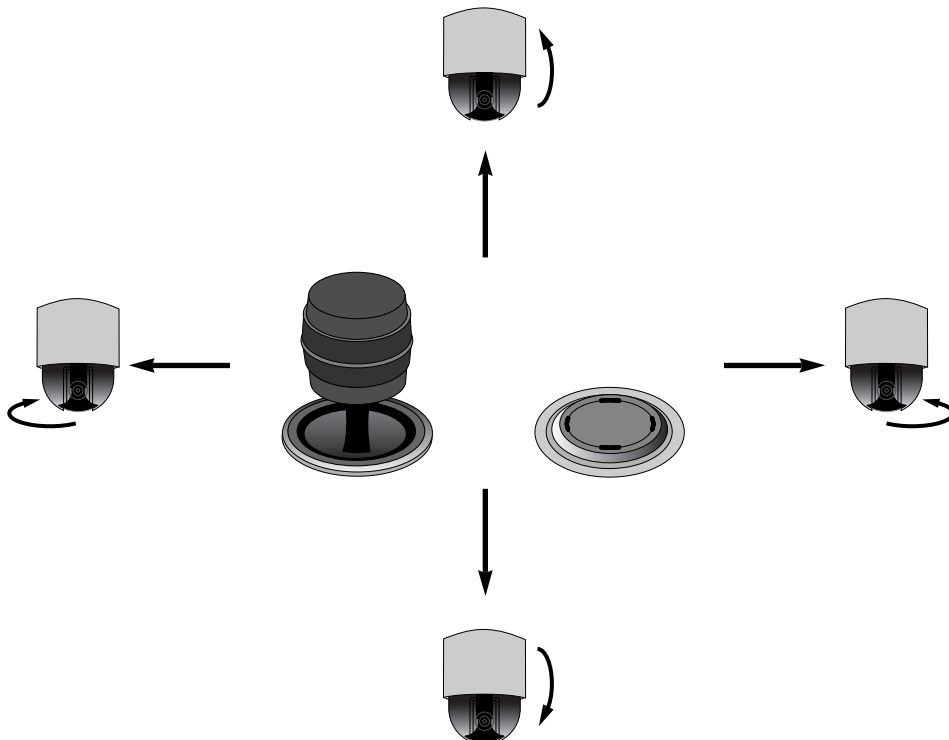

- The joystick can be used to control camera zoom functions.

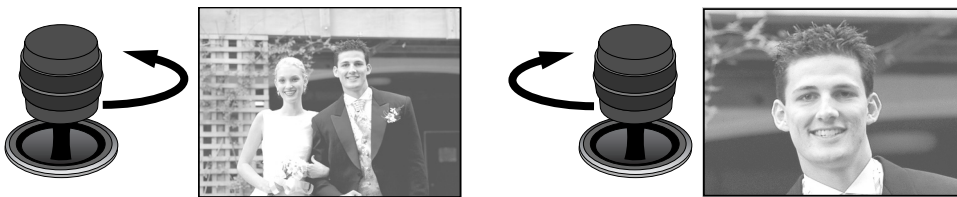

[Camera wide zoom]

[Camera telephoto zoom]

Before Operation

(5) Camera Movement Speed Control

- Use the joystick or press the Slow/Fast button at the bottom of the camera control button section to adjust the camera movement speed.
 - ▣ You must press the ESC button after adjusting the camera movement speed in order to be able to use other controller buttons.
 - ▣ The SLOW/FAST button can be used to adjust movement speed for models without a joystick.

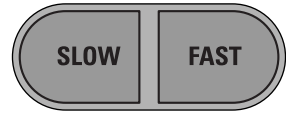

[SLOW/FAST button]

(6) Camera Zoom Control

- Press the ZOOM W/T button to control zoom wide and zoom telephoto.
ZOOM W : Zoom Wide
ZOOM T : Zoom Telephoto



ZOOM

[ZOOM W/T button]

(7) Camera Focus Control

- Press the FOCUS +/- button to control camera focus.
FOCUS - : Focus gets nearer.
FOCUS + : Focus gets further.
 - ▣ The FOCUS +/- button can be used as the ENTER/ESC button for the SVR-1630 and SPD series.



FOCUS

[FOCUS +/- button]

PTZ Mode

(1) PTZ Setup Mode

- This menu is for setting up the PTZ camera function.
It is impossible to operate Speed Dome and DVR by sub-controllers when the master controller is set to on.

① At the initial screen, press the Function button and press the 0 button to activate the [SETUP SYSTEM] menu.

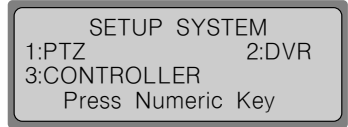

② Press the 1 button to activate the [PTZ SETUP 1 ▶] menu.

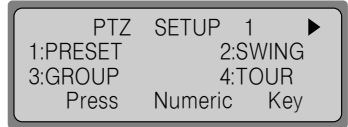

③ Press the ▶▶ button to activate the [◀ PTZ SETUP 2] menu.

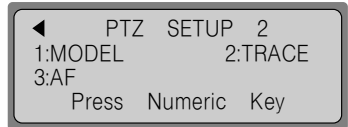

INFORMATION

- The menu may be different depending on the PTZ camera model.

Menu	Models supported	Menu	Models supported
PRESET	SPD series, PELCO-D, PANASONIC, SAMSUNG ELECTRONICS	MODEL	SPD series, PELCO-D, PANASONIC, SAMSUNG ELECTRONICS
SWING	SPD series	TRACE	SPD series, PELCO-D, PANASONIC
GROUP	SPD series	AF	SPD series, PELCO-D, PANASONIC, SAMSUNG ELECTRONICS
TOUR	SPD series	-	-

- Press the ESC button to move to an upper setup mode.

PTZ Mode

(2) PRESET

- This menu is for setting the camera to move to preset locations.

(2-1) PRESET Setup

- ① At the [PTZ SETUP 1 ▶] menu, press the 1 button (see p.15).
- ② Use the joystick or camera control button (SCC-3000 model) to move the camera to the desired location (move up, down, left, and right, and control zoom).

```
PTZ SETUP 1 ▶
CAM ID: 5 SPD
PRESET NO: 0
Enter:Preset ID Set
```

- ③ Enter a preset number.

```
PTZ SETUP 1 ▶
CAM ID: 5 SPD
PRESET NO: 1
Enter:Preset ID Set
```

- ④ Press the Enter button to assign the number to the current location.

(2-2) PRESET Movement

- ① In the initial screen, enter an assigned preset number.
- ② The selected number will be shown in the [- -] display.

```
PTZ CONTROL SYSTEM
CAM ID: 5 SPD
MONITOR: 1 [ 1 ]
Enter:PTZ ID Set
```

- ③ Press the Preset button to move the camera to the preset location.

- If the number entered is not within the selectable range, the last entered number is taken as the first number.

The selectable range for each camera model is as follows.

- SPD 1600/2200/2500 : 1 ~ 64
- PELCO-D : 1 ~ 80

Certain numbers have special functions other than preset.

- 33 + PRESET - FLIP COMMAND
- 97 + PRESET - RANDOM SCAN
- 98 + PRESET - FRAME SCAN
- 99 + PRESET - AUTO SCAN

See the camera manual for more information.

- PANASONIC (WV-CS854A) : 1 ~ 64
- Samsung (SCC-641/643) : 1 ~ 127

- Preset setup is also available in the OSD menu of the connected camera.

PTZ Mode

(3) SWING

- This menu is for setting the camera to alternate between two assigned locations horizontally (pan) or vertically (tilt). Setting the SWING SETUP menu by controllers is only possible in the SPD series. In case of products by other manufacturers, the setting has to be done by the OSD menu of the camera. See the camera manual for more information.

(3-1) SWING Setup

- ① At the [PTZ SETUP 1 ►] menu, press the 2 button (see p.15).
- ② Press the 1 or 2 button to select a horizontal (pan) or vertical (tilt) cycle.

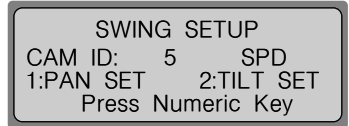

- ③ Set starting point, ending point, movement speed, and stop time.
 - I►/►► button: Moves between items.
 - 1ST : Starting point. Can be set for Preset 1 ~ 64.
 - 2ND : Ending point. Can be set for Preset 1 ~ 64.
 - SPEED : Movement speed. Can be set for 1 ~ 64 (see p.35).
 - STOP : Stop time at the starting point and ending point.
Can be set to 1 ~ 99 (seconds).

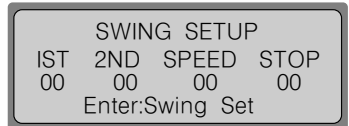

- ④ Press the ENTER button to finish the setup (takes 2 or 3 seconds to finish).
 - The Swing function cannot be set if an unassigned number or a number outside the selectable range is entered.
 - Over 2 PRESET locations have to be set before setting SWING.

(3-2) SWING Operation

- ① At the initial screen, press the Swing button.
- ② Press the 1 and 2 buttons to perform the Swing function.
 - 1 button: Performs the horizontal cycle (pan).
 - 2 button: Performs the vertical cycle (tilt).

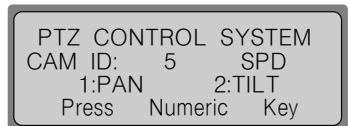

- Move the joystick or press a controller button during the Swing operation to stop the operation.
- AUTO-PAN is performed automatically when the SWING button of PANASONIC(WV-CS854A) and SAMSUNG ELECTRONICS (SCC-641/643) cameras is pressed.

PTZ Mode

(4) GROUP

- This menu is for setting repeated sequential surveillance of assigned locations with assigned speed and intervals. Setting the GROUP SETUP menu by controllers is only available for an SPD series. In case of products by other manufacturers, the setting has to be done by the OSD menu of the camera. See the camera manual for more information.

(4-1) GROUP Setup

① At the [PTZ SETUP 1 ►] menu, press the 3 button (see p.15).

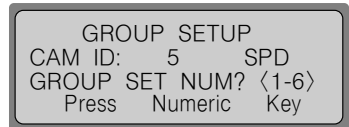

② Enter a Group number.

- Any number between 1 and 6 can be selected.

③ Set each location's Preset ID, area movement speed, and stop time.

- I►/►► button: Moves between items.

- NO : Setup sequence. Up to 64 can be selected.

- In the case of SPD 2200, setup via the controller is up to 64, but via the camera OSD menu it can be up to 128.

- PRESET : Camera Preset ID for assigned location.

- SPEED : Area movement speed. Can be set from 1 ~ 64 (see p.35).

- STOP : Stop time at the starting point and ending point.

Can be set to 1 ~ 99 (seconds).

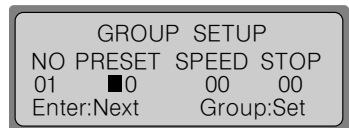

④ Press the ENTER button to move to the setup page for the next location.

Press the Group button to finish the Group Setup.

- The Group function cannot be set if an unassigned number or a number outside the selectable range is entered.

- Over 2 PRESET locations have to be set before setting GROUP.

(4-2) GROUP Operation

① At the initial screen, press the Group button.

② Press the Group button to execute the operation.

③ The Group function is performed.

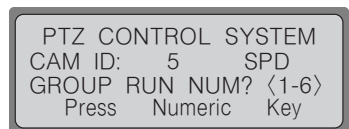

- AUTO-SEQ and SCAN functions are performed when the GROUP button is pressed (for PANASONIC(WV-CS854A) and SAMSUNG ELECTRONICS (SCC-641/643 only).

PTZ Mode

(5) TOUR

- This menu is for setting one or more Groups for Tour so that continuous Group operations can be carried out. The TOUR SETUP menu is only available for an SPD series.

(5-1) TOUR Setup

① At the [PTZ SETUP 1▶] menu, press the 4 button (see p.15).

② Press a Group number to add to the Tour.

- Up to 6 Groups can be added.

③ Press the ENTER button to finish the setup.

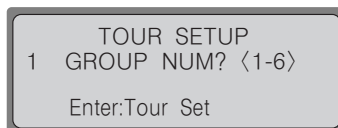

(5-2) TOUR Operation

① At the initial screen, press the Tour button.

② The Tour function is performed.

- The TOUR operation is only available for an SPD series.

PTZ Mode

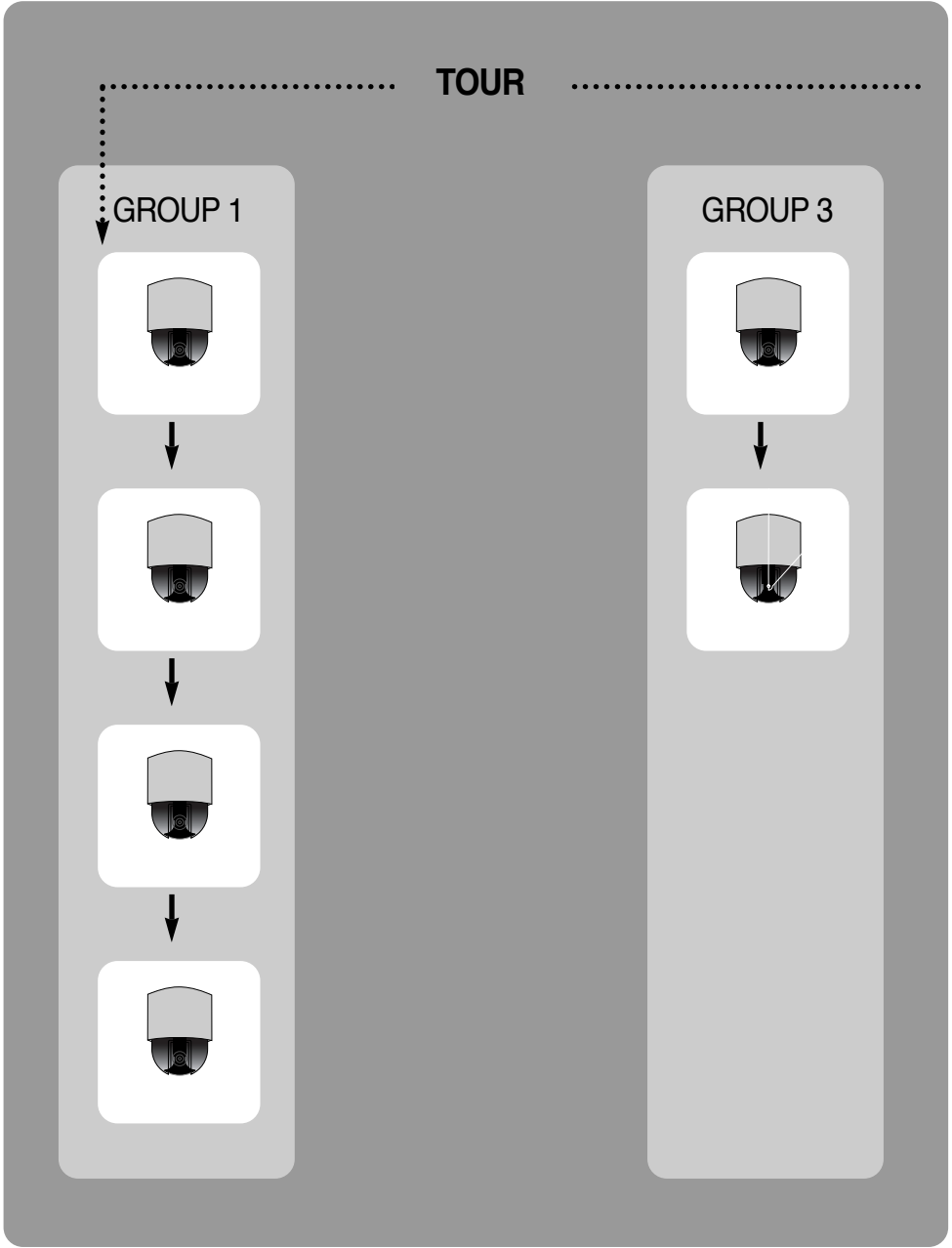

PTZ Mode

(6) MODEL

■ This menu is for setting the PTZ camera ID and camera type.

① At the [PTZ SETUP 1 ▶] menu, press the ▶▶ button (see p.15).

② Press the 1 button to move to the Model Setup screen.

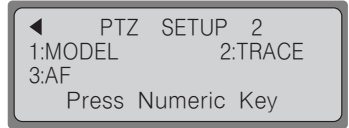

③ Press a number in the number pad to set the PTZ camera ID.

The camera model type saved in EEPROM is displayed on the LCD monitor when changing camera ID.

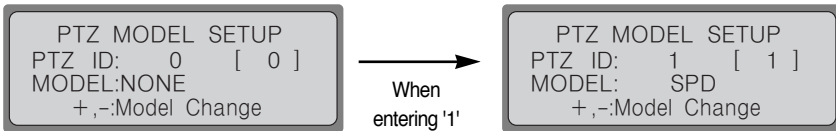

④ Press the + and - buttons on the number pad to change the camera type. SPD-1600/2200/2500, PELCO-D, PANASONIC(WV-CS854A) and SAMSUNG ELECTRONICS (SCC-643) types can be selected.

⑤ Press the ENTER button to finish the setup.

PTZ Mode

(7) TRACE

- This menu is for inputting camera movements, through joystick or camera control buttons, into the memory for a certain period of time, to allow repeating of stored movements when performing the Trace (PATTERN) function. Setting the TRACE SETUP menu by controller is only available for an SPD series.
In case of products by other manufacturers, the setting has to be done by the OSD menu of the camera.
See the camera manual for more information.

(7-1) TRACE Memory

① At the [PTZ SETUP 1 ▶] menu, press the ▶▶ button (see p.15).

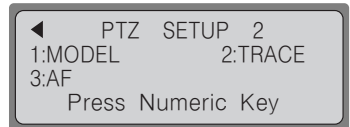

② Press the 2 button to move to the Trace Setup screen.

③ Press the 1 button.

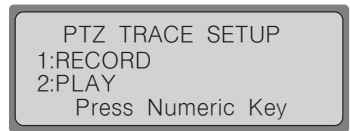

④ Use the joystick or camera control buttons to perform the camera movement to input. Allowed movements are horizontal movements (pan), vertical movements (tilt), zoom, and focus controls.



⑤ Press the ENTER button to stop camera movement input.

- Maximum length for movement memory is approximately 60 ~ 105 seconds. This may vary according to free memory space.
- Movement memory length may be shorter if the camera movement is more complicated.
- Press the FUNCTION button and the 2 button to start TRACE memory. Press the FUNCTION button and the 3 button to stop TRACE memory. For more information, see p. 8.

(7-2) TRACE Operation

① At the Trace Setup screen, press the 2 button.

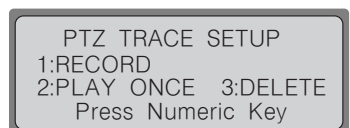

PTZ Mode

(8) AF (Auto-Focus)

- This menu is for adjusting camera focus manually or automatically after camera operation. If AF is set to OFF in the camera setup menu, set the AF of the controller to ON and then automatic adjustment is performed after camera operation.

- ① At the [PTZ SETUP 1▶] menu, press the ▶▶ button (see p.15).
- ② Press the 3 button to move to the AF Setup screen.

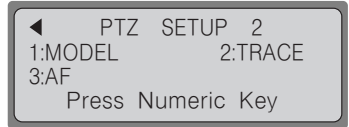

- ③ Press the 1 button to automatically adjust the focus after camera operation. Press the 2 button to disable automatic focus adjustment after camera operation.

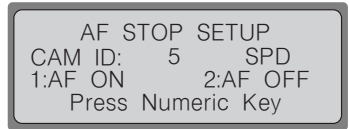

- Auto Focus Setup is also available in the OSD menu of the camera connected.
- It is recommended that you set up the AF function through the camera OSD menu.

PTZ Mode

(9) OSD

- This is used for displaying the camera menu on the monitor.

① At the initial screen, press the OSD button.

② Use the controller buttons to set up the camera menu.

- OSD : SPD 1600/2200/2500 - Toggle camera menu on/off (hold down for 2 seconds)

PELCO-D - Toggle camera menu on/off (press ESC)

PANASONIC (WV-CS854A) - Toggle camera menu on/off (press ESC)

Samsung (SCC-643/641) - Toggle camera menu on/off (press ESC)

- ESC : Cancels the menu selection.

- ENTER : Selects the menu.

- ►► : Moves the menu cursor right.

- ◀◀ : Moves the menu cursor left.

- II : Moves the menu cursor up.

- ■ : Moves the menu cursor down.

- Joystick : Use the joystick to move the menu cursor up, down, left, and right. (Applies to SPD, PELCO-D and Samsung models only)

Applies to PANASONIC models only

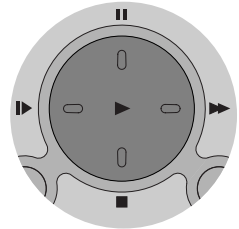

■ Joystick or other button inputs cannot be used for camera operation when the camera menu is displayed on the monitor.

■ PRESET, SWING, GROUP, and TRACE functions can be set in the OSD menu of the camera.

■ Please refer to the camera manual for more information on the camera menu.

■ When operating the PTZ camera OSD menu while the controller and SVR-1630 are connected, the ENTER and ESC functions can only be performed by the FOCUS +/- button.

DVR Mode

DVR MODEL Setup

- This menu is for setting the DVR ID and model for operation by a controller. Sub-controllers cannot be used if the master controller is in Setup mode.

① At the initial screen, press the FUNCTION button and press the 0 button to activate the [SETUP SYSTEM] menu.

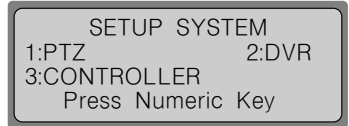

② Press the 2 button to activate the [DVR SETUP] menu.

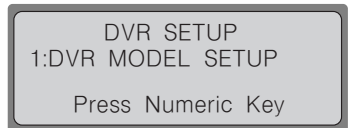

③ Press the 1 button to activate the [DVR Model SETUP] menu.

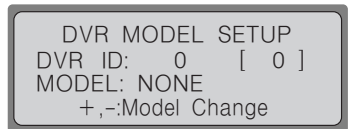

④ Press a number on the number pad to set the DVR ID.
The DVR model name saved in EEPROM will be displayed on the LCD monitor when changing DVR ID.

↓ When entering '1'

⑤ Press the + and - buttons to change the DVR model name
(SVR 430 → SVR 900 → SVR 1620 → SVR 1630).

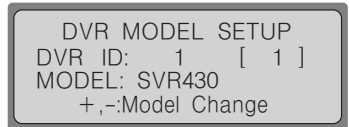

⑥ Press the ENTER button to finish the setup.

- When connecting to an SVR-430, the SVR-430 system ID must be set to be the same as the controller DVR ID (Menu → Network/Communication → RS422/485 → SYSTEM ID).
- When connecting to an SVR-900/1620, the SVR-900/1620 system ID must be set to be the same as the controller DVR ID (Menu → System Setup → Com Port Setup → SYSTEM ID).
- When connecting to an SVR-1630, the SVR-1630 keyboard control address must be set to be the same as the controller DVR ID (Menu → System Setup → Misc.). Also, for the SVR-1630 COM2 RS422/485 menu (Menu → System Setup → Serial Port), Device must be set to SCC-3000 and Interface to RS-485, and for the COM4 RS422/485 menu (Menu → System Setup → Serial Port), Device must be set to SPD2500 (if an SPD2500 is connected) and Interface to RS-485.
- When controlling a PTZ camera via an SVR-1630, connect the SVR-1630 and the controller to COM2 RX+/RX- and connect the SVR-1630 and PTZ camera to COM4 RX+/RX-. Also, at the SVR-1630 channel setup menu, set the PTZ port of each channel to COM4 and set the PTZ address to be the same as the PTZ camera ID.

Controller Mode

(1) Controller Setup Mode

- Sub-controllers cannot be operated if the master controller is in setup mode.

① At the initial screen, press the FUNCTION button and press the 0 button to activate the [SETUP SYSTEM] menu.

```
      SETUP SYSTEM
1:PTZ          2:DVR
3:CONTROLLER
      Press Numeric Key
```

② Press the 3 button to activate the [Controller SETUP 1 ►] menu.

```
CONTROLLER SETUP1 ►
1:CONTROLLER ID
2:SERIAL      3:COPY
      Press Numeric Key
```

③ Press the ►► button to activate the [◀Controller SETUP 2 ►] menu.

```
◀ CONTROLLER SETUP2 ►
1:RESPONSE
2:PASSWORD
      Press Numeric Key
```

④ Press the ►► button to activate the [► Controller SETUP 3] menu.

⑤ At the [Controller SETUP 1 ►], [◀ Controller SETUP 2 ►] or [◀ Controller SETUP 3] menu, press a menu number to open a setup menu.

```
◀ CONTROLLER SETUP3
1:PRIORITY    2:DEFAULT
3:F/W UPDATE
      Press Numeric Key
```

INFORMATION

- Press the ESC button to move to the upper setup mode.
- The Controller Setup menu can be added to enhance controller functionality.

Controller Mode

(2) Controller ID Setup

- This menu is for setting controller ID.

① At the [Controller SETUP 1 ►] menu, press the 1 button (see p.26).

```
CONTROLLER SETUP1 ►
1:CONTROLLER ID
2:SERIAL          3:COPY
Press Numeric Key
```

② Press a number on the number pad to enter a controller ID.

③ Press the ENTER button to set the controller ID.

- Assign number 1 for setting the controller ID for the master controller.
- The lower the ID number, the higher the controller priority.
- Sub-controllers can be operated only when connected to a master controller; Sub-controllers cannot be operated independently.

```
CONTROLLER ID SET
CONTROLLER ID: 1[ 0 ]
ID 1 IS MASTER ID!
Enter:ID Set <1-16>
```

(3) SERIAL Setup

- This menu is for setting the serial port for connecting external devices to the controller.

① At the [Controller SETUP 1 ►] menu, press the 2 button (see p.26).

```
CONTROLLER SETUP1 ►
1:CONTROLLER ID
2:SERIAL          3:COPY
Press Numeric Key
```

② Press the 1 button to activate the Serial 1 PORT Setup screen (PTZ camera/DVR connection PORT). Press the 2 button to activate the Serial 2 PORT Setup screen (reserved PORT).

- The value displayed at step ② indicates the current setup value.
- The BAUD RATE/ DATA BIT/ STOP BIT/ PARATY BIT for PORT 2, which connects to the sub-controller, are fixed and cannot be changed.

```
RS-422/485 SET
1:S1 9600, 8, 1, NONE
2:S3 9600, 8, 1, NONE
Press Numeric Key
```

③ The PORT Setup screen will be displayed.

Press the number for a setup menu.

- 1: Sets the BAUD RATE. (4800, 9600, 19200, 38400)
- 2: Sets the DATA BIT. (8BIT, 7BIT)
- 3: Sets the STOP BIT. (1BIT, 2BIT)
- 4: Sets the PARITY BIT. (NONE, ODD, EVEN)

- Default values for controller SERIAL are 9600 (BAUD RATE), 8BIT (DATA BIT), 1BIT (STOP BIT) and NONE (PARITY BIT).

```
RS-422/485 SET
1:BUAD          2:DATA
3:STOP BIT     4:PARITY
Press Numeric Key
```

Controller Mode

(4) DATA COPY

- This menu is for copying master controller menu data to a sub-controller.
The controller ID value is not copied.

① At the [Controller SETUP 1 ►] menu, press the 3 button (see p.26).

```
CONTROLLER SETUP1 ►
1:CONTROLLER ID
2:SERIAL          3:COPY
Press Numeric Key
```

② Press a number on the number pad to enter the ID number for the sub-controller where the data will be copied.

```
DATA COPY
SUB-CONTROL ID? [ 0 ]
Enter:ID Set (2-16)
```

③ Press the ENTER button to set the controller ID.

④ Press the 1 button to start copying data.
Press the 2 button to return to the previous menu.

```
DATA COPY
Do you want to COPY?
1:YES 2:NO SUB-ID: 2
Press Numeric Key
```

⑤ The [DATA COPYING SUCCESS] message appears when data copying is complete.
The [DATA COPYING FAIL] message appears if data copying failed.

```
DATA COPY
Wait a Minute
DATA COPYING SUCCESS
Press Numeric Key
```

[DATA COPY SUCCESSFUL]

```
DATA COPY
Wait a Minute
DATA COPYING FAIL
Press Numeric Key
```

[DATA COPY FAILURE]

- Data copy takes approximately 7~10 seconds.
This menu is available only for the master controller (ID: 1).

Controller Mode

(5) RESPONSE

- If the camera RESPONSE is set to two-way reception (RESPONSE ON), the controller RESPONSE menu must be set to ON. If the camera RESPONSE is set to one-way reception (RESPONSE OFF), the controller RESPONSE menu must be set to OFF. If this is not followed, the system may have a configuration conflict. For more information on the camera RESPONSE settings, direct your inquiries to the installation vendor. If the DIP switch for the camera connected to the controller is set to two-way reception (RESPONSE ON), this menu can be used to set up the RESPONSE value for the controller and the number of sub-controllers.

① At the [Controller SETUP 1 ►] menu, press the ►► button (see p.26).

② Press the 1 button to open the Response Setup screen.

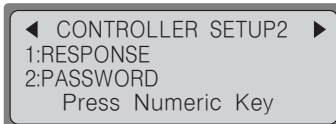

③ Press the 1 button to set the controller RESPONSE setting to ON. The controller automatically restarts to apply the change. Press the 2 button to set the controller RESPONSE setting to OFF. The master controller display shows the setup screen for the number of the connected sub-controller.

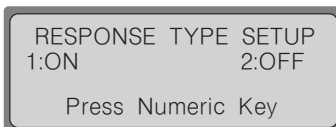

④ Press the 1 ~ 4 button to set the number of the desired sub controller. The controller automatically restarts to apply the changed settings after entering the number.

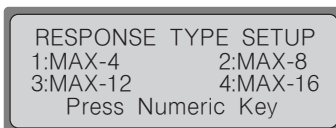

- 1: Sets the number of sub-controllers to 4 including the master controller.
- 2: Sets the number of sub-controllers to 8 including the master controller.
- 3: Sets the number of sub-controllers to 12 including the master controller.
- 4: Sets the number of sub-controllers to 16 including the master controller.

■ Set the maximum number of sub-controllers, to shorten the sub controller data loading time by making the master controller memorize the number of sub-controllers.

■ If Response is set as ON, a maximum of 12 sub-controllers only can be selected.

Controller Mode

■ For information on camera RESPONSE settings (DIP switch settings), refer to the camera manual.

(5-1) SPD-1600 DIP Setup

		ON	OFF
DIP-SW 1	Not used	Always OFF	
DIP-SW 2	Reserved	Always OFF	
DIP-SW 3	RESPONSE Setup	HALF DUPLEX	FULL DUPLEX
DIP-SW 4	Factory default	Always OFF	

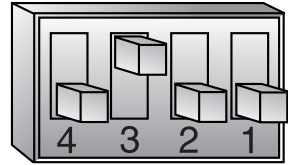

[RESPONSE ON Setup]

(5-2) SPD-2200 DIP Setup

		ON	OFF
DIP-SW 1	RESPONSE Setup	FULL DUPLEX	HALF DUPLEX
DIP-SW 2	Reserved	Always OFF	
DIP-SW 3	Termination setting	Refer to the camera user manual	
DIP-SW 4			

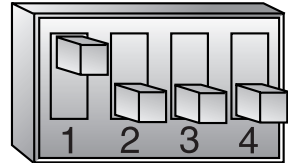

[RESPONSE ON Setup]

(5-3) SPD-2500 DIP Setup

		ON	OFF
DIP-SW 1	Not used	Always OFF	
DIP-SW 2	Reserved	Always OFF	
DIP-SW 3	RESPONSE Setup	HALF DUPLEX	FULL DUPLEX
DIP-SW 4	Factory default	Always OFF	

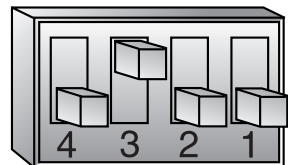

[RESPONSE ON Setup]

Controller Mode

(6) PASSWORD

- This menu is for setting the password to enter when changing controller setup values upon power-on.

(6-1) PASSWORD Setup

① At the [Controller SETUP 1 ►] menu, press the ►► button (see p.26).

② Press the 2 button to activate the Password Setup screen.

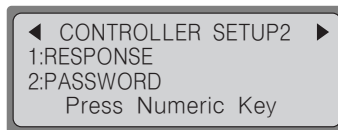

③ Press the 1 button to activate the Password Setup screen.

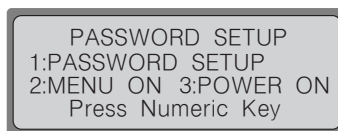

④ Use the number pad to enter a 6-digit password.

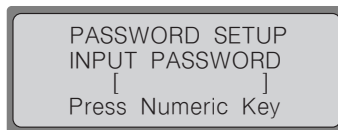

⑤ The password verification screen will appear.
Re-enter the same password. The password will be saved.

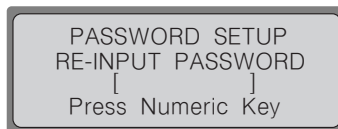

- The factory default password is ****.
Please change the password after installation.

Controller Mode

(6-2) Applying Password – Setup Mode

① At the Password Setup screen, press the 2 button.

PASSWORD SETUP
1:PASSWORD SETUP
2:MENU ON 3:POWER ON
Press Numeric Key

② Press the 1 button to ask for a password every time the setup mode is selected. Press the 2 button to skip asking for a password.

PASSWORD SETUP
1:MENU PASSWORD ON
2:MENU PASSWORD OFF
Press Numeric Key

(6-3) Applying Password - Power

① At the Password Setup screen, press the 3 button.

PASSWORD SETUP
1:PASSWORD SETUP
2:MENU ON 3:POWER ON
Press Numeric Key

② Press the 1 button to ask for a password every time the appliance is powered on. Press the 2 button to skip asking for a password.

PASSWORD SETUP
1:POWER PASSWORD ON
2:POWER PASSWORD OFF
Press Numeric Key

(6-4) Entering Password

If a password is set, the password has to be entered every time the appliance is powered on or before entering the setup menu. At the screen as illustrated on the right, enter the password set at step (6-1).

PASSWORD SETUP
INPUT PASSWORD
[]
Press Numeric Key

Controller Mode

(7) PRIORITY

- This menu is for setting the connected sub-controller to use a PTZ camera or DVR within the specified restrictions. This menu is available for master controller (ID: 1) only.

① At the [Controller SETUP 1 ►] menu, press the ►► button twice (see p.26).

② Press the 1 button to activate the Priority Setup screen.

```
◀ CONTROLLER SETUP3
1:PRIORITY      2:DEFAULT
3:F/W UPDATE
  Press Numeric Key
```

③ Press the 1 button to activate the PTZ Camera Restriction Setup menu. Press the 2 button to activate the DVR Restriction Setup menu.

```
PRIORITY SETUP
1:PTZ ID LIMIT
2:DVR ID LIMIT
  Press Numeric Key
```

④ Use the controller button to set the menu.

[ID]: ID of the assigned sub-controller.

Left [000-255] : The currently selected restriction ID.

Right [000-000] : ID to be assigned.

- 1►/►► : Moves items left and right.

- 2 ~ 16 : Enters ID number.

- ESC : Moves to the upper menu.

- ENTER : Finishes setup.

```
PTZ ID LIMIT
ID   LIMITED RANGE
02  000-255    000-000
Esc:Exit  Enter:Set
```

[PTZ Camera Restriction Setup Menu]

```
DVR ID LIMIT
ID   LIMITED RANGE
02  000-255    000-000
Esc:Exit  Enter:Set
```

[DVR Restriction Setup Menu]

Controller Mode

(8) DEFAULT

- This menu is for resetting the changed controller setup values to the default values.

① At the [Controller SETUP 1 ►] menu, press the ►► button twice (see p.26).

② Press the 2 button to open the Default Setup screen.



◀ CONTROLLER SETUP3
1:PRIORITY 2:DEFAULT
3:F/W UPDATE
Press Numeric Key

③ Press the 1 button to change the controller setup values to the default values and restart the controller.
Press the 2 button to cancel the process.

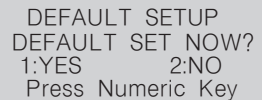

DEFAULT SETUP
DEFAULT SET NOW?
1:YES 2:NO
Press Numeric Key

REFERENCE

(1) Swing, Group Movement Speed

■ For Swing setup, the speed setup value can be 240°/second for pan, and 180°/second for tilt.

Setup value	Degrees / second	Setup value	Degrees / second	Setup value	Degrees / second	Setup value	Degrees / second
1	0.8	33	23	1	0.8	33	23
2	1.0	34	24	2	1.0	34	24
3	1.5	35	25	3	1.5	35	25
4	2.0	36	26	4	2.0	36	26
5	2.5	37	27	5	2.5	37	27
6	3.0	38	28	6	3.0	38	28
7	3.5	39	29	7	3.5	39	29
8	4.0	40	30	8	4.0	40	30
9	4.5	41	35	921.19	Tm0.1(41)	-1155

REFERENCE

(2) System Connections

(2-1) Connecting Controller and Junction Box

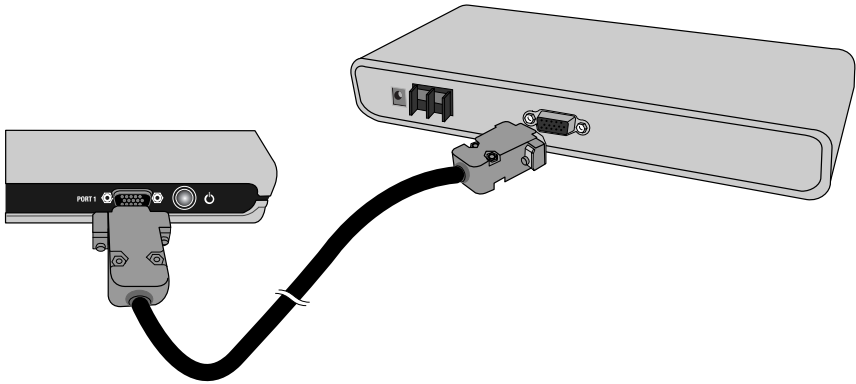

(2-2) Connecting Junction Box and External Devices

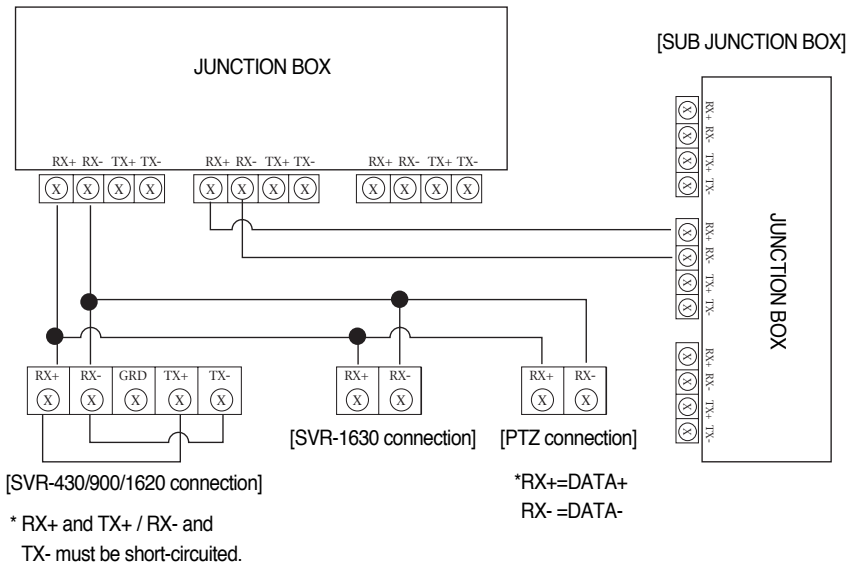

- When connecting with an SVR-1630, only SPD series PTZ cameras can be employed.
- When controlling a PTZ camera via an SVR-1630 there is a delay, and the response may be slow.
- When controlling a PTZ camera with a sub-controller there is a delay, and the response may be slow.

REFERENCE

(3) RS-485/422 Pin Layout (D_SUB_FEMALE)

Terminal	Name	
1	+12V	
2	RX+ (RS-485+)	PORT1
3	RX- (RS-485-)	PORT1
4	TX-	PORT1
5	TX+	PORT1
6	-	
7	RX+ (RS-485 +)	PORT2
8	RX- (RS-485 -)	PORT2
9	TX-	PORT2
10	TX+	PORT2
11	GND	
12	RX+ (RS-485 +)	PORT3
13	RX- (RS-485 -)	PORT3
14	TX-	PORT3
15	TX+	PORT3

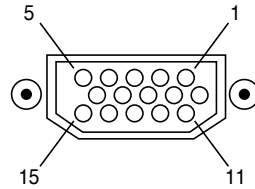

(4) RS-232C Pin Layout (D_SUB_MALE)

Terminal	Name	
1	-	
2	RX	
3	TX	
4	-	
5	GND	
6	-	
7	-	
8	-	
9	-	

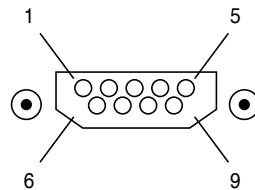

REFERENCE

(5) Controller Specifications

MODEL	SCC-3000
Power (Consumption)	12VDC(Max 700mA)
Control	DVR & Speed Dome (SPD-2500, 1600, 2200)
PTZ Control	SPD-2500, 1600, 2200 all function control
Compatibility	- DVR : SVR-1620 / 900 / 430 / 1630 / 1650 - PTZ : SEC, PELCO-D, PANASONIC
Remote Control	RS-485 / RS-422
Connector	3Port
Baud Rate (bps)	Max 38400bps (Sub-controller : 56400bps)
LCD Display	20 x 4 Character LCD
PTZ Control	Joystick (3Axis Twist Zoom)
Sub Keyboard	Flow control connected with Master Keyboard
Auto Surveillance	Tour, Group, Swing, Preset
Operating temperature(Humidity)	0 ~ 40°(10% ~ 75%)
Storage temperature(Humidity)	-5 ~ 55°(10% ~ 95%)
Weight	2kg
Dimension	400mm X 180mm X 45mm (Without Joystick' height)

(6) RS-485/422 Specifications

Type	Asynchronous Serial, 1 START BIT, 8 DATA BIT, NO PARITY, 1 STOP BIT
Transmission method	HALF DUPLEX / FULL DUPLEX
Transmission rate	4800 ~ 38400 (9600bps recommended)
Composition	4 lines (Twist pair)

(7) Junction Box DIP Switch

- RS-485 Termination ON



- RS-485 Termination OFF



- RS-422 Termination ON



- RS-422 Termination OFF





SALES NETWORK

SAMSUNG TECHWIN CO., LTD.

145-3, Sangdaewon 1-Dong, Jungwon-Gu,
Sunghnam, Kyungki-Do, Korea 462-703
TEL: +82-31-740-8137~8141 FAX: +82-31-740-8145

SAMSUNG OPTO-ELECTRONICS AMERICA, INC. ELECTRONIC IMAGING DIV.

40 Seaview Drive, Secaucus NJ 07094, U.S.A
TEL : +1-201-902-0347 FAX: +1-201-902-0429

SAMSUNG TECHWIN MOSCOW OFFICE

LENNINGRADSDY PR-KT, 37A. KORP.14
RUSSIA, 125167, MOSCOW
TEL: +7-095-258-9296, 9298 FAX: +7-095-258-9297

SAMSUNG OPTO-ELECTRONICS UK LTD.

Samsung House, 1000 Hillswood Drive
Hillswood Business Park Chertsey Surrey KT16 OPS
TEL: +44 (0)1932 455 308 FAX: +44 (0)1932 455 325

TIANJIN SAMSUNG OPTO-ELECTRONICS CO., LTD .

7 Pingchang Rd, Nankai Dist, Tianjin, P.R China
Post Code : 300190
TEL : +86-22-2761-4599 FAX: +86-22-2769-7558

<http://www.samsungtechwin.com>
<http://www.samsungcctv.com>

P/No.:6806-0586-01A

Free Manuals Download Website

<http://myh66.com>

<http://usermanuals.us>

<http://www.somanuals.com>

<http://www.4manuals.cc>

<http://www.manual-lib.com>

<http://www.404manual.com>

<http://www.luxmanual.com>

<http://aubethermostatmanual.com>

Golf course search by state

<http://golfingnear.com>

Email search by domain

<http://emailbydomain.com>

Auto manuals search

<http://auto.somanuals.com>

TV manuals search

<http://tv.somanuals.com>