

**SAMSUNG TECHWIN**

**8 CHANNEL/  
16 CHANNEL DVR**

User Manual

SDE-400x/SDE-500x



**SAMSUNG**

**CE**



**SAMSUNG**

# 8 Channel/ 16 Channel DVR

## User Manual

---

### Copyright

©2012 Samsung Techwin Co., Ltd. All rights reserved.

### Trademark

 **SAMSUNG TECHWIN** is the registered logo of Samsung Techwin Co., Ltd.

The name of this product is the registered trademark of Samsung Techwin Co., Ltd.

Other trademarks mentioned in this manual are the registered trademark of their respective company.

### Restriction

Samsung Techwin Co., Ltd shall reserve the copyright of this document. Under no circumstances, this document shall be reproduced, distributed or changed, partially or wholly, without formal authorization of Samsung Techwin.

### Disclaimer

Samsung Techwin makes the best to verify the integrity and correctness of the contents in this document, but no formal guarantee shall be provided. Use of this document and the subsequent results shall be entirely on the user's own responsibility. Samsung Techwin reserves the right to change the contents of this document without prior notice.

❖ **Design and specifications are subject to change without prior notice.**

❖ **The default password can be exposed to a hacking thread so it is recommended to change the password after installing the product. Note that the security and other related issues caused by the unchanged password shall be responsible for the user.**

## IMPORTANT SAFETY INSTRUCTIONS

---

Read these operating instructions carefully before using the unit.

Follow all the safety instructions listed below.

Keep these operating instructions handy for future reference.

- 1) Read these instructions.
- 2) Keep these instructions.
- 3) Heed all warnings.
- 4) Follow all instructions.
- 5) Do not use this apparatus near water.
- 6) Clean only with dry cloth.
- 7) Do not block any ventilation openings, Install in accordance with the manufacturer's instructions.
- 8) Do not install near any heat sources such as radiators, heat registers, stoves, or other apparatus (including amplifiers) that produce heat.
- 9) Do not defeat the safety purpose of the polarized or grounding- type plug. A polarized plug has two blades with one wider than the other. A grounding type plug has two blades and a third grounding prong. The wide blade or the third prong are provided for your safety. If the provided plug does not fit into your outlet, consult an electrician for replacement of the obsolete outlet.
- 10) Protect the power cord from being walked on or pinched particularly at plugs, convenience receptacles, and the point where they exit from the apparatus.
- 11) Only use attachments/accessories specified by the manufacturer.
- 12) Use only with the cart, stand, tripod, bracket, or table specified by the manufacturer, or sold with the apparatus. When a cart is used, use caution when moving the cart/apparatus combination to avoid injury from tip-over.
- 13) Unplug this apparatus during lightning storms or when unused for long periods of time.
- 14) Refer all servicing to qualified service personnel. Servicing is required when the apparatus has been damaged in any way, such as power-supply cord or plug is damaged, liquid has been spilled or objects have fallen into the apparatus, the apparatus has been exposed to rain or moisture, does not operate normally, or has been dropped.



# overview

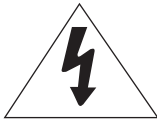

## CAUTION

RISK OF ELECTRIC SHOCK.  
DO NOT OPEN



**CAUTION** : TO REDUCE THE RISK OF ELECTRIC SHOCK, DO NOT REMOVE COVER (OR BACK) NO USER SERVICEABLE PARTS INSIDE. REFER SERVICING TO QUALIFIED SERVICE PERSONNEL.



This symbol indicates that dangerous voltage consisting a risk of electric shock is present within this unit.



This exclamation point symbol is intended to alert the user to the presence of important operating and maintenance (servicing) instructions in the literature accompanying the appliance.

## WARNING

- To reduce the risk of fire or electric shock, do not expose this appliance to rain or moisture.
- To prevent injury, this apparatus must be securely attached to the floor/wall in accordance with the installation instructions.

## WARNING

1. Be sure to use only the standard adapter that is specified in the specification sheet. Using any other adapter could cause fire, electrical shock, or damage to the product.
2. Incorrectly connecting the power supply or replacing battery may cause explosion, fire, electric shock, or damage to the product.
3. Do not connect multiple cameras to a single adapter. Exceeding the capacity may cause abnormal heat generation or fire.
4. Securely plug the power cord into the power receptacle. Insecure connection may cause fire.
5. When installing the camera, fasten it securely and firmly. The fall of camera may cause personal injury.
6. Do not place conductive objects (e.g. screwdrivers, coins, metal parts, etc.) or containers filled with water on top of the camera. Doing so may cause personal injury due to fire, electric shock, or falling objects.
7. Do not install the unit in humid, dusty, or sooty locations. Doing so may cause fire or electric shock.
8. If any unusual smells or smoke come from the unit, stop using the product. In such case, immediately disconnect the power source and contact the service center. Continued use in such a condition may cause fire or electric shock.
9. If this product fails to operate normally, contact the nearest service center. Never disassemble or modify this product in any way. (SAMSUNG is not liable for problems caused by unauthorized modifications or attempted repair.)
10. When cleaning, do not spray water directly onto parts of the product. Doing so may cause fire or electric shock.
11. Do not expose the product to the direct airflow from an air conditioner. Otherwise, it may cause moisture condensation inside the Clear Dome due to temperature difference between internal and external of the dome camera.
12. If you install this product in a low-temp area such as inside a cold store, you must seal up the wiring pipe with silicon, so that the external air can not flow inside the housing. Otherwise, external high, humid air may flow inside the housing, pooling moisture or vapor inside the product due to a difference between internal and external temperature.

## BEFORE START

This user manual provides Information for using the DVR such as brief introduction, part names, functions, connection to other equipment, menu setup, etc.

You have to keep in mind the following notices :

- SAMSUNG retains the copyright on this manual.
- This manual cannot be copied without SAMSUNG's prior written approval.
- We are not liable for any or all losses to the product incurred by your use of non-standard product or violation of instructions mentioned in this manual.
- Prior to opening the case, please consult a qualified technician first. Whenever this is needed power must be removed from the unit.
- Before installing an additional HDD or connecting an external storage device (USB HDD) to this DVR, check the compatibility. Consult your provider for the compatibility list.

### Warning

#### ❖ Battery

It is essential that when changing the battery in the unit, the replacement battery must be of the same type otherwise there may be a possibility of an explosion.

The following are the specifications of the battery you are using now.

- Normal voltage : 3V
- Normal capacity : 170mAh
- Continuous standard load : 0.2mA
- Operating temperature : -20°C ~ +85°C  
(-4°F ~ +185°F)

#### CALIFORNIA USA ONLY

This Perchlorate warning applies only to primary CR (Manganese Dioxide) Lithium coin cells in the product sold or distributed ONLY in California USA. "Perchlorate Material - special handling may apply, See [www.dtsc.ca.gov/hazardouswaste/perchlorate](http://www.dtsc.ca.gov/hazardouswaste/perchlorate)."

#### Caution

- Connect the power cord into a grounded outlet.
- The Mains plug is used as a disconnect device and shall stay readily operable at any time.
- Batteries shall not be exposed to excessive heat such as sunshine, fire or the like
- Risk of Explosion if Battery is replaced by an Incorrect Type. Dispose of Used Batteries According to the Instructions.

#### ❖ System Shutdown

Turning off the power while the product is in operation, or undertaking improper actions may cause damage or malfunction to the hard drive or the product.

Please turn off the power using the Power button on the front of your DVR.

For SDE-4003/5003, please right-click to display the context sensitive menu and select <Shutdown>.

After selecting <OK> in the pop-up menu, you can pull off the power cord.

You may want to install a UPS system for safe operation in order to prevent damage caused by an unexpected power stoppage. (Any questions concerning UPS, consult your UPS retailer.)

#### ❖ Operating Temperature

The guaranteed operating temperature range of this product is 0°C ~ 40°C (32°F ~ 104°F).

This product may not work properly if you run right after a long period of storage at a temperature below the guaranteed one.

Prior to using a device that has been stored for a long period in low temperatures, allow the product to stand at room temperature for a period.

Especially for the built-in HDD in the product, its guaranteed temperature range is 5°C ~ 55°C (41°F ~ 131°F). Likewise, the hard drive may not work at a temperature below the guaranteed one.

#### ❖ Ethernet Port

DVR is designed for indoor use only and all the communication wirings are limited to inside of the building.



- Do not connect UTP camera and BNC camera simultaneously. (CH1, CH2)  
(SDE-4001/4002/4004/4005/5001/5002)

# overview

---

## CONTENTS

---

### OVERVIEW

3

- 3 Important Safety Instructions
- 5 Before Start
- 6 Contents
- 8 Features
- 17 Part Names and Functions (Front)
- 19 Part Names and Functions (Rear)
- 21 Remote Control

### CONNECTING WITH OTHER DEVICE

23

- 23 installation
- 23 Checking the Installation Environment
- 24 Connecting the Video, Audio and Monitor
- 25 Connecting the USB
- 25 Connecting the Camera (SED-1001R, SEB-1005R, SEB-1007R)
- 26 Connecting the Camera (SEB-1020R)
- 32 Connecting the Alarm Input/Output
- 32 Connecting the Network

### LIVE

34

- 34 Getting Started
- 36 Live Screen Configuration
- 41 Live Mode
- 44 Spot Out
- 44 Zoom
- 45 Audio On/Off
- 45 Freeze
- 46 Event Monitoring

### MAIN MENU

47

- 47 System Setup
- 59 Setting the Device
- 66 Setting the Recording
- 70 Setting the Event
- 74 Backup
- 75 Network Configuration

**SEARCH & PLAY**

89

- 89 Search
- 92 Playback

**WEB VIEWER**

94

- 94 Introducing Web Viewer
- 95 Connecting Web Viewer (Mac)
- 96 Using Live Viewer (Mac)
- 97 Connecting Web Viewer (Windows)
- 98 Using Live Viewer (Windows)
- 103 Using Search Viewer
- 107 Viewer Setup
- 118 About
- 119 Mobile Viewer

**BACKUP VIEWER**

120

- 120 SEC Backup Viewer

**APPENDIX**

123

- 123 Product Specification (Camera)
- 126 Product Specification
- 135 Default Setting
- 138 Troubleshooting
- 141 Open Source License Report on the Product

# overview

---

## FEATURES

---

The DVR employs H.264 video encoding for 8 or 16 channel inputs and G.711 audio encoding for 8 or 16 channels while simultaneously supports hard disc recording and playback.

These DVRs also supports network connectivity, providing remote monitoring from a remote PC transferring video and audio data.

- Provides a convenient User Interface
- 8/16 CH Composite/UTP Input Connectors
- Supports CIF(S)/2CIF(M)/4CIF(L) recording formats
- With the network specific codec, network transfer enabled regardless of the recording conditions
- De-interlacing processor for better picture quality
- Display of HDD information and status by using HDD SMART
- Hard Disk overwrite function
- Mass storage hard disk backup through high-speed USB 2.0
- Simultaneous Record and Playback of 8/16-channel video data
- Various Search Modes (Search by Time, Event, Backup and Motion Detection)
- Various Recording Modes (Manual, Event, Scheduled Recording)
- Alarm Interface
- Remote Monitoring function by Network Viewer, Smart Viewer and Mobile Viewer

## Standards Approvals

---



- This equipment has been tested and found to comply with the limits for a Class A digital device, pursuant to part 15 of the FCC Rules. These limits are designed to provide reasonable protection against harmful interference when the equipment is operated in a commercial environment.





This equipment generates, uses, and can radiate radio frequency energy and, if not installed and used in accordance with the instruction manual, may cause harmful interference to radio communications. Operation of this equipment in a residential area is likely to cause harmful interference in which case the user will be required to correct the interference at his own expense.



## Package Contents

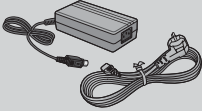

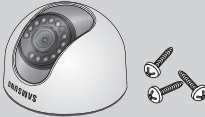
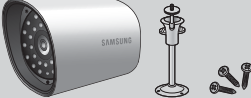
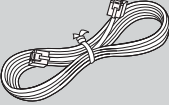
Please unwrap the product, and place the product on a flat place or in the place to be installed.  
Please check the following contents are included in addition to the main unit.

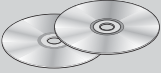
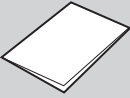
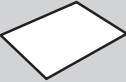
### ❖ SDE-4001N Package

		
DVR (1SET)	Adapter (2EA) / Power Cable (2EA)	Mouse (1EA)
		
Remote Control (1EA) / Battery (2EA)	SED-1001R (2SET)	SEB-1005R (4SET)
		
Camera Cable (6EA)	Network Cable (1EA)	SmartViewer (1EA) / Manual CD (1EA)
		
Quick Start Guide (1EA)	Warranty Card (1EA)	



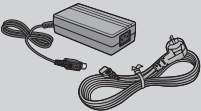

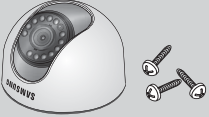
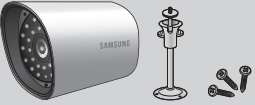
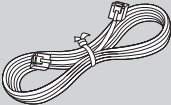
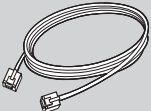
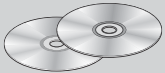
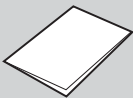
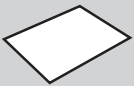

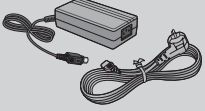

# overview

## ❖ SDE-4001P Package

		
DVR (1SET)	Adapter (2EA) / Power Cable (2EA)	Mouse (1EA)
		
Remote Control (1EA) / Battery (2EA)	SED-1001R (2SET)	SEB-1005R (2SET)
		
Camera Cable (4EA)	Network Cable (1EA)	SmartViewer (1EA) / Manual CD (1EA)
		
Quick Start Guide	Warranty Card (1EA)	

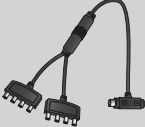
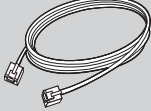

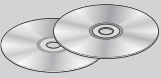
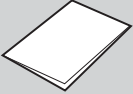
- ! ■ Depending on sales territory, quantity of Quick Start Guide differs.
- SDE-4001P/AJ Model doesn't include "Warranty Card".

❖ SDE-4003N Package

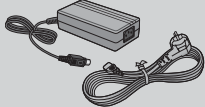

		
<p>DVR (1SET)</p>	<p>Adapter (1EA) / Power Cable (1EA)</p>	<p>Mouse (1EA)</p>
		
<p>Remote Control (1EA) / Battery (2EA)</p>	<p>SEB-1020R (4SET)</p>	<p>Camera Cable (4EA)</p>
		
<p>Camera Power Cable (1EA)</p>	<p>Network Cable (1EA)</p>	<p>Expansion pipe (12EA)</p>
		
<p>SmartViewer (1EA) / Manual CD (1EA)</p>	<p>Quick Start Guide (1EA)</p>	<p>Warranty Card (1EA)</p>

# overview

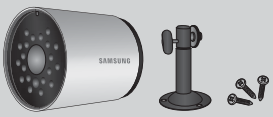
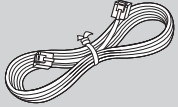
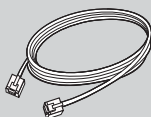
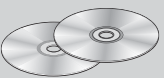
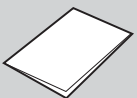
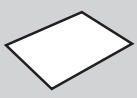
## ❖ SDE-4004N Package



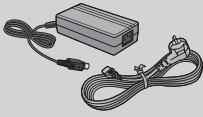

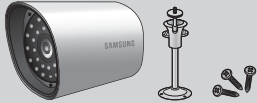
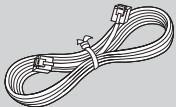
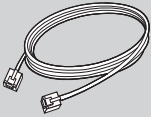
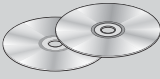
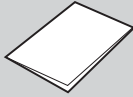
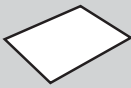
		
DVR (1SET)	Adapter (2EA) / Power Cable (2EA)	Mouse (1EA)
		
Remote Control (1EA) / Battery (2EA)	SEB-1007R (4SET)	Camera Cable (4EA)
		
Network Cable (1EA)	SmartViewer (1EA) / Manual CD (1EA)	Quick Start Guide (1EA)
		
Warranty Card (1EA)		

## ❖ SDE-4005N Package

		
DVR (1SET)	Adapter (2EA) / Power Cable (2EA)	Mouse (1EA)
		
Remote Control (1EA) / Battery (2EA)	SEB-1005R (4SET)	Camera Cable (4EA)
		
Network Cable (1EA)	SmartViewer (1EA) / Manual CD (1EA)	Quick Start Guide (1EA)
		
Warranty Card (1EA)		

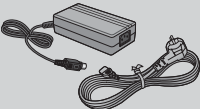

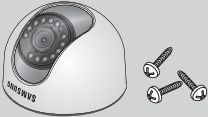
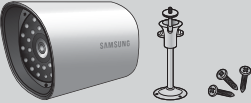
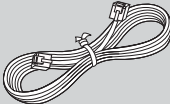
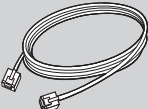
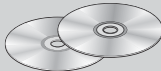
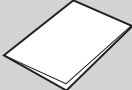
# overview

## ❖ SDE-5001N Package

		
DVR (1SET)	Adapter (2EA) / Power Cable (2EA)	Mouse (1EA)
		
Remote Control (1EA) / Battery (2EA)	SED-1001R (4SET)	SEB-1005R (4SET)
		
Camera Cable (8EA)	Network Cable (1EA)	SmartViewer (1EA) / Manual CD (1EA)
		
Quick Start Guide (1EA)	Warranty Card (1EA)	

- ! ■ SDE-5001P/AJ Model doesn't include "Warranty Card".

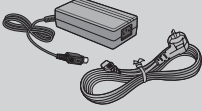

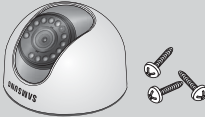
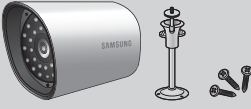
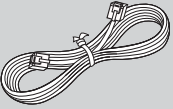
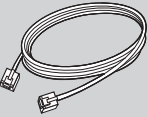
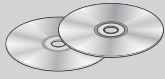
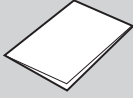
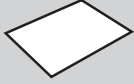



## ❖ SDE-5002N Package

		
DVR (1SET)	Adapter (2EA) / Power Cable (2EA)	Mouse (1EA)
		
Remote Control (1EA) / Battery (2EA)	SED-1001R (4SET)	SEB-1007R (4SET)
		
Camera Cable (8EA)	Network Cable (1EA)	SmartViewer (1EA) / Manual CD (1EA)
		
Quick Start Guide (1EA)	Warranty Card (1EA)	

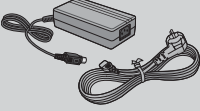
- ❗ SDE-5002P/AJ Model doesn't include "Warranty Card".

# overview

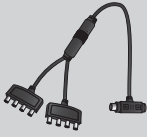
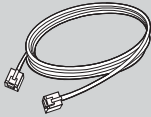
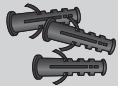
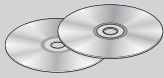
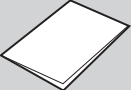
## ❖ SDE-5003N Package

		
DVR (1SET)	Adapter (1EA) / Power Cable (1EA)	Mouse (1EA)
		
Remote Control (1EA) / Battery (2EA)	SEB-1020R (8SET)	Camera Cable (8EA)
		
Camera Power Cable (1EA)	Network Cable (1EA)	Expansion pipe (24EA)
		
SmartViewer (1EA) / Manual CD (1EA)	Quick Start Guide (1EA)	Warranty Card (1EA)



## PART NAMES AND FUNCTIONS (FRONT)

SDE-4003/5003



Part Names	Functions
<b>1</b> USB Port	Connects the USB devices.
<b>2</b> Remote Control Receiver	Input the remote control signal.
<b>3</b> LED Indicator	<b>POWER</b> : Displays the power ON/OFF status.
	<b>ALARM</b> : Lights on when an event occurs.
	<b>REC</b> : Lights on when recording is in progress.



- All functions of SDE-4003/5003 are operable with mouse control, since there are no front buttons.

SDE-4001/4002/4004/4005/5001/5002

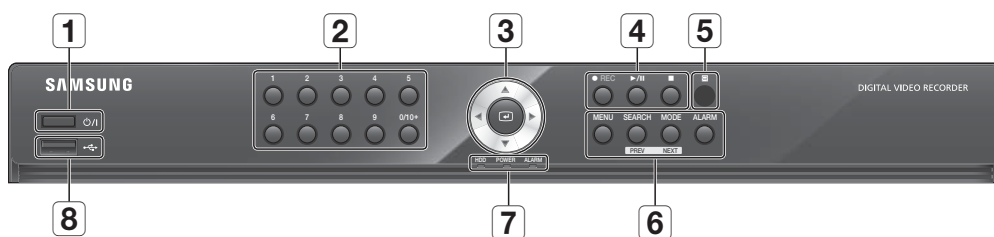

Part Names	Functions
<b>1</b> Power	Used to turn the DVR ON/OFF.
<b>2</b> Channel	Used to select channel numbers directly in the Live Mode, or numbers in the numeric input mode. <ul style="list-style-type: none"> <li>CHANNEL 1–9 : Press each button between 1 to 9. (8CH : 8)</li> <li>CHANNEL 10 : Press the [0/10+] button first, then press the [0/10+] within 1 second.</li> <li>CHANNEL 11–16 : Press the [0/10+] button first, then press any number between 1 to 6 within 1 second.</li> </ul>

# overview

	Part Names	Functions
3	Direction (▲▼◀▶) / Select Button	Used to change a value or move the cursor up/down/left/right. Selects a menu item or executes the selected menu.
4	REC	Starts or ends the recording.
	▶/   ■	<b>Play/Pause</b> : Used to pause or resume the screen. <b>Stop</b> : Used to stop the playback.
5	Remote Control Receiver	Input the remote control signal.
6	MENU	Either goes to the system menu screen or moves to the upper menu from the lower menu.
	SEARCH / PREV	Starts search menu. <b>PREV</b> : Used to move to the previous page in setup or search page.
	MODE / NEXT	Each time you press the button in Live mode, the screen mode will be switched in sequence. Each time you press the button in play mode, the screen mode will be switched in sequence. (1 live channel + (N-1) live channel) <b>NEXT</b> : Used to move to the next page in setup or search page.
7	ALARM	Cancels the ALARM LED and the audible alarm when the alarm is going off, and to remove the icon.
	LED Indicator	<b>HDD</b> : Displays the normal access to HDD. Upon access to HDD, LED is on.
	LED Indicator	<b>POWER</b> : Displays the power ON/OFF status. <b>ALARM</b> : Lights on when an event occurs.
8	USB Port	Connects the USB devices.

## PART NAMES AND FUNCTIONS (REAR)

### SDE-4003

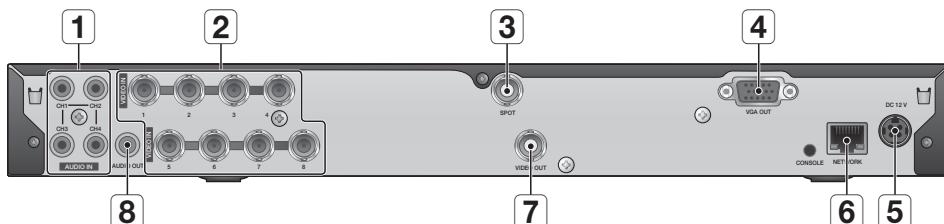

### SDE-5003

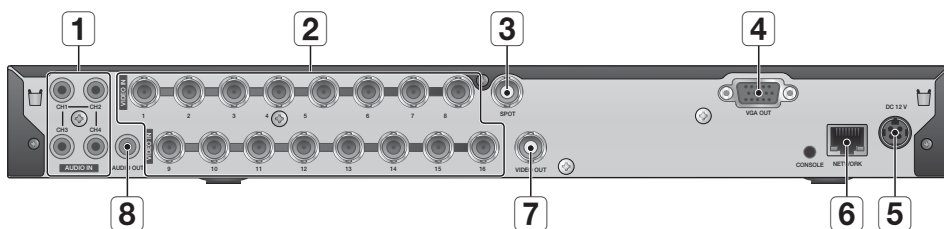

Part Names	Functions
<b>1</b> AUDIO IN	Input ports (RCA jack) for the audio signal.
<b>2</b> VIDEO IN	Input port for the composite video signal.
<b>3</b> SPOT	BNC type of output port for the Spot signal.
<b>4</b> VGA OUT	Output port for VGA video signal.
<b>5</b> DC 12V	DVR power input port.
<b>6</b> NETWORK	NETWORK connector port.
<b>7</b> VIDEO OUT	BNC type of output port for the composite video signal.
<b>8</b> AUDIO OUT	Output port (RCA jack) for the audio signal.



- [CONSOLE] is designed for the service repair purpose only.
- SDE-4003 and SDE-5003 Model don't support the function of "ALARM IN" and "ALARM OUT".

# overview

## SDE-4001/4002/4004/4005

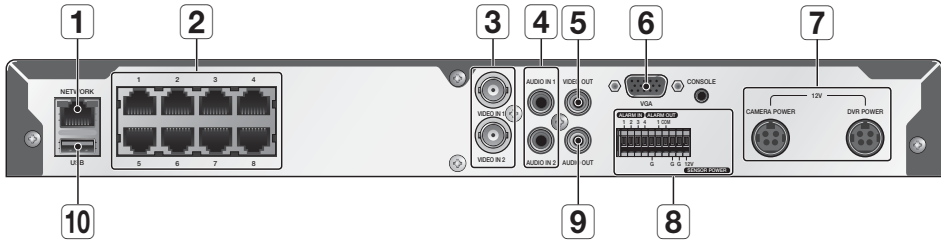

## SDE-5001/5002

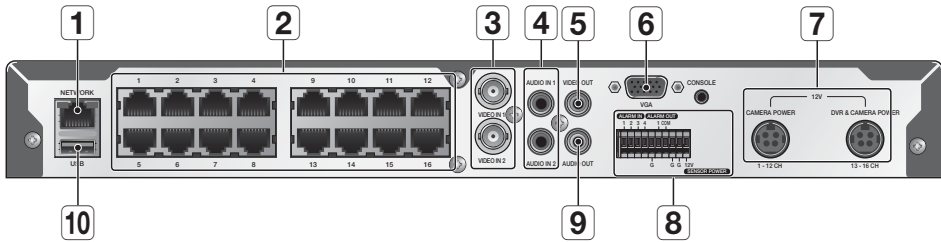

Part Names	Functions
<b>1</b> NETWORK	NETWORK connector port.
<b>2</b> CAMERA IN	Video Signal input ports (UTP type connector).
<b>3</b> VIDEO IN	Composite Video Signal Input Port (BNC type connector).
<b>4</b> AUDIO IN	Audio input signal port (RCA jack).
<b>5</b> VIDEO OUT	Video Signal Output Port (RCA jack).
<b>6</b> VGA	VGA Video Signal Output Port.
<b>7</b> POWER	Camera and DVR power input port.
<b>8</b> ALARM	- ALARM IN 1~4 : Alarm Input port. - ALARM OUT : Alarm Output port. - SENSOR POWER : Sensor Power Output port.
<b>9</b> AUDIO OUT	Audio Signal Output Port (RCA jack).
<b>10</b> USB	USB connector port.

- If you connect UTP camera(SEB-1006R) that support Audio to CH1~CH16, Audio output for CH1~CH16 will be available.
- Do not connect UTP camera and BNC camera simultaneously. (CH1, CH2)
- Use only provided UTP camera.
- If using the VGA cable, the source from VGA will be displayed as main image on the screen along with the OSD menus. Then, the BNC port will output the video signal alone.
- If not using the VGA cable, the source from BNC will be displayed as main image on the screen along with the OSD menus. If you connect the VGA cable after the system boot, only the video signal from VGA will be displayed.
- [CONSOLE] is designed for the service repair purpose only.

## REMOTE CONTROL

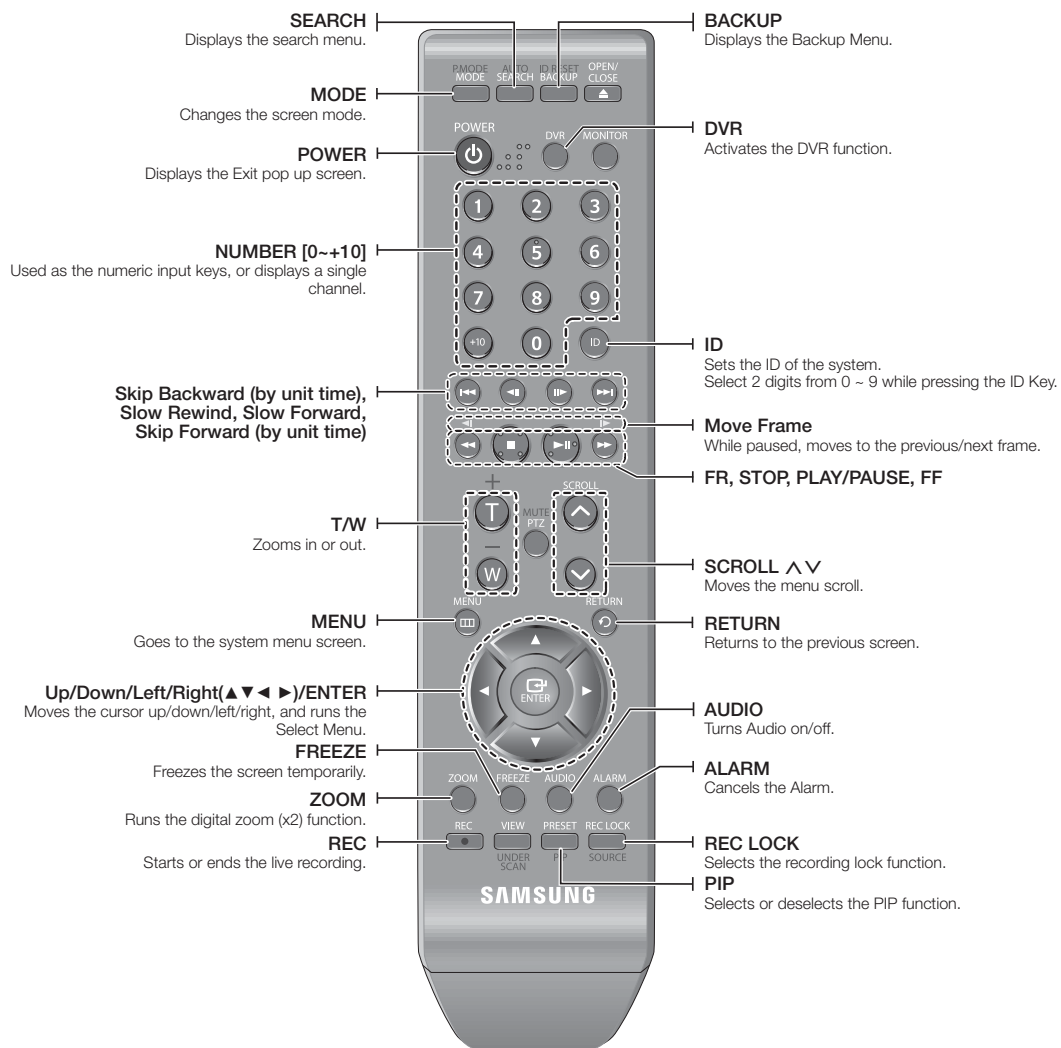

# overview

---

## Using the numeric buttons

---

CHANNEL 1–9	Press each button between 1 to 9. (8CH : 8)
CHANNEL 10	Press the [0/+10] button first, then press the [0/+10] within 1 second.
CHANNEL 11–16	Press the [0/+10] button first, then press any number between 1 to 6.

## Changing the Remote Control ID

---

1. Press the ID button of the remote control and check the ID displayed on the DVR screen.  
The factory default ID of the remote control is 00.
  2. Enter 2 digits of your selection in order, while pressing the system [ID] button.
  3. When ID input is done, press the system [ID] button again to check the setting.
-  ■ If you want to change the remote control ID to 08: Press 0 and 8 in order while the system [ID] button is pressed. Remote control's ID and DVR's ID should be matched for proper operation. Refer to "Remote Devices". (Page 63)

# connecting with other device

## INSTALLATION

Please take note of the followings before using this product.

- Do not use the product outdoor.
- Do not spill water or liquid in the connection part of the product.
- Do not impose the system to excessive shock or force.
- Do not pull out the power plug forcefully.
- Do not disassemble the product on your own.
- Do not exceed the rated input/output range.
- Use a certified power cord only.
- For the product with an input ground, use a grounded power plug.

## CHECKING THE INSTALLATION ENVIRONMENT

Samsung Digital Video Recorder ("DVR" hereinafter) is a state-of-art security device, and contains mass storage hard disk(s) and critical circuits inside.

When the temperature rises inside the product, the product may breakdown and the product life be shortened. Please pay attention to the following recommendations before installation.

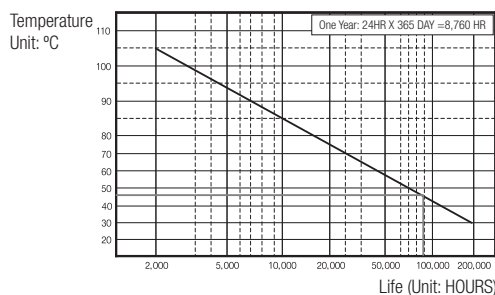

[Figure 1]

The followings are the recommendations when Samsung DVR is installed on a rack.

1. Please ensure that the rack inside is not sealed.
2. Please ensure the air is circulated through the inlet/outlet as shown in the picture.
3. If the DVR or other devices on a rack is to be stacked as in the picture, provide a suitable space or install a ventilating opening for air circulation.
4. For natural air convection, place the inlet at the bottom of the rack and the outlet on top.
5. It is strongly recommended that a fan motor is installed at the inlet and the outlet for air circulation. (Please fit a filter at the inlet to screen dust or foreign substances.)
6. Please maintain the temperature inside the rack or surrounding areas between 0°C ~ 40°C (32°F ~ 104°F) as shown in the figure 1.

Rack Mount Instructions - The following or similar rack-mount instructions are included with the installation instructions :

- A) Elevated Operating Ambient - If installed in a closed or multi-unit rack assembly, the operating ambient temperature of the rack environment may be greater than room ambient. Therefore, consideration should be given to installing the equipment in an environment compatible with the maximum ambient temperature specified by the manufacturer.
- B) Reduced Air Flow - Installation of the equipment in a rack should be such that the amount of air flow required for safe operation of the equipment is not compromised.
- C) Mechanical Loading - Mounting of the equipment in the rack should be such that a hazardous condition is not achieved due to uneven mechanical loading.
- D) Circuit Overloading - Consideration should be given to the connection of the equipment to the supply circuit and the effect that overloading of the circuits might have on overcurrent protection and supply wiring. Appropriate consideration of equipment nameplate ratings should be used when addressing this concern.
- E) Reliable Earthing - Reliable earthing of rack-mounted equipment should be maintained. Particular attention should be given to supply connections other than direct connections to the branch circuit (e.g. use of power strips).

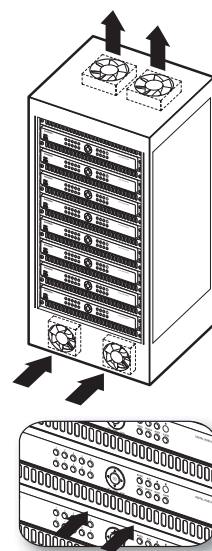

[Figure 2]

# connecting with other device

## CONNECTING THE VIDEO, AUDIO AND MONITOR

SDE-4001/4002/4004/4005/5001/5002

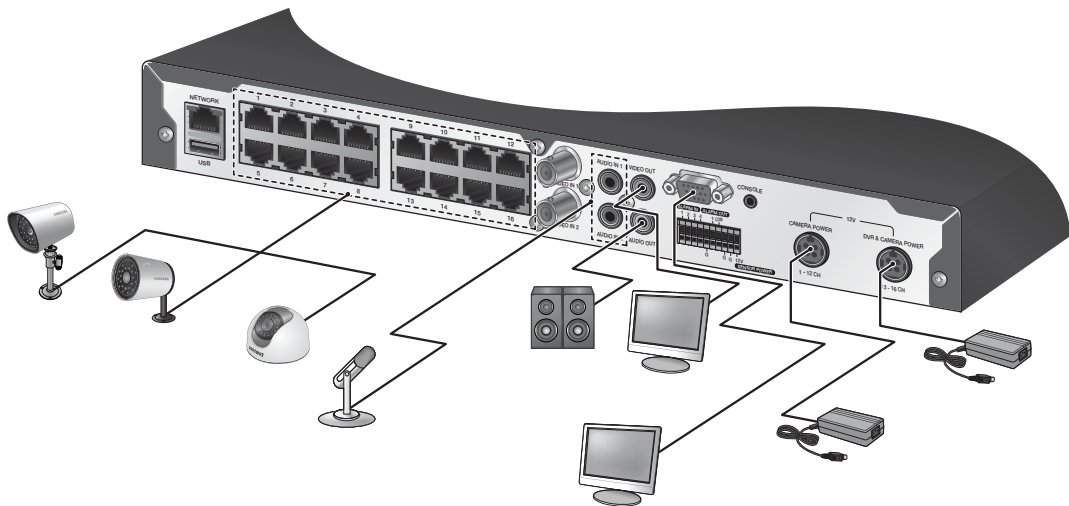

- Do not connect UTP camera and BNC camera simultaneously. (CH1, CH2)

SDE-4003/5003

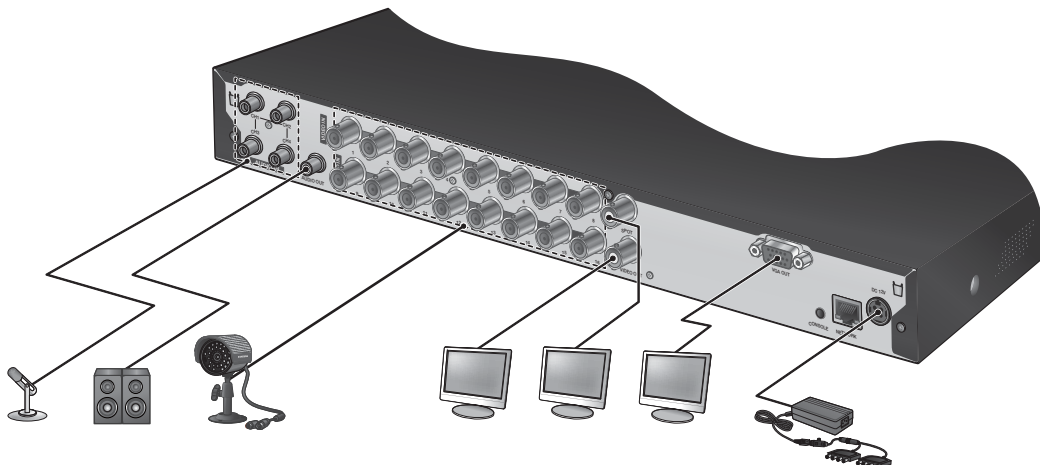



## CONNECTING THE USB

1. By factory default, a USB port is provided for external connection.
2. You can connect a USB HDD, USB memory or mouse to the USB port.
3. If a USB HDD is connected to the system, recognition and settings are available in **"Main Menu > Setting the Device > Storage Device"**. (Page 61)
4. This product supports hot-plugging, which connects/removes the USB device during the system operation.

**!** If you use the USB device for Backup purposes, format it with FAT32 on PC if it is not formatted on the DVR.

## CONNECTING THE CAMERA (SED-1001R, SEB-1005R, SEB-1007R)

Equipped with the IR LED and the illumination sensor, enables you to monitor at night as well as in daytime. The camera is suitable for both internal and external use.

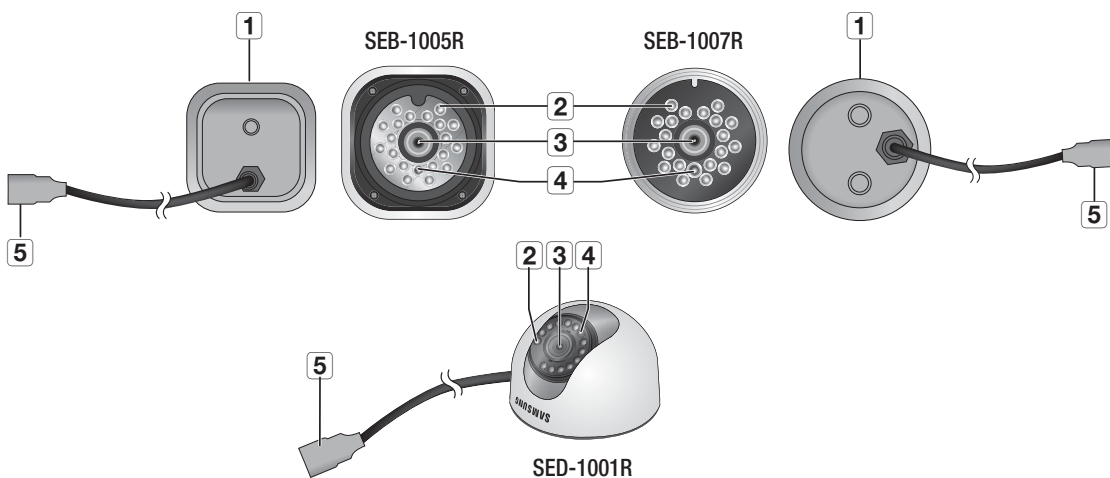

Name	Description
<b>1</b> Camera Fitting Groove	Groove that is used to fit the camera bracket. There are two grooves; one on the top and one on the bottom.
<b>2</b> IR LED	These infrared LED's are controlled by the illumination sensor.
<b>3</b> Lens	Focal length of 3.6mm enables you to cover relatively longer range of monitoring.
<b>4</b> Illumination Sensor	Detects incoming light to control the IR LED.
<b>5</b> DVR Connection Cable	Connect the cable directly to the DVR without using a particular power cable. You can use the RJ-45 cable to connect to a remote camera.

# connecting with other device

## RJ-45 Cable (Length: 18.3m, 60ft)

This cable is specific to UTP connection, which is not compliant with the LAN cable. You can use the UTP direct cable (all of 8 pins are used) to extend the length to a max of 200m. (based on UTP CAT 5e)

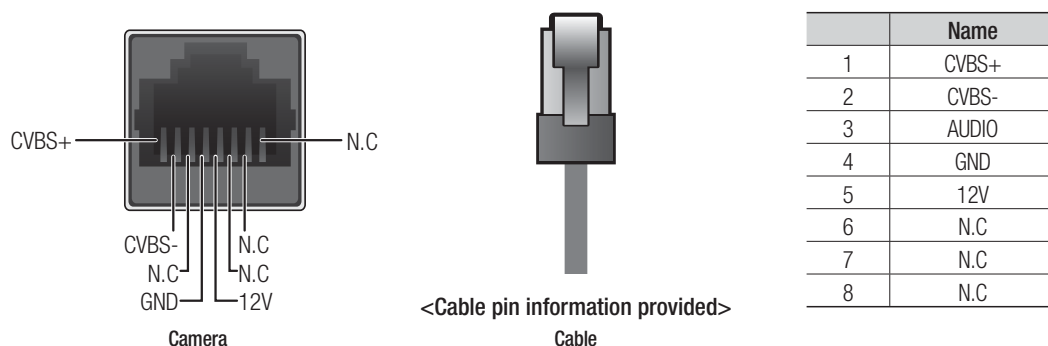

## CONNECTING THE CAMERA (SEB-1020R)

Equipped with the IR LED and the illumination sensor, enables you to monitor at night as well as in daytime. The camera is suitable for both internal and external use.

- Please make sure not to fully expose the camera to rain. The camera must be installed under a shelter to avoid exposure to excessive rain or moisture.

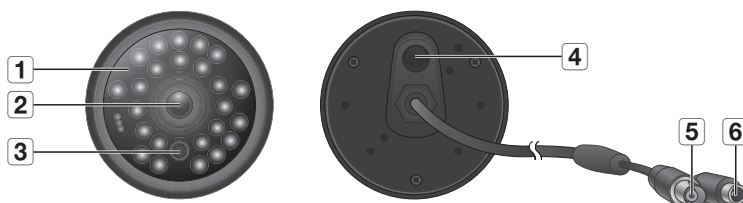

Name	Description
<b>1</b> IR LED	These infrared LED's are controlled by the illumination sensor.
<b>2</b> Lens	Focal length of 3.6mm enables you to cover relatively longer range of monitoring.
<b>3</b> Illumination Sensor	Detects incoming light to control the IR LED.
<b>4</b> Camera Fitting Groove	Groove that is used to fit the camera bracket. There are two grooves; one on the top and one on the bottom.
<b>5</b> BNC Cable	BNC terminal for video signal output.
<b>6</b> Power Cable	Used to plug the power cable.

## Connecting with DVR

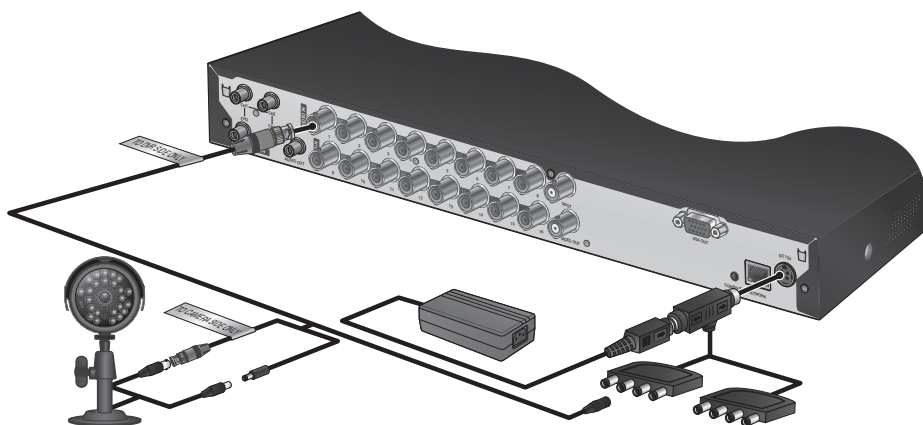

## Installing the camera

The camera can be installed on the wall, ceiling, shelf or a desired position using the provided bracket.

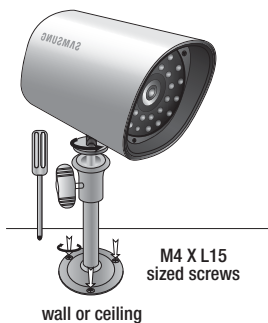

SEB-1005R

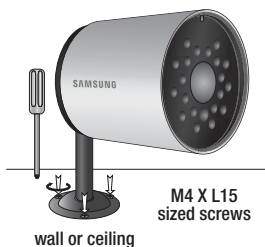

SEB-1007R



SEB-1020R

1. Select a position where you want to install the camera.
    - Make sure the selected position can sustain the weight of the camera.
  2. Use the screw bolts to mount the camera bracket onto the wall or ceiling.
  3. Place the camera on the selected position and fit the hole either on the top or the bottom of the camera into the fixing bolt of the bracket, and turn the camera clockwise.
- !** You should be careful when installing the BOX camera outdoors because the cable connectors may be wet with moisture or pile up with impurities.
- The camera satisfies the IP66 standard, and direct exposure to water or moisture may cause problem such as condensation.

# connecting with other device

## Camera Bracket

The camera bracket can be used to install the camera on the wall, ceiling or shelf.

### Camera Bracket Specification

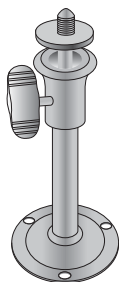

SEB-1005R

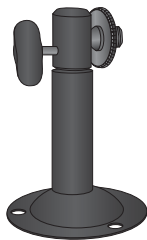

SEB-1007R



SEB-1020R

Name	Description		
	SEB-1005R	SEB-1007R	SEB-1020R
Use	Indoor		Indoor/Outdoor
Installation	Wall or Ceiling		
Dimensions	W57 X H47.2 X L100.5 mm (W2.25 X H1.86 X L3.95 inch)	W40 X H58 X D40 mm (W1.57 X H2.28 X D1.57 inch)	Ø60 X H72 mm (Ø2.36 X H2.83 inch)
Weight	130g(0.29 lbs)	55g (0.12 lbs)	85g (0.19 lbs)
Operating Temperature	-10°C ~ 50°C (14°F ~ 122°F)		
Accessories	SCREW (M4 X L15) : 3 pcs		SCREW (M3.5 X L25): 3 pcs for each bracket

## Adjusting the Camera Bracket

1. Choose an installation site that can sufficiently support the weight of the equipments to be installed.
2. Attach the camera bracket to the wall using the supplied screws.
  - SEB-1020R : (M3.5 X L25). 3.5 X 25
  - SEB-1005R/1007R : (M4 x L15). 4x15

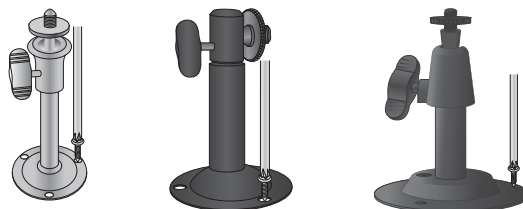

3. Adjust the camera to target the video location and tighten the camera bracket handle on the camera bracket. Install the camera on to the male screw of the camera bracket by rotating the camera clockwise.



4. Loosen the handle by turning it counter clockwise and then adjust the camera position. Tighten the handle, turning it clockwise to lock the camera in position.
5. Connect the camera cable to the camera.



# connecting with other device

## Installing the camera (SED-1001R)

### Precautions before installation

Ensure you read the following instructions before installing the camera:

- Select an installation site (ceiling or wall) that can endure at least 5 times of the camera weight.
- Stuck-in or peeled-off cables can cause damage to the product or a fire.

1. Hold down the bottom lock lever while removing the cover with the other hand.

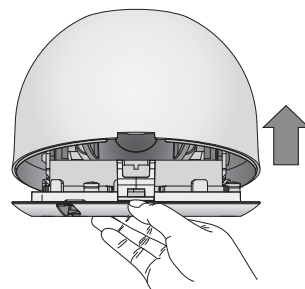

2. Press and hold the lock key outward (in the arrow direction) and turn the bracket counter clockwise to remove it.

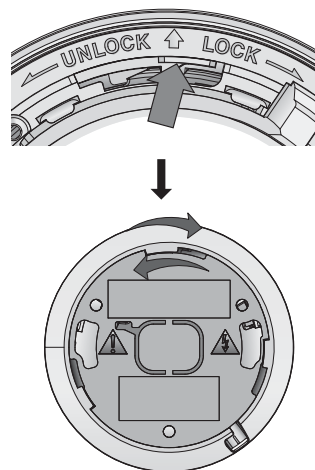

3. Use the provided screws (x3) to fix the bracket to a desired position (ceiling or wall).
  - Ensure that the <b>CAMERA FRONT</b> label on the bracket faces the direction for camera monitoring.

4. Arrange the cables through the bracket to the ceiling or wall. If you intend to drill a hole in the installation site for the wiring purpose, remove the wiring cover to reveal a hole. Arrange the cables through the hole. If you intend to arrange the cables without drilling a hole, use the empty area opposite to the <b>CAMERA FRONT</b> label side for the wiring purpose.

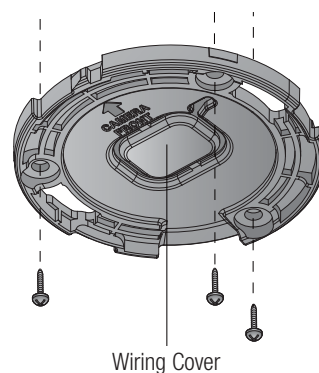

5. Mount the main unit onto the bracket.  
Align the marking hole of the main unit with the <CAMERA FRONT> label of the bracket, and turn the unit in the <LOCK> direction.
6. Adjust the lens in a desired direction.  
For adjusting the lens direction, refer to “Adjusting the monitoring direction for the camera”.

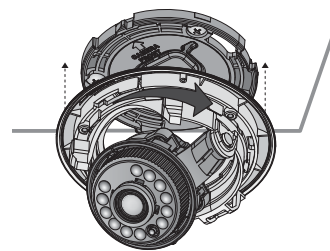

7. Fix the cover to the main unit.  
Align the lock key of the main unit with the latch of the cover.  
Press down the cover until you hear a click.

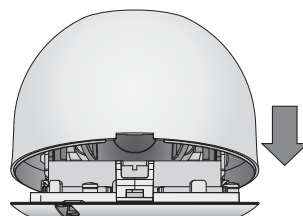

### Adjusting the monitoring direction for the camera

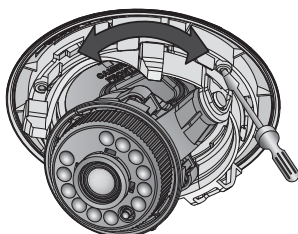

Panning

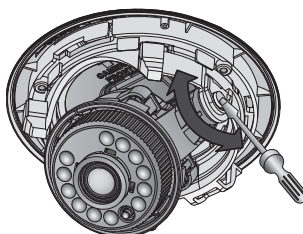

Tilting

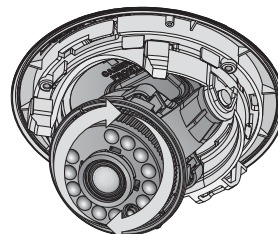

Lens rotation

You can adjust the camera direction only when the camera is fixed on the ceiling.

Then, turning the camera to the left or right is referred to as “Panning”, while tilting the angle is “Tilting”.

- If you want to adjust the panning direction, loosen the bottom screw and turn the camera to a desired direction. Then, tighten the screw back.  
If you couldn't tighten the screw for positioning reasons, select a different screw hole and try again.
- The tilting is available between 0° and 60°. When you finish adjusting the tilt, tighten the tilt adjustable screw if you want to fix the angle.
- If you install the camera vertically on a slanting ceiling or wall, the video from the camera may not be displayed properly. If this is the case, adjust the lens direction to correct the display of the video.

# connecting with other device

## CONNECTING THE ALARM INPUT/OUTPUT

- SDE-4003 and SDE-5003 Model don't support the function of "ALARM IN" and "ALARM OUT".

### Connecting the alarm Input signal

Connection port for the alarm input signal.  
Connect one strand of the sensor signal line (two strands) to the alarm input port and connect the other to the [G] port.

### Connecting the alarm output signal

Connection port for the alarm output signal.  
Connect one strand of the sensor signal line (two strands) to the alarm output port and connect the other to the [COM] port.

- ALARM IN : 5mA sink
- ALARM OUT : 30VDC 2A, 125VAC 0.5A MAX

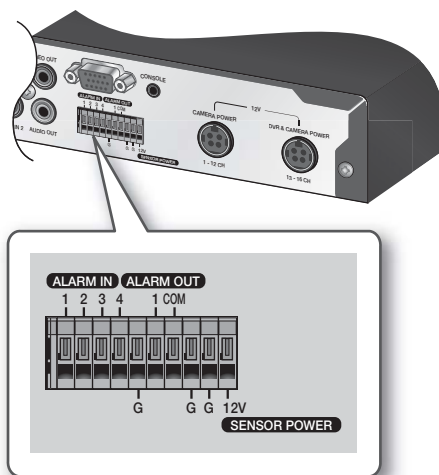

## CONNECTING THE NETWORK

- The following figures are based on Model SDE-5001.

### Connecting to network through Ethernet (10/100BaseT)

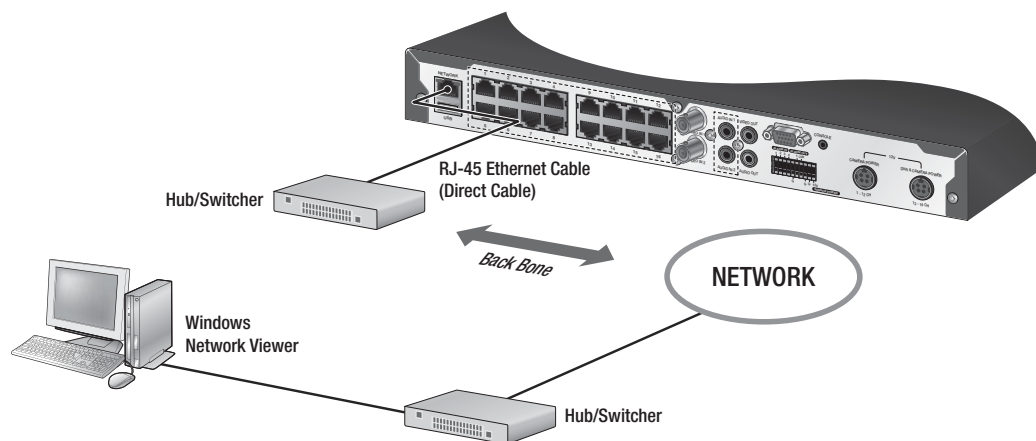



## Connecting to the Network using the router

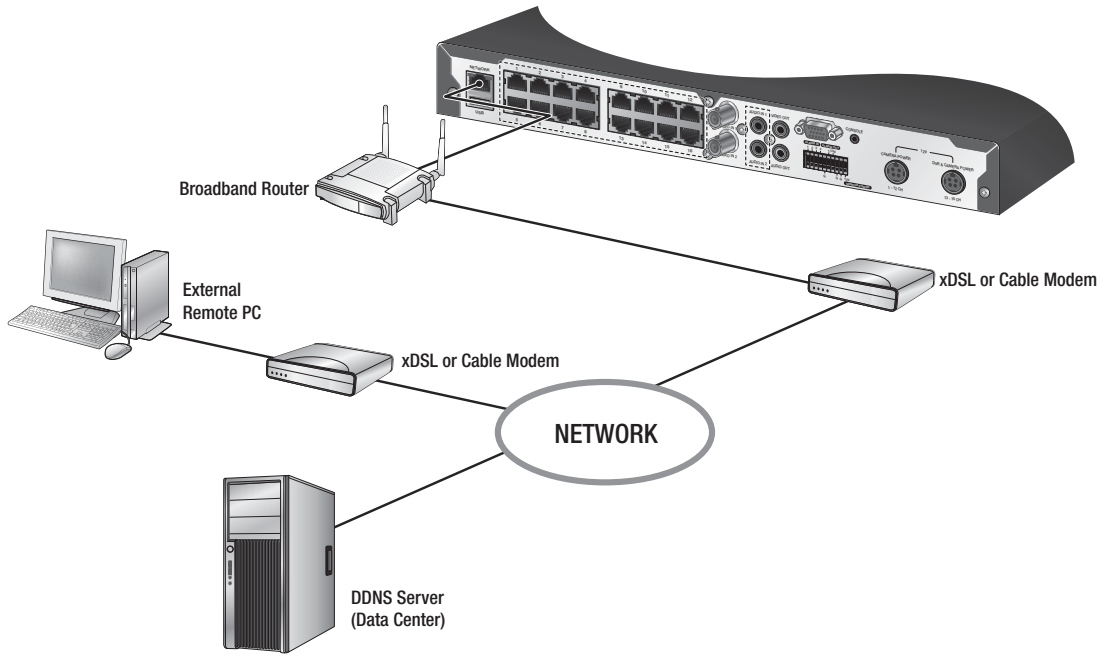

## Connecting to Network through ADSL

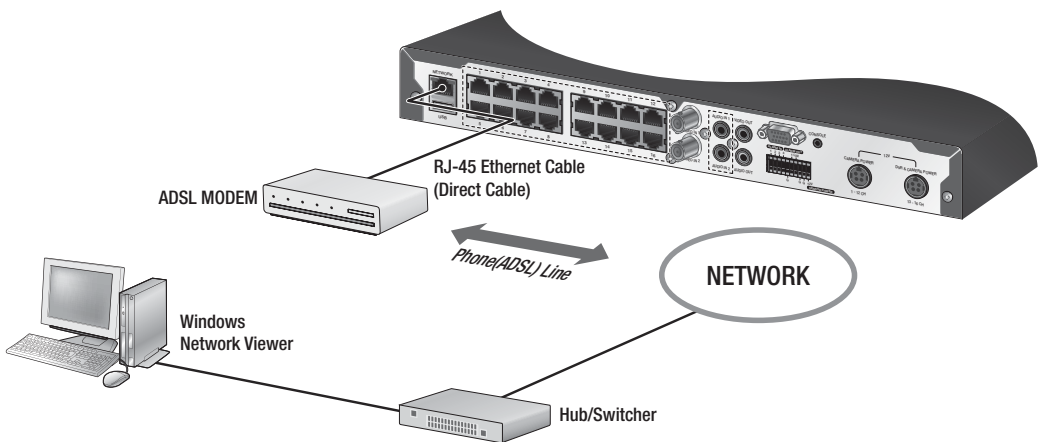

## GETTING STARTED

### Starting the system

1. Connect the power cable of the DVR to the wall outlet.



- It takes about 10 seconds to display the start screen after booting.

2. You will see the initialization screen.  
The initialization process will last about 1 minute.  
If a new HDD is installed, the initialization process may take longer.



3. The live screen appears with a beep.



### Shutting Down the System

You can shut down the system only if you have logged in to the DVR.  
You require permission to shut down the system if you are not logged in as admin.

1. Press the **[POWER]** button on the remote control or the front panel, or right-click to display the context sensitive menu and select **<Shutdown>**.
2. The **"Shutdown"** confirmation window appears.
3. Use the arrow keys on the remote control or the front panel to move to **<OK>** and press the **[ENTER]** button or click **<OK>**. The system will shut down.
4. Press the **[POWER]** button again to restart.



- For the permission management, refer to **"Permission Management > Setting Permissions"**. (Page 54)

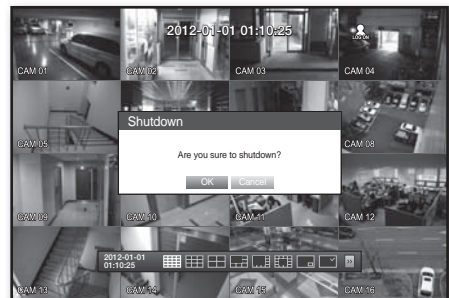

## Login

To access a DVR or restricted menu, you should have logged in to the DVR.

- In live mode, right-click any area of the screen. You will see the context sensitive menu as in the right figure.



- Click <Login>.

The login dialog appears.

You can also see the login dialog to access a desired menu by pressing the [MENU] button on the remote control or the front panel.

- The login dialog will also appear if you press a menu button on the remote control or the front panel of the DVR when the corresponding menu requires logging in.
- After logged in, press [RETURN] on the remote control to display the logout dialog.
- By default, initial ID and password are set to "admin", and "4321".



- The default password can be exposed to a hacking thread so it is recommended to change the password after installing the product.  
Note that the security and other related issues caused by the unchanged password shall be responsible for the user.



- For the restricted permission, refer to "Permission Management > Setting Permissions". (Page 54)

## Locking All Buttons

This will restrict access to all buttons available in the DVR.

- In Live mode, press buttons on the remote control in the order of [STOP (■)]→[FREEZE]→[STOP (■)]→[FREEZE]→[MENU]. All buttons will be locked.
- In the lock condition, press any button to display a dialog where you are prompted to enter the password for unlocking the buttons. The button lock will be released if you enter the admin password.



## LIVE SCREEN CONFIGURATION

### Icons on the Live Screen

You can check the status or operation of the DVR with the icons on the live screen.

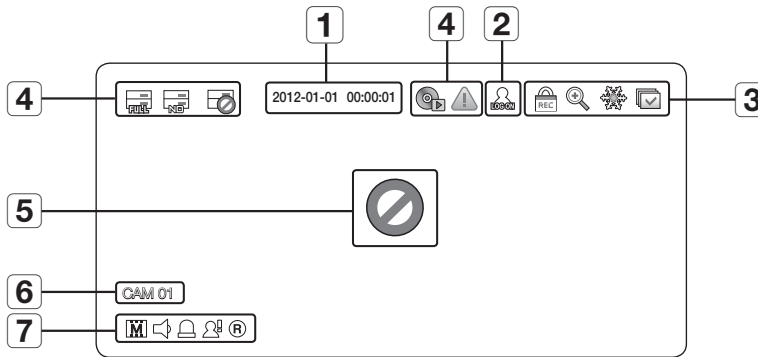

Name		Description
1	Current Date, Time	Displays the current time and date.
2	Login Information	When you are logged in, the "LOG ON" icon will be displayed.
3	Screen Mode	Displayed if the zoom function is activated.
		Freezes the screen temporarily.
		Displayed in Auto Sequence mode where all channels are switched at the specific time interval.
		This icon is displayed if a user with restricted access to the Record button tries to make manual recording. <ul style="list-style-type: none"> <li>Only the user with the applicable permission can release (stop) the recording.</li> </ul>
4	System Operation	Displayed if the HDD is full and the DVR has an insufficient space to record.
		Displayed if no HDD is installed or the existing HDD should be replaced.
		Displayed if the HDD needs a technical examination.
		This will be displayed if the backup operation is in process.
		Displayed if a new firmware is found from the network.
5	Video Input Status	Displayed if no input is entered in the condition that the camera is set to <ON>.
		Nothing will be displayed on the screen if the camera is set to <OFF>.

Name		Description
6	Camera Name/ Channel	Displays the camera name and the changed channel, if any.
7	Camera Operation	/  /  Displays the resolution of the recording screen. (Page 68)
		/  Displays AUDIO ON/MUTE. Not displayed in video mode if deactivated.
		If the sensor is set to <ON>, the input signal will be displayed on the screen of the connected channel. <ul style="list-style-type: none"> <li>SDE-4003 and SDE-5003 Model don't support the function of "ALARM IN" and "ALARM OUT".</li> </ul>
		Displayed if a motion detected in the condition that the motion detection is set to <ON>.
		/  /  Displays the current record mode from Record/Event/Schedule.

## Error Information

- If the internal HDD is not connected, the "NO HDD" () message will appear; if there occurs a problem, you will see the "HDD FAIL" () message in the top left corner. In this case, make sure you contact the service center for assistance as this may cause a failure of recording, playback or backup.



- If you see NO HDD, HDD FAIL icons on the screen, contact the service center for more details.

## Live Screen Menu

In addition to the buttons on the front panel or the remote control, you can access a desired menu by right-clicking the mouse any area in live mode.

The context sensitive menu that appears by right-clicking the screen may differ, depending on the login/logout, screen split mode and DVR operation mode.



- Menu items of Search, Record, Backup and Shutdown can be deactivated, depending on the user permission.



< Split Mode Menu >

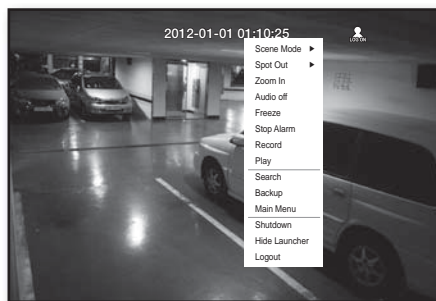

< Single Mode Menu >

## Split Mode Menu

The context sensitive menu in split mode differs, depending on the login/logout status.

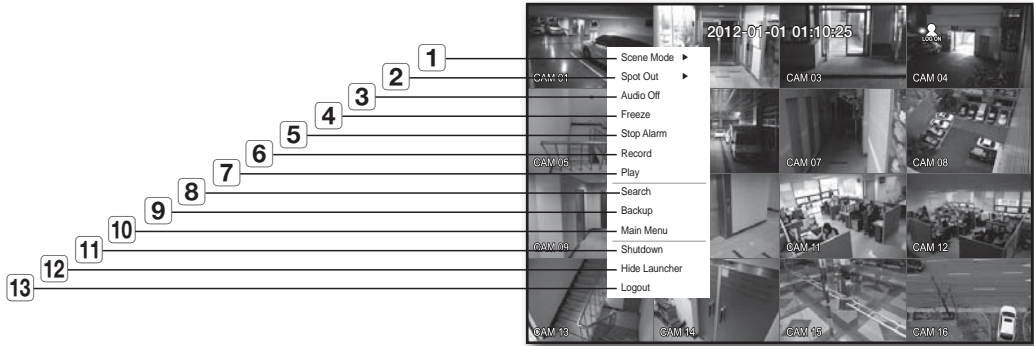

Menu		Description
1	Scene Mode	Refer to <b>"Live Mode"</b> . (Page 41)
2	Spot Out	Refer to <b>"Spot Out"</b> . (Page 44)
3	Audio On/Off	Refer to <b>"Audio On/Off"</b> . (Page 45)
4	Freeze	Refer to <b>"Freeze"</b> . (Page 45)
5	Stop Alarm	Stops the alarm output and the event monitoring. Refer to <b>"Event Monitoring"</b> . (Page 46)
6	Record/Stop	Starts/stops the standard recording.
7	Play	Plays the search result (data). Refer to <b>"Search &amp; Play &gt; Play"</b> . (Page 92)
8	Search	Refer to <b>"Search &amp; Play &gt; Search"</b> . (Page 89)
9	Backup	Refer to <b>"Main Menu &gt; Setting the Backup"</b> . (Page 74)
10	Main Menu	Accesses the main menu. Refer to the Using the DVR section. (Page 47)
11	Shutdown	Turns down the DVR.
12	Show/Hide Launcher	Shows or hides the launcher. Refer to <b>"View the Launcher Menu"</b> . (Page 40)
13	Login/Logout	You can log in or out.

## Single Mode Menu

The single mode menu is available only in Single Mode.

The context sensitive menu for the One Channel mode, in Split mode is different from that of the Single mode.



Menu	Description
<b>1</b> Full Screen	Select and click a desired channel in Split mode to switch to the full screen of the selected channel.
<b>2</b> Zoom In	Enlarges the selected image. (Page 44)

## View the Launcher Menu

The Launcher menu appears on the bottom of the live screen.

1. In Live mode, right-click to display the context menu and select <Show Launcher>.
2. Move the cursor to the bottom and click a desired item in the Launcher menu.

- 
  - If no input is entered for 10 seconds, the menu will disappear.
  - The Launcher menu can be accessed only by using the mouse.
  - SDE-400X do not support the 16-split screen mode.



Menu	Description
<b>1</b> Date/Time	Displays the current time and date. The indication of AM/PM is displayed if you set 12 hours for the time format in "System > Date/Time/Language > Time". (Page 47)
<b>2</b> Screen Mode	Press this button to switch the screen mode in sequence. The current mode is highlighted in white.
<b>3</b> Menu Expansion Button	Click to display the hidden menu to the right.
<b>4</b> Audio	Turns ON/OFF the sound of the selected channel.
<b>5</b> Zoom	Enlarges the selected area. This is available only in Single Live mode.
<b>6</b> Alarm	Stops the alarm if it's activated.
<b>7</b> Freeze	Freezes the Live screen temporarily.
<b>8</b> Play	Enters Play mode if a file to play exist, and if not, enters Search mode.
<b>9</b> Record	Start/End recording the Live screen.



## LIVE MODE

SDE-500X display Live images from 16 channels in a total of 8 layout of split screens.

### Switching the screen mode

To switch the split mode, select a screen mode in the launcher menu, or right-click to select a screen mode in the context menu.

Press the **[MODE]** button on the front panel or the remote control to switch the mode in the sequence of the launcher menu items.

 ■ SDE-400X do not support the 16-split screen mode.

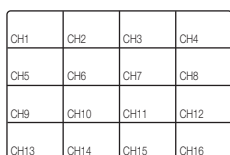

16-split mode

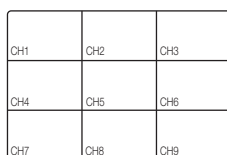

9-split mode

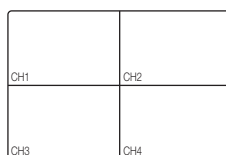

4-split mode

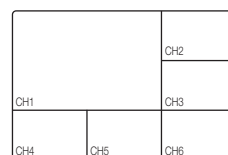

6-split mode

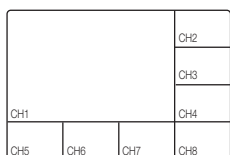

8-split mode

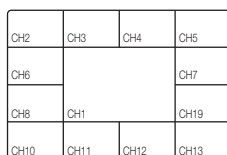

13-split mode

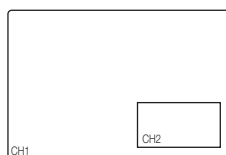

PIP

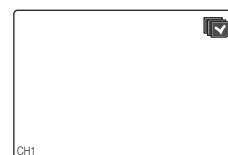



Auto Sequence

### Switching the split mode

SDE-500X display 16 Live images in the sequence of Single, 4-split and 9-split modes.

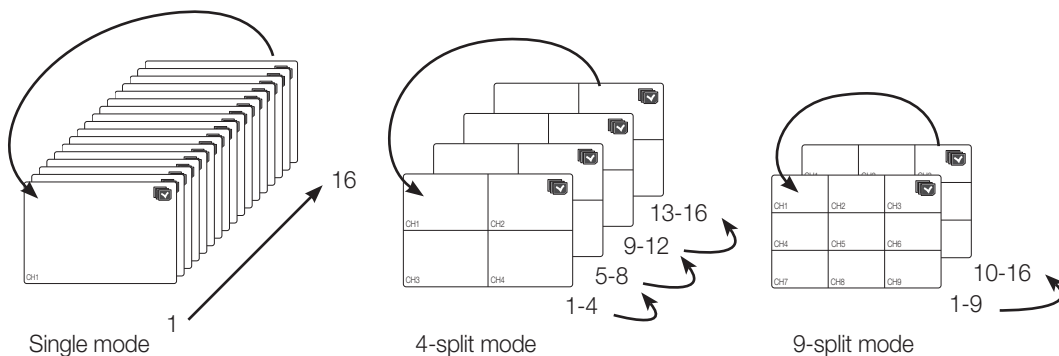
#### Auto Sequence



- 
 In Single mode, If you have set <SEQ-Dwell Time> in "Setting the Device > Camera", Auto Sequence will be conducted at the set interval. (Page 59)
- In a split mode, If you have set <Multi CH SEQ Time> in "Setting the Device > Monitor", Auto Sequence will be conducted at the set interval. (Page 64)

## Manual Switching

Press the left/right button on the front panel or the remote control, or click the arrow <◀/▶> key to move to the next split mode.

- If pressing the right [▶] button in 9-split mode :  
 9-split (CH 1~9) mode → 9-split (CH 10~16) mode → Auto Sequence

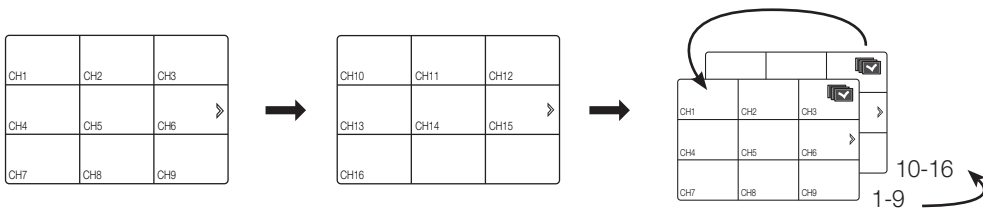

- If pressing the right [▶] button in 4-split mode :  
 Channel (CH 1~4) → Channel (CH 5~8) → Channel (CH 9~12) → Channel (CH 13~16) → Auto Sequence

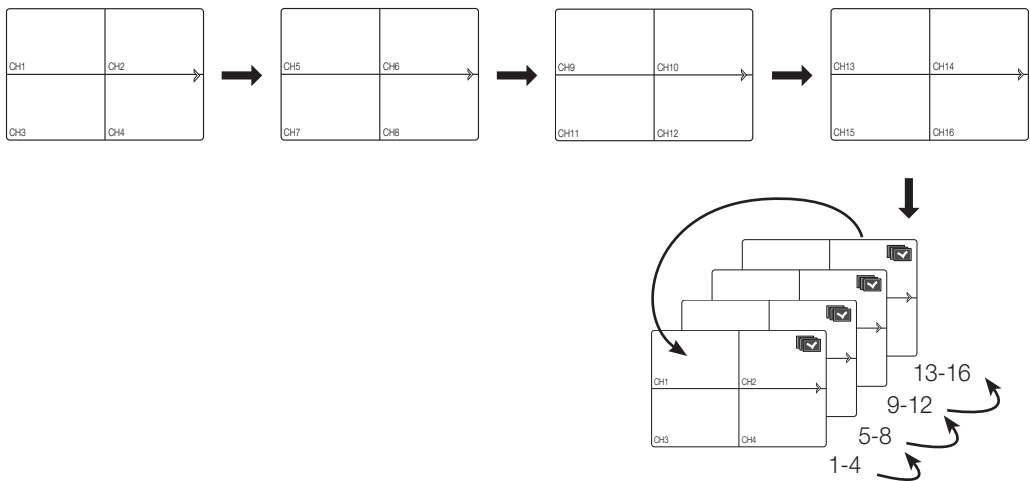

## Channel Setting

You can display the channel in a desired area of a split screen.

1. Place the cursor over the camera name of each channel to display the <▼> key to the right on the screen.
2. Click a camera name to display a channel list where you can select a different channel.
3. Select a desired channel and click it.

The current channel will be switched to the selected one.

Use the cursor to select a channel to move, and drag and drop it to a desired channel; this can also change the channel position.

- Ex : if switching CH 1 to CH 7

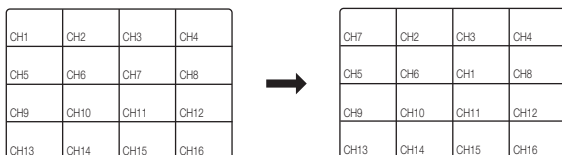

## Switching to Single Mode

When in split mode, select and double-click a desired channel to switch to its Single mode.

Press the number corresponding to a desired channel on the front panel or the remote control to switch to its Single mode.

- CHANNEL 1–9 : Press each button between 1 to 9. (8CH : 8)
- CHANNEL 10 : Press the [0/+10] button.
- CHANNEL 11–16 : Press the [0/+10] button first, then press any number between 1 to 6 within 1 second.

Refer to “**Remote Control > Using the numeric buttons**”. (Page 22)

- Ex : If double-clicking CH 3 or pressing the number “3” on the remote control or the front panel.

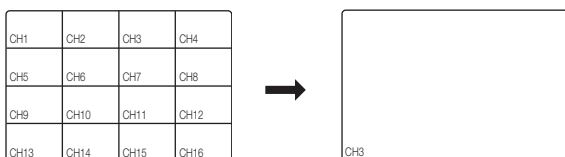

## SPOT OUT

The Spot Out monitoring is independent of the Live mode, which monitors a specific channel through the Spot Out port.

### Selecting a Spot Out mode

If an event occurs such as sensor, motion or alarm from the Spot Out port in connection with a monitor, you can select a output screen mode.

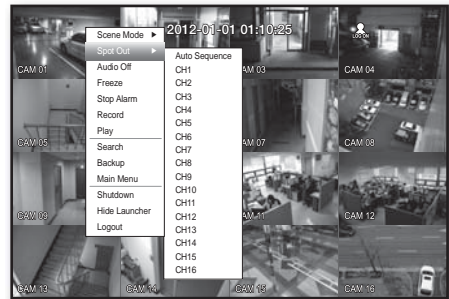

1. In Live mode, right-click any area on the screen.  
The Live menu appears.
2. Click Spot Out.  
Supports the Spot output in Single screen with Auto Sequence mode.
  - The Spot output is supported only for a designated channel.  
For the Spot Out port of a model, refer to “**Part Names and Functions (Rear)**”. (Page 19)



< Multichannel Live Menu >

## ZOOM

This is available only in Single Live mode. In Single mode, select a desired area and use the Zoom function to enlarge it twice.

1. Select <Zoom In> in the right-click menu.  
Press the [ZOOM] button on the remote control, or simply click <  > in the launcher menu. The zoom box appears.
2. Use the direction keys, or drag and drop to specify an area to enlarge.
3. Press the [ENTER] button, or double-click the selected area to enlarge it twice.
  - In the enlarged image, use the direction buttons (▲▼◀▶) on the remote control or the front panel to move the enlarged area.
4. Press the [ZOOM] button on the remote control, or simply click <  > in the launcher menu to release the zoom.

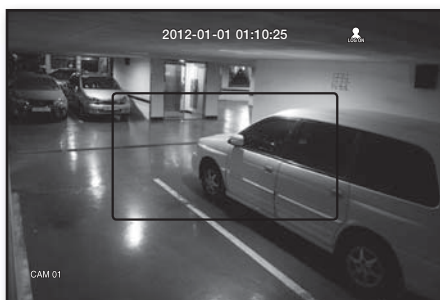

## AUDIO ON/OFF

---

You can turn the sound on/off corresponding to the channel in Live mode.

### AUDIO On/Off in Single mode

Click the audio icon (  ) on the screen, or press the [AUDIO] button on the remote control to turn it on/off.





- Only the channel where <Audio> is set to <ON> in "Device > Camera" displays the audio icon (  ) in Live mode that you can use to turn the sound on/off.

## FREEZE

---

This is available only in Live mode, this pauses playing the Live image temporarily.

1. Press the [FREEZE] button on the remote control, or click <  > in the launcher menu.  
The playback of the image is stopped temporarily.
2. Press the [FREEZE] button again, or click <  >.  
This will release the freeze.

## EVENT MONITORING

This will display the channel in sync with a specific event (Sensor/Motion/Video Loss) if it occurs.

In “**Monitor > Event Display**”, set the event monitoring to ON/OFF and specify the event display time. (Page 64)

- SDE-4003 and SDE-5003 Model don't support the function of Sensor detection.
- If multiple events occur simultaneously, the screen will switch to a split mode.
  - 2~4 events : 4-split mode
  - 5~9 events : 9-split mode
  - 10~16 events : 16-split mode
- If the second event occurs within the set time of <Event Display>, the first event will last until the second one is terminated. (Page 64)
  - Ex : If you set <Event Display> to 5 seconds, and only one event occurs in CH 1.

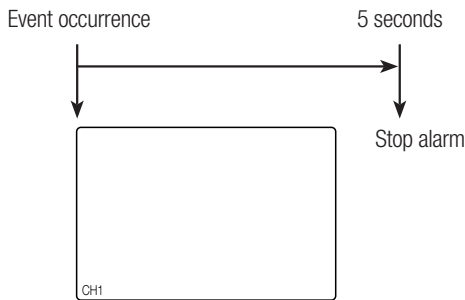

- Ex : If you set <Event Display> to 5 seconds, and the second event occurs in CH 2 within the set time after the first event occurred in CH 1.

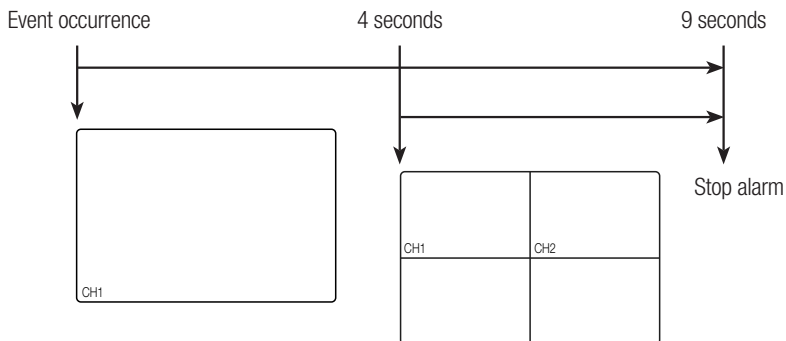

- Press the [ALARM] button to reset the alarm settings and to release the event mode.
- If an alarm activates in the condition you have set the event record, and pre/post alarm times, the event record will be performed.

# main menu

You can setup the system properties, devices, and options for recording, event, backup and network.

## SYSTEM SETUP

You can setup Date/Time/Language, Permission, System Properties and Log.

### Date/Time/Language

You can check and setup the current Date/Time and time related properties, as well as the language used for the interface on the screen.

### Setting the Date/Time/Language

Set the Date/Time/Language

Using the mouse may help make setup easier.

1. Press the [MENU] button on the remote control or on the front panel.
  - If not logged in, it prompts with login window. Refer to "Login". (Page 35)



2. Use the left/right buttons (◀ ▶) to select the <System>. System property setup menu is selected.
3. Use the up/down buttons (▲ ▼) to select <Date/Time/Language> and press the [ENTER] button.
4. Select <Date/Time/Language>. A dialog to setup Date, Time and Language.
5. Use direction buttons (▲ ▼ ◀ ▶) to select an item to set and make your changes.

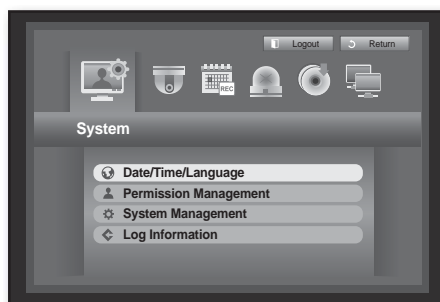

# main menu

- **Date** : Sets the date that will appear on the screen.  
You can select the date format.
- **Time** : Sets the time and its format that will appear on the screen.  
Select either one from **<24 Hours, 12 Hours (AM/PM)>**.
- **Time Zone** : Sets the time zone of your area based on the Greenwich Mean Time (GMT).
  - GMT (Greenwich Mean Time) is standard World Time and the basis of world time zone.
- **Time Sync.** : You can set the DVR's current time synchronized to a selected **<Time Server>** regularly if you select to use **<Time Server>**.  
In this case, **<Date/Time/Language>** setup does not allow time adjustment.

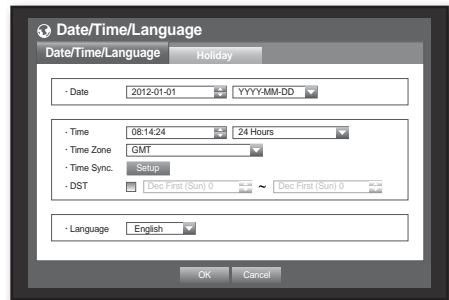

- **Time Server** : Enter an IP or URL address of the time server.
- **Last Sync Time** : Displays the most recent synchronization time from the selected time server.
- **Activate as Server** : Set to **<Use>** to allow the DVR to act as a Time Server for other DVRs.

- **DST** : Set up Daylight Saving Time with its period to make the time earlier than the GMT of its time zone by 1 hour during the set period.
- **Language** : Select your language. Sets the language for the interface.  
English, French, German, Spanish, Italian, Chinese, Russian, Korean, Polish, Japanese, Dutch, Portuguese, Turkish, Czech, Danish, Swedish, Thai, Romanian, Serbian, Croatian, Hungarian and Greek are available.

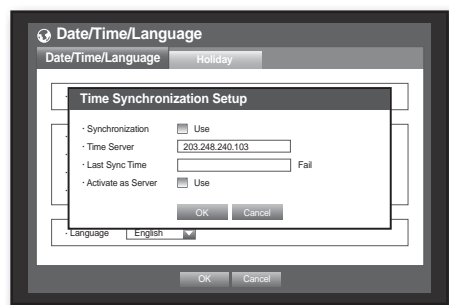

6. When the Date/Time/Language setup is done, press **<OK>**.



- You can also use numeric buttons on the remote control or front panel to enter values for Date, Time and other numeric fields.



## Setting Holiday

You can set specific dates to Holidays according to your preferences. Holidays are applied to <Recording Schedule> and <Alarm Schedule> too.

Using the mouse may help make setup easier.

1. Use the up/down buttons (▲▼) in <Date/Time/Language> window to select <Date/Time/Language>, and press the [ENTER] button.
2. Select <Holiday>.  
A calendar for Holiday setup appears.
3. Use the left/right <◀ ▶> buttons to select year or month, and press the [ENTER] button.

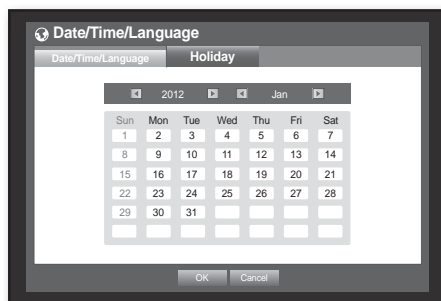

4. Use direction buttons (▲▼◀▶) to select a desired date, and press the [ENTER] button.  
You will see the "Setting Holiday" screen.
  - Ex : Select January 9th and check on <1/9> only to make every January 9th a holiday. Check both on <1/9> and <Jan 2nd Mon> to make every January 9th and 2nd Monday of January holidays.
5. When the Holiday setup is done, press <OK>.

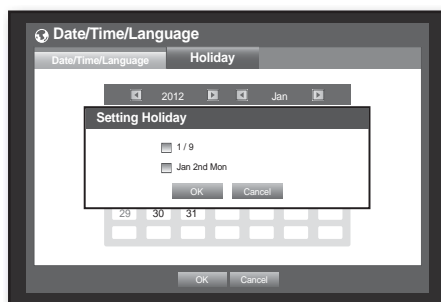

### Using the Calendar

Using the mouse may help make setup easier.

- ① Select year and month.  
Select the left/right <◀ ▶> key on the left/right side of year/month and press [ENTER] button to adjust by 1 year/month.
- ② Use direction buttons to select a date and press [ENTER] button.
  - A date with recorded data to be searched will appear in yellow in the System Log, Event Log, Time Search and Event Search.

# main menu

## Permission Management

You can set permissions of each user over the DVR's specific function and settings.

### Setting the Administrator

You can set and change Administrator's ID and password.  
The administrator can use and set all menu items and functions.

Using the mouse may help make setup easier.

1. Use the up/down buttons (▲▼) in <System> window to move to <Permission Management>, and press [ENTER] button.
2. Select <Admin>.  
A dialog for Admin ID and Password input appears.
3. Use direction buttons (▲▼◀▶) to move to a desired item, and set the ID and password.



- By default, initial ID and password are set to "admin", and "4321".
- The default password can be exposed to a hacking thread so it is recommended to change the password after installing the product.  
Note that the security and other related issues caused by the unchanged password shall be responsible for the user.

4. When the administrator setup is done, press <OK>.

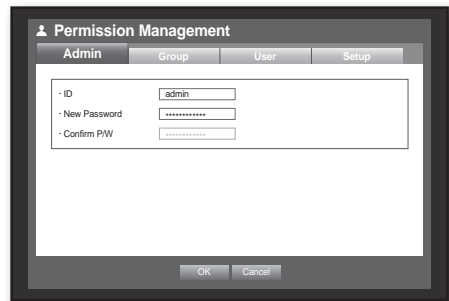

### Using Virtual Keyboard

- ① For alphanumeric inputs, the virtual keyboard window appears.
- ② Use direction buttons (▲▼◀▶) to move to a desired character, and press the [ENTER] button.
- ③ In the upper text input box of the virtual keyboard, there displays a list of candidate words containing the selected character.
- ④ Select a word from the list, or use the keyboard to enter the whole word.
  - If there are many of candidate words, use <◀, ▶> buttons to move between them forward and backward.
- ⑤ Select <OK>.  
Entered word is applied.
  - For upper case letters, use <Caps Lock> button.
  - For special characters, use <Shift> button.
  - Using the virtual keyboard is the same to a normal keyboard use in your region.
  - You can enter only lower-case alphabets and numeric values for the user ID.
  - For the password, use alphabets and special characters excluding < \ > and < " >.
  - You can use number buttons on the remote control or front panel.

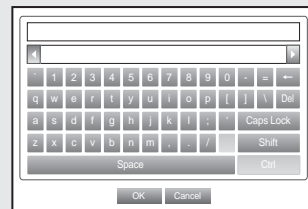

## Setting the Group

You can create user groups and setup permissions for those user groups.

You can register a user for each group in <User>.

Using the mouse may help make setup easier.

1. Use the up/down buttons (▲▼) in <System> window to move to <Permission Management>, and press [ENTER] button.

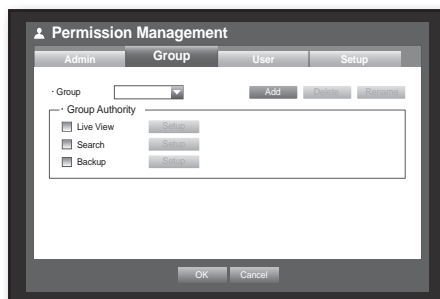

2. Select <Group>.

A window for <Add>, <Delete>, <Rename>, and <Group Authority> setup appears.

3. Use direction buttons (▲▼◀▶) to move to a desired item, and set the value.

- Add, Delete, Rename : You can add, delete, rename a group or modify the permissions given to the group. The virtual keyboard appears when <Add> or <Rename> was selected.

You can add up to 10 groups.

- Add : When you first run the DVR with the admin account, only the admin account exists. Add has already been deactivated. Select <Add> to display the virtual keyboard. Enter a group name. You can add up to 10 groups.

- Delete : Deletes a user group that is already registered. Selecting Delete will delete all user accounts belonging to that group.

- Rename : Renames a group that is already registered. Select <Rename> to display the virtual keyboard.

- For entering a group name, refer to “Using Virtual Keyboard”. (Page 50)

- Group Authority : Sets permissions to access menu items of each group. Users of a group can access checked functions.

4. When the group setup is done, press <OK>.

## To set the group authority

You can set the permissions of the group users to access the menu according to the channel.

1. Select a menu to which the group permission is assigned. The menu where the group permission is assigned will be displayed in the Live menu when a group user logs in.

- Live View : You can set the permission to access the Live screen according to the channel.

- SDE-400X shows a list of 8 channels in Channel Setup window.

- Search : You can set the permission to access the Search menu according to the channel.

- Backup : You can set the permission to access the Backup menu according to the channel.

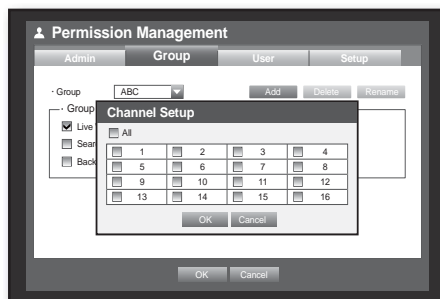

2. Select <OK>.

Select and assign a group user so that the user can access the specified menu.

# main menu

## To restrict the user permissions

If the admin restricts all permissions of an added group, the users belonging to that group can access only the default minimum menus and can change the user's own password only.

1. Start the DVR.  
If all permissions are restricted, only the Login dialog should appear.
2. Log in with a registered user ID.

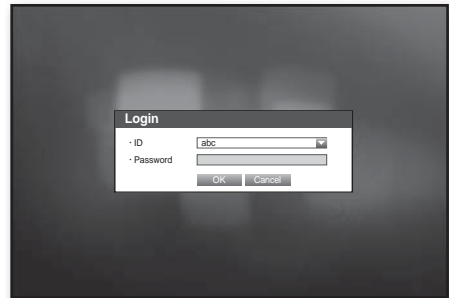

3. Right-click any area on the screen.  
If all permissions are restricted, only the accessible context menus should appear.



## To change the user password

If you log in with a user account that is restricted to access the menu, you can change your own password only.

1. Log in with your account.
2. Select <User Menu>.  
The Permission Management setup screen appears.
3. Select <Permission Management>.  
The Password setup dialog appears.
4. Enter a new password.
5. Select <OK>.  
Your change to the password will be applied.

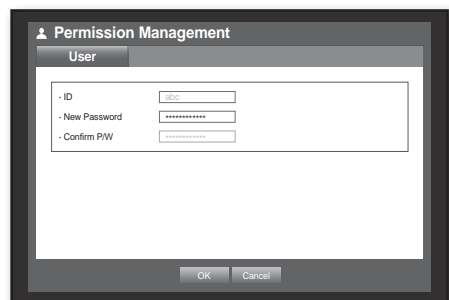

## Setting the User

Users can be added only if a group was created in <Group> menu.

Using the mouse may help make setup easier.

1. Use the up/down buttons (▲▼) in <System> window to move to <Permission Management>, and press [ENTER] button.
2. Select <User>.
 

A window for Add User appears.
3. Use direction buttons (▲▼◀▶) to select <Add> from the window.
 

A window for "Add User" appears.

You can configure the Network Viewer settings including name, ID, viewer, Select Group and password.

Result of the user setup appears in the <User> window.

To change the user property, use "Edit User".

The "Edit User" window appears when you select a desired item to be changed in the <User> window.
- Viewer : If you select <Use>, you will be given access to the Web Viewer and Network Viewer.
  - Refer to "Connecting Web Viewer". (Page 95)
  - For more information about use of SmartViewer, refer to the SmartViewer's user guide.
4. When the user setup is done, press <OK>.

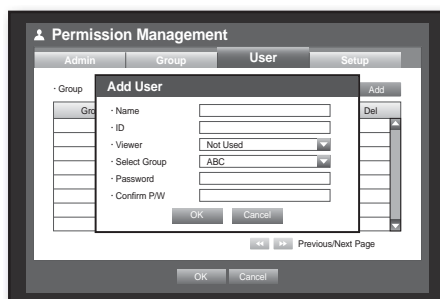
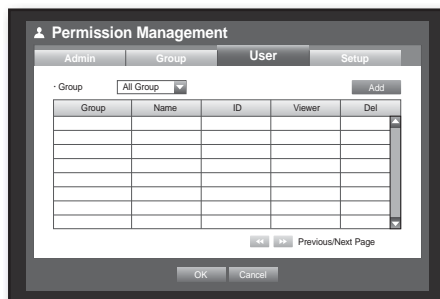

# main menu

## Setting Permissions

You can set restricted access for all general users. Items with restrictions will require logging in for use.

Using the mouse may help make setup easier.

1. Use the up/down buttons (▲▼) in <System> window to move to <Permission Management>, and press [ENTER] button.

2. Select <Setup>.

The Restricted Access, Restriction on Network Access, Auto Log out, Manual Input of ID setup screen appear.

3. Use direction buttons (▲▼◀▶) to move to a desired item, and set the value.

- Restricted Access : All menu items allowed for a user can be set with restricted access.

- Checked (☑) : Restricted

- Not checked (☐) : Accessible

- If it is not checked (☐) in <Restricted Access>, any user can access the item no matter what the <Group Authority> setting.

- If it is checked (☑) in <Restricted Access>, a user can access the item only if the user has permission in <Group Authority> setting.

- Restriction on Network Access : Restricts remote access from a <Restricted Access> network.

- All Network : Restricts all access instances via Network Viewer and Web Viewer.

- Web Viewer : Restricts access via the Web Viewer.

- Auto Log out : A user will be automatically logged out if there is no operation on DVR for over set period of time.

- Manual Input of ID : Prompts you to enter the user ID manually for the login process.

- Checked (☑) : Encloses the registered user IDs with the [\*] symbols.

Use the virtual keyboard to enter the user ID.

4. When the permission setup is done, press <OK>.

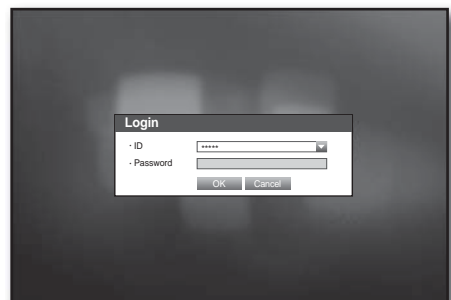
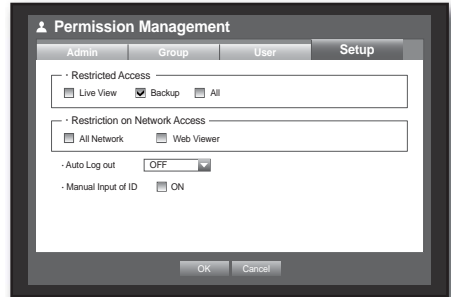

## System Management

You can check the system version, update to a newer version, as well as data backup and initialization.

### Checking the System Information

You can check the current system version, broadcasting system, MAC address. You can update the system. Using the mouse may help make setup easier.

1. Use the up/down buttons (▲▼) in <System> window to move to <System Management>, and press [ENTER] button.
  2. Check the Software Version, Broadcast Format, and MAC Address.
- System Information : Shows the current system's information.  
The values can not be changed by a user.
  - S/W Upgrade : Updates the DVR's software up to date.

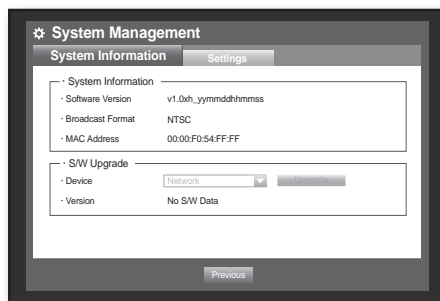

- Ex : If you connect to a storage device that has upgradable software installed, and return to the <System Management> menu, the current software version will be displayed.

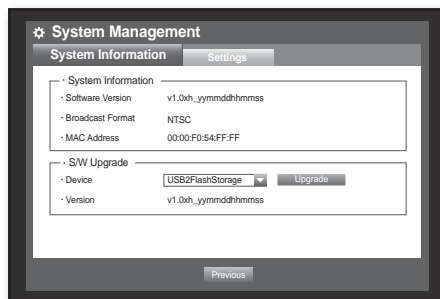

### Updating the Software

1. Connect a device storing the software to be updated. (It may take about 10 seconds to recognize the device.)
  - Upgradeable devices include USB memory and network device.
  - To update the network, the current DVR should have been connected to the network.  
Upgrade via the proxy server may not be enabled due to the restricted access.
2. Select <System Management> from <System> window.
3. Select <System Information>.
4. When the recognized device appears, select <Upgrade>.
  - The <Upgrade> button will be activated only if the current <Software Version> of the <System Information> is same to or older than that of <S/W Upgrade>.

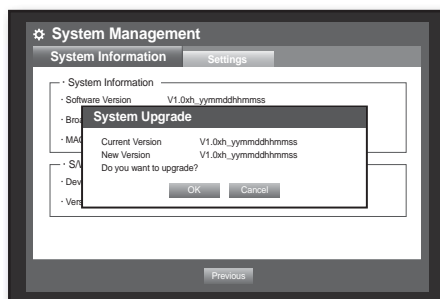

# main menu

5. Press <OK> in the "System Upgrade" window.
  - While updating, it shows the progress.
- Updating progresses with 3 steps as shown in the figure.

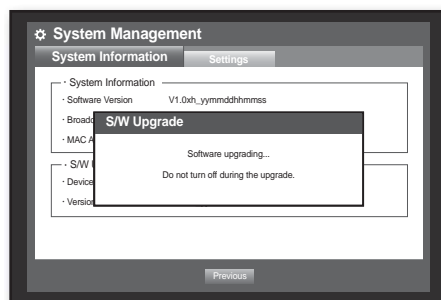
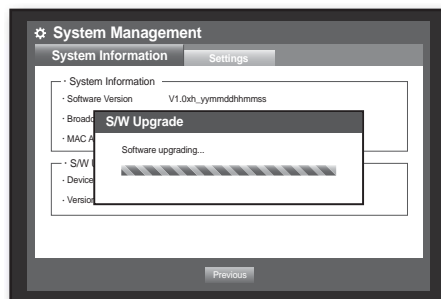

6. When the updating is done, it automatically restarts.  
Do not turn the power off until it finishes restarting.
-  If "Upgrade Failed" appears, retry from the step 4.  
When you experience continued failure, consult the service center for assistance.
  - When you perform S/W update remotely using Smart Viewer, it may take a max of 3 minutes to complete the update since Smart Viewer popped up a confirmation message. This is to guarantee that the DVR set operates stably. For a faster update, use the USB cable to connect to the DVR set.

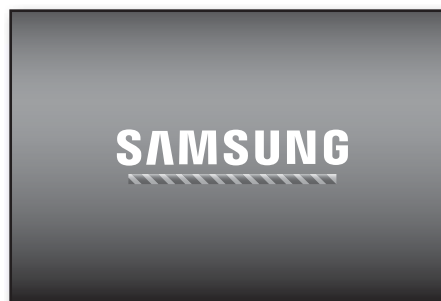



## Settings

You can copy and import the DVR settings by using a storage media.

Using the mouse may help make setup easier.

1. Use the up/down buttons (▲▼) in <System> window to move to <System Management>, and press [ENTER] button.
2. Select <Settings>. A window of storage device and load factory default appears.
3. Use direction buttons (▲▼◀▶) to move to a desired item, and export or import settings data to a storage device.
  - Storage Device : Shows the connected storage device.
  - DVR→USB : Exports DVR settings to the connected storage device.
  - USB→DVR : Imports DVR settings from the storage device and applies to the DVR.
    - If <Include Network Settings> is checked, the network settings will be imported too.
  - Load Factory Default : If <Default> is selected, a confirmation dialog for “Load Factory Default” prompts. Press <OK> to initialize the system to the factory default.
4. To move to the previous menu, press <Previous>.

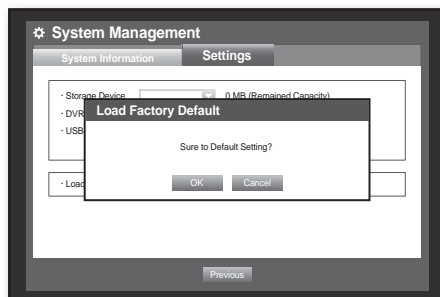
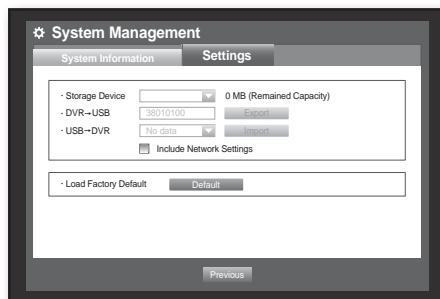

## Log Information

You can browse logs on the system and events.

### System Log

System Log shows log and timestamp on every system start up, system shutdown, and changes on system settings.

Using the mouse may help make setup easier.

1. Use the up/down buttons (▲▼) in <System> window to move to <Log Information>, and press [ENTER] button.
2. Select <System Log>.
  - Refer to “Using the Calendar”. (Page 49)  
Click on the calendar <[Calendar Icon]> to display the calendar window.
  - Type : When there are too many logs, you can display logs of the desired format by selecting the type.
3. Use direction buttons (▲▼◀▶) to move to a desired item, and press <Search>.

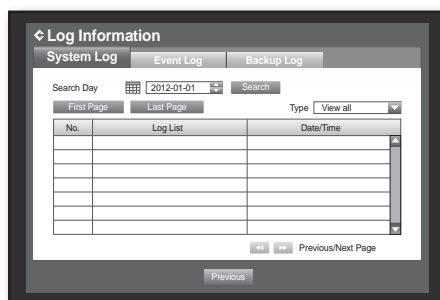

# main menu

## Event Log

Event log shows recorded events on alarms, motion detections and video loss. It also shows the log and its timestamp.

Using the mouse may help make setup easier.

1. Use the up/down buttons (▲▼) in <System> window to move to <Log Information>, and press [ENTER] button.
2. Select <Event Log>.
3. Use direction buttons (▲▼◀▶) to move to the desired item.
4. Set Search Day, Channel and Type and the press <Search>.
  - Refer to "Using the Calendar". (Page 49)  
Click on the calendar <📅> to display the calendar window.

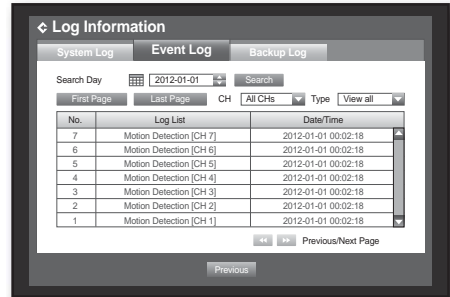

## Backup Log

You can find out who backed up and the details (backup time, channel, device to use, file format, etc.).

Using the mouse may help make setup easier.

1. In the <System> window, press the up/down (▲▼) button to move to <Log Information> and press the [ENTER] button.
2. Select <Backup Log>.
3. Use the four direction buttons (▲▼◀▶) to move to a desired item.
4. Specify a search term and select <Search> in the right corner. Backup details for the search term will be listed.

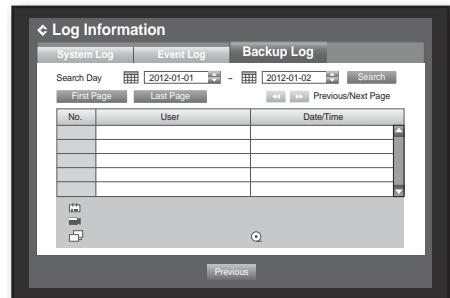

## SETTING THE DEVICE

You can configure the settings of: Camera, Storage Device, Remote Device and Monitor.

### Camera

#### Setting the Camera

You can set Video, Audio, Channel Name and Dwell Time of a Camera.

Using the mouse may help make setup easier.

1. Press the [MENU] button on the remote control or front panel.
2. Use the left/right button (◀ ▶) to select <Device>. Device setting menu is selected.
3. Use the up/down buttons (▲ ▼) to move to <Camera>, and press [ENTER] button.



4. Select <Camera>. You will see a window where you can configure the camera settings including Video, Audio, Channel Name, SEQ-Dwell Time and Privacy Region.

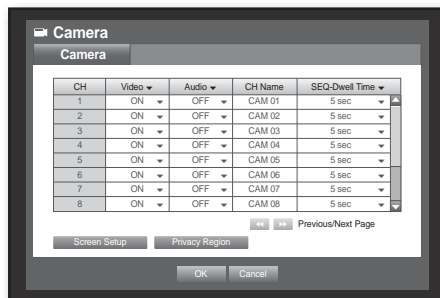

5. Use direction buttons (▲ ▼ ◀ ▶) to move to a desired item, and set the value.
- Video
    - <ON/OFF> : You can turn ON/OFF the selected channel's camera.
    - <Covert1> : Shows information other than the video of the selected channel.
      - For privacy protection, it does not display the video while the recording continues.
    - <Covert2> : Shows nothing but an empty screen while the recording continues.
  - Audio
    - If set to <ON>, you can turn the audio of the channel ON on the Live screen.
    - If set to <OFF>, the channel's audio is off on the Live screen and not recorded.
  - CH Name : Up to 15 characters including blanks are allowed.
    - Refer to "Using Virtual Keyboard". (Page 50)
  - SEQ-Dwell Time : You can set the dwell time between channels for the Live screen.
    - If set to <OFF>, the channel is not listed in the Auto Sequence mode.

# main menu

- Screen Setup : The video appeared on the screen may vary depending on the channel's camera, configure the DVR display to your preferences. Select a channel and adjust the <☀ (Brightness)>, <⦿ (Contrast)>, and <🌈 (Color)> of the selected channel.
    - Press the <Init> to initialize settings back to the default 50.
  - Privacy Region : You can specify a certain area of the camera video to be protected for your privacy.
    - The <Privacy Region> is supported by SDE-4003/5003 only.
6. When the camera setup is done, press <OK>.



## To set the privacy region

- ① Select <Privacy Region>.
- ② When "Privacy Region" window appears, select a channel for detection and set the area of motion detection.

- To set the area in "Privacy Region" window

In the "Privacy Region" window, select desired region from <[Color Swatches]>.

### • Privacy Region

You can specify up to 4 privacy zones for each channel, which can be identified by the color.

1 ■ Purple 2 ■ Green 3 ■ Blue 4 □ Yellow

- To set the area using <Individual> selection

When selected <Individual>, "Privacy Region" window disappears and you can select cells one by one. When the motion area setup is done, Right-click to select <Menu> in the context menu or the [MENU] button on the remote control to display the "Privacy Region" window again.

- Clear All : Selected cell is removed from the Privacy Region.
- Menu : After selecting individual motion areas, move to the "Privacy Region" window.
  - If selected <Apply to All CH>, selected motion area is applied to all channels.

- ③ When completing the privacy zone settings, click <OK>.



Clear All  
Menu

## Storage Device

You can check information on storage devices.

### Confirming Devices

You can check storage devices and their free space, usage as well as status. Devices available are HDD, and USB devices (Memory, HDD).

Using the mouse may help make setup easier.

1. Use the up/down buttons (▲▼) in <Device> window to move to <Storage Device>, and press [ENTER] button.
2. Select <Device>.
  - No. : Shows the assigned number of the internal HDD.
  - Used/Total : Shows the used/total capacity of the storage device.
  - Usage : Sets the storage device's usage.
    - USB memory is used only for backups.
  - Status/Management : Shows the current status of the HDD, as in Normal/Check/Replace.
    - Normal : Available to use
    - Check : Available to use but recommended to replace
    - Replace : Requires immediate replacement.
3. To move to the previous menu, press <OK>.

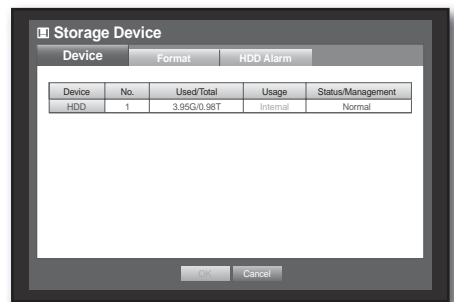

# main menu

## Formatting

You can format a storage device.

Using the mouse may help make setup easier.

1. Use the up/down buttons (▲▼) in <Device> window to move to <Storage Device>, and press [ENTER] button.
2. Select <Format>.  
A window for selection of device for formatting appears.
3. Use direction buttons (▲▼◀▶) to select a device to be formatted.

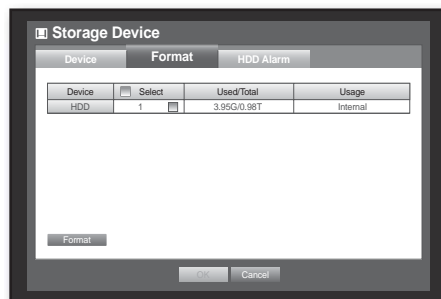

4. Select <Format> on the bottom of the screen.  
Press <OK> on the “Manage” confirmation window will start formatting the selected device.
5. When the formatting is done, press <OK>.



- Even when formatted, used HDD space will not be 0 GB due to the space reserved by the system required for operating.

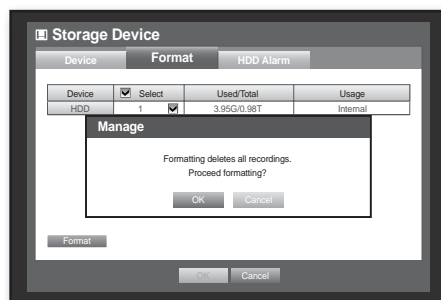

## HDD Alarm

You can set alarm settings for HDD defects such as Check Alarm Output Port, Replace Alarm Output Port, and its duration.

Using the mouse may help make setup easier.

1. Use the up/down buttons (▲▼) in <Device> window to move to <Storage Device>, and press [ENTER] button.
2. Select <HDD Alarm>.  
A window for setting HDD check and replace output ports and their durations appears.

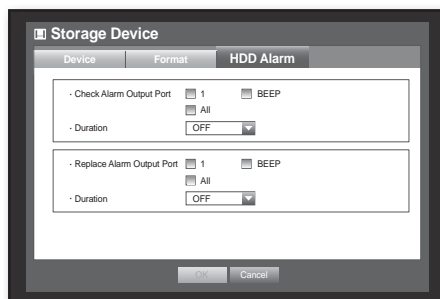

3. Use direction buttons (▲▼◀▶) to move to the desired item.

### • Alarm

- Alarm signal will output through the alarm out port on the rear side when selected <1>.
- If <BEEP> was selected, a beep will sound.
- If <All> was selected, both beep sound and alarm signal through rear side ports will output.
  - Alarm function is not supported by SDE-4003/5003.
- Check Alarm Output Port : If HDD generates check alarm, the alarm signal will output to the specified alarm output port.
- Replace Alarm Output Port : If HDD generates replace alarm, the alarm signal will output to the specified alarm output port.
- Duration : Sets the alarm duration for the alarm signal and beep sound.



- <Check> status means that the HDD is operating but it has problems that require technical examination. (🔧) appears on the Live screen.
- <Replace> status means that the HDD has defect and requires immediate replacement. (🔧) appears on the Live screen.

4. When the HDD Alarm setup is done, press <OK>.

## Remote Devices

You can set the Remote Control ID with the DVR.

Using the mouse may help make setup easier.

1. Use the up/down buttons (▲▼) in <Device> window to move to <Remote Device>, and press [ENTER] button.
2. Use direction buttons (▲▼◀▶) to move to the desired item, and press [ENTER] button.
3. Make sure to match IDs of the DVR and Remote Control, and press <OK>.



- For changing the remote control's ID, refer to "Changing the Remote Control ID". (Page 22)

# main menu

## Monitor

You can configure information to be displayed.

### Setting the Monitor

Using the mouse may help make setup easier.

1. Use the up/down buttons (▲▼) in <Device> window to move to <Monitor>, and press [ENTER] button.

2. Select <Monitor>.

3. Use direction buttons (▲▼◀▶) to move to a desired item, and set the value.

- Event Display : Sets the dwell time of the event channel display on the monitor when an event occurs.  
If selected <Continuous>, it displays the channel until you press [ALARM] button to release it.
  - Display : Displays only checked items on the monitor screen.
  - Multi CH SEQ Time : Sets the interval between automatic display switching in 4-split and 9-split mode of the Live screen.
  - Video Out: You can set the video output mode.
    - Auto : The default is set to Composite. (In VGA mode, the "SAMSUNG" logo will be displayed)  
If a VGA source is connected, the source from the VGA will be displayed as main. (In Composite mode, the spot screen will be displayed)  
The monitor distributor is not supported.  
To switch to VGA mode, turn off the DVR set and connect the VGA jack. (The VGA monitor will turn on)
    - VGA : The main video mode will switch to VGA after the DVR set reboots; the composite source will be displayed on the spot screen.
    - Composite : The main video mode will switch to Composite after the DVR set reboots.  
(SDE-4003/5003 : In VGA mode, the "SAMSUNG" logo will be displayed.)
4. When the monitor setup is done, press <OK>.

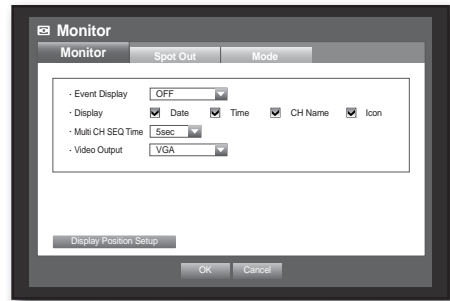

### Setting Display position

Some monitors many not display information (camera name, icon, time information, etc.) about the DVR, depending on the condition. Then, you can change the display position of the data.

1. In the <Device> window, press the up/down (▲▼) button to move to <Monitor> and press the [ENTER] button.
2. Select the <Monitor> item.
3. Select <Display Position Setup> in the bottom.  
You will move to the <Display Position Setup> window.
4. Use the four direction buttons or the number buttons on the front panel or the remote control to adjust the data position.

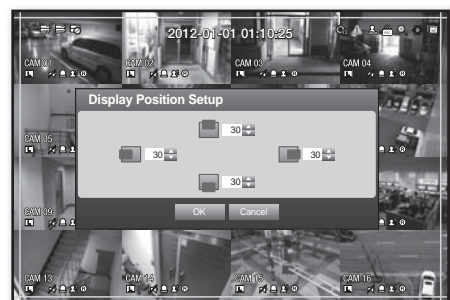



## Setting the Spot Out

You can set the DVR to output information / video apart from the monitor out.

Using the mouse may help make setup easier.

1. Use the up/down buttons (▲▼) in <Device> window to move to <Monitor>, and press [ENTER] button.
2. Select <Spot Out>.
  - The number of Spot Out terminals differs according to the model.
3. Use direction buttons (▲▼◀▶) to move to a desired item, and set the value.

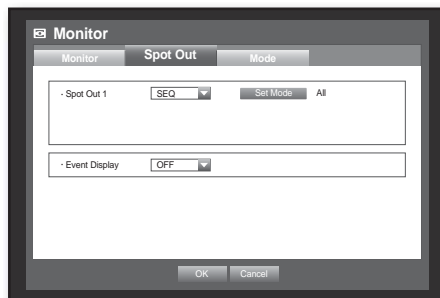

- Spot Out 1 : You can select between SEQ, and Single.
- Set Mode : A window for “Set Spot Out” appears and you can set the channel for it.  
You can set the dwell time between the screen switching in “Setting the Device > Camera > SEQ-Dwell Time”. (Page 59)

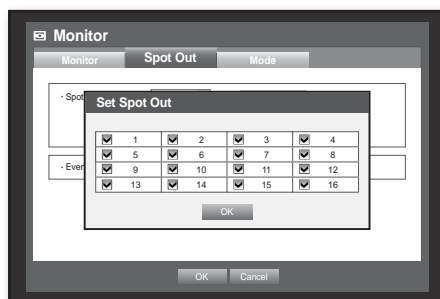

- You can setup using the mouse right button in Live screen. Refer to “Spot Out”. (Page 44)

4. When the Spot Out is done, press <OK>.

## Setting the Screen Mode

You can configure the Live screen and Split Screens.

Using the mouse may help make setup easier.

1. Use the up/down buttons (▲▼) in <Device> window to move to <Monitor>, and press [ENTER] button.
2. Select <Mode>.
3. Use direction buttons (▲▼◀▶) to move to a desired item, and set the value.
  - Live Screen : Select split modes for the Live screen. 16-, 9-, and 4-split screens are included by default. SDE-400X doesn't support 16-split screen mode.
  - Play Screen : Select split modes for the playback screen. Only the 13-split screen is optional. Black shows the playback while white shows the Live screen.
4. When the screen mode setup is done, press <OK>.

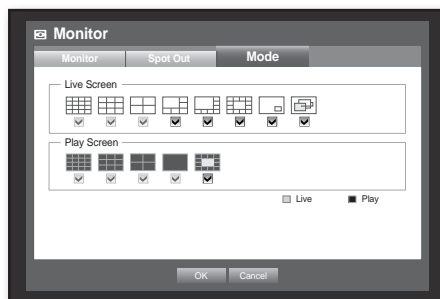

## SETTING THE RECORDING

You can setup scheduled recording, event recording and other recording related settings.

### Recording Schedule

Make your reservation on a date and time to schedule the recording on specified time.

Using the mouse may help make setup easier.

1. Press the [MENU] button on the remote control or front panel.
2. Use the left/right button (◀ ▶) to select <Record>. Record menu is selected.
3. Use the up/down buttons (▲ ▼) to move to <Recording Schedule>, and press [ENTER] button.



4. Select <Recording Schedule>. A window of scheduled recording setup appears.
5. Use direction buttons (▲ ▼ ◀ ▶) to move to a desired item, and set the value.

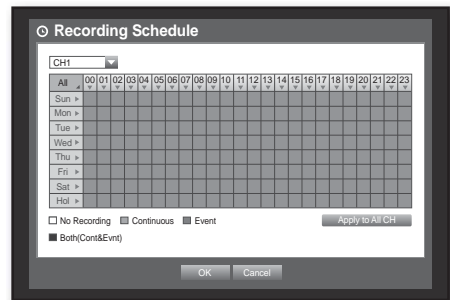

- Apply to All CH : If selected <Apply to All CH>, "Apply to All CH" window appears. Press <OK> to apply the setup to all channels.
6. When the recording schedule setup is done, press <OK>.
-  ■ Event recording and scheduled recording starts about 3 seconds prior to the event/schedule for guaranteed recording.

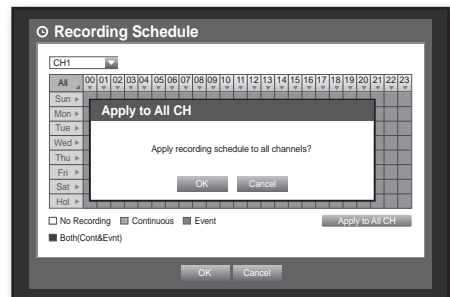

## Recording Color Tags

Color	Function	Description
White	No Recording	No schedule / event recording
Orange	Continuous	Scheduled recording only
Blue	Event	Event recording only
Green	Both(Cont&Evt)	Both scheduled / event recordings

Each press of a selected cell will cycle through <No Recording>-<Continuous>-<Event>-<Both(Cont&Evt)>.

## Event Record Duration

You can set the beginning and ending point of a recording on an event.

Using the mouse may help make setup easier.

1. Use the up/down buttons (▲▼) in <Record> window to move to <Event Record Duration>, and press [ENTER] button.
2. Use direction buttons (▲▼◀▶) to move to a desired item, and set the value.
  - Pre Event : The recording of an event will start at a pre-determined time prior to the actual occurrence of the event. If it is set to 5 seconds, the recording begins from 5 seconds before the event.
  - POST Event : The recording will continue for a pre-determined time after the actual end of an event. If it is set to 5 seconds, the recording ends in 5 seconds after an event.
3. When the event recording duration setup is done, press <OK>.

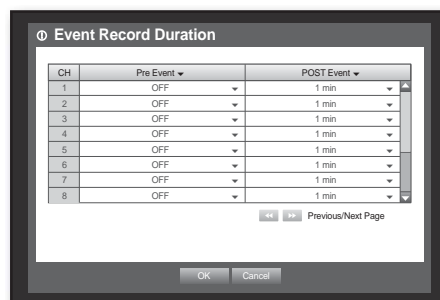

# main menu

## REC Quality & Resolution

You can set resolution, FPS and quality of recordings by channel, and by recording type of standard / event.

### Setting Standard Recording Properties

You can set each channel's resolution, quality and fps for normal recordings.

Using the mouse may help make setup easier.

1. Use the up/down buttons (▲▼) in <Record> window to move to <REC Quality & Resolution>, and press [ENTER] button.
2. Select <Standard>.
3. When the recording setup is done, press <OK>.

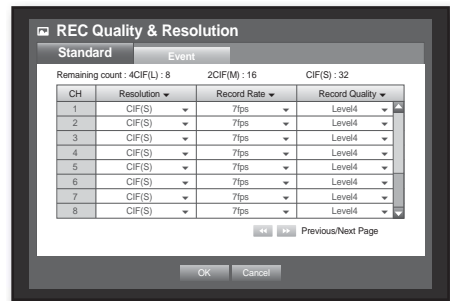

### Setting Event Recording Properties

You can set each channel's resolution, quality and fps for event recordings.

Using the mouse may help make setup easier.

1. Use the up/down buttons (▲▼) in <Record> window to move to <REC Quality & Resolution>, and press [ENTER] button.
2. Select <Event>.  
Event recording setup window appears.
3. Use direction buttons (▲▼◀▶) to move to a desired item, and select it.
  - Resolution : Sets the resolution of the recorded screen.
  - Record Rate : Frames recorded per second.
  - Record Quality : Sets the recording quality.

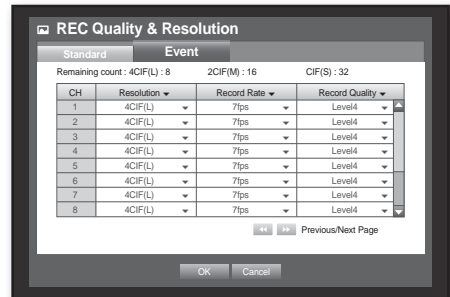

- The estimated total remaining count means the total number of remaining recordings for both standard and event recordings.
- You cannot increase the remaining count if the current remaining count has reached zero or there is no available remaining count from any other page. If this is the case, reduce the remaining count for the current page, or do so for the same channel on any other page.

4. When the Event recording setup is done, press <OK>.

## Record Option

You can set the recording to stop or overwrite when the HDD is full.

Using the mouse may help make setup easier.

1. Use the up/down buttons (▲▼) in <Record> window to move to <Record Option>, and press [ENTER] button.
2. Use direction buttons (▲▼◀▶) to move to a desired item, and set the value.
  - Disk End Mode : If selected <Overwrite>, recording will continue despite the HDD full while overwriting the oldest. If selected <Stop>, the recording will stop when the HDD is full.
  - Disk End Beep : If selected <Stop>, the button is activated. If you check it, the beep will sound on the disk full and the recording stops.
  - Auto Delete : If you check it, Record Period setup is activated. If you specify the auto deletion period, the recording data before the period will be deleted automatically.
    - This option will be enabled only if Disk End Mode is set to <Overwrite>.
3. When the recording option setup is done, press <OK>.

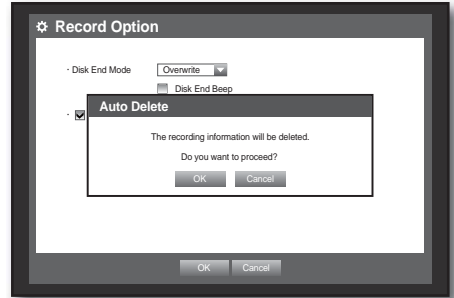

# main menu

## SETTING THE EVENT

You can set recording options for sensor, motion, and video loss event.

- Setting the <Sensor Detection> is not supported by SDE-4003/5003.

### Sensor Detection

You can set the sensor's operating condition and connected camera, as well as alarm output and its duration. Using the mouse may help make setup easier.

1. Press the [MENU] button on the remote control or front panel.
2. Use the left/right button (◀ ▶) to select <Event>. Event setting menu is selected.



3. Use the up/down buttons (▲ ▼) to move to <Sensor Detection>, and press [ENTER] button. A window of sensor detection setup appears.

4. Use direction buttons (▲ ▼ ◀ ▶) to move to a desired item, and set the value.

- Sensor Operation : Sets the operation mode of sensors.
  - <OFF> : Sensor does not operate.
  - <N.O (Normal Open)> : Sensor is opened. If the sensor is closed, it generates alarm.
  - <N.C (Normal Close)> : Sensor is closed. If the sensor is open by interruption, it generates alarm.
- Cam : Select a channel to be connected to the sensor. If selected camera, "Camera Setup" window appears. Select a channel and setup the preset.
  - SDE-400X could only preset 8 channels.

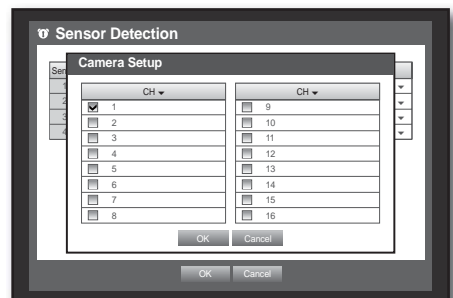
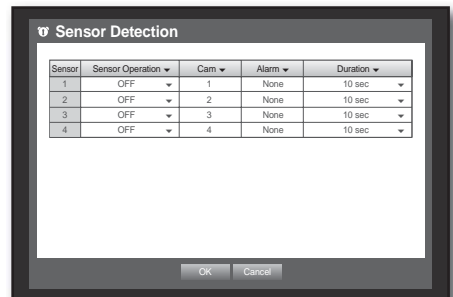

- Alarm : Sets the alarm output method.
    - For further information on alarm output, refer to “HDD Alarm > Alarm”. (Page 63)
  - Duration : Sets the duration of alarm signal and alarm sound.
5. When the sensor detection setup is done, press <OK>.

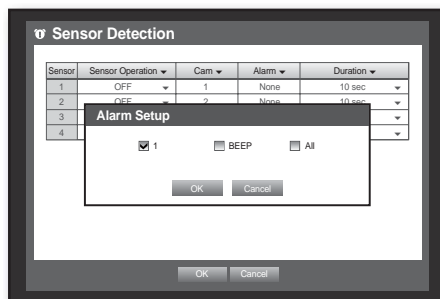

## Motion Detection

You can set target detection region and motion, as well as the alarm signal output. When the motion detection region is set, it detects motion within the area.

Using the mouse may help make setup easier.

1. Use the up/down buttons (▲▼) in <Event> window to move to <Motion Detection>, and press [ENTER] button. A window of motion detection area setup appears.
2. Use direction buttons (▲▼◀▶) to move to a desired item, and set the value.
  - Mode : Sets whether to activate motion detection.
  - Sensitivity : Sets the sensitivity level of the motion detection.
  - Alarm : Sets the alarm output method.
    - For further information on alarm output, refer to “HDD Alarm > Alarm”. (Page 63)
  - Alarm Duration : Sets the duration of alarm signal and alarm sound.
3. When the motion detection setup is done, press <OK>.

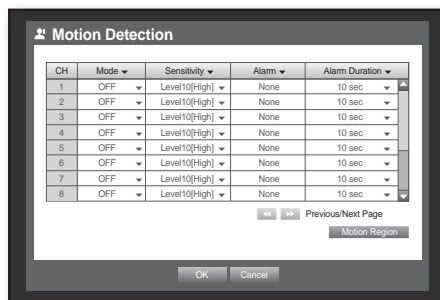

# main menu

## Setting the Motion Detection Area

- ① Select <Motion Region>.
- ② When “Motion Region” window appears, select a channel for detection and set the area of motion detection.

- To set the area in “Motion Region” window  
In the “Motion Region” window, select desired region from <  >.

- To set the area using <Individual> selection  
In the “Motion Region” window, you can select cells individually by using <Individual>.

When selected <Individual>, “Motion Region” window disappears and you can select cells one by one. When the motion area setup is done, press the <Menu> on the screen or the [MENU] button on the remote control or front panel to display the “Motion Region” window again.

- Select : Selected cell is set to be a part of motion detection area.
  - Unselect : Selected cell is removed from the motion detection area.
  - Inverse : Unselected cells are set to be the motion detection area.
  - Menu : After selecting individual motion areas, move to the “Motion Region” window.
    - If selected <Apply to All CH>, selected motion area is applied to all channels.
- ③ When the motion detection setup is done, press <OK>.

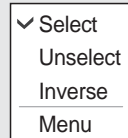

## Video Loss Detection

You can set the alarm to be generated on a camera disconnection, which causes a video loss. Using the mouse may help make setup easier.

1. Use the up/down buttons (▲▼) in <Event> window to move to <Video Loss Detection>, and press [ENTER] button.  
A window of video loss detection area setup appears.
2. Use direction buttons (▲▼◀▶) to move to a desired item, and set the value.
  - Video Loss State : Sets whether to activate video loss detection.
  - Alarm : Sets the alarm output method.
    - For further information on alarm output, refer to “HDD Alarm > Alarm”. (Page 63)
  - Alarm Duration : Sets the duration of alarm signal and alarm sound.
  - Help : Displays a help message that will appear if a video loss event occurs.
3. When the video loss detection setup is done, press <OK>.

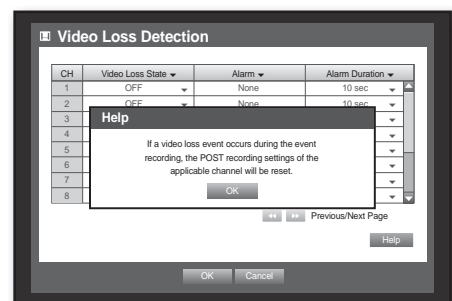



## Alarm Schedule

You can set the conditions and operating hours for scheduled alarms.  
Using the mouse may help make setup easier.

1. Use the up/down buttons (▲▼) in <Event> window to move to <Alarm Schedule>, and press [ENTER] button.

2. A window of <Alarm Schedule> settings appears.

- Alarm : Sets the alarm output method.
  - For further information on alarm output, refer to “HDD Alarm > Alarm”. (Page 63)
- <ON> : Marked in orange, and always generates alarm on scheduled time.
- <OFF> : Marked in white, no alarm is generated even if an event occurs.
- Event Sync : Marked in Blue, generates alarm only when an event occurs.
- Apply to All Alarm : Applies the configured schedule to all alarms.
  - It is not supported by SDE-4003/5003.



- When the alarm is generated on the scheduled time, you can stop the alarm by canceling the schedule.

3. When the Alarm Schedule setup is done, press <OK>.

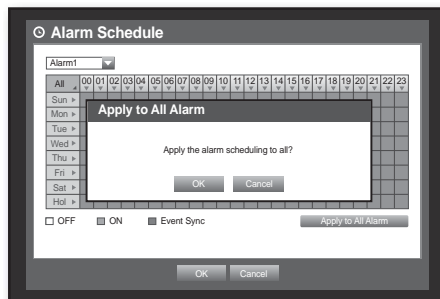
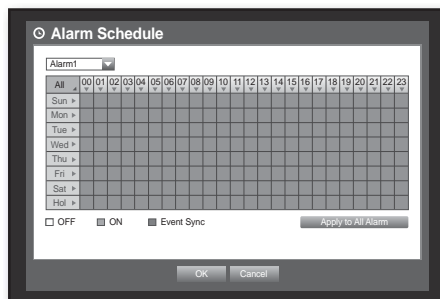

# main menu

## BACKUP

You can check the backup device and set the backup schedule by channel or by time.  
The product only supports external HDD of USB memory and USB type. (Page 126)

### Setting the Backup

You can backup the desired data to a connected device.

Using the mouse may help make setup easier.

1. Press the [MENU] button on the remote control or front panel.
2. Use the left/right button (◀ ▶) to select <Backup>. Backup menu is selected.



3. Press the [ENTER] button.  
A backup window appears.  
You can directly access it from the "Live screen menu". (Page 37)

4. Use direction buttons (▲ ▼ ◀ ▶) to move to a desired item, and set the value.

- Backup Range : Sets the <Start> and <End> time for the backup.
- Channel : Sets the channel to backup.  
You can select multiple channels.
- Device : Select a backup device from the recognized devices.
- Type : Sets the backup data format.
  - DVR : Saved data can be played back only by the DVR.
  - SEC : Saves data in the Samsung's proprietary format with built-in viewer, which supports immediate playback on a PC.
- Filename : You can set the back file name.
  - Refer to "Using Virtual Keyboard". (Page 50)
- Check capacity : Shows the size of the selected backup data, used and available capacity of the selected backup device.
- Overlap : Shows a list of overlapping data on a same time according to the number of data.  
It appears when one channel has multiple data on a certain time point due to changing of time or time zone settings, etc.
  - Refer to time and time zone of "Setting the Date/Time/Language". (Page 47)

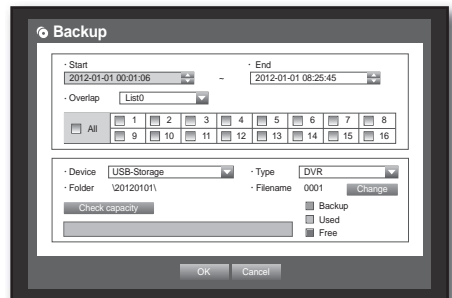

5. When the backup setup is done, press <OK>.
    - If no available device is recognized for backup, <OK> button is not activated.
- ! ▪ The application may slow down during the backup.
- You can switch to the menu screen during the backup in operation, but playback of data is not available.
  - When a memory device is used for backup, it is not available to use the full capacity of the media because the system consumes a portion of its capacity.
- ✍ ▪ Pressing the <Exit> during the backup will return to the previous menu, while the backup progresses.

## NETWORK CONFIGURATION

It provides networked monitoring of Live screen from a remote place, and supports mail forwarding function with events. You can configure the network environment which enables such functions.

### Connection Mode

You can set the network connection route and protocol.

### Setting the Connection

Sets the protocol and environment of the network.

Using the mouse may help make setup easier.

1. Press the [MENU] button on the remote control or front panel.
2. Use the left/right button (◀ ▶) to select <Network>. Network menu is selected.
3. Use the up/down buttons (▲ ▼) to move to <Connection Mode>, and press [ENTER] button.

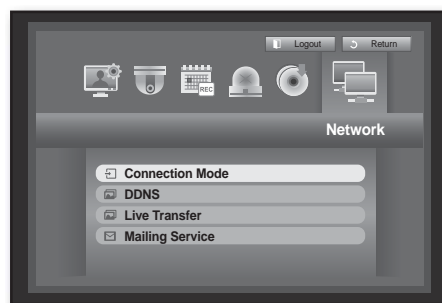

4. Select <Connection>. A window of connection mode setup appears.
5. Use direction buttons (▲ ▼ ◀ ▶) to move to a desired item, and set the value.
  - Connection Mode : Sets the network connection mode.
  - Bandwidth : Sets the maximum data flow to be transferred. (Upload speed)  
Options will vary depending on the selected connection mode.
    - For <Static IP>, <Dynamic IP> : Select one from 50 kbps ~ 2Mbps, and Unlimited.
    - For <ADSL>, select one from 50 kbps ~ 600 kbps.

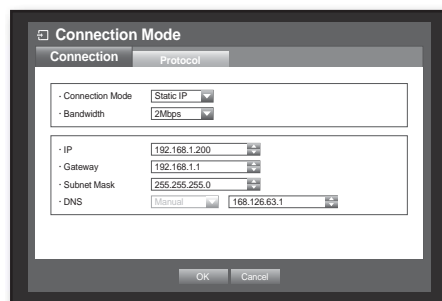

# main menu

- IP, Gateway, Subnet Mask, and DNS
  - For **<Static IP>** : You can directly input IP address, Gateway, Subnet Mask and DNS.
  - For **<Dynamic IP>** : IP address, Gateway, and Subnet Mask are set automatically.
  - For **<ADSL>** : IP address, Gateway, and Subnet Mask are set automatically.
- User ID, Password : In case you selected ADSL, provide the "User ID" and its "Password".

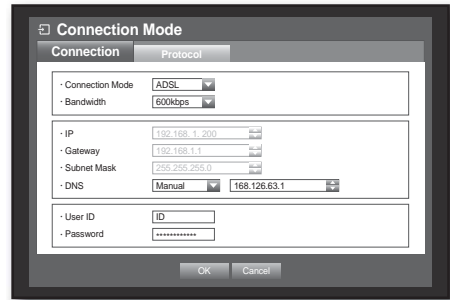

- DNS server for **<Dynamic IP>** and **<ADSL>** can be set by user only if you selected **<Manual>**.

6. When the connection setup is done, press **<OK>**.

## Setting the Protocol

1. Use the up/down buttons (▲▼) in **<Network>** window to move to **<Connection Mode>**, and press **[ENTER]** button.

2. Select **<Protocol>**.

3. Use direction buttons (▲▼◀▶) to move to a desired item, and set the value.

- Protocol Type : Select the protocol type between TCP and UDP.
  - If selected UDP, selections of Port (TCP), Port (UDP), and Unicast/Multicast are activated.
- Port (TCP) : Initially, **<4520~4524>** is set. It increases / decreases by 5.
  - TCP : It has better stability and lower speed when compared to UDP, and recommended for internet environments.
- Port (UDP) : Initially, **<8000~8160>** is set. It increases / decreases by 160.
  - UDP : It has less stability and faster speed when compared to TCP, and recommended for local area network (LAN) environments.
- Unicast/Multicast : Select one between Unicast and Multicast. If selected Multicast, Multicast IP and TTL are activated.
  - Unicast : Transfers data (UDP, TCP) individually to each connecting client.
  - Multicast : Multiple client can receive the data (only in UDP) without putting additional traffic load to the network.
- Multicast IP : User can directly input.
- TTL : Select from 0 ~ 255. Initial value for the TTL is set to **<5>**.
- Webviewer Port : Enter the port number for the Web Viewer. Initially, it is set to **<80>**.
- Multi Browser Support : You can use a Silverlight-compliant web browser to connect to the Web Viewer. Multi browsers are enabled only if the TCP port is set to between 4505 and 4530 with the Web Viewer port of 80. This is a security measure in order to enable Silverlight.

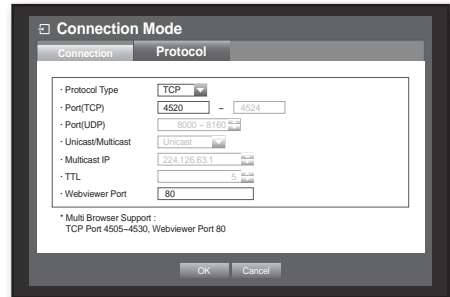

- As UDP protocol may cause a packet loss on the network, it is recommended to use TCP protocols.
- If you select UDP protocols and set port forwarding in the IP router, ending up with an unstable network connection, configure the DMZ settings in the IP router as necessary.

4. When the protocol setup is done, press **<OK>**.

## Notification

-  In a multi-browser environment, the web port should be set to 80 (private port).  
 Select one between 4505 and 4530 for RTSP

### • Network Overview

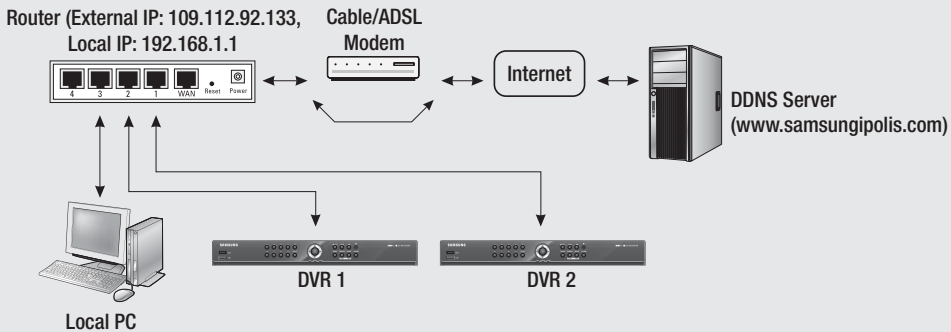

System	DVR 1		DVR 2	
	WEB	RTSP	WEB	RTSP
IP	192.168.1.200	192.168.1.200	192.168.1.202	192.168.1.202
Protocol	TCP	TCP	TCP	TCP
Private Port	80	4520~4524	81	4525~4529
Public Port	80	4520~4524	81	4525~4529

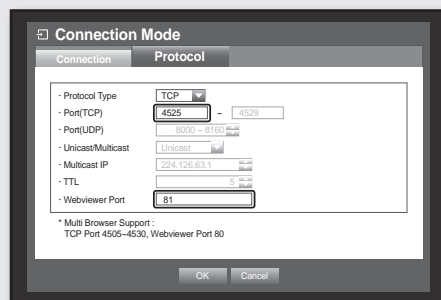
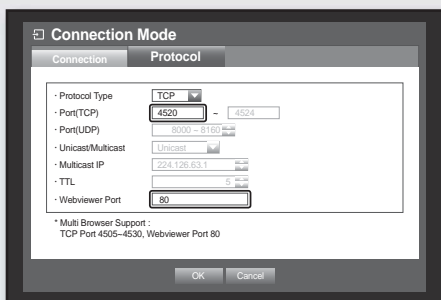
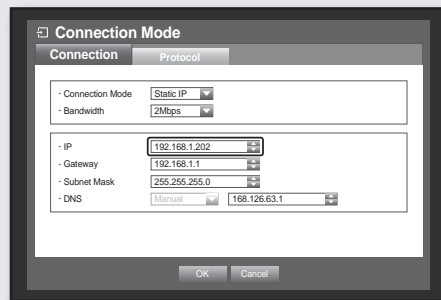
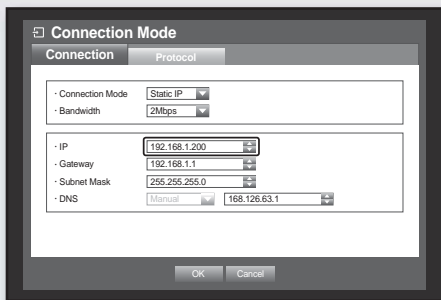

# main menu

- 1st Set Port Forwarding Setting

Port Forwarding is 4520~4524  
(4520, 4521, 4522, 4523, 4524)

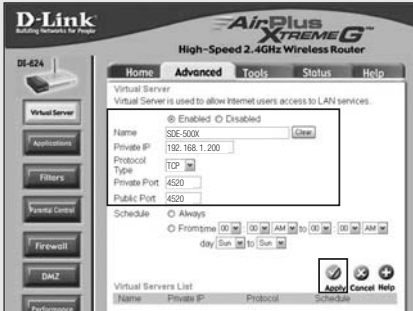

Port Forwarding is 80

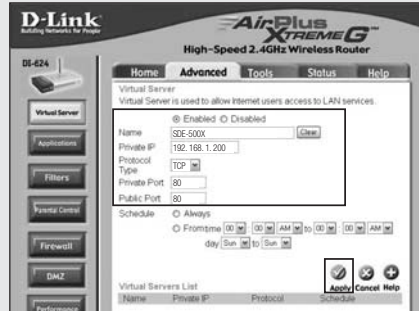

- 2nd Set Port Forwarding Setting

Port Forwarding is 4525~4529  
(4525, 4526, 4527, 4528, 4529)



Port Forwarding is 81

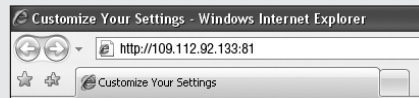
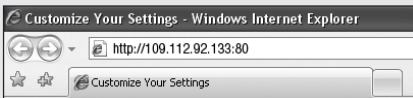

## Connecting and Setting the Network

Networking may differ from the connection method, check your environment before setting the connection mode.

### When no router is used

- **Static IP mode**

- Internet connection : Static IP ADSL, leased line, and LAN environments allows connection between the DVR and remote user.
- DVR Network Settings : Set the **<Connection Mode>** in **<Connection>** menu of the connected DVR to **<Static IP>**.
  - Consult your network manager for IP, Gateway and Subnet Mask.

- **Dynamic IP (DHCP) mode**

- Internet connection : Connect the DVR directly to a cable modem, DHCP ADSL modem or FTTH network.
- DVR Network Settings : Set the **<Connection Mode>** in **<Connection>** menu of the connected DVR to **<Dynamic IP>**.

- **ADSL (PPPoE: ID and password certification)**

- Internet connection : An ADSL modem is directly connected to the DVR, where the ADSL connection requires user ID and password.
- DVR Network Settings : Set the **<Connection Mode>** in **<Connection>** menu of the connected DVR to **<ADSL>**.
  - **<User ID>** and **<Password>** should be the same to the ADSL user information.  
If you don't know the ID and password, consult your ADSL service provider.

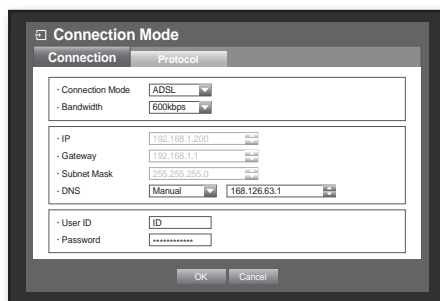
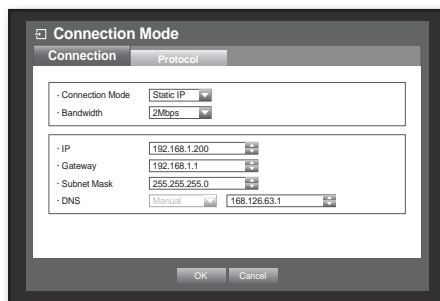

# main menu

---

## When a router is used



- To avoid IP address conflict with the DVR's static IP, check followings :

### • Setting the DVR with a static IP

- Internet connection : You can connect the DVR to a router which is connected to an ADSL/Cable modem or a router in a Local Area Network (LAN) environment.

### • Setting the DVR Network

1. Set the <Connection Mode> in <Connection> menu of the connected DVR to <Static IP>.
2. Check whether the set IP address is in the static IP range provided by the IP router.  
IP, Gateway, and Subnet Mask : Consult your network manager.
  - Check whether the set IP address is in the static IP range provided by the IP router.



- If a DHCP server is configured with starting address (192.168.0.100) and end address (192.168.0.200), you should set the IP address out of the configured DHCP range (192.168.0.2 ~ 192.168.0.99 and 192.168.0.201 ~ 192.168.0.254).

3. Check the Gateway address and subnet mask are equal to those set in the IP router.

### • Setting the DHCP IP Address of the IP router

1. To access the IP router's configurations, open a web browser on the local PC that is connected to the IP router and enter the router's address (ex : http://192.168.1.1).
2. At this stage, make the local PC's windows network configurations to the below example :  
Ex) IP : 192.168.1.2  
Subnet Mask : 255.255.255.0  
Gateway : 192.168.1.1
  - Once connected to the IP router, it prompts with password. While entering nothing to the User Name field, enter "admin" into the password field and press <OK> to access the router configurations.
  - Access the router's DHCP configuration menu and set its DHCP server activation, and provide the start and end address.  
Set the start address (192.168.0.100) and end address (192.168.0.200).



- Above steps may differ from the router devices depending on the manufacturer.



• **Setting Router's Port Forwarding**

1. Set the protocol to <TCP>.
2. External Port Range : Enter the TCP Port set in the <Port(TCP)> in <Protocol> menu of the connected DVR. If more than one DVRs are connected to the router, the TCP port can be different.
3. Internal PC IP Address : Enter the IP address set to the <IP> in <Connection> menu of the connected DVR.
4. Internal Port Range : Set the same to the "External Port Range".

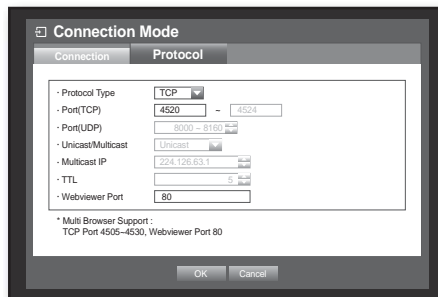

- Above steps may differ from the router devices depending on the manufacturer. Port forwarding is required when you want to access the DVR connected to the router from outside of the router's network.

❖ **In case of Port Forwarding Setting**

1. Download the program.  
Install it in your PC. Run <Simple Port Forwarding>.
  - To download visit <http://www.simpleportforwarding.com/download>

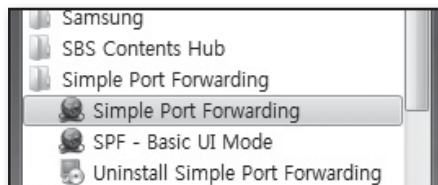

2. ① Click <(2)Do it now> in Check List.

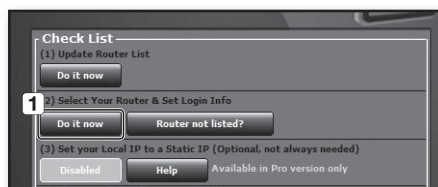

- ② Type your router information.  
If you can't find the exact router in the list, update the router list or choose a similar router in the same manufacturer.

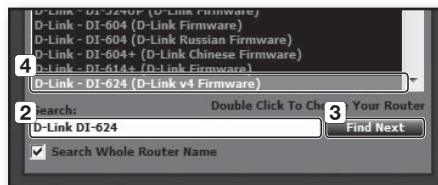

3. ① Click the icon for checking your router IP address.

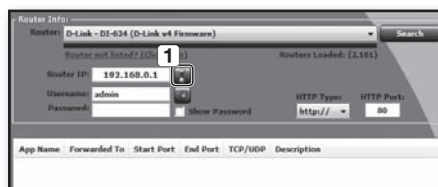

# main menu

② Click <OK> for updating your router IP address.

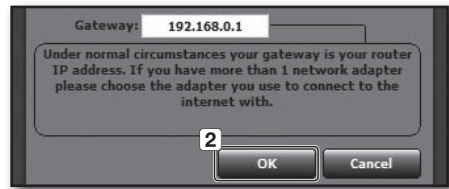

③ Type your router Username & Password.  
If you haven't changed them, skip this procedure, for it provides default value.

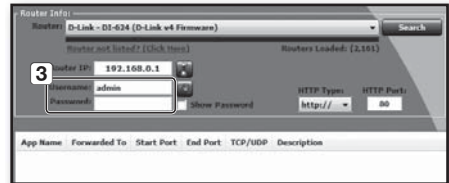

4. ① Click <(4)Do it now> in Check List for choosing the ports.

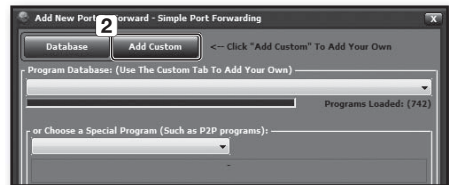

② Click <OK> for updating your router IP address.

IP Address : 192.168.1.200  
Type : TCP  
Start Port : 80  
End Port : 80

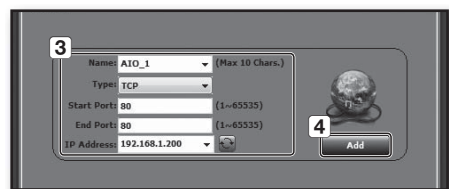

IP Address : 192.168.1.200  
Type : TCP  
Start Port : 4520~4524  
End Port : 4520~4524

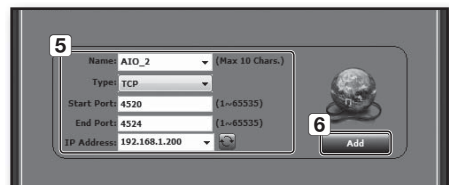

- After checking if the list is right, click **<(5)Do it now>** for updating your router.

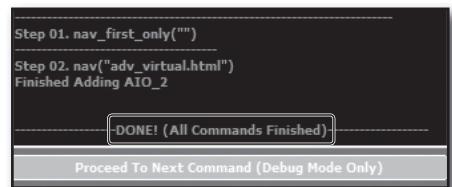
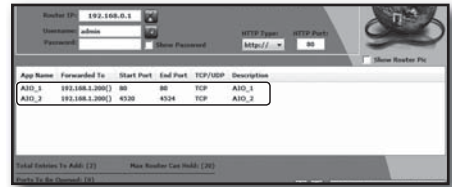

## DDNS

You can set the DDNS site for a remote user's network connection. Using the mouse may help make setup easier.

- Use the up/down buttons (▲▼) in **<Network>** window to move to **<DDNS>**, and press **[ENTER]** button.
- Use virtual keyboard to enter user inputs.
  - Refer to **"Using Virtual Keyboard"**. (Page 50)
- If selected **<OFF>** or **<iPOLiS>**, input fields are deactivated.
- If you select **<iPOLiS>**, the "DDNS Host Address" item will be displayed.
  - Type your set ID in **<Product ID>** field. More specific information is in **"iPOLiS DDNS Setting"**.
  - Select **<Use>** in **<Quick Connect>** menu. After finishing **"iPOLiS DDNS Setting"**, you can connect your DVR set with the address **<http://www.samsungipolis.com/HOMEDVR>**.
    - The router used should support uPNP Port Forwarding function.
    - Note that uPNP Port Forwarding does not support UDP protocol.
    - If the program fails to read uPNP Port Forwarding List, try again after restarting the computer and router.
- When the DDNS setup is done, press **<OK>**.

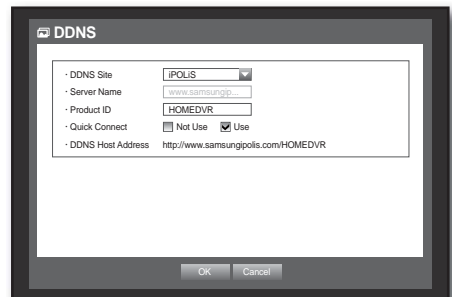

## DDNS Setting

DDNS is a short form of Dynamic Domain Naming System.

DNS (Domain Name System) is a service that routes a domain name consisting of user friendly characters (ex : www.google.com) to an IP address consisting of numbers (64.233.189.104).

DDNS (Dynamic DNS) is a service that registers a domain name and the floating IP address with the DDNS server so that the domain name can be routed to the IP address even if the IP is changed in a dynamic IP system.

### • Setting DDNS in the DVR

Set <Protocol Type> in the <Protocol> menu of the connected DVR to the following :

Ex) Protocol Type : TCP  
Port (TCP) : 4520~4524  
DDNS Site : iPOLiS

### ❖ iPOLiS DDNS Setting

1. Visit <http://www.samsungipolis.com> or <http://www.samsungipolis.co.kr> and click <LOGIN>.

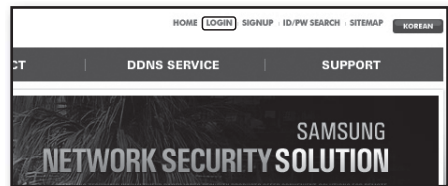

2. If you have ID & PASSWORD, insert them.  
Otherwise, click <SIGN UP> for a new account.

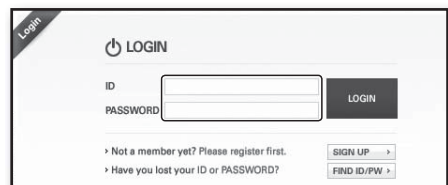

3. After log in, register your set with your information.



4. After registration, you can see the list as below.



5. Select <iPOLiS> and fill Server Name out with your registration information.

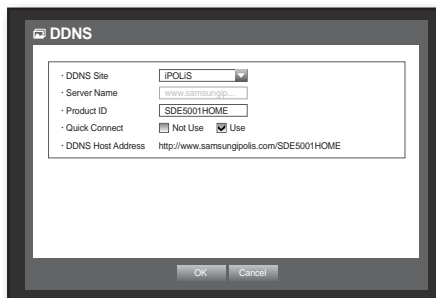

6. You can see <STATUS> changed to <ON> in 10 minutes, if all the network settings are right.



## Live Transfer

Sets the quality of the image that is transferred from the DVR to the network.

Using the mouse may help make setup easier.

1. In the <Network> setting window, press the up/down (▲▼) button to move to <Live Transfer> and press the [ENTER] button.  
The Live Transfer window appears.
2. Use the direction buttons (▲▼◀▶) to move to a desired item and set the value.
3. When the live transfer is done, press <OK>.
  - The resolution for real-time (live) transfer will be set to CIF(S). (Page 68)

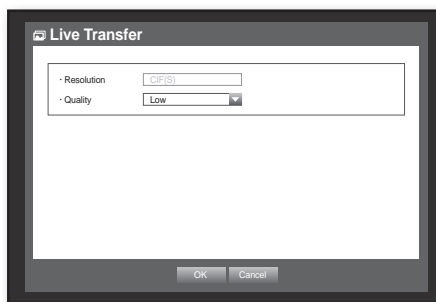

# main menu

## Mailing Service

You can send an e-mail to a DVR-registered user at a specific time interval, or if an event occurs.



- If an event occurs with a channel where the camera's video is set to <OFF> or the remaining recording count is set to <OFF>, only the text notification will be sent to the applicable email address.
- The e-mail receivers are not able to adjust the attached image quality.

## SMTP Setting

Sets the SMTP mail server.

Using the mouse may help make setup easier.

1. In the <Network> setting window, press the up/down (▲▼) button to move to <Mailing Service> and press the [ENTER] button.
2. Select <SMTP>.  
You will see the SMTP setting window.
3. Use direction buttons (▲▼◀▶) to move to a desired item and set the value.
  - ServerType : Displays the connected server type.
  - Server : Enter a server to connect to.
  - Port : Sets the communication port.
  - Use Authentication : Check this if the SMTP server uses user authentication. The account input box will be activated.
  - User : Enter a user to use authentication when connecting to the SMTP server.
  - Password : Enter the password of the SMTP server user.
  - Secure Transfer : Select one from <Never> and <TLS (if available)>.
  - Sender : Use the virtual keyboard to enter the sender's e-mail address.
    - Refer to "Using Virtual Keyboard". (Page 50)
  - TEST : Conducts the test on the server settings.
4. When the SMTP setting is done, press <OK>.



## Event Setting

You can set the interval and type of the event that will be sent to the user.

Using the mouse may help make setup easier.

- SDE-4003 and SDE-5003 Model don't support the function of Sensor detection.

1. In the <Network> setting window, press the up/down (▲▼) button to move to <Mailing Service> and press the [ENTER] button.

2. Select <Event>.

3. Use direction buttons (▲▼◀▶) to move to a desired item and set the value.

• Event Interval : Set the event interval.

- If a series of events occurs, the e-mail will be sent at the specified interval, not on each event.

• Use Event Transfer : Select an event type to send if an event occurs.

If the selected event occurs, the e-mail will be sent to the group that has the recipient authority.

4. When the event setting is done, press <OK>.

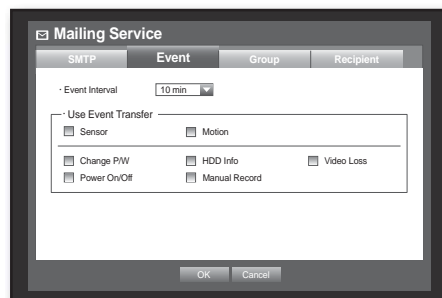

## Group Setting

You can set the group to whom the e-mail is sent, and specify the permission for each group.

You can add recipients for each group in the <Recipient> menu item.

The recipient is set separately from the DVR user group.

Using the mouse may help make setup easier.

- SDE-4003 and SDE-5003 Model don't support the function of Sensor detection.

1. In the <Network> setting window, press the up/down (▲▼) button to move to <Mailing Service> and press the [ENTER] button.

2. Select <Group>.

3. Use direction buttons (▲▼◀▶) to move to a desired item and set the value.

• Add : Select <Add> and use the virtual keyboard to add a group.

- Refer to "Using Virtual Keyboard". (Page 50)

• Delete : Deletes the selected group.

• Rename : You can reset the recipient permission of an existing group.

• Recipient Permission : Set the permission of the recipient group.

4. When the group setting is done, press <OK>.

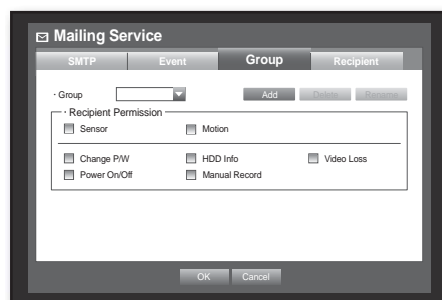

# main menu

## Recipient Setting

You can add/remove a recipient(s) to/from the specified group and edit the group if necessary.

Using the mouse may help make setup easier.

1. In the <Network> setting window, press the up/down (▲▼) button to move to <Mailing Service> and press the [ENTER] button.
2. Select <Recipient>.
3. Use direction buttons (▲▼◀▶) to move to a desired item and set the value.



- Add : You can select a recipient name, e-mail address or group.

You should have created a group in the <Group> menu item before you can add a user to the group.

- For inputting the recipient name and email address, refer to "Using Virtual Keyboard". (Page 50)

4. When the recipient setting is done, press <OK>.

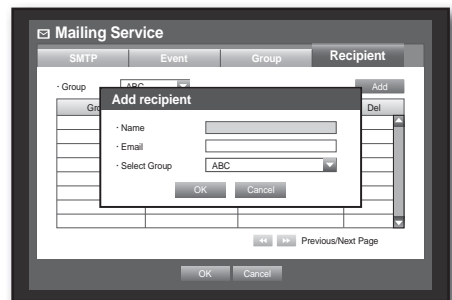



# search & play

## SEARCH

You can perform the search for recorded data by the time or by the search criteria such as an event. You can access the <Search> menu directly in Live mode.

1. In Live mode, right-click any area of the screen. The Live menu appears.
2. Select <Search>. Or, press the [SEARCH] button on the remote control or the front panel.



3. The Search menu appears.
4. The search can be restricted by the Auto Delete function. Refer to "Setting the Recording > Record Option". (Page 69)



- Overlapped data : It only appears if there exists overlapped data on a certain time, produced due to the change of DVR's time setup. The latest data comes first, from <List0>. It does not appear in <Backup Search>.



## Time Search

You can search for recorded data of a desired time.

As the time to display may be different depending on the time zone and the DST standard time, the time of data recorded in the same time can be displayed differently depending on time zone and DST settings.

Using the mouse may help make setup easier.

- SDE-4003 and SDE-5003 Model don't support the function of Sensor detection.

1. Select <Time Search> in the <Search> menu.
2. Select a date to search.
  - Refer to "Using the Calendar". (Page 49)
3. The record data on the specific date will be listed. The display bar is different according to the data type. So check the data type for the color in the left pane.
4. Use direction buttons (▲▼◀▶) to set the search criteria and press the [ENTER] button.
  - Go to First : Moves to the earliest date.
  - Go to Last : Moves to the most recent date.
  - Time : Enter a time to perform the search or use the up/down button <◆> to select one.

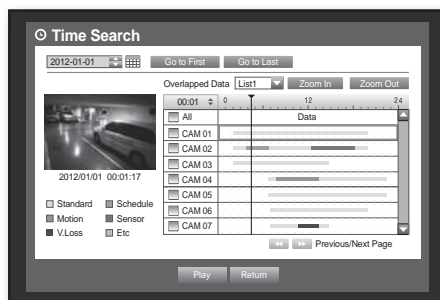

# search & play

- **Zoom In** : The map enlarges in detail.  
It will switch in the sequence of 24 hours - 16 hours - 8 hours - 4 hours.
- **Zoom Out** : The map will switch in the reverse order of the detailed mode above.  
It will switch in the sequence of 4 hours - 8 hours - 16 hours - 24 hours.



▪ Double-click a desired time to zoom it in/out.

- **Preview** : Click **<Channel>** and select (click, drag) a time in **<Duration>** to display a still image for the portion.
  - If the selected channel does not contain any recorded data, it will be marked black.
- 5. Select a data item and click **<Play>**.  
The screen switches to the data playback mode.



## Event Search

You can search for events by the channel and play them.  
Using the mouse may help make setup easier.

1. Select **<Event Search>** in the **<Search>** menu.
2. Use direction buttons (▲▼◀▶) to set the search criteria and press the **[ENTER]** button.
  - All record events on a specific date will be found. (Normal/ Schedule recording included)
- **Date/Time Preview** : If you select a data item in the list, the still image of the selected data will be displayed in the left preview pane.
- **Event** : Displays the type of the event that occurred.
3. Select a data item and click **<Play>**.  
The screen switches to the event data playback mode.

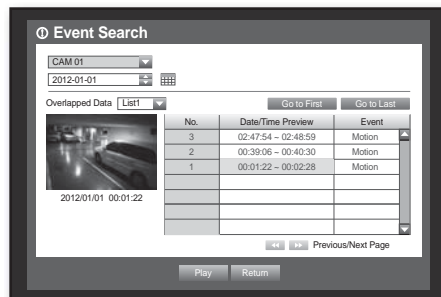

## Backup Search

Searches for backup data in the connected backup device.  
Only data in the format of DVR is included in the search.  
Refer to <Type> in “**Backup > Setting the Backup**”. (Page 74)  
Using the mouse may help make setup easier.

1. Select <Backup Search> in the <Search> menu.
2. Use direction buttons (▲▼◀▶) to set the search criteria and press the [ENTER] button.
  - Record Period : Displays the record period.
  - Channel info : Displays the recorded channel.
  - Play Start Time : Select a time that you start playing.
3. Select a data item and click <Play>.  
The screen switches to the backup data playback mode.

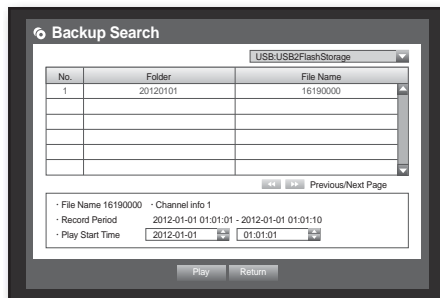

## Motion Search

If a motion is detected in each channel, you can set a desired area to perform the search.  
You can use the mouse to select the related items.

1. Select <Motion Search> in the <Search> menu.
  2. Use direction buttons (▲▼◀▶) to set the search criteria and press the [ENTER] button.
    - If you set the motion area to <Manual Area>, the <Setup> button will be activated.
  - Motion Region : Select an area to perform the search.
    - All Area : Searches for all areas of the selected channel.
    - Current Area : Searches for the motion area for each channel specified in “**Motion Detection > Setting the Motion Detection Area**”. (Page 72)
    - Manual Area : You can set the motion area manually.
  - Setup : The Setup button will be activated only if you have set the motion area to Manual. Press this button to display the area setting window.
  - Date/Time : The Date/Time will be automatically set by the hour, and the end time will be automatically set to one hour later than the start time if it is set.
  - Preview : Select a data item in the list to display the still image of the item.
3. Select a data item and click <Play>.  
The screen switches to the motion data playback mode.

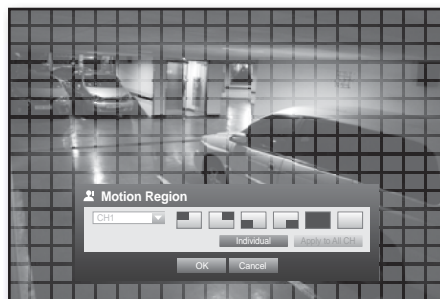
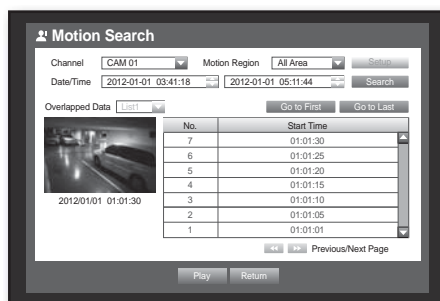



# search & play

## PLAYBACK

### Play

You can play data stored in the HDD and backup a desired portion of the data.



Using the mouse may help make setup easier.

1. In Live mode, click **<Play>** in the right-click menu or  in the launcher menu, or press the Play button on the remote control or the front panel.
2. Use the up/down button ( ) to select a menu.
  - For data search, refer to **<Search>**. (Page 89)



3. Select a data item and click **<Play>** in the Search menu. The selected data is played and the play launcher appears on the screen.
    - If there is an existing data, **<Play>** will start immediately without performing the search.
- Playback Information : Displays the date and time of the current data in the top corner.



- Backup : Click  to set the current time to the start time of backup; you can specify a backup area using the mouse (yellow triangle). Click  again to set the current time to the end time of the backup and the **"Backup Range"** window appears.

- Type : Supports formats of DVR and SEC. Refer to a list of formats in **"Setting the Backup"**. (Page 74)
- Device : Select a backup device.
- Check Capacity : Enables you to check the capacity of the selected storage device.

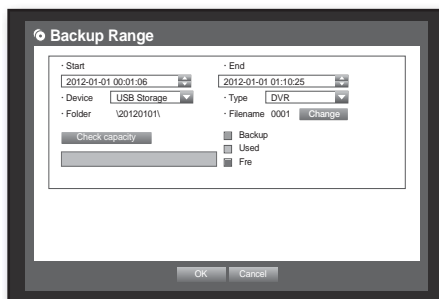

4. If you want to return to the Live screen in Play mode, click  in the launcher menu or press the  button on the remote control or the front panel.

## Using the Playback Button

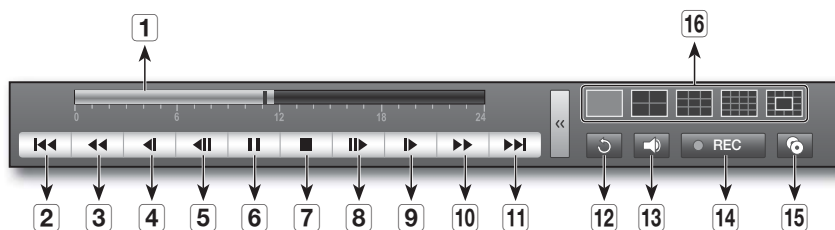

Part Names	Functions
<b>1</b> Play Timeline	Indicates the current playback point, and can be used to move.
<b>2</b> Skip Backward	Moves backward by unit time.
<b>3</b> Backward Fast Play	Used for quick backward playback.
<b>4</b> Backward Slow Play	Used for backward frame-by-frame search while in PAUSE.
<b>5</b> Step Backward	Moves backward by one frame at a time.
<b>6</b> Pause	Stops playing the current video temporarily.
<b>7</b> Stop	Stops playback and moves to the live screen.
<b>8</b> Step Forward	Moves forward by one frame at a time.
<b>9</b> Forward Slow Play	Play forward up to 4 channels simultaneously at a low speed. <ul style="list-style-type: none"> <li>▪ In a split mode, the real time playback may not be supported, depending on the record quality, resolution and number of channels. And some frame rates may be supported.</li> </ul>
<b>10</b> Forward Fast Play	Used for quick forward playback.
<b>11</b> Skip Forward	Moves forward by unit time.
<b>12</b> Return	Return to the search setup screen.
<b>13</b> Audio	Sets Audio ON/OFF. <ul style="list-style-type: none"> <li>▪ If using both web view and DVR set simultaneously, the audio signal will be output from the DVR set.</li> </ul>
<b>14</b> REC	Records all channels in Live mode.
<b>15</b> Partial Backup	Begins backup of the selected section of the video being played, with the specified starting/ending point.
<b>16</b> Mode Switch	Click a desired playback mode or press <b>[MODE]</b> to switch the screen mode in sequence. <ul style="list-style-type: none"> <li>▪ The gray area in the center of the 13-split mode plays the Live channel. The default channel of the Live mode is CH1, which can be changed later.</li> </ul>

# Web Viewer

## INTRODUCING WEB VIEWER

### What is Web Viewer?

Web Viewer allows remote access to your DVRs. You have access to live video, archived video etc.

### Product Features

- Remote access from a standard browser
- Supports 1, 4, 9, 16 camera viewing formats (maximum of 16 cameras in the list).
- Gets JPEG, BMP format images to print and save to “Print or Save JPEG, BMP format images”.
- Record video in AVI format-compatible with popular media players. (needed the H.264 codec)

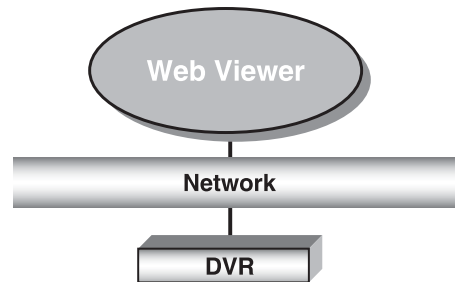

### System Requirements

The following lists the minimum suggested hardware and operating system requirements needed to run the Web Viewer.

<b>OS</b>	Windows XP Professional Windows 2000 Windows Vista Home Basic /Premium Windows 7 Safari 5.1.1 or later version
<b>Web Browser</b>	Internet Explorer 6.0.2900.2180 or later
<b>CPU</b>	Intel Pentium 4, 2GHz
<b>Memory</b>	512 MB
<b>Monitor</b>	High Color 16-bit 1024 x 768
<b>HDD</b>	50 MB(Installation space required) * Additional HDD space required for recording. Recorded file size will vary depending on recording quality settings.



- Even for computers of higher performance than recommended, you may experience frame skipping with the Web Viewer if the computer is overloaded showing more than 80% of CPU usage.

## CONNECTING WEB VIEWER (MAC)

### ❖ Safari on MAC.

If you want to use SDE-Series DVR Web Viewer with Safari Browser on a Mac, please refer to this user guide and install Multi Viewer with firmware upgrade if necessary.

- Brower versions available: Safari 5.1.1 or later version
  - Silverlight: 4.0.60831.0 or later
1. Click **[Click now to Install]** to display the installation screen as shown.



2. Double-click the **[Silverlight.pkg]** icon to display the Silverlight plug-in installation screen as shown.



3. Click **[Continue]** to start installing Silverlight plug-in. When done, you will see the screen as below.

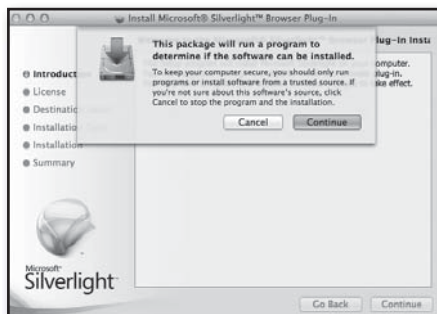

4. Click **[Close]** to exit from the Silverlight plug-in installation screen.

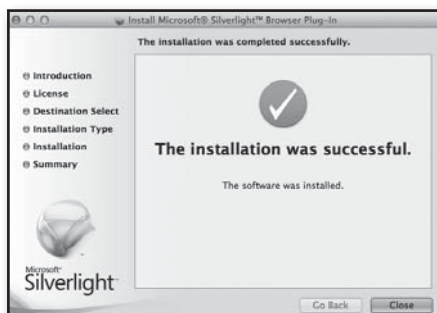

# Web Viewer

- If Microsoft Silverlight plug-in is already installed

1. Use a web browser to connect to the DVR.
2. If Silverlight plug-in is already installed, you will see the screen as shown.
3. If this is the case, perform Step 3 [TCP port & Web Viewer port settings] below.
4. If the screen above does not appear, check if the DVR set is connected properly with a valid IP address.

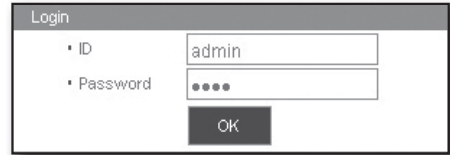

## USING LIVE VIEWER (MAC)

The Live Viewer screen consists of following :



- 1 This displays the IP address and the model name of the connected DVR.
- 2 These menus consist of <LIVE>, <ABOUT>.
- 3 These buttons are used for the screen split and full screen mode. (Max. : 9CH)
- 4 Shows the IP address and model name of the connected DVR.
- 5 Select to turn the sound on/off.
- 6 Select <DVR Time> or <PC Time> for the OSD time information display setting of the Live Viewer.
- 7 These buttons are used for sequence and changing the screen channel.
- 8 These buttons are used for capture, print, and save the image.  
When you can't play the file recorded in web, install the H.264 CODEC  
ex) MAC: perian\_1.2.3.dmg (<http://perian.org>)
- 9 Shows the channel of the connected DVR.
- 10 This displays the screen for connected camera with DVR.



## CONNECTING WEB VIEWER (WINDOWS)

1. Open your web browser and type the IP address or URL of DVR into the URL address box.



- The basic URL of the DVR is as following in case of MAC address :
- <http://www.samsungipolis.com/User ID>
  - You can also use registered URL which setups up in the Setup menu of your DVR.

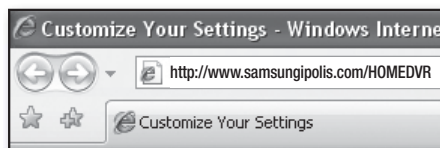

2. Set the Admin ID and password same to those of the DVR Admin.  
For general users, enter the DVR user ID and password.



- The default password can be exposed to a hacking thread so it is recommended to change the password after installing the product.  
Note that the security and other related issues caused by the unchanged password shall be responsible for the user.



- It allows up to 10 simultaneous access including the Admin and general users.
- It does not allow multiple login of the Admin user.
- Initial password of the Admin user is set to "4321".
- Password of the Admin and general users can be changed in <Permission Management> menu of the DVR.
- Normal users should have set <Viewer> under <Permission Management> to "Use" before connecting to the Web Viewer. (Page 53)
- All settings are applied by the DVR's settings.

3. Click <Install ActiveX Control...>.  
Downloading Active-X control may take several minutes according to the security settings on your PC.

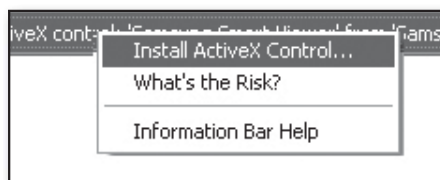

4. Click <Install>.



5. You may have "Windows Security Alert" that attempts to block this with the Windows Firewall. In that case, click <Unblock> to start Web Viewer.



6. Installation is complete.  
Now you can see the main screen of Live Viewer.

# Web Viewer

## USING LIVE VIEWER (WINDOWS)

The Live Viewer screen consists of following :



- 1 This displays the IP address and the model name of the connected DVR.
  - 2 These menus consist of <LIVE>, <SEARCH>, <SETUP>, <ABOUT>.
  - 3 These buttons are used for the screen split and full screen mode.
  - 4 Shows the IP address and model name of the connected DVR.
  - 5 Select to turn the sound on/off.  
Select the format of OSD information that will be displayed on Live Viewer.
  - 6 Select <DVR Time> or <PC Time> for the OSD time information display setting of the Live Viewer.
  - 7 These buttons are used for sequence and changing the screen channel.
  - 8 These buttons are used for capture, print, and save the image.
  - 9 Shows the channel of the connected DVR.
  - 10 This displays the screen for connected camera with DVR.
-  ■ The initial split-screen mode is set according to the number of channels connected to DVR.  
You can change the split-screen mode by clicking buttons for split-screen modes.

## OSD Information Display

- 1 The channel number, video size, and IP address of the connected DVR are displayed.
- 2 This icon will appear if the audio signal is currently being output.
- 3 The current date and time will be displayed according to the selected time information display setting <DVR Time> or <PC Time>.
- 4 Alarm icon appears when alarm is issued. It disappears when pressed the [ALARM] button of the DVR.
- 5 Motion icon appears when motion is detected. It disappears when pressed the [ALARM] button of the DVR.



## Split-Screen

You can change the split mode by clicking each number icon.

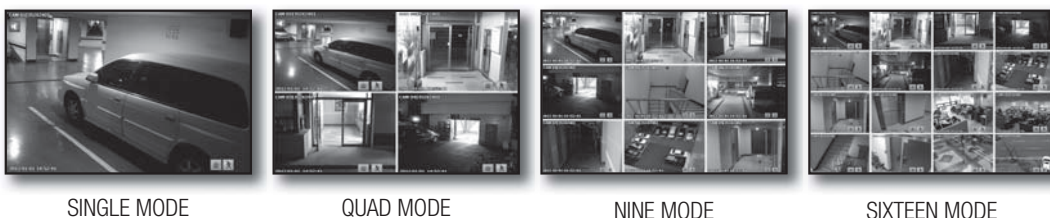

- Click <1> button.  
The screen displays the selected camera connected to the DVR in “**SINGLE MODE**”.
- Click <4> button.  
The screen displays the selected camera connected to the DVR in “**QUAD MODE**”.
- Click <9> button.  
The screen displays the selected camera connected to the DVR in “**NINE MODE**”.
- Click <16> button.  
The screen displays the selected camera connected to the DVR in “**SIXTEEN MODE**”.  
SDE-400X doesn't support 16-split screen mode.
- Click <Full Screen Mode Icon> button.  
The screen displays the selected camera connected to the DVR in “**FULL SCREEN MODE**”.  
Double clicking on the screen or pressing any button of the keyboard returns to the previous mode.



# Web Viewer

## Connected DVR

This displays the IP address and the status of the connecting DVR.



- Connection failure message

**No Response** : Appears when the DVR does not respond.

**Access Denied** : Appears when the maximum number of users is exceeded.

- The number of simultaneous connections are limited to 10.

## Setting the display of the OSD time information

Select <**DVR Time**> or <**PC Time**> for the OSD time information display setting.

- **DVR Time** : Based on the time of the connected DVR
- **PC Time** : Based on the time of the PC currently running the Web Viewer.
- **Audio** : Sound On/Off

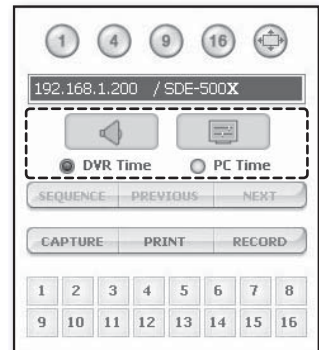

## Changing The Live Screen Mode

- 16-split mode does not support "SEQUENCE", "PREVIOUS" and "NEXT".

- **SEQUENCE** : When this button is clicked, screens are switched at a preset interval.

In SINGLE MODE, the channel numbers are sequentially switched from 1 to 16.

In QUAD MODE, the screens are changed like 1st 4 channels (1~4) → 2nd 4 channels (5~8) → 3rd 4 channels (9~12) → 4th 4 channels (13~16).

In NINE MODE, the screens are changed from 9 channels (1~9) to 7 channels (10~16).

- Preset interval (10 seconds)

- **PREVIOUS** : When this button is clicked, the previous screen appears.

In SINGLE MODE, the channel numbers are switched in reverse order.

In QUAD MODE, the screens are changed like 1st 4 channels (1~4) → 2nd 4 channels (13~16) → 3rd 4 channels (9~12) → 4th 4 channels (5~8). In NINE MODE, the screens are changed from 9 channels (1~9) to 7 channels (10~16).

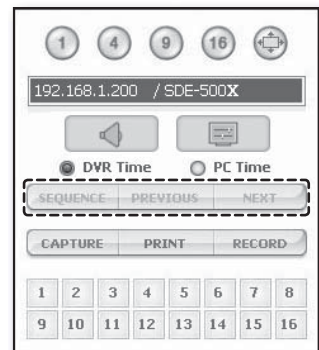

- **NEXT** : When this button is clicked, the next screen appears.  
 In SINGLE MODE, the channel numbers are sequentially switched from 1 to 16.  
 In QUAD MODE, the screens are changed like 1st 4 channels (1~4) → 2nd 4 channels (5~8)  
 → 3rd 4 channels (9~12) → 4th 4 channels (13~16).  
 In NINE MODE, the screens are changed from 9 channels (1~9) to 7 channels (10~16).
  - If 16-channel DVR is connected, clicking "NEXT" in QUAD MODE is to change the screen as shown in the picture.

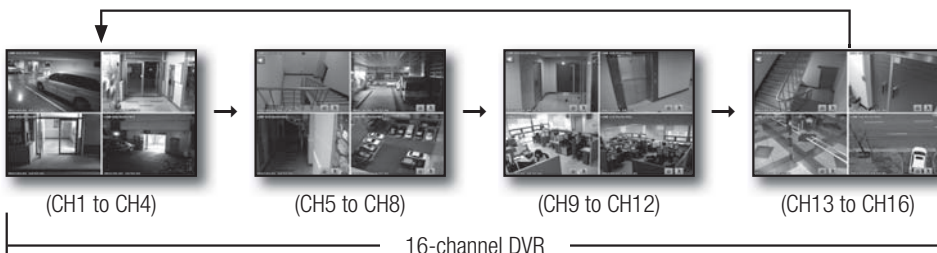

## Saving The Live Screen On The PC

- **CAPTURE** : Saves the current screen into a BMP or JPEG file.



- The default saving path is "C:\Program Files\Samsung\DVR Web Viewer\Snapshot\Live". To change the saving path, click <SAVE PATH (...)> button and then select the path you want. For Windows Vista, the saving path is "C:\users\user ID\AppData\LocalLow\Samsung\DVR Web Viewer\Snapshot" by default.

- The file is automatically named as following : "IP address\_Port number\_YYYYMMDD\_camera number\_index"  
 Ex) 192.168.1.200\_554\_20120101\_134132\_01\_00

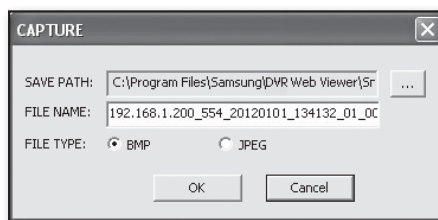

- **PRINT** : Prints out the selected screen out of the currently displayed live screens. It also prints the IP address, time, camera number and the current event status together.

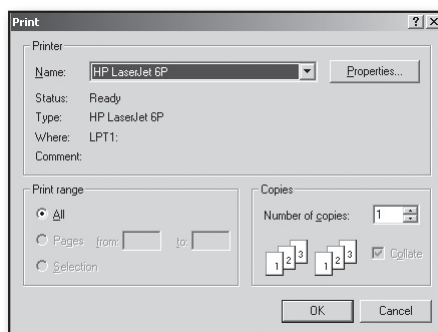

# Web Viewer

- **RECORD** : Saves the current image on the screen and saves it as a avi video file.



- To record it, it is required at least 1GB of available space.
- The default saving path is "C:\Program Files\Samsung\DVR Web Viewer\VideoClip\Live". To change the saving path, click <SAVE PATH (...)> button and then select the path you want. For Windows Vista, the saving path is "C:\users\user ID\AppData\Local-Low\Samsung\DVR Web Viewer\VideoClip".
- The file is automatically named as following : "IP address\_Port number\_YYYYMMDD\_camera number\_index"  
Ex) 192.168.1.200\_554\_20120101\_135105\_01\_00
- For AVI Save, you need the Xvid codec for playing saved files.
- HDD Minimum Free Size : During the recording, if there is no more capacity available in the HDD than set free space will prompt with a popup message : "**Cannot record due to insufficient disc space in the HDD**".

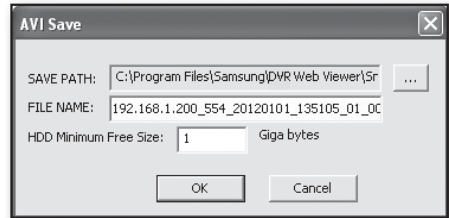

## Changing The Live Screen Channel

- Blue numbers : The channel connected to the current live screen
- Gray numbers : The channel not connected to the current live screen

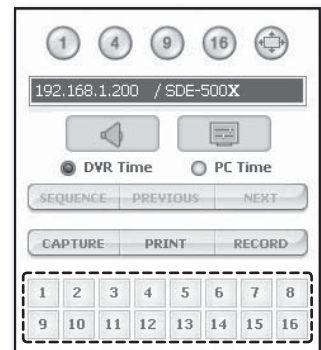

## USING SEARCH VIEWER

The Search Viewer screen consists of following :



- 1 This displays the IP address and the model name of the connected DVR.
- 2 These menus consist of <LIVE>, <SEARCH>, <SETUP>, <ABOUT>.
- 3 These buttons are used for the screen split and full screen mode.
- 4 Shows the IP address and model name of the connected DVR.
- 5 Select the format of OSD information that will be displayed on Live Viewer.
- 6 These buttons are used for capture, print, and save the image.
- 7 This displays a calendar at which you can search the recorded video.
- 8 The duplicate check list will appear If there are found duplicates in the same timeline. The duplicated items will be listed in latest-first order.
- 9 This displays a timeline at which you can search the recorded video by the time.
- 10 These buttons are used for controlling playback.
- 11 This displays the screen for playback of recorded video.



- <SEQUENCE>, <PREVIOUS>, <NEXT> buttons are not available in SEARCH menu.
- During the DVR backup, you may have a trouble accessing CMS & Web Search.
- Web Viewer on only Internet Explorer can support "Search" function.

# Web Viewer

## Split-Screen

You can change the split mode by clicking each number icon.



SINGLE MODE



QUAD MODE

- Click < 1 > button.  
The screen displays the selected camera connected to the DVR in "SINGLE MODE".
- Click < 4 > button.  
The screen displays the selected camera connected to the DVR in "QUAD MODE".



- Only SINGLE and QUAD MODE are available in SEARCH menu.

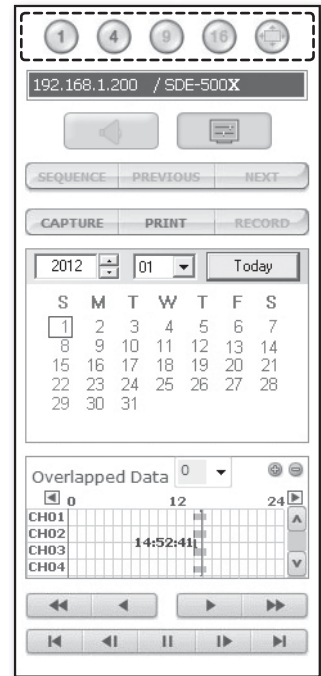

## Connected DVR

This displays the IP address and the status of the connecting DVR.



- Connection failure message  
**No Response** : Appears when the DVR does not respond.  
**Access Denied** : Appears when the maximum number of users is exceeded.
- The number of simultaneous connection is limited to 3.

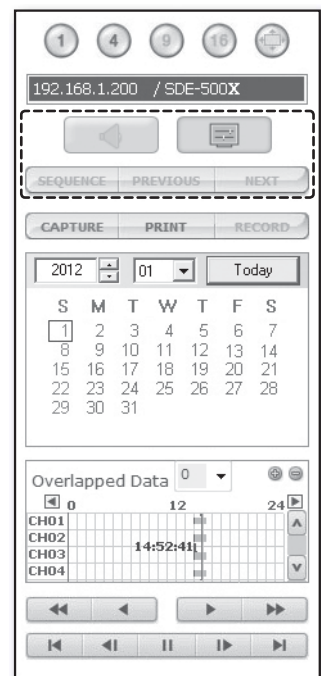



## Saving The Live Screen On The PC

- **CAPTURE** : Saves the current screen into a BMP or JPEG file.



- The default saving path is "C:\Program Files\Samsung\DVR Web Viewer\SnapShot\Search". To change the saving path, click <SAVE PATH (...)> button and then select the path you want. For Windows Vista, the saving path is "C:\users\ (user ID)\AppData\LocalLow\Samsung\DVR Web Viewer\ Snapshot".
- The file is automatically named as following : "IP address\_Port number\_YYYYMMDD\_camera number\_index"  
Ex) 192.168.1.200\_554\_20120101\_134132\_01\_00

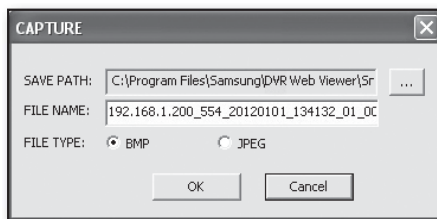

- **PRINT** : Print out the current screen. It also prints IP address, time, camera number and current event state.

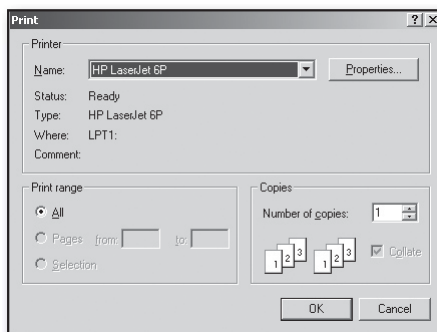

- **RECORD** : While in playback, press this button saves the video data of the selected channel as an AVI file. (It is saved in the designated folder on your PC.)  
To stop recording, click this button again.



- To record it, it is required at least 1GB of available space.
- The default saving path is "C:\Program Files\Samsung\DVR Web Viewer\VideoClip\Search". To change the saving path, click <SAVE PATH (...)> button and then select the path you want. For Windows Vista, the saving path is "C:\users\ (user ID)\AppData\LocalLow\Samsung\DVR Web Viewer\VideoClip\".
- The file is automatically named as following : "IP address\_Port number\_YYYYMMDD\_camera number\_index"  
Ex) 192.168.1.200\_554\_20120101\_135105\_01\_00
- For AVI save, you need the Xvid codec for playing saved files.

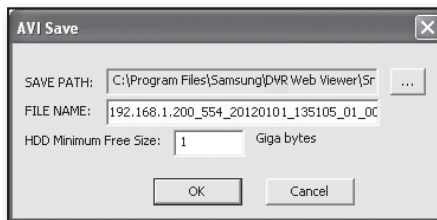

# Web Viewer

## Searching The Recorded Video In The Calendar

If the video data has been recorded on a date, the date is distinguished in green. If you click the date, the recorded video information is displayed in the time line. When you click <Today>, it will be synchronized with the system time (date) of the current PC.

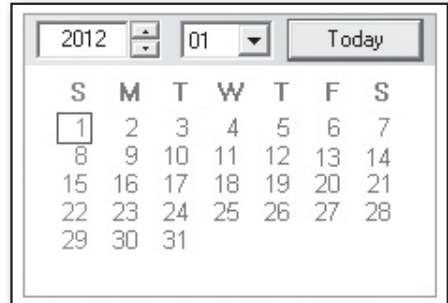

## Check duplicates

If there are found duplicates in the same timeline after you changed the DVR time, those duplicates will be listed in the <0> order with the latest one on top.

## Searching The Recorded Video In The Timeline

It displays the recorded video data status on the DVR after a date is selected. The normal mode displays the time ranging from 0 to 24 Hours while the extension mode displays the time every 2 hours.

[Normal Mode]

- If you click <+> button, it changes to the extension mode.
- Each time line represents 1 hour.

[Extension Mode]

- If you click <-> button, it changes to the normal mode.
- Each time line represents 5 minutes.



- For SDE-500X, channels are ranging from CH01 to CH16.  
For SDE-400X, channels are ranging from CH01 to CH08.

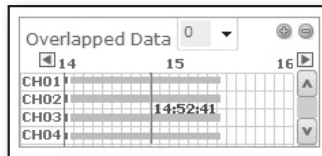
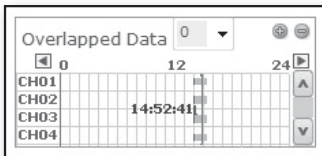
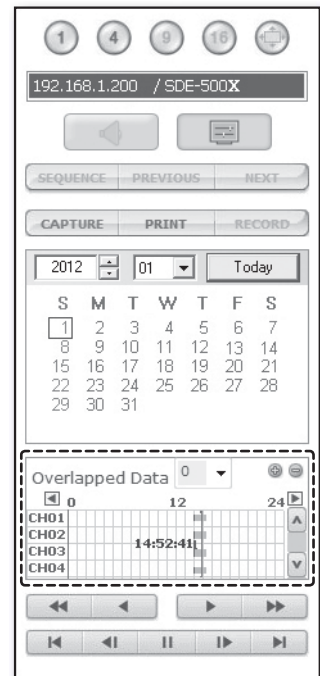

## Controlling Playback

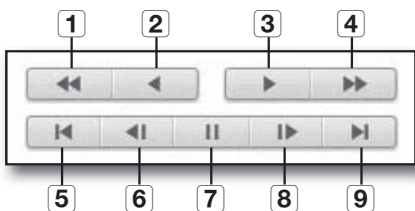

- 1 **Fast Backward** : Reverse-plays faster(2x~64x).
- 2 **Reverse Play** : Performs Reverse Play.
- 3 **Play** : Performs playback.
- 4 **Fast Forward** : Plays faster(2x~64x).
- 5 **Go to First** : Moves the beginning time of recorded video in the time line.
- 6 **Step Backward** : Performs one step reverseplay by one frame.
- 7 **Pause** : Stops the playback temporarily.
- 8 **Step Forward** : Performs one step forward by one frame.
- 9 **Go to Last** : Moves the last time of recorded video in the time line.



- Only the admin account can play the audio signal during the playback. If using both web view and DVR set simultaneously, the audio signal will be output from the DVR set.

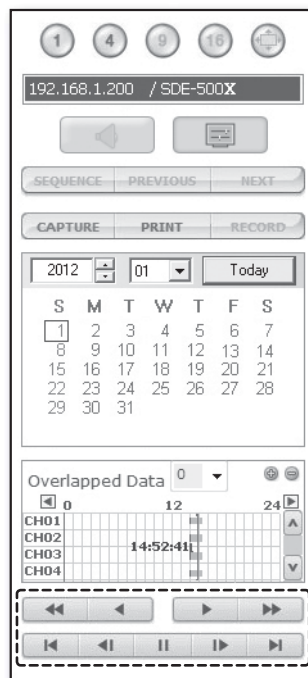

## VIEWER SETUP

You can configure the DVR settings remotely on the network.

To configure the DVR settings, click <Setup>.

### System

You can configure the various settings of the DVR system.

### Date/Time/Language

For more information, refer to <Date/Time/Language> in the <System Setup> menu. (Page 47)

1. Select <Date/Time/Language> in the System menu.
2. Configure the DVR settings according to your system environment.

#### • Date/Time

Set the date and time.



# Web Viewer

- **Time Synchronization Setup**

Set the time synchronization.

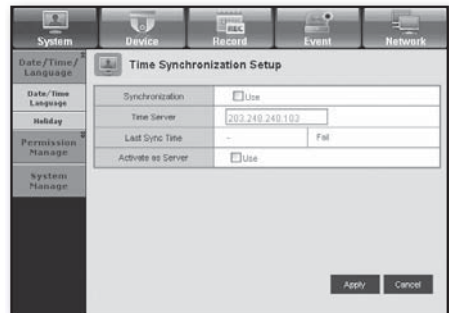

- **Display**

Date Format : Set the date type.

Time : Select a time format to display on the screen.

- **DST (Daylight Saving Time)**

DST is displayed an hour ahead of the standard time of the time zone.

- **Language**

Select a preferred language for the DVR.



## Holiday

You can set specific dates to Holidays according to your preferences.

For more information, refer to <Setting Holiday> in the <System Setup> menu. (Page 49)

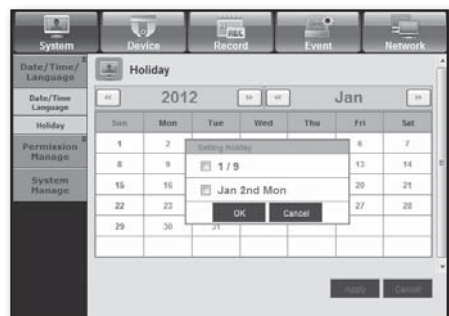

## Permission Management

For more information, refer to <Permission Management> in the <System Setup> menu. (Page 50)

- **Admin**

You can change the admin ID or the password.

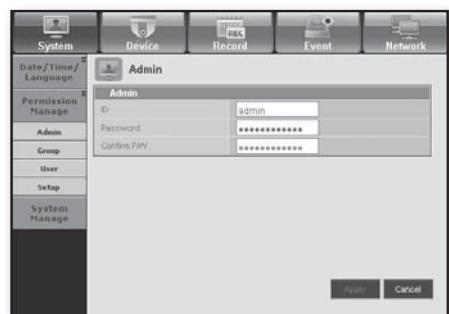

• **Group**

Users are classified into groups and the permission can be set according to the group.

- First of all, add a group.

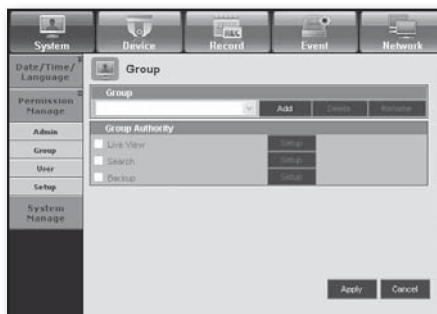

• **User**

You can add, change or remove a user or users.

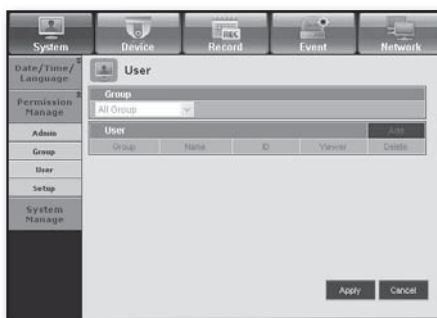

• **Setup**

You can set the user permission.

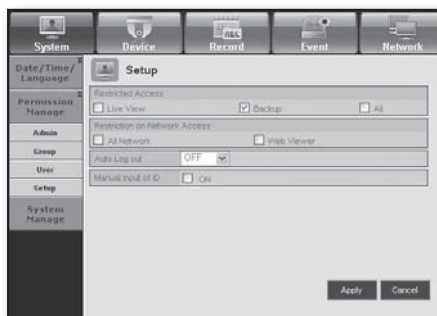

**System Management**

For more information, refer to <System Management> in the <System Setup> menu. (Page 55)

• **System Information**

You can see information of the current system. Check the Software Version, Broadcast Format and MAC Address.

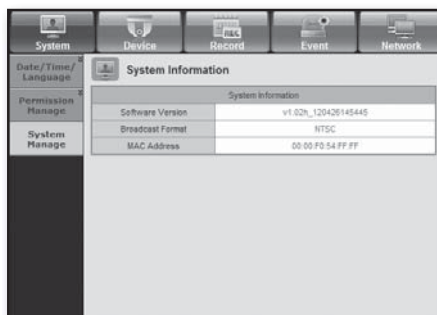

# Web Viewer

## Device

You can check a list of devices that are connected to the DVR and configure the necessary settings. Click **<Device>** in the menu screen.

For more information, refer to "**Setting the Device**". (Page 59)

## Camera

### • Camera

You can configure the settings of the camera that is connected to the DVR.



### • Privacy Region

You can specify a certain area of the camera video to be protected for your privacy.

- The **<Privacy Region>** is supported by SDE-4003/5003 only.

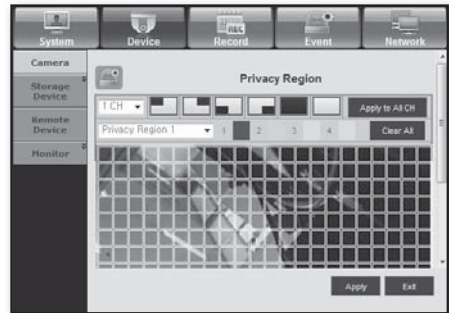

## Storage Device

You can check and change the settings of the storage device.

- **Device**

You will see a list of storage devices that are connected to the DVR.

You can check the type, used/total, usage and status of the device.



- **HDD Alarm**

You can set the alarm output channel and the alarm duration for an error.



## Remote Device

Specify the use of remote control and the remote control ID so that you can synchronize with the DVR.

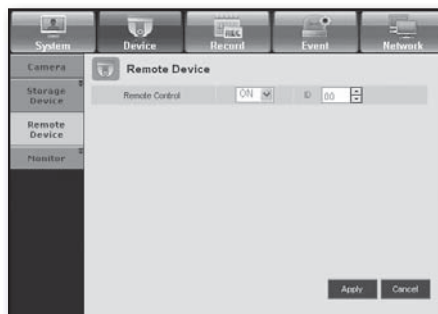

# Web Viewer

## Monitor

- **Monitor**

You can configure the monitoring screen settings and set the output system.

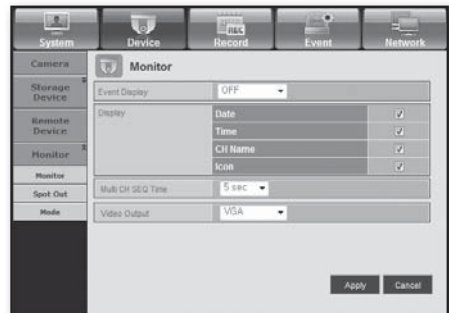

- **Spot Out**

With the monitor connected via the SPOT port, if there occurs an event such as Sensor, Motion, or Alarm, you can select a video output mode for external monitoring.

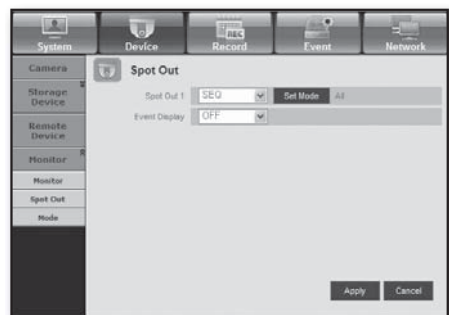

- **Mode**

You can switch between live mode and play mode.

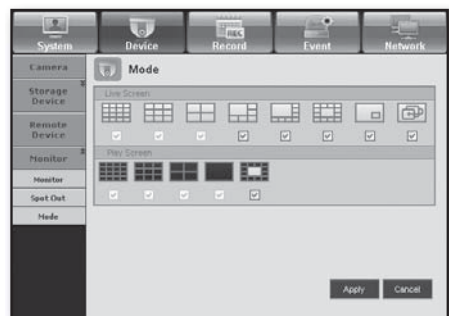



## Record

For more information, refer to “Setting the Recording”. (Page 66)

### Recording Schedule

If you set a recording schedule for a specific date and time, the recording will start at that specific time.

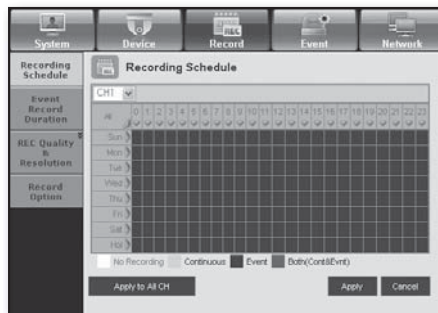

- Apply to All CH : Click <Apply to All CH> to display the confirmation window.

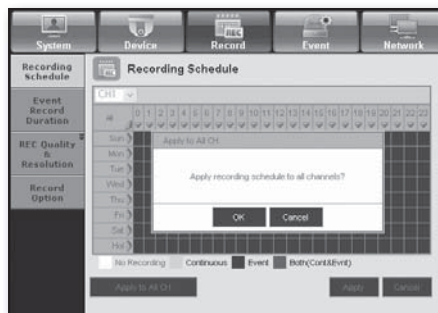

### Event Record Duration

You can set the start and end times of recording that will be activated if an event occurs.

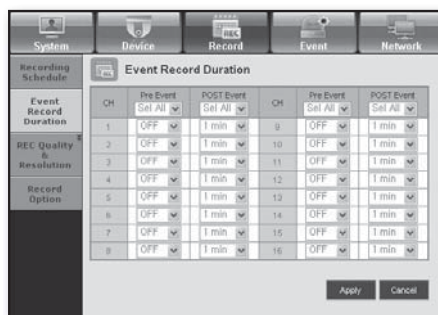

# Web Viewer

## REC Quality & Resolution

### • Standard/Event

You can set the resolution, frame rate and recording quality for each channel.



## Record Option

You can set the Disk End Mode.

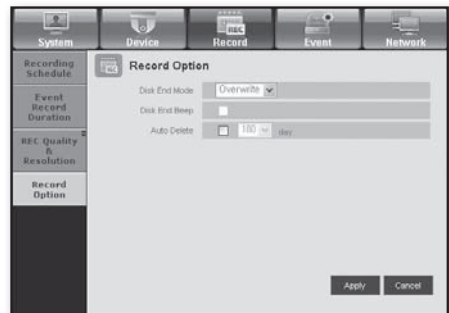

## Event

For more information, refer to "Setting the Event". (Page 70)

- Setting the <Sensor Detection> is not supported by SDE-4003/5003.

## Sensor Detection

You can set the sensor operation mode and the synchronized camera as well as the alarm output type and the duration.



## Motion Detection

You can set the motion detection mode and the sensitivity as well as the alarm output type and the duration.

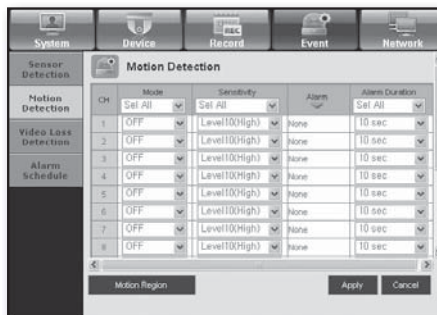

- **Motion Region**

Set the target motion detection area



## Video Loss Detection

You can set the alarm output time if a video loss occurs.

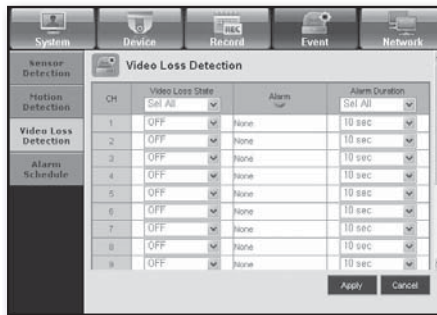

## Alarm Schedule

You can schedule the alarm output according to the day of the week and the time.

The default setting is Event Sync, which activates the alarm only if an event occurs.

- It is not supported by SDE-4003/5003.

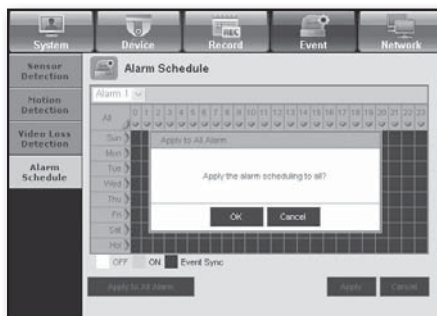

# Web Viewer

## Network

For more information, refer to “**Network Configuration**”. (Page 75)

### Connection

A remote user can access the DVR via the network to check the current mode and the IP address.

- **Connection**

You can set the network connection route.

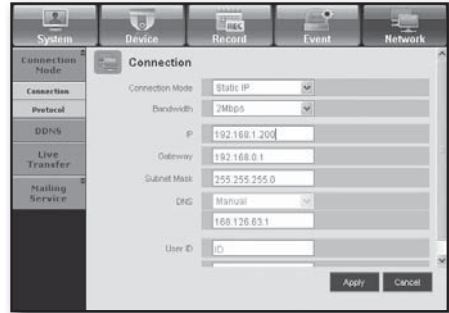

- **Protocol**

You can configure the protocol related settings.

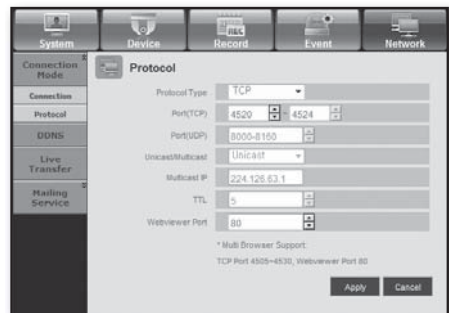

### DDNS

You can check the DDNS settings.

- If you select <iPOLiS>, the “DDNS Host Address” item will be displayed.

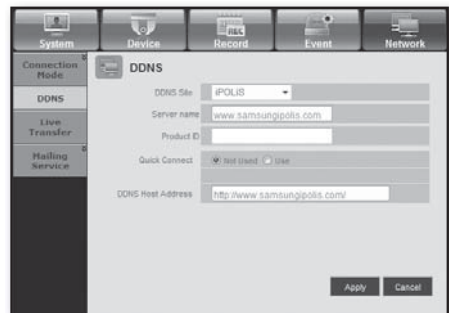

## Live Transfer

A remote user can set the images of the DVR.

- **Live Transfer**

A remote user can set the image resolution of the transferred data.

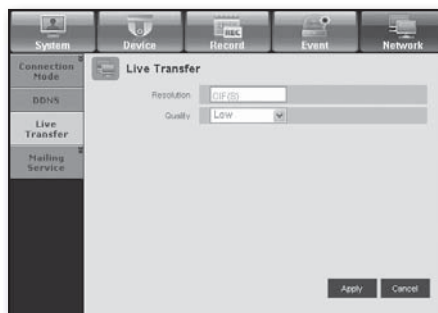

## Mailing Service

You can specify the SMTP server that sends a mail if an event occurs and set the recipient group and users.

- **SMTP**

You can set the server that sends mails and specify if you use the authentication process.



- **Event**

You can set the event interval and specify which events the server sends mails for.

- SDE-4003 and SDE-5003 Model don't support the function of Sensor detection.

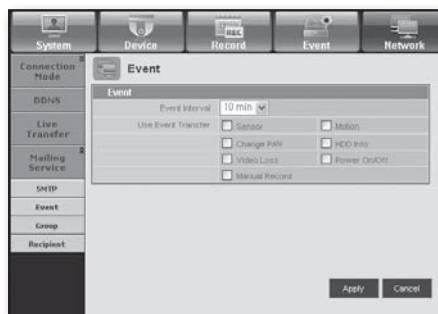

# Web Viewer

- **Group**

You can add a group to receive the mail if an event occurs and set the permission to receive the event mail for each group.

- SDE-4003 and SDE-5003 Model don't support the function of Sensor detection.

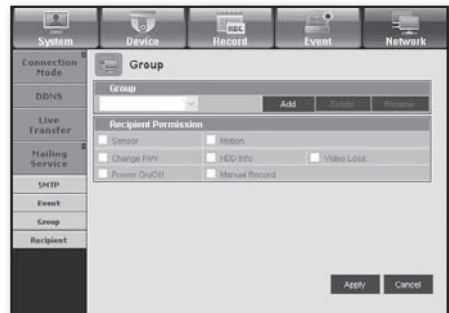

- **Recipient**

You can add a user or users who will receive the mail.

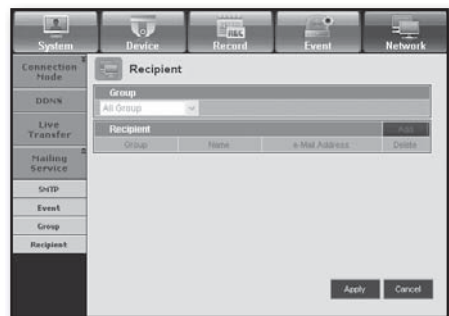

## ABOUT

Click <ABOUT>.

Displays the model name of connected DVR and the version of Web Viewer.

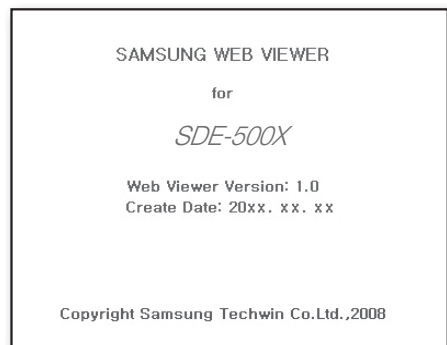

# MOBILE VIEWER

## What is Mobile Viewer?

iPOLIS mobile is smartphone application that enables you to connect to DVR (Digital Video Recorder) remotely and control the video playback and PTZ operations (if configured) in real time.

## Using a Smartphone

1. Download iPOLiS mobile to your Smartphone.
  - iPhone : App Store, Android: Android Market
2. From the start screen of iPOLiS mobile, tap <Device List>. The Add Device screen appears.

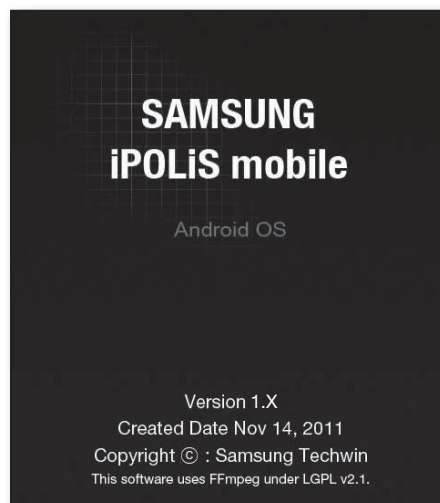

3. Register the DVR to the iPOLiS mobile.

## Key Features

- Remote access via Smartphone
- 1-split and 4-split modes supported in Live Viewer (However, search is not available).
- Switch channels using the touch-sensitive LCD panel
- Up to 4 channels supported
- Audio (wifi : O, 3G : X)

## Compatible Smartphone

This application is optimized for

- iPhone OS v4.3.5
- Android v2.2/2.3 (Galaxy S/S2 recommended)



- Refer to your DVR Setting for HTTP and RTSP Port Setting. Mobile Viewer uses the last value of the RTSP port numbers you registered in your DVR.  
Ex) HTTP: 80, RTSP 4250-4254  
For more information refer to "Setting the Protocol". (Page 76)

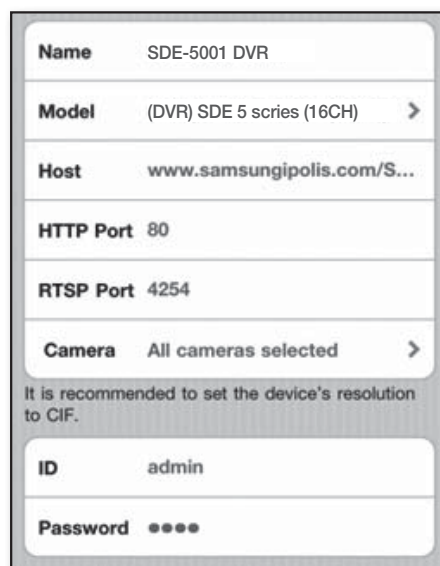

<The picture is taken from iPhone>

# backup viewer

## SEC BACKUP VIEWER

You can play a file that is backed up in the format of SEC.

Backup in the format of SEC will involve in generating two files: one for the backup data and one for the viewer.

If you run the backup file viewer, the backup data file will be automatically played.

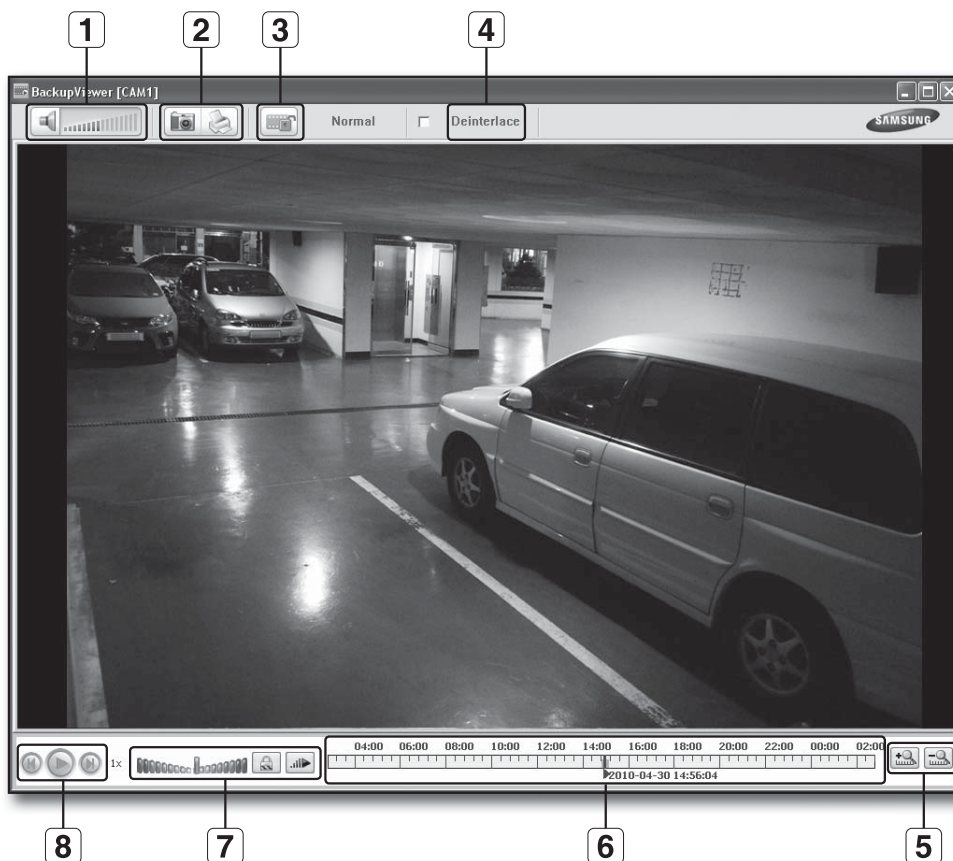













### Recommended System Requirements

PCs with a lower specification than the recommended below may not fully support forward/backward and high-speed playback.



- OS : Windows XP professional, Windows Vista, Windows 7 (It is not supported by MAC OS.)
- CPU : Intel Core2-Duo 2.4GHz or higher
- RAM : DDR PC-3200 1G or more
- VGA : Geforce 6200 or higher



Name		Description
1	Audio	 /  A toggle button. Each time you press this button, the audio output will toggle between activated and deactivated.
		 You can adjust the volume level from 0 to 100.
2	Screen Printout	 Saves the current screen as an image file. Supported file formats include BMP and JPEG.
		 Prints out the current screen. You should have installed the appropriate printer driver before you can print out the screen.
3	File Tamper Detection	 /  A toggle button. Each time you press this button, it will toggle between activated and deactivated. The closed lock icon indicates activation of the file tamper detection, which will blink the screen three times and stop playing if an unauthorized manipulation of a data file is detected. <ul style="list-style-type: none"> <li>■ A message of "The file is forged" will display in the menu bar.</li> </ul>
4	Deinterlace	You can enable the De-interlace function.
5	Zoom In/Out	 Collapses the time range that is displayed on the range bar of the storage time. You can collapse the range bar until the overall range is shortened to 24 hours.
		 Enlarges the time range that is displayed on the range bar of the storage time. You can enlarge the range bar until the overall range is extended to 1 minute.
6	Display of storage time range	Displays the time range of a stored video file. You can move the gridline of the range bar to select a time point to play.
7	Speed	 A toggle button; each time you press this button, the "Slow Playback" icon changes its color to display it's activated/deactivated. If it is activated, you can use the play speed control to adjust the play speed up to x1/16 forward and backward respectively, whereas if deactivated, you can adjust up to x16 forward and backward.
		 A toggle button; each time you press this button, the "Lock Speed" icon changes its color to display it's activated/deactivated. If activated, the adjusted speed will be kept even if you release the mouse on the speed bar. If deactivated, the adjusted speed will be applied only while you use the mouse to hold the adjusted speed, and if you release the mouse, the speed will restore to x1.
		 You can adjust the play speed up to x16 forward and backward respectively, which varies according to the frame rate per second of the source. Fast playback maximum is limited to x2 for footages recorded at 20 ~ 30 fps (frames per second), x4 for 11 ~ 19 fps, x8 for 6 ~ 10 fps, and x16 for footages recorded at slower than 6 fps.

# backup viewer

---

Name		Description
8	Play	 Displays the next frame. This is available only if the playback is stopped.
		 A toggle button. Press it once to start playing the video and switch the button mode to 'Pause', and press it again to switch the button mode to Play and stop playing temporarily.
		 Displays the previous frame. This is available only if the playback is stopped.

# appendix

## PRODUCT SPECIFICATION (CAMERA)

### ❖ SED-1001R / SED-1005 / SED-1007R

Item	Details					
	SED-1001R N	SED-1001R P	SEB-1005R N	SEB-1005R P	SEB-1007R N	SEB-1007R P
<b>Electrical</b>						
Input Voltage	DC 12V(by UTP)					
Power Consumption	2.2W		2.6W		2.6W	
<b>Video</b>						
Imaging Device	MT9V138					
Total Pixels	680 x 512					
Scanning System	Interface					
Synchronization	Internal					
Frequency	H: 15,734 Hz	H: 15,625 Hz	H: 15,734 Hz	H : 15,625 Hz	H: 15,734 Hz	H : 15,625 Hz
	V: 59.94 Hz	V: 50 Hz	V: 59.94 Hz	V : 50 Hz	V: 59.94 Hz	V : 50 Hz
Horizontal Resolution	520TVL					
Min. Illumination	0Lux (IR-LED)					
S/N Ratio (Y Signal)	46dB					
UTP	Built-in UTP TX					
	Maximum Transmission Length: 200m (UTP CAT 5e, all of 8 pins are used)					
	Balanced Differential Impedance: 100 ohm					
<b>Lens</b>						
Focus Length	3.6mm					
Max.Aperture Ratio	2					
Angular Field of View	H: 56°					
	V: 42°					
<b>Operational</b>						
Shutter Mode	Auto (Rolling Shutter)					
Gain Control	Auto					
White Balance	Auto (3200°K~6500°K)					
Digital Noise Reduction	Auto					
Day & Night	Auto					
Night-Visibility	10m(12EA)		15m (20EA)		15m (20EA)	

# appendix

---

Item	Details					
	SED-1001R N	SED-1001R P	SEB-1005R N	SEB-1005R P	SEB-1007R N	SEB-1007R P
<b>Environmental</b>						
Operating Temperature/ Humidity	0°C ~ +40°C (+32°F ~ +104°F) / 20% ~ 85% RH					
<b>Mechanical</b>						
Dimension (W X H X D)	W102 X H71.7 mm		W65.5 X H65.5 X D94.6 mm (2.58 X 2.58 X 3.72 inch)		W59.1 X H59.1 X D72 mm (2.33 X 2.33 X 2.83 inch)	
Weight	170g		315g		115g	

❖ SEB-1020R

Item	Details	
	SEB-1020R N	SEB-1020R P
<b>Electrical</b>		
Input Voltage	DC 12V	
Power Consumption	3W	
<b>Video</b>		
Imaging Device	1/3.6" OV7959 Color CMOS	
Active Pixels	NTSC: 648(H) x 488(V), PAL: 668(H) x 528(V)	
Scanning System	Interlace	
Synchronization	Internal	
Frequency	H : 15,734 Hz	H : 15,625 Hz
	V : 59.94 Hz	V : 50 Hz
Horizontal Resolution	480TVL	
Min. Illumination	0Lux (IR-LED)	
S/N Ratio (Y Signal)	46dB	
<b>Lens</b>		
Focus Length	3.6mm	
Max.Aperture Ratio	2	
Angular Field of View	H: 67°	
	V: 53°	
<b>Operational</b>		
Shutter Mode	Auto (Rolling Shutter)	
Gain Control	Auto	
White Balance	Auto (3200°K~6500°K)	
Digital Noise Reduction	Auto	
Day & Night	Auto	
IR Distance	15m	
<b>Environmental</b>		
Operating Temperature/ Humidity	0°C ~ +40°C (+32°F ~ +104°F) / 20% ~ 85% RH	
<b>Mechanical</b>		
Dimension (W X H X L)	W64 X H63 X L86 mm (2.52 X 2.48 X 3.39 inch)	
Weight	0.30Kg	

## PRODUCT SPECIFICATION

### ❖ SDE-4001/4004/4005

Item		Details		
		SDE-4001	SDE-4004	SDE-4005
Video	Inputs	8 UTP Line(CH1~CH8), BNC 2 ports(CH1, CH2)		
	Resolution	704x480 NTSC, 704x576 PAL		
Live	Frame rate	30fps NTSC, 25fps PAL		
	Resolution	704x480 NTSC, 704x576 PAL		
	Multi Screen display	1, 4, 6, 8, 9, 13, PIP, Sequence		
<b>Performance</b>				
Operating System	Embedded	Linux		
Recording	Compression	H.264		
	Record Rate	NTSC: Up to 60fps @ 704x480 / PAL: Up to 50fps @ 704x576		
		NTSC: Up to 120fps @ 704x240 / PAL: Up to 100fps @ 704x288		
		NTSC: Up to 240fps @ 352x240 / PAL: Up to 200fps @ 352x288		
	Mode	Manual, Schedule, Event		
	Overwrite modes	Continuous		
Pre-event	Off/5sec			
Post-event	- Off/5/10/20/30sec - 1/3/5/10/20min, 1/2/3/4/5/6 hour			
Search & Playback	Search mode	Date/time, Event, Backup, Motion (※ All Search contains the Preview function)		
	Playback function	Fast Forward/Backward, Slow Forward/Backward, Step Forward/Backward		
Network	Transmission speed	NTSC:120fps, PAL:100fps		
	Stream	H.264(CIF)		
	Maximum No. of remote users	Search(2) / Live Unicast(10) / Live Multicast(10)		
	Protocol support	TCP/IP, DHCP, PPPoE, SMTP, NTP, HTTP, DDNS, RTP, RTSP		
	Monitoring	Smart viewer, Webviewer, Mobile Viewer		

Item		Details		
		SDE-4001	SDE-4004	SDE-4005
Storage	Internal HDD	NTSC : 1TB SATA HDD PAL : 500GB SATA HDD		NTSC : 500GB SATA HDD
	External HDD	-		
	DVD Writer (Back-up)	-		
	USB (Back-up)	2 USB Ports		
	File Format (Back-up)	BU(DVR Player), SEC(Include Player)		
Security	Password Protection	1Admin, 10 Group, 10 User per 1 Group, User can be assigned authority for function		
	Data Authentication	Watermark (Only supports in SEC backup viewer)		
<b>Interface</b>				
Monitors	VGA	Analog RGB 1024x768 resolution(BNC or VGA selected in booting.)		
	HDMI	-		
	Main Composite	BNC, 1 Vp-p, 75 ohm		
	Spot Composite	-		
	Loop Outputs	-		
Audio	Inputs/Output	8 UTP Line(CH1 ~CH8), 2 Port RCA(CH1, CH2) / 1 line out		
	Compression	G.711		
	Sampling rate	8KHz		
Alarm	Inputs/Outputs	Terminal 4 inputs (NO/NC) / Terminal 1 relay outputs, Rating: 30V DC/2A, 125V AC/0.5A		
	Remote notification	Notification via e-mail		
Connections	Ethernet	1 RJ-45 10/100 Base-T		
	Serial interface	-		
	USB	USB 2.0, 2 ports		
	e-SATA	-		
	Application Support	Mouse, Remote Controller		
	Protocol support	-		
	PTZ	-		

# appendix

Item	Details			
	SDE-4001	SDE-4004	SDE-4005	
<b>General</b>				
Electrical	Input Voltage/Current	100 ~ 240 VAC ±10%; 50/60 Hz, Autoranging		
	Power consumption	ADP-4812 Adaptor (2EA), 12V, 48W+48W		
Environmental	Operating Temperature/ Humidity	0°C ~ +40°C (+32°F ~ +104°F) / 20% ~ 85%RH		
Mechanical	Dimension (W X H X D)	W350 X H44 X D300mm (13.98 X 1.73 X 11.81 inch)		
	Weight (With hard disks)	NTSC: 2.75Kg / PAL: 2.56Kg	NTSC: 2.75Kg	NTSC: 2.56Kg
	Gross weight	NTSC: 11.6Kg / PAL: 9.2Kg	NTSC: 8.8Kg	NTSC: 9.7Kg
	Box Size (Outer)	<b>❖ SDE-4001/4005</b> NTSC: W497 X H402 X D288mm / PAL: W497 X H402 X D213mm (NTSC: 19.57x15.83x11.34 inch / PAL: 19.57x15.83x8.39 inch) <b>❖ SDE-4004</b> NTSC: W497 X H402 X D213mm (19.57x15.83x8.39 inch)		
	Box Size (Inner)	<b>❖ SDE-4001/4005</b> NTSC: W487 X H392 X D270mm / PAL: 487 X H392 X D198mm (NTSC: 19.17x15.43x10.63 inch / PAL: 19.17x15.43x7.80 inch) <b>❖ SDE-4004</b> NTSC: W487 X H392 X D195mm (19.17x15.43x7.68 inch)		
Lauguage	English, Spanish, French, German, Italian, Polish, Portuguese, Russian, Turkish, Japanese, Czech, Swedish, Danish, Korean, Chinese, Netherland, Thai, Romanian, Serbian, Croatian, Hungarian, Greek			



❖ SDE-5001/5002

Item		Details	
		SDE-5001	SDE-5002
Video	Inputs	16 UTP Line(CH1~CH16), BNC 2 ports(CH1, CH2)	
	Resolution	704x480	
Live	Frame rate	30fps	
	Resolution	704x480	
	Multi Screen display	1, 4, 6, 8, 9, 13, 16, PIP, Sequence	
<b>Performance</b>			
Operating System	Embedded	Linux	
Recording	Compression	H.264	
	Record Rate	Up to 120fps@ 704x480	
		Up to 240fps @ 704x240	
		Up to 480fps @ 352x240	
	Mode	Manual, Schedule, Event	
	Overwrite modes	Continuous	
Pre-event	Off/5sec		
Post-event	- Off/5/10/20/30sec - 1/3/5/10/20min, 1/2/3/4/5/6 hour		
Search & Playback	Search mode	Date/time, Event, Backup, Motion (※ All Search Included Prview Function)	
	Playback function	Fast Forward/Backward, Slow Forward/Backward, Step Forward/Backward	
Network	Transmission speed	120fps	
	Stream	H.264(CIF)	
	Maximum No. of remote users	Search(2) / Live Unicast(10) / Live Multicast(10)	
	Protocol support	TCP/IP, DHCP, PPPoE, SMTP, NTP, HTTP, DDNS, RTP, RTSP	
	Monitoring	Smart viewer, Webviewer, Mobile Viewer	

# appendix

Item		Details	
		SDE-5001	SDE-5002
Storage	Internal HDD	1TB SATA HDD	
	External HDD	-	
	DVD Writer (Back-up)	-	
	USB (Back-up)	2 USB Ports	
	File Format (Back-up)	BU(DVR Player), SEC(Include Player)	
Security	Password Protection	1Admin, 10 Group, 10 User per 1 Group, User can be assigned authority for function	
	Data Authentication	Watermark (Only supports in SEC backup viewer)	
<b>Interface</b>			
Monitors	VGA	Analog RGB 1024x768 resolution(BNC or VGA selected in booting.)	
	HDMI	-	
	Main Composite	BNC, 1 Vp-p, 75 ohm	
	Spot Composite	-	
	Loop Outputs	-	
Audio	Inputs/Output	16 UTP Line(CH1~CH16), 2 Port RCA(CH1, CH2) / 1 line out	
	Compression	G.711	
	Sampling rate	8KHz	
Alarm	Inputs/Outputs	Terminal 4 inputs (NO/NC) / Terminal 1 relay outputs, Rating: 30V DC/2A, 125V AC/0.5A	
	Remote notification	Notification via e-mail	
Connections	Ethernet	1 RJ-45 10/100 Base-T	
	Serial interface	-	
	USB	USB 2.0, 2 ports	
	e-SATA	-	
	Application Support	Mouse, Remote Controller	
	Protocol support	-	

Item	Details	
	SDE-5001	SDE-5002
<b>General</b>		
Electrical	Input Voltage/Current	100 ~ 240 VAC ±10%; 50/60 Hz, Autoranging
	Power consumption	ADP-4812 Adaptor (2EA), 12V, 48W+48W
Environmental	Operating Temperature/ Humidity	0°C ~ +40°C (+32°F ~ +104°F) / 20% ~ 85%RH
Mechanical	Dimension (W X H X D)	W350 X H44 X D300 mm (13.98 X 1.73 X 11.81 inch)
	Weight (With hard disks)	2.8Kg
	Gross weight	12.8Kg
	Box Size (Outer)	W497 X H402 X D288mm (NTSC: 19.57 X 15.83 X 11.34 inch)
	Box Size (Inner)	W487 X H392 X D270mm (NTSC: 19.17 X 15.43 X 10.63 inch)
Lauguage		English, Spanish, French, German, Italian, Polish, Portuguese, Russian, Turkish, Japanese, Czech, Swedish, Danish, Korean, Chinese, Netherlands, Thai, Romanian, Serbian, Croatian, Hungarian, Greek

# appendix

## ❖ SDE-4003/5003

Item		Details	
		SDE-5003	SDE-4003
Video	Inputs	16 composite video 0.5-1 Vpp, 75 ohm	8 composite video 0.5-1 Vpp, 75 ohm
	Resolution	704x480 NTSC, 704x576 PAL	
Live	Frame rate	480fps NTSC, 400fps PAL	240fps NTSC, 200fps PAL
	Resolution	704x480 NTSC, 704x576 PAL	
	Multi Screen display	1, 4, 6, 8, 9, 13, 16, PIP, Sequence	1, 4, 6, 8, 9, 13, PIP, Sequence
<b>Performance</b>			
OS	Embedded	Linux	
Recording	Compression	H.264	
	Record Rate	NTSC: Up to 120fps @ 704x240 PAL: Up to 100ips @ 704x288	NTSC: Up to 60fps @ 704x480 PAL: Up to 50ips @ 704x576
		NTSC: Up to 240fps @ 352x240 PAL: Up to 200ips @ 352x288	NTSC: Up to 120fps @ 704x240 PAL: Up to 100ips @ 704x288
		NTSC: Up to 480fps @ 352x240 PAL: Up to 400ips @ 352x288	NTSC: Up to 240fps @ 352x240 PAL: Up to 200ips @ 352x288
	Mode	Manual, Schedule, Event	
	Overwrite modes	Continuous	
	Pre-alarm	Off/5sec	
Post-Alarm	Up to 6 hour. (5, 10, 20, 30 sec, 1, 3, 5, 10, 20 min, 1, 2, 3, 4, 5, 6 hour)		
Search mode	Search mode	Date/time, Event, Back up, Motion	
	Playback function	Fast Forward / Backward, Slow Forward / Backward, Step Forward / Backward	
Network	Transmission speed	NTSC:120fps, PAL:100fps	
	Bandwidth	Up to (4)Mbps, Unlimited(4M)/2/1.5/1 Mbps/800/600/500/400/300/200/100/50 kbps	
	Bandwidth control	Automatic	
	Stream	H.264(CIF)	
	Maximum No. of remote users	Search(2) / Live Unicast(10) / Live Multicast(10)	
	Protocol support	TCP/IP, DHCP, PPPoE, SMTP, NTP, HTTP, DDNS, RTP, RTSP	
	Monitoring	Smart Viewer, WebViewer, Mobile Viewer	

Item		Details	
		SDE-5003	SDE-4003
Smart phone	Smart phone	Android, i-phone (iPad included)	
	Protocol support	RTP, RTSP, HTTP, CGI	
	Transmission speed	CIF Max 15fps(Single Channel)/ CIF Max 2fps(Quad Channel)	
	Remote users Maximum	Live(1)	
Storage	Internal HDD	1TB SATA HDD	
	External HDD	-	
	DVD Writer (Back-up)	-	
	USB (Back-up)	2 USB Ports	
	File Format (Back-up)	BU (DVR Player), SEC (Include Player)	
Security	Password Protection	1 Admin, 10 Group , 10 User per 1 Group	
	Data Authentication	Watermark	
<b>Interface</b>			
Monitors	VGA	Analog RGB 1024x768 resolution (BNC or VGA selected in booting.)	
	HDMI	-	
	Main/Spot Composite	BNC, 1 Vp-p, 75 ohm	
	Spot Composite	Analog Spot (1 BNC, 1 Vp-p, 75 ohm)	
	Loop Outputs	-	
Audio	Inputs / Output	4 line in / 1 line out	
	Compression	G.711	
	Sampling rate	8KHz	
Alarm	Inputs / Outputs	-	
	Remote notification	Notification via e-mail	

# appendix

Item		Details	
		SDE-5003	SDE-4003
Connections	Ethernet	1 RJ45 10/100 Base-T	
	Serial interface	-	
	USB	USB 2.0, 2 ports (Front)	
	e-SATA	-	
	Application Support	Mouse, Remote Controller	
	PTZ Protocol support	-	
<b>General</b>			
Electrical	Input Voltage /Current	DC12V Adaptor,4A,100~250VAC, 50~60Hz, 48watt	
	Power consumption	Max.36 W (with 1x HDD)	
Environmental	Operating Temperature /Humidity	0°C ~ +40°C (+32°F ~ +104°F) / 20% ~ 85%RH	
Mechanical	Dimension (W X H X D)	W360 X H44 X D160 mm (14.17 X 1.73 X 6.30 inches)	
	Weight (With hard disks)	1.86kg	1.84kg
	Gross weight	10.11kg	6.8kg
	Box Size (Outer)	W445 X H299 X D303 mm (17.52 X 11.77 X 11.93 inches)	W445 X H299 X D221 mm (17.52 X 11.77 X 8.70 inches)
	Box Size (Inner)	W435 X H289 X D285 mm (17.13 X 11.38 X 11.22 inches)	W435 X H289 X D203 mm (17.13 X 11.38 X 7.99 inches)
Language	Korean, Japanese, Chinese, English, French, German, Spanish, Italian, Russian, Polish, Czech, Turkish, Netherlands, Portuguese, Swedish, Danish, Thai, Rumania, Serbia, Croatia, Hungary, Greek		

## DEFAULT SETTING

This returns the factory default settings.

The settings are made as follows;

- Use System/Load Factory Default in MENU
- The default settings are based on SDE-5001.
- The default password can be exposed to a hacking thread so it is recommended to change the password after installing the product. Note that the security and other related issues caused by the unchanged password shall be responsible for the user.

Category	Details			Factory Default
System Settings	Date/Time/Language	Date/Time/Language	Date	YYYY-MM-DD
			Time Format	24 hours
			Time Zone	GMT
			Time Synchronize	OFF
			DST	OFF
			Language	English
	Permission Management	Admin	ID	admin
			New Password	4321
		Setting	Restricted Access	Backup
			Auto Logout	OFF
System Management	System Information	Broadcast Format	NTSC/PAL	
Device	Camera	Camera	Video	ON
			Audio	OFF
			CH Name	CAM 01 ~ CAM 16
			SEQ-Dwell Time	5sec
	Screen Setup	Screen Setup	Brightness	50
			Contrast	50
			Color	50
	Storage Device	HDD Alarm	Check Alarm Output Port	OFF
			Duration	OFF
			Replace Alarm Output Port	OFF
			Duration	OFF
	Remote Device	Remote Control		ON(00)

# appendix

Category	Details			Factory Default
Device	Monitor	Monitor	Event Display	OFF
			Display	All
			Multi CH SEQ Time	5sec
			Video Output	VGA
			Display Position Setup	30
	Mode	Live Mode	ALL	
		Play Mode	ALL	
Recording	Recording Schedule	CH1		Both(Cont&Evt)
	Event Record Duration	PRE Event		OFF
		POST Event		1 min
	REC Quality/ Resolution	Standard	Resolution	CIF(S)
			Frame Rate	NTSC: 7 fps PAL: 5 fps
			Record Quality	Level 4
		Event	Resolution	4CIF(L)
			Frame Rate	NTSC: 7 fps PAL: 5 fps
			Record Quality	Level 4
	Record Option	Disk End Mode	Setup	Overwrite
Disk End Beep			OFF	
	Auto Delete		OFF	
Event	Sensor Detection	Sensor Operation	OFF	
		Camera	Camera No.	
		Alarm	None	
		Alarm Duration	10 sec	
	Motion Detection	Mode	OFF	
		Sensitivity	Level 10 High	
		Alarm	None	
		Alarm Duration	10 sec	
		Motion Region	All Area	



Category	Details			Factory Default
Event	Video Loss Detection	Video Loss State		OFF
		Alarm		None
		Alarm Duration		10 sec
	Alarm Schedule	Alarm1		Event Sync
Network	Connection Mode	Connection	Connection Mode	Static IP
			Bandwidth	2Mbps
			IP	192.168.1.200
			Gateway	192.168.1.1
			Subnet Mask	255.255.255.0
			DNS	168.126.63.1
	Protocol	Protocol Type	TCP	
		Port (TCP)	4520~4524	
		Webviewer Port	80	
	DDNS	DDNS Site		OFF
	Live Transfer	Resolution		CIF(S)
		Quality		Low
	Mailing Service	SMTP	Server	OFF
			Port	25
			Use Authentication	OFF
Secure Transfer			Never	
Event		Event Interval	10 min	
		Use Event Transfer	OFF	
Group		Group	OFF	
		Recipient Permission	OFF	
Recipient	Group	All Group		

# appendix

## TROUBLESHOOTING

Symptom	Countermeasures
The system does not turn on and the indicator on the front panel does not work at all.	<ul style="list-style-type: none"> <li>• Check if the power supply system is properly connected.</li> <li>• Check the system for the input voltage from the power source.</li> <li>• If the problem persists even after you have taken the above actions, check the power supplier and replace it with a new one if necessary.</li> </ul>
Some channels display just a black screen even if they receive video sources.	<ul style="list-style-type: none"> <li>• Check if the camera connected to the system properly displays the image. Sometimes, this problem may occur on a camera that is not properly connected to the video source.</li> <li>• Check if the camera is properly supplied with power.</li> <li>• Sometimes, this problem may occur on a channel with weak video signal from a video distributor that is connected to multiple systems. In this case, input the video source of the camera directly into the DVR. This may find the cause and solve the problem.</li> </ul>
If I press the <b>[REC]</b> button on the front panel, nor the player start recording.	<ul style="list-style-type: none"> <li>• Check if there is a free space on the HDD for the recording.</li> <li>• Check if the record mode is set to <b>ON</b> in the record mode setting.</li> </ul>
The screen displays the logo image repeatedly.	<ul style="list-style-type: none"> <li>• This may occur from a problem with the main board, or the related software is corrupt. Contact the nearest service center for more information.</li> </ul>
The Channel button does not work on the Live screen.	<ul style="list-style-type: none"> <li>• The Channel button does not work if the current screen is in the event monitoring mode. In the event monitoring screen, press the <b>[ALARM]</b> button to exit the screen and select a channel.</li> </ul>
The cursor will not move to the Start button when I start the calendar search.	<ul style="list-style-type: none"> <li>• Check if the channel and the date that you want to play are marked with the V symbol. Both channel and date should be checked before you can start playing with the Start button.</li> </ul>
When the alarm sounds, I press the <b>[ALARM]</b> button on the front panel to release the alarm but it does not work. The alarm persists and I could not set it off in any way.	<ul style="list-style-type: none"> <li>• Press the <b>[MENU]</b> button on the front panel to release the alarm in the following way: <ol style="list-style-type: none"> <li>1) To release the event monitoring mode : Monitoring Mode – set the duration of the event monitoring to Off.</li> <li>2) To release the alarm sound : Event Record Mode - Alarm (Motion Detection/Video Loss) – deactivate the alarm sound.</li> <li>3) To release the event : Event Record Mode - Alarm (Motion Detection/Video Loss) – set the mode to Off.</li> </ol> </li> </ul>

Symptom	Countermeasures
A message of "Need to reset date/time." is displayed on the screen.	<ul style="list-style-type: none"> <li>This message is displayed if there occurs a problem with the time setting of the internal clock or an error in the clock itself. Contact the retailer or the service center for more information.</li> </ul>
The time bar is not displayed in Search mode.	<ul style="list-style-type: none"> <li>The timeline can switch between normal and extension mode. In extension mode, the time bar may not be displayed in the current timeline. Switch to normal mode or use the left or right button to navigate through the time bar.</li> </ul>
The "NO HDD" icon and an error message are displayed.	<ul style="list-style-type: none"> <li>Check the HDD for connection. If the problem persists in a normal condition, contact the nearest service center to have the HDD checked by the service personnel.</li> </ul>
I have installed an additional HDD on the DVR but it does not recognize the HDD.	<ul style="list-style-type: none"> <li>See the compatibility list to check if the additional HDD is supported by the DVR. For the compatibility list, contact the retailer where you purchased the DVR.</li> </ul>
I have connected an external storage device to the DVR but the DVR seems not to recognize it.	<ul style="list-style-type: none"> <li>See the compatibility list of external storage devices to check if the connected device is supported by the DVR. For the compatibility list, contact the retailer where you purchased the DVR.</li> </ul>
If I press the ESC key in full screen mode of the WebViewer, the system does not switch to a normal split mode.	<ul style="list-style-type: none"> <li>Press the ALT+TAB keys to select 'ACTIVE MOVIE' and press the ESC key again. The system will switch to a normal split mode.</li> </ul>
I found it difficult to configure the network settings if using the default search, backup and router settings.	<ul style="list-style-type: none"> <li>For more information, refer to the user manual.</li> <li>If you want to check the basics of the product for a quick start, refer to the quick start guide (backup, search).</li> <li>If you use the router for network connection, refer to the "<b>Connecting to the Internet using the router</b>" section in this manual.</li> </ul>
I forgot the password.	<ul style="list-style-type: none"> <li>Contact the DVR administrator for help.</li> </ul>
Backup data is just not played by the PC or DVR.	<ul style="list-style-type: none"> <li>When you are backing up data, you have choices about the player either: PC or DVR. Make your selection before proceeding.</li> <li>If you are using the PC to play the data, the format of the backup file should be SEC.</li> <li>If you are using the DVR for this purpose, formatting backup files should be done by the DVR.</li> </ul>
My player does not switch to Live mode while in playback.	<ul style="list-style-type: none"> <li>Press the Stop [■] button on the DVR or the remote control, or click the [■] icon on the launcher to switch to Live mode.</li> </ul>

# appendix

Symptom	Countermeasures
Recording does not work.	<ul style="list-style-type: none"> <li>• If your player does not display a Live image at all, that indicates recording does not work so first check if you see an image on the screen.</li> <li>• Recording does not work if the recording settings are not properly configured.               <ol style="list-style-type: none"> <li>1) Manual Record: Press the <b>[REC]</b> button on the front panel of the DVR or on the remote control to start recording.</li> <li>2) Scheduled Record: Specify a desired time in Menu – Record - Recording Schedule. Recording will start at the specified time.                   <ul style="list-style-type: none"> <li>- <b>&lt;Continuous&gt;</b> Record: Recording will proceed in any conditions at the specified time.</li> <li>- <b>&lt;Event&gt;</b> Record: When an event occurs, recording will perform only if the event is of alarm, motion detection and video loss. If there is no event found, recording will not perform.</li> <li>- <b>&lt;Continuous / Event&gt;</b> Record: If there is no event found, Continuous recording will perform. Whereas, if an event occurs, Event recording will perform.</li> </ul> </li> </ol> </li> </ul>
The image quality of the recording data is not good.	<ul style="list-style-type: none"> <li>• Increase the resolution and quality level in Menu – Record – Quality / Resolution.               <ol style="list-style-type: none"> <li>1) Resolution: Select a bigger size when specifying the recording size. (4CIF&gt;2CIF&gt;CIF) The recording image in the CIF format shows a deteriorated quality as it is enlarged from a small-sized image.</li> <li>2) Record Quality: Specify a bigger level for the recording quality.</li> </ol> </li> <li>• If you increase the resolution and the recording quality, the data size increases accordingly. So the HDD will be filled faster. Overwriting will overwrite the existing data so recording will proceed at a shorter interval.</li> </ul>

# OPEN SOURCE LICENSE REPORT ON THE PRODUCT

The software included in this product contains copyrighted software that is licensed under the GPL/LGPL. You may obtain the complete Corresponding Source code from us for a period of three years after our last shipment of this product by sending email to help.ctvt@samsung.com If you want to obtain the complete Corresponding Source code in the physical medium such as CD-ROM, the cost of physically performing source distribution might be charged.

- GPL Software : linux kernel, Sysvinit, dosfstools, wget, msmtmp, busybox, cdrtools, dvd+rw-tools, iconv, smartctl, uboot, minicom, openssl, bash, lm\_sensors
- LGPL Software : glibc, vmstat, inetutils
- OpenSSL License : OpenSSL

## GNU GENERAL PUBLIC LICENSE

Version 2, June 1991

Copyright (C) 1989, 1991 Free Software Foundation, Inc.

51 Franklin Street, Fifth Floor, Boston, MA 02110-1301, USA

Everyone is permitted to copy and distribute verbatim copies of this license document, but changing it is not allowed.

### Preamble

The licenses for most software are designed to take away your freedom to share and change it. By contrast, the GNU General Public License is intended to guarantee your freedom to share and change free software to make sure the software is free for all its users. This General Public License applies to most of the Free Software Foundation's software and to any other program whose authors commit to using it. (Some other Free Software Foundation software is covered by the GNU Lesser General Public License instead.) You can apply it to your programs, too. When we speak of free software, we are referring to freedom, not price. Our General Public Licenses are designed to make sure that you have the freedom to distribute copies of free software (and charge for this service if you wish), that you receive source code or can get it if you want it, that you can change the software or use pieces of it in new free programs; and that you know you can do these things.

To protect your rights, we need to make restrictions that forbid anyone to deny you these rights or to ask you to surrender the rights. These restrictions translate to certain responsibilities for you if you distribute copies of the software, or if you modify it.

For example, if you distribute copies of such a program, whether gratis or for a fee, you must give the recipients all the rights that you have. You must make sure that they, too, receive or can get the source code. And you must show them these terms so they know their rights.

We protect your rights with two steps:

(1) copyright the software, and (2) offer you this license which gives you legal permission to copy, distribute and/or modify the software.

Also, for each author's protection and ours, we want to make certain that everyone understands that there is no warranty for this free software. If the software is modified by someone else and passed on, we want its recipients to know that what they have is not the original, so that any problems introduced by others will not reflect on the original authors' reputations.

Finally, any free program is threatened constantly by software patents. We wish to avoid the danger that redistributors of a free program will individually obtain patent licenses, in effect making the program proprietary. To prevent this, we have made it clear that any patent must be licensed for everyone's free use or not licensed at all. The precise terms and conditions for copying, distribution and modification follow.

## TERMS AND CONDITIONS FOR COPYING, DISTRIBUTION AND MODIFICATION

Version 2, June 1991

Copyright (C) 1989, 1991 Free Software Foundation, Inc.

51 Franklin St

0. This License applies to any program or other work which contains a notice placed by the copyright holder saying it may be distributed under the terms of this General Public License. The "Program", below, refers to any such program or work, and a "work based on the Program" means either the Program or any derivative work under copyright law: that is to say, a work containing the Program or a portion of it, either verbatim or with modifications and/or translated into another language. (Hereinafter, translation is included without limitation in the term "modification".) Each licensee is addressed as "you".

Activities other than copying, distribution and modification are not covered by this License; they are outside its scope. The act of running the Program is not restricted, and the output from the Program is covered only if its contents constitute a work based on the Program (independent of having been made by running the Program). Whether that is true depends on what the Program does.

1. You may copy and distribute verbatim copies of the Program's source code as you receive it, in any medium, provided that you conspicuously and appropriately publish on each copy an appropriate copyright notice and disclaimer of warranty; keep intact all the notices that refer to this License and to the absence of any warranty; and give any other recipients of the Program a copy of this License along with the Program.

You may charge a fee for the physical act of transferring a copy, and you may at your option offer warranty protection in exchange for a fee.

2. You may modify your copy or copies of the Program or any portion of it, thus forming a work based on the Program, and copy and distribute such modifications or work under the terms of Section 1 above, provided that you also meet all of these conditions:

- a) You must cause the modified files to carry prominent notices stating that you changed the files and the date of any change.
- b) You must cause any work that you distribute or publish, that in whole or in part contains or is derived from the Program or any part thereof, to be licensed as a whole at no charge to all third parties under the terms of this License.
- c) If the modified program normally reads commands interactively when run, you must cause it, when started running for such interactive use in the most ordinary way, to print or display an announcement including an appropriate copyright notice and a notice that there is no warranty (or else, saying that you provide a warranty) and that users may redistribute the program under these conditions, and telling the user how to view a copy of this License. (Exception: if the Program itself is interactive but does not normally print such an announcement, your work based on the Program is not required to print an announcement.)

These requirements apply to the modified work as a whole. If identifiable sections of that work are not derived from the Program, and can be reasonably considered independent and separate works in themselves, then this License, and its terms, do not apply to those sections when you distribute them as separate works. But when you distribute the same sections as part of a whole which is a work based on the Program, the distribution of the whole must be on the terms of this License, whose permissions for other licensees extend to the entire whole, and thus to each and every part regardless of who wrote it.

Thus, it is not the intent of this section to claim rights or contest your rights to work written entirely by you; rather, the intent is to exercise the right to control the distribution of derivative or collective works based on the Program.

In addition, mere aggregation of another work not based on the Program with the Program (or with a work based on the Program) on a volume of a storage or distribution medium does not bring the other work under the scope of this License.

3. You may copy and distribute the Program (or a work based on it, under Section 2) in object code or executable form under the terms of Sections 1 and 2 above provided that you also do one of the following:

- a) Accompany it with the complete corresponding machine-readable source code, which must be distributed under the terms of Sections 1 and 2 above on a medium customarily used for software interchange; or,
- b) Accompany it with a written offer, valid for at least three years, to give any third party, for a charge no more than your cost of physically performing source distribution, a complete machine-readable copy of the corresponding source code, to be distributed under the terms of Sections 1 and 2 above on a medium customarily used for software interchange; or,
- c) Accompany it with the information you received as to the offer to distribute corresponding source code. (This alternative is allowed only for noncommercial distribution and only if you received the program in object code or executable form with such an offer, in accord with Subsection b above.)

The source code for a work means the preferred form of the work for making modifications to it. For an executable work, complete source code means all the source code for all modules it contains, plus any associated interface definition files, plus the scripts used to control compilation and installation of the executable. However, as a special exception, the source code distributed need not include anything that is

normally distributed (in either source or binary form) with the major components (compiler, kernel, and so on) of the operating system on which the executable runs, unless that component itself accompanies the executable.

If distribution of executable or object code is made by offering access to copy from a designated place, then offering equivalent access to copy the source code from the same place counts as distribution of the source code, even though third parties are not compelled to copy the source along with the object code.

4. You may not copy, modify, sublicense, or distribute the Program except as expressly provided under this License. Any attempt otherwise to copy, modify, sublicense or distribute the Program is void, and will automatically terminate your rights under this License. However, parties who have received copies, or rights, from you under this License will not have their licenses terminated so long as such parties remain in full compliance.

5. You are not required to accept this License, since you have not signed it. However, nothing else grants you permission to modify or distribute the Program or its derivative works. These actions are prohibited by law if you do not accept this License. Therefore, by modifying or distributing the Program (or any work based on the Program), you indicate your acceptance of this License to do so, and all its terms and conditions for copying, distributing or modifying the Program or works based on it.

6. Each time you redistribute the Program (or any work based on the Program), the recipient automatically receives a license from the original licensor to copy, distribute or modify the Program subject to these terms and conditions. You may not impose any further restrictions on the recipients' exercise of the rights granted herein. You are not responsible for enforcing compliance by third parties to this License.

7. If, as a consequence of a court judgment or allegation of patent infringement or for any other reason (not limited to patent issues), conditions are imposed on you (whether by court order, agreement or otherwise) that contradict the conditions of this License, they do not excuse you from the conditions of this License. If you cannot distribute so as to satisfy simultaneously your obligations under this License and any other pertinent obligations, then as a consequence you may not distribute the Program at all. For example, if a patent license would not permit royalty-free redistribution of the Program by all those who receive copies directly or indirectly through you, then the only way you could satisfy both it and this License would be to refrain entirely from distribution of the Program.

If any portion of this section is held invalid or unenforceable under any particular circumstance, the balance of the section is intended to apply and the section as a whole is intended to apply in other circumstances.

It is not the purpose of this section to induce you to infringe any patents or other property right claims or to contest validity of any such claims; this section has the sole purpose of protecting the integrity of the free software distribution system, which is implemented by public license practices. Many people have made generous contributions to the wide range of software distributed through that system in reliance on consistent application of that system; it is up to the author/donor to decide if he or she is willing to distribute software through any other system and a licensee cannot impose that choice.

This section is intended to make thoroughly clear what is believed to be a consequence of the rest of this License.

8. If the distribution and/or use of the Program is restricted in certain countries either by patents or by copyrighted interfaces, the original copyright holder who places the Program under this License may add an explicit geographical distribution limitation excluding those countries, so that distribution is permitted only in or among countries not thus excluded. In such case, this License incorporates the limitation as if written in the body of this License.

9. The Free Software Foundation may publish revised and/or new versions of the General Public License from time to time. Such new versions will be similar in spirit to the present version, but may differ in detail to address new problems or concerns.

Each version is given a distinguishing version number. If the Program specifies a version number of this License which applies to it and "any later version", you have the option of following the terms and conditions either of that version or of any later version published by the Free Software Foundation. If the Program does not specify a version number of this License, you may choose any version ever published by the Free Software Foundation.

10. If you wish to incorporate parts of the Program into other free programs whose distribution conditions are different, write to the author to ask for permission. For software which is copyrighted by the Free Software Foundation, write to the Free Software Foundation; we sometimes make exceptions for this. Our decision will be guided by the two goals of preserving the free status of all derivatives of our free software and of promoting the sharing and reuse of software generally.

## NO WARRANTY

11. BECAUSE THE PROGRAM IS LICENSED FREE OF CHARGE, THERE IS NO WARRANTY FOR THE PROGRAM, TO THE EXTENT PERMITTED BY APPLICABLE LAW. EXCEPT WHEN OTHERWISE STATED IN WRITING THE COPYRIGHT HOLDERS AND/OR OTHER PARTIES PROVIDE THE PROGRAM "AS IS" WITHOUT WARRANTY OF ANY KIND, EITHER EXPRESSED OR IMPLIED, INCLUDING, BUT NOT LIMITED TO, THE IMPLIED WARRANTIES OF MERCHANTABILITY AND FITNESS FOR A PARTICULAR PURPOSE. THE ENTIRE RISK AS TO THE QUALITY AND PERFORMANCE OF THE PROGRAM IS WITH YOU. SHOULD THE PROGRAM PROVE DEFECTIVE, YOU ASSUME THE COST OF ALL NECESSARY SERVICING, REPAIR OR CORRECTION.

12. IN NO EVENT UNLESS REQUIRED BY APPLICABLE LAW OR AGREED TO IN WRITING WILL ANY COPYRIGHT HOLDER, OR ANY OTHER PARTY WHO MAY MODIFY AND/OR REDISTRIBUTE THE PROGRAM AS PERMITTED ABOVE, BE LIABLE TO YOU FOR DAMAGES, INCLUDING ANY GENERAL, SPECIAL, INCIDENTAL OR CONSEQUENTIAL DAMAGES ARISING OUT OF THE USE OR INABILITY TO USE THE PROGRAM (INCLUDING BUT NOT LIMITED TO LOSS OF DATA OR DATA BEING RENDERED INACCURATE OR LOSSES SUSTAINED BY YOU OR THIRD PARTIES OR A FAILURE OF THE PROGRAM TO OPERATE WITH ANY OTHER PROGRAMS), EVEN IF SUCH HOLDER OR OTHER PARTY HAS BEEN ADVISED OF THE POSSIBILITY OF SUCH DAMAGES.

## END OF TERMS AND CONDITIONS

### How to Apply These Terms to Your New Programs

If you develop a new program, and you want it to be of the greatest possible use to the public, the best way to achieve this is to make it free software which everyone can redistribute and change under these terms.

To do so, attach the following notices to the program. It is safest to attach them to the start of each source file to most effectively convey the exclusion of warranty; and each file should have at least the "copyright" line and a pointer to where the full notice is found.

one line to give the program's name and an idea of what it does.

Copyright (C) yyyy name of author

This program is free software; you can redistribute it and/or modify it under the terms of the GNU General Public License as published by the Free Software Foundation; either version 2 of the License, or (at your option) any later version.

This program is distributed in the hope that it will be useful, but WITHOUT ANY WARRANTY; without even the implied warranty of MERCHANTABILITY or FITNESS FOR A PARTICULAR PURPOSE. See the GNU General Public License for more details.

You should have received a copy of the GNU General Public License along with this program; if not, write to the Free Software Foundation, Inc., 51 Franklin Street, Fifth Floor, Boston, MA 02110-1301, USA.

Also add information on how to contact you by electronic and paper mail. If the program is interactive, make it output a short notice like this when it starts in an interactive mode:

Gnomovision version 69, Copyright (C) year name of author  
Gnomovision comes with ABSOLUTELY NO WARRANTY; for details type 'show w'. This is free software, and you are welcome to redistribute it under certain conditions; type 'show c' for details.

The hypothetical commands 'show w' and 'show c' should show the appropriate parts of the General Public License. Of course, the commands you use may be called something other than 'show w' and 'show c'; they could even be mouse-clicks or menu items--whatever suits your program.

You should also get your employer (if you work as a programmer) or your school, if any, to sign a "copyright disclaimer" for the program, if necessary. Here is a sample; alter the names:

Yooyodyne, Inc., hereby disclaims all copyright interest in the program 'Gnomovision' (which makes passes at compilers) written by James Hacker.

signature of Ty Coon, 1 April 1989 Ty Coon, President of Vice  
This General Public License does not permit incorporating your program into proprietary programs. If your program is a subroutine library, you may consider it more useful to permit linking proprietary applications with the library. If this is what you want to do, use the GNU Lesser General Public License instead of this License.

## GNU GENERAL PUBLIC LICENSE

Version 3, 29 June 2007

Copyright © 2007 Free Software Foundation, Inc. <<http://fsf.org/>>

Everyone is permitted to copy and distribute verbatim copies of this license document, but changing it is not allowed.

## Preamble

The GNU General Public License is a free, copyleft license for software and other kinds of works.

The licenses for most software and other practical works are designed to take away your freedom to share and change the works. By contrast, the GNU General Public License is intended to guarantee your freedom to share and change all versions of a program--to make sure it remains free software for all its users. We, the Free Software Foundation, use the GNU General Public License for most of our software; it applies also to any other work released this way by its authors. You can apply it to your programs, too.

When we speak of free software, we are referring to freedom, not price. Our General Public Licenses are designed to make sure that you have the freedom to distribute copies of free software (and charge for them if you wish), that you receive source code or can get it if you want it, that you can change the software or use pieces of it in new free programs, and that you know you can do these things.

To protect your rights, we need to prevent others from denying you these rights or asking you to surrender the rights. Therefore, you have certain responsibilities if you distribute copies of the software, or if you modify it: responsibilities to respect the freedom of others.

For example, if you distribute copies of such a program, whether gratis or for a fee, you must pass on to the recipients the same freedoms that you received. You must make sure that they, too, receive or can get the source code. And you must show them these terms so they know their rights.

Developers that use the GNU GPL protect your rights with two steps: (1) assert copyright on the software, and (2) offer you this License giving you legal permission to copy, distribute and/or modify it.

For the developers' and authors' protection, the GPL clearly explains that there is no warranty for this free software. For both users' and authors' sake, the GPL requires that modified versions be marked as changed, so that their problems will not be attributed erroneously to authors of previous versions.

Some devices are designed to deny users access to install or run modified versions of the software inside them, although the manufacturer can do so. This is fundamentally incompatible with the aim of protecting users' freedom to change the software. The systematic pattern of such abuse occurs in the area of products for individuals to use, which is precisely where it is most unacceptable. Therefore, we have designed this version of the GPL to prohibit the practice for those products. If such problems arise substantially in other domains, we stand ready to extend this provision to those domains in future versions of the GPL, as needed to protect the freedom of users.

Finally, every program is threatened constantly by software patents. States should not allow patents to restrict development and use of software on general-purpose computers, but in those that do, we wish to avoid the special danger that patents applied to a free program could make it effectively proprietary. To prevent this, the GPL assures that patents cannot be used to render the program non-free.

The precise terms and conditions for copying, distribution and modification follow.

## TERMS AND CONDITIONS

### 0. Definitions.

"This License" refers to version 3 of the GNU General Public License.

"Copyright" also means copyright-like laws that apply to other kinds of works, such as semiconductor masks.

"The Program" refers to any copyrightable work licensed under this License. Each licensee is addressed as "you", "Licensees" and "recipients" may be individuals or organizations.

To "modify" a work means to copy from or adapt all or part of the work in a fashion requiring copyright permission, other than the making of an exact copy. The resulting work is called a "modified version" of the earlier work or a work "based on" the earlier work.

A "covered work" means either the unmodified Program or a work based on the Program.

To "propagate" a work means to do anything with it that, without permission, would make you directly or secondarily liable for infringement under applicable copyright law, except executing it on a computer or modifying a private copy. Propagation includes copying, distribution (with or without modification), making available to the public, and in some countries other activities as well.

To "convey" a work means any kind of propagation that enables other parties to make or receive copies. Mere interaction with a user through a computer network, with no transfer of a copy, is not conveying.

An interactive user interface displays "Appropriate Legal Notices" to the extent that it includes a convenient and prominently visible feature that (1) displays an appropriate copyright notice, and (2) tells the user that there is no warranty for the work (except to the extent that warranties are provided), that licensees may convey the work under this License,

and how to view a copy of this License. If the interface presents a list of user commands or options, such as a menu, a prominent item in the list meets this criterion.

### 1. Source Code.

The "source code" for a work means the preferred form of the work for making modifications to it. "Object code" means any non-source form of a work.

A "Standard Interface" means an interface that either is an official standard defined by a recognized standards body, or, in the case of interfaces specified for a particular programming language, one that is widely used among developers working in that language.

The "System Libraries" of an executable work include anything, other than the work as a whole, that (a) is included in the normal form of packaging a Major Component, but which is not part of that Major Component, and (b) serves only to enable use of the work with that Major Component, or to implement a Standard Interface for which an implementation is available to the public in source code form. A "Major Component", in this context, means a major essential component (kernel, window system, and so on) of the specific operating system (if any) on which the executable work runs, or a compiler used to produce the work, or an object code interpreter used to run it.

The "Corresponding Source" for a work in object code form means all the source code needed to generate, install, and (for an executable work) run the object code and to modify the work, including scripts to control those activities. However, it does not include the work's System Libraries, or general-purpose tools or generally available free programs which are used unmodified in performing those activities but which are not part of the work. For example, Corresponding Source includes interface definition files associated with source files for the work, and the source code for shared libraries and dynamically linked subprograms that the work is specifically designed to require, such as by intimate data communication or control flow between those subprograms and other parts of the work.

The Corresponding Source need not include anything that users can regenerate automatically from other parts of the Corresponding Source. The Corresponding Source for a work in source code form is that same work.

### 2. Basic Permissions.

All rights granted under this License are granted for the term of copyright on the Program, and are irrevocable provided the stated conditions are met. This License explicitly affirms your unlimited permission to run the unmodified Program. The output from running a covered work is covered by this License only if the output, given its content, constitutes a covered work. This License acknowledges your rights of fair use or other equivalent, as provided by copyright law.

You may make, run and propagate covered works that you do not convey, without conditions so long as your license otherwise remains in force. You may convey covered works to others for the sole purpose of having them make modifications exclusively for you, or provide you with facilities for running those works, provided that you comply with the terms of this License in conveying all material for which you do not control copyright. Those thus making or running the covered works for you must do so exclusively on your behalf, under your direction and control, on terms that prohibit them from making any copies of your copyrighted material outside their relationship with you.

Conveying under any other circumstances is permitted solely under the conditions stated below. Sublicensing is not allowed; section 10 makes it unnecessary.

### 3. Protecting Users' Legal Rights From Anti-Circumvention Law.

No covered work shall be deemed part of an effective technological measure under any applicable law fulfilling obligations under article 11 of the WIPO copyright treaty adopted on 20 December 1996, or similar laws prohibiting or restricting circumvention of such measures.

When you convey a covered work, you waive any legal power to forbid circumvention of technological measures to the extent such circumvention is effected by exercising rights under this License with respect to the covered work, and you disclaim any intention to limit operation or modification of the work as a means of enforcing, against the work's users, your or third parties' legal rights to forbid circumvention of technological measures.

### 4. Conveying Verbatim Copies.

You may convey verbatim copies of the Program's source code as you receive it, in any medium, provided that you conspicuously and appropriately publish on each copy an appropriate copyright notice; keep intact all notices stating that this License and any non-permissive terms added in accord with section 7 apply to the code; keep intact all notices of the absence of any warranty; and give all recipients a copy of this License along with the Program.

You may charge any price or no price for each copy that you convey, and you may offer support or warranty protection for a fee.

## 5. Conveying Modified Source Versions.

You may convey a work based on the Program, or the modifications to produce it from the Program, in the form of source code under the terms of section 4, provided that you also meet all of these conditions:

- a) The work must carry prominent notices stating that you modified it, and giving a relevant date.
- b) The work must carry prominent notices stating that it is released under this License and any conditions added under section 7. This requirement modifies the requirement in section 4 to "keep intact all notices".
- c) You must license the entire work, as a whole, under this License to anyone who comes into possession of a copy. This License will therefore apply, along with any applicable section 7 additional terms, to the whole of the work, and all its parts, regardless of how they are packaged. This License gives no permission to license the work in any other way, but it does not invalidate such permission if you have separately received it.
- d) If the work has interactive user interfaces, each must display Appropriate Legal Notices; however, if the Program has interactive interfaces that do not display Appropriate Legal Notices, your work need not make them do so.

A compilation of a covered work with other separate and independent works, which are not by their nature extensions of the covered work, and which are not combined with it such as to form a larger program, in or on a volume of a storage or distribution medium, is called an "aggregate" if the compilation and its resulting copyright are not used to limit the access or legal rights of the compilation's users beyond what the individual works permit. Inclusion of a covered work in an aggregate does not cause this License to apply to the other parts of the aggregate.

## 6. Conveying Non-Source Forms.

You may convey a covered work in object code form under the terms of sections 4 and 5, provided that you also convey the machine-readable Corresponding Source under the terms of this License, in one of these ways:

- a) Convey the object code in, or embodied in, a physical product (including a physical distribution medium), accompanied by the Corresponding Source fixed on a durable physical medium customarily used for software interchange.
- b) Convey the object code in, or embodied in, a physical product (including a physical distribution medium), accompanied by a written offer, valid for at least three years and valid for as long as you offer spare parts or customer support for that product model, to give anyone who possesses the object code either (1) a copy of the Corresponding Source for all the software in the product that is covered by this License, on a durable physical medium customarily used for software interchange, for a price no more than your reasonable cost of physically performing this conveying of source, or (2) access to copy the Corresponding Source from a network server at no charge.
- c) Convey individual copies of the object code with a copy of the written offer to provide the Corresponding Source. This alternative is allowed only occasionally and noncommercially, and only if you received the object code with such an offer, in accord with subsection 6b.
- d) Convey the object code by offering access from a designated place (gratis or for a charge), and offer equivalent access to the Corresponding Source in the same way through the same place at no further charge. You need not require recipients to copy the Corresponding Source along with the object code. If the place to copy the object code is a network server, the Corresponding Source may be on a different server (operated by you or a third party) that supports equivalent copying facilities, provided you maintain clear directions next to the object code saying where to find the Corresponding Source. Regardless of what server hosts the Corresponding Source, you remain obligated to ensure that it is available for as long as needed to satisfy these requirements.
- e) Convey the object code using peer-to-peer transmission, provided you inform other peers where the object code and Corresponding Source of the work are being offered to the general public at no charge under subsection 6d.

A separable portion of the object code, whose source code is excluded from the Corresponding Source as a System Library, need not be included in conveying the object code work.

A "User Product" is either (1) a "consumer product", which means any tangible personal property which is normally used for personal, family, or household purposes, or (2) anything designed or sold for incorporation into a dwelling. In determining whether a product is a consumer product, doubtful cases shall be resolved in favor of coverage. For a particular product received by a particular user, "normally used" refers to a typical or common use of that class of product, regardless of the status of the particular user or of the way in which the particular user actually uses, or expects or is expected to use, the product. A product is a consumer product regardless of whether the product has

substantial commercial, industrial or non-consumer uses, unless such uses represent the only significant mode of use of the product.

"Installation Information" for a User Product means any methods, procedures, authorization keys, or other information required to install and execute modified versions of a covered work in that User Product from a modified version of its Corresponding Source. The information must suffice to ensure that the continued functioning of the modified object code is in no case prevented or interfered with solely because modification has been made.

If you convey an object code work under this section in, or with, or specifically for use in, a User Product, and the conveying occurs as part of a transaction in which the right of possession and use of the User Product is transferred to the recipient in perpetuity or for a fixed term (regardless of how the transaction is characterized), the Corresponding Source conveyed under this section must be accompanied by the Installation Information. But this requirement does not apply if neither you nor any third party retains the ability to install modified object code on the User Product (for example, the work has been installed in ROM).

The requirement to provide Installation Information does not include a requirement to continue to provide support service, warranty, or updates for a work that has been modified or installed by the recipient, or for the User Product in which it has been modified or installed. Access to a network may be denied when the modification itself materially and adversely affects the operation of the network or violates the rules and protocols for communication across the network.

Corresponding Source conveyed, and Installation Information provided, in accord with this section must be in a format that is publicly documented (and with an implementation available to the public in source code form), and must require no special password or key for unpacking, reading or copying.

## 7. Additional Terms.

"Additional permissions" are terms that supplement the terms of this License by making exceptions from one or more of its conditions. Additional permissions that are applicable to the entire Program shall be treated as though they were included in this License, to the extent that they are valid under applicable law. If additional permissions apply only to part of the Program, that part may be used separately under those permissions, but the entire Program remains governed by this License without regard to the additional permissions.

When you convey a copy of a covered work, you may at your option remove any additional permissions from that copy, or from any part of it. (Additional permissions may be written to require their own removal in certain cases when you modify the work.) You may place additional permissions on material, added by you to a covered work, for which you have or can give appropriate copyright permission.

Notwithstanding any other provision of this License, for material you add to a covered work, you may (if authorized by the copyright holders of that material) supplement the terms of this License with terms:

- a) Disclaiming warranty or limiting liability differently from the terms of sections 15 and 16 of this License; or
- b) Requiring preservation of specified reasonable legal notices or author attributions in that material or in the Appropriate Legal Notices displayed by works containing it; or
- c) Prohibiting misrepresentation of the origin of that material, or requiring that modified versions of such material be marked in reasonable ways as different from the original version; or
- d) Limiting the use for publicity purposes of names of licensors or authors of the material; or
- e) Declining to grant rights under trademark law for use of some trade names, trademarks, or service marks; or
- f) Requiring indemnification of licensors and authors of that material by anyone who conveys the material (or modified versions of it) with contractual assumptions of liability to the recipient, for any liability that these contractual assumptions directly impose on those licensors and authors.

All other non-permissive additional terms are considered "further restrictions" within the meaning of section 10. If the Program as you received it, or any part of it, contains a notice stating that it is governed by this License along with a term that is a further restriction, you may remove that term. If a license document contains a further restriction but permits relicensing or conveying under this License, you may add to a covered work material governed by the terms of that license document, provided that the further restriction does not survive such relicensing or conveying.

If you add terms to a covered work in accord with this section, you must place, in the relevant source files, a statement of the additional terms that apply to those files, or a notice indicating where to find the applicable terms.

Additional terms, permissive or non-permissive, may be stated in the form of a separately written license, or stated as exceptions; the above requirements apply either way.



## 8. Termination.

You may not propagate or modify a covered work except as expressly provided under this License. Any attempt otherwise to propagate or modify it is void, and will automatically terminate your rights under this License (including any patent licenses granted under the third paragraph of section 11).

However, if you cease all violation of this License, then your license from a particular copyright holder is reinstated (a) provisionally, unless and until the copyright holder explicitly and finally terminates your license, and (b) permanently, if the copyright holder fails to notify you of the violation by some reasonable means prior to 60 days after the cessation.

Moreover, your license from a particular copyright holder is reinstated permanently if the copyright holder notifies you of the violation by some reasonable means, this is the first time you have received notice of violation of this License (for any work) from that copyright holder, and you cure the violation prior to 30 days after your receipt of the notice.

Termination of your rights under this section does not terminate the licenses of parties who have received copies or rights from you under this License. If your rights have been terminated and not permanently reinstated, you do not qualify to receive new licenses for the same material under section 10.

## 9. Acceptance Not Required for Having Copies.

You are not required to accept this License in order to receive or run a copy of the Program. Ancillary propagation of a covered work occurring solely as a consequence of using peer-to-peer transmission to receive a copy likewise does not require acceptance. However, nothing other than this License grants you permission to propagate or modify any covered work. These actions infringe copyright if you do not accept this License. Therefore, by modifying or propagating a covered work, you indicate your acceptance of this License to do so.

## 10. Automatic Licensing of Downstream Recipients.

Each time you convey a covered work, the recipient automatically receives a license from the original licensors, to run, modify and propagate that work, subject to this License. You are not responsible for enforcing compliance by third parties with this License.

An "entity transaction" is a transaction transferring control of an organization, or substantially all assets of one, or subdividing an organization, or merging organizations. If propagation of a covered work results from an entity transaction, each party to that transaction who receives a copy of the work also receives whatever licenses to the work the party's predecessor in interest had or could give under the previous paragraph, plus a right to possession of the Corresponding Source of the work from the predecessor in interest, if the predecessor has it or can get it with reasonable efforts.

You may not impose any further restrictions on the exercise of the rights granted or affirmed under this License. For example, you may not impose a license fee, royalty, or other charge for exercise of rights granted under this License, and you may not initiate litigation (including a cross-claim or counterclaim in a lawsuit) alleging that any patent claim is infringed by making, using, selling, offering for sale, or importing the Program or any portion of it.

## 11. Patents.

A "contributor" is a copyright holder who authorizes use under this License of the Program or a work on which the Program is based. The work thus licensed is called the contributor's "contributor version".

A contributor's "essential patent claims" are all patent claims owned or controlled by the contributor, whether already acquired or hereafter acquired, that would be infringed by some manner, permitted by this License, of making, using, or selling its contributor version, but do not include claims that would be infringed only as a consequence of further modification of the contributor version. For purposes of this definition, "control" includes the right to grant patent sublicenses in a manner consistent with the requirements of this License.

Each contributor grants you a non-exclusive, worldwide, royalty-free patent license under the contributor's essential patent claims, to make, use, sell, offer for sale, import and otherwise run, modify and propagate the contents of its contributor version.

In the following three paragraphs, a "patent license" is any express agreement or commitment, however denominated, not to enforce a patent (such as an express permission to practice a patent or covenant not to sue for patent infringement). To "grant" such a patent license to a party means to make such an agreement or commitment not to enforce a patent against the party.

If you convey a covered work, knowingly relying on a patent license, and the Corresponding Source of the work is not available for anyone to copy, free of charge and under the terms of this License, through a publicly available network server or other readily accessible means, then you must either (1) cause the Corresponding Source to be so available, or (2) arrange to deprive yourself of the benefit of the patent license for this particular work, or (3) arrange, in a manner consistent with the requirements of this License, to extend the patent license to downstream

recipients. "Knowingly relying" means you have actual knowledge that, but for the patent license, your conveying the covered work in a country, or your recipient's use of the covered work in a country, would infringe one or more identifiable patents in that country that you have reason to believe are valid.

If, pursuant to or in connection with a single transaction or arrangement, you convey, or propagate by procuring conveyance of, a covered work, and grant a patent license to some of the parties receiving the covered work authorizing them to use, propagate, modify or convey a specific copy of the covered work, then the patent license you grant is automatically extended to all recipients of the covered work and works based on it.

A patent license is "discriminatory" if it does not include within the scope of its coverage, prohibits the exercise of, or is conditioned on the non-exercise of one or more of the rights that are specifically granted under this License. You may not convey a covered work if you are a party to an arrangement with a third party that is in the business of distributing software, under which you make payment to the third party based on the extent of your activity of conveying the work, and under which the third party grants, to any of the parties who would receive the covered work from you, a discriminatory patent license (a) in connection with copies of the covered work conveyed by you (or copies made from those copies), or (b) primarily for and in connection with specific products or compilations that contain the covered work, unless you entered into that arrangement, or that patent license was granted, prior to 28 March 2007.

Nothing in this License shall be construed as excluding or limiting any implied license or other defenses to infringement that may otherwise be available to you under applicable patent law.

## 12. No Surrender of Others' Freedom.

If conditions are imposed on you (whether by court order, agreement or otherwise) that contradict the conditions of this License, they do not excuse you from the conditions of this License. If you cannot convey a covered work so as to satisfy simultaneously your obligations under this License and any other pertinent obligations, then as a consequence you may not convey it at all. For example, if you agree to terms that obligate you to collect a royalty for further conveying from those to whom you convey the Program, the only way you could satisfy both those terms and this License would be to refrain entirely from conveying the Program.

## 13. Use with the GNU Affero General Public License.

Notwithstanding any other provision of this License, you have permission to link or combine any covered work with a work licensed under version 3 of the GNU Affero General Public License into a single combined work, and to convey the resulting work. The terms of this License will continue to apply to the part which is the covered work, but the special requirements of the GNU Affero General Public License, section 13, concerning interaction through a network will apply to the combination as such.

## 14. Revised Versions of this License.

The Free Software Foundation may publish revised and/or new versions of the GNU General Public License from time to time. Such new versions will be similar in spirit to the present version, but may differ in detail to address new problems or concerns.

Each version is given a distinguishing version number. If the Program specifies that a certain numbered version of the GNU General Public License "or any later version" applies to it, you have the option of following the terms and conditions either of that numbered version or of any later version published by the Free Software Foundation. If the Program does not specify a version number of the GNU General Public License, you may choose any version ever published by the Free Software Foundation.

If the Program specifies that a proxy can decide which future versions of the GNU General Public License can be used, that proxy's public statement of acceptance of a version permanently authorizes you to choose that version for the Program.

Later license versions may give you additional or different permissions. However, no additional obligations are imposed on any author or copyright holder as a result of your choosing to follow a later version.

## 15. Disclaimer of Warranty.

THERE IS NO WARRANTY FOR THE PROGRAM, TO THE EXTENT PERMITTED BY APPLICABLE LAW. EXCEPT WHEN OTHERWISE STATED IN WRITING THE COPYRIGHT HOLDERS AND/OR OTHER PARTIES PROVIDE THE PROGRAM "AS IS" WITHOUT WARRANTY OF ANY KIND, EITHER EXPRESSED OR IMPLIED, INCLUDING, BUT NOT LIMITED TO, THE IMPLIED WARRANTIES OF MERCHANTABILITY AND FITNESS FOR A PARTICULAR PURPOSE. THE ENTIRE RISK AS TO THE QUALITY AND PERFORMANCE OF THE PROGRAM IS WITH YOU. SHOULD THE PROGRAM PROVE DEFECTIVE, YOU ASSUME THE COST OF ALL NECESSARY SERVICING, REPAIR OR CORRECTION.

## 16. Limitation of Liability.

IN NO EVENT UNLESS REQUIRED BY APPLICABLE LAW OR AGREED TO IN WRITING WILL ANY COPYRIGHT HOLDER, OR ANY OTHER PARTY WHO MODIFIES AND/OR CONVEYS THE PROGRAM AS PERMITTED ABOVE, BE LIABLE TO YOU FOR DAMAGES, INCLUDING ANY GENERAL, SPECIAL, INCIDENTAL OR CONSEQUENTIAL DAMAGES ARISING OUT OF THE USE OR INABILITY TO USE THE PROGRAM (INCLUDING BUT NOT LIMITED TO LOSS OF DATA OR DATA BEING RENDERED INACCURATE OR LOSSES SUSTAINED BY YOU OR THIRD PARTIES OR A FAILURE OF THE PROGRAM TO OPERATE WITH ANY OTHER PROGRAMS), EVEN IF SUCH HOLDER OR OTHER PARTY HAS BEEN ADVISED OF THE POSSIBILITY OF SUCH DAMAGES.

## 17. Interpretation of Sections 15 and 16.

If the disclaimer of warranty and limitation of liability provided above cannot be given local legal effect according to their terms, reviewing courts shall apply local law that most closely approximates an absolute waiver of all civil liability in connection with the Program, unless a warranty or assumption of liability accompanies a copy of the Program in return for a fee.

END OF TERMS AND CONDITIONS

## GNU LESSER GENERAL PUBLIC LICENSE

Version 2.1, February 1999

Copyright (C) 1991, 1999 Free Software Foundation, Inc.

51 Franklin Street, Fifth Floor, Boston, MA 02110-1301 USA

Everyone is permitted to copy and distribute verbatim copies of this license document, but changing it is not allowed.

[This is the first released version of the Lesser GPL. It also counts as the successor of the GNU Library Public License, version 2, hence the version number 2.1.]

### Preamble

The licenses for most software are designed to take away your freedom to share and change it. By contrast, the GNU General Public Licenses are intended to guarantee your freedom to share and change free software to make sure the software is free for all its users.

This license, the Lesser General Public License, applies to some specially designated software packages--typically libraries--of the Free Software Foundation and other authors who decide to use it. You can use it too, but we suggest you first think carefully about whether this license or the ordinary General Public License is the better strategy to use in any particular case, based on the explanations below.

When we speak of free software, we are referring to freedom of use, not price. Our General Public Licenses are designed to make sure that you have the freedom to distribute copies of free software (and charge for this service if you wish); that you receive source code or can get it if you want it; that you can change the software and use pieces of it in new free programs; and that you are informed that you can do these things.

To protect your rights, we need to make restrictions that forbid distributors to deny you these rights or to ask you to surrender these rights. These restrictions translate to certain responsibilities for you if you distribute copies of the library or if you modify it.

For example, if you distribute copies of the library, whether gratis or for a fee, you must give the recipients all the rights that we gave you. You must make sure that they, too, receive or can get the source code. If you link other code with the library, you must provide complete object files to the recipients, so that they can relink them with the library after making changes to the library and recompiling it. And you must show them these terms so they know their rights.

We protect your rights with a two-step method: (1) we copyright the library, and (2) we offer you this license, which gives you legal permission to copy, distribute and/or modify the library.

To protect each distributor, we want to make it very clear that there is no warranty for the free library. Also, if the library is modified by someone else and passed on, the recipients should know that what they have is not the original version, so that the original author's reputation will not be affected by problems that might be introduced by others.

Finally, software patents pose a constant threat to the existence of any free program. We wish to make sure that a company cannot effectively restrict the users of a free program by obtaining a restrictive license from a patent holder. Therefore, we insist that any patent license obtained for a version of the library must be consistent with the full freedom of use specified in this license.

Most GNU software, including some libraries, is covered by the ordinary GNU General Public License. This license, the GNU Lesser General Public License, applies to certain designated libraries, and is quite different from the ordinary General Public License. We use this license for certain libraries in order to permit linking those libraries into non-free programs.

When a program is linked with a library, whether statically or using a shared library, the combination of the two is legally speaking a combined work, a derivative of the original library. The ordinary General Public License therefore permits such linking only if the entire combination fits its criteria of freedom. The Lesser General Public License permits more lax criteria for linking other code with the library.

We call this license the "Lesser" General Public License because it does Less to protect the user's freedom than the ordinary General Public License. It also provides other free software developers Less of an advantage over competing non-free programs. These disadvantages are the reason we use the ordinary General Public License for many libraries. However, the Lesser license provides advantages in certain special circumstances.

For example, on rare occasions, there may be a special need to encourage the widest possible use of a certain library, so that it becomes a de-facto standard. To achieve this, non-free programs must be allowed to use the library. A more frequent case is that a free library does the same job as widely used non-free libraries. In this case, there is little to gain by limiting the free library to free software only, so we use the Lesser General Public License.

In other cases, permission to use a particular library in non-free programs enables a greater number of people to use a large body of free software. For example, permission to use the GNU C Library in non-free programs enables many more people to use the whole GNU operating system, as well as its variant, the GNU/Linux operating system.

Although the Lesser General Public License is Less protective of the users' freedom, it does ensure that the user of a program that is linked with the Library has the freedom and the wherewithal to run that program using a modified version of the Library.

The precise terms and conditions for copying, distribution and modification follow. Pay close attention to the difference between a "work based on the library" and a "work that uses the library". The former contains code derived from the library, whereas the latter must be combined with the library in order to run.

## TERMS AND CONDITIONS FOR COPYING, DISTRIBUTION AND MODIFICATION

**0.** This License Agreement applies to any software library or other program which contains a notice placed by the copyright holder or other authorized party saying it may be distributed under the terms of this Lesser General Public License (also called "this License"). Each licensee is addressed as "you".

A "library" means a collection of software functions and/or data prepared so as to be conveniently linked with application programs (which use some of those functions and data) to form executables.

The "Library", below, refers to any such software library or work which has been distributed under these terms. A "work based on the Library" means either the Library or any derivative work under copyright law: that is to say, a work containing the Library or a portion of it, either verbatim or with modifications and/or translated straightforwardly into another language. (Hereinafter, translation is included without limitation in the term "modification".)

"Source code" for a work means the preferred form of the work for making modifications to it. For a library, complete source code means all the source code for all modules it contains, plus any associated interface definition files, plus the scripts used to control compilation and installation of the library.

Activities other than copying, distribution and modification are not covered by this License; they are outside its scope. The act of running a program using the Library is not restricted, and output from such a program is covered only if its contents constitute a work based on the Library (independent of the use of the Library in a tool for writing it). Whether that is true depends on what the Library does and what the program that uses the Library does.

**1.** You may copy and distribute verbatim copies of the Library's complete source code as you receive it, in any medium, provided that you conspicuously and appropriately publish on each copy an appropriate copyright notice and disclaimer of warranty; keep intact all the notices that refer to this License and to the absence of any warranty; and distribute a copy of this License along with the Library.

You may charge a fee for the physical act of transferring a copy, and you may at your option offer warranty protection in exchange for a fee.

**2.** You may modify your copy or copies of the Library or any portion of it, thus forming a work based on the Library, and copy and distribute such modifications or work under the terms of Section 1 above, provided that you also meet all of these conditions:

- The modified work must itself be a software library.
- You must cause the files modified to carry prominent notices stating that you changed the files and the date of any change.
- You must cause the whole of the work to be licensed at no charge to all third parties under the terms of this License.

- d) If a facility in the modified Library refers to a function or a table of data to be supplied by an application program that uses the facility, other than as an argument passed when the facility is invoked, then you must make a good faith effort to ensure that, in the event an application does not supply such function or table, the facility still operates, and performs whatever part of its purpose remains meaningful.

(For example, a function in a library to compute square roots has a purpose that is entirely well-defined independent of the application. Therefore, Subsection 2d requires that any application-supplied function or table used by this function must be optional: if the application does not supply it, the square root function must still compute square roots.)

These requirements apply to the modified work as a whole. If identifiable sections of that work are not derived from the Library, and can be reasonably considered independent and separate works in themselves, then this License, and its terms, do not apply to those sections when you distribute them as separate works. But when you distribute the same sections as part of a whole which is a work based on the Library, the distribution of the whole must be on the terms of this License, whose permissions for other licensees extend to the entire whole, and thus to each and every part regardless of who wrote it.

Thus, it is not the intent of this section to claim rights or contest your rights to work written entirely by you; rather, the intent is to exercise the right to control the distribution of derivative or collective works based on the Library.

In addition, mere aggregation of another work not based on the Library with the Library (or with a work based on the Library) on a volume of a storage or distribution medium does not bring the other work under the scope of this License.

**3.** You may opt to apply the terms of the ordinary GNU General Public License instead of this License to a given copy of the Library. To do this, you must alter all the notices that refer to this License, so that they refer to the ordinary GNU General Public License, version 2, instead of to this License. (If a newer version than version 2 of the ordinary GNU General Public License has appeared, then you can specify that version instead if you wish.) Do not make any other change in these notices.

Once this change is made in a given copy, it is irreversible for that copy, so the ordinary GNU General Public License applies to all subsequent copies and derivative works made from that copy.

This option is useful when you wish to copy part of the code of the Library into a program that is not a library.

**4.** You may copy and distribute the Library (or a portion or derivative of it, under Section 2) in object code or executable form under the terms of Sections 1 and 2 above provided that you accompany it with the complete corresponding machine-readable source code, which must be distributed under the terms of Sections 1 and 2 above on a medium customarily used for software interchange.

If distribution of object code is made by offering access to copy from a designated place, then offering equivalent access to copy the source code from the same place satisfies the requirement to distribute the source code, even though third parties are not compelled to copy the source along with the object code.

**5.** A program that contains no derivative of any portion of the Library, but is designed to work with the Library by being compiled or linked with it, is called a "work that uses the Library". Such a work, in isolation, is not a derivative work of the Library, and therefore falls outside the scope of this License.

However, linking a "work that uses the Library" with the Library creates an executable that is a derivative of the Library (because it contains portions of the Library), rather than a "work that uses the library". The executable is therefore covered by this License. Section 6 states terms for distribution of such executables.

When a "work that uses the Library" uses material from a header file that is part of the Library, the object code for the work may be a derivative work of the Library even though the source code is not. Whether this is true is especially significant if the work can be linked without the Library, or if the work is itself a library. The threshold for this to be true is not precisely defined by law.

If such an object file uses only numerical parameters, data structure layouts and accessors, and small macros and small inline functions (ten lines or less in length), then the use of the object file is unrestricted, regardless of whether it is legally a derivative work. (Executables containing this object code plus portions of the Library will still fall under Section 6.)

Otherwise, if the work is a derivative of the Library, you may distribute the object code for the work under the terms of Section 6. Any executables containing that work also fall under Section 6, whether or not they are linked directly with the Library itself.

**6.** As an exception to the Sections above, you may also combine or link a "work that uses the Library" with the Library to produce a work containing portions of the Library, and distribute that work under terms

of your choice, provided that the terms permit modification of the work for the customer's own use and reverse engineering for debugging such modifications.

You must give prominent notice with each copy of the work that the Library is used in it and that the Library and its use are covered by this License. You must supply a copy of this License. If the work during execution displays copyright notices, you must include the copyright notice for the Library among them, as well as a reference directing the user to the copy of this License. Also, you must do one of these things:

- Accompany the work with the complete corresponding machine-readable source code for the Library including whatever changes were used in the work (which must be distributed under Sections 1 and 2 above); and, if the work is an executable linked with the Library, with the complete machine readable "work that uses the Library", as object code and/or source code, so that the user can modify the Library and then relink to produce a modified executable containing the modified Library. (It is understood that the user who changes the contents of definitions files in the Library will not necessarily be able to recompile the application to use the modified definitions.)
- Use a suitable shared library mechanism for linking with the Library. A suitable mechanism is one that (1) uses at run time a copy of the library already present on the user's computer system, rather than copying library functions into the executable, and (2) will operate properly with a modified version of the library, if the user installs one, as long as the modified version is interface-compatible with the version that the work was made with.
- Accompany the work with a written offer, valid for at least three years, to give the same user the materials specified in Subsection 6a, above, for a charge no more than the cost of performing this distribution.
- If distribution of the work is made by offering access to copy from a designated place, offer equivalent access to copy the above specified materials from the same place.
- Verify that the user has already received a copy of these materials or that you have already sent this user a copy.

For an executable, the required form of the "work that uses the Library" must include any data and utility programs needed for reproducing the executable from it. However, as a special exception, the materials to be distributed need not include anything that is normally distributed (in either source or binary form) with the major components (compiler, kernel, and so on) of the operating system on which the executable runs, unless that component itself accompanies the executable.

It may happen that this requirement contradicts the license restrictions of other proprietary libraries that do not normally accompany the operating system. Such a contradiction means you cannot use both them and the Library together in an executable that you distribute.

**7.** You may place library facilities that are a work based on the Library side-by-side in a single library together with other library facilities not covered by this License, and distribute such a combined library, provided that the separate distribution of the work based on the Library and of the other library facilities is otherwise permitted, and provided that you do these two things:

- Accompany the combined library with a copy of the same work based on the Library, uncombined with any other library facilities. This must be distributed under the terms of the Sections above.
- Give prominent notice with the combined library of the fact that part of it is a work based on the Library, and explaining where to find the accompanying uncombined form of the same work.

**8.** You may not copy, modify, sublicense, link with, or distribute the Library except as expressly provided under this License. Any attempt otherwise to copy, modify, sublicense, link with, or distribute the Library is void, and will automatically terminate your rights under this License. However, parties who have received copies, or rights, from you under this License will not have their licenses terminated so long as such parties remain in full compliance.

**9.** You are not required to accept this License, since you have not signed it. However, nothing else grants you permission to modify or distribute the Library or its derivative works. These actions are prohibited by law if you do not accept this License. Therefore, by modifying or distributing the Library (or any work based on the Library), you indicate your acceptance of this License to do so, and all its terms and conditions for copying, distributing or modifying the Library or works based on it.

**10.** Each time you redistribute the Library (or any work based on the Library), the recipient automatically receives a license from the original licensor to copy, distribute, link with or modify the Library subject to these terms and conditions. You may not impose any further restrictions on the recipients' exercise of the rights granted herein. You are not responsible for enforcing compliance by third parties with this License.

**11.** If, as a consequence of a court judgment or allegation of patent infringement or for any other reason (not limited to patent issues), conditions are imposed on you (whether by court order, agreement or otherwise) that contradict the conditions of this License, they do not excuse you from the conditions of this License. If you cannot distribute

so as to satisfy simultaneously your obligations under this License and any other pertinent obligations, then as a consequence you may not distribute the Library at all. For example, if a patent license would not permit royalty free redistribution of the Library by all those who receive copies directly or indirectly through you, then the only way you could satisfy both it and this License would be to refrain entirely from distribution of the Library.

If any portion of this section is held invalid or unenforceable under any particular circumstance, the balance of the section is intended to apply, and the section as a whole is intended to apply in other circumstances.

It is not the purpose of this section to induce you to infringe any patents or other property right claims or to contest validity of any such claims; this section has the sole purpose of protecting the integrity of the free software distribution system which is implemented by public license practices. Many people have made generous contributions to the wide range of software distributed through that system in reliance on consistent application of that system; it is up to the author/donor to decide if he or she is willing to distribute software through any other system and a licensee cannot impose that choice.

This section is intended to make thoroughly clear what is believed to be a consequence of the rest of this License.

**12.** If the distribution and/or use of the Library is restricted in certain countries either by patents or by copyrighted interfaces, the original copyright holder who places the Library under this License may add an explicit geographical distribution limitation excluding those countries, so that distribution is permitted only in or among countries not thus excluded. In such case, this License incorporates the limitation as if written in the body of this License.

**13.** The Free Software Foundation may publish revised and/or new versions of the Lesser General Public License from time to time. Such new versions will be similar in spirit to the present version, but may differ in detail to address new problems or concerns.

Each version is given a distinguishing version number. If the Library specifies a version number of this License which applies to it and "any later version", you have the option of following the terms and conditions either of that version or of any later version published by the Free Software Foundation. If the Library does not specify a license version number, you may choose any version ever published by the Free Software Foundation.

**14.** If you wish to incorporate parts of the Library into other free programs whose distribution conditions are incompatible with these, write to the author to ask for permission. For software which is copyrighted by the Free Software Foundation, write to the Free Software Foundation; we sometimes make exceptions for this. Our decision will be guided by the two goals of preserving the free status of all derivatives of our free software and of promoting the sharing and reuse of software generally.

## NO WARRANTY

**15.** BECAUSE THE LIBRARY IS LICENSED FREE OF CHARGE, THERE IS NO WARRANTY FOR THE LIBRARY, TO THE EXTENT PERMITTED BY APPLICABLE LAW. EXCEPT WHEN OTHERWISE STATED IN WRITING THE COPYRIGHT HOLDERS AND/OR OTHER PARTIES PROVIDE THE LIBRARY "AS IS" WITHOUT WARRANTY OF ANY KIND, EITHER EXPRESSED OR IMPLIED, INCLUDING, BUT NOT LIMITED TO, THE IMPLIED WARRANTIES OF MERCHANTABILITY AND FITNESS FOR A PARTICULAR PURPOSE. THE ENTIRE RISK AS TO THE QUALITY AND PERFORMANCE OF THE LIBRARY IS WITH YOU. SHOULD THE LIBRARY PROVE DEFECTIVE, YOU ASSUME THE COST OF ALL NECESSARY SERVICING, REPAIR OR CORRECTION.

**16.** IN NO EVENT UNLESS REQUIRED BY APPLICABLE LAW OR AGREED TO IN WRITING WILL ANY COPYRIGHT HOLDER, OR ANY OTHER PARTY WHO MAY MODIFY AND/OR REDISTRIBUTE THE LIBRARY AS PERMITTED ABOVE, BE LIABLE TO YOU FOR DAMAGES, INCLUDING ANY GENERAL, SPECIAL, INCIDENTAL OR CONSEQUENTIAL DAMAGES ARISING OUT OF THE USE OR INABILITY TO USE THE LIBRARY (INCLUDING BUT NOT LIMITED TO LOSS OF DATA OR DATA BEING RENDERED INACCURATE OR LOSSES SUSTAINED BY YOU OR THIRD PARTIES OR A FAILURE OF THE LIBRARY TO OPERATE WITH ANY OTHER SOFTWARE), EVEN IF SUCH HOLDER OR OTHER PARTY HAS BEEN ADVISED OF THE POSSIBILITY OF SUCH DAMAGES.

## END OF TERMS AND CONDITIONS

### How to Apply These Terms to Your New Libraries

If you develop a new library, and you want it to be of the greatest possible use to the public, we recommend making it free software that everyone can redistribute and change. You can do so by permitting redistribution under these terms (or, alternatively, under the terms of the ordinary General Public License).

To apply these terms, attach the following notices to the library. It is safest to attach them to the start of each source file to most effectively

convey the exclusion of warranty; and each file should have at least the "copyright" line and a pointer to where the full notice is found. one line to give the library's name and an idea of what it does.

Copyright (C) year name of author

This library is free software; you can redistribute it and/or modify it under the terms of the GNU Lesser General Public License as published by the Free Software Foundation; either version 2.1 of the License, or (at your option) any later version.

This library is distributed in the hope that it will be useful, but WITHOUT ANY WARRANTY; without even the implied warranty of MERCHANTABILITY or FITNESS FOR A PARTICULAR PURPOSE. See the GNU Lesser General Public License for more details.

You should have received a copy of the GNU Lesser General Public License along with this library; if not, write to the Free Software Foundation, Inc., 51 Franklin Street, Fifth Floor, Boston, MA 02110-1301 USA Also add information on how to contact you by electronic and paper mail.

You should also get your employer (if you work as a programmer) or your school, if any, to sign a "copyright disclaimer" for the library, if necessary. Here is a sample; alter the names:

Yoyodyne, Inc., hereby disclaims all copyright interest in the library 'Frob' (a library for tweaking knobs) written by James Random Hacker.  
signature of Ty Coon, 1 April 1990 Ty Coon, President of Vice.

## OpenSSL LICENSE

Copyright (c) 1998-2006 The OpenSSL Project. All rights reserved. Redistribution and use in source and binary forms, with or without modification, are permitted provided that the following conditions are met:

1. Redistributions of source code must retain the above copyright notice, this list of conditions and the following disclaimer.
2. Redistributions in binary form must reproduce the above copyright notice, this list of conditions and the following disclaimer in the documentation and/or other materials provided with the distribution.
3. All advertising materials mentioning features or use of this software must display the following acknowledgment: "This product includes software developed by the OpenSSL Project for use in the OpenSSL Toolkit. (<http://www.openssl.org/>)"
4. The names "OpenSSL Toolkit" and "OpenSSL Project" must not be used to endorse or promote products derived from this software without prior written permission. For written permission, please contact [openssl-core@openssl.org](mailto:openssl-core@openssl.org).
5. Products derived from this software may not be called "OpenSSL" nor may "OpenSSL" appear in their names without prior written permission of the OpenSSL Project.
6. Redistributions of any form whatsoever must retain the following acknowledgment: "This product includes software developed by the OpenSSL Project for use in the OpenSSL Toolkit (<http://www.openssl.org/>)"

THIS SOFTWARE IS PROVIDED BY THE OPENSSL PROJECT "AS IS" AND ANY EXPRESSED OR IMPLIED WARRANTIES, INCLUDING, BUT NOT LIMITED TO, THE IMPLIED WARRANTIES OF MERCHANTABILITY AND FITNESS FOR A PARTICULAR PURPOSE ARE DISCLAIMED. IN NO EVENT SHALL THE OPENSSL PROJECT OR ITS CONTRIBUTORS BE LIABLE FOR ANY DIRECT, INDIRECT, INCIDENTAL, SPECIAL, EXEMPLARY, OR CONSEQUENTIAL DAMAGES (INCLUDING, BUT NOT LIMITED TO, PROCUREMENT OF SUBSTITUTE GOODS OR SERVICES; LOSS OF USE, DATA, OR PROFITS; OR BUSINESS INTERRUPTION) HOWEVER CAUSED AND ON ANY THEORY OF LIABILITY, WHETHER IN CONTRACT, STRICT LIABILITY, OR TORT (INCLUDING NEGLIGENCE OR OTHERWISE) ARISING IN ANY WAY OUT OF THE USE OF THIS SOFTWARE, EVEN IF ADVISED OF THE POSSIBILITY OF SUCH DAMAGE. This product includes cryptographic software written by Eric Young ([ey@cryptsoft.com](mailto:ey@cryptsoft.com)). This product includes software written by Tim Hudson ([tjh@cryptsoft.com](mailto:tjh@cryptsoft.com)).

## Original SSLeay License

Copyright (C) 1995-1998 Eric Young ([ey@cryptsoft.com](mailto:ey@cryptsoft.com)) All rights reserved. This package is an SSL implementation written by Eric Young ([ey@cryptsoft.com](mailto:ey@cryptsoft.com)). The implementation was written so as to conform with Netscapes SSL. This library is free for commercial and non-commercial use as long as the following conditions are adhered to. The following conditions apply to all code found in this distribution, be it the RC4, RSA, lhash, DES, etc., code; not just the SSL code. The SSL documentation included with this distribution is covered by the same copyright terms except that the holder is Tim Hudson ([tjh@cryptsoft.com](mailto:tjh@cryptsoft.com)).

Copyright remains Eric Young's, and as such any Copyright notices in the code are not to be removed.

If this package is used in a product, Eric Young should be given attribution as the author of the parts of the library used. This can be in the form of a textual message at program startup or in documentation

(online or textual) provided with the package. Redistribution and use in source and binary forms, with or without modification, are permitted provided that the following conditions are met:

1. Redistributions of source code must retain the copyright notice, this list of conditions and the following disclaimer.
2. Redistributions in binary form must reproduce the above copyright notice, this list of conditions and the following disclaimer in the documentation and/or other materials provided with the distribution.
3. All advertising materials mentioning features or use of this software must display the following acknowledgement: "This product includes cryptographic software written by Eric Young (eay@cryptsoft.com)" The word 'cryptographic' can be left out if the rouines from the library being used are not cryptographic related :-).
4. If you include any Windows specific code (or a derivative thereof) from the apps directory (application code) you must include an acknowledgement: "This product includes software written by Tim Hudson (tjh@cryptsoft.com)"

THIS SOFTWARE IS PROVIDED BY ERIC YOUNG "AS IS" AND ANY EXPRESS OR IMPLIED WARRANTIES, INCLUDING, BUT NOT LIMITED TO, THE IMPLIED WARRANTIES OF MERCHANTABILITY AND FITNESS FOR A PARTICULAR PURPOSE ARE DISCLAIMED. IN NO EVENT SHALL THE AUTHOR OR CONTRIBUTORS BE LIABLE FOR ANY DIRECT, INDIRECT, INCIDENTAL, SPECIAL, EXEMPLARY, OR CONSEQUENTIAL DAMAGES (INCLUDING, BUT NOT LIMITED TO, PROCUREMENT OF SUBSTITUTE GOODS OR SERVICES; LOSS OF USE, DATA, OR PROFITS; OR BUSINESS INTERRUPTION) HOWEVER CAUSED AND ON ANY THEORY OF LIABILITY, WHETHER IN CONTRACT, STRICT LIABILITY, OR TORT (INCLUDING NEGLIGENCE OR OTHERWISE) ARISING IN ANY WAY OUT OF THE USE OF THIS SOFTWARE, EVEN IF ADVISED OF THE POSSIBILITY OF SUCH DAMAGE. The licence and distribution terms for any publically available version or derivative of this code cannot be changed. i.e. this code cannot simply be copied and put under another distribution licence [including the GNU Public Licence.



### **Correct Disposal of This Product** (Waste Electrical & Electronic Equipment)

---

(Applicable in the European Union and other European countries with separate collection systems)

This marking on the product, accessories or literature indicates that the product and its electronic accessories (e.g. charger, headset, USB cable) should not be disposed of with other household waste at the end of their working life. To prevent possible harm to the environment or human health from uncontrolled waste disposal, please separate these items from other types of waste and recycle them responsibly to promote the sustainable reuse of material resources.

Household users should contact either the retailer where they purchased this product, or their local government office, for details of where and how they can take these items for environmentally safe recycling.

Business users should contact their supplier and check the terms and conditions of the purchase contract. This product and its electronic accessories should not be mixed with other commercial wastes for disposal.



### **Correct disposal of batteries in this product**

---

(Applicable in the European Union and other European countries with separate battery return systems.)

This marking on the battery, manual or packaging indicates that the batteries in this product should not be disposed of with other household waste at the end of their working life. Where marked, the chemical symbols Hg, Cd or Pb indicate that the battery contains mercury, cadmium or lead above the reference levels in EC Directive 2006/66. If batteries are not properly disposed of, these substances can cause harm to human health or the environment.

To protect natural resources and to promote material reuse, please separate batteries from other types of waste and recycle them through your local, free battery return system.





## SALES NETWORK

---

### **SAMSUNG TECHWIN CO., LTD.**

Samsungtechwin R&D Center, 701, Sampyeong-dong, Bundang-gu, Seongnam-si, Gyeonggi-do, Korea, 463-400  
TEL : +82-70-7147-8740~60 FAX : +82-31-8018-3745

### **SAMSUNG TECHWIN AMERICA Inc.**

100 Challenger Rd. Suite 700 Ridgefield Park, NJ 07660  
Toll Free : +1-877-213-1222 Direct : +1-201-325-6920  
Fax : +1-201-373-0124  
[www.samsungsv.com](http://www.samsungsv.com)

### **SAMSUNG TECHWIN EUROPE LTD.**

Samsung House, 1000 Hillswood Drive, Hillswood Business  
Park Chertsey, Surrey, UNITED KINGDOM KT16 OPS  
TEL : +44-1932-45-5300 FAX : +44-1932-45-5325

---

[www.samsungtechwin.com](http://www.samsungtechwin.com)  
[www.samsungsecurity.com](http://www.samsungsecurity.com)  
[www.samsungipolis.com](http://www.samsungipolis.com)



## Free Manuals Download Website

<http://myh66.com>

<http://usermanuals.us>

<http://www.somanuals.com>

<http://www.4manuals.cc>

<http://www.manual-lib.com>

<http://www.404manual.com>

<http://www.luxmanual.com>

<http://aubethermostatmanual.com>

Golf course search by state

<http://golfingnear.com>

Email search by domain

<http://emailbydomain.com>

Auto manuals search

<http://auto.somanuals.com>

TV manuals search

<http://tv.somanuals.com>