



SAMSUNG CAMERA

User Manual

Digital Camera

Digimax 420

Thank you for buying a Samsung Camera.

This manual will guide you through using the Digimax 420, including capturing images, downloading images and using the MGI PhotoSuite III SE software. Please read this manual carefully before using your new camera.

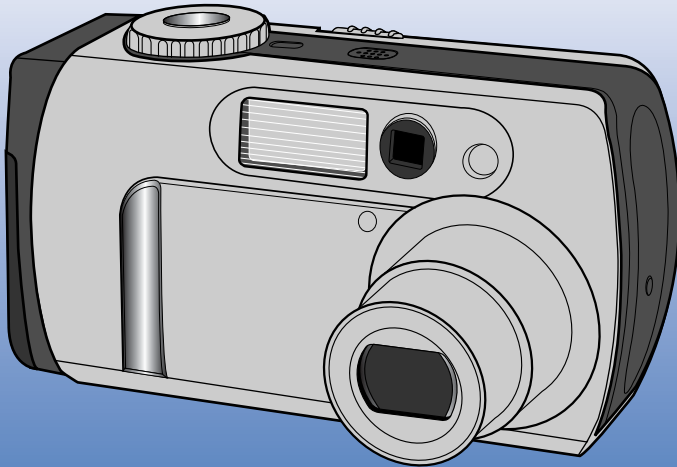

ENGLISH

Instructions

- Use this camera in the following order

Set up the camera driver

Before connecting the camera to a PC, via the USB cable, you will need to set up the camera driver. Install the camera driver that is contained in the Application S/W CD-ROM.(p.94)

Take a picture

Take a picture (p.25)

Insert the USB cable

Insert the supplied USB cable into the PC USB port and the camera USB connection terminal.(p.82)

Check the camera power

Check the camera power. If the power is turned off, slide the camera switch to power it on.(p.28)

Check [Removable Disk]

Open Window's EXPLORER and search for [Removable Disk].(p.83)

Contents

READY

READY

- Getting to know your camera 5
- About the icons 5
- Danger 6
- Warning 7
- Caution 8
- Special features 9
- This digital camera can be used for 10
- Manufacturer's contents 12
- Identification of features 13
- Front & Top 13
- Back & Bottom 13
- Side 14
- 5-function button 14
- Camera status lamp 15
- Mode dial 16
- Connecting to Power Source 17
- Attaching the strap 19
- Instructions on how to use the
memory card 20
- Inserting the memory card 22
- Removing the memory card 22

- Using the camera button to adjust the
camera 28
- POWER switch 28
- SHUTTER button 28
- LCD button 29
- MENU button 30
- MACRO button 31
- WIDE / TELE button 32
- Voice memo / UP button 34
- Metering / Down button 35
- Flash / left button 36
- Self-timer / Right button 38
- OK button 38
- Using the LCD monitor to adjust the
camera 39
- Size 40
- Quality 41
- Effect 42
- Shooting 43
- Exposure 44
- ISO 46
- White balance 47
- Scene 48

RECORDING

- LCD monitor indicator 23
- Starting recording mode 25

PLAY

- Starting the play mode 49
- LCD monitor indicator 51

Contents

● LCD button	52	● Sound	78
● Menu button	52	● LCD brightness	78
● Delete button	53	● Video out	79
● Thumbnail / Enlargement button	54	● Connecting to an external monitor	80
● Left / Right / OK button	55	● Quick view	81
● Voice memo / Up button	56	● Starting PC mode	82
● Play & Pause / Down button	57	● Important notes	85
● Setting up the play back function using the LCD monitor	58	● Warning indicator	86
● Slide show	59	● Before contacting a service center	87
● Protect	60	● Specifications	90
● Delete all	61		
● Copy to card	62		
● DPOF : Standard	63		
● DPOF : Index	65		

SETUP

● Setup menu	66	● Software Notes	92
● Format	67	● About the software	92
● File name	69	● Setting up the application software	94
● Power off	70	● Removing the USB Driver for Windows 98SE	100
● Language	71	● Removable Disk	102
● Date setup	72	● Removing the removable disk	103
● Imprint	73	● Setting up the USB Driver for MAC	105
● Date type	74	● Using the USB Driver for MAC	105
● User set	74	● Digimax Viewer	106
● List of camera function	75	● MGI PhotoSuite III SE	107
		● FAQ	122

SOFTWARE

Getting to know your camera

Thank you for buying a Samsung Digital Camera.

- Prior to using this camera, please read the user manual thoroughly.
- When you require After Sales service, please bring the camera and the cause of the camera malfunction (such as Batteries, Memory card etc.) to the A/S center.
- Keep the manual in a safe place.

About the icons

This manual contains instructions on using this camera that will help you to use this camera safely and correctly. This will help prevent danger and injury to others.



DANGER

DANGER indicates an imminently hazardous situation which, if not avoided, will result in death or serious injury.



WARNING

WARNING indicates a potentially hazardous situation, which, if not avoided, could result in death or serious injury.



CAUTION

CAUTION indicates a potentially hazardous situation, which, if not avoided, may result in a minor or moderate injury.



NOTICE

NOTICE indicates a factor, which, if not avoided, may result in camera malfunction or poor image quality.



INFORMATION

INFORMATION indicates a factor, which should assist further in the operation of the camera.



Danger

- Do not attempt to modify this camera in any way. This may result in fire, injury, electric shock or severe damage to you or your camera. Internal inspection, maintenance and repairs should be carried out by your dealer or Samsung Camera Service Center.

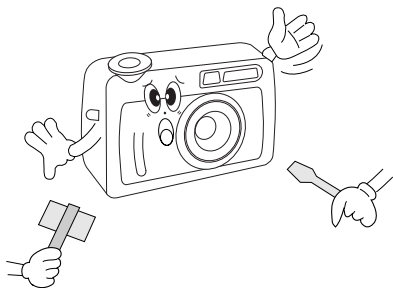

- Please do not use this product in close proximity to flammable or explosive gases, as this could increase the risk of explosion.

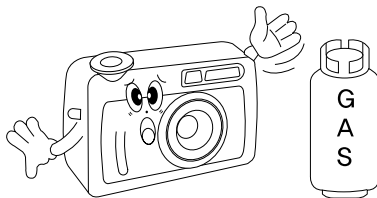

- Should any form of liquid or a foreign object enter the camera, do not use it. Switch off the camera, and then disconnect the power source (batteries or AC Power Adapter). You must contact your dealer or Samsung Camera Service Center. Do not continue to use the camera as this may cause a fire or electric shock.

- Do not insert or drop metallic or inflammable foreign objects into the camera through access points e.g. CARD slot and battery chamber. This may cause a fire or electric shock.

- Do not operate this camera with wet hands. This could pose a risk of electric shock.

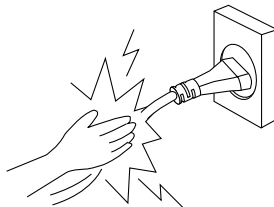



Warning

- Do not use the flash in close proximity to people or animals. Positioning the flash too close to your subject's eyes, may cause eyesight damage.

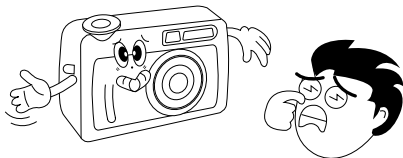

- When taking photographs, never point the lens of the camera directly into very strong light. This may result in permanent damage to the camera or your eyesight.

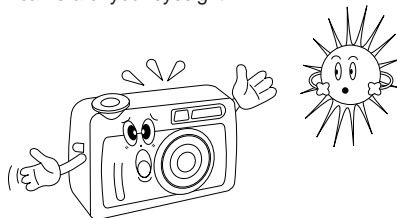

- For safety reasons keep this product and accessories out of reach of children or animals to prevent accidents e.g.:

- Swallowing batteries or small camera accessories. In case of accidents, please consult a doctor immediately.
- There is a possibility of injury from the camera's moving parts.

- Do not leave this camera in places subject to extremely high temperatures, such as a sealed vehicle, direct sunlight or other places of extreme variances in temperature. Exposure to extreme temperatures may adversely affect the camera's internal components and could cause a fire.

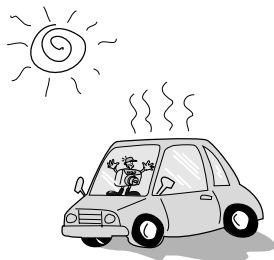

- Batteries and camera may become hot during prolonged use and it may result in camera malfunction. Should this be the case, allow the camera to sit idle for a few minutes to allow it time to cool.

- Do not recharge the non rechargeable batteries. It may cause an explosion.

- When in use, do not cover the camera or AC Power Adapter. This may cause heat to build up and distort the camera body or cause a fire. Always use the camera and its accessories in a well-ventilated area.

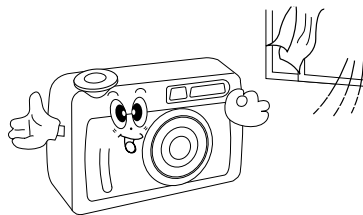



Caution

- Leaking, overheating, or burst batteries could result in fire or injury.
 - Use batteries with the correct specification for the camera.
 - Do not short circuit, heat or dispose of batteries in fire.
 - Do not use old batteries with new ones, or mix brands of batteries.
 - Ensure the batteries are positioned correctly with regard to polarity (+ / -).

- When the camera is not in use for long periods, always unplug the camera from its power source.

- Do not fire the flash while it is in contact with hands or objects. Do not touch the flash after using it continuously. It may cause burns.

- Do not move the camera while it is switched on, if you are using the AC Power Adapter. After use, always switch off the camera before unplugging the adapter from the AC Power wall socket. Then make sure that any connector cords or cables to other devices are disconnected before moving the camera. Failure to do so may damage the cords or cables and cause a fire or electric shock.

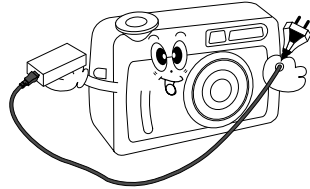

Special features

This digital camera has the following features.

- A high resolution of 4.0 mega pixels
- A 3X optical and 4 X digital zoom lens
- Movie clip & Voice recording function
- An easy and fast PC interface with USB Storage Driver & Digimax viewer
- Compact size & ergonomic design
- A Super macro(6cm) function
- 16MB internal flash memory

An FCC warning

• This device has been tested in accordance with the limits of a class B digital device under item 15 of the FCC rules. These limits are designed to provide protection against harmful interference in commercial installation. This equipment generates, absorbs and can emit radio frequency energy. If it is not installed and used in accordance with the instructions, it may cause harmful interference to radio communication. There is however, no guarantee that interference will not occur in some situations. Should any interference occur when this device is in operation, please try one or more of the following measures.

- Change the location and direction of any aerial.
 - Increase distance between camera and affected device.
 - Use a different socket away from the affected device.
 - Please contact a Samsung agent or a radio/TV engineer.
- This device complies with part 15 of the FCC Rules.

This digital camera can be used for

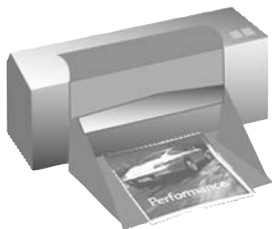

Printing images using a dedicated printer, DPOF-compatible printer or DPOF-equipped photo lab.
(refer to page 63)



Viewing images on TV.
(refer to page 79)



Taking a picture.
(refer to page 25)



Down loading image files from camera to computer.
(refer to page 83)



Editing images on a PC.
(refer to page 107)

This digital camera can be used for

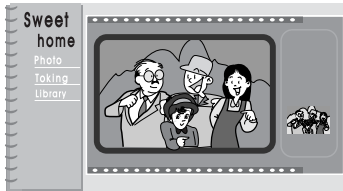

Creation of a digital photo album.



Recording your voice.
(refer to page 34/56)



Inserting images directly
into any electronic
document.



Recording a movie clip
(refer to page 25)

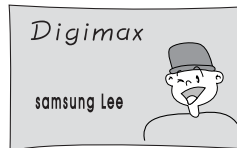

Taking a self-portrait
and using the image
to personalize name
cards.

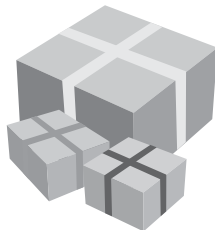

You can even create your own unique gift wrap
paper by using your digital images.

Manufacturer's contents

Please check that you have the correct contents before using this product.

 marked contents are optional.

Digital Camera



2 AA Alkaline Batteries



Pouch



AV cable



USB cable



Camera strap



User manual



Product warranty



Software CD

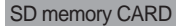

 SD memory CARD



Battery pack
(SBP-3603)

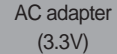

 AC adapter
(3.3V)



Digimax Battery I-Pack : SBP-1103 KIT

Battery charger



Rechargeable battery



AC adapter(5V)



Identification of features

Front & Top

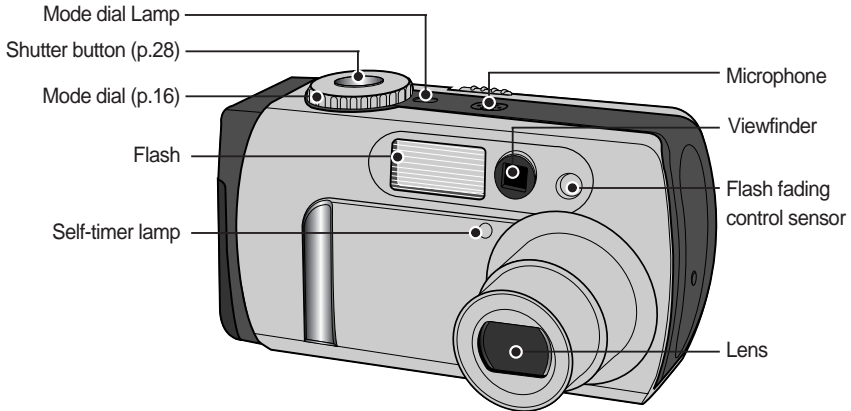

Back & Bottom

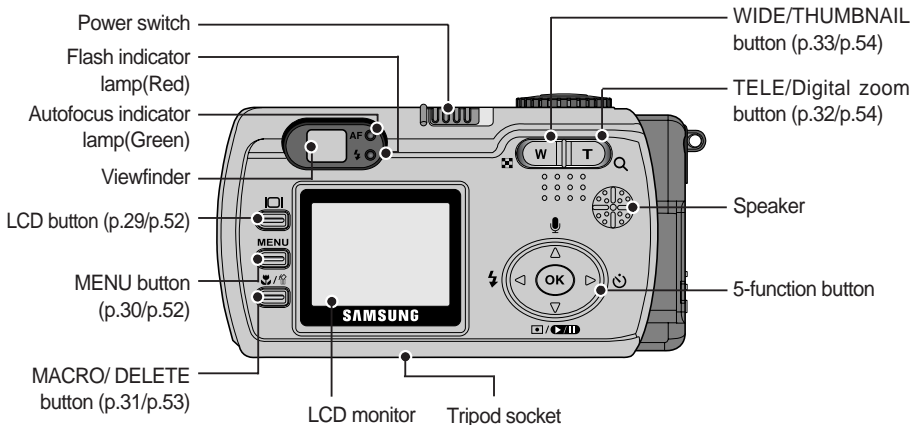

Identification of features

Side

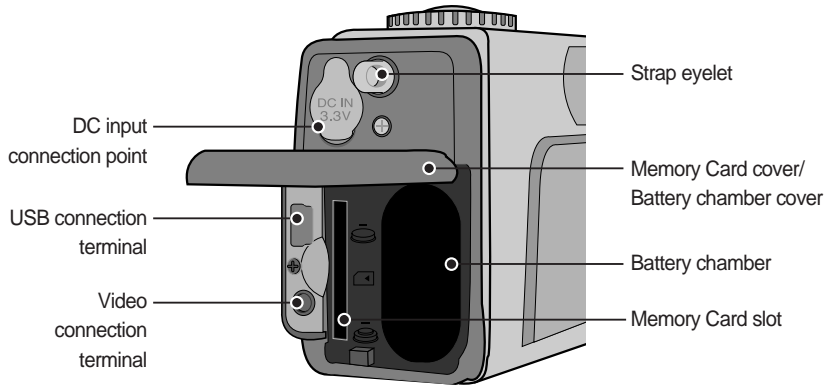

5-function button

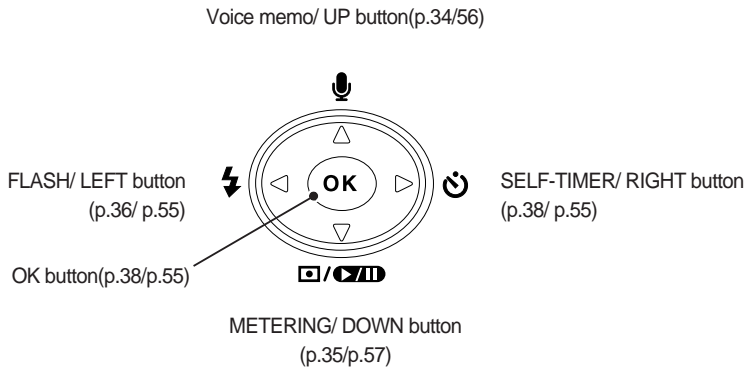

Camera status lamp

READY

Lamp	Status	Camera condition
Autofocus indicator lamp (Green)	OFF	System ready
	ON	Power on processing
		The camera focuses on the subject. (Pressing the shutter button half way down)
	Blinking	Image processing (compression/ decompression)
		USB busy (PC mode)
		The camera cannot focus on the subject.
Flash indicator lamp (Red)	Blinking	Flash charge processing
	ON	Flash ready
Self-timer lamp (Red)	Blinking	For the first seven seconds, the LED blinks at 1 second intervals. For the final three seconds, the LED blinks rapidly at 0.5-second intervals.
Mode dial lamp (Green)	ON	Whenever the LCD monitor is off
		When the USB cable is connected.
		When the A/V cable is connected.

Mode dial

- You can select the desired working mode by using the mode dial located on the top of the camera.
- This digital camera has 4 working modes. These are listed below.

MOVIE CLIP

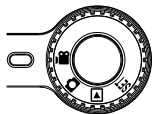

- **Movie clip mode**

A movie clip can be recorded for as long as the available recording time of the memory capacity allows. Image size and type are listed below.

- Image size : 288X208 - File type : *.AVI

STILL IMAGE

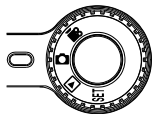

- **Still image mode**

This mode is used for still image shots.

Macro shot – W : 6cm ~ 80cm T: 40cm ~ 80cm

Normal shot – 80cm ~ infinity.

PLAY

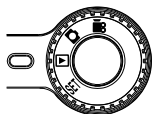

- **Play mode**

In this mode, the stored images on the memory can be viewed on the LCD monitor on the back of the camera or on an external monitor using a Video connection terminal. A recorded audio file can also be played back in this mode.

SETUP

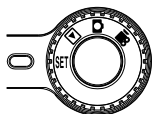

- **Setup mode**

In this mode, you can set up basic settings such as Format, File name, Auto power off, Date setup, Date imprint, Date type, User set, Sound, LCD brightness, Video out, Quick view.

Connecting to a Power Source

- There are two ways in which to provide the camera with power. You can use batteries or alternatively, you can use an AC(100 ~ 250V) Adapter (DC 3.3V 2.0A).
- We recommend using batteries for a digital camera.(Within a year from the date of manufacture) The batteries are listed below.

Non rechargeable batteries : AA type – Alkaline, Ni-Mn, Ni-Zn, Lithium
CR-V3 type – Lithium

Rechargeable batteries : AA type – Ni-MH, Ni-Cd (over 1000mA)
CR-V3 type – Digimax Battery I-Pack(SBP-1103)
Battery pack – Digimax Battery Pack(SBP-3603)



[AA type battery]



[CR-V3 type battery]



[Battery pack]



NOTICE

Important information about battery usage

- It is easy to buy alkaline batteries. However, the duration for using batteries varies in accordance with the battery manufacturer or the photographic conditions.
When the camera is not used, turn off the camera power.
- Do not recharge the non rechargeable batteries. It may cause an explosion.
- Please remove the batteries if the camera will not be used for long periods.
Batteries can lose power over time and are prone to leaking if kept inside the camera.
- We recommend high capacity ALKALINE batteries as manganese batteries cannot deliver sufficient power.
- Low temperatures (below 0°C) can affect the performance of the batteries and you may experience reduced battery life.
- Batteries will usually recover at normal temperatures.
- Do not use old and new batteries at the same time.
- During extended use of the camera, the camera body may become warm. This is perfectly normal.
- If you are planning to use this camera for long periods of time, it is advisable to use an AC adapter(3.3V 2.0A).

Connecting to a Power Source

Using the batteries

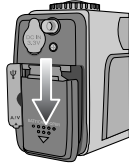

1. Open the battery chamber cover by pushing in the direction of the arrow.

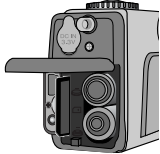

[Inserting the AA type battery]

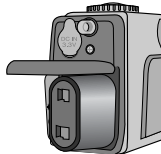

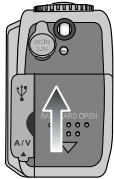

[Inserting the CR-V3 type battery]

2. Insert the batteries taking note of the polarity (+ / -).



3. To close the battery chamber cover, push it until it clicks.

■ There are 3 indicators for battery condition that are displayed on the LCD monitor.

Battery indicator			
Battery status	The batteries are fully charged.	Prepare new batteries.	There is no battery capacity. Replace with new batteries.

Using the Digimax battery pack (Optional : SBP-3603, 3.3V)

The Digimax Battery Pack is a rechargeable external Li-ion battery for use with most digital cameras. These optional battery packs provide long lasting power and their operating performances are much improved over Ni-MH and Alkaline batteries. This is due to the mass storage lithium ion cell.

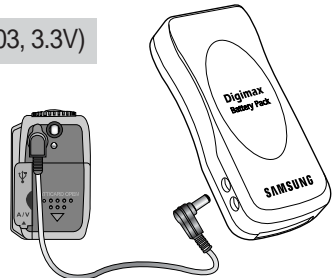

Connecting to a Power Source

Using the AC power adapter (3.3V 2.0A)

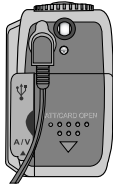

If you have access to a mains supply, using an AC Adapter (3.3V 2.0A) allows the camera to be used for long periods of time.

Plug the adapter into the connection point (DC IN 3.3V) on the camera. Remove the batteries when using the AC adapter.



DANGER

- Always turn off the power before taking the AC adapter out of the mains supply.
- As with all mains powered devices, safety is important. Ensure that neither the camera nor adapter comes into contact with water or metallic materials.
- Please ensure that you use an AC adapter (3.3V 2.0A) with the correct specification for the camera. Failure to do so may affect your warranty.

Attaching the strap

To prevent accidental damage to the camera, always use the strap. Refer to the illustrations below.

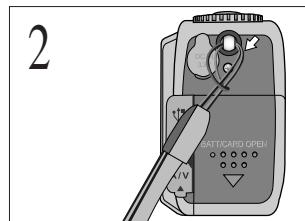
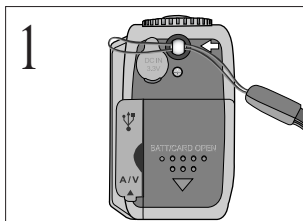

Instructions on how to use the memory card

- The camera comes with 16MB of internal flash memory, allowing you to store images and movie clips in the camera. However, you can expand the memory capacity by using an optional memory card so that you can store more images and movie clips.

Maintenance of the memory card

- Turn off the camera power whenever the memory card is being inserted or removed.
- Repeated use of the memory card will eventually reduce the memory card's performance. Should this be the case, you will need to purchase a new memory card.
- Wear and tear on the memory card is not covered by the Samsung warranty.
- The memory card is an electronic precision device.
Do not bend, drop or subject the memory card to any heavy impact.
- Do not store the memory card in an environment with strong electronic or magnetic fields, e.g. near loud speakers or TV receivers.
- Please do not use or store in an environment where there are extremes in temperature.
- Do not allow the memory card to become dirty or to come into contact with any liquid.
Should this happen, clean the memory card with a soft cloth.
- Please keep the memory card in its case when not in use.
- During and after periods of extended use, you may notice that the memory card is warm.
This is perfectly normal.
- Do not use a memory card that is used in another digital camera or memory card reader.
- Do not use a memory card formatted by another digital camera or memory card reader.

Preserving the memory card data

- If the memory card is subjected to any of the following, the recorded data may become corrupted :
 - When the memory card is used incorrectly.
 - If the power is switched off or the memory card is removed while recording, deleting (formatting) or reading.
- Samsung cannot be held responsible for lost data.
- It is advisable to copy important data onto other media as back-up e.g. floppy disks, hard disks, CD etc.
- If there is insufficient memory available :If you press the shutter button for the shot, a [CARD FULL !] message will appear and the camera will not operate. To optimize the amount of memory in the camera, replace the memory card or delete unnecessary images stored on the memory.

Instructions on how to use the memory card

NOTICE

- If you open the memory card cover when the camera power is turned on, the power will turn off automatically.
- Don't remove the memory card when the Autofocus indicator lamp(Green) is blinking as this may cause damage to data in the memory card.

- You can use an SD memory card only.

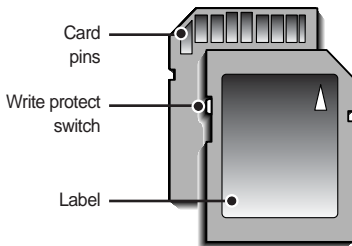

【SD(Secure Digital) memory card】

The SD memory card has a write protect switch that prevents image files from being deleted or formatted. By sliding the switch to the bottom of the SD memory card, the data will be protected. By sliding the switch to the top of the SD memory card, the data protection will be canceled. Slide the switch to the top of the SD memory card before taking a picture.

- When using a 16MB internal memory, the specified shooting capacity will be as follows. (These figures are intended as an indication of expected performance). These figures are approximate as image capacities can be affected by variables such as subject matter.

Recorded image size	Super fine	Fine	Normal
2272X1704 (Large)	6	13	20
2272X1504 (Photo)	7	15	23
1120X840 (Medium)	28	56	84
544X408 (Small)	109	199	299

Inserting the memory card

1. Turn off the camera power and pull the memory card cover in the direction of the arrow to open.

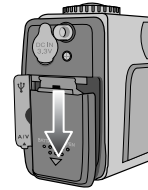

2. Insert the memory card all the way into the memory card slot. The Label stuck to the memory card and the front side of the camera should face in the same direction. The memory card pins and the LCD monitor should face in the same direction.

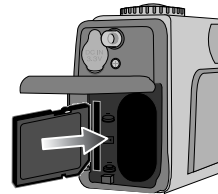

3. To close, push the card cover until you hear a click. If the card cover does not close, check that the memory card is inserted correctly. Do not force the memory card.

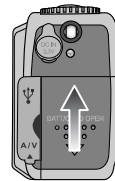

CAUTION

CAUTION

- Do not insert the reverse side of the memory card. It may cause memory card slot breakage.

Removing the memory card

1. Turn the power off using the power switch. Open the memory card cover and press the memory card as shown in the image and release.

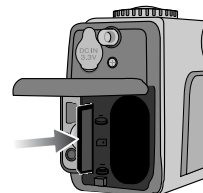

2. Remove the memory card and close the memory card cover.





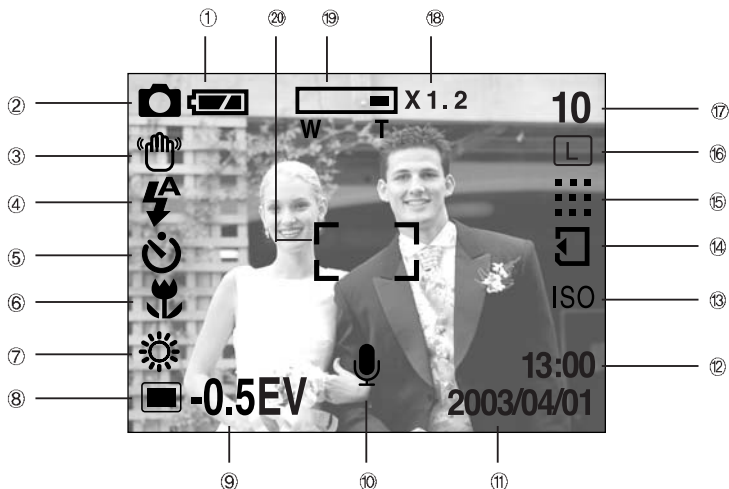









LCD monitor indicator

- The LCD monitor displays information about the shooting functions and selections.



【Image & Full Status】

RECORDING

No.	Description	Icons	Page
1	Battery	  	p.18
2	Recording mode	  	p.16
3	Camera shake warning		p.27
4	Flash	    	p.36
5	Self-timer		p.38
6	Macro	  2M 1M	p.31

LCD monitor indicator

No.	Description	Icons	Page
7	White Balance		p.47
8	Metering		p.35
9	Exposure compensation	-2.0EV ~ +2.0EV	p.44
10	Voice memo		p.34
11	Date	2003/04/01	p.72~74
12	Time	13:00	
13	ISO	ISO	p.46
14	Memory card indicator		
15	Quality		p.41
16	Image size		p.40
17	Number of available shots remaining (still image)	10	
	Recording time (movie clip)	01:00 (Minute:Second)	
18	Digital zoom	X1.2	p.32~33
19	Optical zoom		
20	Auto focus frame		

Starting recording mode

- If the memory card is inserted in the camera, all the camera functions apply only to the memory card.
- If the memory card is not inserted in the camera, all the camera functions apply only to the internal memory.

Recording a Movie clip

1. Insert the batteries (p.18). Insert the batteries taking note of the polarity (+ / -).
2. Insert the memory card (p.22). As this camera has a 16MB internal memory, you do not need to insert the memory card. If the memory card is not inserted, an image will be stored in the internal memory. To expand memory capacity, insert a memory card. If the memory card is inserted, an image will be stored on the memory card.
3. Close the memory card cover.
4. Slide the power switch to turn on the camera.
If the date/time that is displayed on the LCD monitor is incorrect, reset the date/time before taking a picture. (p.72)
5. Select the MOVIE CLIP() mode by rotating the mode dial.
6. Point the camera towards the subject and compose the shot by using the viewfinder or LCD monitor.
7. Press the shutter button and movie clips are recorded for as long as the available recording time of the memory permits.
 - Movie clips will still be recorded if the shutter button is released.
 - If you wish to stop recording, press the shutter button again.
 - Image size and type are listed below.
 - Image size : 288 x 208
 - File type : *.AVI

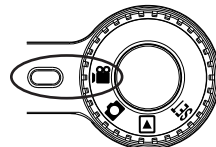

[Movie clip mode]

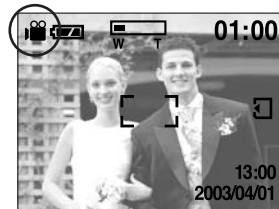

INFORMATION

- Depending on the shooting conditions, the available recording time may be changed.

Starting recording mode

Recording a still image

Steps 1 - 4 are the same as those for recording a movie clip.

5. Select the STILL IMAGE() mode by rotating the mode dial.

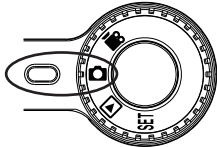

[Still image mode]

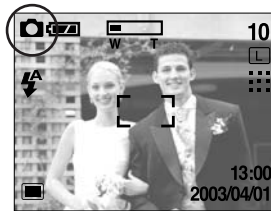

6. Point the camera towards the subject and compose the image by using either the viewfinder or LCD monitor.
7. Press the shutter button to capture an image.



CAUTION

CAUTION

- A Blinking autofocus indicator lamp means that the camera cannot focus on the subject. Should this be the case, the camera is unable to capture an image clearly.



INFORMATION

- There are two LED lamps (one green, one red) positioned next to the viewfinder. If the camera is in focus when you press the shutter button halfway, the green LED will illuminate and you can capture an image. If the camera can focus on the subject, the autofocus frame in the center of the LCD monitor will change from white to green. If the red lamp illuminates, the flash can fire.

Starting recording mode



NOTICE

- Camera shake warning.
When the Flash Off or Slow synchro mode is selected in a low lighting condition, the camera shake warning indicator () may appear on the LCD monitor. In this case, use a tripod, support the camera on a solid surface or change the flash mode to flash shot mode.
- Backlight compensated shots
When taking an outdoor shot, avoid facing the sun, as the image may be dark because of the strong backlight. In conditions where there is a strong backlight, please use exposure compensation (p.44).
- Avoid obstructing the lens or the flash when you capture an image.
- As there can be some differences between what is seen through the Viewfinder and the resulting image when taken at a range closer than 1.5m, it is recommended that you use the LCD monitor to compose the shot.
- Using the LCD monitor extensively will drain the batteries.
We recommend turning off the LCD monitor and using the optical viewfinder as often as possible in order to extend battery life.
- Under certain conditions the auto focus system may not perform as expected.
 - When photographing a subject that has little contrast.
 - If the subject is highly reflective or shiny.
 - If the subject is moving at high speed.
 - When there is strong reflected light, or when the background is very bright.
 - When the subject matter has only horizontal lines or the subject is very narrow (such as a stick or flagpole).
 - In dark conditions

Using the camera button to adjust the camera

- The STILL IMAGE / MOVIE CLIP mode function can be set up by using the camera button.

POWER switch

- Used for turning the camera power on / off.
- If this camera isn't operated during the specified time(about 60 SEC.), the camera power will be idle(LCD monitor : Off, Mode dial lamp : ON) automatically.

To use the camera again, press any of the camera buttons except the power switch.

If there is no operation during the specified time after the idle mode, the camera power will be turned off automatically to save battery life.

Pressing the power button for over 2 seconds will deactivate the buzzer sound function.

If you wish to hear the buzzer sound, set the [SOUND] settings in the SETUP mode to ON.

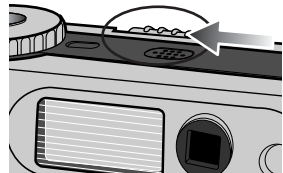

SHUTTER button

- Used for taking an image or recording audio in the RECORDING (STILL IMAGE, MOVIE CLIP) mode.
- In MOVIE CLIP mode
Pressing the shutter button down fully starts the process for recording a movie clip. Press the shutter button once and the movie clip is recorded for as long as the available recording time in the memory allows. If you wish to stop recording, press the shutter button again.
- In STILL IMAGE mode

Pressing the shutter button down halfway activates the autofocus and checks the condition of the flash. Pressing the shutter down fully takes the image and stores the relevant data regarding the shot. If you select voice memo recording, the recording will start after storing the image data is complete.(Voice Recording time : 10sec)

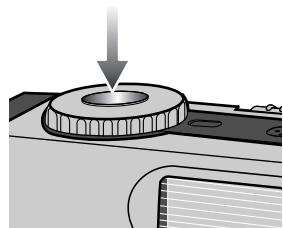

LCD(LO) button

- You can check the recording status in the LCD monitor.
- Pressing the LCD button in the RECORDING (STILL IMAGE, MOVIE CLIP) mode will change the display as shown below.



MOVIE CLIP mode

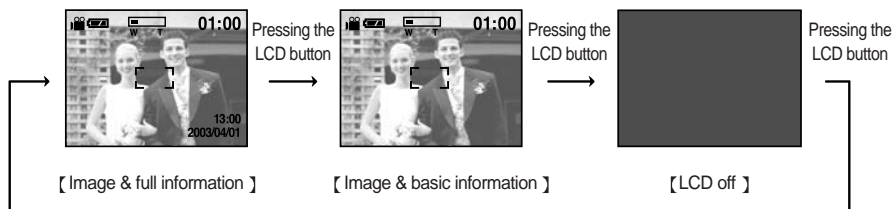

STILL IMAGE mode

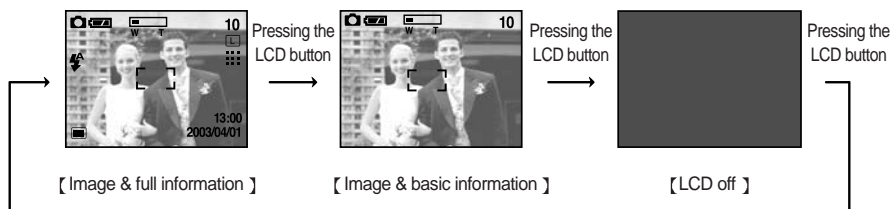

MENU button

- When you press the MENU button, a menu related to each camera mode will be displayed on the LCD monitor. Pressing it again will return the LCD to the initial display.
- A menu option can be displayed when the following are selected : STILL IMAGE mode, MOVIE CLIP mode, PLAY mode and SETUP mode. There is no menu available when the PC mode is selected.

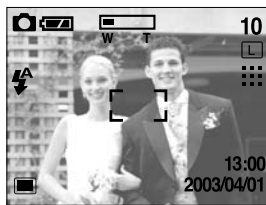
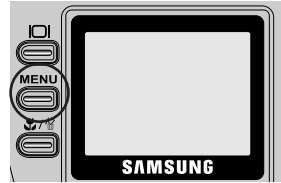

【MENU off】

Pressing the
MENU button

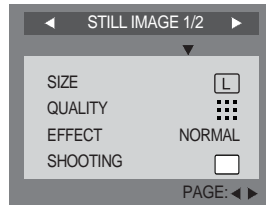

【MENU on】



INFORMATION

- The menu will not be displayed on the LCD monitor in the following circumstances:
 - When another button is being operated.
 - While image data is being processed.(when the green lamp next to the viewfinder blinks)
 - When there is no battery capacity.
- When the menu is showing on the LCD monitor, it is not possible to operate the shutter button i.e. capture an image. To capture an image, simply cancel the menu display by pressing the MENU button.

MACRO() button

- Used for macro shots
 - Wide : 6cm~ 80cm Tele: 40cm ~ 80cm
- In dark conditions, the auto focus may not function. If this occurs, press the MACRO button and you can select fixed focus manually.

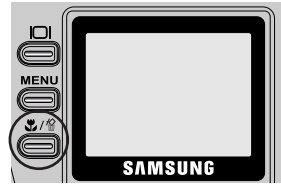

- Selecting the focus mode
Pressing the Macro button will change the focus mode as shown below.

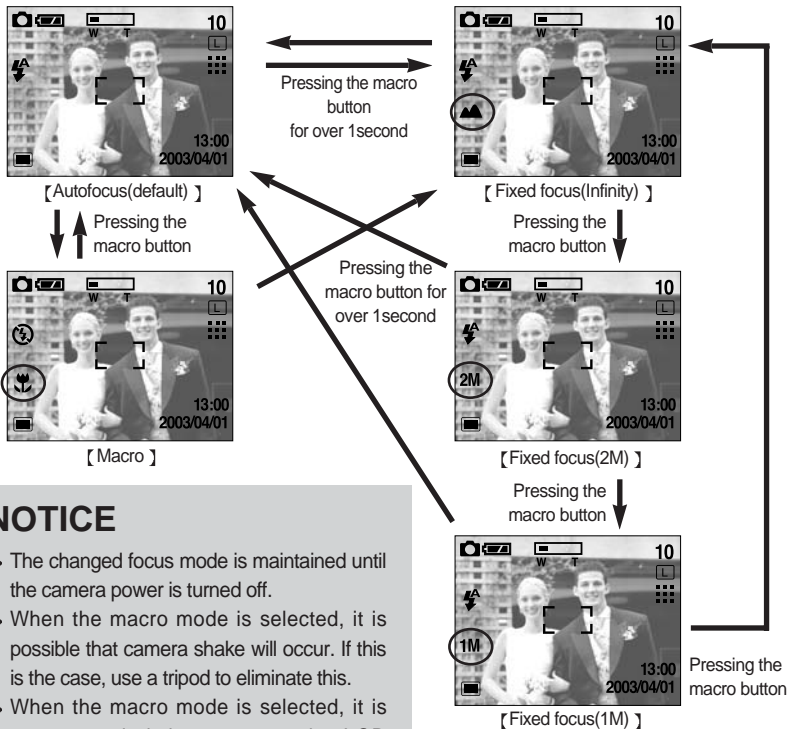

NOTICE

- The changed focus mode is maintained until the camera power is turned off.
- When the macro mode is selected, it is possible that camera shake will occur. If this is the case, use a tripod to eliminate this.
- When the macro mode is selected, it is recommended that you use the LCD monitor to compose these shots.

WIDE / TELE button

- Used for digital or optical zooming in / out.
- This camera has a 3X optical zoom and a 4X digital zoom function. Using both will offer a total zoom ratio of 12X.
- When you press the zoom (W/T) button, the zoom bar will display in the upper left of the LCD monitor.

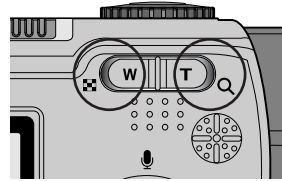

TELE Zoom

- TELE Optical zoom
Pressing the T zoom button.
This will zoom into the subject i.e. the subject will appear nearer.
- TELE Digital zoom
When the maximum (3X) optical zoom is selected, pressing the T zoom button activates the digital zoom software and increases the digital zoom ratio by 0.2 steps.
Releasing the zoom button T stops the digital zooming at the required setting.
Once the maximum digital zoom (4X) is achieved, pressing the T zoom button will have no effect.
You can check the digital zoom rate with the [X1.2 ~ X 4.0] numerical mark next to the zoom bar.



[WIDE zoom]

Pressing the
TELE button
→



[TELE zoom]

Pressing the
TELE button
→

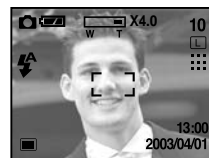

[Digital zoom 4.0X]



INFORMATION

- To use the digital zoom the LCD monitor has to be turned on.
- Images taken using the digital zoom may take a little longer for the camera to process. Allow time for this to take place.
- While the digital zoom is activated, you can't select the continuous and AEB menu.
- To use the continuous, AEB shot, cancel the digital zoom mode.
- You may notice a decrease in image quality when using the digital zoom.
- If a movie clip is being recorded, the zoom operation cannot be activated.

WIDE / TELE button

WIDE Zoom

· WIDE Optical zoom

Pressing the W zoom button. This will zoom out from the subject i.e. the subject will appear further away. Pressing the W button continuously will set the camera to its minimum zoom setting i.e. the subject appears at its furthest from the camera.

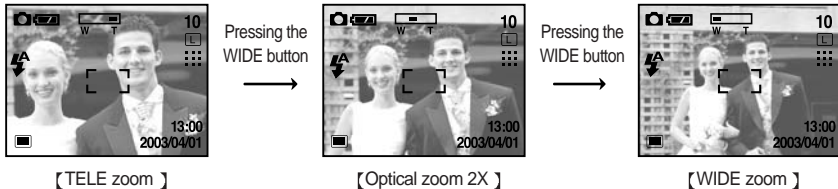

· WIDE Digital zoom

When the digital zoom is in operation, pressing the W zoom button will reduce the digital zooming in steps. Releasing the W zoom button stops digital zooming. Pressing the W button will reduce the digital zoom and it will then proceed to reduce the optical zoom until the minimum setting is reached.

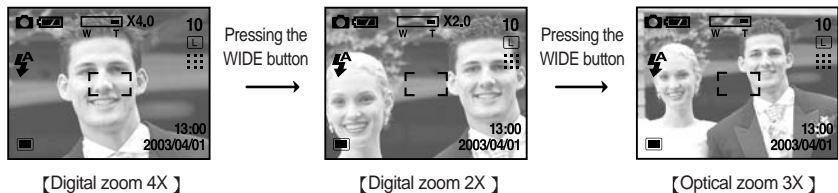

CAUTION

- Take care not to touch the lens to avoid taking an unclear image and possibly causing camera malfunction. If the image is dim, turn the camera power off and on again to modify the lens position.
- Take care not to press the lens as this may cause a camera malfunction.
- When the camera is turned on, take care not to touch the camera's moving lens parts as this may cause the resulting image to be dim and unclear.
- Take care not to touch the lens during the zoom operation as this may cause damage.

Voice memo(🎤) / Up (▲) button

- When the menu is displayed on the LCD monitor, pressing the UP button makes the menu cursor move up or change the sub menu value.
- When the menu is not displayed on the LCD monitor, the UP button operates as the voice memo button. You can add audio such as your voice to a stored still image.
- Recording a voice memo
 1. Rotate the mode dial to the STILL IMAGE mode.
 2. Press the VOICE MEMO button.

If the voice memo indicator is displayed on the LCD monitor, the setting is completed.
 3. Press the shutter button and take a picture.

The picture is stored on the memory card.
 4. Voice memo will be recorded for ten seconds from the moment the picture is stored. In the middle of the sound recording, pressing the shutter button will stop the voice memo.

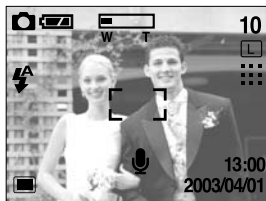

[Ready for recording]

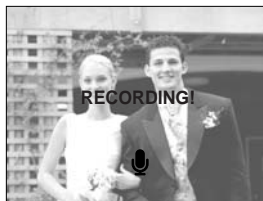



[Recording a voice memo]



INFORMATION

- A distance of 40cm between you and the camera (microphone) is the best distance to record a voice memo.
- The Voice memo function is inactivated after finishing a voice memo.
- If you record a new voice memo to an image that had a voice memo, the existing voice memo is replaced with the new voice memo.

Metering() / Down() button

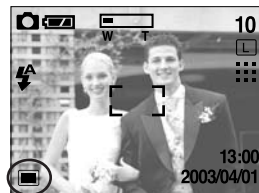

- When the menu is displayed on the LCD monitor, pressing the DOWN() button makes the cursor shift to down or changes the sub menu.
- When the menu is not displayed on the LCD monitor, the DOWN() button operates as the METERING() button.
This button can be used to obtain the right exposure.

- Selecting the metering mode
 1. Rotate the mode dial to the STILL IMAGE mode.
 2. If the desired metering mode indicator is displayed on the LCD monitor when pressing the METERING button, the function is ready for recording.



[Selecting Multi metering]

- METERING mode indicator

Indicator	Mode	Description
	Multi pattern	Exposure will be calculated based on an average of the available light in the image area. However, the calculation will be biased towards the centre of the image area.
	Spot	Use this function when there is backlight or when photographing a subject that has little contrast. In backlighting conditions adjust the light metering to suit the subject matter.



INFORMATION

- The default metering mode is Multi pattern metering.
- The changed metering mode is maintained until the camera power is turned off.

Flash(⚡)/ left(◀) button

- When the menu is displayed on the LCD monitor, pressing the LEFT(◀) button makes the cursor shift to the main menu.
- When the menu is not displayed on the LCD monitor, the LEFT(◀) button operates as the FLASH (⚡) button.

- Selecting the flash mode

1. Rotate the mode dial to the STILL IMAGE mode.
2. Press the Flash(⚡) button until the desired flash mode indicator displays on the LCD monitor.
3. A flash mode indicator will be displayed on the LCD monitor.
Use the correct flash to suit the environment.

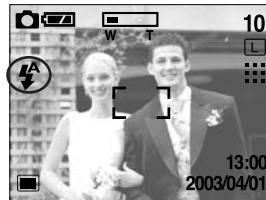

[Selecting the Auto flash]

- Flash mode indicator

Indicator	Flash mode	Definition
	Auto flash	If the subject or background is dark, the camera flash will operate automatically.
	Auto & Red eye reduction	If a subject or background is dark, the camera flash will work automatically and will reduce the red-eye effect by using the red-eye reduction function.
	Slow synchro	The flash will operate in conjunction with a slow shutter speed in order to obtain the correct exposure. We recommend using a tripod for this function. When you take an image in a condition with poor light, the camera shake warning indicator (⚡) will display on the LCD monitor.
	Fill in flash	The flash fires regardless of available light. The intensity of the flash will be controlled, according to the prevailing conditions. The brighter the background or subject is, the less intense the flash will be.
	Flash off	The flash does not fire. Select this mode when capturing images in a place or situation where flash photography is prohibited. When you capture an image in a poorly lit condition, the camera shake warning indicator (⚡) will display on the LCD monitor.

Flash(⚡)/ left(◀) button



INFORMATION

- Using the flash frequently will reduce the life of the batteries.
- Under normal operating conditions the charging time for the flash is normally within 10 seconds. If the batteries are weak, the charging time will be longer.
- During continuous shooting mode, AEB mode or movie clip mode, the flash function will not operate.



NOTICE

- Take photographs within the flash range.
- The flash ranges are listed below.

ISO		AUTO	100	200	400
Normal focus	WIDE	0.8~3m	0.8~2.6m	1~3.7m	1~5.2m
	TELE	0.8~2m	0.8~1.5m	1~2.1m	1~2.9m
Macro	WIDE	0.3~0.8m	0.3~0.8m	0.3~0.8m	0.3~0.8m
	TELE	0.4~0.8m	0.4~0.8m	0.4~0.8m	0.4~0.8m

- The image quality is not guaranteed if the subject is too close or highly reflective.
- The LCD monitor is turned off for a while after using the flash to recharge it.

Self-timer(☺) / Right(▶) button

- When the menu is displayed on the LCD monitor, pressing the Right button makes the cursor shift to the sub menu.
- When the menu is not displayed on the LCD monitor, the RIGHT button operates as the Self-timer(☺) button. This function is used when the photographer would also like to be in the image.
- Selecting the self-timer
 1. Rotate the mode dial to the STILL IMAGE/ MOVIE CLIP mode.
 2. If the self-timer indicator is displayed on the LCD monitor by pressing the self-timer button, the setting is completed.
 3. Pressing the shutter button will allow an interval of ten seconds before the image is taken. After that, the self-timer is canceled.

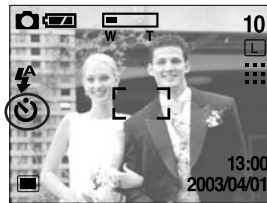

[Selecting the self-timer]



INFORMATION

- The default is OFF.
- The self-timer LED lamp(red) and the self-timer indicator on the LCD monitor will blink for 10 seconds after the self-timer button has been pressed.
 - For the first seven seconds, the LED blinks at one second intervals.
 - For the final three seconds, the LED blinks quickly at 0.5-second intervals.
- If you operate the Power switch, Mode dial or Shutter button during the self-timer operation, the self-timer function is cancelled.
- Use a tripod to prevent the camera from shaking.

OK button

- Used for confirming data that is changed by using ▲/▼/◀/▶ buttons.

Using the LCD monitor to adjust the camera

- Using the LCD monitor to adjust the camera
 - Recording functions can be changed by using the LCD monitor.
 - In the STILL IMAGE/ MOVIE CLIP mode, pressing the MENU button displays the menu on the LCD monitor.
 - The following functions are available, depending on the mode you have selected.

Camera working mode	Menu
Still image mode	Size, Quality, Effect, Shooting, Exposure compensation, ISO, White balance, Scene
Movie clip mode	White balance, Effect

RECORDING



INFORMATION

- The menu will not be displayed on the LCD monitor in the following circumstances:
 - When another button is being operated.
 - While image data is being processed. (when the green LED next to the viewfinder blinks)
 - When there is no battery capacity.
- When the menu is showing on the LCD monitor, it is not possible to operate the shutter button i.e. capture an image. To capture an image, simply cancel the menu display by pressing the MENU button.

Size

- You can select the image size you require.

1. Rotate the mode dial to the STILL IMAGE mode and press the MENU button.
2. Select the [SIZE] menu by pressing the UP/DOWN button.
3. Press the RIGHT button and the cursor will shift to the [SIZE] sub menu.
4. Select the desired sub menu by pressing the UP/DOWN button.
5. Press the OK button to confirm the setting.
6. Press the menu button and the menu display will disappear. Take a picture.

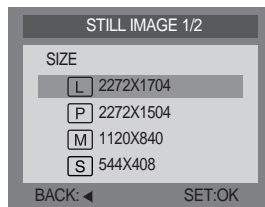
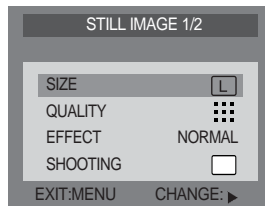

INFORMATION

- A large image uses more memory, so increasing the image size will reduce the total number of shots you can store in the memory.
- Even if the camera is restarted, the image size setting is maintained.
- The image sizes are listed below.

Icons	L	P	M	S
Image size	2272x1704	2272x1504	1120x840	544x408

Quality

■ In STILL IMAGE mode, you can select the image quality (Data compression rate).

1. Rotate the mode dial to the STILL IMAGE mode and press the MENU button.
2. Select the [QUALITY] menu by pressing the UP/DOWN button.
3. Press the RIGHT button and the cursor will shift to the [QUALITY] sub menu.
4. Select the desired sub menu by pressing the UP/DOWN button.
5. Press the OK button to confirm the setting.
6. Press the menu button and the menu display will disappear. Take a picture.

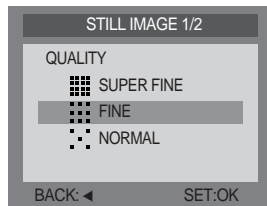
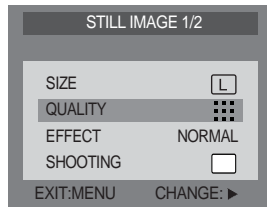

RECORDING



INFORMATION

- The higher the QUALITY setting, the better the final image will be. However, the high quality setting will require more memory and therefore reduce the number of images you can store on the memory.
- SUPER FINE is the highest quality and NORMAL is the lowest setting. Choose the setting appropriate for your needs.
- The image file is stored in *.jpg.
- This file format complies with the DCF(Design rule for Camera File system).
- Even if the camera should be restarted, the quality setting is maintained.
- When using the 16MB internal memory, the specified shooting capacity will be as follows. (These figures are intended as an indication of expected performance)

	Digimax 420			
Quality \ Size	L	P	M	S
Super fine	6	7	28	109
Fine	13	15	56	199
Normal	20	23	84	299

Effect

- Using the camera's digital processor, it is possible to add special effects to your images.

1. Rotate the mode dial to the STILL IMAGE or MOVIE CLIP mode and press the MENU button.
2. Select the [EFFECT] menu by pressing the UP/DOWN button.

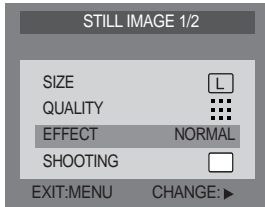

[STILL IMAGE mode]

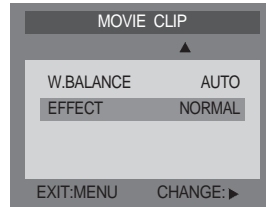

[MOVIE CLIP mode]

3. Press the RIGHT button and the cursor will shift to the [EFFECT] sub menu.
4. Select the desired sub menu by pressing the UP/DOWN button.

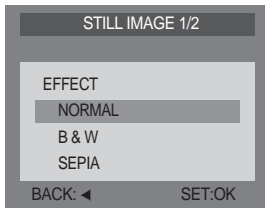

[STILL IMAGE mode]

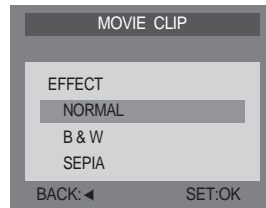

[MOVIE CLIP mode]

- NORMAL : No effect is added to the image.
- B & W : Converts the image to black and white.
- SEPIA : Converts the image to a sepia tone

5. Press the OK button to confirm the setting.
6. Press the menu button and the menu display will disappear. Take a picture.

Shooting

- You can select continuous shooting or AEB(Auto Exposure Bracket) shooting in this menu.

1. Rotate the mode dial to the STILL IMAGE mode and press the MENU button.
2. Select the [SHOOTING] menu by pressing the UP/DOWN button.
3. Press the RIGHT button and the cursor will shift to the [SHOOTING] sub menu.
4. Select the desired sub menu by pressing the UP/DOWN button.
5. Press the OK button to confirm the setting.
 - SINGLE : you can take only one picture at a time.
 - CONTINUOUS : In this mode, you can capture moving subjects continuously.
 - AEB : In this mode, you can take a 3-image bracket(-0.5EV, 0.0EV, +0.5EV) of a scene.

When you select continuous shooting, a window will display as shown alongside. Select the number of continuous shots by pressing the UP/ DOWN button. Depending on the memory capacity, the number of continuous shots may vary.

6. Press the menu button and the menu display will disappear. Take a picture.

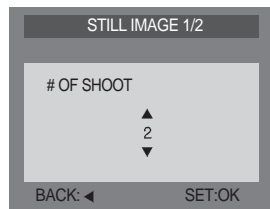
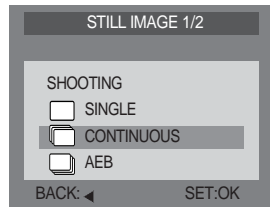
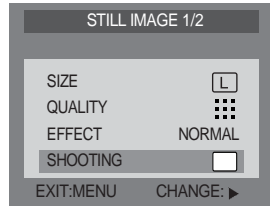

INFORMATION

- The flash mode is set to "flash off" in continuous shooting and AEB shooting. After completing the continuous or AEB shot, the shooting mode is changed to [SINGLE] automatically.
- Once a continuous sequence has begun, it will continue until the selected number of shots has been taken. Releasing the shutter button will not interrupt this function.

Shooting



INFORMATION

- To take continuous shots, the number of available shots must be more than 2 because the minimum numbers of continuous shots permitted are 2. To take the AEB shots, the number of available shots must be more than 3 because of the same reason.
- Camera shake can be a problem when using the AEB shooting mode and it takes time to store the AEB image to the memory. We recommend using a tripod.
- In continuous shot and AEB mode, the digital zoom function will not operate.
- When using the 16MB internal memory, the specified continuous shooting capacity will be as follows. (These figures are intended as an indication of expected performance)

	Digimax 420			
Quality \ Size	L	P	M	S
Super fine	3	3	14	56
Fine	6	7	26	99
Normal	9	10	37	99

Exposure

- This camera automatically adjusts the exposure according to the ambient lighting conditions. However, you can select the exposure value by using the [EXPOSURE] sub menu. In the STILL IMAGE mode, you can select the exposure value.
 - If you increase the exposure value, the image will be brighter.
 - If you decrease the exposure value, the image will be darker.

1. Rotate the mode dial to the STILL IMAGE mode and press the MENU button.
2. Select the [STILL IMAGE 2/2] menu by pressing the RIGHT button.
3. Select the [EXPOSURE] menu by pressing the UP/DOWN button.

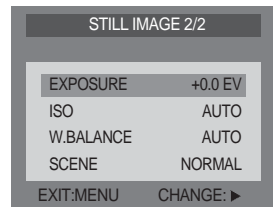

[STILL IMAGE mode]

Exposure

4. Press the RIGHT button and the cursor will shift to the [EXPOSURE] sub menu.
5. Select the desired sub menu by pressing the UP/DOWN button.



【STILL IMAGE mode】

6. Press the OK button to confirm the setting.
7. Press the menu button and the menu display will disappear. Take a picture.



INFORMATION

- Exposure compensation setting range : -2.0 ~ +2.0 EV (0.5 EV steps)
- This change to the exposure will remain until the camera is switched off. When the camera is turned on again, the exposure compensation setting returns to 0.0EV (discarding the exposure compensation).
- When you have selected a change in exposure value, the value is displayed on the LCD.
- Decreasing or increasing the exposure value may lead to images being under or over exposed (too dark or too bright). Review your images using the LCD monitor to check that they have been successful.

ISO

- You can select the camera's sensitivity to light by selecting the ISO sub menu. The speed or specific light-sensitivity of a camera is rated by ISO numbers. In the STILL IMAGE mode, you can select the ISO value.

- The higher the number, the more sensitive it is to light. As with film, the higher speeds usually induce more electronic noise so the image gets grainier.

1. Rotate the mode dial to the STILL IMAGE mode and press the MENU button.
2. Select the [STILL IMAGE 2/2] menu by pressing the RIGHT button.
3. Select the [ISO] menu by pressing the UP/DOWN button.

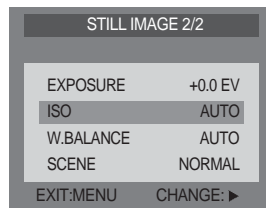

【 STILL IMAGE mode 】

4. Press the RIGHT button and the cursor will shift to the [ISO] sub menu.
5. Select the desired sub menu by pressing the UP/DOWN button.

· AUTO : The camera's sensitivity is automatically changed by variables such as lighting value or subject brightness.

· 100/ 200/ 400 : In the same lighting conditions, the higher the ISO value is, the faster the shutter speed will be. However, the images can be saturated in very bright conditions.

6. Press the OK button to confirm the setting.
7. Press the menu button and the menu display will disappear. Take a picture.

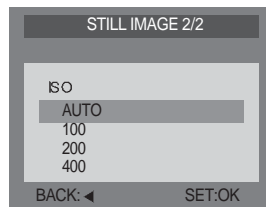

【 STILL IMAGE mode 】

White balance

- The white balance control allows you to adjust the colours to appear more natural looking. Different lighting conditions may cause a colour cast on your images.

1. Rotate the mode dial to the STILL IMAGE or MOVIE CLIP mode and press the MENU button.
2. Select the [STILL IMAGE 2/2] menu by pressing the RIGHT button.
(In the MOVIE CLIP mode, just press the UP/DOWN button to select the [W.BALANCE] menu.)
3. Select the [W.BALANCE] menu by pressing the UP/DOWN button.

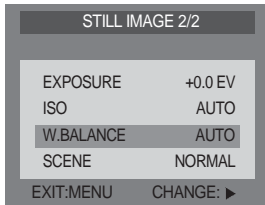

[STILL IMAGE mode]

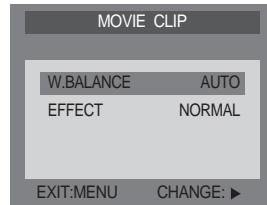

[MOVIE CLIP mode]

4. Press the RIGHT button and the cursor will shift to the [W.BALANCE] sub menu.
5. Select the desired sub menu by pressing the UP/DOWN button.

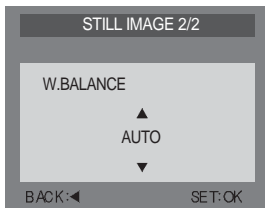

[STILL IMAGE mode]

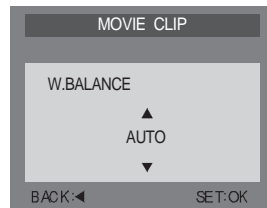

[MOVIE CLIP mode]

- ① **AUTO** : The camera automatically selects the appropriate white balance settings, depending on the prevailing lighting conditions.
 - ② **DAYLIGHT** : For taking images outside.
 - ③ **CLOUDY** : For taking images under a cloudy and overcast sky.
 - ④ **SUNSET** : For taking images at sunset.
 - ⑤ **FLUOR.** : For shooting under fluorescent lighting.
 - ⑥ **TUNGSTEN** : For shooting under tungsten (standard light bulb) lighting.
6. Press the OK button to confirm the setting. The changed white balance is maintained until the camera power is turned off.
 7. Press the menu button and the menu display will disappear. Take a picture.

Scene

- Select the [NIGHT] sub menu in a low lighting condition and you can get a clearer image

1. Rotate the mode dial to the STILL IMAGE mode and press the MENU button.
2. Select the [STILL IMAGE 2/2] menu by pressing the RIGHT button.
3. Select the [SCENE] menu by pressing the UP/DOWN button.
4. Press the RIGHT button and the cursor will shift to the [SCENE] sub menu.
5. Select the desired sub menu by pressing the UP/DOWN button.
6. Press the OK button to confirm the setting.
 - NORMAL : select this mode in a normal shooting condition.
 - NIGHT : select this mode in a low lighting condition.
7. Press the menu button and the menu display will disappear. Take a picture.

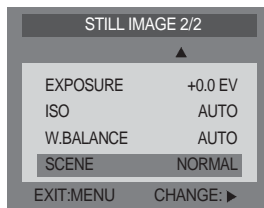

【 STILL IMAGE mode 】

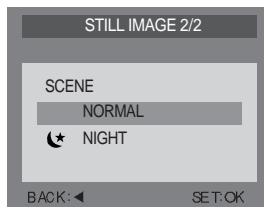

INFORMATION

- In [NIGHT] mode, don't move for a while after the flash has finished firing as the shutter speed is slow. We recommend using a tripod or supporting the camera on a solid object in order to avoid camera shake.
- In [NIGHT] mode, you can't use the macro focus.

Starting the play mode

- If the memory card is inserted in the camera, all the camera functions apply only to the memory card.
- If the memory card is not inserted in the camera, all the camera functions apply only to the internal memory.
- Turn the camera on and select the PLAY(▶) mode by rotating the MODE dial. The camera can now play back the images stored on a memory.
- You can set up the PLAY mode function by using the camera buttons and LCD monitor.

Playing back a movie clip

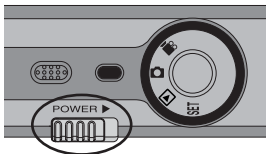

1. Slide the power switch to turn on the camera.

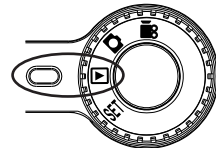

2. Select the PLAY(▶) mode by rotating the mode dial.



3. The last image stored on the memory is displayed on the LCD monitor.

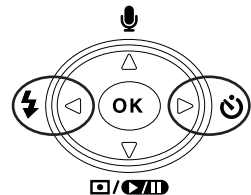

4. Select the movie clip that you want to play back by using the LEFT(◀)/RIGHT(▶) button.

- ※ Keep the LEFT/ RIGHT button pressing and the images are shown rapidly.
- If you select a movie clip file, the movie clip indicator(▶) will be displayed on the LCD monitor.
- Press the PLAY & PAUSE button to play back a movie clip. To pause it while playing back a movie clip, press the PLAY & PAUSE button again. To stop play back, press the LEFT / RIGHT button.

Starting the play mode

Playing back a still image

Steps from 1-3 are the same as those to play back a movie clip.

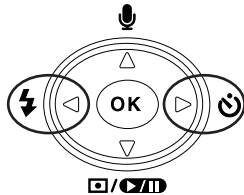

4. Select an image that you want to play back by pressing the LEFT / RIGHT button.



5. If an image that has a voice memo is selected, the voice memo indicator will be displayed on the LCD monitor.

· Press the PLAY & PAUSE button to play back the memo.

To pause it while playing back a voice memo, press the PLAY & PAUSE button again.

To stop play back, press the LEFT / RIGHT button.



INFORMATION

- The LCD monitor will remain in operation until the camera is switched off in PLAY mode.
- If the memory card is inserted in the camera, all the camera functions are applied only to the memory card.
- If the memory card is not inserted in the camera, all the camera functions are applied only to the internal memory.

LCD monitor indicator

- The LCD monitor displays information about the shooting conditions.

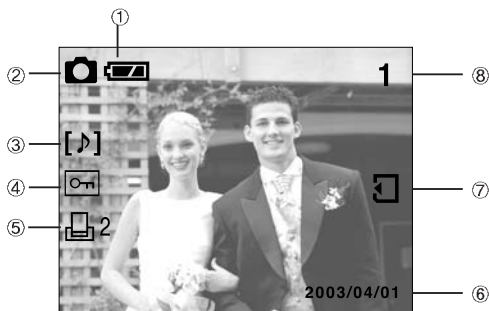

No.	Description	Icons	Page
1	Battery		p.18
2	Still image / Movie clip		
3	Voice memo		p.56
4	Protect indicator		p.60
5	DPOF indicator & the number of prints		p.63
6	Recording data	2003/04/01	
7	Memory card indicator		
8	Number of stored images	1	

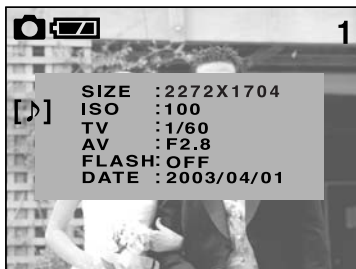

SIZE : 2272X1704 image size
 ISO : 100 ISO sensitivity
 TV : 1/60 shutter speed
 AV : F 2.8 aperture value
 FLASH : OFF Whether or not the flash is being used.
 DATE : 2003/04/01 recording date

LCD(LOI) button

- The shooting information will be displayed on the LCD monitor.

The last image stored in the memory is displayed on the LCD monitor.

Pressing the LCD button in the PLAY (▶) mode will change the display as shown below.

[Image & Icons] → [Image & Information] → [Image only]



Menu button

- When you press the MENU button, the PLAY mode menu will be displayed on the LCD monitor. Pressing it again will return the LCD to the initial display.
- The menu will not display on the LCD monitor under the following circumstances:
 - When another button is being pressed.
 - While image data is being processed. (While the green LED next to the viewfinder is blinking)
 - When there is no battery capacity.

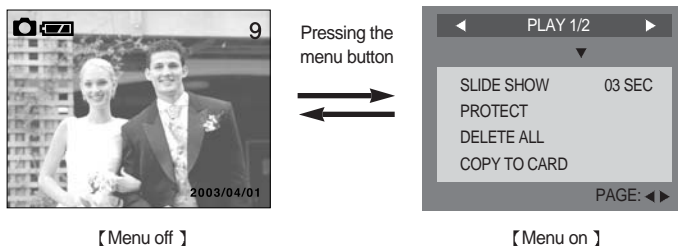

Delete() button

- This deletes an image stored on the internal memory or memory card.

1. Select an image that you want to delete by pressing the LEFT / RIGHT button.

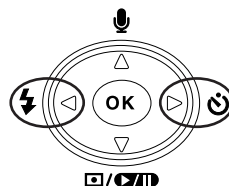

2. Press the DELETE() button and a message will display as shown alongside on the LCD monitor.



Pressing the LEFT button : the deletion is cancelled.

Pressing the OK button : Once an image has been deleted, the next image in the sequence will appear on the LCD display. (If the last stored image is deleted, the previous image will appear.)

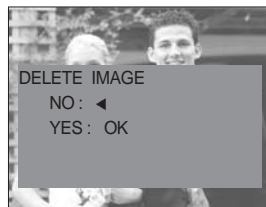

INFORMATION

- Before deleting images from the camera, you should protect or download images to your computer that you wish to keep.

Thumbnail() / Enlargement() button

- You can view up to 9 images at a time and enlarge the selected image.

Thumbnail button

1. Press the thumbnail button in the normal display mode.
2. 9-images will be displayed at the same time on the LCD monitor. The thumbnail display will highlight the image that had been showing at the time the thumbnail mode was selected.
3. Press the 5-function button to move to the desired image. The selected image is highlighted.

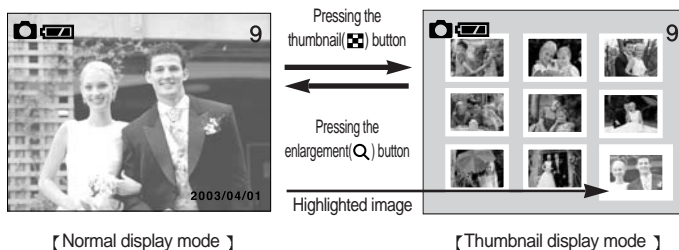

Icons are displayed to indicate the type of file selected.

() : Movie clip file

() : Protect indicator

() : DPOF indicator

() : Voice memo indicator

4. Pressing the enlargement() button will zoom back to the original full sized image.

Enlargement button

1. Select an image that you want to enlarge() and press the enlargement button.
2. The image will be enlarged ratio by 0.5 steps.
3. Different parts of the image can be viewed by pressing the 5 function button.



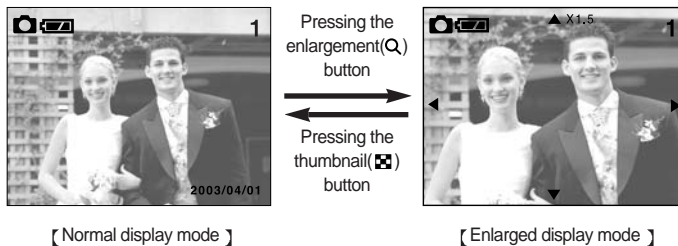

Thumbnail() / Enlargement() button



4. Pressing the thumbnail() button will zoom back to the original full sized image.



INFORMATION

- If the image is enlarged, the enlargement indicator( /  /  / ) is displayed on the LCD monitor.
- Movie clips can't be enlarged.
- If an image is enlarged, a loss of quality may occur.

PLAY

Left() / Right() / OK button

■ Left/ Right/ OK button activates the following.

- Left button : When the menu is displayed on the LCD monitor, pressing the left button makes the cursor shift to the main menu.
- Right button : When the menu is displayed on the LCD monitor, pressing the right button makes the cursor shift to the sub menu.
- OK button : When the menu is displayed on the LCD monitor, the OK button is used for confirming data that is changed by using the 5 function button.

Voice(🎤) memo / Up(▲) button

- When the menu is displayed on the LCD monitor, pressing the UP button makes the menu cursor move up or change the sub menu value.
- When the menu is not displayed on the LCD monitor, the UP button operates as the voice memo button. You can add your audio to a stored still image.

1. Press the LEFT/ RIGHT button to select an image that you wish to add sound to.
2. Press the voice memo button (🎤) and the voice memo indicator will display. The camera is now ready to record a voice memo.



3. Press the shutter button to start recording. The [RECORDING] message will be displayed on the LCD monitor (as shown) and the voice is recorded to the still image for 10 seconds. The recording can be stopped by pressing the shutter button again.



4. The ([♪]) icon will be displayed on the LCD monitor after finishing the voice memo.



INFORMATION

- The voice memo can't be recorded onto a movie clip file.
- A distance of 40cm between you and the camera (microphone) is the best distance to record sound.

Play & Pause(▶/⏸) / Down(▼) button

- When the menu is displayed on the LCD monitor, pressing the down button makes the menu cursor move down.
- When the menu is not displayed on the LCD monitor, press the down button to play and pause the movie clip, slide show or a still image that has a voice memo.
 1. Press the LEFT/ RIGHT button to select an image that has voice memo or is a movie clip.
 2. Pressing the play & pause button activates the following.
 - If an image is showing, but there is no sound (or movement) : Plays the voice memo or starts the movie clip.
 - If the image is playing : The progress is paused.
 - If the play & pause button is pressed when the image is paused, the sound or movement will resume.



3. To select another image, press the LEFT/RIGHT button after the playing back is finished or paused.

Setting up the play back function using the LCD monitor

- PLAY mode functions can be changed by using the LCD monitor.
- In the PLAY mode, pressing the MENU button displays the menu on the LCD monitor.

Main menu	Sub menu	Secondary menu
SLIDE SHOW	▲ 01 ~ 05 SEC ▼	
PROTECT	ONE IMAGE	LOCK UNLOCK
	ALL IMAGES	LOCK UNLOCK
DELETE ALL	NO YES	
COPY TO CARD	NO YES	
STANDARD	ONE IMAGE	0 ~ 30
	ALL IMAGES	0 ~ 30
INDEX PRINT	NO YES	

Slide show

- Images can be displayed continuously at pre-set intervals.
- You can view the slide show by connecting the camera to an external monitor.

1. Rotate the mode dial to the PLAY mode and press the MENU button.
2. Select the [SLIDE SHOW] menu by pressing the UP/DOWN button.
3. Press the RIGHT button and the cursor will shift to the [SLIDE SHOW] sub menu.

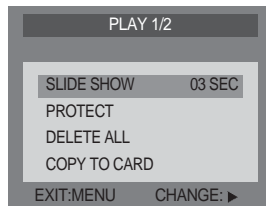

4. Select the desired sub menu by pressing the UP/DOWN button.
5. Press the OK button. The menu display will disappear and the slide show will start.
 - To pause the slide show, press the play & pause button.
 - To resume the slide show, press the play & pause button again.
 - Press the LEFT / RIGHT button and the slide show will stop.



PLAY



INFORMATION

- The default is 3 SEC and the loading time depends on the image size and quality.
- The slide show will start from an image that was displayed on the LCD monitor. The [POWER OFF] function can't be activated.
- When the last stored image is played back, the first stored image will be played back automatically.
- While the slide show is playing, only the first frame of an AVI file is displayed.
- If there is only an image in the memory card, the slide show will not start.

Protect

- This is used to protect specific shots from being accidentally erased (LOCK). It also releases images that have been previously protected (UNLOCK).

1. Rotate the mode dial to the PLAY mode and press the MENU button.
2. Select the [PROTECT] menu by pressing the UP/DOWN button.
3. Press the RIGHT button and the cursor will shift to the [PROTECT] sub menu.

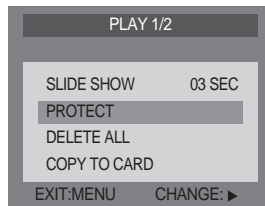

4. Select the desired sub menu by pressing the UP/DOWN button and press the OK button.
 - [ONE IMAGE] : Only an image that is displayed on the LCD monitor is protected or unprotected.
 - [ALL IMAGES] : All of the stored images are protected or unprotected.



5. Select the desired secondary menu by pressing the UP/DOWN button and press the OK button.
 - [LOCK] : Sets up the PROTECT function.
 - [UNLOCK] : Cancels the protect function.
6. If you select the [ONE IMAGE] sub menu at step 4, you can protect or unprotect another image by pressing the LEFT / RIGHT button.
7. Press the menu button and the menu will disappear. If you protect an image, the protect icon (🔒) will be displayed on the LCD monitor. (An unprotected image has no indicator)

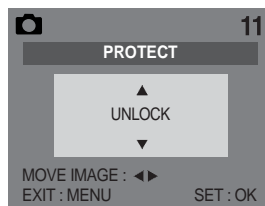

NOTICE

- An image in LOCK mode will be protected from [DELETE] or [DELETE ALL] functions, but will NOT be protected from the [FORMAT] function.

Delete all

- This enables you to clear all unprotected images from the memory.

1. Rotate the mode dial to the PLAY mode and press the MENU button.
2. Select the [DELETE ALL] menu by pressing the UP/DOWN button.
3. Press the RIGHT button and the cursor will shift to the [DELETE ALL] sub menu.
4. Select the desired sub menu by pressing the UP/DOWN button and press the OK button.
 - Selecting [NO] : The display returns to the initial menu.
 - Selecting [YES] : A [PLEASE WAIT!] message will display and all the unprotected images are deleted. If there aren't protected images, all the images are deleted and a [NO IMAGE!] message will display.
5. If a [NO IMAGE!] message is displayed on the LCD monitor after selecting [YES], press the menu button or rotate the mode dial. The message will disappear.

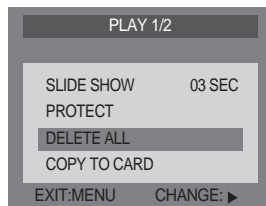

PLAY



NOTICE

- Remember that this will permanently delete unprotected images. Important shots should be stored on a computer before deletion takes place.

Copy to card

- This enables you to copy image files to the memory card.

1. Rotate the mode dial to the PLAY mode and press the MENU button.
2. Select the [COPY TO CARD] menu by pressing the UP/DOWN button.
3. Press the RIGHT button and the cursor will shift to the [COPY TO CARD] sub menu.
4. Select the desired sub menu by pressing the UP/DOWN button and press the OK button.
 - Selecting [NO] : The display is returned to the initial menu.
 - Selecting [YES] : [PLEASE WAIT!] message will display and all of the images that are stored on the internal memory are copied to the memory card. After copying the images to the memory card, the menu will be displayed on the LCD monitor.

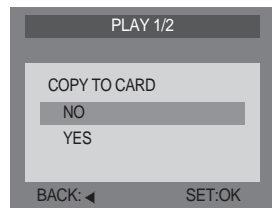
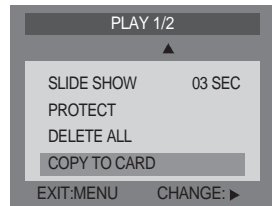

INFORMATION

- If you select this menu and press the OK button without inserting the memory card, a [NO CARD !] message will display.
- If the memory card capacity is smaller than the internal memory, a [CARD FULL !] message will be displayed by rotating the mode dial to the STILL IMAGE or MOVIE CLIP mode. The rest of the image files that are stored on the internal memory will not be copied. Before doing [COPY TO CARD], delete unnecessary files.

Copy to card



INFORMATION

- The image is stored on the 100SSCAM sub folder that is created under the DCIM folder in the internal or memory card.
- When you move the images that are stored in the internal memory by doing [COPY TO CARD] to the card, 101SSCAM folder will be created in the card to avoid duplication of the sub folder name.
- Whenever you carry out the [COPY TO CARD] function, the number of SSCAM folder increases. (Ex : 100SSCAM, 101SSCAM, 102SSCAM, 103SSCAM...)
- After completing [COPY TO CARD], the last stored image of the last copied folder is displayed on the LCD monitor. When you take an image, the image is stored in the last copied folder.

DPOF : Standard

■ DPOF

- DPOF(Digital Print Order Format) allows you to embed printing information on your memory card. Select the pictures to be printed and how many prints to make.(Print quantity : 0 ~ 30)
- The DPOF indicator will display on the LCD monitor when an image that has DPOF information plays back. Images can then be printed on DPOF printers, or at an increasing number of photo laboratories.

■ This function is not available for Movie clips and WAV files.

■ The DPOF file is only stored on the memory card.

To make a DPOF file for the images that are stored on the internal memory, apply the [COPY TO CARD] function first.

DPOF : Standard



1. Rotate the mode dial to the PLAY mode and press the MENU button.
2. Select the [PLAY[DPOF] 2/2] menu by pressing the RIGHT button.
3. Select the [STANDARD] menu by pressing the UP/DOWN button.

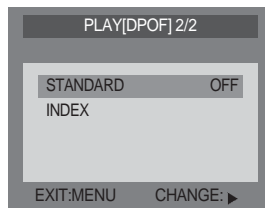

4. Press the RIGHT button and the cursor will shift to the [STANDARD] sub menu.
5. Select the desired sub menu by pressing the UP/DOWN button and press the OK button.

- [ONE IMAGE] : Specifies the number of copies for a selected image
- [ALL IMAGES]: Specifies the number of copies for all images.

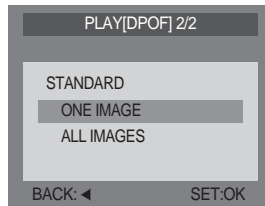

6. Select the print quantity by pressing the UP/DOWN button and press the OK button.

- Print quantity : 0 ~ 30

7. If you select the [ONE PICTURE] sub menu at step 5, you can embed a print quantity on another image by pressing the LEFT / RIGHT button.

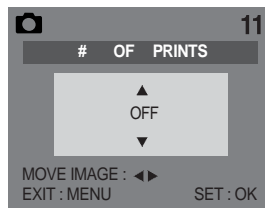

8. If an image carries DPOF instructions, the DPOF indicator (🖨️) will show. The number of prints are displayed alongside the DPOF indicator.





- Images(except for movie clips) are printed as index type. There is no indicator for the index print. The first printed image is the first stored image.

1. Rotate the mode dial to the PLAY mode and press the MENU button.
2. Select the [PLAY[DPOF] 2/2] menu by pressing the RIGHT button.
3. Select the [INDEX] menu by pressing the UP/DOWN button.
4. Press the RIGHT button and the cursor will shift to the [INDEX] sub menu.
5. Select the desired sub menu by pressing the UP/DOWN button and press the OK button.
6. Press the menu button and the menu display will disappear.

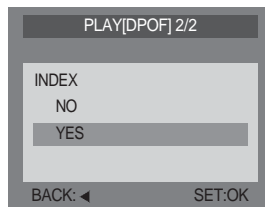
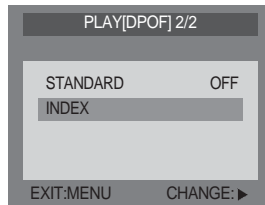

Setup menu

- Rotate the mode dial to the SETUP (SET) mode, allowing you to set up the basic camera settings.
- [LANGUAGE], [DATE SETUP], [VIDEO OUT] sub menus will not be changed by doing the reset function.

Main menu	Sub menu		Secondary menu	Default
FORMAT	NO YES			NO
FILE NAME	RESET SERIES			RESET
POWER OFF	OFF, 01 ~ 05 MIN ▲ ▼			03 MIN
LANGUAGE	ENGLISH	SPANISH		
	KOREAN	ITALIAN		
	FRENCH	S.CHINESE		
	GERMAN	T.CHINESE		
DATE SETUP	2003/01/01 ~ 2049/12/31 ▲ ▼			
IMPRINT	OFF DATE DATE & TIME			OFF
DATE TYPE	Y/M/D M/D/Y D/M/Y			Y/M/D
USER SET	NO YES RESET			NO
SOUND	OFF LOW NORMAL HIGH			NORMAL
LCD	-3 ~ NORMAL ~ +3			NORMAL
VIDEO OUT	NTSC PAL			
QUICKVIEW	OFF, 01 ~ 03 SEC ▲ ▼			01 SEC

Format

- This is used for formatting the memory card.

1. Rotate the mode dial to SETUP mode and the [SETUP 1/3] menu will display.
2. Select the [FORMAT] menu by pressing the UP/DOWN button.
3. Press the RIGHT button and the cursor will shift to the [FORMAT] sub menu.

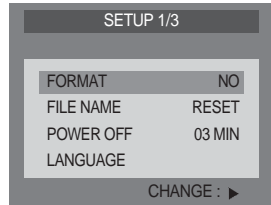

4. Select the desired sub menu by pressing the UP/DOWN button and press the OK button.
 - Selecting [NO] : SETUP menu will be displayed.
 - Selecting [YES] : The memory is formatted.([FORMAT OK!] message will be displayed and the SETUP menu will be displayed.)

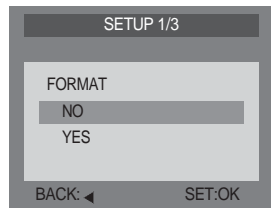

NOTICE

- Before using a memory card that has a file this camera can't recognize or one that has been taken from another camera, it must be initialized.
- All the files in the memory are deleted by the [FORMAT] function. Before formatting the memory, it is advisable to copy important data onto other media as back-up e.g. floppy disks, hard disks, CD etc.
- Do not use the memory card formatted by another digital camera or memory card reader.
- If the memory card is not inserted, the internal memory will be formatted.

Format



NOTICE

- When you format the memory card in your PC that runs on Windows 2000 or XP, please select the FAT file system.

Formatting on a PC

(Connecting the camera to the PC with the USB cable. Refer to p.82)

1. Select [Removable Disk] in the [Windows Explorer].



2. Press the right mouse button and select [Format].

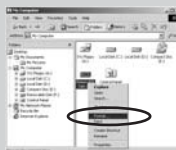

3. Select [FAT] file format type and click the [Start] button.

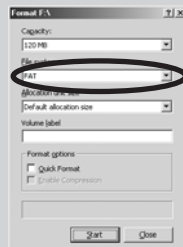

File name

■ This enables you to name files

1. Rotate the mode dial to SETUP mode and the [SETUP 1/3] menu will display.
2. Select [FILE NAME] menu by pressing the UP/DOWN button.
3. Press the RIGHT button and the cursor will shift to the [FILE NAME] sub menu.
4. Select the desired sub menu by pressing the UP/DOWN button and press the OK button.

- [RESET] : Using reset, the next file name will be set from 0001 even after formatting, deleting all or inserting a new memory card.
- [SERIES] : Under this system, the file name will directly follow the last stored file name, regardless of any actions such as file deletion or formatting.

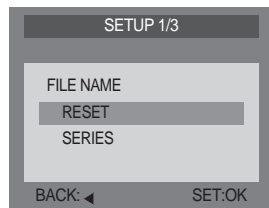
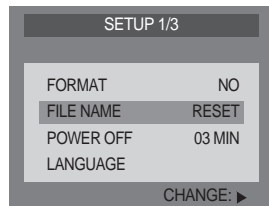

INFORMATION

- The first stored folder name is 100SSCAM, and the first file name is S4200001.
- Whenever you store an image, the file number is increased by 1.
- The file number is named from S4200001 to S4209999 automatically, 9999 files will be stored in a folder.
- Using [SERIES], the sequence starts at 100SSCAM and increases in increments of 1.(e.g : 101SSCAM, 102SSCAM...
- The files used with the memory card conform to the DCF(Design rule for Camera File system) format.
- If you change the name of files that are stored on the memory, you can not play back the files on the LCD monitor of this camera.

Power off

- This function switches the camera off after a set amount of time in order to prevent unnecessary battery drainage.

1. Rotate the mode dial to SETUP mode and the [SETUP 1/3] menu will display.
2. Select the [POWER OFF] menu by pressing the UP/DOWN button.
3. Press the RIGHT button and the cursor will shift to the [POWER OFF] sub menu.
4. Select the desired sub menu by pressing the UP/DOWN button and press the OK button.
 - Auto power off time : Off, 1 ~ 5 MIN

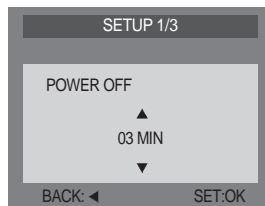
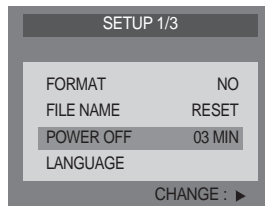

- Time for power off

Power status	Period of time (Battery)	Period of time (AC adapter)
Idle mode (LCD monitor off)	About 60 sec	N/A
Power off	User setting	N/A



INFORMATION

- Even if the batteries or AC adapter are removed and inserted again, the power off setting will be preserved.
- Note that the automatic power off does not operate if the camera is in slide show, PC mode, recording a movie clip or playing back a movie clip.

Language

- There is a choice of languages that can be displayed on the LCD monitor.

1. Rotate the mode dial to SETUP mode and the [SETUP 1/3] menu will display.
2. Select the [LANGUAGE] menu by pressing the UP/DOWN button.
3. Press the RIGHT button and the cursor will shift to the [LANGUAGE] sub menu.
4. Select the desired sub menu by pressing the UP/DOWN button and press the OK button.

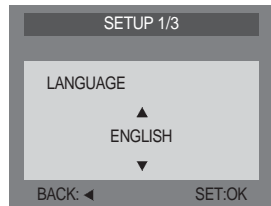
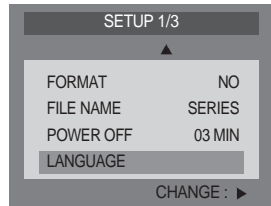

INFORMATION

- You can select 8 languages. Those are listed below. :
English, Korean, French, German, Spanish, Italian, S. Chinese, T. Chinese.
- Even if the camera is restarted, the language setting will be maintained.

Date setup

- You can change the imprinted date.

1. Rotate the mode dial to SETUP mode and the [SETUP 1/3] menu will display.
2. Select the [SETUP 2/3] menu by pressing the RIGHT button.
3. Select the [DATE SETUP] menu by pressing the UP/DOWN button.
4. Press the RIGHT button and the cursor will shift to the [DATE SETUP] sub menu.
5. Select the desired sub menu by pressing the UP/ DOWN/ LEFT/ RIGHT button.
 - LEFT / RIGHT button : selects YEAR/ MONTH/ DAY / HOUR / MINUTE
 - UP/ DOWN button : changes the value of each item.
6. Press the OK button to confirm the setting.

The selection range for date/time setup covers from 2003~2049.

(It is automatically programmed to allow for a leap year/ month)

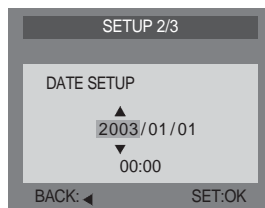
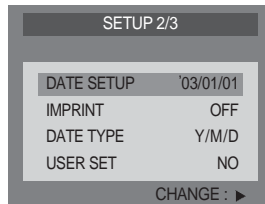

INFORMATION

- If the batteries or AC adapter are removed, it is necessary to reset the time /date.
- Recording date displays on the LCD monitor in the PLAY mode.(DATE IMPRINT : ON)

Imprint

- There is an option to include DATE/TIME on still images.

1. Rotate the mode dial to SETUP mode and the [SETUP 1/3] menu will display.
2. Select the [SETUP 2/3] menu by pressing the RIGHT button.
3. Select the [IMPRINT] menu by pressing the UP/DOWN button.
4. Press the RIGHT button and the cursor will shift to the [IMPRINT] sub menu
5. Select the desired sub menu by pressing the UP/DOWN button.
 - OFF : DATE & TIME will not be imprinted on the image file.
 - DATE : Only DATE will be imprinted on the image file.
 - DATE&TIME : DATE & TIME will be imprinted on the image file.
6. Press the OK button to confirm the setting.

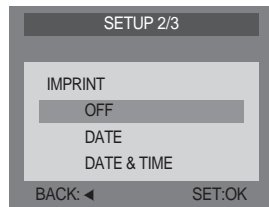
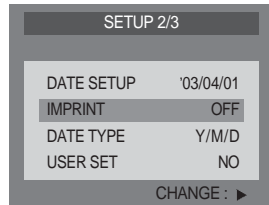

INFORMATION

- Date & Time are displayed at the bottom right side of the LCD monitor.
- Date will be imprinted as DATE TYPE setting.
- TIME is imprinted in the following way : [Hour / Minute/ Second] and hours are shown using the 24 hour clock.
- The imprint function is unaffected by the camera being switched on and off.
- Date & Time is imprinted as you set it in the DATE SETUP menu.
- The imprint function is applied only to a still image.

Date type

- You can select date type that is imprinted on the image.

1. Rotate the mode dial to SETUP mode and the [SETUP 1/3] menu will display.
2. Select [SETUP 2/3] menu by pressing the RIGHT button.
3. Select the [DATE TYPE] menu by pressing the UP/DOWN button.
4. Press the RIGHT button and the cursor will shift to the [DATE TYPE] sub menu
5. Select the desired sub menu by pressing the UP/DOWN button
 - Y/M/D
 - M/D/Y
 - D/M/Y
6. Press the OK button to confirm the setting.

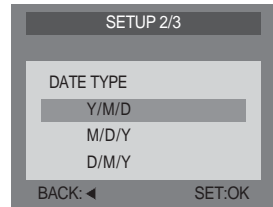
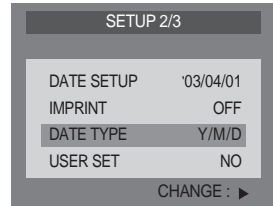

User set

- This menu allows you to save the changed camera settings. When the camera is turned on, the saved camera menu will be adopted.(Effect, Exposure, ISO, W.Balance only)

1. Rotate the mode dial to SETUP mode and the [SETUP 1/3] menu will display.
2. Select the [SETUP 2/3] menu by pressing the RIGHT button.
3. Select the [USER SET] menu by pressing the UP/DOWN button.
4. Press the RIGHT button and the cursor will shift to the [USER SET] sub menu.
5. Select the desired sub menu by pressing the UP/DOWN button and press the OK button.

- Selecting [NO] : SETUP menu will display without resetting
Selecting [YES] :All the changed camera settings are saved.
Selecting [RESET] :All the camera settings are changed to the camera default settings except for [LANGUAGE], [DATE SETUP] and [VIDEO OUT] sub menu.

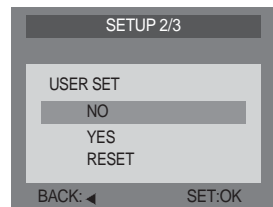
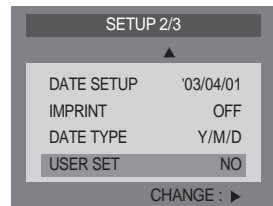

List of camera function

⊙ : Default

× : There is no associated menu.

● : The setting is maintained even if the camera power is off.

◇ : The setting is returned to default, once the camera power has been switched off.

△ : The setting is returned to default after the function has been completed.

■ : If the [USER SET] menu was set to [YES], the setting is maintained even if the camera power is off.

Main menu	Sub menu	Movie clip	STILL IMAGE	PLAY	SETUP
SIZE	2272x1704	288 X 208 Fixed	⊙	X	X
	2272x1504		●	X	X
	1120x840		●	X	X
	544x408		●	X	X
QUALITY	SUPER FINE	X	●	X	X
	FINE	X	⊙	X	X
	NORMAL	X	●	X	X
EFFECT	NORMAL	⊙	⊙	X	X
	B&W	◇ / ■	◇ / ■	X	X
	SEPIA	◇ / ■	◇ / ■	X	X
SHOOTING	SINGLE	X	⊙	X	X
	CONTINUOUS	X	△	X	X
	AEB	X	△	X	X
EXPOSURE	-0.5 ~-2.0	X	◇ / ■	X	X
	0.0	X	⊙	X	X
	+0.5 ~+2.0	X	◇ / ■	X	X
ISO	AUTO	X	⊙	X	X
	100	X	◇ / ■	X	X
	200	X	◇ / ■	X	X
	400	X	◇ / ■	X	X
W.BALANCE	AUTO	⊙	⊙	X	X
	DAYLIGHT	◇ / ■	◇ / ■	X	X
	CLOUDY	◇ / ■	◇ / ■	X	X
	SUNSET	◇ / ■	◇ / ■	X	X
	FLUORESCENT	◇ / ■	◇ / ■	X	X
	TUNGSTEN	◇ / ■	◇ / ■	X	X

List of camera function

SCENE	NORMAL	X	⊙	X	X	
	NIGHT	X	◇	X	X	
FLASH	AUTO	X	⊙	X	X	
	AUTO&RED EYE	X	◇	X	X	
	SLOW SYNCH	X	◇	X	X	
	FILL IN	X	◇	X	X	
	OFF	X	◇	X	X	
	SELF-TIMER	ON	△	△	X	X
	OFF	⊙	⊙	X	X	
METERING	MULTI	X	⊙	X	X	
	SPOT	X	◇	X	X	
VOICE MEMO(STILL IMAGE)	ON	⊙	△	△	X	
SOUND RECORDING(MOVIE CLIP)	OFF	X	⊙	⊙	X	
PROTECT	ONE IMAGE	X	X	⊙	X	
	ALL IMAGES	X	X	◇	X	
DELETE ALL	NO	X	X	⊙	X	
	YES	X	X	△	X	
COPY TO CARD	NO	X	X	⊙	X	
	YES	X	X	△	X	
DPOF	STANDARD	ONE IMAGE	X	X	⊙	X
		ALL IMAGES	X	X	◇	X
	INDEX	NO	X	X	⊙	X
		YES	X	X	●	X
FORMAT	NO	X	X	X	⊙	
	YES	X	X	X	△	
FILE NAME	RESET	X	X	X	⊙	
	SERIES	X	X	X	●	
POWER OFF (03 MIN)	YES	X	X	X	⊙	
	NO	X	X	X	●	

List of camera function

LANGUAGE	ENGLISH	X	X	X	●
	S.CHINESE	X	X	X	●
	T.CHINESE	X	X	X	●
	KOREAN	X	X	X	●
	ITALIAN	X	X	X	●
	GERMAN	X	X	X	●
	FRENCH	X	X	X	●
	SPANISH	X	X	X	●
DATE SETUP		X	X	X	●
IMPRINT	OFF	X	X	X	⊙
	DATE	X	X	X	●
	DATE & TIME	X	X	X	●
DATE TYPE	Y/M/D	X	X	X	⊙
	D/M/Y	X	X	X	●
	M/D/Y	X	X	X	●
USER SET	NO	X	X	X	⊙
	YES	X	X	X	●
	RESET	X	X	X	△
SOUND	OFF	X	X	X	●
	LOW	X	X	X	●
	NORMAL	X	X	X	⊙
	HIGH	X	X	X	●
LCD (NORMAL)	YES	X	X	X	⊙
	NO	X	X	X	●
VIDEO OUT	NTSC	X	X	X	●
	PAL	X	X	X	●
QUICK VIEW (01 SEC)	YES	X	X	X	⊙
	NO	X	X	X	●

※ Menus are subject to change without prior notice.

Sound

- A beep will sound when you press the camera button and an error occurs.

You can check the camera condition with this function.

1. Rotate the mode dial to SETUP mode and the [SETUP 1/3] menu will display.
2. Select the [SETUP 3/3] menu by pressing the RIGHT button twice.
3. Select the [SOUND] menu by pressing the UP/DOWN button.
4. Press the RIGHT button and the cursor will shift to the [SOUND] sub menu.
5. Select the desired sub menu by pressing the UP/DOWN button.
 - Selecting [OFF] : The sound function is not activated.
 - Selecting [LOW] : The low sound will be activated.
 - Selecting [NORMAL] : The normal sound will be activated.
 - Selecting [HIGH] : The loud sound will be activated.
6. Press the OK button to confirm the setting.

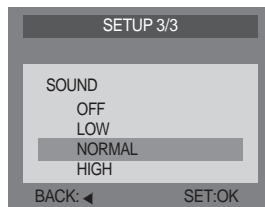
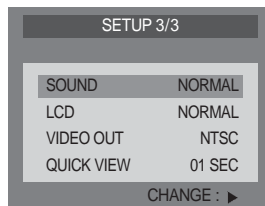

LCD brightness

- You may adjust the LCD brightness.

1. Rotate the mode dial to SETUP mode and the [SETUP 1/3] menu will display.
2. Select the [SETUP 3/3] menu by pressing the RIGHT button twice.
3. Select the [LCD] menu by pressing the UP/DOWN button.
4. Press the RIGHT button and the cursor will shift to the [LCD] sub menu.
5. Select the desired sub menu by pressing the UP/DOWN button.
 - LCD brightness range : -3 ~ NORMAL ~ +3
6. Press the OK button to confirm the setting.

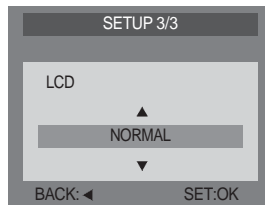
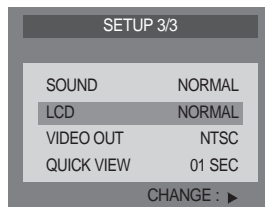

Video out

- The Movie output signal from the camera can be NTSC or PAL. Your choice of output will be governed by the type of device (monitor or TV, etc.) to which the camera is connected.

1. Rotate the mode dial to SETUP mode and the [SETUP 1/3] menu will display.
2. Select the [SETUP 3/3] menu by pressing the RIGHT button twice
3. Select the [VIDEO OUT] menu by pressing the UP/DOWN button.
4. Press the RIGHT button and the cursor will shift to the [VIDEO OUT] sub menu.
5. Select the desired sub menu by pressing the UP/DOWN button.
6. Press the OK button to confirm the setting.

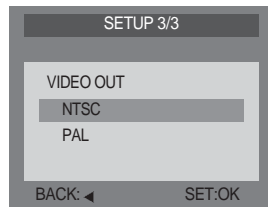
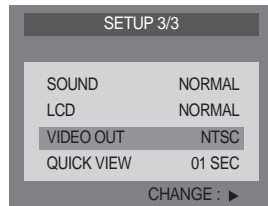

INFORMATION

- Select the correct movie standard for the outer monitor. PAL mode can support only BDGHI.
- NTSC : U.S.A, Canada, Japan, South Korea, Taiwan, Mexico.
- PAL : Australia, Austria, Belgium, China, Denmark, Finland, Germany, U.K., Holland, Italy, Kuwait, Malaysia, New Zealand, Singapore, Spain, Sweden, Switzerland, Thailand, Norway.

Connecting to an external monitor

► Connecting to an external monitor

In RECORDING/ PLAY mode, you can view the stored still images or movie clips by connecting the camera to an external monitor via the video cable. When the camera is connected to an external monitor, the LCD monitor will be turned off automatically.

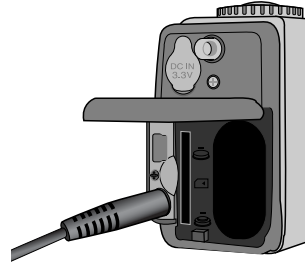

INFORMATION

- When using a TV as an external monitor, you will need to select the external or AV channel of the TV.
- There will be a digital noise on the external monitor, but it is not a malfunction.
- If the image is not in the centre of the screen, use the TV controls to centre it.
- When the camera is connected to an external monitor, the menu will be visible on the external monitor and the menu functions are the same as those indicated on the LCD monitor.

Quick view

- You can briefly review the last image captured during the pre-set time.

1. Rotate the mode dial to SETUP mode and the [SETUP 1/3] menu will display.
2. Select the [SETUP 3/3] menu by pressing the RIGHT button twice.
3. Select the [QUICK VIEW] menu by pressing the UP/DOWN button.
4. Press the RIGHT button and the cursor will shift to the [QUICK VIEW] sub menu.
5. Select the desired sub menu by pressing the UP/DOWN button.
 - Quick view sub menu : OFF, 01SEC ~ 03SEC
6. Press the OK button to confirm the setting.

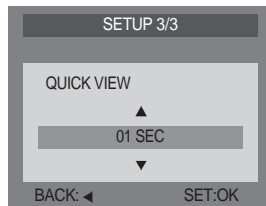
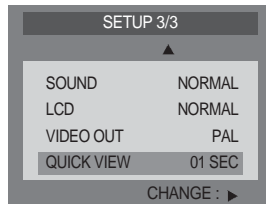

INFORMATION

- The quick view function doesn't apply to the movie clip.

Starting PC mode

- If you insert the USB cable into the USB connection terminal, the camera working mode will change to the PC mode automatically.
- In this mode, you can download stored images to your PC through the USB cable.
- The LCD monitor is always turned off in PC mode.
- The autofocus indicator lamp(green) blinks when the files are transferring via the USB connection.

■ Connecting the camera to a PC

1. Turn the PC power on.
2. Turn the camera power on.
3. Connect the PC and the camera via the USB cable.
 - Insert the small plug of the USB cable into the camera USB connection terminal.
 - Insert the large connector of the USB cable into the USB port of the PC
 - The plugs must be firmly inserted.

■ Disconnecting the camera and PC

Refer to the following page

- WIN 98SE : p.103
- WIN 2000/ME/XP : p.103

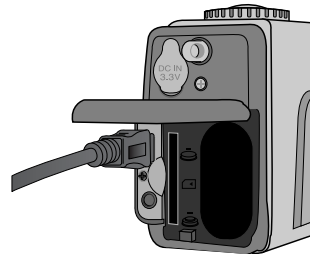

INFORMATION

- The camera driver must be installed before using PC mode.
- To save battery power, it is recommended that you use an AC adaptor(Optional) when connecting the camera to a computer.

Starting PC mode

■ Downloading stored images

Once you have downloaded images to your PC, they can be edited and printed.

1. Connect the camera to your PC with the USB cable.
2. On your computer's desktop display, select [My computer] and double click [Removable Disk → DCIM → 100SSCAM].
The image files will then be displayed.



3. Select an image and press the right mouse button.

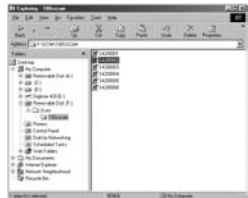

4. A pop-up menu will open.
Click the [Cut] or [Copy] menu
[Cut] : cuts a selected file.
[Copy] : copies files.

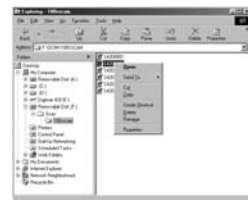

5. Click a folder where you want to paste the file.

Starting PC mode

6. Press the right mouse button and a pop-up menu will open. Click [Paste].



7. An image file is transferred from camera to your PC.



- By using [Digimax Viewer], you can see the stored images in the memory directly on the PC monitor and you can copy or move the image files.
- When the memory card is inserted, you can view the images that are stored in the memory card.
- When the memory card is not inserted, you can view the images that are stored in the internal memory.

Important notes

- Your new Samsung camera is a precision instrument. Whilst it is designed to withstand general wear and tear, there are some important points that will help you get maximum service and reliability from your camera. The following should be avoided :
 - Severe changes in temperature and humidity.
 - Dust and dirt.
 - Direct sunlight or the inside of a vehicle in hot weather.
 - Environments where there is high magnetism or excessive vibration.
 - Areas with high explosives or which are highly flammable materials.
 - Pesticides, etc.
- Sand can be particularly troublesome to cameras.
 - Sand or other small particulates can cause severe malfunctions.Ensure that there is no contact with sand or similar particles.
- Extremes in temperature may cause problems.
 - If the camera is transferred from a cold to a warm and humid environment, condensation can form on the delicate electronic circuitry. If this occurs, turn the camera off and wait for at least 1 hour until all moisture is dispersed. Moisture build up can also occur in the MEMORY CARD. If this happens, turn off the camera and remove the MEMORY CARD. Wait until the moisture has dispersed.
- If the digital camera is not used for a long period, an electric discharge can occur. It is a good idea to remove the batteries and the MEMORY CARD, the camera is not used for some time.
- If the camera is exposed to electronic interference, it will turn itself off to protect the MEMORY CARD.
- Maintenance
 - Use a soft brush (available from photo stores) to GENTLY clean the lens and LCD assemblies. If this does not work, lens-cleaning paper with lens cleaning fluid can be used.
 - Clean the camera body with a soft cloth. Do not allow this camera to come into contact with solvent materials such as benzol, insecticide, thinners etc.
This may damage the body shell of the camera and also affect its performance.
 - Rough handling can damage the LCD monitor. Take care to avoid damage and keep the camera in its protective carry case at all times when not in use.
- DO NOT attempt to disassemble or modify the camera. It contains delicate parts and there are high voltage circuits that can cause electric shocks.
- Under certain conditions, static electricity can cause the flash unit to fire.
This is not harmful to the camera and is not a malfunction.
- When images are uploaded or downloaded, the data transfer may be affected by static electricity. In this case, disconnect and re-connect the USB cable before trying the transfer again.

Warning indicator

There are several warnings that may appear in the LCD display

Warning indicator	Causes	Remedy
CARD ERROR !	<ul style="list-style-type: none">- Card error.	<ul style="list-style-type: none">- Turn off the camera power and turn it on again.- Insert the memory card again.- Format the memory card.(p.67)
MEMORY ERROR !	<ul style="list-style-type: none">- Internal memory error.	<ul style="list-style-type: none">- Turn off the camera power and turn it on again.- Format the internal memory.(p.67)
CARD FULL !	<ul style="list-style-type: none">- There is insufficient memory card capacity to take an image.	<ul style="list-style-type: none">- Insert a new memory card.- Delete unnecessary image files to free up some memory.
MEMORY FULL!	<ul style="list-style-type: none">- There is insufficient internal memory capacity to take an image.	<ul style="list-style-type: none">- Delete unnecessary image files to free up some memory.
NO IMAGE !	<ul style="list-style-type: none">- There are no images stored on the memory card.	<ul style="list-style-type: none">- Take images.- Insert a memory card that is holding some images.
NO CARD !	<ul style="list-style-type: none">- A memory card is not inserted.- The camera can't recognize the memory card.	<ul style="list-style-type: none">- Insert a memory card.- Insert the memory card again.- Turn off the camera power and turn it on again.
FILE ERROR !	<ul style="list-style-type: none">- Memory card error.	<ul style="list-style-type: none">- Insert a new memory card.- Contact camera service center.
LOW BATTERY !	<ul style="list-style-type: none">- There is low battery capacity.	<ul style="list-style-type: none">- Insert fresh batteries.
CARD LOCKED !	<ul style="list-style-type: none">- The SD memory card is locked.	<ul style="list-style-type: none">- Slide the write protect switch to the top of the SD memory card.

Before contacting a service center

Please check the following

Symptom	Causes	Remedy
The camera doesn't switch on	<ul style="list-style-type: none"> - There is low battery capacity. - An AC Power Adapter is not connected. 	<ul style="list-style-type: none"> - Insert fresh batteries. - Connect an AC Power Adapter.
The camera powers down whilst in use	<ul style="list-style-type: none"> - The batteries are exhausted. - The Camera is turned off automatically due to the Auto power off function. - The Adapter plug is not connected securely. 	<ul style="list-style-type: none"> - Insert fresh batteries. - Slide the power switch to reactivate camera. - Remove and re-insert the plug.
Batteries drain quickly	<ul style="list-style-type: none"> - The Camera is being used in low temperatures. - Mixing old and new batteries or battery types. 	<ul style="list-style-type: none"> - Keep the camera in warm conditions (i.e. inside a coat or jacket) and only remove it in order to take images. - Insert fresh batteries.(all of which should be of the same type)
Camera does not take images when pressing the Shutter button	<ul style="list-style-type: none"> - There is insufficient memory capacity. - The memory card has not been formatted. - The memory card is exhausted. - The camera power is off. - The batteries are exhausted. - The SD card is locked. 	<ul style="list-style-type: none"> - Delete unnecessary image files. - Format the memory card.(p.67) - Insert a new memory card. - Turn the camera power on. - Insert fresh batteries. - Slide the write protect switch to the top of the SD memory card.

Before contacting a service center

Symptom	Causes	Remedy
The images are unclear	<ul style="list-style-type: none">- The focus mode is not correct.- The autofocus was not activated.- Pictures are being taken beyond the flash range.- The lens is smudged or dirty.	<ul style="list-style-type: none">- Select appropriate focus mode.- Use Fixed focus when you can't use auto focus mode.- Take a picture within the flash range.- Clean the lens.
The flash does not fire	<ul style="list-style-type: none">- FLASH OFF mode has been selected.	<ul style="list-style-type: none">- Disengage FLASH OFF mode.
Incorrect date and time is displayed	<ul style="list-style-type: none">- The date and time have been set incorrectly or the camera has adopted the default settings.	<ul style="list-style-type: none">- Reset the date and time correctly.
The camera buttons do not operate	<ul style="list-style-type: none">- Camera malfunction.	<ul style="list-style-type: none">- Remove /re-insert batteries and switch camera on.
Memory card error	<ul style="list-style-type: none">- Incorrect memory card format.	<ul style="list-style-type: none">- Re-format the memory card.(p.67)
The images don't play back	<ul style="list-style-type: none">- Incorrect file name. (Violation of DCF format)	<ul style="list-style-type: none">- Do not change the image file name.

Before contacting a service center

Symptom	Causes	Remedy
Color of image different to original scene	- White balance setting is incorrect.	- Select appropriate White balance.
Images are too bright	- Exposure is excessive.	- Reset exposure compensation.
No image on external monitor	- The external monitor has not been connected properly with the camera. - There are incorrect files in the memory card. - There are no images in the memory.	- Check the connection cables. - Insert a memory card that have correct files. - Take pictures.
When using the PC's explorer, 'Removable Disk' file does not show	- Cable connection is incorrect. - The camera is off. - There are no batteries, the batteries are exhausted or the AC adapter is not connected. - The operating system is not Windows 98, 98SE, 2000, ME, XP/ Mac OS 9.0~10.2. Alternatively the PC does not support USB. - USB driver is not installed.	- Check the connection. - Turn the camera on. - Insert new batteries or check the adapter connection. - Install Windows 98, 98SE, 2000, ME, XP/ Mac OS 9.0~10.2 to PC that supports USB. - Install "USB Storage Driver" .

Specifications

Image Sensor	Type	1/1.8" CCD
	Effective Pixels	Approx. 4.0 Mega pixels
	Total Pixels	Approx. 4.1 Mega pixels
Lens	Focal Length	SHD Lens f = 7.7 ~ 23.1mm (35mm film equivalent : 38~114mm)
	F No.	F2.7 ~ F4.9
	Digital Zoom	Still Image mode : 1.0X ~ 4.0X Play mode : 1.0X ~ 5.0X (depends on image size)
Viewfinder	Optical Viewfinder	Real image optical viewfinder
	LCD Monitor	1.5" color TFT LCD (117,600 dots)
Focusing	Type	TTL auto focus
	Range	Normal : 80cm ~ infinity, Macro : Wide 6 ~ 80cm, Tele 40 ~ 80cm Fixed focus : 1m, 2m, Infinity
Shutter	Type	Mechanical and Electronic shutter
	Speed	Normal : 1 ~ 1/2,000 sec. Night : 5 ~ 1/2,000 sec.
Exposure	Control	Program AE Metering : Multi, Spot
	Compensation	±2.0EV (0.5EV steps)
	ISO Equivalent	Auto, 100, 200, 400
Flash	Modes	Auto, Auto & Red-eye reduction, Slow sync, Fill-in flash, Flash off
	Range	Wide : 0.3 ~ 3.0m, Tele : 0.4 ~ 2.0m
	Recharging Time	Approx. 10 sec.
Effect		Normal, B&W, Sepia
White Balance		Auto, Daylight, Cloudy, Sunset, Fluorescent, Tungsten
Shooting	Still Image	Scene Modes : Normal, Night Scene Shooting : Single, Continuous, AEB
	Movie Clip	Size : 15fps For 288X208 with Voice (Recording time : memory capacity dependent)
Self-timer		10 sec.
Storage	Media	Internal memory : 16MB flash memory External memory(optional) : SD Card (Up to 256MB guaranteed)
	File Format	Still Image : JPEG (DCF), DPOF Movie Clip : AVI (MJPEG)

Specifications

	Image Size	Large : 2272x1704 pixels, Photo : 2272x1504 pixels Medium : 1120x840 pixels, Small : 544x408 pixels
	Capacity (16MB) (Internal memory)	Large : Super fine 6, Fine 13, Normal 20 Photo : Super fine 7, Fine 15, Normal 23 Medium : Super fine 28, Fine 56, Normal 84 Small : Super fine 109, Fine 199, Normal 299 * These figures are measured by Internal memory based. These figures are measured under Samsung's standard conditions and may vary depending on shooting conditions and camera settings.
Image Play		Single image, Thumbnails, Slide show, Movie Clip
Interface		Digital output connector : USB DC power input connector : 3.3V
Power Source		Included : 2 x Alkaline Battery Optional : 2x Ni-MH batteries / I-Pack CR-V3 Lithium-ion Battery/ AC adapter * Included battery may vary depending on sales region.
Dimensions (WxHxD)		109.7 x 59x 39.6mm
Operating Temperature		0 ~ 40 °C
Operating Humidity		5 ~ 85%
Weight		Approx. 165g (without batteries and card)
Software	Camera Driver	Storage Driver (Windows98/98SE/2000/ME/XP, XP, Mac OS 9.0 ~ 10.2)
	Application	MGI PhotoSuite, Digimax Viewer

System Requirements	Digimax 420
For Windows	PC with processor better than MMX Pentium 233MHz (XP : Pentium II 300MHz) Windows 98/98SE/2000/ME/XP Minimum 32MB RAM (XP : 128MB) 140MB of available hard-disk space USB port CD-ROM drive 800x600 pixels, 16-bit color display compatible monitor (24-bit color display recommended)
For Macintosh	Power Mac G3 or later Mac OS 9.0 ~ 10.2 Minimum 64MB RAM 110MB of available hard-disk space USB port CD-ROM drive QuickTime 4.0 or later for Movie Clip

※ Specifications are subject to change without prior notice.

Software Notes

Please ensure that you read the instruction manual carefully before use.

- The attached software is a camera driver and image editing software tool for Windows.
 - Under no circumstances should all or part of either the software or the user manual be reproduced.
 - Copyright for both software is licensed only for use with a camera.
 - In the unlikely event of a manufacturing fault, we will repair or exchange your camera. We cannot, however, be held responsible in any way for damage caused by inappropriate use.
 - Using a Hand-made PC or a PC that has not been guaranteed by the manufacturer is not covered by the Samsung warranty.
 - Before reading this manual, you should have a basic knowledge of computers and O/S (Operating Systems).
- ※ Windows is a registered trademark of Microsoft.
※ Macintosh, Mac is the registered trademark of Apple computer, USA.

About the software

After inserting the CD-ROM provided with this camera into the CD-ROM drive, the following window should automatically run. Before connecting the camera to the PC, you should first install the camera driver.

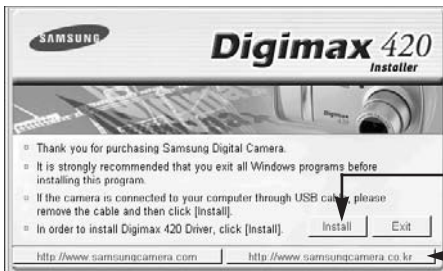

Setting up the application program

Access to the Samsung camera web-site.

Click the [Install] menu on the Autorun frame and all of application software is installed.

- Camera driver : This enables images to transfer between the camera and PC. This camera uses the USB Storage Driver as the camera driver. You can use the camera as a USB card reader. After installing the driver and connecting this camera to the PC, you can find [Removable Disk] in [Windows Explorer] or [My computer]. A USB Storage Driver is provided only for Windows. A USB Driver for MAC is not included with the Application CD. But you can use the camera with Mac OS 9.0~10.2.
- Setting up the camera driver for WINDOWS (p.94)

About the software

■ Digimax Viewer 2.0 :

This is a program for viewing stored images. You can see the stored images in the memory directly on a PC monitor. You can also copy, move or delete the images and enlarge /downscale the image sizes with Digimax Viewer.

For windows only.

- Setting up Digimax Viewer (p.94)
- Using Digimax Viewer (p.106)

■ MGI PhotoSuite III SE : Image editing program

Image editing program for downloaded images. For Windows only.

- Setting up MGI PhotoSuite III SE (p.96)
- Using MGI PhotoSuite III SE (p.107)

■ Internet link : You can visit the Samsung web-site through the internet.

- <http://www.samsungcamera.com> : English
- <http://www.samsungcamera.co.kr> : Korean



INFORMATION

- Check the system requirements (p.91) before setting up the driver.
- You should allow 5~10 seconds for running the automatic setup program according to the capability of the computer. If the frame does not show, run the [Windows Explorer] and select [Samsung.exe] in the CD-ROM Drive root directory.

Setting up the application software

To use this camera with a PC, install the application software first. After this has been done, the stored images in the camera can be moved to the PC and can be edited by an image editing program.



NOTICE

- Disable other programs before installing the application software.
- Before installing the application software, disconnect the USB connection.

You can visit the Samsung web-site through the internet.

<http://www.samsungcamera.com> : English

<http://www.samsungcamera.co.kr> : Korean

1. Click the [Install] menu in the Autorun frame.
The camera driver is installed automatically.

[Click !]

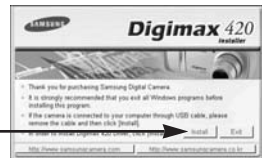

2. Installation is complete.

A window for which you can select application software will be displayed. Select the application program and click the [Install] button. Refer to page.92 for more information about the application program.

[Click !]

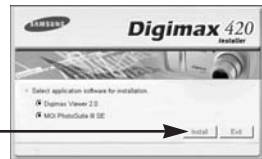

INFORMATION

- If you select [Exit] at step 2, the application program installation will be cancelled.

3. The [Digimax Viewer 2.0] installation window will be displayed as shown below. Click the [Next>] button.

[Click !]



Setting up the application software



INFORMATION

- If you select [Cancel] at step 3, a window for installing MGI PhotoSuite III SE will be displayed.

4. The Software License Agreement window will be displayed. If you agree to this, click [Yes], the window will then move to the next step. If you disagree, click [No] and the install program will be canceled.

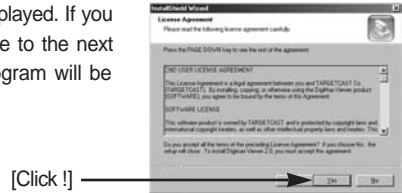

5. Select a destination folder and click [Next>].



6. Select the Program folder and click [Next>].



Setting up the application software

7. Installation is completed. Click the [Finish] button and a window for installing MGI PhotoSuite III SE will be displayed.



[Click !]

8. The [MGI PhotoSuite III SE] installation window will be displayed as shown below. Click the [OK] button.



[Click !]



INFORMATION

- If you select [Cancel] at step 8, a window for restarting the computer will be displayed.

9. A [Welcome] window will be displayed. Click the [Next>] button.

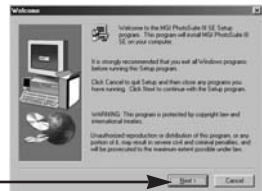

[Click !]

10. The Software License Agreement window will be displayed. If you agree to this, click [Yes], the window will then move to the next step. If you disagree, click [No] and the install program will be canceled.

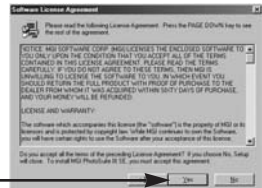

[Click !]

Setting up the application software

11. Select a setup type and click the [Next >] button.

Full : the program will be installed with all the options.
Custom : you can choose what you would like to install.



[Click !]

12. If installation is completed correctly, Autoplay is registered automatically into the start menu program as shown alongside. Click the [Next>] button.



[Click !]

13. The MGI Registration window will be displayed. Click the [Continue] button.

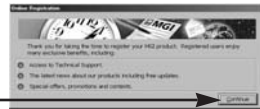

[Click !]

14. The [Online Registration Utility] window will be displayed. Fill in the blanks and click the [Register] button.

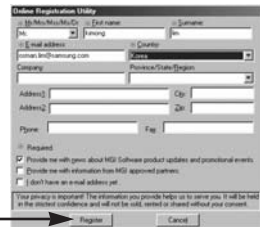

[Click !]

15. Installation is complete. Click the [Finish] button.



[Click !]

Setting up the application software



INFORMATION

- A [Read me] file will open. Click the Close button to close the file.

16. To use the [REMOVABLE DISK], you have to restart your computer. Click the [OK] button and the computer will restart.



[Click !]

17. After restarting the computer, connect the PC to the camera with the USB cable.

18. Turn the camera power on. [Found New Hardware Wizard] will open and the computer will recognize the camera.

* If you have ever installed an image viewer program or your OS is Windows XP, an image viewer program will open. If the image viewer program opens, the camera driver was setup successfully.



19. If you can see [Removable Disk] under [My computer], the camera driver installation was successful. Now you can transfer image files from the camera to PC via the USB cable.



Setting up the application software



INFORMATION

- If you have installed the camera driver, [Found New Hardware Wizard] may not open.
- After the [Found New Hardware Wizard] window opens, a window may open to select the camera driver file location. In this case, select the
 - win 98/98SE :C:\WINDOWS\OTHER
 - win ME/XP :C:\WINDOWS\INF
 - win 2000 :C:\WINNT\INF folder.

If you can't find the [INF(OTHER)] folder, check the [Show all files] button in [Window's Explorer →View → Folder option → View].

- Before connecting the camera to the PC, You should first install the camera driver.
- After installing the camera driver, you have to restart your PC.
- If you connect the camera to the PC before installing the camera driver, the [Found New Hardware Wizard] will open. In this case, cancel the [Found New Hardware Wizard] and disconnect the camera. Install the camera driver and connect the camera to the PC again.
- Should the computer not find the camera driver after installation, please try one or more of the following measures.
 1. Delete the camera driver (p.100), and re-install the driver.
 2. Refer to FAQ (p.122) to check for a possible solution to the problem.
 3. If your PC's central processing unit is VIA chip (This is shown in the USB Host Controller), download the patch file from the Samsung Camera web page. (<http://www.samsungcamera.com>)

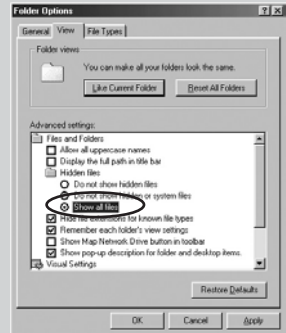

Removing the USB Driver for Windows 98SE

- To remove the USB driver, refer to the process shown below.

1. Trace [Start → Settings] and click [Control Panel]



2. Double-click [Add/Remove programs].



Removing the USB Driver for Windows 98SE

3. The [Add/Remove Programs Properties] window will open. Click [Digimax 420] and click the [Add/Remove] button.

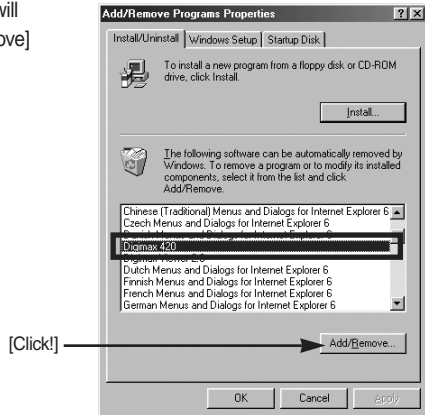

4. A window will open. Select [Remove] and click [Next >] button. The camera driver will be removed.



5. Uninstalling is complete. Click the [Yes] button and the window will disappear.

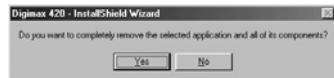

Removable Disk

To use this camera as a Removable Disk, install (p.110) the USB Driver.

1. Before turning the camera power on, connect the camera to the PC with the USB cable.
2. Click [Removable Disk] under [My computer] or [Windows Explorer].
3. Image files stored in the Removable Disk (DCIM → 100SSCAM) can be transferred to the PC.



NOTICE

Important information whilst using the Removable Disk

- The [Removable Disk] indicator will not show when the camera power is off.
- We recommend that you should copy the images to the PC to view them. Opening images directly from the removable disk may be subject to unexpected disconnection.
- When uploading images from the PC to the camera, ensure that the uploaded file names are not the same as those already stored on the memory.
- When you upload a file that is not taken by this camera to the Removable Disk, the [FILE ERROR!] message will be displayed on the LCD monitor in the PLAY mode, and nothing is displayed in THUMBNAIL mode.
- The green lamp next to the viewfinder will blink, when a file is transferred (copy or deletion) between the PC and the camera. Do not remove the USB cable until the lamp stops blinking. To remove the USB cable in Windows 2000/ME/XP, use the [Unplug or Eject Hardware] icon on the task bar.

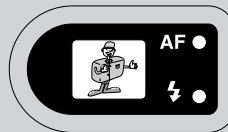

Removing the removable disk

■ Windows 98SE

1. Check whether the camera and PC are transferring a file. If the green lamp (next to the viewfinder) blinks, you have to wait until the LED illuminates.
2. Unplug the USB cable.

■ Windows 2000/ME/XP

(The illustrations may be different from the real display in accordance with the Windows O/S.)

1. Check whether the camera and PC are transferring a file.
If the green lamp (next to the viewfinder) blinks, you have to wait until the LED illuminates.
2. Double-click the [Unplug or Eject Hardware] icon on the task bar.



[Double-click]

3. The [Unplug or Eject Hardware] window will open.
Select the [USB Mass Storage Device] and click the [Stop] button.



Removing the removable disk

4. The [Stop a Hardware device] window will open.
Select the [SAMSUNG DIGIMAX 420 USB Device]
and click the [OK] button.



5. A [Safe to Remove Hardware] window will open.
Click the [OK] button.



6. A [Unplug or Eject Hardware] window will open.
Click the [Close] button and the removable disk will
be removed safely.



7. Unplug the USB cable.

Setting up the USB Driver for MAC

1. A USB Driver for MAC is not included with the Application CD as MAC OS supports the camera driver.
2. Check the MAC OS. You can check the MAC OS version during MAC OS start-up.
This camera is compatible with MAC OS 9.0–10.2.
3. Connect the camera to the Macintosh and turn the camera power on in PC mode.
4. A new icon (Untitled) will be displayed on the desktop after connecting the camera to the MAC.

Using the USB Driver for MAC

1. Double click a new icon (Untitled) on the desktop and the folder in the memory will be displayed.
2. Select an image file and copy or move it to MAC.



NOTICE

- If you use Mac OS 10.0 or later, you may experience an error occurring when you transfer files from the PC to the camera.

Digimax Viewer

This software is only compatible with Windows.



1. To open Digimax Viewer, click the [Start → Programs → Samsung → Digimax Viewer 2.0 → Digimax Viewer 2.0] and Digimax Viewer 2.0 will then open.

2. If the [Auto Launch] option is selected, this program will be executed automatically upon recognizing the camera.

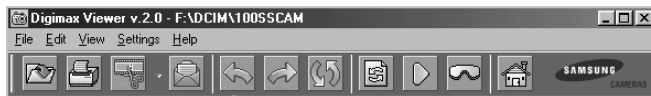

3. You can easily use the Digimax viewer program as it offers FILE menu and TOOL bar. And, you can use the pop up menu. Click an image and press the right mouse button.

Digimax Viewer functions are listed below.

- Basic function : Copy, Move, Delete, Rotate, Rename, changing file type, Resize, Property.
- Advanced function : Print, Slide show, Export, Sending e-mail, On-line print, Web album etc.



INFORMATION

- Refer to the [Help] menu in Digimax viewer 2.0 for further information.

MGI PhotoSuite III SE





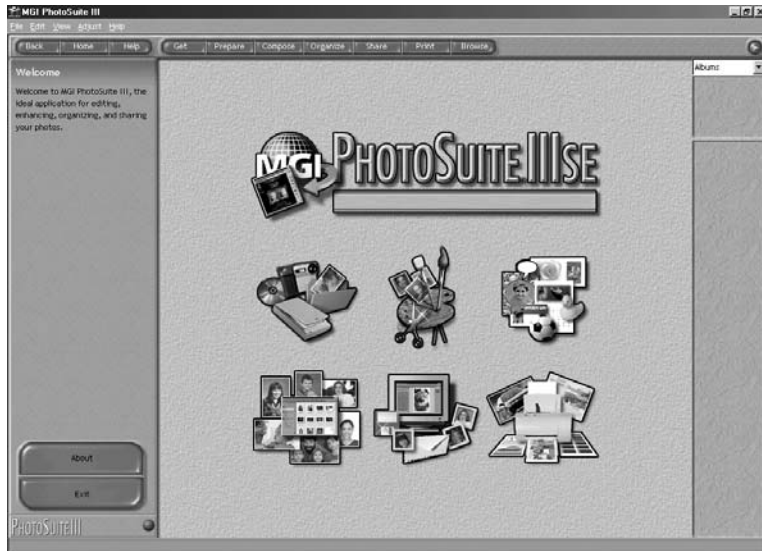

This software is only compatible with Windows.

To open MGI PhotoSuite III SE, click the [Start → Programs → MGI PhotoSuite III SE → MGI PhotoSuite III SE] and MGI PhotoSuite III SE will then open.



MGI PhotoSuite III SE









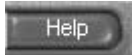

■ An introduction to the Welcome screen

	<p>Get</p> <p>Get images.</p>
	<p>Prepare</p> <p>A number of photo editing activities can be performed within this module.</p>
	<p>Compose</p> <p>Use your photos in a variety of fun, creative and interesting ways.</p>
	<p>Organize</p> <p>Organize your photos and other media files into albums.</p>
	<p>Share</p> <p>Save your results to show to others.</p>
	<p>Print</p> <p>Print hard copies of photos and projects.</p>

MGI PhotoSuite III SE

■ Introduction to navigation bar



	Back Return to the previous step.
	Home Return to Welcome screen.
	Help Display help window.
	Get Get images.
	Prepare A number of photo editing activities can be performed within this module.
	Compose Use your photos in a variety of fun and interesting ways.
	Organize Organize your photos and other media files into albums.
	Share Save your results to show to others.
	Print Print hard copies of photos and projects.
	Browse Browse the web site.

MGI PhotoSuite III SE

GET

■ To obtain images from the computer

1. To acquire images, Click the large [Get] button on the Welcome screen, or the [Get] button on the Navigation bar. Click [Computer] from the list of options displayed on the activity panel.



2. The Open file selector is displayed. Now select the image file and click [open].



3. The Welcome screen will change to the next work step, with the selected image displayed.



MGI PhotoSuite III SE

- The Welcome screen will change to the next work step, with the selected image displayed.

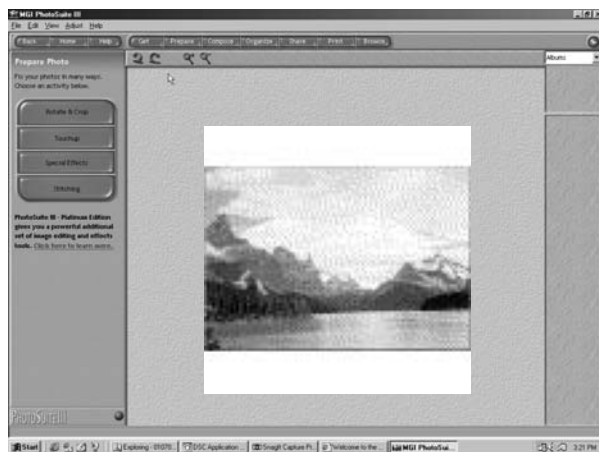

NOTICE

When you use the Digimax camera, only [Computer] and [Album] from the list of options displayed are available. You will be able to obtain images from the digital camera.



[Computer and Album Only]

MGI PhotoSuite III SE

■ Acquiring images from an Album.

1. To acquire images, click the large [Get] button on the Welcome screen, or the [Get] button on the Navigation bar. Click [Album] from the list of options displayed on the activity panel.



2. After selecting Album on the [1 Choose a photo album], click an image in the album and click [Open].



3. The Welcome screen will change to the next work step, with the selected image displayed.

※ Refer to page 117 for more information about creating an Album.

MGI PhotoSuite III SE

PREPARE

When the image is loaded, the step changes to Prepare automatically.

■ Menu for [PREPARE] steps

Rotate & Crop

You can rotate, flip or crop images along with a host of others.

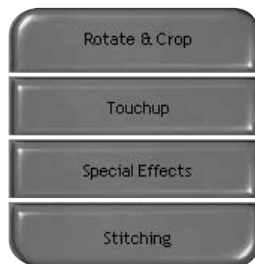

Touchup

Remove Red eye, Remove Scratches etc.. are available in this menu.

Special Effects

A number of special effects can be applied.

Stitching

Join a series of photos together to create a sweeping panoramic effect.

MGI PhotoSuite III SE

COMPOSE

Add text, Compound Images etc. are available in this step.

■ Menu of [COMPOSE] steps

- Collages** : A collage consists of several photos or sections of photos arranged together on a common background.
- Photo Layouts** : The Photo Layouts activity includes many collage and layout options.
- Cards & tags** : Use your photos to create items such as Gift Tags, Greeting Cards, Invitations, Postcards, and Sports Cards.
- Calendars** : Use your photos to create a variety of calendars (monthly, quarterly, seasonal, yearly).
- Collections** : Photos can also be used to create a variety of items for business purposes.
- Fun stuff** : You can create magazine covers, Backgrounds etc. in this menu.
- Business** : You can make business items such as business cards, certificates, signs, labels, promotions, name tags, stationary
- Frames & Edges** : Add frames and edge effects to your photos according to predefined templates.



MGI PhotoSuite III SE

ORGANIZE

Organize your photos and other media files into albums.

■ Menu of [ORGANIZE] steps

[① Choose a photo album to view or edit]

Select Album : To create an Album, click [Organize] in the welcome screen or navigation bar.

Album.. : Open Master Album.

[② Select a photo, and choose an action below.]

- Open : Open selected image.
- Delete : Delete selected image.
- Properties... : view image information.

[③ Choose an action to manage your album.]

- Add : click [Add] to add an image to an Album.
- Sort : click [Sort] to Sort saved images.
- Search : click [Search] to Search saved images.
- Reset : click [Reset] to reset the setting.
- Update : click [Update] to update images.
- Create Slide Show : click [Create Slide Show] to create a Slide Show.

Always start on this page : If you select this option, the program will start in [Organize].



MGI PhotoSuite III SE

■ Creating an Album

1. To create an Album, click the large Organize button on the Welcome screen, or the Organize button on the Navigation bar.
2. Click [Album...] in [1]Choose a photo album to view or edit.]
3. The Master Album window will be displayed, then click [New..].
4. Put a new Album name in the New Album window and click [OK]. A new album will now be created.
5. A [Master Album] window will open. Click the [OK] button.



MGI PhotoSuite III SE

■ Add images to the album

1. Select [③Choose an action to manage your album. → Add..] to add images to the album.

[Click!]



2. Click [Computer] in Add Photos menu.

[Click!]



NOTICE

[Digital Camera(Direct)], [Scanner(TWAIN)], [Digital Camera(TWAIN)] sources can't be used.

MGI PhotoSuite III SE

3. A [Add photo to Album] window will open. Select images that you want to add. Click the [Add] button.

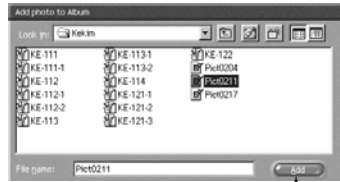

[Click!]

4. Adding images is complete.



MGI PhotoSuite III SE

SHARE

Saving or sharing images.

■ Menu of [SHARE] steps

Save

To save the active file according to its current name and path.

Save As

To assign a new name or path to the file.

Send E-mail

e-mailing images.

Slide Show

Viewing images as a slide show.



MGI PhotoSuite III SE

PRINT

You can print images.

■ Menu for the [PRINT] steps

Print

Printing images.

Print Multiples

Print multiple copies of a photo or project, or one copy of each of the photos included in an album, according to a predefined template.

- * Choose a printer, an orientation, the print size, and the number of copies. You can then print the images.



INFORMATION

For more information, please refer to the Help file in [Help MGI PhotoSuite III help].

FAQ

Please check the following if the USB connection malfunctions.

- [Case 1] The camera power is off.
→ Turn the camera power on. We recommend using an AC power adapter in PC mode.
If you use batteries, check the battery condition.
- [Case 2] USB Driver is not installed correctly.
→ Install the USB Driver correctly. Refer to page 94.
- [Case 3] The USB cable is not connected or you are using a cable with an incorrect specification.
→ Use a USB cable with the correct specification.
- [Case 4] Occasionally the computer recognizes the USB as another device.
→ Install the camera driver correctly. Turn the camera power off and remove the USB cable.
Connect the USB cable again and turn the camera power on. The computer should now recognize the camera.
- [Case 5] There is an unexpected error during file transfer.
→ Turn the camera power off and on again. Transfer the file again.

FAQ

[Case 6] How do I know my computer supports a USB Interface?

- Check the USB port in your computer or keyboard.
- Check OS version. USB Interface is available in Windows 98, 98SE, 2000, ME .XP.
- Check [Universal serial bus controller] in Device Manager. Do the following to check [Universal serial bus controller].

Win 98/ME : Trace [Start → Setting → Controller → System → Device Manager → Universal serial bus controller]

Win 2K : Trace [Start → Setting → Controller → System → Hardware Device Manager → Universal serial bus controller].

Win XP : Trace [Start → Control Panel → Performance and Maintenance → System → Hardware Device Manager → Universal Serial Bus controller].

There must be USB Host Controller and USB root hub under [Universal serial bus controller].

- When all the conditions mentioned above are met, the computer can support the USB interface.

[Case 7] When using the USB hub.

- There may be a problem in connecting the camera to the PC through the USB hub if the PC and the hub are not compatible. Wherever possible, connect the camera to the PC directly.

[Case 8] Are other USB cables connected to the PC?

- The camera may malfunction when it is connected to the PC at the same time as another USB cable. In this case, disconnect the other USB cable, and connect only one USB cable to the camera.



SAMSUNG TECHWIN CO., LTD.
OPTICS & DIGITAL IMAGING DIVISION
145-3, SANGDAEWON 1-DONG, JUNGWON-
GU, SUNGNAM-CITY, KYUNGKI-DO, KOREA 462-121
TEL : (82) 31-740-8086, 8088, 8090, 8092, 8099
FAX : (82) 31-740-8398, 8111

SAMSUNG OPTO-ELECTRONICS AMERICA, INC.
HEADQUARTERS
40 SEAVIEW DRIVE, SECAUCUS, NJ07094, U.S.A.
TEL : (1) 201-902-0347
FAX : (1) 201-902-9342

WESTERN REGIONAL OFFICE
18600 BROADWICK ST.,
RANCHO DOMINGUEZ, CA 90220, U.S.A.
TEL : (1) 310-537-7000
FAX : (1) 310-537-1566

SAMSUNG OPTO-ELECTRONICS UK LIMITED
SAMSUNG HOUSE
1000 HILLSWOOD DRIVE
HILLSWOOD BUSINESS PARK
CHERTSEY KT16 OPS U.K.
TEL : +44 (0) 1932 455000
FAX : +44 (0) 1932 455325

SAMSUNG OPTO-ELECTRONICS GMBH
AM KRONBERGER HANG 6
D-65824 SCHWALBACH/TS., GERMANY
TEL : (49) 6196 66 53 03
FAX : (49) 6196 66 53 66

SAMSUNG FRANCE S.A.S.
BP 51 TOUR MAINE MONTPARNASSE
33, AV .DU MAINE
75755, PARIS CEDEX 15, FRANCE
HOTLINE PHOTO NUMÉRIQUE :
00 800 22 26 37 27 (Numéro Vert-Appel Gratuit)
TEL : (33) 1-4279-2282/5
FAX : (33) 1-4320-4510

SAMSUNG TECHWIN MOSCOW OFFICE
KORP. 14 37-A LENNINGRADSKY PR-KT
MOSCOW, 125167, RUSSIA
TEL : (7) 095-258-9296, 9298, 9299
FAX : (7) 095-258-9297

TIANJIN SAMSUNG OPTO-ELECTRONICS CO.,LTD.
7 PINGCHANG ROAD NANKAI DIST., TIANJIN
P.R CHINA
POST CODE:300190
TEL : (86) 22-2761-8867
FAX : (86) 22-2761-8864

* Internet address - <http://www.samsungcamera.com/>



6806-1561

Free Manuals Download Website

<http://myh66.com>

<http://usermanuals.us>

<http://www.somanuals.com>

<http://www.4manuals.cc>

<http://www.manual-lib.com>

<http://www.404manual.com>

<http://www.luxmanual.com>

<http://aubethermostatmanual.com>

Golf course search by state

<http://golfingnear.com>

Email search by domain

<http://emailbydomain.com>

Auto manuals search

<http://auto.somanuals.com>

TV manuals search

<http://tv.somanuals.com>