



DAY & NIGHT COLOR CCD CAMERA

INSTRUCTION MANUAL

SDN-520N/P SDN-510N/P



SALES NETWORK

· SAMSUNG TECHWIN CO., LTD

Optics & Digital Imaging Division
145-3, Sangdaewon 1-Dong, Jungwon-Gu,
Sungnam, Kyungki-Do, Korea
462-121

TEL : 82-31-740 - 8137~41
FAX : 82-31-740 - 8145

· SAMSUNG OPTO-ELECTRONICS AMERICA, INC.

Closed Circuit Division
40 Seaview Drive, Secaucus N.J
07094, U.S.A.

TEL : (201) 902-0347
FAX : (201) 902-9342

P/NO. : 6806-0366-01A

Printed in Korea

Download from www.Somanuals.com. All Manuals Search And Download.

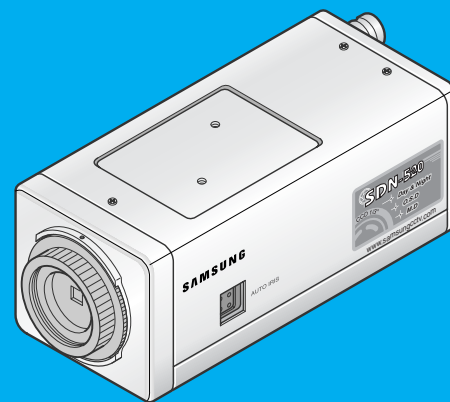

SAMSUNG CCD CAMERA

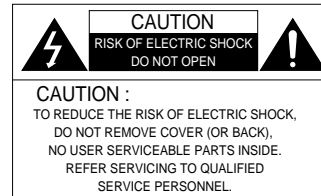

The lightning flash with an arrowhead symbol, within an equilateral triangle is intended to alert the user to the presence of uninsulated "dangerous voltage" within the product's enclosure that may be of sufficient magnitude to constitute a risk of electric shock to persons.



The exclamation point within an equilateral triangle is intended to alert the user to the presence of important operating and maintenance (servicing) instructions in the literature accompanying the appliance.

INFORMATION - This equipment has been tested and found to comply with limits for a Class A digital device, pursuant to part 15 of the FCC Rules. These limits are designed to provide reasonable protection against harmful interference when the equipment is operated in a commercial environment. This equipment generates, uses, and can radiate radio frequency energy and, if not installed and used in accordance with the instruction manual, may cause harmful interference to radio communications. Operation of this equipment in a residential area is likely to cause harmful interference in which case the user will be required to correct the interference at his own expense.

WARNING - Changes or modifications not expressly approved by the manufacturer could void the user's authority to operate the equipment.

CAUTION : To prevent electric shock and risk of fire hazards:

- ◆ Do NOT use power sources other than that specified.
- ◆ Do NOT expose this appliance to rain or moisture.

This installation should be made by a qualified service person and should conform to all local codes.

Features



The electronic iris shutter is automatically controlled at the speed of
1/60 - 1/10,000sec(NTSC Models) /
1/50 - 1/10,000sec(PAL Models).



The backlight compensation technology allows the camera to find the best picture conditions in any environment and automatically gives the necessary light level compensation, so that you can always obtain the clearest picture, finest detail and perfect light contrast.

Do not drop the camera or subject them to physical shocks.



It can cause malfunctions to occur.

Never keep the camera face to strong light directly.

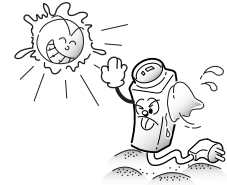

It can damage the CCD.

Do not touch the front lens of the camera.



Do not expose the camera to rain or spill beverage on it.



If it gets wet, wipe it dry immediately.
Liquids can contain minerals that corrode the electronic components.

Front

C Mount Adapter.

Attach the C-Mount Adapter when using the C-Mount Lens.

Tripod Mounting Bracket Screw Hole.

Used to fix the Tripod mounting bracket on the top of the camera.

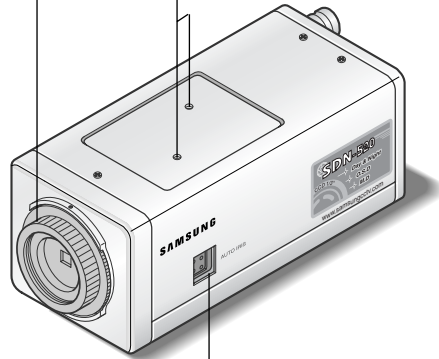

Auto Iris Lens Connector.

Used to connect the Auto iris lens plug.

Bottom

Tripod Mounting Hole

Used to install the camera on an optional tripod. The tripod must be equipped with the screw specified as shown below.

1/4"-20 UNC (20 THREAD)
L:4.5mm±0.2mm (ISO standard),
or 0.197" (ASA standard)

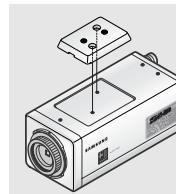
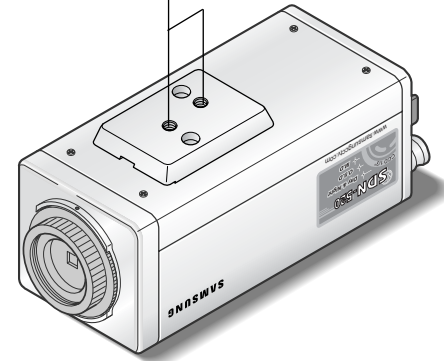
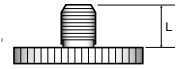

You can remove and install this bracket on the top of the camera. You must use the supplied screw or the equivalent (within 4mm). If not, the bracket may not be fixed properly.

Back

REMOTE Jack

Used to connect a remote plug.
This jack also provides the motion detect signal.

DC/VIDEO Selection Switch

Used to choose DC or VIDEO according to the type of your auto iris lens.

Menu Setup Buttons

SET Button

Used to access menu mode.
Also used to confirm the setting.

UP/DOWN Button

Used to choose the desired menu item. It also moves the cursor up or down in the menu screen.

LEFT/RIGHT Button

Used to change the parameter of the selected menu item. It also moves the cursor to the left or right in the menu screen.

Power LED

The LED turns on when power is supplied.

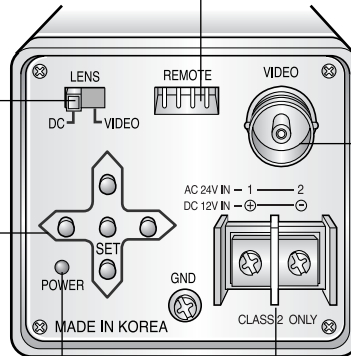

Video Out Jack

Used to connect an external video monitor in jack.

Power Terminal

Used to connect AC24V or DC12V power source.

Accessories

Auto Iris Lens Plug



Remote Plug

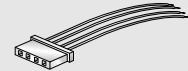

L-Wrench



C-Mount Adapter



Instruction Manual



Lens

The lens is not supplied with this camera. Purchase a lens suitable for your environment. This camera accepts the auto iris lens and both C- and CS-mount lens.



- If the lens is marked with fingerprints or other marks, the image quality might be poor.
- It is recommended to use a high quality lens to improve the image quality under low illumination.

Installing Auto Iris Lens

1. Peel approximately 8mm from the end of the lens cable outer cover.

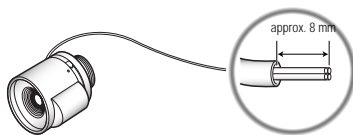

2. Peel approximately 2mm from the end of the cable inner cover.

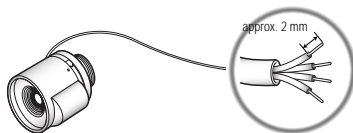

3. Remove the cover from the iris lens plug supplied, and solder the lens cable to the plug as shown below.

- Video type :
 - No. 1 Pin --- Red (Power source)
 - No. 2 Pin --- N.C
 - No. 3 Pin --- White (Video signal)
 - No. 4 Pin --- Black (GND)
- DC type :
 - No. 1 Pin --- Damping -
 - No. 2 Pin --- Damping +
 - No. 3 Pin --- Drive +
 - No. 4 Pin --- Drive -

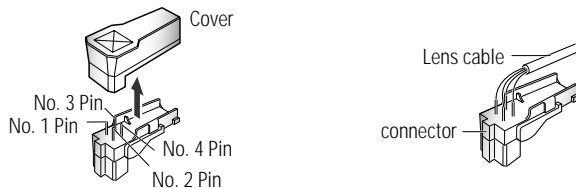

4. Remove the protective cap, and attach the lens to the camera by turning clockwise.
5. Connect the lens plug to the auto iris connector on the right side of the camera.

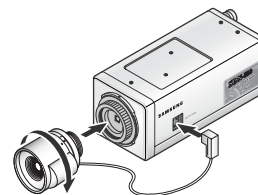

6. Set the DC/VIDEO selection switch to DC or VIDEO according to the type of the lens.

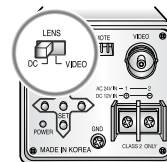

◆ Mounting a C-mount lens

1. Attach the C Mount lens adapter by turning clockwise.

◆ Mounting a CS-mount lens

After removing the protecting cap, attach the lens into the camera by turning clockwise.



- Use the lens under the specification as shown. Otherwise the lens can damage the camera or abnormal fixing may result.

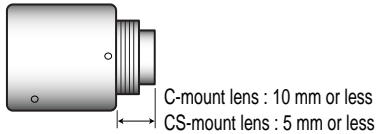

- A heavy lens may disturb the balance with the camera and possibly result in damage. Don't use a lens heavier than 450g.
- It is recommended to set the lens ALC mode to Av mode (Average). Pk mode can be occurred hunting.

2. Attach the lens to the camera by turning clockwise.

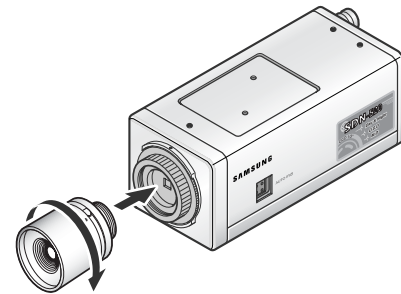

Connecting to P

• As the connection varies by environment, refer to the manual for details.

If necessary, you can connect the REMOTE to the back of the camera.

When the power is turned on, the camera will be in standby mode. Press the power button to turn on the camera. The camera will start recording when the power button is pressed. The camera will stop recording when the power button is pressed again.

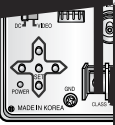

Setup Menu

Camera ID (see page 23)

- **ON** : Activate. You can enter up to 14 alphanumeric characters and select the ID position.
- **OFF** : Deactivate

Backlight (see page 26)

- **ON** : Backlight Compensation.
- **OFF** : Deactivate.

Motion Detection (see page 27)

- **ON** : Activate.
- **OFF** : Deactivate

Lens Selection (see page 31)

- **Manual lens**
- **DC or Video lens**

Shutter Speed Control (see page 32)

- **ESC (Electronic Shutter Control)** : Electronically adjusts the optimal shutter speed.
- **Manual** : Manually adjusts the shutter speed.

Gain Control (see page 34)

- **AGC (Auto Gain Control)** : Activates AGC feature.
- **OFF** : Deactivate AGC feature.

White Balance Control (see page 35)

- **ATW (Auto Tracing White balance)** : Automatically controls white balance.
- **AWC (Auto White balance Control)** : Automatically controls white balance.
- **Manual** : Manually controls white balance.

Color (Day & Night) (see page 36)

- **AUTO 1** : Automatic changeover by sensing day or night condition. (Under sunlight or fluorescent lamps)
- **AUTO 2** : Automatic changeover by sensing day or night condition. (Under incandescent lamps)
- **ON** : Activate in only color mode.
- **OFF** : Activate in only black and white mode.

Synchronization Mode (see page 37)

- **INT** : Internal synchronization
- **LL** : External line lock synchronization

Reset (see page 38)

●
END

Setup Menu

Use the five Setup Menu buttons on the rear of the camera.

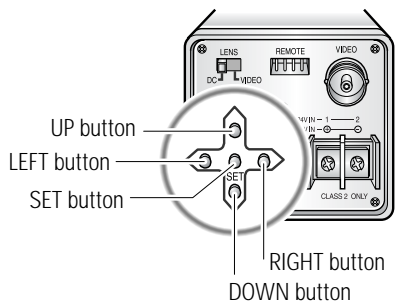

1. Press the SET button to access the setup mode.

◆ Setup menu is displayed on the monitor screen.

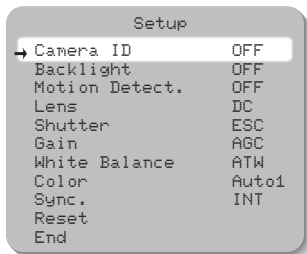

2. Select the desired feature using the UP or DOWN button.

- ◆ Each time you press the UP or DOWN button, the arrow indicator moves up or down.
- ◆ Move the arrow indicator to the desired feature item.

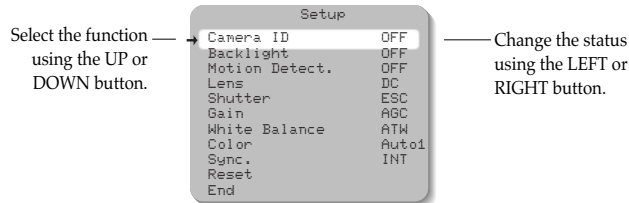

3. Change the status of the selected feature using the LEFT or RIGHT button.

4. When completed, move the arrow indicator to 'End' and press the SET button.

Camera ID

If you enter a camera ID, the name will be displayed in the screen monitor.

1. Press the SET button to display the setup menu and move the arrow indicator to 'Camera ID' using the UP or DOWN button.
2. Set 'Camera ID' to 'ON' using the LEFT or RIGHT button.



- If the camera ID feature is set to 'OFF', the name will not displayed in the monitor.

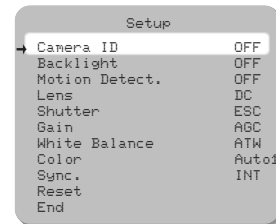

Backlight

The Wide Dynamic Range and Super BLC technology in your camera provides intelligent light level control to overcome the severe Backlight conditions.

1. Press the SET button to display the setup menu and move the arrow indicator to 'Backlight' using the UP or DOWN button.

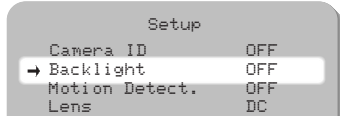

2. Set 'Backlight' to "ON/OFF" using the LEFT or RIGHT button.

- ON : Backlight Compensation.
*The activating zone of BLC is focused on the center of monitor occupying 20% of the full screen.
BLC area can be focused on more by increasing the weight number.*
- OFF : Deactivate.

3. Press the 'SET' button.

◆ When 'ON' is chosen, you can adjust the weight.

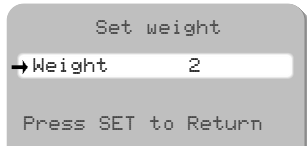

You can select the weight from 0 to 4.

By increasing the number, the activating zone of BLC is more focused on the center of monitor.

4. When completed, press the SET button.

Motion Detection

Your camera transmits an alert signal when it detects motion of an object on the screen. If you connect the camera to an external alarm, you can pay attention to the screen when the alarm sounds. This feature is useful when you have to monitor several screens simultaneously.

1. Press the SET button to display the setup menu and move the arrow indicator to 'Motion Detect.' using the UP or DOWN button.
2. If you want to activate the motion detecting mode, set 'Motion Detect.' to 'ON' using the LEFT or RIGHT button.

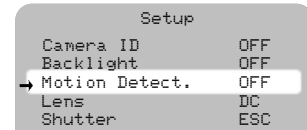

3. Press the SET button.

◆ The Motion Detection screen appears. You can assign the active zone.

4. Specify the zone area.

- ◆ You can point to the top, bottom, left, and right base lines by setting a proper value from 0 to 15 with an increment of 1.

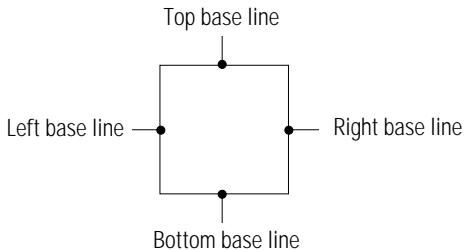

- ◆ Move the arrow indicator to 'Top' using the UP or DOWN button and increase or decrease the value using the LEFT or RIGHT button. Repeat the procedure for bottom, left, and right.

How to Assign the Zone

If you assign a zone, an alert signal occurs when the camera detects motion of objects in that zone.

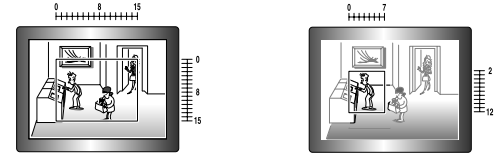

Ex. Full screen

Ex. Zone
Top 2 Bottom 12 Left 0 Right 7

5. Adjust Sensitivity.

- ◆ Move the arrow indicator to 'Sensitivity' using the UP or DOWN button, then press the LEFT or RIGHT button to decrease or increase the value.
- ◆ If you decrease the sensitivity, the camera will detect only motion that is clearly noticeable. If you want to set the camera to detect minor motion, increase the sensitivity.
- ◆ You can select the sensitivity from 0 to 10. Higher sensitivity detects smaller motions at the risk of false detection. Therefore zone adjustment is recommended rather than sensitivity adjustment.

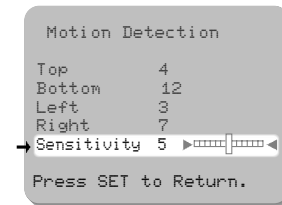

3. If you choose "DC", you can adjust the brightness.

After pressing the SET button, adjust the brightness of the monitor screen using the LEFT or RIGHT button.

- ◆ The screen becomes darker when the value is decreased and brighter when the value is increased.
- ◆ You can adjust the brightness from 0 to 99.



- You can only adjust the brightness in DC mode.
- It is recommended to set the value at 60 to stabilize the operation.
- To control the brightness of the auto iris lens, refer to the owner's manual.

4. When completed, press the SET button.

Shutter Speed Control

Select ESC (Electronic shutter control) or manual control of the shutter speed.

1. Press the SET button to display the setup menu and move the arrow indicator to 'Shutter' using the UP or DOWN button.
2. Select 'ESC' or 'Manual' shutter using the LEFT or RIGHT button.
 - ◆ ESC : Electronically controls the optimal shutter speed.
 - ◆ Manual : You can select the shutter speed.

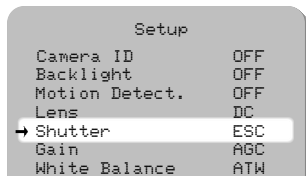

3. If you choose 'Manual', select the optimal shutter speed.

- ◆ You can select speed from '1/60' to '1/10,000' sec (NTSC Models), / '1/50' to '1/10,000' sec (PAL Models).
- ◆ When the shutter speed is increased or decreased using the LEFT or RIGHT button, you can find the difference by monitoring the brightness of the screen.

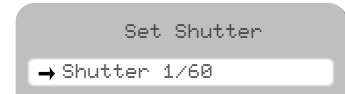

NTSC Models



PAL Models

4. When completed, press the SET button.



- If the camera directly faces strong fluorescent light in 'ESC' mode, the image may become unstable.
- If you choose 'ESC', you can adjust the brightness of monitor screen using the LEFT or RIGHT button.

Gain Control

1. Press the SET button to display the setup menu and move the arrow indicator to 'Gain' using the UP or DOWN button.
2. Select 'AGC' or 'OFF' using the LEFT or RIGHT button.
 - ◆ AGC : Activates automatic gain control feature.
 - ◆ OFF : Deactivates automatic gain control feature.

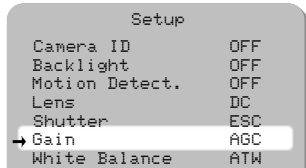

- If you choose 'AGC', you can adjust the brightness using the LEFT or RIGHT button from 0 to 99.
- In 'AGC' mode, you can select the Gain limit 'Low' or 'High' or 'Middle'.
- If you choose 'High' in the 'Gain limit' menu, the image is more detailed and more noise.
- If you choose 'Low' in the 'Gain limit' menu, the image is less detailed and less noise.

White Balance Control

Your camera provides 3 white balance control modes. You can select the most suitable one. You can adjust the white balance.

1. Press the SET button to display the setup menu and move the arrow indicator to 'White Balance' using the UP or DOWN button.
2. Select the desired control mode using the LEFT or RIGHT button.

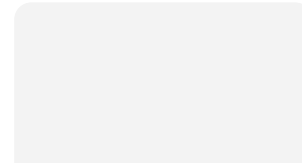

The three white balance control modes are as follows :

- ATW (Auto Tracing white balance) : The camera automatically controls the white balance in any environment.



- Do not use 'ATW' mode when the camera is installed under severe lighting condition.
- AWC (Auto White balance Control) : The white balance is automatically adjusted in a specific environment. In order to obtain the best result, press the SET button while the camera focuses on white paper. If the environment including the light source is changed, you have to adjust the white balance again.
- Manual : To fine adjust, select the Manual mode. You can increase or decrease the red or blue factor while monitoring the difference on the screen. To use the mode more effectively, set it to ATW or AWC mode to obtain a proper white balance, then set to 'Manual' mode and press the SET button. Increase or decrease the value for red and blue, watching the color of the picture, and press the SET button when you obtain the best color.

Color (Day & Night)

Your camera provides automatic mode changeover by sensing day or night conditions. It changes to Color mode in day conditions for optimal color and to BW mode in night conditions for clear identification.

1. Press the SET button to display the setup menu and move the arrow indicator to 'Color' using the UP or DOWN button.
2. Select a mode using the LEFT or RIGHT button.
 - ◆ ON : Color mode is kept up.
 - ◆ OFF : A black and white mode is kept up.
 - ◆ Auto1 : Select this mode under a normal light source(sunlight or fluorescent lamp). When changing between color and B/W, the OSD key does not act for 3 seconds.
 - ◆ Auto2 : Select this mode under light source that have a wavelength range mostly above 800nm(incandescent lamp). When changing between color and B/W, the OSD key does not act for 3 seconds.

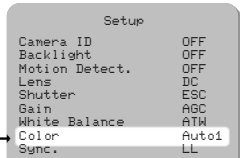

3. Press the SET button.



- If you set low level in Video IRIS mode, Color/BW may not change over automatically.
- Under Gain OFF Color/BW does not change over automatically, ON/OFF is only available.
- If you change 'Gain' menu from ON to OFF, 'Color' mode change to ON.
- If you change 'Gain' menu from OFF to ON, 'Color' mode change to Auto1.
- Select Auto2 in 'Color' mode under incandescent lamp.
- Adjust the focus if the camera is out of focus for changing modes.

Synchronization Mode

Two synchronization modes are available Internal and External linelock. -In linelock mode, it synchronizes the video signal between cameras without a synchronous generator. The linelock synchronization is only used in the areas of 60Hz(NTSC Models)/50Hz(PAL Models).

1. Press the SET button to display the setup menu and move the arrow indicator to 'Sync.' using the UP or DOWN button.
2. Select 'LL' or 'INT' using the LEFT or RIGHT button.
 - ◆ INT : Internal synchronization.
 - ◆ LL : External linelock synchronization.

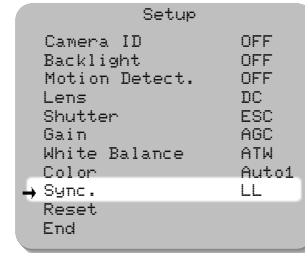

3. LL mode Press the SET button.

- ◆ The phase is preset to 225 degrees at the factory. You can re-adjust it from 0 to 270 degrees.

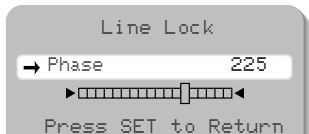

- When the power frequency is 50Hz, you can not use line lock mode (NTSC Models).
- When the power frequency is 60Hz, you can not use the line lock mode (PAL Models).
- 'Sync.' mode is fixed to 'INT' in DC12V input power.

Reset

This function resets the camera to the default settings pre-set at the factory.

- ◆ All modes are initialized and return to the default status.

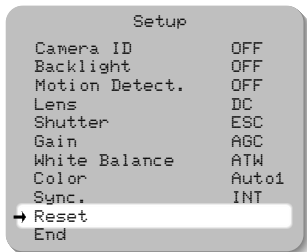

Using Remote Jack

If you connect a remote plug to the REMOTE jack on the rear of the camera as shown below, you can access the menu setup mode from a remote place.

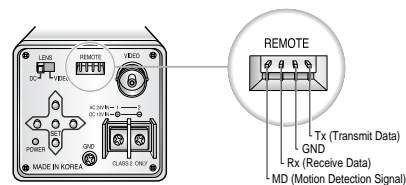

1. RS-232C Communication Setting.
Mode : Serial
Bit/sec : 9600bps
Port : Com1
Parity : None
2. Setup menu Command.

Setup menu	Command	Byte
Set	A0, A0, 01, 00, 00, AF	6
Up	A0, A0, 02, 00, 00, AF	6
Down	A0, A0, 03, 00, 00, AF	6
Left	A0, A0, 04, 00, 00, AF	6
Right	A0, A0, 05, 00, 00, AF	6

3. Motion Detection Output Signal Level.

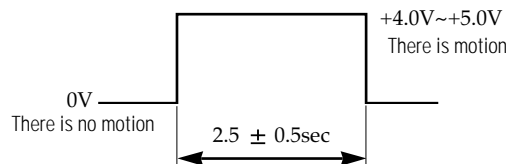

- You must turn the camera power off when you connect or remove the remote plug.

If you have trouble operating your camera, refer to the following table. If the guidelines do not enable you to solve the problem, contact an authorized technician.

Problem	Solution
Nothing appears on the screen.	<ul style="list-style-type: none"> • Check that the power cord and line connection between the camera and monitor are fixed properly. • Check that the DC/VIDEO selection switch on the rear of the camera is set to a proper position according to the type of your auto iris lens.
The image on the screen is dark.	<ul style="list-style-type: none"> • Check that you have set the 'Shutter' feature under the setup menu to 'ESC' mode. • Check that you have set to a proper sensitivity and brightness level in the 'Shutter' feature.
The afterimage of moving objects remain on the screen.	<ul style="list-style-type: none"> • It occurs temporarily when the camera converge available light to produce clear image under low illumination. It is normal. • If you decrease the sensitivity level of the 'Shutter' feature under the setup menu, this symptom can be eliminated, but the image on the screen may be darker.
The image on the screen is dim.	<ul style="list-style-type: none"> • Check if the lens is stained. If dirty, clean the lens with soft, clean cloth.
The camera is not working properly, and the surface of the camera case is hot.	<ul style="list-style-type: none"> • Check that you have properly connected the camera to an appropriate power source. Refer to page 17.

Problem	Solution
'Auto' mode does not activate.	<ul style="list-style-type: none"> • Have you set the 'Gain' feature under the setup menu to 'OFF'? Set the feature to 'AGC'. • Have you set the level of video lens too low?
The color of the picture is not matched.	<ul style="list-style-type: none"> • Check that you have properly set the 'White Balance' feature under the setup menu.
The contrast on the screen is too weak.	<ul style="list-style-type: none"> • Adjust the contrast feature of the monitor. • If the camera is exposed to too strong light, change the camera position.
The image on the screen flickers.	<ul style="list-style-type: none"> • Is the camera facing to direct sunlight or fluorescent lighting? Change the camera position. • Check that the DC/VIDEO selection switch on the rear of the camera is set to a proper position according to the type of your auto iris lens.
The image on the screen is distorted.	<ul style="list-style-type: none"> • Check that the power frequency is proper in 'Sync.' If the power frequency is not proper, the linelock synchronization mode cannot be used. Set the 'Synchronization Mode' to 'INT' mode. <ul style="list-style-type: none"> – NTSC Model's Power frequency in LL mode: 60Hz – PAL Model's Power frequency in LL mode: 50Hz

Specifications

Item	SDN-520N	SDN-510N	SDN-520P	SDN-510P
Power Source	AC 24V, 60Hz / DC 12V		AC 24V, 50Hz / DC 12V	
Image Pick-Up Device	1/3 * SONY EX-VIEW HAD IT CCD	1/3 * Solid State Image Device CCD(SONY)	1/3 * SONY EX-VIEW HAD IT CCD	1/3 * Solid State Image Device CCD(SONY)
Scanning System	2:1 Interlace(NTSC Standard) 525 Lines / 60 Fields / 30 Frames		2:1 Interlace(PAL Standard) 625 Lines / 50 Fields / 25 Frames	
Picture elements	811(H) × 508(V)		795(H) × 596(V)	
Effective picture elements	768(H) × 494(V)		752(H) × 582(V)	
Resolution	480(Color)/520(BW)TV Lines Horizontally			
Video Output	1.0 V _{p-p} NTSC composite		1.0 V _{p-p} PAL composite	
Backlight Compensation	On/Off Selectable			
Color	Auto1/Auto2/On/Off Selectable			
RS-232C Communication	Available			
O.S.D	Built-in			
Iris Mode	Video Iris / DC Iris / ESC Selectable			
Electronic Shutter	1/60~1/10,000 sec		1/50~1/10,000 sec	
White Balance	ATW / AWC / MANUAL Selectable			
Lens Mount	CS-mount(or C-mount with the supplied adaptor)			
Min. Illumination	0.5 Lux at F1.2 (Color) 0.01 Lux at F1.2 (B&W)	0.5 Lux at F1.2 (Color) 0.03 Lux at F1.2 (B&W)	0.5 Lux at F1.2 (Color) 0.01 Lux at F1.2 (B&W)	0.5 Lux at F1.2 (Color) 0.03 Lux at F1.2 (B&W)
S/N Ratio	More than 48dB (AGC Off)			
Power Consumption	3.8W at AC24 / 3.5W at DC12			
Synchronizing System	Internal/Line lock selectable			
Environmental conditions	- 10°C ~ +50°C			
Dimension	55(W) × 57(H) × 135(L)mm (Without Lens)			
Weight	Approx 400g (Without Lens)			
Accessory	Auto Iris Lens Plug, Remote Plug, L-Wrench, Instruction Manual, C-Mount Adapter			

DECLARATION OF CONFORMITY

Application of Council Directive(s)	89/336/EEC
Manufacturer's Name	SAMSUNG TECHWIN CO., LTD
Manufacturer's Address	SAMSUNG TECHWIN CO., LTD 42, SUNGJU-DONG CHANGWON-CITY, KYUNGNAM, KOREA, 641-120
European Representative Name	
European Representative Address	
Equipment Type/Environment	CCTV Camera
Model Name	SDN-520P/510P
Beginning Serial NO.	S2040001
Year of Manufacture	2002. 4. 1
Conformance to	EN 50081-1 : 1992 EMC-Directive 89/336 EEC and 92/31/EEC EN 50130-4 : 1996

We, the undersigned, hereby declare that the equipment specified above conforms to the above Directive(s).

Manufacturer	SAMSUNG TECHWIN CO., LTD	Legal Representative in Europe
Signature	<i>Young Taek, SON</i>	Signature
Full Name	YOUNG TAEK SON	Full Name
Position	QUALITY CONTROL MANAGER	Position
Place	CHANGWON, KOREA	Place
Date	2002. 4. 1	Date

Free Manuals Download Website

<http://myh66.com>

<http://usermanuals.us>

<http://www.somanuals.com>

<http://www.4manuals.cc>

<http://www.manual-lib.com>

<http://www.404manual.com>

<http://www.luxmanual.com>

<http://aubethermostatmanual.com>

Golf course search by state

<http://golfingnear.com>

Email search by domain

<http://emailbydomain.com>

Auto manuals search

<http://auto.somanuals.com>

TV manuals search

<http://tv.somanuals.com>