

SAMSUNG



Digimax A55W

User's Manual

Thank you for buying a Samsung Camera.
This manual will guide you through using the camera, including capturing images,
downloading images and using the application software.
Please read this manual carefully before using your new camera.

ENGLISH

Download from Www.Somanuals.com. All Manuals Search And Download.

Instructions

- Use this camera in the following order

Set up the camera driver

Before connecting the camera to a PC, via the USB cable, you will need to set up the camera driver. Install the camera driver that is contained in the Application S/W CD-ROM.(p.106)

Take a picture

Take a picture (p.19)

Insert the USB cable

Insert the supplied USB cable into the PC's USB port and the camera's USB connection terminal.(p.115)

Check the camera's power

Check the camera's power.
If the power is turned off, slide the camera switch to turn it on.

Check [Removable Disk]

Open Window's EXPLORER and search for [Removable Disk].(p.116)

- If you use a card reader to copy the images on the memory card to your PC, the images could be damaged. When transferring the images taken with the camera to your PC, be sure to use the supplied USB cable to connect the camera to your PC. Please note that the manufacturer holds no responsibility for loss or damage of images on the memory card due to the use of a card reader.

Contents

READY

● Getting to know your camera	5
● Danger	6
● Warning	6
● Caution	7
● An FCC warning	7
● System chart	8
● Identification of features	10
■ Front & Top	10
■ Back & Side	10
■ Side/ 5-function button	11
■ Self-timer lamp	12
■ Camera Status Lamp	12
■ Mode icon	12
● Connecting to a Power Source	13
■ Using the batteries	14
● Instructions on how to use the memory card	15
● Inserting the memory card	17
● Removing the memory card	17

RECORDING

● LCD monitor indicator	18
● Changing the recording mode	19
■ Selecting the [MODE] menu	19
● Starting the recording mode	22
■ How to use the Auto mode	22
■ How to use the Movie clip mode	22
■ Recording the movie clip without voice	23
■ Using Successive Recording	23
■ How to use the Program mode	23
■ How to use the Scene modes	24
■ How to use the VOICE RECORDING mode	25
● Things to Watch Out for When Taking Pictures	26

● Using the camera buttons to adjust the camera	27
■ Power switch	27
■ SHUTTER button	27
● ZOOM W/ T button	27
● Voice recording/ Voice memo/ UP button	30
● Macro/ Down button	31
● Focus lock	32
● Flash/ Left button	33
● Self-timer/ Right button	35
● MENU/ OK button	36
● M (Mode) button	36
● E (Effect) button	39
● Special Effect : Colour	39
● Special Effect : Preset focus frames	40
● Special Effect : Composite shooting	41
● Special Effect : Photo Frame	43
● Movie Clip frame stabiliser	44
● +/- button	45
● Using the LCD monitor to adjust the camera settings	48
● How to use the menu	50
● Mode	50
● MODE SET	51
● Size	52
● Quality/ Frame rate	53
● Metering	54
● Continuous Shooting	54
● Sharpness	55
● OSD(On Screen Display) information	55

PLAY

● Starting play mode	56
■ Playing back a still image	56
■ Playing back a movie clip	57
■ How to capture the movie clip	57

Contents

■ On camera movie trimming	58	● Imprinting the recording date	88
■ Playing back a recorded voice	59	● Auto Focus lamp	89
● LCD monitor indicator	60	● Sound	89
● Using the camera buttons to adjust the camera	61	● LCD brightness	90
● Thumbnail/ Enlargement button	61	● Selecting Video out type	90
● Voice memo/ Up button	62	● Quick view	92
● Play & Pause/ Down button	63	● Initialisation	92
● Delete button	64	● Setting up the MYCAM menu	93
● Left/ Right/ Menu/ OK button	65	● Start up image	93
● Album button	66	● Shutter sound	94
● Setting up the play back function using the LCD monitor	69	● Start up sound	94
● Rotating an image	72	● Important notes	95
● Resize	73	● Warning indicator	97
● Protecting images	74	● Before contacting a service centre	98
● Deleting all images	75	● Specifications	101
● DPOF	75		
● DPOF : STANDARD	76		
● DPOF : INDEX	76		
● DPOF : PRINT SIZE	77		
● DPOF : CANCEL	77		
● COPY TO CARD	78		
● PictBridge	79		
● PictBridge : Picture Selection	80		
● PictBridge : Print Setting	81		
● PictBridge : Print	82		
● PictBridge : RESET	83		

SETUP

● Setup menu	84
● File name	85
● Auto power off	86
● Language	87
● Formatting a memory card	87
● Setting up the Date/ Time/ Date type	88

SOFTWARE

● Software Notes	103
● System Requirements	103
● About the software	104
● Setting up the application software	106
● Starting PC mode	115
● Removing the USB Driver for Windows 98SE	118
● Removable Disk	119
● Removing the removable disk	120
● Setting up the USB Driver for MAC	121
● Using the USB Driver for MAC	121
● Digimax Viewer 2.1	122
● Using PhotoImpression	123
● FAQ	125

Getting to know your camera

Thank you for buying a Samsung Digital Camera.

- Prior to using this camera, please read the user manual thoroughly.
- When you require After Sales service, please bring the camera and the cause of the camera malfunction (such as Battery, Memory card etc.) to the A/S centre.
- Please check that the camera is operating properly prior to when you intend to use it (e.g. for a trip or an important event) to avoid disappointment. Samsung camera takes no responsibility for any loss or damages that may result from camera malfunction.
- Keep the manual in a safe place.
- ✧ Microsoft, Windows and Windows logo are registered trademarks of Microsoft Corporation incorporated in the United States and/or other countries.
- ✧ All brand and product names appearing in this manual are registered trademarks of their respective companies.

This manual contains instructions on using this camera that will help you to use this camera safely and correctly. This will help prevent danger and injury to others.



DANGER

DANGER indicates an imminently hazardous situation which, if not avoided, will result in death or serious injury.



WARNING

WARNING indicates a potentially hazardous situation, which, if not avoided, could result in death or serious injury.



CAUTION

CAUTION indicates a potentially hazardous situation, which, if not avoided, may result in a minor or moderate injury.



Correct Disposal of This Product (Waste Electrical & Electronic Equipment)

(Applicable in the European Union and other European countries with separate collection systems) This marking shown on the product or its literature, indicates that it should not be disposed with other household wastes at the end of its working life.

To prevent possible harm to the environment or human health from uncontrolled waste disposal, please separate this from other types of wastes and recycle it responsibly to promote the sustainable reuse of material resources. Household users should contact either the retailer where they purchased this product, or their local government office, for details of where and how they can take this item for environmentally safe recycling. Business users should contact their supplier and check the terms and conditions of the purchase contract. This product should not be mixed with other commercial wastes for disposal.

Danger

- Do not attempt to modify this camera in any way. This may result in fire, injury, electric shock or severe damage to you or your camera. Internal inspection, maintenance and repairs should be carried out by your dealer or Samsung Camera Service centre.
- Please do not use this product in close proximity to flammable or explosive gases, as this could increase the risk of explosion.
- Should any form of liquid or a foreign object enter the camera, do not use it. Switch off the camera, and then disconnect the power source.
You must contact your dealer or Samsung Camera Service centre.
Do not continue to use the camera as this may cause a fire or electric shock.
- Do not insert or drop metallic or inflammable foreign objects into the camera through access points e.g. the memory card slot and battery chamber.
This may cause a fire or electric shock.
- Do not operate this camera with wet hands. This could pose a risk of electric shock.

DANGER

Warning

- Do not use the flash in close proximity to people or animals.
Positioning the flash too close to your subject's eyes, may cause eyesight damage.
- For safety reasons keep this product and accessories out of reach of children or animals to prevent accidents e.g.:
 - Swallowing battery, or small camera accessories. If an accident should occur, please consult a doctor immediately.
 - There is the possibility of injury from the camera's moving parts.
- Battery and camera may become hot during prolonged use and it may result in camera malfunction. Should this be the case, allow the camera to sit idle for a few minutes to allow it time to cool.
- Do not leave this camera in places subject to extremely high temperatures, such as a sealed vehicle, direct sunlight or other places of extreme variances in temperature.
Exposure to extreme temperatures may adversely affect the camera's internal components and could cause a fire.
- When in use, do not cover the camera.
This may cause heat to build up and distort the camera body or cause a fire.
Always use the camera and its accessories in a well-ventilated area.

WARNING

Caution

- Leaking, overheating, or burst battery could result in fire or injury.
 - Use battery with the correct specification for the camera.
 - Do not short circuit, heat or dispose of battery in fire.
 - Do not insert the battery with the polarities reversed.
- Remove the battery when not planning to use the camera for a long period of time. Battery may leak corrosive electrolyte and permanently damage the camera's components.
- Do not fire the flash while it is in contact with hands or objects. Do not touch the flash after using it continuously. It may cause burns.
- Take care not to touch the lens and where the lens cover is to avoid taking an unclear image and possibly causing camera malfunction.
- Avoid obstructing the lens or the flash when you capture an image.



CAUTION

An FCC warning

- This device has been tested in accordance with the limits of a class B digital device under item 15 of the FCC rules. These limits are designed to provide protection against harmful interference in commercial installation. This equipment generates, absorbs and can emit radio frequency energy. If it is not installed and used in accordance with the instructions, it may cause harmful interference to radio communication.

There is however, no guarantee that interference will not occur in some situations. Should any interference occur when this device is in operation, please try one or more of the following measures.

- Change the location and direction of any aerial.
 - Increase distance between the camera and the affected device.
 - Use a different socket away from the affected device.
 - Please contact a Samsung agent or a radio/TV engineer.
- This device complies with part 15 of the FCC Rules.
 - Changes or modifications not expressly approved by the party responsible for compliance could void user's authority to operate the equipment.

System chart

Please check that you have the correct contents before using this product. **The contents can vary depending on the sales region.** To buy the optional equipment, contact your nearest Samsung dealer or Samsung service centre.

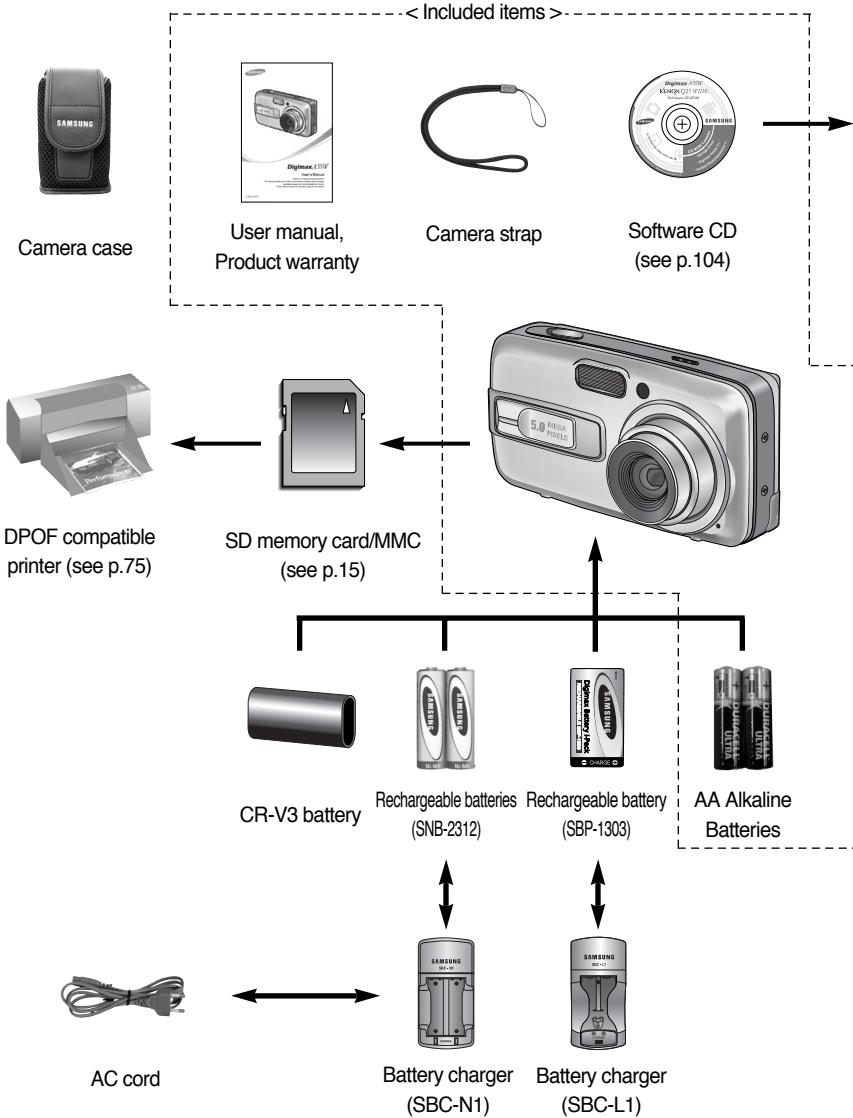

System chart

System Requirements

For Windows

- PC with processor better than MMX Pentium 233MHz (XP : Pentium II 300MHz)
- Windows 98/98SE/2000/ME/XP
- Minimum 64MB RAM (Over 128MB recommended)
- 200MB of available hard-disk space (Over 1GB recommend)
- USB port
- CD-ROM drive
- 1024X768 pixels, 16-bit color display compatible monitor (24-bit color display recommended)
- DirectX 8.1 or later

For Macintosh

- Power Mac G3 or later
- Mac OS 9.2 ~ 10.3
- Minimum 64MB RAM
- 110MB of available hard-disk space
- USB port
- CD-ROM drive
- QuickTime player or a media player that supports AVI file format.

CAUTION

When you connect the camera to a computer or printer, you have to use the USB cable supplied with the camera, or the external devices may not recognise the camera.



Computer
(see p.115)

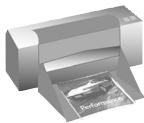

PictBridge compatible
printer(see p.79)



USB cable



AV cable



External monitor
Yellow colour - Video
White colour - Voice
(see p.90)

Identification of features

Front & Top

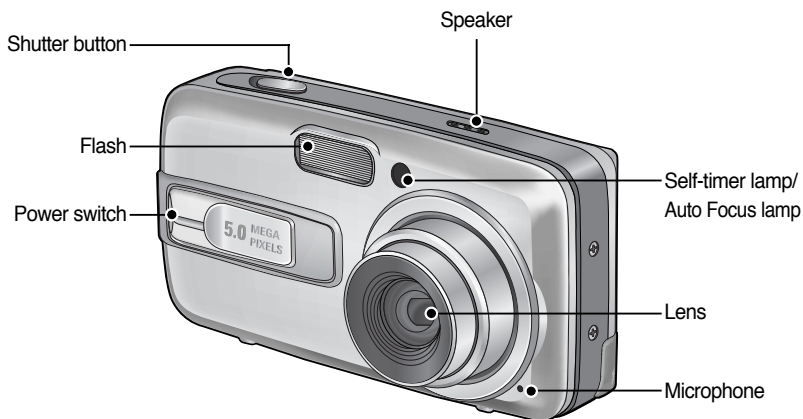

Back & Side

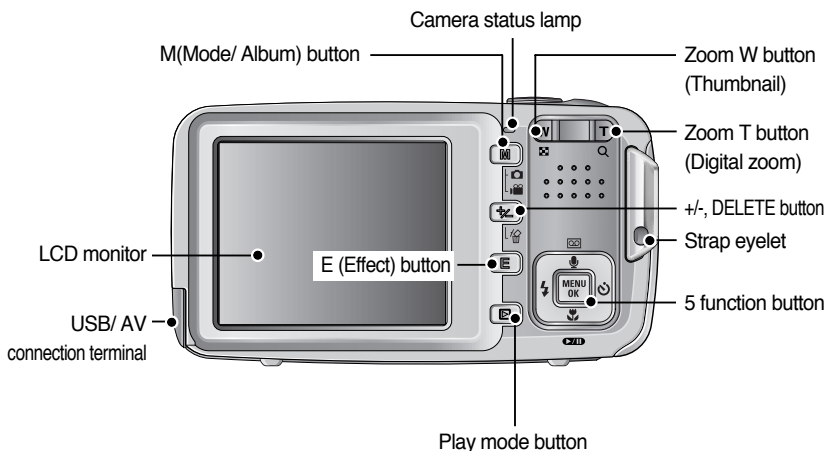

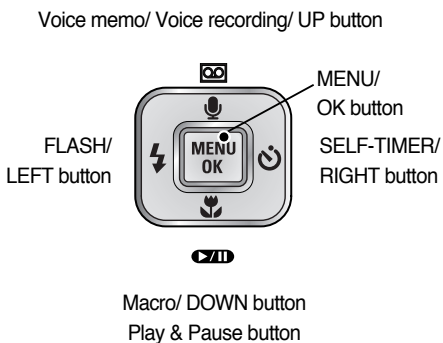
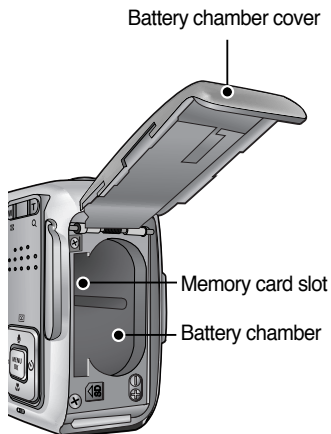

Identification of features

Side/ 5-function button



Identification of features















■ Self-timer lamp

Icon	Status	Description
	Blinking	For the 2 seconds, the lamp blinks quickly at 0.25-second intervals.
	Blinking	- For the first 7 seconds, the lamp blinks at 1 second intervals. - For the final 3 seconds, the lamp blinks quickly at 0.25-second intervals.
	Blinking	A picture will be taken after about 10 seconds and 2 seconds later a second picture will be taken.

■ Camera Status Lamp

Status	Description
Power on	The lamp turns on and off when the camera is ready to take a picture
After taking a picture	The lamp blinks while saving the image data and turns off when the camera is ready to take a picture
While movie recording	The lamp blinks
While voice recording	The lamp blinks
When the USB cable is inserted to a PC	The lamp lights up (LCD monitor turns off after initializing the device)
Transmitting Data with a PC	The lamp blinks (LCD monitor turns off)
When the USB cable is inserted to a printer	The lamp is off
When the printer is printing	The lamp blinks

■ Mode icon : Refer to page 51 for more information about the camera mode setting.

MODE	MOVIE CLIP	VOICE RECORDING	AUTO	PROGRAM	PLAY
ICON					
MODE	SCENE				
	NIGHT	PORTRAIT	CHILDREN	LANDSCAPE	CLOSE UP
ICON					
MODE	SUNSET	DAWN	BACKLIGHT	FIREWORKS	BEACH&SNOW
ICON					

Connecting to a Power Source

- You can use batteries only to provide the camera with power.
- We recommend using batteries for a digital camera (Within a year from the date of manufacture). The batteries are listed below.
 - Non rechargeable batteries : AA type - Alkaline
 - CR-V3 type - Lithium Ion battery
 - Rechargeable batteries : AA type - Ni-MH battery
(Samsung SNB-2312 recommended)
 - CR-V3 type - Lithium Ion battery
(Samsung SBP-1303 recommended)
- It is easy to buy alkaline batteries. However, the duration for using batteries varies in accordance with the battery manufacturer or the photographic conditions.

INFORMATION

Important information about battery usage

- When the camera is not used, turn off the camera power.
- Do not recharge the non rechargeable batteries. It may cause an explosion.
- Please remove the batteries if the camera will not be used for long periods.
Batteries can lose power over time and are prone to leaking if kept inside the camera.
- We recommend high capacity batteries (listed above) as manganese batteries cannot deliver sufficient power.
- Low temperatures (below 0°C) can affect the performance of the batteries and you may experience reduced battery life. Batteries will usually recover at normal temperatures.
- Do not use old and new batteries at the same time.
- During extended use of the camera, the camera body may become warm.
This is perfectly normal.

Connecting to a Power Source

Using the batteries

: If the camera does not turn on after you have inserted batteries, please check whether the batteries are inserted with the correct polarity (+/-).



1. Open the battery chamber cover by pushing in the direction of the arrow.

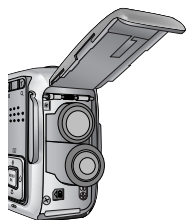

[Inserting the AA type battery]



2. Insert the batteries taking note of the polarity (+/-).



3. To close the battery chamber cover, push it until it clicks.

INFORMATION

- When the battery chamber cover is opened, do not press the battery chamber cover by force. This may cause the battery chamber cover modification or breakage.

- There are 4 indicators for battery condition that are displayed on the LCD monitor.

Battery indicator			
Battery status	The battery is fully charged	Prepare new battery	There is no battery capacity. Replace with new battery.

Instructions on how to use the memory card

- Be sure to format the memory card (see p.87) if you are using a newly purchased memory for the first time, if it contains data that the camera cannot recognise, or if it contains images captured with a different camera.
- Turn off the camera power whenever the memory card is being inserted or removed.
- Repeated use of the memory card will eventually reduce the memory card's performance. Should this be the case, you will need to purchase a new memory card. Wear and tear on the memory card is not covered by the Samsung warranty.
- The memory card is an electronic precision device.
Do not bend, drop or subject the memory card to any heavy impact.
- Do not store the memory card in an environment with strong electronic or magnetic fields, e.g. near loud speakers or TV receivers.
- Please do not use or store in an environment where there are extremes in temperature.
- Do not allow the memory card to become dirty or to come into contact with any liquid. Should this happen, clean the memory card with a soft cloth.
- Please keep the memory card in its case when not in use.
- During and after periods of extended use, you may notice that the memory card is warm. This is perfectly normal.
- Do not use a memory card that is used in another digital camera.
To use the memory card in this camera, format the memory card using this camera.
- Do not use a memory card formatted by another digital camera or memory card reader.
- If the memory card is subjected to any of the following, the recorded data may become corrupted :
 - When the memory card is used incorrectly.
 - If the power is switched off or the memory card is removed while recording, deleting (formatting) or reading.
- Samsung cannot be held responsible for lost data.
- It is advisable to copy important data onto other media as back-up e.g. floppy disks, hard disks, CD etc.
- If there is insufficient memory available
: A [CARD FULL!] message will appear and the camera will not operate. To optimise the amount of memory in the camera, replace the memory card or delete unnecessary images stored on the memory.

Instructions on how to use the memory card

INFORMATION

- Don't remove the memory card when the camera status lamp is blinking as this may cause damage to data in the memory card.

- The camera can use SD Memory Cards and MMC (Multi Media Cards). Please consult the enclosed manual for using the MMC Cards.

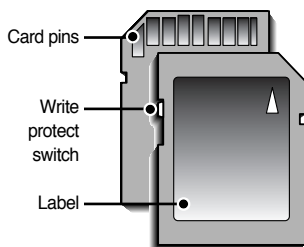

[SD (Secure Digital) memory card]

The SD memory card has a write protect switch that prevents image files from being deleted or formatted. By sliding the switch to the bottom of the SD memory card, the data will be protected. By sliding the switch to the top of the SD memory card, the data protection will be cancelled. Slide the switch to the top of the SD memory card before taking a picture.

- When using a 25MB memory, the specified shooting capacity will be as follows. These figures are approximate as image capacities can be affected by variables such as subject matter.

Recorded image size		S. FINE	FINE	NORMAL	30FPS	15FPS
Still image	5M(2592x1944)	9	18	26	-	-
	4M(2272x1704)	11	23	34	-	-
	3M(2048x1536)	14	28	41	-	-
	2M(1600x1200)	23	44	64	-	-
	1M(1024x768)	53	96	132	-	-
	VGA(640x480)	117	189	238	-	-
Movie clip	640(640X480)	-	-	-	About 1MIN	About 2MIN
	320(320X240)	-	-	-	About 2MIN	About 4MIN
	160(160X128)	-	-	-	About 4MIN	About 6MIN

Inserting the memory card

1. Slide the power switch to turn the power off. Open the battery chamber cover while pushing it in the direction of the arrow.



2. Have the front of the memory card facing toward the back of the camera (LCD monitor) and the card pins toward the front of the camera (lens), and then push the memory card into the card slot until you hear a click.



3. To close, push the battery chamber cover until you hear a click. If the memory card does not slide in smoothly, do not attempt to insert it by force. Check the direction of insertion, and then insert it correctly. Do not insert the memory card the wrong way round. Doing so may damage the memory card slot.



Removing the memory card

1. Slide the power switch to turn the power off. Open the battery chamber cover and press the memory card as shown in the image and release.

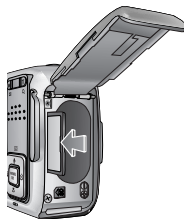

2. Remove the memory card and close the battery chamber cover.

LCD monitor indicator

■ The LCD monitor displays information about the shooting functions and selections.

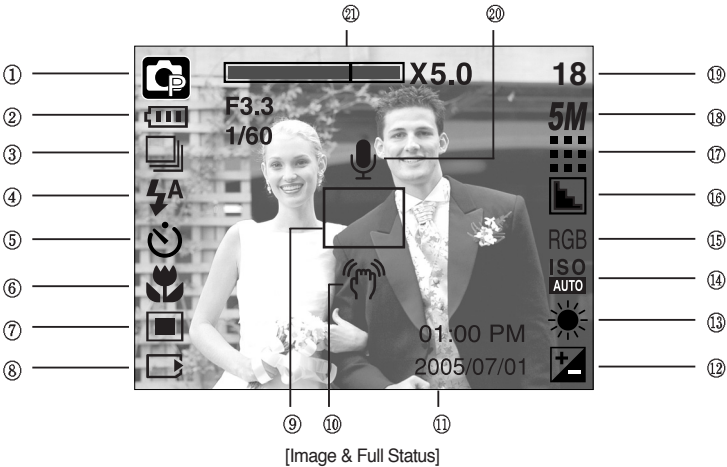

No.	Description	Icons	Page
1	Recording mode		p.51
2	Battery		p.14
3	Continuous shot		p.54
4	Flash		p.33
5	Self-timer		p.35
6	Macro		p.31
7	Metering		p.54
8	Card inserted indicator		-
9	Auto focus frame		-
10	Camera shake warning		-
11	Date/ Time	2005/07/01 01:00 PM	p.88
12	Exposure compensation		p.47
13	White Balance	AWB	p.46
14	ISO	ISO	p.46
15	RGB	RGB	p.45
16	Sharpness		p.55

LCD monitor indicator

17	Image quality		p.53
18	Image size	5M 4M 3M 2M 1M VGA 640 320 160	p.52
19	Number of available shots remaining	18	p.16
	Remaining time (Movie clip/ Voice recording)	00:01:30 / 01:00:00	p.16
20	Voice memo/ Mic. off		p.30/23
21	Optical/ Digital Zoom bar/ Digital Zoom rate	X5.0	p.27

Changing the recording mode

- You can select the desired working mode by the M (mode) button located on the back of the camera and [MODE], [MODE SET] menu. Auto, Program, movie clip, scene (night, portrait, children, landscape, close-up, sunset, dawn, backlight, fireworks, beach & snow) camera modes are available.
- Selecting the [MODE] menu
 1. Insert the battery (p.14).
 2. Insert the memory card (p.17). As this camera has a 25MB internal memory, you do not need to insert the memory card. If the memory card is not inserted, an image will be stored in the internal memory. If the memory card is inserted, an image will be stored on the memory card.
 3. Close the battery chamber cover.
 4. Slide the power switch to turn on the camera.
 5. Press the menu button and a menu will display.
 6. Use the Left/ Right button to select the [MODE] menu.
 7. Select [STILL & MOVIE], [FULL] or [CUSTOM] sub menu by pressing the UP/ DOWN button.
 - [STILL & MOVIE] : A still image mode that was selected on the [MODE SET] menu and movie clip mode can be selected. Refer to page 51 for more information about using the [MODE SET] menu.
 - [FULL] : Auto, Program, Movie clip and scene modes can be selected.
 - [CUSTOM] : Modes set as on in the [MODE SET] menu can be selected.
 8. Press the MENU button and the menu will disappear.

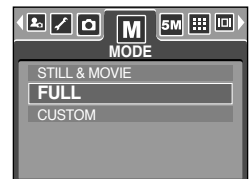

Changing the recording mode

- Changing the recording mode : If the [STILL & MOVIE] menu was selected
Steps from 1-4 are the same as those for selecting the [MODE] menu.
 5. The recording mode used just before will display.
 6. Press the M (Mode) button located on the back of the camera and the recording mode will change to the movie clip mode.
 7. Press the M (Mode) button again and a still image mode selected on the [MODE SET] menu will be selected.

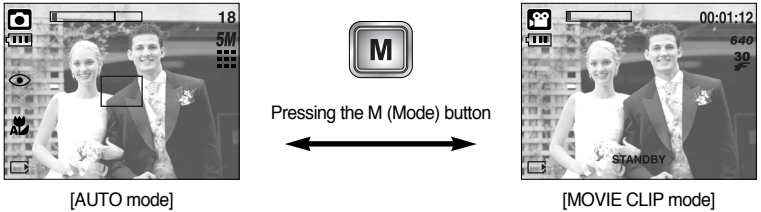

- Changing the recording mode : If the [FULL] menu was selected
Steps from 1-4 are the same as those for selecting the [MODE] menu.
 5. The recording mode used just before will display.
 6. Press the M (Mode) button located on the back of the camera and the mode selection menu will display.
 7. To select the Auto, Program, Movie clip or Scene modes, press the Left/ Right button.
To move between the Auto, Manual, Movie clip menu line and Scene menu line, press the Up/ Down button.

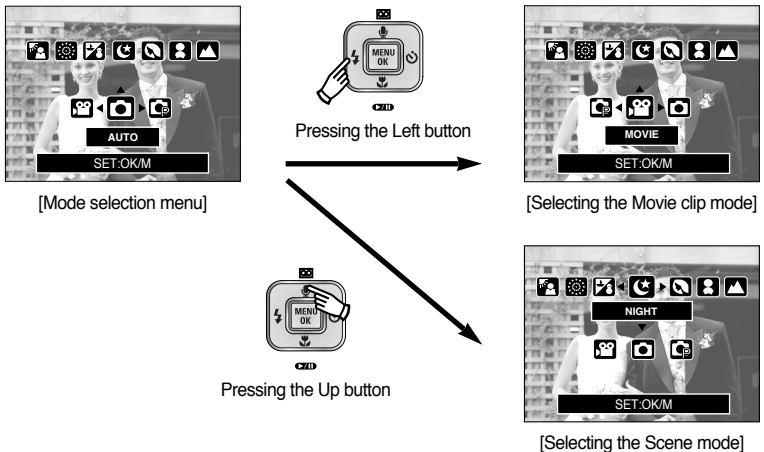

8. Press the M (Mode) button and the mode selection menu will disappear.

Changing the recording mode

- Changing the recording mode : If the [CUSTOM] menu was selected
Steps from 1-4 are the same as those for selecting the [MODE] menu.
- 5. The recording mode used just before will display.
- 6. Press the M (Mode) button located on the back of the camera and the mode selection menu will display.
- 7. You can select modes set as on in the [MODE SET] menu by pressing the Up/ Down/ Left/ Right buttons. Refer to page 51 for more information about using the [MODE SET] menu.

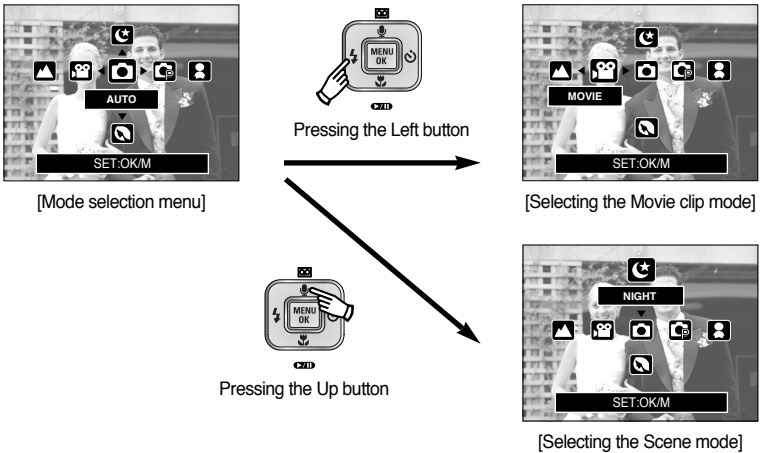

8. Press the M (Mode) button and the mode selection menu will disappear.

Starting the recording mode

■ How to use the Auto mode

Use this for shooting basic still images.

1. Select the [FULL] sub menu on the [MODE] menu (p.19).
2. Select the Auto mode by pressing the M (Mode) button (p.20).
3. Point the camera towards the subject and compose the image by using the LCD monitor.
4. Press the shutter button to capture an image.

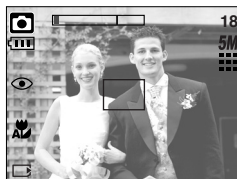

[AUTO mode]

INFORMATION

- If the auto focus frame turns to red when you press the shutter button down half way, it means that the camera cannot focus on the subject. Should this be the case, the camera is less likely to capture an image clearly.
- Avoid obstructing the lens or the flash when you capture an image.

■ How to use the Movie clip mode

A movie clip can be recorded for as long as the available recording time of the memory capacity allows.

1. Select the [FULL] sub menu on the [MODE] menu (p.19).
2. Select the Movie clip mode by pressing the M (Mode) button (p.20).
3. Point the camera towards the subject and compose the image by using the LCD monitor.
4. Press the shutter button once and movie clips are recorded for as long as the available recording time allows. Movie clips will still be recorded if the shutter button is released. If you wish to stop recording, press the shutter button again.

※ Image size and type are listed below.

- Image size : 640X480, 320X240, 160X128 (user selectable)
- Movie clip file type : AVI (MPEG-4)



[MOVIE CLIP mode]

Starting the recording mode

■ Recording the movie clip without voice

You can record the movie clip without voice.

Steps from 1-3 are the same as those for MOVIE CLIP mode.

4. Press the Up button and the () icon will display on the LCD monitor.
5. Press the shutter button and movie clip is recorded for as long as the available recording time without voice.
6. To stop the recording, press the shutter button again.





■ Pausing while recording a movie clip (Successive Recording)

This camera allows you to temporarily stop during unwanted scenes, while recording a movie clip. Using this function, you can record your favourite scenes into a movie clip without having to create multiple movie clips.

● Using Successive Recording

Steps from 1-2 are the same as those for MOVIE CLIP mode.

3. Point the camera towards the subject and compose the image by using the LCD monitor. Press the shutter button and movie clips are recorded for as long as the available recording time. Movie clips will still be recorded if the shutter button is released.
4. Press the Pause button() to pause recording.
5. Press the Pause button() again to resume the recording.
6. If you wish to stop recording, press the shutter button again.



[Successive recording of a movie clip]

■ How to use the Program mode

Selecting the automatic mode will configure the camera with optimal settings and you can manually configure various functions.

1. Select the [FULL] sub menu on the [MODE] menu (p.19).
2. Select the Program mode by pressing the M (Mode) button (p.20).
3. Point the camera towards the subject and compose the image by using the LCD monitor.
4. Press the shutter button to capture an image.



[PROGRAM mode]

Starting the recording mode

■ How to use the Scene modes

Use the menu to easily configure optimal settings for a variety of shooting situations.

1. Select the [FULL] sub menu on the [MODE] menu (p.19).
2. Select the Scene mode by pressing the M (Mode) button (p.20).
3. Point the camera towards the subject and compose the image by using the LCD monitor.
4. Press the shutter button to capture an image.

※ The scene modes are listed below.

[NIGHT]() : Use this for shooting still images at night or in other dark conditions.

[PORTRAIT]() : To take a picture of a person.

[CHILDREN]() : To take a picture of fast moving objects, for example, children.

[LANDSCAPE]() : To take pictures of distant scenery.

[CLOSE UP]() : Close-up shooting for small objects such as plants and insects.

[SUNSET]() : For taking pictures of sunsets.

[DAWN]() : Daybreak scenes.

[BACKLIGHT]() : Portrait without shadows caused by backlight.

[FIREWORKS]() : Firework scenes.

[BEACH&SNOW]() : For ocean, lake, beach and snowscape scenes.

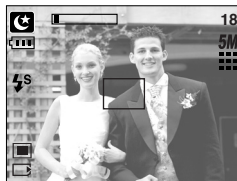

[SCENE mode]

Starting the recording mode

■ How to use the VOICE RECORDING mode

A voice recording can be recorded for as long as the available recording time of the memory capacity allows. (Max: 1 hour)



1. In any mode with the exception of the Movie clip, select the VOICE RECORDING mode by pressing the Voice recording button twice.
2. Press the shutter button to record a voice.
 - Press the shutter button once and voice is recorded for as long as the available recording time (Max : 1 hour) allows. The recording time will be displayed on the LCD monitor. Voice will still be recorded if the shutter button is released.
 - If you wish to stop recording, press the shutter button again.
 - File type : WAV



[VOICE RECORDING mode]

● Pausing while recording a voice recording

This camera allows you to temporarily stop during unwanted recording, while recording a voice. Using this function, you can record your favorite voices into a voice recording file without having to create multiple voice recording files.

1. Press the shutter button and voice is recorded for as long as the available recording time. Voice will still be recorded if the shutter button is released.
2. Press the Pause button() to pause recording.
3. Press the Pause button() again to resume the recording.
4. If you wish to stop recording, press the shutter button again.



[Pausing the voice recording]

INFORMATION

- A distance of 40cm between you and the camera (microphone) is the best distance to record sound.
- If the camera power is turned off while the voice recording is paused, the voice recording is cancelled.

Things to Watch Out for When Taking Pictures

- Pressing the shutter button down half way
Lightly press the shutter button to confirm focus and flash battery charge.
Press the shutter button all way down to take the picture.

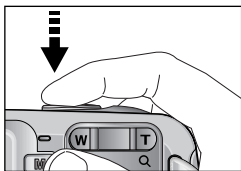

[Lightly press the shutter button]

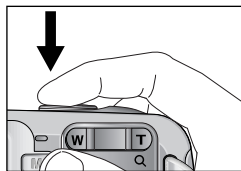

[Press the shutter button]

- The available recording time may vary depending on shooting conditions and camera settings.
- When the Flash Off or Slow synchro mode is selected in a low lighting condition, the camera shake warning indicator () may appear on the LCD monitor. In this case, use a tripod, support the camera on a solid surface or change the flash mode to flash shot mode.
- Backlight compensated shots : When taking an outdoor shot, avoid facing the sun, as the image may be dark because of the strong backlight.
To take a picture against the sun, please use the [BACKLIGHT] in the scene shooting mode (see page 24), Fill-in flash (see page 33), Spot metering (see page 54), or Exposure compensation (see page 47).
- Avoid obstructing the lens or the flash when you capture an image.
- Under certain conditions the auto focus system may not perform as expected.
 - When photographing a subject that has little contrast.
 - If the subject is highly reflective or shiny.
 - If the subject is moving at high speed.
 - When there is strong reflected light, or when the background is very bright.
 - When the subject matter has only horizontal lines or the subject is very narrow (such as a stick or flagpole).
 - When the surroundings are dark

Using the camera buttons to adjust the camera

- The recording mode function can be set up by using the camera buttons.

Power switch

- Used for turning the camera's power on/ off.
- If there is no operation during the specified time, the camera's power will be turned off automatically to save battery life. Refer to page 86 for more information about the auto power off function.

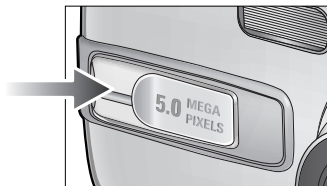

SHUTTER button

- Used for taking an image or recording voice in the recording mode.
- In MOVIE CLIP mode
Pressing the shutter button down fully starts the process for recording a movie clip. Press the shutter button once and the movie clip is recorded for as long as the available recording time in the memory allows. If you wish to stop recording, press the shutter button again.

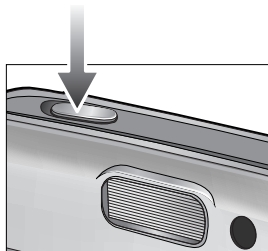

- In STILL IMAGE mode

Pressing the shutter button down halfway activates the autofocus and checks the condition of the flash.

Pressing the shutter down fully takes the image and stores the relevant data regarding the shot. If you select voice memo recording, the recording will start after the camera has finished storing the image data.

ZOOM W/ T button

- If the menu is not displayed, this button works as the OPTICAL ZOOM or DIGITAL ZOOM button.



ZOOM W/ T button

- This camera has a 4.8X optical zoom and a 5X digital zoom function. Using both will offer a total zoom ratio of 24X. The illustrated images are for your information. The zoom scale can be varied depending on the subject matter.

● TELE Zoom

Optical zoom TELE : Pressing the ZOOM T button. This will zoom into the subject i.e. the subject will appear nearer.

Digital zoom TELE : When the maximum (4.8X) optical zoom is selected, pressing the ZOOM T button activates the digital zoom software. Releasing ZOOM T button stops the digital zoom at the required setting. Once the maximum digital zoom (5X) is achieved, pressing the ZOOM T button will have no effect.

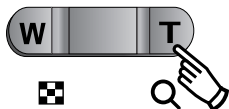

● WIDE Zoom

Optical zoom WIDE : Pressing the ZOOM W button. This will zoom out from the subject i.e. the subject will appear further away. Pressing the ZOOM W button continuously will set the camera to its minimum zoom setting i.e. the subject appears at its furthest from the camera.

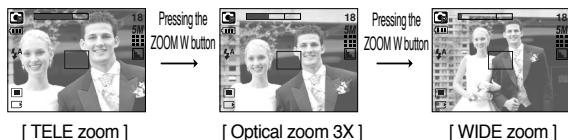
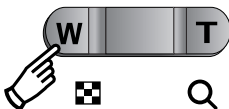

Digital zoom WIDE : When the digital zoom is in operation, pressing the ZOOM W button will reduce the digital zooming in steps.

Releasing ZOOM W button stops digital zooming.

Pressing the ZOOM W button will reduce the optical zoom and then it will continue to reduce the optical zoom until the minimum setting is reached.

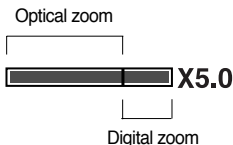

ZOOM W/ T button

INFORMATION

- Images taken using the digital zoom may take a little longer for the camera to process. Allow time for this to take place.
- You may notice a decrease in image quality when using the digital zoom.
- To view more clear digital zoom image, press the shutter button halfway at the maximum (4.8X) optical zoom position and press the zoom T button again.
- The digital zoom can't be activated in the [NIGHT], [CHILDREN], [CLOSE UP] and [FIREWORKS] scene modes.
- The zoom function can't be activated during the movie clip recording.
- The digital zoom cannot be used in movie clip shots.
- Take care not to press the lens, lens cover and camera by force. This may cause the camera malfunction.

Voice recording()/ Voice memo()/ UP button

- While the menu is showing, press the UP button to move up the submenu cursor.
When the menu is not displayed on the LCD monitor, the UP button operates as the voice recording or voice memo button. You can record your voice or add your voice-over to a stored still image. Refer to page 25 for more information about the voice recording.

● Recording a voice memo

1. Press the M (Mode) button to select a Recording mode with the exception of Movie clip mode.
2. Press the Voice memo () button. If the voice memo indicator is displayed on the LCD monitor, the setting is completed.



Pressing the Voice memo button

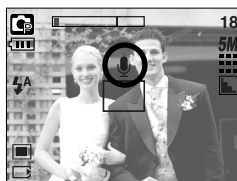

3. Press the shutter button and take a picture.
The picture is stored on the memory.
4. Voice memo will be recorded for ten seconds from the moment the picture is stored. In the middle of the voice recording, pressing the shutter button will stop the voice memo.

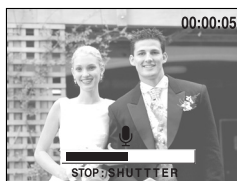

[Recording Voice Memo]

INFORMATION

- A distance of 40cm between you and the camera (microphone) is the best distance to record sound.

Macro () / Down button

- While the menu is showing, press the DOWN button to move from the main menu to a submenu, or to move down the submenu cursor. When the menu is not showing, you can use the MACRO/ DOWN button to take macro pictures. The distance ranges are shown below. Press the Macro button until the desired macro mode indicator displays on the LCD monitor.



[Auto focus - No icon]







[Macro ()]



[Auto macro ()]

- Types of focus modes and focus ranges (W: Wide, T: Tele)

(Unit : cm)

Mode	Auto ()		Program ()	
	Focus Type	Auto macro ()	Normal	Macro ()
Focus range	W : 5~Infinity T : 19~Infinity	W : 60~Infinity T : 60~Infinity	W : 2~60 T : 19~60	W : 60~Infinity T : 60~Infinity













- ※ See the next page for the available focusing method, by recording mode.

INFORMATION

- When the macro mode is selected, it is possible that camera shake will occur. Take care not to shake the camera.
- When you take a picture within 30cm in the Macro mode, select the FLASH OFF mode.

Macro()/ Down button

■ Available focusing method, by recording mode (O: Selectable , X: Not selectable, ∞: Infinity focus range)

Mode										
Normal	O	O	O							
Macro	O	X	O							
Auto macro	X	O	X							
Mode	SCENE									
										
Normal	O	O	O	∞	X	∞	∞	O	∞	O
Macro	X	X	X	X	O	X	X	X	X	X
Auto macro	X	X	X	X	X	X	X	X	X	X

Focus lock

■ To focus on the subject positioned outside of the centre, use the focus lock function.

● Using the Focus Lock

1. Ensure the subject is in the centre of the autofocus frame.
2. Press the SHUTTER button halfway. When the green auto focus frame lights up, it means the camera is focused on the subject. Be careful not to press the SHUTTER button all the way down to avoid taking an unwanted picture.
3. With the SHUTTER button still pressed down only halfway, move the camera to recompose your picture as desired, and then press the SHUTTER button completely to take the picture. If you release your finger from the SHUTTER button, the focus lock function will be cancelled.



1. The image to be captured.

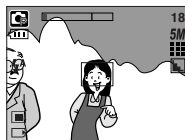

2. Press the SHUTTER button halfway and focus on the subject.



3. Recompose the picture and fully depress the SHUTTER button.

Flash ()/ Left button

- When the menu is displayed on the LCD monitor, pressing the LEFT button makes the cursor shift to the left tab.
- When the menu is not displayed on the LCD monitor, the LEFT button operates as the FLASH () button.
- Selecting the flash mode
 1. Press the M (Mode) button to select a Recording mode with the exception of Movie clip mode (p.20).
 2. Press the Flash button until the desired flash mode indicator displays on the LCD monitor.
 3. A flash mode indicator will be displayed on the LCD monitor. Use the correct flash to suit the environment.

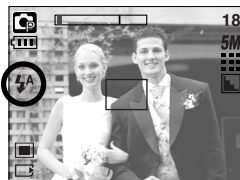

[Selecting the Auto flash]

● Flash range

(Unit : m)







ISO	Normal		Macro		Auto macro	
	WIDE	TELE	WIDE	TELE	WIDE	TELE
AUTO	0.6~3.0	0.6~2.0	0.25~0.6	0.5~0.6	0.25~3.0	0.5~2.0

INFORMATION



















- If you press the shutter button after selecting the Auto, Fill-in, Slow sychro flash, the first flash fires to check the shooting condition (Flash range and Power ratio of flash). Do not move until the second flash fires.
- Using the flash frequently will reduce the life of the battery.
- Under normal operating conditions the charging time for the flash is normally within 5 seconds. If the battery is weak, the charging time will be longer.
- During the continuous shot, AEB and movie clip mode, the flash function will not operate.
- Take photographs within the flash range.
- The image quality is not guaranteed if the subject is too close or highly reflective.

Flash ()/ Left button

● Flash mode indicator

Menu tab	Flash mode	Description
	Auto flash	If the subject or background is dark, the camera flash will operate automatically.
	Auto & Red eye reduction	If a subject or background is dark, the camera flash will work automatically and will reduce the red-eye effect by using the red-eye reduction function.
	Fill in flash	The flash fires regardless of available light. The intensity of the flash will be controlled, according to the prevailing conditions. The brighter the background or subject is, the less intense the flash will be.
	Slow synchro	The flash will operate in conjunction with a slow shutter speed in order to obtain the correct exposure. When you take an image in a condition with poor light, the camera shake warning indicator () will display on the LCD monitor. We recommend using a tripod for this function.
	Flash off	The flash does not fire. Select this mode when capturing images in a place or situation where flash photography is prohibited. When you capture an image in a poorly lit condition, the camera shake warning indicator () will display on the LCD monitor. We recommend using a tripod for this function.

● Available flash mode, by recording mode

													
	X	X	O	X	X	X	X	X	X	X	X	X	O
	X	O	O	X	O	O	X	X	X	X	X	X	X
	X	X	O	X	X	X	X	X	X	X	O	X	X
	X	X	O	O	X	X	X	X	X	X	X	X	X
	O	O	O	O	O	O	O	O	O	O	X	O	X

Self-timer (⌚) / Right button

■ When the menu is displayed on the LCD monitor, pressing the Right button makes the cursor shift to the right tab. The right button can also be used to move to a sub menu to select a different setting. When the menu is not displayed on the LCD monitor, the Right button operates as the Self-timer. This function is used when the photographer would also like to be in the image.

● Using the self-timer

1. Press the M (Mode) button to select a still image mode or movie clip mode (p.20).

2. Press the Self-timer button until the desired mode indicator displays on the LCD monitor.

In Movie clip mode, only the 10 Sec. self-timer can be used.

- 2 Sec. Self-timer (⌚^{2S}) : Pressing the shutter button will allow an interval of 2 seconds before the image is taken.

- 10 Sec. Self-timer (⌚) : Pressing the shutter button will allow an interval of 10 seconds before the image is taken.

- Double Self-timer (⌚^o) : A picture will be taken after about 10 seconds and 2 seconds later a second picture will be taken. When using the flash, the 2-second self-timer may be delayed for longer than 2 seconds depending on the flash charge time.

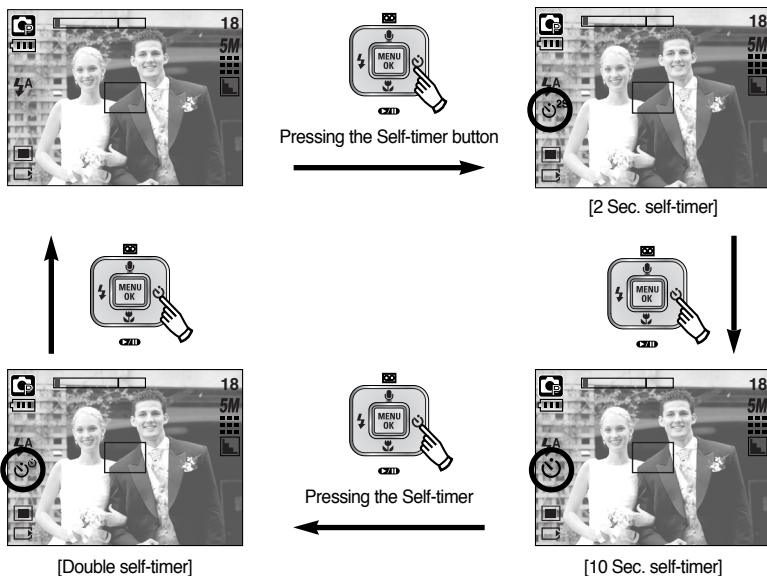

3. When you press the Shutter button, the picture will be taken after the specified time has elapsed.

※ If you operate the Power switch, Self-timer button and Shutter button during the self-timer operation, the self-timer function is cancelled.

MENU/ OK button

■ MENU button

- When you press the MENU button, a menu related to each camera mode will be displayed on the LCD monitor. Pressing it again will return the LCD to the initial display.
- A menu option can be displayed when the following are selected :
MOVIE CLIP and STILL IMAGE mode. There is no menu available when the VOICE RECORDING mode is selected.

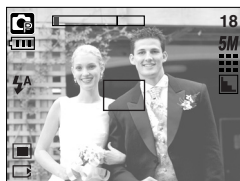

[Menu off]



Pressing the MENU button



[Menu on]

■ OK button

- When the menu is displayed on the LCD monitor, this button is used for shifting the cursor to the sub menu or for confirming data.

M (Mode) button

- You can select the desired recording mode. The selectable recording modes are different from what you selected sub menu in the [MODE] menu.

- [STILL & MOVIE] : A recording mode selected in the [MODE SET] menu, Movie clip mode
- [FULL] : Auto, Movie clip, Program, Scene modes
- [CUSTOM] : Modes set as on in the [MODE SET] menu

- How to use the mode button : In case of [STILL & MOVIE] and [AUTO] sub menu



[Auto mode]



Pressing the M button



[Movie clip mode]

M (Mode) button

- How to use the mode button : In case of [FULL] sub menu and Auto mode



[Auto mode]



Pressing the Mode button



[Mode selection menu]



Pressing the Up button



[Scene mode]



Pressing the Right button



[Program mode]



Pressing the Left button



[Movie clip mode]



Pressing the Left/Right button

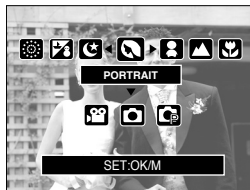

[Selecting a scene mode]

※ Press the Mode button and the mode selection menu will disappear.

M (Mode) button

- How to use the mode button : In case of [CUSTOM] sub menu and Auto mode



[Auto mode]



Pressing the Mode button



[Mode selection menu]



Pressing the Right button

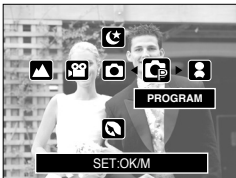

[Program mode]

- ※ The illustrated images and modes are for your information.
They can be changed as the [MODE SET] menu setting.



Pressing the Up button

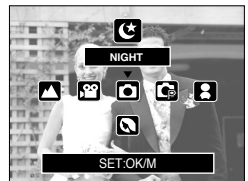

[Night scene mode]



Pressing the Down button

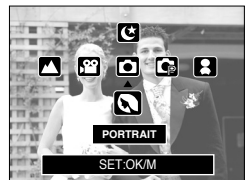













[Portrait scene mode]

- ※ Press the Mode button and the mode selection menu will disappear.

E (Effect) button

- It is possible to add special effects to your images by using this button
- Still image mode : You can select the colour, focus, composite and frame menus.
Movie clip mode : You can select the colour and stabilizer menus.
- Available Effects, by recording mode (O : Selectable X : Not selectable)

							
	O	O	O	O	O	O	O
	X	X	O	X	X	X	X
	X	X	O	X	X	X	X
	X	X	O	X	X	X	X
	O	X	X	X	X	X	X

- ※ This button will not operate in the Voice recording mode and some scene modes (Night, Sunset, Dawn, Backlight, Fireworks and Beach & Snow)
If a special effect is selected, the rest special effect functions set before are cancelled automatically.
- Even if the camera is turned off, the special effect setting will be preserved.
To cancel the special effect, select the **OFF** sub menu of each menu.

Special Effect : Colour

- By using the camera's digital processor, it is possible to add special effects to your images
 1. Press the E button in the still image mode or Movie clip mode.
 2. Select the COLOR menu by pressing the Left/ Right button.



[Still image mode]

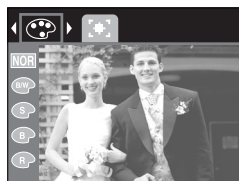

[Movie clip mode]

Special Effect : Colour

3. Select a desired sub menu by pressing the Up/Down button and press the OK button.

NOR : No effect is added to the image

B/W : Captured images will be stored in black and white.

S : Captured images will be stored in a sepia tone (a gradient of yellowish brown colours).

R : Captured images will be stored in a red tone.

G : Captured images will be stored in a green tone.

B : Captured images will be stored in a blue tone.

N : Save the image in negative mode.

4. Press the shutter button to capture an image.

Special Effect : Preset focus frames

■ You can make the subject stand out from its surroundings.
The subject will be sharp and in focus while making the rest out of focus.

1. Press the E button in the program mode.
2. Select the FOCUS menu by pressing the Left/ Right button.
3. Select a desired sub menu by pressing the Up/ Down button and press the OK button.



[Range 1]



[Range 2]



[Range 3]



[Range 4]

4. The preset focus frame will appear.
Press the shutter button to capture an image







Special Effect : Composite shooting

- You can combine 2 ~ 4 different shots in a still image.

1. Press the E button in the program mode.
2. Select the COMPOSITE menu by pressing the Left/ Right button.
3. Select a desired sub menu by pressing the Up/ Down button and press the OK button.



- **OFF** : cancels the composite shooting
-  : 2 different shots are combined in a still image.
-  : 3 different shots are combined in a still image.
-  : 4 different shots are combined in a still image.
-  : 2 different panorama shots are combined in a still image.

4. The number of frames you selected in step 3 is displayed on the LCD monitor.
Press the shutter button to start the composite shooting

※ Selecting 2 composite shooting

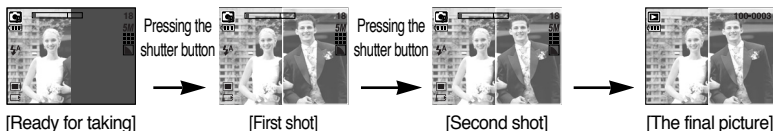

5. After taking the last shot, the image will be saved.

- ※ You can use the flash button, self-timer button, macro button, voice memo button and the Zoom W/T button during the composite shooting.
- ※ If you press the camera buttons (Play mode button, M button and Menu button) during the composite shots, each mode of the camera buttons is executed. The images captured before will be deleted.
- ※ The voice memo will start after taking the last composite shooting.

Special Effect : Composite shooting

- Changing a part of composite shot before taking the last shot

Before taking the last composite shot, you can change a part of composite shot.

1. During the composite shots, press the +/- button.
2. A previous image will be deleted and new frame will display.

If there is an image taken before, press the +/- button again and a previous image will be deleted again.



[Before taking the 3rd shot]



Pressing the +/- button



[Moving backward to the 2nd shot]

3. Press the shutter button to capture a new image.

Special Effect : Photo Frame

■ You can add 9 types of frame-like borders to a still image you want to capture.

1. Press the E button in the program mode.
2. Select the FRAME menu by pressing the Left/ Right button.
3. Select a desired sub menu by pressing the Up/ Down button and press the OK button.

- **OFF** : The photo frame will not be added.

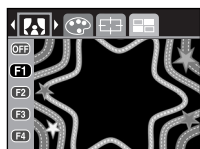

F1

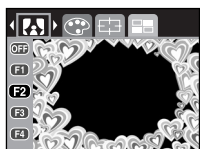

F2



F3

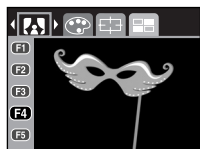

F4



F5



F6



F7



F8



F9

4. The photo frame will appear.
Press the shutter button to capture an image



Movie Clip frame stabiliser

- This function helps stabilize images captured during movie recording.
You can select this menu only in the MOVIE CLIP mode.
If the memory card is not inserted, this function will not operate.

- How to use this function

1. Press the E button in the Movie clip mode.
2. Select the STABILIZER menu by pressing the Left/ Right button.
3. Select a desired sub menu by pressing the Up/ Down button and press the OK button.

- **OFF** : Movie clip frame stabilizer function becomes disabled.
- **ON** : Prevents camera shake during movie recording.
The recording frame range will become narrower than when you select the **OFF** menu. Pre-view frames may not display smoothly on the LCD monitor.









INFORMATION

- When you select the **ON** sub menu, the movie clip frame range will be narrow depending on the movie clip size.

+/- button

- You can use the +/- button to adjust the values for the RGB, ISO, white balance and exposure compensation.

Main menu	Sub menu	Available camera mode
RGB	R (Red), G (Green), B (Blue)	
ISO	AUTO, 100, 200, 400	
WHITE BALANCE	AUTO, DAYLIGHT, CLOUDY, FLUORESCENT H, FLUORESCENT L, TUNGSTEN, CUSTOM.	 
Exposure compensation	-2.0 ~ 0.0 ~ +2.0 (0.5EV steps)	 

- RGB : Allows the user to adjust the R (Red), G (Green), and B (Blue) values of the images to be captured.

- Setting RGB Values

1. Press the +/- button, and then use the UP and DOWN buttons to select the RGB icon ().
The RGB menu bar will appear as shown.
2. Use the UP/ DOWN/ LEFT and RIGHT buttons to select the desired RGB value.
 - Up/ Down Button : Navigates between R, G, and B icons.
 - Left/ Right Button : Changes value of each icon.
3. When you press the +/- button again, the value you set will be saved and RGB setup mode will end.

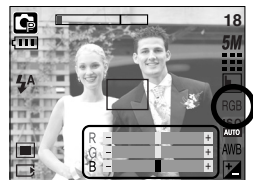

+/- button

- ISO : You can select the ISO sensitivity when taking pictures.

The speed or specific light-sensitivity of a camera is rated by ISO numbers.

- Selecting an ISO Sensitivity

1. Press the +/- button, and then use the UP and DOWN buttons to select the ISO icon ().

The ISO menu bar will appear as shown.

2. Use the LEFT and RIGHT buttons to select the desired ISO sensitivity value.

- AUTO : The camera's sensitivity is automatically changed by variables such as lighting value or subject brightness.

-100, 200, 400 : You can increase the shutter speed while the same amount of light is present, by increasing the ISO sensitivity. However, the image may be saturated in high luminance. The higher the ISO value, the higher the camera's sensitivity to light is and therefore the greater its capacity to take pictures in dark conditions. However, the noise level in the image will increase as the ISO value increases, making the image appear coarse.

3. When you press the +/- button again, the value you set will be saved and ISO setup mode will end.

- White balance : The white balance control allows you to adjust the colours to appear more natural looking.

- Selecting a White Balance

1. Press the +/- button, and then use the UP and DOWN buttons to select the white balance icon ().

The white balance menu bar will appear as shown.

2. Use the LEFT and RIGHT buttons to set the white balance to the desired value. The value you set will be displayed on the LCD monitor.

AUTO  : The camera automatically selects the appropriate white balance settings, depending on the prevailing lighting conditions.

DAYLIGHT  : For taking images outside.

CLOUDY  : For taking images under a cloudy and overcast sky.

Fluorescent H  : For shooting under daylight fluorescent types of three-way fluorescent lighting.

Fluorescent L  : Shooting under white fluorescent lighting.

TUNGSTEN  : For shooting under tungsten (standard light bulb) lighting.

CUSTOM  : Allows the user to set the white balance according to the shooting condition.

Different lighting conditions may cause a colour cast on your images.

3. Press the +/- button again. The value you set will be saved and White Balance setup mode will end.

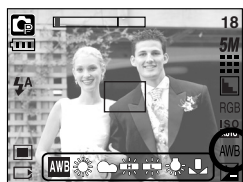

+/- button

● Using the Custom White Balance

White balance settings may vary slightly depending on the shooting environment.

You can select the most appropriate white balance setting for a given shooting environment by setting up the custom white balance.

1. Select the CUSTOM () menu of the White Balance and press the OK button.
2. Place a sheet of white paper in front of the camera so that the LCD monitor shows only white, and then press the SHUTTER button.
3. Press the OK button and your custom white balance value is stored.
 - The custom white balance value will be applied, starting with the next picture you take.
 - The user configured white balance will remain effective until it is overwritten.

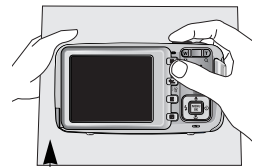
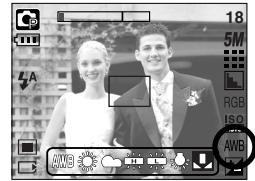



[White paper]

- Exposure compensation : This camera automatically adjusts the exposure according to the ambient lighting conditions.

You can also select the exposure value by using the +/- button.

● Compensating Exposure

1. Press the +/- button, and then use the UP and DOWN buttons to select the exposure compensation icon (). The exposure compensation menu bar will appear as shown.
 2. Use the LEFT and RIGHT buttons to set the desired exposure compensation factor.
 3. Press the +/- button again. The value you set will be saved and the Exposure Compensation setup mode will close. If you change the exposure value, the exposure indicator () will be displayed on the bottom of the LCD monitor.
- ※ A negative exposure compensation value reduces the exposure.
Note that a positive exposure compensation value increases the exposure and the LCD monitor will appear white or you may not get good pictures.

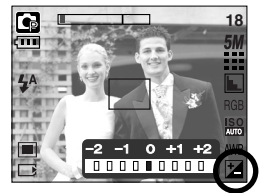











Using the LCD monitor to adjust the camera settings

- You can use the menu on the LCD monitor to set up recording functions. In any mode with the exception of VOICE RECORDING mode, pressing the MENU button displays the menu on the LCD monitor.











INFORMATION

- The menu will not be displayed on the LCD monitor in the following circumstances:
 - When another button is being operated.
 - While image data is being processed.
 - When there is no battery capacity.

- The following functions are available, depending on the mode you have selected. The items indicated by are default settings.

Menu tab	Main menu	Sub menu		Camera working mode	Page
	MODE	STILL&MOVIE			p.50
		FULL			
		CUSTOM			
	MODE SET	AUTO	PROGRAM		p.51
		MOVIE	NIGHT		
		PORTRAIT	CHILDREN		
		LANDSCAPE	CLOSE UP		
		SUNSET	DAWN		
		BACKLIGHT	FIREWORKS		
		BEACH&SNOW	-		
	SIZE (Still image)	2592X1944	2272X1704		p.52
		2048X1536	1600X1200		
		1024X768	640X480		
	SIZE (Movie clip)	640X480	320X240		p.52
		160X128	-		
	QUALITY	S.FINE	FINE		p.53
		NORMAL	-		

Using the LCD monitor to adjust the camera settings

Menu tab	Main menu	Sub menu		Camera working mode	Page
	FRAME RATE	30 FPS	15 FPS		p.53
	METERING	MULTI	SPOT		p.54
	SHOOTING	SINGLE	CONTINUOUS		p.54
		AEB	-		
	SHARPNESS	SOFT	NORMAL		p.55
		VIVID	-		
	OSD INFORMATION	FULL OSD	BASIC OSD		p.55
		SAVE MODE	-		

※ Menus are subject to change without prior notice.

How to use the menu

1. Turn on the camera and press the MENU button. A menu for each camera mode appears. However, there is no menu for Voice Recording mode ().
2. Use the LEFT and RIGHT buttons to navigate through the menus.



3. Use the UP and DOWN buttons to select a sub menu.

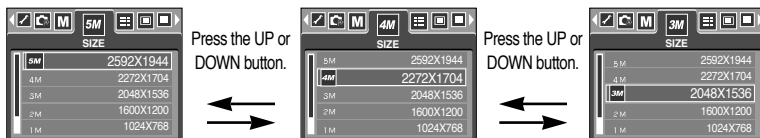

4. Select a sub menu, and then the value you set will be saved. Press the MENU button and the menu will disappear.

Mode

- You can select the desired working mode by the M (Mode) button located on the back of the camera and [MODE] menu. Auto, Program, Movie clip, Scene (night, portrait, children, landscape, close-up, sunset, dawn, backlight, fireworks, beach & snow) camera modes are available.
- [STILL & MOVIE] : A still image mode that was selected on the [MODE SET] menu and movie clip mode can be selected.
- [FULL] : Auto, Program, Movie clip and scene modes can be selected.
- [CUSTOM] : You can select modes set as on in the [MODE SET] menu

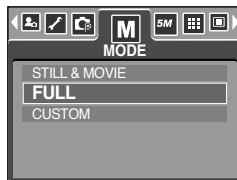

MODE SET

- You can select the desired recording mode.
- If you select the [CUSTOM] sub menu in the [MODE SET] menu, you can select modes set as on in this menu by pressing the M button.
 - The maximum custom modes you can select are 7 and the minimum custom modes are 3.
 - If you select over 7 custom modes, the menus are set as off automatically from the lower placed sub menu.

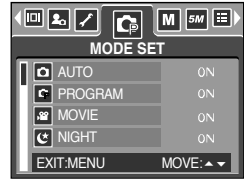

- [AUTO] : For shooting basic still image
- [PROGRAM] : You can manually configure all functions.
- [MOVIE] : For taking a movie clip
- [NIGHT] : Use this for shooting still images at night or in other dark conditions.
- [PORTRAIT] : To take a picture of a person.
- [CHILDREN] : To take a still picture of moving children.
- [LANDSCAPE] : Scenery with green woods or blue sky.
- [CLOSE UP] : Close-up shooting for small objects such as plants and insects.
- [SUNSET] : For taking pictures of sunsets.
- [DAWN] : Daybreak scenes.
- [BACKLIGHT] : Portrait without shadows caused by backlight.
- [FIREWORKS] : Firework scenes.
- [BEACH&SNOW] : For ocean, lake, beach and snowscape scenes.

INFORMATION

- When [NIGHT], [LANDSCAPE], [CLOSE UP], [SUNSET], [DAWN] and [FIREWORKS] scene mode are selected, it is possible that camera shake will occur. In this case, you should use a tripod.

Size

- You can select the image size appropriate for your application.

Mode	STILL IMAGE mode						MOVIE CLIP mode		
Icon	5M	4M	3M	2M	1M	VGA	640	320	160
Size	2592X1944	2272X1704	2048X1536	1600X1200	1024X768	640X480	640X480	320X240	160X128

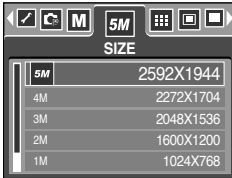

[STILL IMAGE mode]

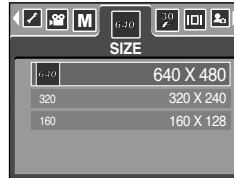





[MOVIE CLIP mode]

INFORMATION

- The higher the resolution, the lower the number of available shots will be because high resolution images require more memory than lower resolution images.

Quality/ Frame rate

- You can select the compression ratio appropriate for your application of the captured images. The higher the compression ratio, the lower the picture quality.

Mode	STILL IMAGE mode			MOVIE CLIP mode	
Icon					
Sub menu	S.FINE	FINE	NORMAL	30FPS	15FPS
File Format	jpeg	jpeg	jpeg	avi	avi

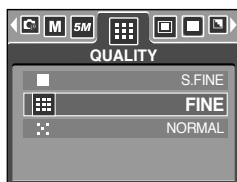

[STILL IMAGE mode]

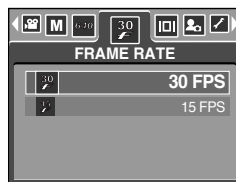

[MOVIE CLIP mode]

INFORMATION

- S.FINE is the highest quality and NORMAL is the lowest setting. Choose the setting appropriate for your needs.
- This file format complies with the DCF(Design rule for Camera File system).
- JPEG (Joint Photographic Experts Group) :
JPEG is the image compression standard developed by the Joint Photographic Experts Group. This type of compression is most commonly used for compressing photos and graphics because it can compress the files efficiently without damaging the data.

Metering

- If you cannot obtain suitable exposure conditions, you can change the metering method to take brighter pictures.

[MULTI] () : Exposure will be calculated based on an average of the available light in the image area. However, the calculation will be biased towards the centre of the image area. This is suitable for general use.

[SPOT] () : Only the rectangular area in the centre of the LCD monitor will be metered for light. This is suitable when the subject in the centre is exposed correctly, regardless of the back lighting.

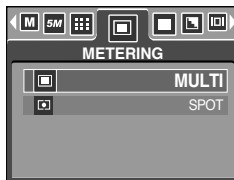

[PROGRAM mode]

INFORMATION

- The default metering mode is Multi pattern metering.
- If the subject is not the centre of the focus area, do not use the spot metering as this may result in an exposure error. In this circumstance, it is better to use exposure compensation.

Continuous Shooting

- Select the number of pictures in continuous shooting.
 - [SINGLE] : Take one picture only
 - [CONTINUOUS] : Images will be taken continuously until the shutter button is released. The shooting capacity depends on the memory.
- [AEB] : Take three pictures in a series in different exposures: short exposure (-0.5EV), standard exposure (0.0EV) and over exposure (+0.5EV). Use the mode if it is hard to decide exposure of the object.

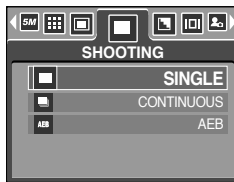

[PROGRAM mode]

- ※ High resolution and picture quality increases file saving time, which increases stand-by time.
- ※ If the [CONTINUOUS] sub menu is selected, the flash will be off automatically.
- ※ If less than 3 pictures are available in the memory, the AEB shooting is not available.
- ※ It is best to use a tripod for the AEB shooting as the time to save each image file is longer and the blurring caused by camera shake may occur.

Sharpness

- You can adjust the sharpness of the picture you want to take. You cannot check the sharpness effect on the LCD monitor before you take a picture, because this function is applied only when the captured image is stored on the memory.

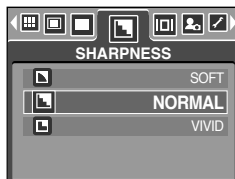

Sub menu	Icon	Description
SOFT		The edges of the image are softened. This effect is suitable for editing images on your PC.
NORMAL		The edges of the image are sharp. This is suitable for printing.
VIVID		The edges of the image are emphasized. The edges will appear sharp, but noise may occur in the recorded image.

OSD(On Screen Display) information

- In any mode with the exception of VOICE RECORDING mode, you can check the recording status in the LCD monitor.
- Idle mode : If you select the [SAVE MODE] and the camera isn't operated during the specified time(about 30 SEC.), the camera power will be idle (LCD monitor : OFF, Camera status lamp : Blinking) automatically.

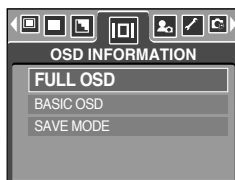

- To use the camera again, press any of the camera buttons except the power switch.
- If there is no operation during the specified time, the camera power will be turned off automatically to save battery life. Refer to page 86 for more information about the auto power off function.



[Full information mode]

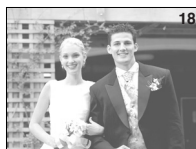

[Basic information mode]

Starting play mode

- If the memory card is inserted in the camera, all the camera functions apply only to the memory card.
- If the memory card is not inserted in the camera, all the camera functions apply only to the internal memory.
- Slide the power switch to turn the camera power on. Press the play mode button once to switch to play mode. Press the play mode button again to switch to shooting mode.
- You can turn the power on with the play mode button.
 - 1) When the lens cover closes, pressing the play mode button switches to play back mode and pressing it again makes the camera turn off.
 - 2) When the lens cover opens, pressing the play mode button switches to play back mode and pressing it again will switch to shooting mode.
- You can set up the PLAY mode function by using the camera buttons and LCD monitor.

● Playing back a still image

1. Select the PLAY mode by pressing the play mode button ().



2. The last image stored on the memory is displayed on the LCD monitor.



3. Select an image that you want to play back by pressing the LEFT/ RIGHT button.

※ Press and hold the Left or Right button to fast forward the images played.



INFORMATION

- Even if the camera's power is off, you can start the play mode by pressing the play mode button.
- Lightly press the shutter button in Play mode to switch to the currently set shooting mode.

Starting play mode

●Playing back a movie clip

Steps from 1-2 are the same as those to play back a still image.

3. Select the recorded movie clip that you want to play back by using the LEFT/ RIGHT button. If you select a movie clip, the movie clip indicator () will be displayed on the LCD monitor.

4. Press the play & pause button () to play back a movie clip file.

- To pause a movie clip file while playing it back, press the play & pause button again.

- Pressing the play & pause button again will cause the movie clip file will restart.

- To rewind the movie clip while it is playing, press the LEFT button. To fast forward the movie clip, press the RIGHT button.

- To stop playback of the movie clip, press the play & pause button, and then press the LEFT or RIGHT button.



■Movie clip capture function : capture still images from the movie clip.

●How to capture the movie clip

Steps 1-2 are the same as those for playing back a still image.

3. Select the recorded movie clip that you want to play back by using the LEFT/ RIGHT button.

4. Press the Play/ Pause button to play the movie clip

5. Press the Play/ Pause button while playing the movie clip. Then press the E button.

6. The paused movie clip is saved in a new file name.

※ The captured movie clip file has same size as the original movie clip (640X480, 320X240, 160X128).

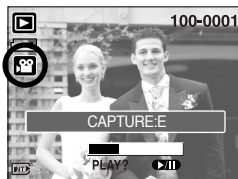

[Paused]

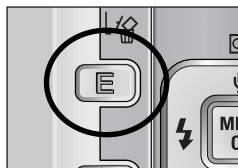

[Pressing the E button]

Starting play mode

- On camera movie trimming : You can extract desired frames of movie clip during the movie clip play back.
- If the running time is under 10 seconds, the movie clip can't be trimmed.
 1. Select a desired movie clip in the play mode.
 2. Play back the movie clip by pressing the Play & Pause button.
 3. Press the Pause button at the point of the movie clip that you want to start extracting.
 4. Press the OK button.
 5. Press the Play & Pause button and the extracted range will be displayed on the status bar.
 6. Press the Play & Pause button once more at the point where you wish the extracted file to stop.
 7. Press the OK button and a confirmation window will display.
 8. Select a desired sub menu by pressing the Up/ Down button and press the OK button.

[TRIM] : the extracted file will be saved.
[CANCEL] : cancels the extracting movie clip

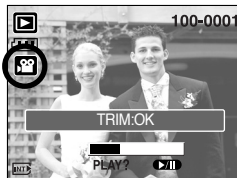
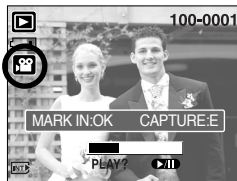

INFORMATION

- If the time line bar passes by the start point by pressing the REW(Left) button, the first frame of the movie clip will display.
- If you doesn't specify the ending point of the movie clip, the trimming confirmation window will display at the point of the last frame.

Starting play mode

●Playing back a recorded voice

Steps from 1-2 are the same as those to play back a still image.

3. Select the recorded voice that you want to play back by using the LEFT/ RIGHT button. If you select a recorded voice file, the voice indicator () will be displayed on the LCD monitor.

4. Press the play & pause button () to play back a recorded voice file.

- To pause a recorded voice file, while playing it back, press the play & pause button again.
- To resume playback of the voice file, press the play & pause button.
- To rewind the voice file while it is playing, press the LEFT button.
- To fast forward the voice file, press the RIGHT button.
- To stop playback of the voice file, press the play & pause button, and then press the LEFT or RIGHT button.



LCD monitor indicator

- The LCD monitor displays shooting information about the displayed image.



No.	Description	Icon	Page
1	Play mode		-
2	Battery		p.14
3	File Type		-
4	Voice memo		p.62
5	Protect indicator		p.74
6	DPOF indicator		p.75
7	Folder name and Stored image number	100-0009	-

- By pressing the Play mode button for over 1 Sec., you can check the recording information.



[Play mode display]

Pressing for over 1 Sec.



Pressing the Play mode button



[Recording information]

SIZE : 2592X1944 Size
 AV : F3.3 Aperture value
 TV : 1/60S Shutter speed
 ISO : 100 ISO sensitivity
 FLASH: Off Whether or not the flash is used
 DATE: 2005/07/01 Recording date

Using the camera buttons to adjust the camera

- In Play mode, you can use the buttons on the camera to conveniently set up the Play mode functions.

Thumbnail() / Enlargement() button

- You can view multiple pictures, enlarge a selected picture, and crop and save a selected area of an image.

● Thumbnail display

1. While an image is displayed full screen, press the thumbnail button.
2. The thumbnail display will highlight the image that had been showing at the time the thumbnail mode was selected.
3. Press the 5 function button to move to a desired image.
4. To view an image separately, press the enlargement button.

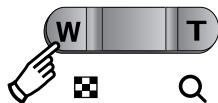

[Normal display mode]

Pressing the thumbnail button()

← →

Pressing the enlargement button()

Highlighted image



[Thumbnail display mode]

● Image enlargement

1. Select an image that you want to enlarge and press the enlargement button.
2. Different parts of the image can be viewed by pressing the 5 function button.
3. Pressing the thumbnail button will zoom back to the original full sized image.
 - You can tell whether the image displayed is an enlarged view by checking the image enlargement indicator shown at the bottom left of the LCD monitor. (If the image is not an enlarged view, the indicator will not be displayed.) You can also check the area of enlargement.
 - Movie clips and WAV files can't be enlarged.
 - If an image is enlarged, a loss of quality may occur.

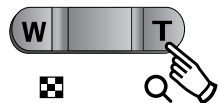

Thumbnail()/ Enlargement() button

- The maximum enlargement rate in proportion to the image size.

Image size	2592	2272	2048	1600	1024	640
Maximum enlargement rate	X8.0	X7.1	X6.4	X5.0	X3.2	X2.0

- Trimming : You can extract part of the image that you want and save it separately.

1. Select an image that you want to enlarge and press the enlargement button.
2. Different parts of the image can be viewed by pressing the 5 function button.
3. Press the MENU button and a message will be displayed as shown alongside.
4. Select a desired sub menu by pressing the UP/ DOWN button and press the OK button.
[TRIM] : The trimmed image will save as a new file name, and display on the LCD monitor.
[CANCEL]: The trimming menu will disappear.



- ※ If there is little memory space to save the trimmed image, the image can't be trimmed.
- ※ To delete the enlarged image during the trimming function, press the delete button.

Voice () memo/ Up button

- When the menu is displayed on the LCD monitor, pressing the UP button makes the menu cursor move up.
 - When the menu is not displayed on the LCD monitor, the UP button operates as the voice memo button. You can add your voice to a stored still image.
- Adding a Voice Memo to a Still Image

1. Press the LEFT/ RIGHT button to select an image that you wish to add sound to.
2. Press the voice memo button () and the voice memo indicator will display. The camera is now ready to record a voice memo.

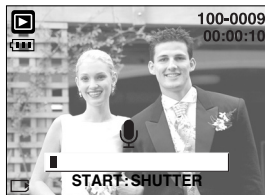

Voice () memo/ Up button

3. Press the shutter button to start recording and voice will be recorded to the still image for 10 seconds.
While the voice is recording, the recording status window will be displayed as shown alongside.



4. The recording can be stopped by pressing the shutter button again.

5. The () icon will be displayed on the LCD monitor after voice memo recording has finished.
 - Voice memos can't be recorded onto movie clip files.
 - A distance of 40cm between you and the camera (microphone) is the best distance to record sound.
 - The voice memo will be saved in *.wav format, but has the same file name as the still image to which it corresponds.
 - If you add a new voice memo to the still image that already has a voice memo, the existing voice memo will be erased.



Play & Pause () / Down button

- In Play mode, the play & pause/ down button works as follows:
 - If the menu is displayed
Press the DOWN button to move from the main menu to a sub menu, or to move down the sub menu cursor.
 - If a still image with a voice memo, a voice file, or a movie clip is playing
In Stop mode : Plays a still image with a voice memo, a voice file, or a movie clip.
During playback : Temporarily stops playback.
In Pause mode : Resumes playback



[Voice recording is stopped]



[Voice recording is playing]



[Voice recording is paused]

Delete () button

- This deletes images stored on the memory card.
- **Deleting Images in Play Mode**
 1. Select an image that you want to delete by pressing the LEFT/ RIGHT button and press the DELETE() button.
 2. A message will display as shown alongside on the LCD monitor.
 3. Select the submenu values by pressing the UP/ DOWN button and then press the OK button.
If [DELETE] is selected : deletes the selected images.
If [CANCEL] is selected : cancels "Delete Image".



- **Deleting Images in Thumbnail Display Mode**
 1. Use the UP, DOWN, LEFT, and RIGHT buttons to select the image you want to delete, and then press the DELETE () button.
 2. The following message will be displayed on the LCD monitor.
 3. Select the submenu values by pressing the UP/ DOWN button and then press the OK button.
If [DELETE] is selected : deletes the selected images.
If [CANCEL] is selected : cancels "Delete Image".

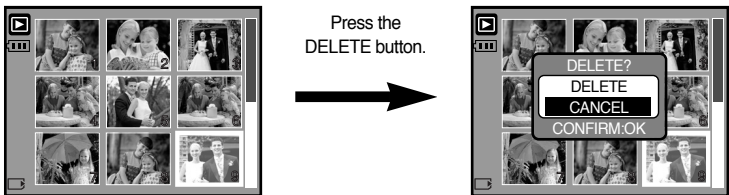

INFORMATION

- Before deleting images from the camera, you should protect or download images to your computer that you wish to keep.

Left/ Right/ Menu/ OK button

- LEFT/ RIGHT/ MENU/ OK buttons activate the following.
 - LEFT button : While the menu is showing, press the LEFT button to select the menu tab to the left of the cursor.
 - RIGHT button : While the menu is showing, press the RIGHT button to select the menu tab to the right of the cursor, or to move an secondary menu.
 - MENU button : When you press the MENU button, the play mode menu will be displayed on the LCD monitor. Pressing it again will return the LCD to the initial display.
 - OK button : When the menu is displayed on the LCD monitor, the OK button is used for confirming data that is changed by using the 5 function button.

Album button

- You can organise the captured still images into albums by using the Album button.
- This camera has 8 albums and each album can take up to 100 images.
- The album menu loading time depends on the memory card type.

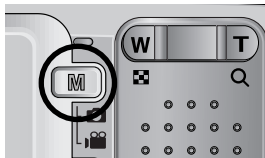

■ How to use the album

● Selecting the album

1. In the play mode, press the Album button.

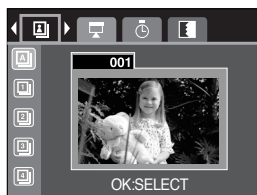

2. Select the [ALBUM] menu by pressing the Left/ Right button.

3. Select a desired album by pressing the Up/ Down button.



● Inserting still images into the album

1. Select (A) album.
2. Press the OK button and a window for inserting images will display.
3. Up/ Down button : select an album for inserting images
Left/ Right button : select images

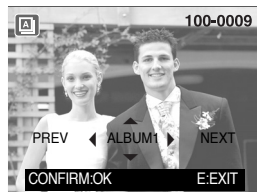

Album button

4. Press the OK button and a confirmation window for inserting an image will display. Select a desired sub menu by Pressing the Up/Down button and press the OK button.

[YES] : inserts an image into the selected album.

[NO] : cancels the inserting image.



●Removing still images from the album

1. Select an album.
2. Press the delete button and a confirmation window will display.
3. Select a desired sub menu by pressing the Up/ Down button and press the OK button.

[YES] : Removes all images in the album

[NO] : Cancels the removing images



●Removing selected image

1. Select an album.
2. Press the OK button and a window for removing images will display.

Left/ Right button: select images

Delete button : A confirmation window will display. Select a desired sub menu by pressing the Up/Down button and press the OK button.

[YES] : the selected image will be removed

[NO] : Cancels the removing image

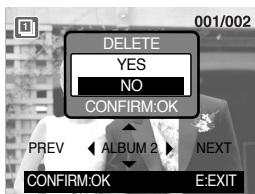

INFORMATION

- If an image is deleted from the memory, the image doesn't display on an album.
- An image can be added into the different albums.

Album button

● Playing back the albums

⊙ Playing back all of the albums

1. Select (A) album.
2. Select [SHOW] menu by pressing the Left/ Right button.
3. Select a desired sub menu by pressing the Up/ Down button. Press the OK button and the slide show will start.
(▶) : The slide show is closed after one cycle.
(↺) : The slide show is repeated until the OK button is pressed.

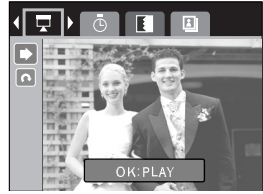

⊙ Playing a desired album

1. Select a desired album.
2. Select [SHOW] menu by pressing the Left/ Right button.
3. Select a desired sub menu by pressing the Up/ Down button. Press the OK button and the slide show will start.
(▶) : The slide show is closed after one cycle.
(↺) : The slide show is repeated until the OK button is pressed.

● Setting play interval: Set the slide show play interval.

1. Select a desired album.
2. Select [INTERVAL] menu by pressing the Left/ Right button.
3. Select a desired sub menu by pressing the Up/ Down button.

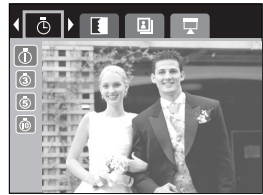

● Configure slide show effects

: Unique screen effects can be used for the slide show.





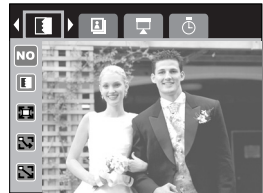

1. Select a desired album.
2. Select [EFFECT] menu by pressing the Left/ Right button.
3. Select a desired sub menu by pressing the Up/ Down button.

- (NO) : Normal display.
(E) : Image moves from the left.
(▶) : Image is displayed slowly from the centre outwards.
(↖) : Image moves from the top left.
(↘) : The image slides diagonally from top left to bottom right.
(MIX) : NO, E, ▶, ↖, and ↘ effects are applied in order.





Setting up the play back function using the LCD monitor

- PLAY mode functions can be changed by using the LCD monitor. In the PLAY mode, pressing the MENU button displays the menu on the LCD monitor. The menus you can set up in Play mode are as follows. To capture an image after setting up the play menu, press the PLAY button.





Menu tab	Main menu	Sub menu	Secondary menu	Page
	ROTATE	RIGHT90°	-	p. 72
		LEFT90°	-	
		180°	-	
		HORIZONTAL	-	
		VERTICAL	-	
	RESIZE	2272X1704	-	p. 73
		2048X1536	-	
		1600X1200	-	
		1024X768	-	
		640X480	-	
		USER IMAGE 1, 2	-	
	PROTECT	SELECT	UNLOCK/ LOCK	p. 74
		ALL	UNLOCK/ LOCK	
	DELETE ALL	NO	-	p. 75
		YES	-	
	DPOF	STANDARD	ONE PIC/ ALL PICS	p. 75
		INDEX	NO/ YES	
		PRINT SIZE	DEFAULT/3X5/4X6/5X7/8X10	~ p. 77
		CANCEL	STANDARD/INDEX/PRINT SIZE	
	COPY TO CARD	NO	-	p. 78
		YES	-	

Setting up the play back function using the LCD monitor

- This menu is available while the camera is connected to a PictBridge supporting printer (direct connection to the camera, sold separately) with a USB cable.

Menu tab	Main menu	Sub menu	Secondary menu	Page
	IMAGES	ONE PIC	-	p. 80
		ALL PICS	-	
	AUTO SET	NO	-	p. 81
		YES	-	
	CUSTOM SET	SIZE	AUTO	p. 81
			POSTCARD	
			CARD	
			LETTER	
			4X6	
			L	
			2L	
			A4	
		A3		
		LAYOUT	AUTO	
			FULL	
			1	
			2	
			4	
			8	
		TYPE	9	
16				
AUTO				
PLAIN				
PHOTO				
FAST PHO.				

Setting up the play back function using the LCD monitor

Menu tab	Main menu	Sub menu	Secondary menu	Page
	CUSTOM SET	QUALITY	AUTO	p.81
			DRAFT	
			NORMAL	
			FINE	
		DATE	AUTO	
			OFF	
			ON	
		FILE NAME	AUTO	
			OFF	
ON				
	PRINT	STANDARD	-	p. 82
		INDEX	-	
	DPOF PRINT	NO	-	p. 82
		YES	-	
	RESET	NO	-	p.83
		YES	-	

※ Menus are subject to change without prior notice.

Rotating an image

■ You can rotate the stored images by various degrees.

1. Press the play mode button and press the menu button.
2. Press the LEFT/ RIGHT button and select the [ROTATE] menu tab.
3. Select a desired sub menu by pressing the UP/ DOWN button.

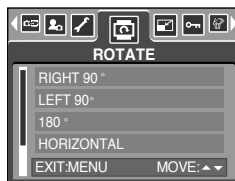

[RIGHT 90°] :
Rotate picture in a clock-wise
direction

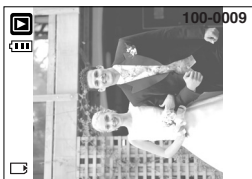

[LEFT 90°] :
Rotate picture in a counter-
clock-wise direction



[180°] :
Rotate picture 180 degrees

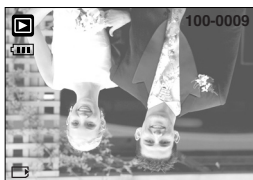

[HORIZONTAL] :
Rotate picture horizontally

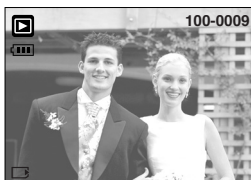

[VERTICAL] :
Rotate picture vertically

4. Press the OK button. The rotated image will be saved with a new file name and the menu will disappear. If you display the rotated image on the LCD monitor, empty spaces may appear to the left and right of the image.

Resize

- Change the resolution (size) of pictures taken. Select [USER IMAGE] to save an image to be the start-up image. The resized image will have a new file name.

1. Press the play mode button and press the menu button.
2. Press the LEFT/ RIGHT button and select the [RESIZE] menu tab.
3. Select a desired sub menu by pressing the UP/ DOWN button and press the OK button.



● Image Resize Types

Resize	2272X 1704	2048X 1536	1600X 1200	1024X 768	640X 480	USER IMAGE
2592	O	O	O	O	O	O
2272	X	O	O	O	O	O
2048	X	X	O	O	O	O
1600	X	X	X	O	O	O
1024	X	X	X	X	O	O
640	X	X	X	X	X	O

INFORMATION

- A large sized image can be resized to a smaller sized image, but not vice versa.
- Only JPG images can be resized. MOVIE and WAV files can't be resized.
- You can change the resolution of only those files compressed in the JPEG 4:2:2 format.
- The resized image will have a new file name. The [USER IMAGE] image is stored not on the memory card but on the internal memory.
- Only two [USER IMAGE] images can be saved. If you save a new [USER IMAGE] image, the existing startup image will be deleted in order.
- If the memory capacity is insufficient to store the resized image, a [CARD FULL!] message will display on the LCD monitor and the resized image will not be stored.

Protecting images

- This is used to protect specific shots from being accidentally erased (LOCK). It also unprotects images that have been previously protected (UNLOCK).

● Protecting Images

1. Press the play mode button and press the menu button.
2. Press the LEFT/ RIGHT button and select the [PROTECT] menu tab.
3. Select a desired sub menu by pressing the UP/ DOWN button and press the OK button.

[SELECT] : Only an image that is displayed on the LCD monitor is protected or unprotected.

[ALL] : All of the stored images are protected or unprotected.



4. Select the desired secondary menu by pressing the UP/ DOWN button and press the OK button.

[UNLOCK] : Cancels the protect function.

[LOCK] : Sets up the protect function.

- If you select the [SELECT] sub menu at step 3, you can protect or unprotect another image by pressing the LEFT/ RIGHT button. If you press the SHUTTER button, the Image Protection menu will disappear.

- If you protect an image, the protect icon() will be displayed on the LCD monitor.

(An unprotected image has no indicator)

- An image in LOCK mode will be protected from [DELETE] or [DELETE ALL] functions, but will NOT be protected from the [FORMAT] function.

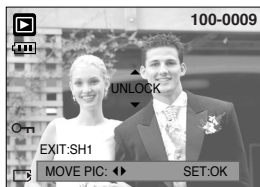

Deleting all images

- Of all the files stored in the memory card, the unprotected files in the DCIM subfolder will be deleted. Remember that this will permanently delete unprotected images. Important shots should be stored on a computer before deletion takes place. The startup image is stored in the camera's internal memory (i.e., not on the memory card) and it will not be deleted even if you delete all files on the memory card.

● Deleting all images

1. Press the play mode button and press the menu button.
2. Press the LEFT/ RIGHT button and select the [DELETE ALL] menu tab.
3. Select a desired sub menu by pressing the UP/ DOWN button and press the OK button.

Selecting [NO] : cancels "Delete All"

Selecting [YES] : Displays the dialogue box to confirm the delete.

- If [DELETE] is selected : press the OK button and all unprotected pictures are deleted.

- If [CANCEL] is selected : press the OK button and images are not deleted.



DPOF

- DPOF(Digital Print Order Format) allows you to embed printing information on your memory card's MISC folder. Select the pictures to be printed and how many prints to make.
- The DPOF indicator will display on the LCD monitor when an image that has DPOF information plays back. Images can then be printed on DPOF printers, or at an increasing number of photo labs.
- This function is not available for Movie clips and Voice recording files.
- The DPOF file is only stored on the memory card.

DPOF : STANDARD

- This function allows you to embed print quantity information on a stored image.

1. Press the play mode button and press the menu button.
2. Press the LEFT/ RIGHT button and select the [DPOF] menu tab.
3. Select the [STANDARD] menu by pressing the UP/ DOWN button and press the RIGHT button.
4. Use the UP and DOWN buttons to select [ONE PIC] or [ALL PICS], and then press the OK button. A window for selecting number of copies will display.

[ONE PIC] : Set the number of copies to print for the current picture only.

[ALL PICS] : Set the number of copies to print for each picture, excluding movie clips and voice recordings.

5. Use the UP and DOWN buttons to select the number of copies and then press the OK button.

- The DPOF icon () will appear by the pictures for which the number of copies to print is set.

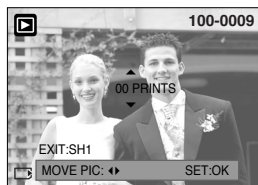
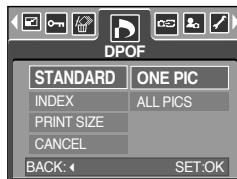

DPOF : INDEX

- Images (except for movie clips and voice file) are printed as index type.

1. Press the play mode button and press the menu button.
2. Press the LEFT/ RIGHT button and select the [DPOF] menu tab.
3. Select the [INDEX] menu by pressing the UP/ DOWN button and press the RIGHT button.
4. Select a desired sub menu by pressing the UP/ DOWN button.

If [NO] is selected : The image will not be printed in index format.

If [YES] is selected : The image will be printed in index format.

5. Press the OK button to confirm the setting.
6. Press the menu button twice and the menu will disappear.



DPOF : PRINT SIZE

- You can specify the print size when printing images stored on the memory card. The [PRINT SIZE] menu is available only for DPOF 1.1 compatible printers.

● Setting the Print Size

1. Press the play mode button and press the menu button.
2. Press the LEFT/ RIGHT button and select the [DPOF] menu tab.
3. Select the [PRINT SIZE] menu by pressing the UP/ DOWN button and press the RIGHT button.
4. Select a desired sub menu by pressing the UP/ DOWN button and press the OK button.

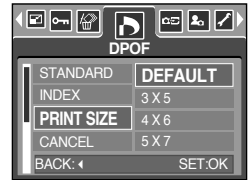

* PRINT SIZE : DEFAULT, 3X5, 4X6, 5X7, 8X10

* The [DEFAULT] print size varies depending on the printer manufacturer.

For your printer's default value, please refer to the user's guide that came with your printer.

DPOF : CANCEL

- You can cancel the [STANDARD], [INDEX], or [PRINT SIZE] settings. Cancel the setting to reset the value to its default.

1. Press the play mode button and press the menu button.
2. Press the LEFT/ RIGHT button and select the [DPOF] menu tab.
3. Select the [CANCEL] menu by pressing the UP/ DOWN button and press the RIGHT button.
4. Select a desired sub menu by pressing the UP/ DOWN button.

If [STANDARD] is selected : Cancels the standard print setting.

If [INDEX] is selected : Cancels the index print setting.

If [PRINT SIZE] is selected : Cancels the print size setting.

5. Press the OK button to confirm the setting.

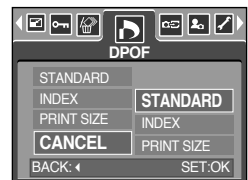

COPY TO CARD

- This enables you to copy image files to the memory card.
- Copying to the Memory Card
 1. Press the play mode button and press the menu button.
 2. Select the [COPY TO CARD] menu tab by pressing the LEFT/ RIGHT button.
 3. Select a desired sub menu by pressing the UP/ DOWN button and press the OK button.
 - [NO] : cancels the [COPY TO CARD] function.
 - [YES] : All images saved in the internal memory are

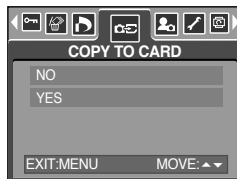

copied to the memory card after the [PROCESSING!] message is displayed. After copying has been completed, the screen will return to play mode.

INFORMATION

- When this menu is selected without inserting a memory card, you can't select the [COPY TO CARD] sub menus.
- If there is not enough space available in the memory card to copy saved images in the internal memory (25MB), the [COPY TO CARD] command will copy only some of the images and display [CARD FULL!] message. Then the system will return to the playback mode. Please be sure to delete any unnecessary images to free up space before inserting the memory card into the camera.

PictBridge

- You can use the USB cable to connect this camera to a printer that supports PictBridge (sold separately) and print the stored images directly. Movie clips and voice files cannot be printed. You can set up the following settings from the PictBridge menu.

IMAGES	: Select the pictures to be printed.
PRINTER SETUP	: Setting up printing(AUTO SET/ CUSTOM SET)
PRINT	: Printing pictures
DPOF AUTO PRINT	: Printing the DPOF files
RESET	: Initializing the PictBridge functions

● Connecting the Camera to a Printer

1. Slide the power switch to turn the camera power on.
2. Use the supplied USB cable to connect the camera to the printer as shown below.
3. Turn on the printer to connect the camera to the printer.
4. A window for selecting an external device will display on the LCD monitor.
5. Select [PRINTER] menu by pressing the Up/ Down button and press the OK button.

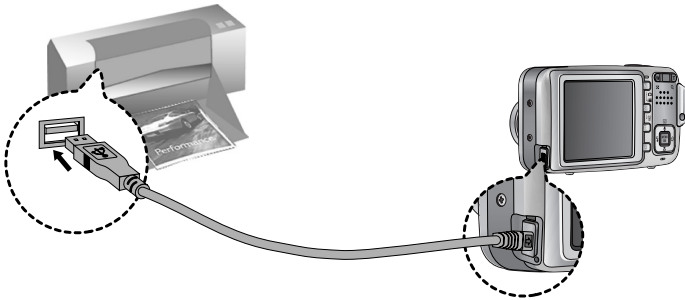

- ※ If you selected [COMPUTER] in Step 5, when you connect the camera to your printer, the [USB ERROR!] message will display and the connection will not be established. In this case, disconnect the USB cable, and then follow the procedure from Step 2 and onward.

PictBridge : Picture Selection

■ Select pictures to print

1. Connect the camera to your printer. The USB menu must be set to [PRINTER] after you connect the camera to the printer. (See p.79)
2. Use the LEFT and RIGHT buttons to select the [IMAGE] menu tab.
3. Use the UP and DOWN buttons to select the desired submenu value, and then press the OK button.



When [ONE PIC] is selected : The PictBridge function will be applied only to the picture currently displayed.

When [ALL PICS] is selected : The PictBridge function will be applied to all pictures, excluding movie clips and voice files.

● Setting the Number of Copies to Print

- Select [ONE PIC] or [ALL PICS]. A screen where you can set the number of copies to print will appear as shown below.



[When [ONE PIC] is selected]

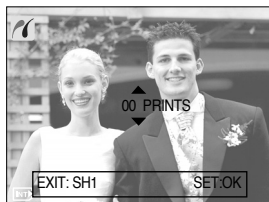

[When [ALL PICS] is selected]

- Press the Up/ Down button to select the number of prints. Maximum 30 prints.
- When you select [ONE PIC] menu, use the Left/ Right button to select another picture and select the number of prints for another picture.
- After setting the number of prints, press the OK button to save.
- Press the Shutter button to return to the menu without setting the number of prints.

PictBridge : Print Setting

■ AUTO SET

1. Connect the camera to your printer. The USB menu must be set to [PRINTER] after you connect the camera to the printer. (See p.79)
2. Use the LEFT and RIGHT buttons to select the [AUTO SET] menu tab.
3. Use the UP and DOWN buttons to select the desired submenu value, and then press the OK button.
[NO] : [CUSTOM SET] values are kept.
[YES]: All values in the [CUSTOM SET] are automatically changed.



■ CUSTOM SET : You can select the Paper Size, Print Format, Paper Type, Print Quality, Date Print, and File Name Print menus for printed pictures.

1. Connect the camera to your printer. The USB menu must be set to [PRINTER] after you connect the camera to the printer. (See p.79)
2. Use the LEFT and RIGHT buttons to select the [CUSTOM SET] menu tab.
3. Use the UP and DOWN buttons to select the desired submenu value, and then press the RIGHT button.
4. Use the UP and DOWN buttons to select the desired submenu value, and then press the OK button.

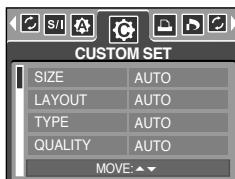

■ The menus you can set up are as follows:

Menu	Function	Sub menu
SIZE	Setting the size of the printing paper	AUTO, POSTCARD, CARD, LETTER, 4 X 6, L, 2L, A4, A3
LAYOUT	Setting the number of pictures to be printed on a sheet of paper	AUTO, FULL, 1, 2, 4, 8, 9, 16
TYPE	Setting the quality of the printing paper	AUTO, PLAIN, PHOTO, FASTPHO.
QUALITY	Setting the quality of the picture to be printed	AUTO, DRAFT, NORMAL, FINE
DATE	Setting whether to print the date	AUTO, OFF, ON
FILE NAME	Setting whether to print the file name	AUTO, OFF, ON

※ Some menu options are not supported in all manufacturer and printer models.

※ If the setting values are not changed in the automatic/manual setting, the setting values are automatically kept.

PictBridge : Printing

■ Printing Pictures

1. Connect the camera to your printer.

The USB menu must be set to [PRINTER] after you connect the camera to the printer. (See p.79)

2. Use the LEFT and RIGHT buttons to select the [PRINT] menu tab.
3. Use the UP and DOWN buttons to select the desired submenu value, and then press the OK button.

[STANDARD] : Print the pictures stored in the memory card in set numbers.

One picture is printed on one piece of paper.

[INDEX] : Print multiple images on one sheet of paper.

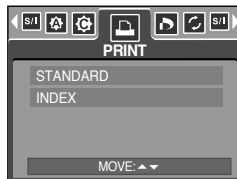

4. The screen shown on the right will appear and the picture will be printed. If no picture is selected, the [NO IMAGE!] message will be displayed. Press the shutter button while printing to cancel the printing and the [IMAGES] menu is displayed.

※ Number of pictures in a index print varies depends on the printer used.

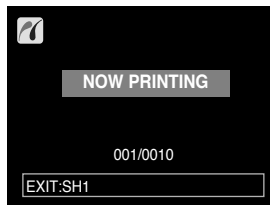

■ DPOF PRINT : This allows you to directly print the files with DPOF information.

1. Connect the camera to your printer. The USB menu must be set to [PRINTER] after you connect the camera to the printer. (See p.79)
2. Use the LEFT and RIGHT buttons to select the [DPOF PRINT] menu tab.
3. Use the UP and DOWN buttons to select the desired submenu value, and then press the OK button.

[NO] : Cancel the printing

[YES]: Directly print the file with the DPOF information

※ Depending on the manufacturer and printer model, some menus may not be available. With a printer without supporting the DPOF, the menu is still displayed but not available.

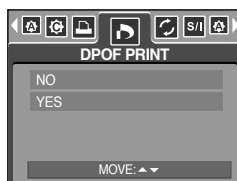

PictBridge : RESET

■ Initialises user-changed configurations.

1. Connect the camera to your printer.

The USB menu must be set to [PRINTER] after you connect the camera to the printer.(See p.79)

2. Use the LEFT and RIGHT buttons to select the [RESET] menu tab.

3. Use the UP and DOWN buttons to select the desired submenu value, and then press the OK button.

- If [NO] is selected : Settings will not be reset.

- If [YES] is selected : All print and image settings will be reset.



※ Default print setting varies depending on the printer manufacturer.

For your printer's default setting, refer to the user's guide that came with your printer.

Setup menu

- In this mode, you can set up basic settings. You can use the setup menu in all camera modes, except Voice Recording mode.

The items indicated by are default settings.

Menu tab	Main menu	Sub menu	Secondary menu	Page	
	FILE	RESET	-	p.85	
		SERIES	-		
	PWR SAVE	OFF, 1, 3 , 5MIN	-	p.86	
	LANGUAGE	ENGLISH	한국어	FRANÇAIS	p.87
		DEUTSCH	ESPAÑOL	ITALIANO	
		简体中文	繁體中文	РУССКИЙ	
		PORTUGUÊS	DUTCH	DANSK	
		SVENSKA	SUOMI	ไทย	
		BAHASA	عربي	Čeština	
		POLSKI	Magyar	-	
	FORMAT	NO	-	p.87	
		YES	-		
	DATE&TIME	05/07/01 13:00	OFF	p.88	
		YYYY/MM/DD	-		
		DD/MM/YYYY	-		
		MM/DD/YYYY	-		
	IMPRINT	OFF	-	p.88	
		DATE	-		
		DATE&TIME	-		
	AF LAMP	OFF	-	p.89	
ON		-			
SOUND	OFF	-	p.89		
	LOW	-			
	MEDIUM	-			
	HIGH	-			

Setup menu

Menu tab	Main menu	Sub menu	Secondary menu	Page
	LCD	DARK	-	p.90
		NORMAL	-	
		BRIGHT	-	
	VIDEO	NTSC	-	p.90
		PAL	-	
	Q.VIEW	OFF, 0.5, 1, 3SEC	-	p.92
	RESET	NO	-	p.92
		YES	-	

※ Menus are subject to change without prior notice.

File name

■ This function allows the user to select the file naming format.

● Assigning File Names

1. In any mode with the exception of Voice Recording mode, press the MENU button.
2. Press the LEFT/ RIGHT button and select the [SETUP] menu tab.
3. Select the [FILE] menu by pressing the UP/ DOWN button and press the RIGHT button.
4. Select a desired sub menu by pressing the UP/ DOWN button and press the OK button.

[SERIES] : New files are named using numbers that follow the previous sequence, even when a new memory card is used, or after formatting, or after deleting all pictures.

[RESET] : After using the reset function, the next file name will be set from 0001 even after formatting, deleting all or inserting a new memory card.

5. Press the menu button twice and the menu will disappear.

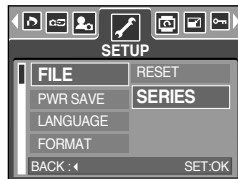

File name

INFORMATION

- The first stored folder name is 100SSCAM, and the first file name is SA550001.
- File names are assigned sequentially from SA550001 → SA550002 → ~ → SA559999.
- The folder number is assigned sequentially from 100 to 999 as follows:
100SSCAM → 101SSCAM → ~ → 999SSCAM.
- The files used with the memory card conform to the DCF(Design rule for Camera File systems) format.

Auto power off

- This function switches the camera off after a set amount of time in order to prevent unnecessary battery drainage.

● Setting Power Off

1. In any mode with the exception of Voice Recording mode, press the MENU button.
2. Press the LEFT/ RIGHT button and select the [SETUP] menu tab.
3. Select the [PWR SAVE] menu by pressing the UP/ DOWN button and press the RIGHT button.
4. Select a desired sub menu by pressing the UP/ DOWN button and press the OK button.

[OFF] : The power off function will not operate.

[1, 3, 5 MIN] : The power will turn off automatically if not used for the period of time specified.

5. Press the menu button twice and the menu will disappear.



INFORMATION

- Even if the battery is removed and inserted again, the power off setting will be preserved.
- Note that the automatic power off function will not operate if the camera is in PC mode, slide show, playing back a voice recording, playing back a movie clip and the [COMPOSITE] shooting.

Language

- There is a choice of languages that can be displayed on the LCD monitor. Even if the battery is removed and inserted again, the language setting will be preserved.

● Setting Language

1. In any mode with the exception of Voice Recording mode, press the MENU button.
2. Press the LEFT/ RIGHT button and select the [SETUP] menu tab.
3. Select the [LANGUAGE] menu by pressing the UP/ DOWN button and press the RIGHT button.
4. Select a desired sub menu by pressing the UP/ DOWN button and press the OK button.



LANGUAGE sub menu : English, Korean, French, German, Spanish, Italian, S.Chinese, T.Chinese, Russian, Portuguese, Dutch, Danish, Swedish, Finnish, Thai, BAHASA(MALAY/ INDONESIAN), Arabic, Hungarian, Czech and Polish.

5. Press the menu button twice and the menu will disappear.

Formatting a memory card

- This is used for formatting the memory card. If you run [FORMAT] on the memory card, all images, including the protected images, will be deleted. Be sure to download important images to your PC before formatting the memory card.

● Formatting a Memory Card

1. In any mode other than Voice Recording mode, press the MENU button.
2. Press the LEFT/ RIGHT button and select the [SETUP] menu tab.
3. Select the [FORMAT] menu by pressing the UP/ DOWN button and press the RIGHT button.
4. Select a desired sub menu by pressing the UP/ DOWN button and press the OK button.



If [NO] is selected : The memory card will not be formatted.

Press the menu button twice and the menu display will disappear.

If [YES] is selected : A confirmation window will display. Select the [FORMAT] message and press the OK button. A [PROCESSING!] message appears and the memory card will be formatted. If you ran FORMAT in Play mode, a [NO IMAGE!] message will appear.

INFORMATION

- Be sure to run [FORMAT] on the following types of memory card.
 - A new memory card, or an unformatted memory card.
 - A memory card that has a file this camera can't recognise or one that has been taken from another camera.
- Always format the memory card using this camera. If you insert a memory card that has been formatted using other cameras, memory card readers, or PCs, you will get a [CARD ERROR!] message.

Setting up the Date/ Time/ Date type

- You can change the date and time that will be displayed on the captured images and set up the date type.

● Setting Date/ Time & Selecting Date Format

1. In any mode with the exception of Voice Recording mode, press the MENU button.
2. Press the LEFT/ RIGHT button and select the [SETUP] menu tab.
3. Select the [DATE&TIME] menu by pressing the UP/ DOWN button and press the RIGHT button.
4. Use the UP, DOWN, LEFT, and RIGHT buttons to select the desired submenu value, and then press the OK button.
 - RIGHT button : Selects the year/ month/ day/ hour/ minute date type.
 - LEFT button : Moves the cursor to the [DATE&TIME] main menu if the cursor is at the first item of the date and time setup. In all other cases, the cursor will be shifted to the left of its current position.
 - UP and DOWN buttons : Changes the setting value.
5. Press the menu button twice and the menu will disappear.

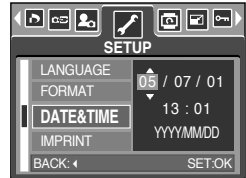

Imprinting the recording date

- There is an option to include DATE/ TIME on still images.

● Date Imprinting

1. In any mode with the exception of Voice Recording mode, press the MENU button.
2. Press the LEFT/ RIGHT button and select the [SETUP] menu tab.
3. Select the [IMPRINT] menu by pressing the UP/ DOWN button and press the RIGHT button.
4. Use the UP and DOWN buttons to select the desired date imprint type, and then press the OK button.
 - [OFF] : The DATE & TIME will not be imprinted on the image file.
 - [DATE] : Only the DATE will be imprinted on the image file.
 - [DATE&TIME] : The DATE & TIME will be imprinted on the image file.
5. Press the menu button twice and the menu will disappear.
 - ※ The Date & Time are imprinted at the bottom right side of the still image.
 - ※ The date will be imprinted as a DATE TYPE setting.
 - ※ TIME is imprinted in the following way : [Hour : Minute] and hours are shown using the 24 hour clock.
 - ※ The imprint function is applied only to still images.

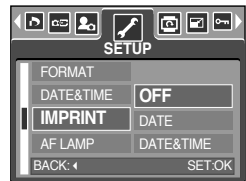

Auto Focus lamp

- You can turn on and off the Auto Focus lamp
- How to set up the lamp
 1. In any mode with the exception of Voice Recording mode, press the MENU button.
 2. Press the LEFT/ RIGHT button and select the [SETUP] menu tab.
 3. Select the [AF LAMP] menu by pressing the UP/ DOWN button and press the RIGHT button.
 4. Select a desired sub menu by pressing the UP/ DOWN button and press the OK button.
 - If [OFF] is selected : The AF lamp will not light up.
 - If [ON] is selected : The AF lamp will light up.

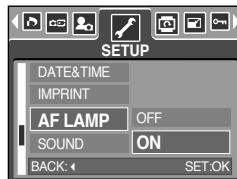

- ※ If you select [OFF] menu and take an image in poorly lit conditions or select the [NIGHT] scene mode, the camera may not take exact focus.
- ※ The Auto Focus lamp will function while using the self-timer even if the configuration is set to off.

Sound

- If you set the operation sound to ON, various sounds will be activated for camera startup, when button are pressed, and if there is a card error, so that you can be aware of the camera operation status.
- Setting Operation Sounds
 1. In any mode with the exception of Voice Recording mode, press the MENU button.
 2. Press the LEFT/ RIGHT button and select the [SETUP] menu tab.
 3. Select the [SOUND] menu by pressing the UP/ DOWN button and press the RIGHT button.
 4. Select a desired sub menu by pressing the UP/ DOWN button and press the OK button.
 - [SOUND] sub menu : OFF/ LOW/ MEDIUM/ HIGH
 5. Press the menu button twice and the menu will disappear.

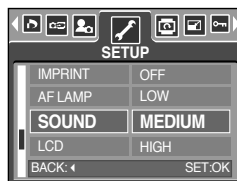

LCD brightness

- You can adjust the LCD brightness.

● Adjusting LCD Brightness

1. In any mode with the exception of Voice Recording mode, press the MENU button.
2. Press the LEFT/ RIGHT button and select the [SETUP] menu tab.
3. Select the [LCD] menu by pressing the UP/ DOWN button and press the RIGHT button.
4. Select a desired sub menu by pressing the UP/ DOWN button and press the OK button.
[LCD] sub menu : DARK, NORMAL, BRIGHT
5. Press the menu button twice and the menu will disappear.



Selecting Video out type

- The Movie output signal from the camera can be NTSC or PAL.

Your choice of output will be governed by the type of device (monitor or TV, etc.) to which the camera is connected. PAL mode can support only BDGHI.

● Setting the Video Out Type

1. In any mode with the exception of Voice Recording mode, press the MENU button.
2. Press the LEFT/ RIGHT button and select the [SETUP] menu tab.
3. Select the [VIDEO] menu by pressing the UP/ DOWN button and press the RIGHT button.
4. Select a desired sub menu by pressing the UP/ DOWN button and press the OK button.
- [VIDEO] sub menu : NTSC, PAL
5. Press the menu button twice and the menu will disappear.

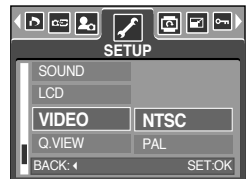

Selecting Video out type

■ Connecting to an external monitor

In RECORDING/PLAY mode, you can view the stored still images or movie clips by connecting the camera to an external monitor via the A/V cable. When the camera is connected to an external monitor, the LCD monitor will be turned off automatically.

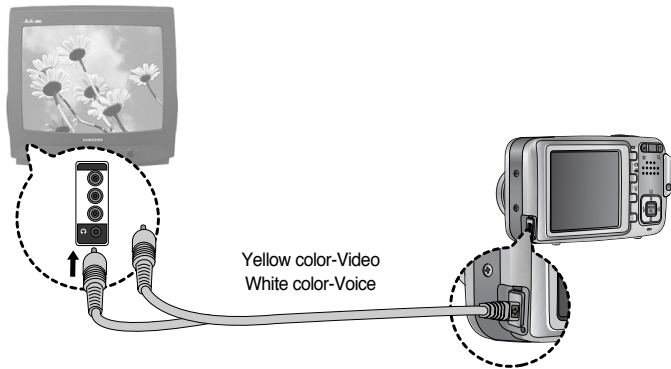

INFORMATION

- NTSC : U.S.A, Canada, Japan, South Korea, Taiwan, Mexico.
- PAL : Australia, Austria, Belgium, China, Denmark, Finland, Germany, U.K., Holland, Italy, Kuwait, Malaysia, New Zealand, Singapore, Spain, Sweden, Switzerland, Thailand, Norway.
- When using a TV as an external monitor, you will need to select the external or AV channel of the TV.
- There will be a digital noise on the external monitor, but it is not a malfunction.
- If the image is not in the centre of the screen, use the TV controls to centre it.
- When the camera is connected to an external monitor, the menu will be visible on the external monitor and the menu functions are the same as those indicated on the LCD monitor.

Quick view

- If you enable Quick View before capturing an image, you can view the image you just captured on the LCD monitor for the duration set in the [Q.VIEW] setup. Quick view is possible only with still images.

● Setting Quick View

1. In any mode with the exception of Voice Recording mode, press the MENU button.
2. Press the LEFT/ RIGHT button and select the [SETUP] menu tab.
3. Select the [Q.VIEW] menu by pressing the UP/ DOWN button and press the RIGHT button.
4. Select a desired sub menu by pressing the UP/ DOWN button and press the OK button.

[OFF] : The quick view function can't be activated.

[0.5, 1, 3SEC] : The captured image is briefly displayed during the selected time.

5. Press the menu button twice and the menu will disappear.

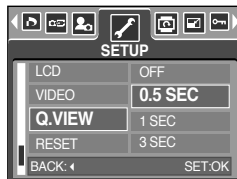

Initialisation

- All camera menu and function settings will be restored to their default values. However, values for DATE/ TIME, LANGUAGE, and VIDEO OUT will not be changed.

● Initialising the Camera

1. In any mode with the exception of Voice Recording mode, press the MENU button.
2. Press the LEFT/ RIGHT button and select the [SETUP] menu tab.
3. Select the [RESET] menu by pressing the UP/ DOWN button and press the RIGHT button.
4. Select a desired sub menu by pressing the UP/ DOWN button and press the OK button.





If [NO] is selected : Settings will not be restored to their defaults.

If [YES] is selected : A confirmation window will display. Select the [YES] menu and press the OK button. Then all settings will be restored to their defaults.

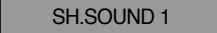

Setting up the MYCAM menu

- You can set up a start up image, start up sound and shutter sound. Every camera working mode (with the exception of Voice recording mode) has the MyCAM menu. The items indicated by  are default settings.

Menu tab	Main menu	Sub menu		Page
	S.IMAGE	 OFF	LOGO	p.93
		USER IMAGE 1	USER IMAGE 2	
	SH.SOUND	OFF	 SH.SOUND 1	p.94
		SH.SOUND 2	SH.SOUND 3	
	S.SOUND	 OFF	SOUND 1	p.94
		SOUND 2	SOUND 3	

* Menus are subject to change without prior notice.

Start up image

- You can select the image that is first displayed on the LCD monitor whenever the camera is turned on.

● Setting a Startup Image

- In any mode with the exception of Voice Recording mode, press the MENU button.
- Press the LEFT/ RIGHT button and select the [MYCAM] menu tab.
- Select the [S.IMAGE] menu by pressing the UP/ DOWN button and press the RIGHT button.
- Select a desired sub menu by pressing the UP/ DOWN button and press the OK button.
- Press the menu button twice and the menu will disappear.



INFORMATION

- Use a saved image for the start-up image with the [USER IMAGE] in the [RESIZE] menu in the play mode.
- The start-up image will not be deleted by deleting all images or [FORMAT] menu.
- The start-up images are deleted by doing the [RESET] menu.

Shutter sound

- You can select the shutter sound.

● Selecting the Shutter Sound

1. In any mode with the exception of Voice Recording mode, press the MENU button.
2. Press the LEFT/ RIGHT button and select the [MYCAM] menu tab.
3. Select the [SH.SOUND] menu by pressing the UP/ DOWN button and press the RIGHT button.
4. Select a desired sub menu by pressing the UP/ DOWN button and press the OK button.
5. Press the menu button twice and the menu will disappear.

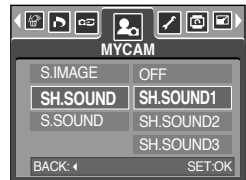

Start up sound

- You can select the sound that is activated whenever the camera is turned on.

● Setting the Startup Sound

1. In any mode with the exception of Voice Recording mode, press the MENU button.
2. Press the LEFT/ RIGHT button and select the [MYCAM] menu tab.
3. Select the [S.SOUND] menu by pressing the UP/ DOWN button and press the RIGHT button.
4. Select a desired sub menu by pressing the UP/ DOWN button and press the OK button.
5. Press the menu button twice and the menu will disappear.

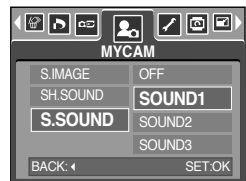

Important notes

Be sure to observe the following precautions!

- This unit contains precision electronic components. Do not use or store this unit in the following locations.
 - Areas exposed to severe changes in temperature and humidity.
 - Areas exposed to dust and dirt.
 - Areas exposed to direct sunlight or the inside of a vehicle in hot weather.
 - Environments where there is high magnetism or excessive vibration.
 - Areas with high explosives or highly flammable materials.

- Do not leave this camera in places subject to dust, chemicals (like naphthalene and mothball), high temperature and high humidity.
Keep this camera with silica gel in a hermetically sealed box when not planning to use the camera for a long period of time

- Sand can be particularly troublesome to cameras.
 - Do not let sand get inside the unit when using it on beaches, coastal dunes, or other areas where there is lots of sand.
 - Doing so may result in failure or may permanently render the unit unusable.

- Handling the camera
 - Never drop the camera or subject it to severe shocks or vibrations.
 - Prevent the large size LCD monitor from an impact. When this camera is not used, keep this camera in the camera case.
 - Avoid obstructing the lens or the flash when you capture an image.
 - This camera is not waterproof.
To avoid dangerous electrical shocks, never hold or operate the camera with wet hands.
 - If you use this camera in wet places, such as beach or pool, do not let water or sand get inside the camera. Doing so may result in failure or may permanently damage the unit.

- Extremes in temperature may cause problems.
 - If the camera is transferred from a cold to a warm and humid environment, condensation can form on the delicate electronic circuitry. If this occurs, turn the camera off and wait for at least 1 hour until all moisture is dispersed. Moisture build up can also occur in the memory card. If this happens, turn off the camera and remove the memory card. Wait until the moisture has dispersed.

Important notes

■ Caution on Using the Lens

- If the lens is subjected to direct sunlight, it could result in discoloration and deterioration of the image sensor.
- Pay attention not to get fingerprints or foreign substances on the surface of the lens.

■ If the digital camera is not used for a long period, an electric discharge can occur.

It is a good idea to remove the battery and the memory card if you do not intend using the camera for an extended period of time.

■ If the camera is exposed to an electronic interference, it will turn itself off to protect the memory card.

■ Camera Maintenance

- Use a soft brush (available from photo stores) to gently clean the lens and LCD assemblies. If this does not work, lens-cleaning paper with lens cleaning fluid can be used. Clean the camera body with a soft cloth. Do not allow this camera to come into contact with solvent materials such as benzol, insecticide, thinners etc. This may damage the body shell of the camera and also affect its performance. Rough handling can damage the LCD monitor. Take care to avoid damage and keep the camera in its protective carry case at all times when not in use.

■ Do not attempt to disassemble or modify the camera.

■ Under certain conditions, static electricity can cause the flash unit to fire. This is not harmful to the camera and is not a malfunction.

■ Before an important event or going on a trip, you should check the camera condition.

- Take a picture for testing the camera condition and prepare extra battery.
- Samsung cannot be held responsible for camera malfunctions.

Warning indicator

- There are several warnings that may appear on the LCD display

CARD ERROR!

- Memory card error
 - Turn off the camera power and turn it on again
 - Insert the memory card again
 - Insert the memory card and format the memory card (p.87)

MEMORY ERROR!

- Internal memory error
 - Turn off the camera power and turn it on again
 - Format the memory with the memory card removed. (p.87)

CARD LOCKED!

- The memory card is locked
 - SD memory card : Slide the write protect switch to the top of the memory card

CARD FULL!/ MEMORY FULL!

- There is insufficient memory capacity to take an image
 - Insert a new memory card
 - Delete unnecessary image files to free up some memory

NO IMAGE!

- There are no images stored on the memory
 - Take images
 - Insert a memory card that is holding some images

FILE ERROR!

- File error
 - Format the memory card
- Memory card error
 - Contact a camera service centre

LOW BATTERY!

- There is low battery capacity
 - Insert fresh batteries

Warning indicator

LOW LIGHT!

- When taking pictures in dark places
 - Take pictures in Flash Photography mode.

OUT OF NUMBER

- When selecting too many printing pages in the PictBridge menu.
 - Select printing page within the limitation.

Before contacting a service centre

- Please check the following

The camera doesn't switch on

- There is low battery capacity
 - Insert fresh batteries
- Battery are inserted incorrectly with the polarities reversed
 - Insert the battery according to the polarity marks (+, -)

The camera power ceases while in use

- The battery are exhausted
 - Insert fresh batteries
- The Camera is turned off automatically
 - Turn on the camera power again.

Battery drain quickly

- The Camera is being used in low temperatures
 - Keep the camera in warm conditions (i.e. inside a coat or jacket) and only remove it in order to take images

Before contacting a service centre

Camera does not take images when pressing the Shutter button

- . There is insufficient memory capacity
 - Delete unnecessary image files
- . The memory card has not been formatted
 - Format the memory card (p.87)
- . The memory card is exhausted
 - Insert a new memory card
- . The memory card is locked
 - Refer to [CARD LOCKED!] error message (p.97)
- . The camera's power is off
 - Turn the camera power on
- . The battery are exhausted
 - Insert fresh batteries.
- . Battery is inserted incorrectly with the polarities reversed
 - Insert the battery according to the polarity marks (+, -)

The camera suddenly stops working while in use

- . The camera was stopped due to a malfunction
 - Remove /re-insert battery and switch the camera on

The images are unclear

- . A picture was taken within 0.6m from the subject without setting an appropriate macro mode
 - If the subject is closer than 0.6m, select macro shot mode
- . The picture was taken with the subject beyond the flash range
 - Take a picture within the flash range
- . The lens is smudged or dirty
 - Clean the lens

The flash does not fire

- . Flash off mode has been selected
 - Dis-engage flash off mode
- . The camera mode can't use the flash
 - Refer to the FLASH instruction (p.33)

Incorrect date and time is displayed

- . The date and time have been set incorrectly or the camera has adopted the default settings
 - Reset the date and time correctly

Before contacting a service centre

The camera buttons do not operate

- . Camera malfunction
 - Remove/ re-insert battery and switch the camera on

A card error has occurred while the memory card is in the camera.

- . Incorrect memory card format
 - Re-format the memory card

The images don't play back

- . Incorrect file name (Violation of DCF format)
 - Do not change the image file name

Colour of image is different to the original scene

- . White balance setting is incorrect
 - Select appropriate White balance

Images are too bright

- . Exposure is excessive
 - Reset exposure compensation

No image on external monitor

- . The external monitor has not been connected properly with the camera
 - Check the connection cables
- . There are incorrect files in the memory card
 - Insert a memory card that has correct files

When using the PC's explorer, the [Removable Disk] file does not show

- . Cable connection is incorrect
 - Check the connection
- . The camera is off
 - Turn the camera on
- . The operating system is not Windows 98, 98SE, 2000, ME, XP/ Mac OS 9.2 ~ 10.3.
Alternatively the PC does not support USB
 - Install Windows 98, 98SE, 2000, ME, XP/ Mac OS 9.2 ~ 10.3 to PC that supports USB
- . The camera driver is not installed
 - Install a [USB Storage Driver]

Specifications

Image Sensor	Type	1/2.5" CCD
	Effective Pixel	Approx. 5.0 Mega-pixel
	Total Pixel	Approx. 5.1 Mega-pixel
Lens	Focal Length	SHD Lens $f = 4.6 \sim 22.2\text{mm}$ (35mm film equivalent : 28 ~ 135mm)
	F No.	F3.3 ~ F4.8
	Digital Zoom	Still Image mode : 1.0X ~ 5.0X Play mode : 1.0X ~ 8.0X (depends on image size)
LCD Monitor		2.5" color TFT LCD
Focusing	Type	TTL auto focus
	Range	Normal : 60cm ~ infinity Macro : 2cm ~ 60cm (Wide), 19cm ~ 60cm (Tele) Auto Macro : 5cm ~ infinity (Wide), 19 ~ infinity (Tele)
Shutter	Type	Mechanical and Electronic shutter
	Speed	4~1/2,000 sec. (Night : 8sec~1/2,000 sec.)
Exposure	Control	Program AE Metering : Multi, Spot
	Compensation	$\pm 2\text{EV}$ (0.5EV steps)
	ISO Equivalent	AUTO, 100, 200, 400
Flash	Modes	Auto, Auto & Red-eye reduction, Fill-in flash, Slow sync, Flash off
	Range	Wide : 0.25m ~ 3.0m, Tele : 0.5m ~ 2.0m
	Recharging Time	Approx. 5 sec.
Sharpness		Soft, Normal, Vivid
Effect		Normal, B&W, Sepia, Negative, Red, Green, Blue, RGB, Highlight Frame, Composite, Photo Frame
White Balance		Auto, Daylight, Cloudy, Fluorescent_H, Fluorescent_L, Tungsten, Custom
Voice Recording		Voice Recording (max. 1 hour), Voice Memo in Still Image (max. 10 sec.)
Date Imprinting		Off, Date, Date & Time (user selectable)
Shooting	Still Image	Modes : Auto, Program, Scene, Voice Recording * Scene : Night, Portrait, Children, Landscape, Close-up, Sunset, Dawn, Backlight, Fireworks, Beach & Snow Continuous : Single, Continuous, AEB Self-timer : 2 sec., 10 sec., Double(10 sec., 2 sec.)
	Movie Clip	With audio (recording time : memory capacity dependent) Size : 640x480, 320x240, 160x128 Frame rate : 30fps, 15fps
Storage	Media	Internal memory: Approx. 25MB flash memory External memory: SD card/ MMC (Up to 1GB Guaranteed)
	File Format	Still Image : JPEG (DCF), EXIF 2.2, DPOF 1.1, PictBridge 1.0 Movie Clip : AVI (MPEG-4) Audio : WAV

Specifications

Storage	Image Size	5M : 2592x1944 4M : 2272x1704 3M : 2048x1536 2M : 1600x1200 1M : 1024x768 VGA : 640x480
	Capacity (25MB)	5M : Super Fine 9, Fine 18, Normal 26 4M : Super Fine 11, Fine 23, Normal 34 3M : Super Fine 14, Fine 28, Normal 41 2M : Super Fine 23, Fine 44, Normal 64 1M : Super Fine 53, Fine 96, Normal 132 VGA : Super Fine 117, Fine 189, Normal 238 * These figures are measured under Samsung's standard conditions and may vary depending on shooting conditions and camera settings.
Image Play	Type	Single image, Thumbnails, Slide show, Movie Clip, Album mode
	Editing	Trimming, Rotating, Resizing
Interface		Digital output connector : USB 2.0 Audio : Mono Video output : NTSC, PAL (user selectable) PictBridge
Power Source		Primary Batteries: 2 x AA alkaline, or CR-V3(Lithium) battery Secondary Batteries : 2 x Ni-MH, Samsung SBP-1303 (Lithium Ion) * Included battery may vary depending on sales region.
Dimensions (WxHxD)		106.3x56.5x26.7mm
Weight		150g (without battery and card)
Operating Temperature		0 ~ 40°C
Operating Humidity		5 ~ 85%
Software	Camera Driver	Storage Driver (Windows98/ 98SE/ 2000/ ME/ XP, Mac OS 9.2 ~ 10.3)
	Application	ArcSoft PhotoImpression, Digimax Viewer
Special Features		Optical 4.8X Zoom for Still image MPEG-4 VGA 30fps, Supporting Edit on DSC Various Scene Modes and Effects (Color Effect, Highlight, Composite, Photo Frame) Easy Mode Change M Button

* Specifications are subject to change without prior notice.

* All trademarks are the property of their respective owners.

Software Notes

Please ensure that you read the instruction manual carefully before use.

- . The attached software is a camera driver and image editing software tool for Windows.
- . Under no circumstances should all or part of either the software or the user manual be reproduced.
- . Copyrights for software are licensed only for use with a camera.
- . In the unlikely event of a manufacturing fault, we will repair or exchange your camera. We cannot, however, be held responsible in any way for damage caused by inappropriate use.
- . Using a Hand-made PC or a PC and OS that has not been guaranteed by the manufacturer is not covered by the Samsung warranty.
- . Before reading this manual, you should have a basic knowledge of computers and O/S (Operating Systems).

System Requirements

For Windows	For Macintosh
PC with processor better than MMX Pentium 233MHz (XP : Pentium II 300MHz)	Power Mac G3 or later
Windows 98/98SE/2000/ME/XP	Mac OS 9.2 ~ 10.3
Minimum 64MB RAM (XP : 128MB) 200MB of available hard-disk space (Over 1GB is recommended)	Minimum 64MB RAM 110MB of available hard-disk space
USB port	USB port
CD-ROM drive	CD-ROM drive
1024X768 pixels, 16-bit colour display compatible monitor (24-bit colour display recommended) DirectX 8.1 or later	QuickTime player or a media player that supports AVI file format

About the software

After inserting the CD-ROM provided with this camera into the CD-ROM drive, the following window should automatically run.



Before connecting the camera to the PC, you should first install the camera driver.

■ Camera driver : This enables images to transfer between the camera and PC.

This camera uses the USB Storage Driver as the camera driver. You can use the camera as a USB card reader. After installing the driver and connecting this camera to the PC, you can find [Removable Disk] in [Windows Explorer] or [My computer]. A USB Storage Driver is provided only for Windows. A USB Driver for MAC is not included with the Application CD. But you can use the camera with Mac OS 9.2 ~ 10.3.

■ XviD codec : This makes movie clips(MPEG-4) recorded with this camera play back on a PC.

To play back a movie clip recorded with this camera, you must install the XviD codec.

If a movie clip recorded with this camera does not play well, install this codec.

This software is only compatible with Windows.

If a movie clip can't play back on the Mac OS, please visit the following site.

<http://www.divx.com/divx/mac/>

If a movie clip can't play back on the Mac OS, use a media player that supports XviD codec (Mplayer, VLC(VideoLAN Client) media player)

■ Digimax Viewer : This is a program for viewing stored images.

You can see the stored images in the memory directly on a PC monitor. You can also copy, move or delete the images and enlarge/downscale the image sizes with Digimax Viewer. This software is only compatible with Windows.

About the software

■ PhotoImpression : Image editing program.

You can edit or store still images that you download from the camera.

This software is only compatible with Windows.

INFORMATION

- Be sure to check the system requirements before installing the driver.
- You should allow 5 ~ 10 seconds for running the automatic setup program according to the capability of the computer. If the frame does not show, run the [Windows Explorer] and select [Samsung.exe] in the CD-ROM Drive root directory.

Setting up the application software

To use this camera with a PC, install the application software first.

After this has been done, the stored images in the camera can be moved to the PC and can be edited by an image editing program.

INFORMATION

- Close other programs before installing the application software.
- Before installing the application software, disconnect the USB connection.

You can visit the Samsung web-site through the internet.

<http://www.samsungcamera.com> : English

<http://www.samsungcamera.co.kr> : Korean

1. Click the [Install] menu in the Autorun frame.
The camera driver is installed automatically.



2. Installation is complete.
Click the [Finish] button.

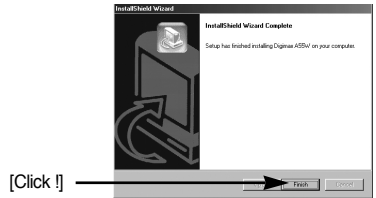

3. A windows to check whether the PC has XviD codec or not will display.

[Preview] : You can check the movie clip display condition.

[Install] : The XviD codec is installed.

[Cancel] : The XviD codec is not installed and a window for installing the application softwares will display.



※ If you didn't click the [Preview] button, the [Install] button can't be selected.

Setting up the application software

4. If an error listed below takes place during the preview, click the [Install] button to install the XviD codec.

- Only a voice plays back.
- An error message displays and the movie clip does not play back.



* A window shown alongside may display according to the system requirements.

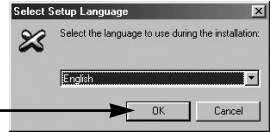

[Click !]

5. The XviD codec installation window will be displayed as shown alongside. Click the [Next >] button.



[Click !]

6. The Software License Agreement window will be displayed. If you agree to this, select [I accept the agreement] and click [Next >] button. The window will then move to the next step. If you disagree, select [I do not accept the agreement] and click [Cancel] button. The installation program will be cancelled.

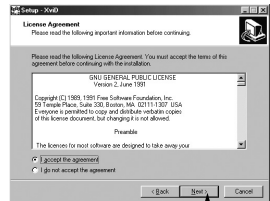

[Click !]

※ The XviD codec is distributed according to the GNU General Public License and everyone can copy, distribute and change this codec. For more information, see the License documents.

Setting up the application software

7. The XviD information window will display.
Click the [Next >] button.

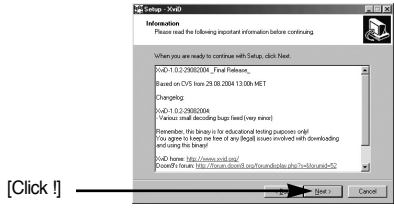

8. The destination selection window will open.
Click [Next >] button.
To copy to the files to another folder, click [Browse...]
and choose a folder you want.

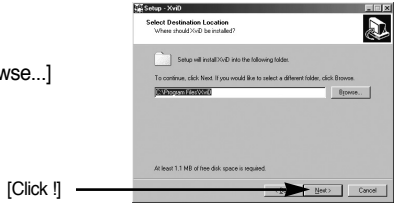

9. A window will open, asking you to choose a folder to which program icons will be added.
Click [Next >] button.
If you want to add the program icons to a different folder, choose another folder, and then click [Next >] button.



10. The [Select Additional Tasks] window will display.
Select the additional tasks and click the [Next >] button.

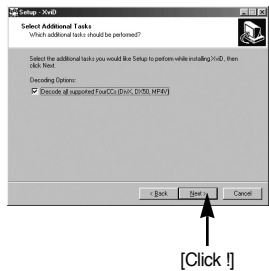

Setting up the application software

11. The XviD codec is ready to install.

Click the [Install] button.

[Click !]

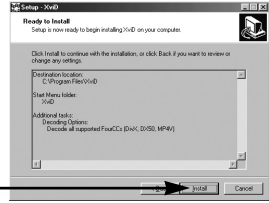

12. Installation is complete.

Click the [Finish] button.

[Click !]



13. A window where you can choose the program you want to install will appear. Click [Install].

For information on application software, please refer to page 104, 105.

[Click !]

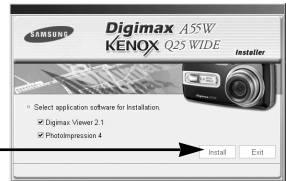

INFORMATION

- If you select [Exit] at step 13, the application program installation will be cancelled.

14. The [Digimax Viewer 2.1] installation window will be displayed as shown alongside.

Click the [Next >] button.

[Click !]



Setting up the application software

INFORMATION

- If you select [Cancel] at step 14, a window for installing Photolmpression will be displayed.

15. The Software License Agreement window will be displayed.

If you agree to this, click [Yes], the window will then move to the next step.

If you disagree, click [No] and the installation program will be cancelled.



[Click !]

16. A destination selection window will open.

Click [Next >].

To copy to the files to another folder, click [Browse..] and choose a folder you want.

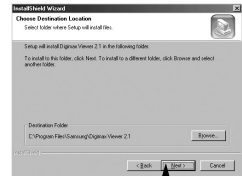

[Click !]

17. A window will open, asking you to choose a folder to which program icons will be added.

Click [Next >] button.

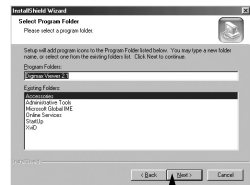

[Click !]

18. Digimax Viewer installation is successfully completed.

Click the [Finish] button to install Photolmpression.

- * The system will not reboot even the [Yes, I want to restart the computer now] option is selected.
- * The screen shot of step 18 can be different with the illustration according to the system requirements.



[Click !]

Setting up the application software

19. The PhotoImpression installation window will be displayed as shown alongside.
Click the [OK] button.

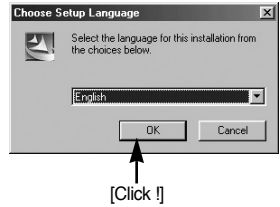

20. A Welcome window will be displayed.
Click the [Next >] button.



21. The Software License Agreement window will be displayed.
If you agree to this, click [Yes], the window will then move to the next step.
If you disagree, click [No] and the installation program will be cancelled.

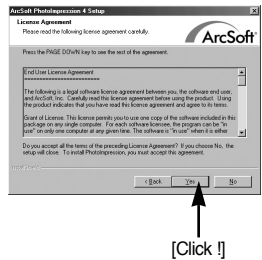

Setting up the application software

22. A destination selection window will open.

Click [Next >]. To copy the files to another folder, click [Browse...] and choose a folder you want.

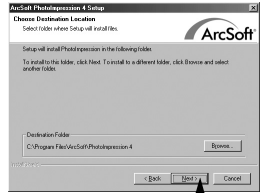

23. The [Select Components] window will appear.

Click [Next >] button.

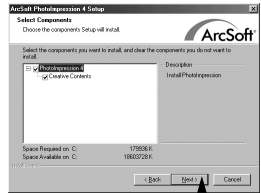

24. A window will open, asking you to choose a folder to which program icons will be added.

Click [Next >] button. If you want to add the program icons to a different folder, choose another folder, and then click [Next >] button.

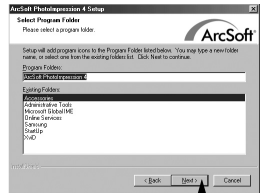

25. PhotoImpression Installation is completed.

Click the [Finish] button.

- * The system will not reboot even if the [Yes, I want to restart the computer now] option is selected.
- * The frame that appears may be different to that shown according to the system requirements.

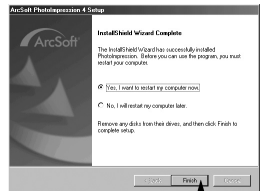

Setting up the application software

26. To apply changes, you must restart the computer. Select [Yes, I want to restart my computer now], and then click [Finish].

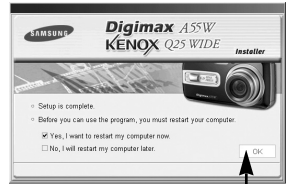

[Click !]

27. After restarting the computer, connect the PC to the camera with the USB cable.

28. Turn the camera power on.
[Found New Hardware Wizard] will open and the computer will recognise the camera.

* If you have ever installed an image viewer program or your OS is Windows XP, an image viewer program will open.
If the image viewer program opens, the camera driver was setup successfully.



29. If you can see [Removable Disk] under [My computer], the camera driver installation was successful.

Now you can transfer image files from the camera to PC via the USB cable.

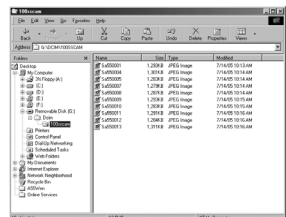

Setting up the application software

INFORMATION

- If you have installed the camera driver, [Found New Hardware Wizard] may not open.
- On a Windows 98 or 98 SE system, the Found New Hardware Wizard dialog box opens and a window asking you to select a driver file may appear. In this case, specify "USB Driver" in the CD supplied. (for Windows 98 and 98 SE).
- Before connecting the camera to the PC, You should first install the camera driver.
- After installing the camera driver, you have to restart your PC.
- If you connect the camera to the PC before installing the camera driver, the [Found New Hardware Wizard] will open.
In this case, cancel the [Found New Hardware Wizard] and disconnect the camera. Install the camera driver and connect the camera to the PC again.
- Should the computer not find the camera driver after installation, please try one or more of the following measures.
 1. Delete the camera driver (p.118), and re-install the driver.
 2. Refer to FAQ (p.125) to check for a possible solution to the problem.
 3. If your PC's central processing unit is VIA chip (This is shown in the USB Host Controller), download the patch file from the Samsung Camera web page. (<http://www.samsungcamera.com>)

Starting PC mode

- If you connect the USB cable to a USB port on your PC and then turn on the power, the camera will automatically switch to "computer connection mode".
- In this mode, you can download stored images to your PC through the USB cable.

■ Connecting the camera to a PC

1. Slide the power switch to turn the camera power on.
2. Use the supplied USB cable to connect the camera to the computer as shown below.
3. Turn on the computer to connect the camera to the printer.
4. A window for selecting an external device will display on the LCD monitor.
5. Select [COMPUTER] menu by pressing the Up/Down button and press the OK button.

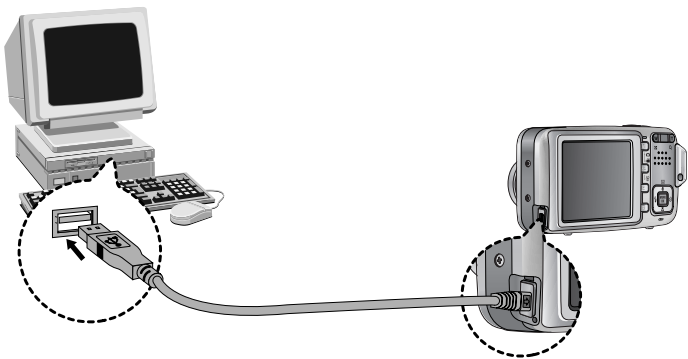

※ If you selected [PRINTER] in Step 5, when you connect the camera to your computer, the [USB ERROR!] message will display and the connection will not be established. In this case, disconnect the USB cable, and then follow the procedure from Step 2 and onward.

Starting PC mode

■ Downloading stored images

You can download the still images stored on the camera to your PC's hard disk and print them or use a photo editing software to edit them.

1. Connect the camera to your PC with the USB cable.

2. On your computer's desktop display, select [My computer] and double click [Removable Disk → DCIM → 100SSCAM].

The image files will then be displayed.

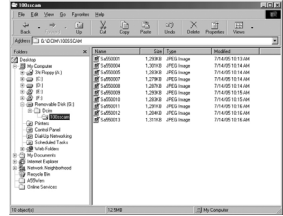

3. Select an image and press the right mouse button.

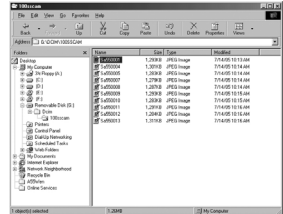

4. A pop-up menu will open.

Click [Cut] or [Copy] menu.

- [Cut] : cuts a selected file.
- [Copy] : copies files.

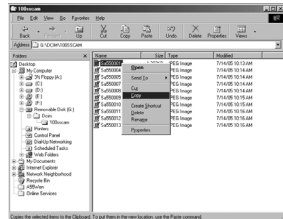

5. Click a folder where you want to paste the file.

Starting PC mode

6. Press the right mouse button and a pop-up menu will open. Click [Paste].

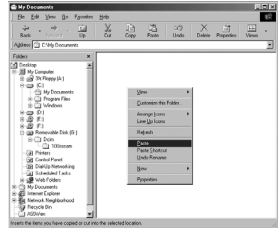

7. An image file is transferred from the camera to your PC.

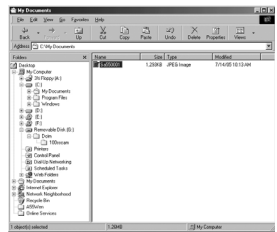

- By using [Digimax Viewer], you can see the stored images in the memory directly on the PC monitor and you can copy or move the image files.

Removing the USB Driver for Windows 98SE

■ To remove the USB driver, refer to the process shown below.

1. Trace [Start →Settings] and click [Control Panel].

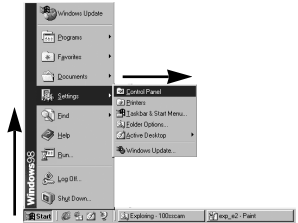

2. Double-click [Add/ Remove programs].



3. The [Add/ Remove Programs Properties] window will open. Click [Digimax A55W] and click the [Add/ Remove] button.

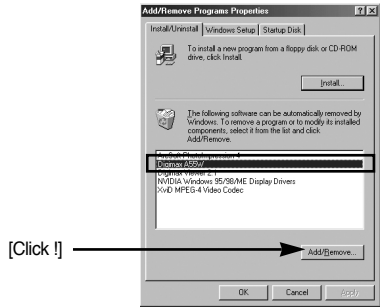

4. Uninstallation is complete.
Click the [Finish] button and the window will disappear.



Removable Disk

- To use this camera as a Removable Disk, install (p.106) the USB Driver.
 1. Before turning the camera power on, connect the camera to the PC with the USB cable.
 2. Click [Removable Disk] under [My computer] or [Windows Explorer].
 3. Image files stored in the Removable Disk (DCIM → 100SSCAM) can be transferred to the PC.

INFORMATION

Important information whilst using the Removable Disk

- The [Removable Disk] indicator will not show when the camera power is off or the USB cable is removed.
- We recommend that you should copy the images to the PC to view them. Opening images directly from the removable disk may be subject to unexpected disconnection.
- When uploading images from the PC to the camera, ensure that the uploaded file names are not the same as those already stored on the memory.
- When you upload a file that is not taken by this camera to Removable Disk, the [FILE ERROR!] message will be displayed on the LCD monitor in the PLAY mode, and nothing is displayed in THUMBNAIL mode.
- The camera status lamp will blink, when a file is transferred (copy or deletion) between the PC and the camera. Do not remove the USB cable until the lamp stops blinking.

To remove the USB cable in Windows 2000/ME/XP, use the [Unplug or Eject Hardware] icon on the task bar.

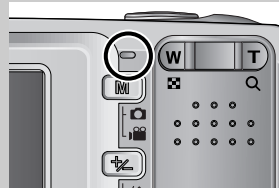

Removing the removable disk

■ Windows 98SE

1. Check whether the camera and PC are transferring a file.
If the camera status lamp blinks, you have to wait until the lamp illuminates.
2. Unplug the USB cable.

■ Windows 2000/ME/XP

(The illustrations may be different from the real display in accordance with the Windows O/S.)

1. Check whether the camera and PC are transferring a file.
If the camera status lamp blinks, you have to wait until the lamp illuminates.

2. Double-click the [Unplug or Eject Hardware] icon on the task bar.



3. The [Unplug or Eject Hardware] window will open. Select the [USB Mass Storage Device] and click the [Stop] button.

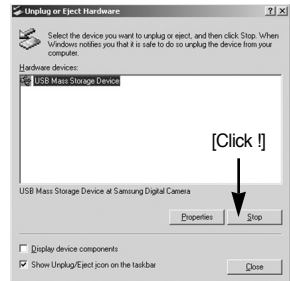

4. The [Stop a Hardware device] window will open. Select the [USB Mass Storage Device] and click the [OK] button.

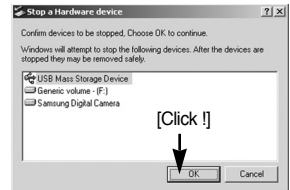

5. A [Safe to Remove Hardware] window will open. Click the [OK] button.



Removing the removable disk

6. A [Unplug or Eject Hardware] window will open.
Click the [Close] button and the removable disk will be removed safely.

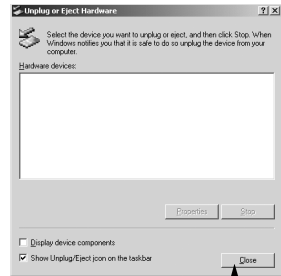

7. Unplug the USB cable.

Setting up the USB Driver for MAC

1. A USB Driver for MAC is not included with the software CD as MAC OS supports the camera driver.
2. Check the MAC OS. You can check the MAC OS version during MAC OS start-up.
This camera is compatible with MAC OS 9.2 ~ 10.3.
3. Connect the camera to the Macintosh and turn the camera power on.
4. A new icon will be displayed on the desktop after connecting the camera to the MAC.

Using the USB Driver for MAC

1. Double click a new icon on the desktop and the folder in the memory will be displayed.
2. Select an image file and copy or move it to MAC.

CAUTION

- For Mac OS 10.0 or later : First complete uploading from computer to the camera and then remove the removable disk with the Extract command.
- If a movie clip can't play back on the Mac OS, please visit the following site(<http://www.divx.com/divx/mac/>) and download the codec. Or, use a media player that supports the Xvid codec (Mplayer, VLC(VideoLAN Client) media player).

Digimax Viewer 2.1

■ This software is only compatible with Windows.

1. To open Digimax Viewer, click the [Start → Programs → Samsung → Digimax Viewer 2.1 → Digimax Viewer 2.1] and Digimax Viewer 2.1 will then open.



2. If the [Auto Launch] option is selected, this program will be executed automatically when the camera is recognised.

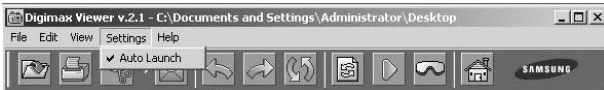

3. You can easily use the Digimax viewer 2.1 program as it offers a FILE menu and TOOL bar. And, you can use the pop up menu. Click an image and press the right mouse button.



Digimax Viewer functions are listed below.

- Basic functions : Copy, Move, Delete, Rotate, Rename, changing file type, Resize, Property.
- Advanced functions : Print, Slide show, Export, Sending e-mail, On-line print, Web album etc.

INFORMATION

- Before deleting images from the camera, you should download images to your computer that you wish to keep.
- Refer to the [Help] menu in Digimax viewer 2.1 for further information.

Using Photolmpression





- With Photolmpression, you can edit or store still images that you downloaded from the camera. This software is only available in Windows version.
- To start the program, click [Start → Programs → ArcSoft Photolmpression 4 → Photolmpression 4]. The following screen will appear.













Using Photolmpression

· You can use Photolmpression to perform the following tasks.

■ Command Button

Button	Description
	Imports a picture from an album, a source folder, or the camera/scanner, or captures screen shots of what is being viewed on the current monitor.
	Selects Cut, Resize, Edit Image, Insert Text, Enhance Picture, Insert Effects, or Layer.
	Performs Insert Frame, Insert Borders, Insert Calendar, Insert Greeting Cards, Insert Template, or Connect with Other Software.
	Saves the edited picture, and sends an e-mail or uses it as the background image.
	Outputs the edited picture according to your preferences.

■ Tool Bar

Button	Description	Button	Description
	Resize Layer		Rotate Layer
	Flip Layer Horizontally		Rotate All Layers
	Undo		Redo
	Copy		Paste
	Delete Layer		Close Picture

INFORMATION

- For detailed instructions on how to use Photolmpression, please refer to the program's Help.

FAQ

- Please check the following if the USB connection malfunctions.

[Case 1] The camera power is off.
→ Turn the camera power on.

[Case 2] USB Driver is not installed correctly.
→ Install the USB Driver correctly. Refer to page 106.

[Case 3] The USB cable is not connected or you are using a cable with an incorrect specification.
→ Use a USB cable with the correct specification.

[Case 4] The camera is not recognized by your PC.
Sometimes, the camera may appear under [Unknown Devices] in Device Manager.
→ Install the camera driver correctly.
Turn off the camera, remove the USB cable, plug in the USB cable again, and then turn on the camera.

[Case 5] There is an unexpected error during file transfer
→ Turn the camera power off and on again. Transfer the file again.

[Case 6] How do I know my computer supports a USB Interface?
→ Check the USB port in your computer or keyboard.
→ Check the OS version. A USB Interface is available in Windows 98, 98SE, 2000, ME .XP.
→ Check [Universal Serial Bus controllers] in Device Manager. Do the following to check [Universal Serial Bus controllers].
Win 98/ME : Trace [Start → Settings → Control Panel → System → Device Manager → Universal Serial Bus controllers].
Win 2000 : Trace [Start → Settings → Control Panel → System → Hardware → Device Manager → Universal Serial Bus controllers].
Win XP : Trace [Start → Control Panel → Performance and Maintenance → System → Hardware → Device Manager → Universal Serial Bus controllers].

FAQ

There must be USB Host Controller and USB root hub under [Universal Serial Bus controllers].

In addition, double-click on the USB Universal Host Controller and the USB Root Hub to check if the Device Status states "This device is working properly".

If the Device Status says the device is "not working properly", click the "Driver" tab and then click [Update Driver] or [Reinstall Driver].

- When all the conditions mentioned above are met, the computer can support the USB interface.

[Case 7] When using the USB hub.

- There may be a problem in connecting the camera to the PC through the USB hub if the PC and the hub are not compatible. Wherever possible, connect the camera to the PC directly.

[Case 8] Are other USB cables connected to the PC?

- The camera may malfunction when it is connected to the PC at the same time as another USB cable. In this case, disconnect the other USB cable, and connect only one USB cable to the camera.

[Case 9] When I open the Device Manager (by clicking Start → (Settings) → Control Panel → (Performance and Maintenance) → System → (Hardware) → Device Manager), there are 「Unknown Devices」 or 「Other Devices」 entries with a yellow question mark(?) beside them or devices with an exclamation mark(!) beside them.

- Right-click on the entry with the question(?) or exclamation (!) mark and select "Remove". Restart the PC and connect the camera the again. For Windows 98 PC, remove the camera driver also, restart the PC, and then reinstall the camera driver.
- Double-click on the entry with the question (?) or exclamation (!) mark, click the "Driver" tab, and click [Update Driver] or [Reinstall Driver]. If a message appears asking you to specify the location of the appropriate device driver, specify "USB Driver" in the CD supplied.

[Case 10] In some security programs (Norton Anti Virus, V3, etc.), the computer may not recognize the camera as a removable disk.

- Stop the security programs and connect the camera to the computer. Refer to the security program instructions about how to stop the program.

FAQ

- When the movie clip doesn't play back on the PC
- ※ When the movie clip recorded by the camera doesn't play back on the PC, the causes are mostly due to the codec installed on the PC.

- When the correct software for playback of a movie is not installed
→ Install the codec as listed below.

[Installing codec for Windows]

- 1) Insert the CD provided with the camera
- 2) Run the windows explorer and select [CD-ROM drive:\XviD] folder and click the XviD codex-1[1].1.0.exe file.

[Installing codec for Mac OS]

- 1) Visit the following site for downloading the codec.<http://www.divx.com/divx/mac>
- 2) Click the [Free Download] button located at the upper right side of the page and a window for downloading the DivX codec will display.
- 3) Select the Mac OS you use and click the [Download] button. Save it on a folder you want to.
- 4) Run the downloaded file and the codec for playing back the movie clip will be installed.
 - ※ If a movie clip can't play back on the Mac OS, use a media player that supports XviD codec (Mplayer, VLC(VideoLAN Client) media player).

- When the DirectX 8.1 or later is not installed
→ Install the DirectX 8.1 or later
- 1) Insert the CD provided with the camera
- 2) Run the windows explorer and select [CD-ROM drive:\ USB Driver\DirectX] folder and click the DXSETUP.exe file. The DirectX will be installed. Visit the following site for downloading the DirectX.<http://www.microsoft.com/directx>

FAQ

- If a PC (Windows 98) stops responding while the camera and PC are connected repeatedly
 - If a PC (Windows 98) is turned on for a long time and connect the camera repeatedly, the PC may not recognise the camera. In this case, re-start the PC.

- If a PC connected with the camera stops responding while Windows is starting.
 - In this case, disconnect the PC and the camera and Windows will start.
 - If the problem happens continuously, set the Legacy USB Support to disable and re-start the PC. The Legacy USB Support is in the BIOS setup menu. (The BIOS setup menu differs from the PC manufacturers and some BIOS menus don't have Legacy USB Support) If you can't change the menu by yourself, contact to the PC manufacturer or BIOS manufacturer.

- If the movie clip can't be deleted, removable disk can't be extracted or an error message displays during the file transfer.
 - If you install only the Digimax Viewer, the problems mentioned above occasionally happen.
 - Close the Digimax Viewer program by clicking the Digimax Viewer icon on the Taskbar.
 - Install all the application programs included in the software CD.
 - (You must install the Movie clip codec)

MEMO

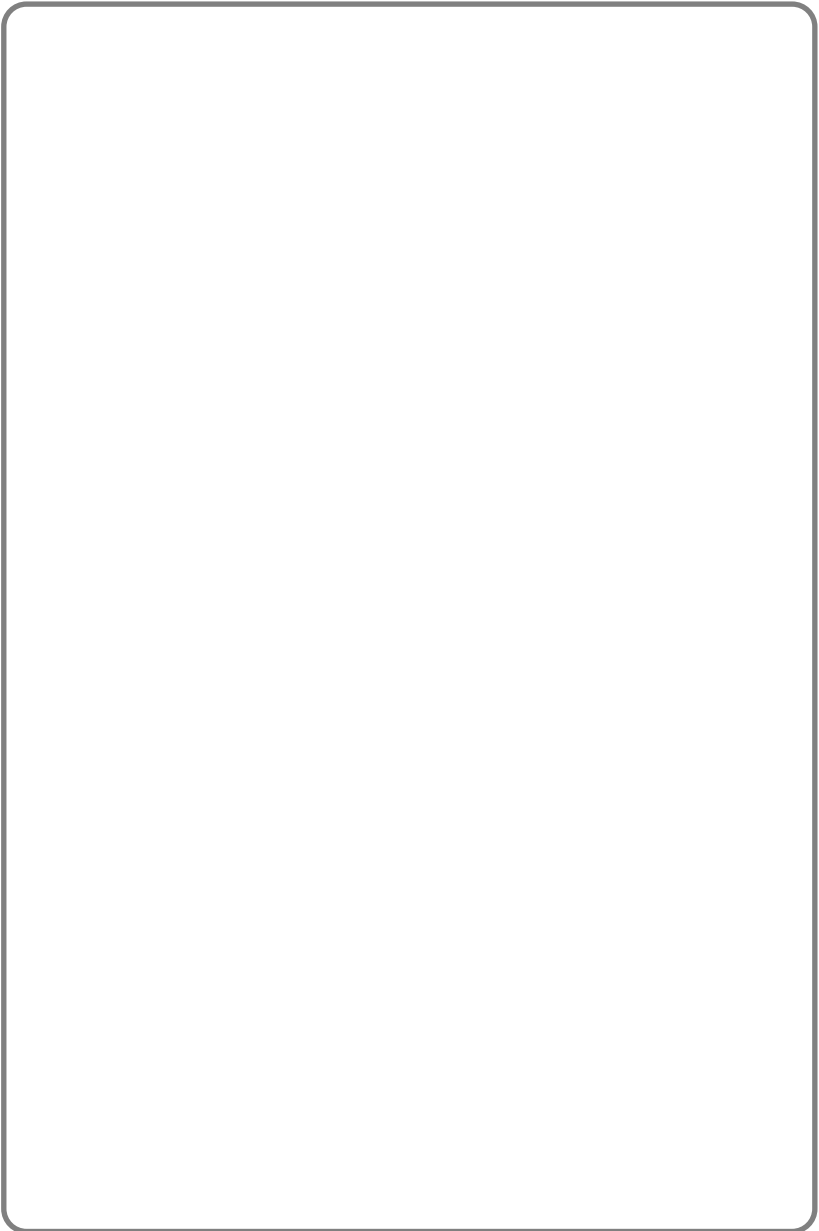

MEMO

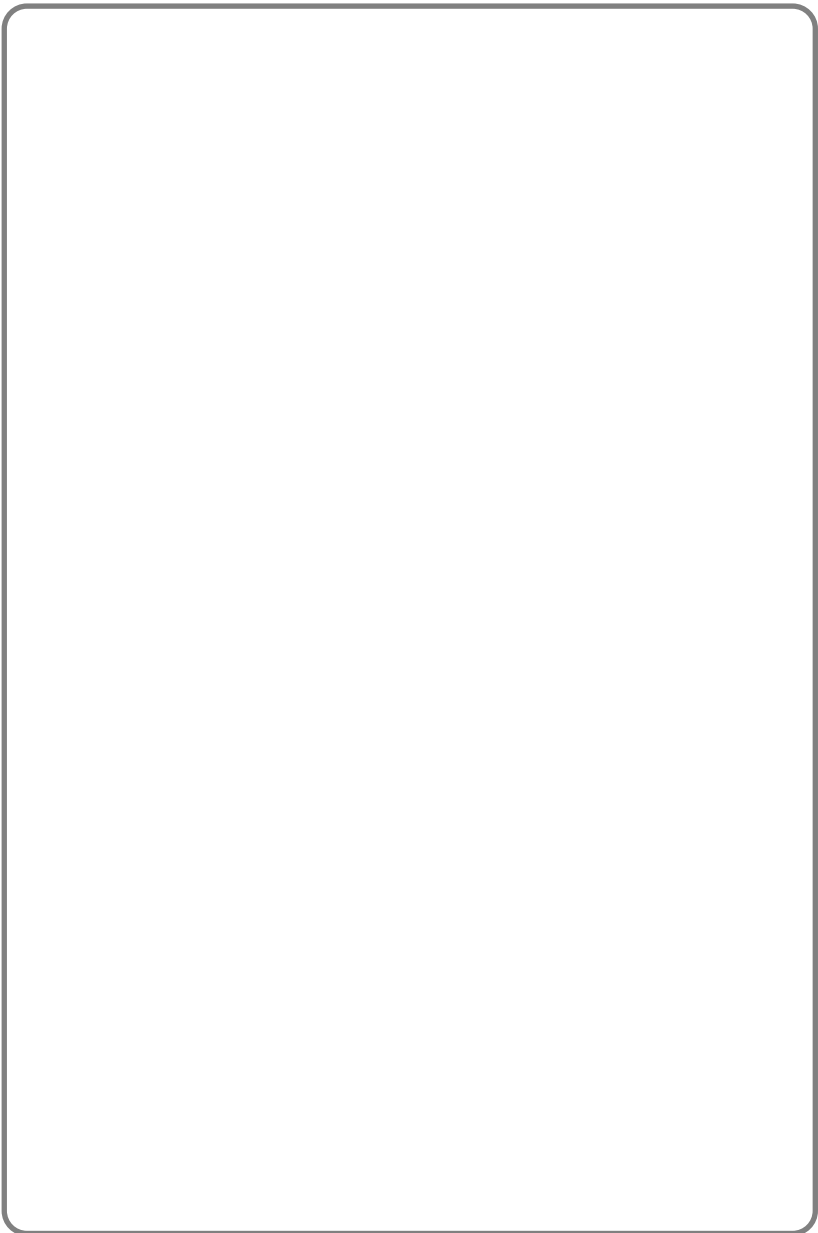

MEMO

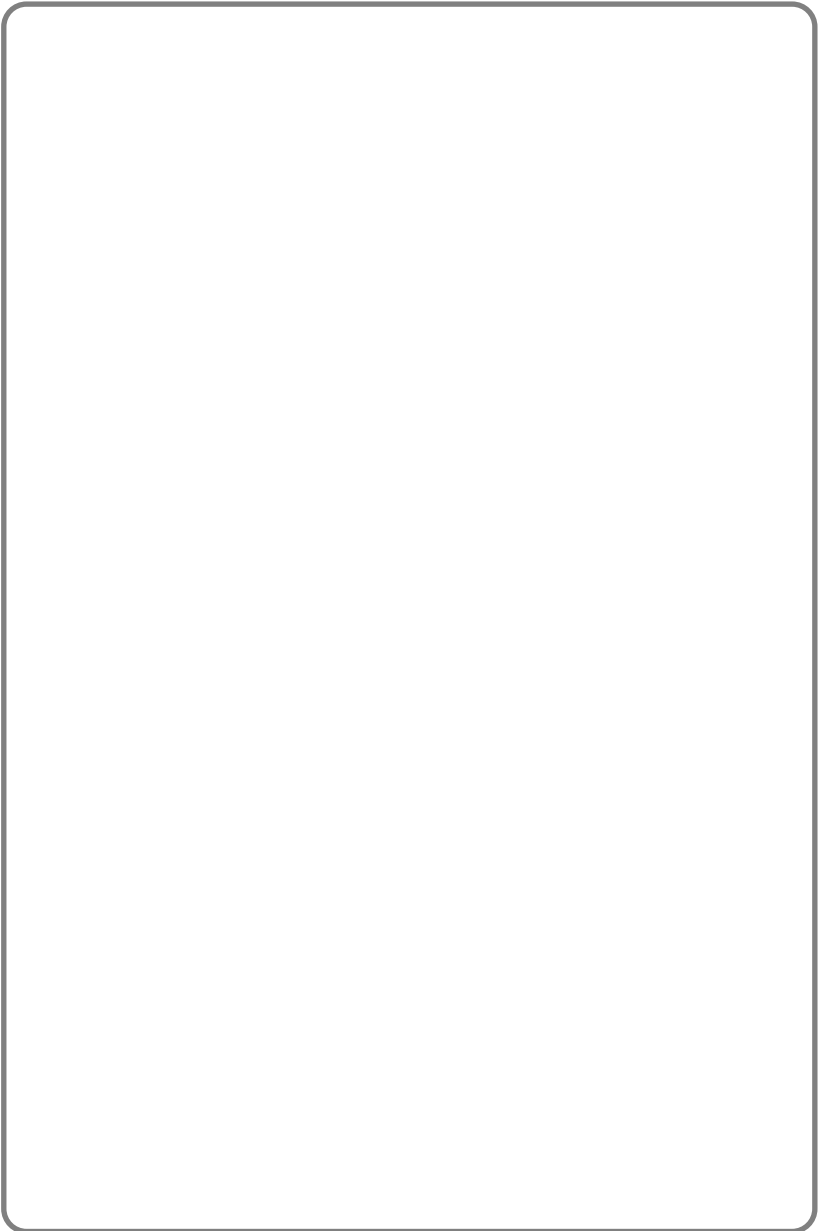



SAMSUNG

SAMSUNG TECHWIN CO., LTD.
OPTICS & DIGITAL IMAGING DIVISION
145-3, SANGDAEWON 1-DONG, JUNGWONGU,
SUNGNAM-CITY, KYUNGKI-DO, KOREA
462-121
TEL : (82) 31-740-8086,8088, 8090, 8092, 8099
FAX : (82) 31-740-8398, 8111
www.samsungcamera.com

SAMSUNG OPTO-ELECTRONICS AMERICA, INC.
HEADQUARTERS
40 SEAVIEW DRIVE, SECAUCUS, NJ07094, U.S.A.
TEL : (1) 201-902-0347
FAX : (1) 201-902-9342

WESTERN REGIONAL OFFICE
18600 BROADWICK ST.,
RANCHO DOMINGUEZ, CA 90220, U.S.A.
TEL : (1) 310-900-5263/5264
FAX : (1) 310-537-1566
www.samsungcamerausa.com

SAMSUNG OPTO-ELECTRONICS UK LIMITED
SAMSUNG HOUSE
1000 HILLSWOOD DRIVE
HILLSWOOD BUSINESS PARK
CHERTSEY KT16 OPS U.K.
TEL : 00800 12263727
(free for calls from UK only)
UK Service Hotline : 01932455320
www.samsungcamera.co.uk

SAMSUNG OPTO-ELECTRONICS GMBH
AM KRONBERGER HANG 6
D-65824 SCHWALBACH/TS., GERMANY
TEL : 49 (0) 6196 66 53 03
FAX : 49 (0) 6196 66 53 66
www.samsungcameras.de

SAMSUNG FRANCE S.A.S.
BP 51 TOUR MAINE MONTPARNASSE
33, AV. DU MAINE
75755, PARIS CEDEX 15, FRANCE
HOTLINE PHOTO NUMÉRIQUE :
00 800 22 26 37 27 (Numéro Vert-Appel Gratuit)
TEL : (33) 1-4279-2200
FAX : (33) 1-4538-6858
www.samsungphoto.fr

SAMSUNG TECHWIN MOSCOW OFFICE
RUSSIA, 125167, MOSCOW LENNINGRADSKY,
PR-KT, 37-A, KORP14
TEL : (7) 095-258-9299/96/98
FAX : (7) 095-258-9297
<http://www.samsungcamera.ru>

TIANJIN SAMSUNG OPTO-ELECTRONICS CO.,LTD.
7 PINGCHANG ROAD NANKAI DIST., TIANJIN
P.R CHINA
POST CODE:300190
TEL : (86) 22-2761-4599
FAX : (86) 22-2769-7558
www.samsungcamera.com.cn

* Internet address - <http://www.samsungcamera.com/>



The CE Mark is a Directive conformity mark of the European Community (EC)

6806-2828

Free Manuals Download Website

<http://myh66.com>

<http://usermanuals.us>

<http://www.somanuals.com>

<http://www.4manuals.cc>

<http://www.manual-lib.com>

<http://www.404manual.com>

<http://www.luxmanual.com>

<http://aubethermostatmanual.com>

Golf course search by state

<http://golfingnear.com>

Email search by domain

<http://emailbydomain.com>

Auto manuals search

<http://auto.somanuals.com>

TV manuals search

<http://tv.somanuals.com>