

SAMSUNG

SAMSUNG CAMERA

User Manual

Digital Camera

Digimax 130

Thank you for buying a Samsung Camera. This manual will guide you through using the Digimax 130, including taking pictures, downloading images and using MGI PhotoSuite software. Please read this manual before using your new camera.

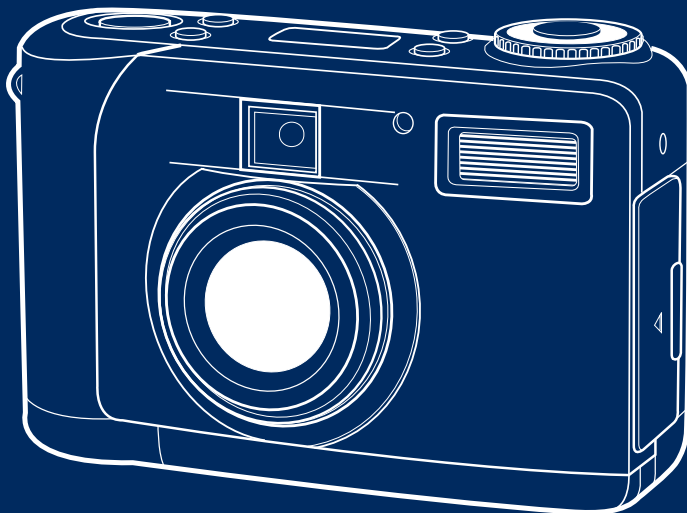

ENGLISH

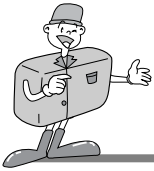

SPECIAL FEATURES

Thank you for buying a Samsung Digital Camera.
This digital camera possesses the following features.

- ▶ A high resolution of 1.3 mega pixels
- ▶ 2x digital zoom
- ▶ USB interface function
- ▶ 1.6 inch TFT LCD monitor
- ▶ 8MB internal memory and CompactFlash™ card compatible

A FCC warning

- This device has been tested in accordance with the limits of a class B digital device under item 15 of the FCC rules. These limits are designed to provide protection against harmful interference in commercial installation.

This equipment generates, absorbs and can emit radio frequency energy. If it is not installed and used in accordance with the instructions, it may cause harmful interference to radio communication.

There is however, no guarantee that interference will not occur in a some situations.

Should any interference occur when this device is in operation, please try one or more of the following measures.

- Change the location and direction of any aerial.
 - Increase distance between camera and affected device.
 - Use a different socket away from the affected device.
 - Please contact a Samsung agent or a radio/TV engineer.
- This device complies with part 15 of the FCC Rules.



MANUFACTURE'S CONTENTS

MANUFACTURE'S CONTENTS

■ Please check that you have the correct contents before using this product.

Digital camera



4 AA Alkaline
Batteries



Pouch



Application S/W,
Driver CD-ROM



User manual



Product warranty



Video cable



USB cable



Camera strap



Accessories (Optional)



AC Adapter



CompactFlash™ card
(CF CARD)

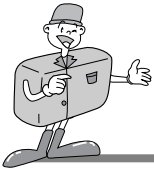

THIS DIGITAL CAMERA CAN BE USED FOR



Viewing images on TV

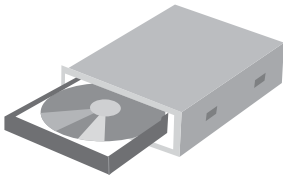

Recording images onto CD

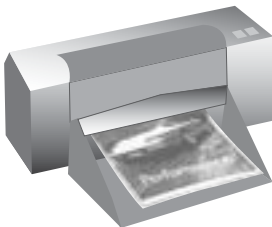

Printing images



Editing images on a PC



THIS DIGITAL CAMERA CAN BE USED FOR

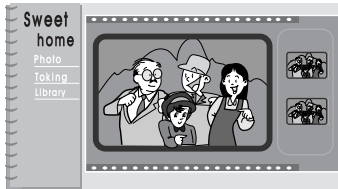

Creation of
a digital photo album



Inserting images
directly into any
electronic document

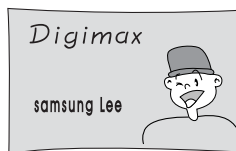

Taking a self-portrait
and using the image
to personalize name
cards

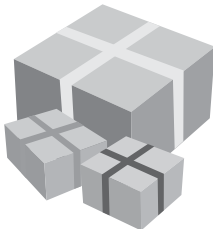

You can even create your
own unique gift-wrap paper
by using your digital images.



CONTENTS

Ready

- Getting to know your camera 7
- Safety note 8
- Identification and features 10
 - Viewfinder 12
 - LCD panel indicator 13
 - LCD menu 14
- Ready 15
 - Connecting to Power 15
 - Using the batteries 15
 - Using the AC power adapter 16
 - Inserting CF CARD 17
 - Removing CF CARD 17
 - Instructions on how to use CF CARD 18
 - Selecting the date and time 20
 - Attaching the strap 21

Basic

- Camera working mode 22
 - Now lets take a picture 22
 - Identifications and Functions 24
 - Digital zoom 26
- Instruction of camera mode 28
 - Record mode 28
 - Play mode 28
 - Set up mode 29
 - Delete mode 29
 - PC mode 29
- LED Messages 29
- Setting up the function 30
 - Setting up the function by using the LCD panel 30
 - Select the Flash mode 30

- Select the quality and the resolution mode 31
- Select the Self-timer mode 32
- Checking the battery 32

Advanced

- Setting up the function 33
 - Setting up the function by using a LCD monitor 33
 - Record mode 33
 - Play mode 37
 - Setup mode 41
 - Delete mode 47
 - PC mode 49
- Before contacting service center 50
- Specifications 51

Software

- Software manual 52
 - Please read the user manual carefully before using the camera 52
 - System requirements 53
- How to set up the software 54
 - How to set up the software 54
 - Setting up Camera Driver 55
 - Setting up the MGI PhotoSuite III SE 57
 - Setting up the MGI PhotoVista 59
- How to use editing software 61
 - MGI PhotoSuite III SE 61
 - MGI PhotoVista 74
- Setting up Camera Driver for Mac 80

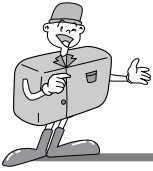

GETTING TO KNOW YOUR CAMERA

- Prior to using this camera, please read the user manual thoroughly.
- Keep the manual in a safe place.

About the image mark

This manual contains instructions on using this camera that will help you to use this camera safely and correctly. This will help prevent danger and injury to others.



Warning

This is a descriptive statement warning of the result if the instructions are ignored or not understood.



Note

This explains use of the camera, please refer to this.



Reference

This should assist further in the operation of the camera.



SAFETY NOTE



WARNING

- Do not attempt to modify this camera in any way. This may result in fire, injury, electric shock or severe damage to you or your camera. Internal inspection, maintenance and repairs should be carried out by your dealer or Samsung Camera Service Center.
- Do not use the flash in close proximity to the people or animals.
Positioning the flash too close to your subject's eyes, may cause eyesight damage.
Do not attempt to photograph children using a flash, closer than a 1 meter proximity.
- When taking photographs, never point the lens of the camera directly into very strong light.
This may result in permanent damage to the camera or your eyesight.
- Please do not use this product in close proximity to flammable or explosive gases, as this could increase the risk of explosion.
- For safety reasons keep this product and accessories out of reach of children or animals to prevent accidents e.g.:
 - Swallowing batteries or small camera accessories.
In case of accidents, please consult a doctor immediately.
 - There is a risk of permanent eye damage if the flash is operated at a distance of less than one meter from a person's eyes.
 - There is a possibility of injury from the camera's moving parts.
- Should any form of liquid enter the camera, do not use it. Switch off the camera, and then disconnect the power source (batteries or AC Power Adapter).
You must contact your dealer or Samsung Camera Service Center.
Do not continue to use the camera as this may cause a fire or electric shock.
- Turn the camera off immediately, then disconnect the power source (batteries or AC Power Adapter).
Then contact your dealer or Samsung Camera Service Center.
Do not continue to use the camera as this may cause a fire or electric shock.
- Do not insert or drop metallic or inflammable foreign objects into the camera through access points e.g. CF CARD slot and battery chamber. This may cause a fire or electric shock.
- Do not operate this camera with wet hands.
This could pose a risk of electric shock.



SAFETY NOTE



NOTE

- Do not leave this camera in places subject to extremely high temperatures, such as a sealed vehicle, direct sunlight or other places of extreme variances in temperature. Exposure to extreme temperatures may adversely affect the camera's internal components and could cause a fire.
- When in use, do not cover the camera or AC Power Adapter. This may cause heat to build up and distort the camera case or cause a fire.
- Always use the camera and its accessories in a well-ventilated area. Leakage, overheating, or burst batteries could result in fire or injury.
 - Do not short circuit, heat or dispose of batteries in fire.
 - Do not use old batteries with new ones, or mix brands of batteries.
 - Ensure the batteries are positioned correctly with regard to polarity (+ / -).
- When the camera is not in use for long periods, always unplug the camera from its power source (batteries or AC Power Adapter) for safety purposes. Leaking batteries can cause fire and pollution to the environment.
- Allowing dust to accumulate in the camera over a long period is hazardous as extreme circumstances may cause a fire. It is best to clean your camera prior to seasonal periods of high humidity. Consult your dealer or Samsung Camera Service Center for information on the cost of cleaning your camera.
- Do not move the camera while it is switched on, if you are using the AC Power Adapter. After use, always switch off the camera before unplugging the adapter from the AC Power wall socket. Then make sure that any connector cords or cables to other devices are disconnected before moving the camera. Failure to do so may damage the cords or cables and cause a fire or electric shock.

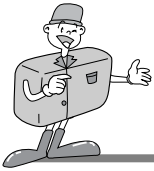

IDENTIFICATION OF FEATURES

Product Exterior (Front)

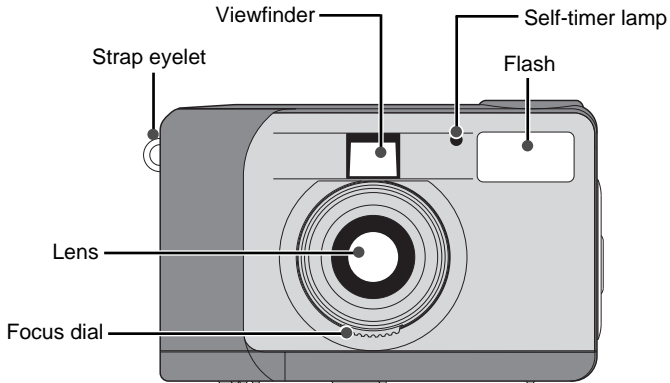

Product Exterior (Rear)

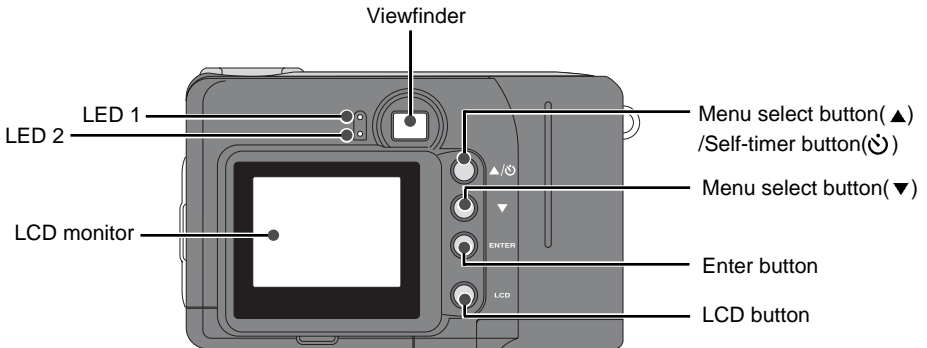



IDENTIFICATION OF FEATURES

RE
AD
Y

Product Exterior (Top/Side/Bottom)

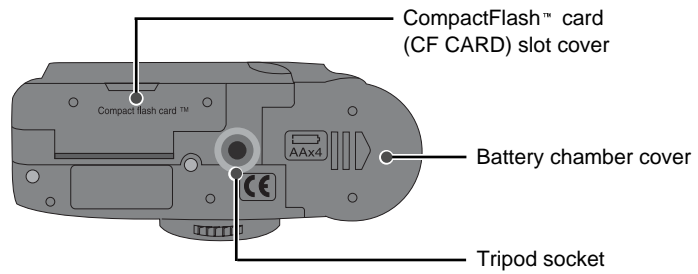
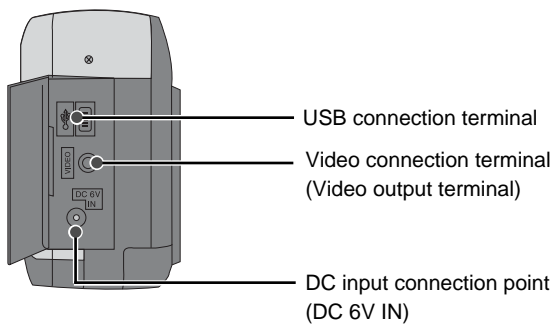
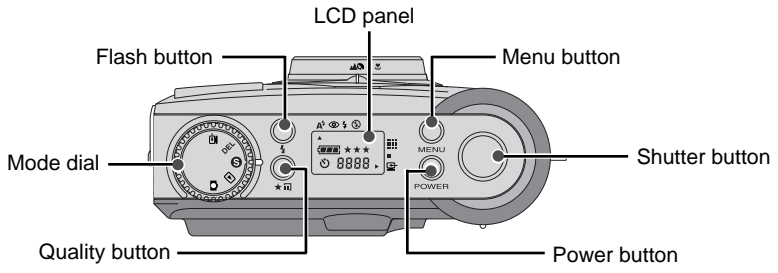

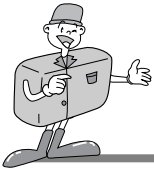

IDENTIFICATION OF FEATURES

Viewfinder

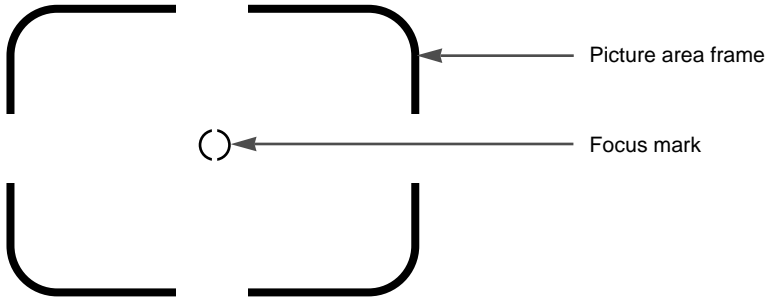

Reference

- . Vertical and Horizontal shots are taken in the same way.
- . Avoid obstructing the lens or the flash when you take a picture.
A picture can be spoiled when a finger, hair or camera strap is in front of the lens or the flash.

Note

Please use the LCD monitor when using Macro mode (0.4m–0.8m).
As there can be some differences between what is seen through the Viewfinder and the resulting image when taken at a range closer than 1.5m, it is recommended that you use the LCD monitor to compose the shot.



IDENTIFICATION OF FEATURES

LCD panel indicator

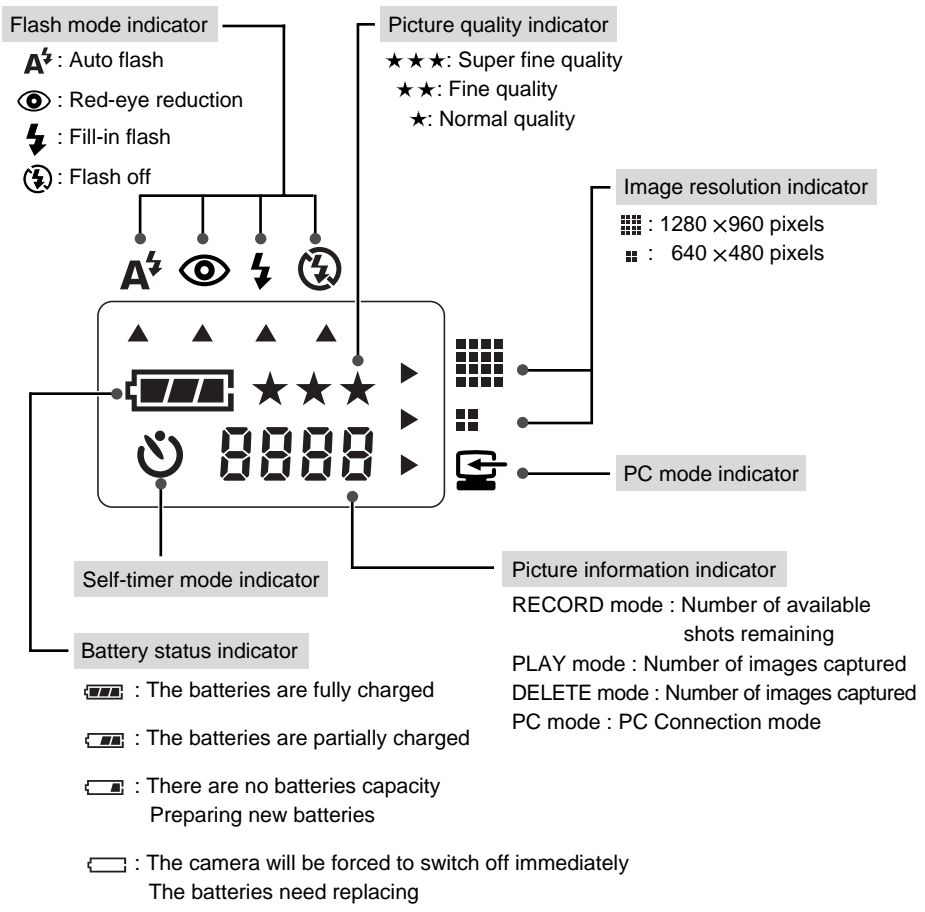



IDENTIFICATION OF FEATURES

LCD Menu

The function menu will be displayed on LCD monitor.



[RECORD Menu]

LCD BRIGHTNESS : change LCD BRIGHTNESS

QUICKVIEW: view the captured image straight away.

WHITE BALANCE : change WHITE BALANCE

EV COMPENSATION : change EV COMPENSATION

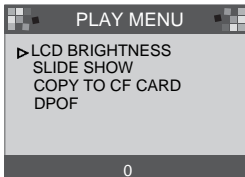

[PLAY Menu]

LCD BRIGHTNESS : change LCD BRIGHTNESS

SLIDE SHOW : view all captured image continuously

COPY TO CF CARD : copy images in the internal memory to CF CARD

DPOF : Digital Print Order Format

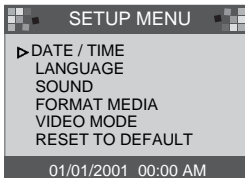

[SETUP Menu]

DATE / TIME : DATE / TIME setting

LANGUAGE : LANGUAGE setting

SOUND : buzzer sound setting

FORMAT MEDIA : formatting CF CARD or Internal memory

VIDEO MODE : change VIDEO MODE (NTSC or PAL)

RESET TO DEFAULT : change the settings to factory default settings

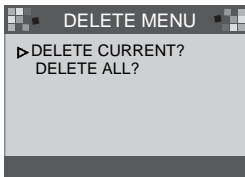

[DELETE Menu]

DELETE CURRENT? : delete current image

DELETE ALL? : delete all images

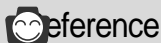

. There is no menu associated with PC mode.



READY

R
E
A
D
Y

Connecting to Power

There are two ways in which to provide the camera with power. One is using batteries (AA Alkaline), alternatively use an AC Adapter (DC 6V / 2.5A).

■Using the batteries

- 1 Open the battery chamber cover by pushing in the direction of the arrow.
- 2 Insert the batteries taking note of the polarity (+ / -).
- 3 To close the battery chamber cover, push it until it clicks.



Note

►Important information about battery usage

- Please remove the batteries if the camera will not be used for long periods.
- Batteries can lose power over time and are prone to leak if kept inside the camera.
- Do not use manganese batteries as they cannot deliver sufficient power.
- Low temperatures (below 0°C) can cause the camera to work for a shorter period of time due to reduced battery performance. The batteries will recover at normal temperatures.
- Do not use old and new batteries or different types together.
- Extended use of the camera may cause the camera body to become warm. This is perfectly normal.

If you are planning to use this camera for long periods of time, it is advisable to use an AC adapter.

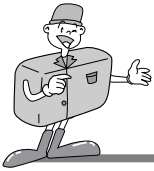

READY

■ Using the AC power adapter

- If you have access to a main supply, using an AC Adapter allows the camera to be used for long periods of time. If you connect the camera to a computer, it is advisable to use an AC adapter rather than the camera's battery, as this will enable extended use.
- Plug the adapter into the connection point (DC 6V IN) on the camera. Please ensure that you use an AC adapter with the correct specification for the camera.
- Failure to do so may affect your warranty.



WARNING

- Always turn off the power before taking the AC adapter out of the main supply.
- Keep the metallic part of camera away from any metallic material to prevent fatal damage.

■ Auto power off in each mode

- This camera will automatically switch off when not in use for a period time.

Mode	Auto power off
RECORD mode	3 Minutes
PLAY mode	3 Minutes (excluding SLIDE SHOW)
SETUP mode	3 Minutes
DELETE mode	3 Minutes
PC mode	X



READY

R
E
A
D
Y

Inserting CF CARD

■ If your camera doesn't have enough space for image storage, insert a CF CARD.

- 1 Pull the card cover in the direction of the arrow to open.
- 2 Insert the card towards the arrow.
The front side of the CF CARD (red arrow printed) and front side of camera should face the same direction when card is inserted.



- 3 To close the CF CARD cover, push the CF CARD cover in the opposite direction of the arrow until you hear a click.

Removing CF CARD

- 1 Turn the power off using the power button.
- 2 Push the Card eject lever (ⓘ) down.
- 3 Remove CF CARD as shown in the picture.



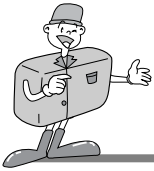

READY



Reference

- When using an 8MB internal memory, the specification/shooting capacity will be as follows. This is based on the conditioning standard of our company.

Image resolution	Recorded picture quality	File format	Number of shots
L (1280 × 960 pixels)	Super fine quality	. J P G	16 ±1
	Fine quality	. J P G	24 ±1
	Normal quality	. J P G	48 ±2
S (640 × 480 pixels)	Super fine quality	. J P G	33 ±2
	Fine quality	. J P G	66 ±2
	Normal quality	. J P G	134 ±4

※ The number of normal shots can vary according to the picture content.

Instructions on how to use CF CARD

■ Using a new CF CARD for the first time

- Before using the CF CARD, it must be initialized.
- Initializing prepares the CF CARD for recording data.
- For more details, please refer to the page 44 (FORMAT MEDIA).



Note

- If used over extended periods, a CF CARD may deteriorate and its performance may be impaired. If this occurs, it is best to replace with a new CF CARD.
Should this be the case, you will need to purchase a new CF CARD.
- Always turn the power off when replacing the CF CARD.



READY

■ Preserving the CF CARD data

- If the card is subjected to any of the following, the recorded data may become corrupted:
 - When the CF CARD is used incorrectly.
 - If the power is switched off while initializing, reading or removing the CF CARD.
- It is advisable to copy important data onto other media as back-up e.g. floppy disks, hard disks etc.
- Samsung cannot be held responsible for lost data.



Note

Important information whilst using the CF CARD

- When a CF CARD is inserted, the camera only operates using the CF CARD. So, in RECORD mode, the images only store in CF CARD and, in PLAY mode, you can only view the images from the CF CARD.
- If you switch off the camera while it is reading, initializing or playing, the information on the CF CARD may be corrupted.
- The CF CARD is an electronic precision device.
 - Do not bend, drop or subject the card to any heavy impact.
- Do not store the CF CARD in an environment with strong electronic or magnetic fields, e.g. near loud speakers or TV receivers.
- Please do not use or store in an environment where there are extremes of temperature.
- Do not allow the CF CARD to come into contact with dirt.
 - Should this happen, clean the dirt off with a soft cloth.
- Please keep the CF CARD in its case when not in use.
- During and after periods of extended use, you may notice that the CF CARD is warm. This is perfectly normal.

※ CompactFlash™ card, CF CARD is the registered trademark of Sandisk.

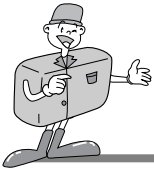

READY

Selecting the date and time

■ You can record the date and time with the image data in the memory card when you take a picture.

Please select the date and time when you use the camera for the first time or when the batteries have been removed from the camera for over 60 seconds.

- 1 Turn on the power by pressing the Power button.
- 2 Switch to SETUP mode, and the SETUP menu will then be displayed.
- 3 Select DATE/TIME by pressing Menu select button (▲/▼)
- 4 Press Enter button, and the cursor will skip to the data field.
The first item (Month) in this field will be selected.
- 5 Press Enter button to proceed to the next item.
- 6 Use Menu select buttons(▲/▼) to change the numbers.
- 7 Repeat 5,6 to change the date or time.
- 8 When the last item is selected/changed, press the Enter button to return to the SETUP menu.

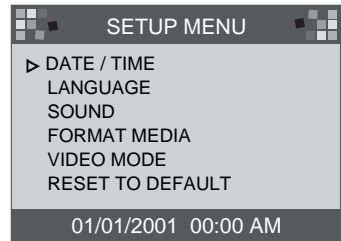



READY

R
E
A
D
Y



Reference

- The date is indicated as below

01	/	01	/	2001	00	:	00	AM (PM)
↑		↑		↑	↑		↑	↑
month		day		year	hour		minute	AM (PM)

- The selection range for date/time setup covers from 2001 – 2099.
(It is automatically programmed to allow for a leap year/ month)
- It is originally set as [01/01/2001 00:00 AM].
- If 1 minute passed where the camera did not have batteries in it, you will need to check date/time.

Attaching the strap

To prevent accidental damage to the camera, always use the strap.

■ Refer to the illustrations below



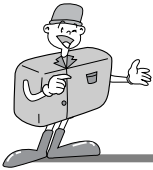

CAMERA WORKING MODE

Now let's take a picture



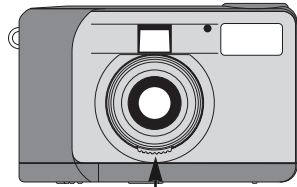
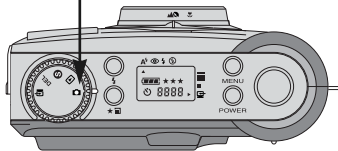

■ If the internal memory is full, insert a CF CARD.

- 1 Turn the power on.
 - The beep is activated whenever the power is turned on.
 - Should the color of the condition indicator lamp(LED1) next to the viewfinder be red, it means that the camera is booting up. When it changes to green, the camera is ready for use.
- 2 Turn the Mode dial to RECORD mode ().

RECORD mode



Focus dial

- 3 Select the desired mode(macro or portrait/landscape) by turning the Focus dial.
 - Landscape / Portrait ( ): 0.8 m ~ infinity
 - Macro (): between 0.4 m ~ 0.8 m
- 4 Select the desired image quality and resolution on the LCD panel with the Quality button ( ).
- 5 Using the LCD monitor , you can set the function in detail.
Refer to page 33-48 of the user manual for setting up function using the LCD monitor.



CAMERA WORKING MODE

Now let's take a picture

- 6 Use the viewfinder or LCD monitor to frame your shot.
 - Turn the LCD button on to use the LCD monitor.

- 7 When taking pictures, squeeze the Shutter button gently to prevent camera shake.
 - If you press the Shutter button down fully, the picture will be taken and the data that makes up the picture, will be stored in the internal memory or CF CARD.
 - The LED will blink red while the images are being captured and stored.



Reference

- ▶ If there is insufficient memory available,
 - The [0000] mark will be displayed on the LCD panel.
 - If you press the Shutter button, the following message will be displayed and the warning sound for low card storage capacity will be heard as two short "beeps".

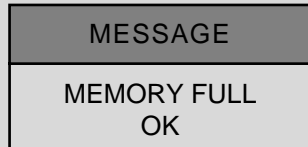

- Press the Enter button to remove the message.
- To extend the amount of memory on the camera, replace the CF CARD or delete unnecessary images stored on the internal memory or CF CARD.



Note

- ▶ We cannot guarantee the quality of pictures, should they be taken under certain circumstances:
 - If the subject is highly reflective or shiny.
 - If the subject is moving at high speed.
 - When there is strong reflected light, or when the background is very bright.

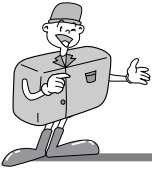

CAMERA WORKING MODE

Identifications and Functions

► Power button (POWER)

Press the Power button to turn the camera ON/OFF.

If the camera is turned on and no buttons are pressed, or if there is no host communication with it for 90 seconds, the LCD panel and LCD monitor will automatically be turned off to conserve battery power. The camera will be in standby mode and if any buttons are pressed or the Mode dial is rotated during this time, the camera will be in normal mode again immediately.

Should the camera not be in use for 3 minutes or more, the system will switch itself off and the Power button will need to be pressed to turn the camera back on.

The AC adapter and the batteries each have the same settings as mentioned above.

► Menu button (MENU)

The Menu button is only active in RECORD mode and PLAY mode.

Press the Menu button to turn on the RECORD menu and PLAY menu.

To turn off the menu, press the Menu button again.

► Shutter button

Press the button in RECORD mode for image capturing, processing and storing.

Before taking a shot, please ensure that your camera has sufficient storage capacity and that there is appropriate light for successful image capture.

By pressing the Shutter button on PLAY mode, the DPOF setting will change.

For more information about DPOF, refer to page 40.

► Flash button ()

The Flash mode can only be set under RECORD mode.

There are 4 modes available: Auto flash, Red-eye reduction, Fill-in flash and Flash off.

► Quality button ()

The image quality and resolution can only be set under RECORD mode.

This camera provides 6 different image resolution & quality combination settings.



CAMERA WORKING MODE

Identifications and Functions

► Menu select button (▲/▼)

Use the Menu select button when you wish to select the menu for each mode.

► Self-timer button (⏱)

The Self-timer button is active only in RECORD mode.

When the Self-timer button is pressed, the 10-second Self-timer is enabled.

The image will be captured 10 seconds after you have pressed the Shutter button.

After taking the picture, the Self-timer mode will be disabled.

. To cancel the Self-timer function, do any of the following:

- Press the Self-timer button again.
- Power off the camera.
- Change to another mode excluding RECORD mode.
- The camera automatically disables the Self-timer function after an image is captured.

► Enter button (ENTER)

The Enter button is active at any time when a menu or dialog box is displayed.

Use the button to select/confirm the currently highlighted item.

► LCD button (LCD)

The LCD button is only active in RECORD mode and PLAY mode.

While in RECORD mode, pressing the LCD button will enable the LCD monitor to be turned

On or Off. In PLAY mode, press the LCD button to preview the images.



Note

Extensive use of the LCD monitor to view a potential picture will drain the batteries in a short period of time. To safeguard against this, it is advisable to use the optical viewfinder.

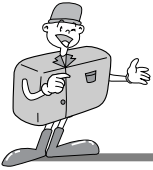

CAMERA WORKING MODE

Digital zoom

- You can take an extended picture (2x ZOOM) on RECORD mode by pressing LCD button and Enter button successively.
Extended (2x ZOOM) image stores as 640 x 480 pixels.
But, you must set the image resolution to 1280 x 960 pixels to take an extended (2x ZOOM) picture.
- There is a 2x and 4x Digital zoom available in PLAY mode.
 - Enter button: In PLAY mode, to use the Digital zoom, press the Enter button and the image will be magnified. The magnification rate will be changed by pressing the Enter button as 2x, 4x.
 - Menu select button: In PLAY mode to scroll through the images, use the Menu select button. However, in Digital zoom mode, the Menu select button will highlight the various images.

The zoom indicator and magnification number shown in the upper and lower left side, indicates the zoom position and magnification.





CAMERA WORKING MODE

■1 image screen play mode

- 1 Turn the power on.
- 2 The most recent image captured will be shown when the Mode dial is set to PLAY mode.
- 3 Use the Menu select button (▲/▼) to browse the captured images.
 - In single image display, press the Enter button once to view the extended image(2x Zoom) and press the Enter button twice to view an even more extended image(4x Zoom). By pressing the Enter button 3 times, the extended image will return to its initial image size. For more information refer to page 26.



[1 image screen play mode]



[Thumbnail play mode]

■Thumbnail play mode

- 1 Turn the power on.
- 2 The most recent image captured will be shown when the Mode dial is set to PLAY MODE.
- 3 Press LCD button once to display image size, date and time information on the LCD monitor. Press LCD button again to view images in Thumbnail mode.
- 4 Press the Menu select button to select an image.
- 5 Pressing the Enter button will extend the image.

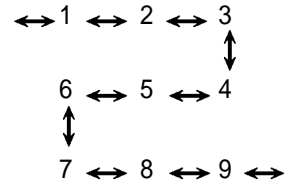

[Image sequence]



CAMERA WORKING MODE

Instruction of camera mode

- You can select the appropriate mode by using the Mode dial located at the top of the camera.

This digital camera has 5 working modes, which are listed below.

▶ RECORD mode ()

This mode is used for taking pictures.

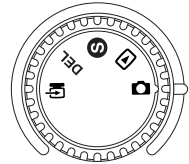

In this mode, LCD BRIGHTNESS, QUICKVIEW, WHITE BALANCE, EV COMPENSATION settings can be changed.

The images are stored on the internal memory or CF CARD.



- You should set the Focus dial before taking a picture.

There are 2 kinds of focus modes that can be selected by switching the Focus dial.

Landscape / Portrait ( ) : For a normal / long distance shot
Focusing range : 0.8m ~ infinity

Macro () : For a macro shot
Focusing range : 0.4m ~ 0.8m

Note

- When making a Macro shot, you will need to use a tripod to avoid camera shake.
- Please use the LCD monitor when using Macro photography(0.4m~0.8m).
- When shots are taken of a subject within a range of 1.5m, there can be some differences between the result and what you viewed through the optical viewfinder. It is therefore recommended in these instances that pictures are composed using the LCD monitor.

▶ PLAY mode ()

In this mode, the images stored on the CF CARD or internal memory can be viewed on the LCD monitor on the back of the camera, or on an external monitor using a video output terminal.

You can set SLIDE SHOW, LCD brightness and DPOF settings.



CAMERA WORKING MODE

- ▶ SET UP mode (**S**)
DATE/TIME, LANGUAGE, SOUND, FORMAT MEDIA, VIDEO MODE and RESET TO DEFAULT settings can be changed.
- ▶ DELETE mode (**DEL**)
In this mode you can delete images in the internal memory or CF CARD.
In DELETE mode, the recorded images can be deleted all at once, or singularly.
- ▶ PC mode (**PC**)
In this mode, images stored on the internal memory or CF CARD can only be transferred via USB cable.

LED Messages

■ LED status is situated next to the viewfinder.

LED	Color	Status	Instruction
LED1	Red	BLINKING	Busy detecting a system error
	Green	ON	When Power is on
	Red	BLINKING	Image processing (Compression/Decompression/Download)
LED2	Green	ON	CF CARD is inserted
	Green	OFF	CF CARD is not inserted

■ Front side, Self-timer lamp

Self-timer lamp	Red	BLINKING	Self-timer is in operation
	Red	ON	Self-timer button has been pressed



SETTING UP THE FUNCTION

Setting up the function by using the LCD panel

Select the Flash mode

- The flash mode can only be set under RECORD mode.
- There are 4 modes available: Auto flash, Red-eye reduction, Fill-in flash and Flash off.

The default setting is Auto flash.

- Use the flash mode that is best suited for the environment.

To change the setting, press the Flash mode button until the desired mode is highlighted.

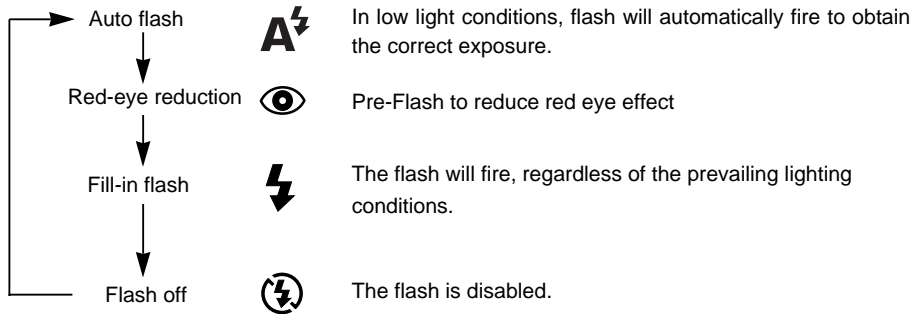

Note

- When a subject is closer than 1m there will be an additional exposure (2~3times) to ensure the correct lighting levels. Please do not move until the main flash fires.
- Using the flash frequently will reduce the life of the batteries.
 - Under normal operating conditions, the charging time for the flash is normally under 10 seconds. If the batteries are weak, the charging time will be longer.
 - If you take a outdoor photography or the subject is in shady place, set the flash mode Fill-in flash to get a good result.
- If you take a picture in dark place and the flash mode is off, LOW LUMINANCE message will display on the LCD monitor. In addition, it may cause the camera to lock the Shutter automatically. In this case, set the flash mode to Auto flash and take a picture again.



SETTING UP THE FUNCTION

Setting up the function by using the LCD panel

Select the quality and the resolution mode

- Image quality and resolution can only be set under RECORD mode.
- This camera provides 6 different image resolution & quality combination settings.
- The default setting is [1280X960 pixels] resolution() , at the Super fine quality(★★★).
- To change the setting, press the Quality button a number of times until the desired one is selected.

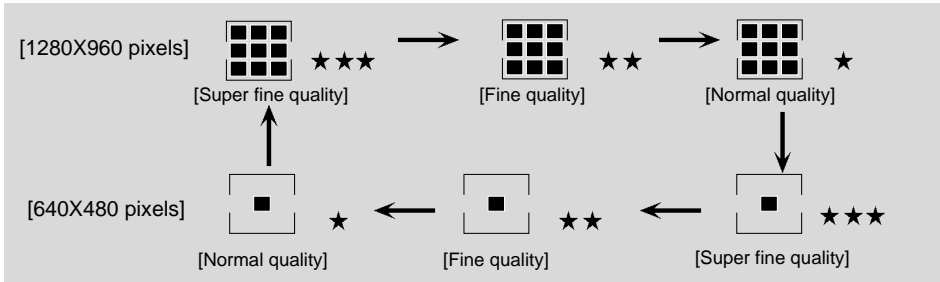

- The setting is maintained even if the camera power is off.

■Image Resolution Indicator

- RECORD mode : Indicates the resolution setting of the captured image.
- PLAY mode : Shows the resolution of the image currently displayed.

■Image Quality Indicator

- RECORD mode : Shows the quality setting of the captured image.
- PLAY mode : Shows the quality of the image currently displayed.



Reference

- The resolution and quality shown on the LCD panel indicates the resolution and quality of the picture about to be taken. The resolution and quality stored in the CF CARD or internal memory cannot be changed once an image has been captured.



SETTING UP THE FUNCTION

Setting up the function by using the LCD panel

Selecting the Self-timer mode

- This function is used when the photographer would also like to be in the picture.
The Self-timer mode can only be set under RECORD mode.

- 1 Press the Self-timer button() to activate it.
- The Self-timer lamp(red) is turned on.
- 2 Press the Shutter button to activate.
- 3 When you press the Self-timer button, the Self-timer lamp blinks slowly for 7 seconds.
The lamp will blink rapidly for a further 3 seconds before the picture is taken.

Checking the battery

Refer to page 13.



SETTING UP THE FUNCTION



Setting up the function by using the LCD monitor

RECORD Mode

Press the Menu button in RECORD mode, the Record menu will be displayed.

■LCD BRIGHTNESS

Changes the brightness setting of the LCD monitor.

- 1 Turn the power on.
- 2 Set the camera to RECORD mode ().
- 3 By pressing the Menu button, the RECORD menu will be displayed on the LCD monitor.
- 4 Use the Menu select button () to select LCD BRIGHTNESS setting.
- 5 Press the Enter button and the cursor will skip to the data field.
- 6 Use the Menu select button () to increase/decrease the LCD BRIGHTNESS.
 - . Brightness setting : -5 ~ +5, Interval = 1
 - . Default setting is 0.
- 7 Press the Enter button again to make the change.
 - . The cursor returns to the RECORD menu automatically when the change has been made.
- 8 Press the Menu button again to make the RECORD menu disappear.

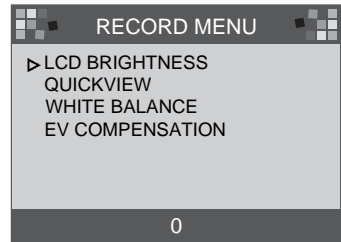

The setting is saved even if the camera power is off .

In PLAY mode, the same setting is applied.







SETTING UP THE FUNCTION

Setting up the function by using the LCD monitor

■ QUICKVIEW

If QUICKVIEW is selected, you can view the most recently captured image immediately on the LCD monitor.

- 1 Turn the power on.
- 2 Set the camera to RECORD mode ().
- 3 By pressing the Menu button, the RECORD menu will be displayed on the LCD monitor.
- 4 Use the Menu select button ( / ) to select QUICKVIEW setting.
- 5 Press the Enter button and the cursor will go to the data field.
- 6 Use the Menu select button ( / ) to select the data (ON, OFF).
 - The default setting is ON.
- 7 Press the Enter button again to make the change. The cursor returns to the RECORD menu automatically when the change has been made.
- 8 Press the Menu button again to make the RECORD menu disappear.

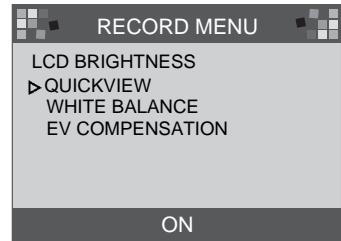



SETTING UP THE FUNCTION

Setting up the function by using the LCD monitor

■ WHITE BALANCE

The color of the image may alter according to lighting conditions during shooting. By using this function, you will be able to obtain more naturally colored images.

- 1 Turn the power on.
- 2 Set the camera to RECORD mode ().
- 3 By pressing the Menu button, the RECORD menu will be displayed on the LCD monitor.
- 4 Use the Menu select button () to select WHITE BALANCE setting.
- 5 Press the Enter button and the cursor will skip to the data field.

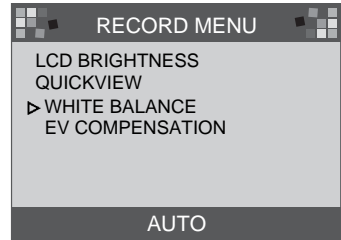

- 6 Use the Menu select button () to select WHITE BALANCE setting (Auto, Sun, Shade, Fluorescent, Tungsten).
 - The default setting is AUTO.
- 7 Press the Enter button again to make the change.
 - The cursor returns to the RECORD menu automatically when the change has been made.
- 8 Press the Menu button again to make the RECORD menu disappear.

This setting is reset to AUTO when the camera power is off.



SETTING UP THE FUNCTION

Setting up the function by using the LCD monitor

■EV COMPENSATION

This camera will automatically control the exposure value and you can select exposure compensation.

- ▶ If you increase(+) the exposure, you will obtain a brighter image.
- ▶ If you decrease(-) the exposure, you will obtain a darker image.

- 1 Turn the power on.
- 2 Set the camera to RECORD mode ().
- 3 By Pressing the Menu button, the RECORD menu will be displayed on the LCD monitor.
- 4 Use the Menu select button to select EV COMPENSATION setting.
- 5 Press the Enter button and the cursor will skip to the data field.
- 6 Use the Menu select button to select data.
The exposure compensation is over a range of -1.8 to +1.8 EV in steps of 0.3 EV.
The default setting is 0.0
- 7 Press the Enter button again to make the change.
The cursor returns to the RECORD menu automatically, when the change has been made.
- 8 Press the Menu button again to make the RECORD menu disappear.
This setting is reset to 0.0 when the camera power is off.

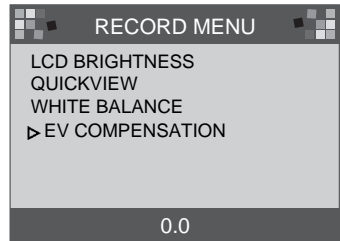

Note

- RECORD mode : Although EV is changed, the image on the LCD monitor will not be changed.
- PLAY mode : You can view EV changed image on the LCD monitor.



SETTING UP THE FUNCTION

Setting up the function by using the LCD monitor

PLAY mode

Press the Menu button in PLAY mode, the PLAY menu will be displayed.

■LCD BRIGHTNESS

Refer to page 33.

■SLIDE SHOW

This displays the recorded images in sequence, with a user-defined delay time in between 2 and 10. The power (battery, or AC power) will continue until the slide show is finished.

After finishing the SLIDE SHOW, the auto power off system will be applied.

If running time of the SLIDE SHOW is over 30 minutes, the auto power off system will be applied.

- 1 Turn the power on.
- 2 Set the camera to PLAY mode.
- 3 By pressing the Menu button, the PLAY menu will be displayed on the LCD monitor.
- 4 Use the Menu select button (▲/▼) to select SLIDE SHOW.
- 5 Press the Enter button and the cursor will skip to the data field.
- 6 Use the Menu select button (▲/▼) to select data.
 - The delay is between 2 and 10 seconds in increments of 2 seconds.
 - The default setting is 2.





SETTING UP THE FUNCTION

Setting up the function by using the LCD monitor

- 7 Press the Enter button again to make the change.
- 8 The SLIDE SHOW will start.
 - If you want to stop the SLIDE SHOW, press one of the following buttons :
LCD button, Menu button, Enter button and Menu select button
and camera turns to PLAY mode.

This setting is reset to 2 minutes when the camera power is off.



Reference

- When the SLIDE SHOW starts without images on the internal memory or CF CARD, the following message will appear.

MESSAGE

NO IMAGES



SETTING UP THE FUNCTION

Setting up the function by using the LCD monitor

■ COPY TO CF CARD

Copy the recorded images on the internal memory to CF CARD.

- 1 Turn the power on.
- 2 Set the camera to PLAY mode.
- 3 By pressing the Menu button, the PLAY menu is displayed on the LCD monitor.
- 4 Use the Menu select button to select COPY TO CF CARD.
- 5 Press the Enter button and the cursor will skip to the data field.
- 6 Use the Menu select button to select data.
 - When you press the Enter button after selecting YES [message 1] will be displayed on the LCD monitor and [message 2] will be displayed after copy has been completed. Press the Enter button and the cursor will return to the PLAY menu automatically.
 - Press the Enter button after selecting NO and the cursor will return to the PLAY menu automatically.
- 7 Press the Menu button again to make the PLAY menu disappear.

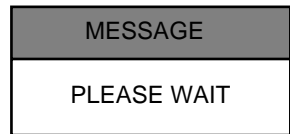
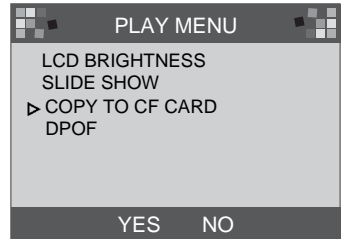

[message 1]



[message 2]



Note

A NO CARD message will be displayed on the LCD monitor and the camera will make beep sounds when you press Enter button after selecting YES, should the CF CARD not have been inserted.

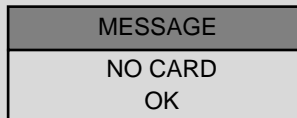

Should this be the case, press the Enter button and turn the power off. Then insert the CF CARD and repeat 1-6.



SETTING UP THE FUNCTION

Setting up the function by using the LCD monitor

■DPOF(Digital Print Order Format)

- If you are using a printer that supports DPOF, you will be able to print the captured image from CF CARD.
- A NO CARD message will display on the LCD monitor if a CF CARD is not inserted.
- Only images stored on the CF CARD can be printed.

■**PRINT QUANTITY** : setting PRINT QUANTITY. Default setting is 1.

■**PRINT SIZE** : setting PRINT SIZE. Default setting is PRINT STD.

■**PRINT INDEX** : print images on a page as THUMBNAI LS.
Default setting is ON.

■**PRINT ENABLE** : set up DPOF.

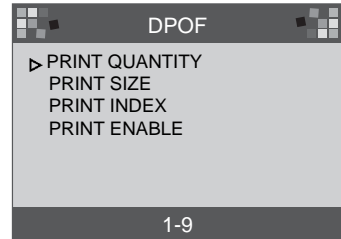

Note

- When you change each item of DPOF, set up PRINT ENABLE as ENABLE. Otherwise the DPOF setting is discarded.
- By pressing the Shutter button on PLAY mode, the DPOF setting will be changed.
 - Some printers support DPOF QUANTITY only.



SETTING UP THE FUNCTION

Setting up the function by using the LCD monitor

SETUP mode

You can set up the items (DATE/TIME, LANGUAGE, SOUND, FORMAT MEDIA, VIDEO MODE, RESET TO DEFAULT).

■ DATE / TIME

The date and time can be selected.

This will allow you to put the date and time on your data.

Refer to page 20 for more information.

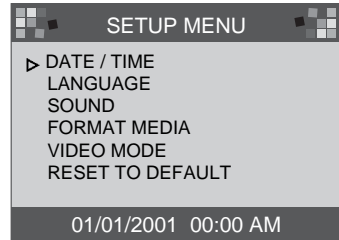

Note

- The date/time that is displayed on the LCD monitor does not print onto the images when printed or viewed by the image viewer. To print date/time onto the images, please use an image processing program such as PhotoSuite.

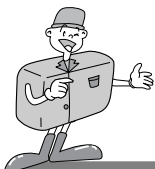

SETTING UP THE FUNCTION

Setting up the function by using the LCD monitor

■ LANGUAGE

There are 7 languages available for your selection.

- 1 Turn the power on.
- 2 Set the camera to SETUP mode and the SETUP menu will be displayed on the LCD monitor.
- 3 Use the Menu select button to select a LANGUAGE setting.
- 4 Press the Enter button and the cursor will skip to the LANGUAGE data field. Use the Menu select button to select a LANGUAGE. The default setting is ENGLISH.

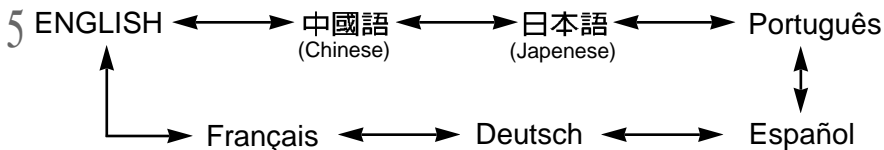
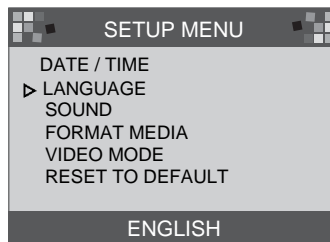

- 6 Press the Enter button again to make the change and the cursor will automatically return to the SETUP menu.

The setting is saved even if the camera power is off.



SETTING UP THE FUNCTION

Setting up the function by using the LCD monitor

■SOUND

You can select whether or not the beep sound is activated.

- 1 Turn the Power on.
- 2 Set the camera to SETUP mode and SETUP menu will be displayed on the LCD monitor.
- 3 Use the Menu select button (▲/▼) to select SOUND setting.
- 4 Press the Enter button and the cursor will skip to the SOUND data field.
- 5 Use the Menu select button to select data (ON, OFF).
 - The default setting is ON.
 - Press the Enter button again after selecting ON and the cursor will return to the SETUP menu automatically. The SOUND is set to ON.
 - Press the Enter button again after selecting OFF and the cursor returns to the SETUP menu automatically. The SOUND set off.

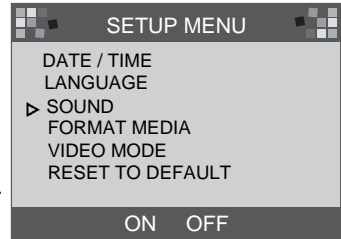

The setting is saved even if the camera power is off.

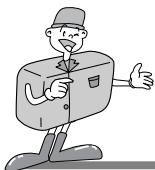

SETTING UP THE FUNCTION

Setting up the function by using the LCD monitor

■FORMAT MEDIA

Formats the CF CARD or internal memory.

- 1 Turn the power on.
- 2 Set the camera to SETUP mode and the SETUP menu will be displayed on the LCD monitor.
- 3 Use the Menu select button (▲/▼) to select FORMAT MEDIA.
- 4 Press the Enter button and the cursor will skip to the FORMAT MEDIA data field.
- 5 Use the Menu select button (▲/▼) to select data (YES , NO).
 - The default setting is NO.
 - To format the CF CARD or internal memory, Select YES and press Enter button. The message [ARE YOU SURE ?] will be displayed to confirm FORMAT MEDIA.
- 6 Select YES and press the Enter button.

The cursor will return to the SETUP menu automatically.

 - After selecting NO, press the Enter button to discard FORMA MEDIA. The cursor will then return to the SETUP menu automatically.

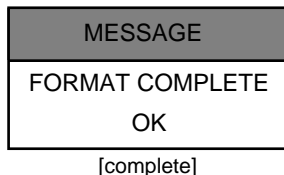
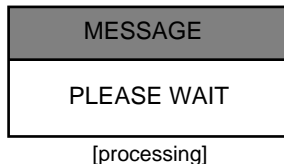
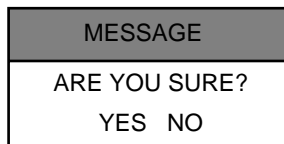
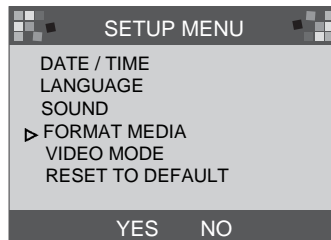

Reference

- You must format the CF card in the following circumstances:
 - the CF CARD is not initialized.
 - the CF CARD is not recognized by the camera.



SETTING UP THE FUNCTION

Setting up the function by using the LCD monitor

■VIDEO MODE

- You can set up the Video output signal from the camera in NTSC or PAL, depending on the type of device (monitor or TV, etc.) to which it is being connected.
 - Select the correct video output for the device that is to be connected.
 - The LCD monitor of camera will automatically switch off when the camera is connected to an external monitor.
- ▶ The information on the external screen will be exactly the same as on the LCD monitor.
Refer to page 37~40.

- 1 Turn the power on.
- 2 Set the camera to SETUP mode and the SETUP menu will be displayed on the LCD monitor.
- 3 Use the Menu select button (▲/▼) to select VIDEO MODE.
- 4 Press the Enter button and the cursor will skip to the VIDEO MODE data field.
- 5 Use the Menu select button to select data (NTSC, PAL).
The default setting is NTSC.
- 6 Press the Enter button again to make the change and the cursor will automatically return to the SETUP menu.

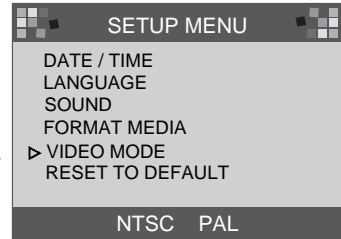

Note

- Video mode is only available in PLAY mode.

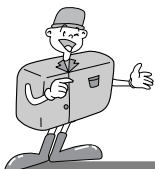

SETTING UP THE FUNCTION

Setting up the function by using the LCD monitor

■ RESET TO DEFAULT

returns all the camera settings to the factory default settings.

- 1 Turn the power on.
- 2 Set the camera to SETUP mode and SETUP menu will be displayed on the LCD monitor.
- 3 Use the Menu select button (▲/▼) to select RESET TO DEFAULT.
- 4 Press the Enter button and the cursor will skip to the RESET TO DEFAULT data field.

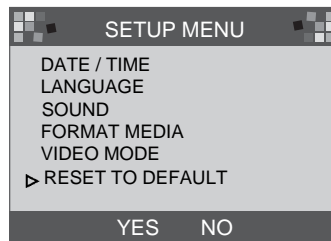

- 5 Use the Menu select button to select data(YES, NO).
 - After selecting YES, press the Enter button again to make the change and the cursor will return to the SETUP menu automatically.
 - After selecting NO, press the Enter button again to discard RESET TO DEFAULT and the cursor will return to the SETUP menu automatically.

ITEM	DEFAULT
Resolution	1280 × 960
Quality	Super fine quality
White Balance	Auto
Flash	Auto
Quickview	ON
LCD Brightness	0
EV Compensation	0.0
Slide Show Delay	2 seconds
SOUND	ON
VIDEO	NTSC



SETTING UP THE FUNCTION

Setting up the function by using the LCD monitor

DELETE mode

In DELETE mode, users can delete all the recorded images at once or one after another.



Note

- To delete the images recorded in the camera (internal memory), do not insert any CF CARD as the camera will not be able to read the internal data with a CF CARD inserted.
- To delete the images recorded in the CF CARD, make sure that the card is inserted before deletion.

■DELETE CURRENT

- 1 Turn the power on.
- 2 Set the camera to DELETE mode and the SETUP menu will be displayed on the LCD monitor.
- 3 Use the Menu select button (▲/▼) to select DELETE CURRENT?.
- 4 By pressing the Enter button, the last image captured will be displayed.
- 5 Use the Menu select button to select image.
- 6 Pressing the Enter button will delete the image.
- 7 Press the MENU button and the cursor will return to DELETE menu.

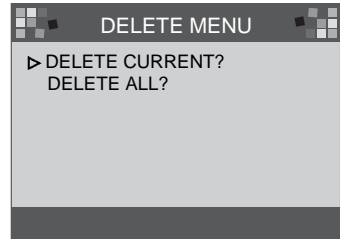



SETTING UP THE FUNCTION

Setting up the function by using the LCD monitor

■DELETE ALL

- 1 Turn the power on.
- 2 Set the camera to DELETE mode and DELETE menu will be displayed on the LCD monitor.
- 3 Use the Menu select button (▲/▼) to select DELETE ALL?.
- 4 Press the Enter button and the following message will be displayed.
- 5 Use the Menu select button to select data (YES, NO).
 - After selecting YES, press the Enter button again to delete all and the following message will be displayed.
 - Take a picture turning the Mode dial to RECORD mode.
- 6 After selecting NO, press the Enter button again and the setting will be discarded. The cursor will return to the DELETE menu.

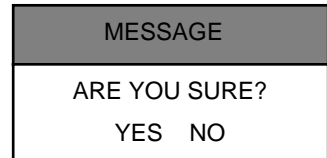
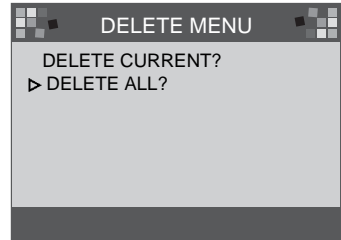



SETTING UP THE FUNCTION

Setting up the function by using the LCD monitor

PC mode

- In this mode, images can be transferred to a PC via USB cable.
- There are no menus associated with this mode.
- When you connect the camera to the PC, you should ensure that the camera is in PC mode.

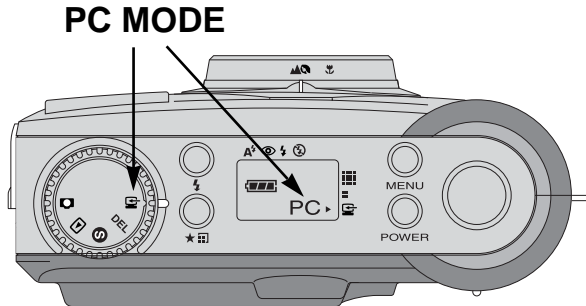

Note

- Before connecting the camera to the PC, you will need to do the following in this order.
 1. Turn the Mode dial to PC mode.
 2. Turn the power on.
 3. Connect USB cable.

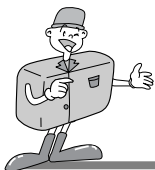

BEFORE CONTACTING A SERVICE CENTER

Before contacting a service center, please check the following

Symptoms	Causes	Steps
The power is not turned on	<ul style="list-style-type: none"> · The batteries need replacing · The AC Power Adapter is not connected 	<ul style="list-style-type: none"> · Replace the batteries with new ones · Connect the AC Power Adapter
The power is turned off during use	<ul style="list-style-type: none"> · The batteries need replacing · The camera has automatically turned itself off · The adapter has not been connected properly 	<ul style="list-style-type: none"> · Replace the batteries with new ones · Power on · Plug the adapter in correctly
The battery power is draining quickly	<ul style="list-style-type: none"> · The external temperature is too cold · The camera is using both old and new batteries 	<ul style="list-style-type: none"> · Keep batteries at the correct temperature · Replace all batteries with new ones
Camera does not take pictures when the Shutter button is being pressed	<ul style="list-style-type: none"> · The camera is not set to RECORD mode · The batteries are weak · The power has not been switched on · The memory card has not been initialized 	<ul style="list-style-type: none"> · Set it to RECORD mode · Replace the batteries with new ones · Power on. · Initialize
Images are dim	<ul style="list-style-type: none"> · You have selected the incorrect focus mode 	<ul style="list-style-type: none"> · If the subject is closer than 0.8m, select macro mode and if the subject is beyond 0.8m, select normal mode
The flash mode does not work	<ul style="list-style-type: none"> · The camera's flash is turned off 	<ul style="list-style-type: none"> · Cancel the Flash off mode
The incorrect date/time is displayed	<ul style="list-style-type: none"> · The wrong date/time is displayed or has been saved as basic numbers 	<ul style="list-style-type: none"> · Select the appropriate date in SETUP mode
The screen is too bright	<ul style="list-style-type: none"> · There is excessive exposure · LCD monitor is too bright 	<ul style="list-style-type: none"> · Reset exposure compensation · Set LCD BRIGHTNESS
The screen is not very clear	<ul style="list-style-type: none"> · The lens cover is smudged or dirty 	<ul style="list-style-type: none"> · You should clean the lens cover



SPECIFICATIONS

Image Sensor	1/3.2" CCD with 1.3 Mega pixels
Lens F2.8 / F8.0	f=5.5mm (35mm film equivalent : 42.5mm)
Digital Zoom	RECORD mode : 2X, PLAY mode : 2X, 4X
Viewfinder	Real image optical viewfinder
LCD Monitor	1.6" color TFT LCD
Focusing	Pan focusing
Focusing Range	Normal : 0.8m ~ infinity Macro : 0.4m ~ 0.8m
Shutter	Mechanical and Electronic shutter
Shutter Speed	1/10 ~ 1/520 sec.
Exposure	Program AE / Exposure compensation ± 1.8 EV (0.3 EV steps)
ISO Equivalent	100, 200 (Automatic)
White Balance	Auto / Manual (Sun, Shade, Fluorescent, Tungsten)
Flash	Auto flash / Red - eye reduction / Fill-in flash / Flash off
Flash Range	0.8m ~ 2.0m
Self-Timer	10 sec.
Storage	<ul style="list-style-type: none"> · Internal memory : 8MB flash memory · External memory : CompactFlash™ card (Type I)
File Format	JPEG (DCF compliant), DPOF compliant
Image Resolution	Large : 1280 × 960 pixels, Small : 640 × 480 pixels
Storage Capacity (8MB)	Large : Super fine 16 ± 1 , Fine 24 ± 1 , Normal 48 ± 2 Small : Super fine 33 ± 2 , Fine 66 ± 2 , Normal 134 ± 4
Image Play	Single image / Thumbnails / Slide show
Interface	Digital output connector : USB Video output : NTSC / PAL (user selectable) DC power input connector : 6.0V
Power Source	4 × AA alkaline / Ni-MH batteries AC adapter (optional)
Dimensions(W×H×D)	106 × 71 × 47mm / 4.2 × 2.8 × 1.9in
Weight	190g / 6.7oz (without batteries)
Software	Camera Driver (Windows 98/98SE/2000/ME, Mac OS 8.6 or later) MGI PhotoSuite, PhotoVista

※ Specifications are subject to change without prior notice.



SOFTWARE MANUAL

Please read the user manual carefully before using the camera

► Software Notes

- The attached softwares are image editing softwares for Windows.
 - Under no circumstances should all or part of both the software and the user manual be reproduced .
 - Copyright for both software is licensed only for use with a camera.
 - In the unlikely event of a manufacturing fault, we will repair or exchange your camera.
We cannot, however, be held responsible in any way for damage caused by inappropriate use.
 - Before reading this manual, you should have a basic knowledge of computers and O/S (Operating Systems).
- ※ Windows is a registered trademark of Microsoft.
- ※ Macintosh, Mac is the registered trademark of Apple computer, USA.



SOFTWARE MANUAL

System Requirements (2001 August)

► For Windows

Computer : A personal computer with a processor more advanced than MMX Pentium 133 MHz.

Operating System : Windows 98/98SE/2000/ME

Memory : Minimum 32MB RAM

Others : USB port, CD-ROM Drive

80MB of available hard-disk space

16 bit color display adapter and compatible monitor

a desktop area of 800 by 600 pixels

(24 bit color display adapter, True color display recommended)

► For Macintosh

Computer : Power Mac G3 or later

Operating System : Mac OS 8.6 or later

Memory : Minimum 32MB RAM

Others : USB port, CD-ROM Drive

64MB of available hard-disk space



HOW TO SET UP THE SOFTWARE

How to set up the software

- When you put the Driver CD-ROM provided with this camera into the CD-ROM drive, the following frame is automatically run.



- Camera Driver : This is the driver for connecting the PC to the Camera.
For windows : refer to page 55.
For Macintosh : refer to page 80.
- MGI PhotoSuite III SE : Photography program. Refer to page 61.
- MGI PhotoVista : This program enables you to create spectacular 360° panoramic images in a snap. Refer to page 74.

Internet link

<http://www.samsungcamera.com> : English

<http://www.zoomin.co.kr> : Korean



Reference

- If the frame is not displayed, run [Windows Explorer] and select [D:\ camera.exe] in the CD-ROM root directory. D:\ is usually the default name for the CD-ROM drive.



HOW TO SET UP THE SOFTWARE

Setting up the Camera Driver

To use this camera with a PC, first install the Camera Driver. After this has been done, the captured images in the camera can be moved to the PC and can be edited by a PC Photography program.

- 1 Click the Camera Driver icon in the auto run frame(54 page).
A WELCOME window will then be displayed.
Click [Next >] to prepare the Camera Driver installation.



- 2 Start Installation of Digimax 130 window will be displayed.
Click [Next >] to start installation.



- 3 An Installation Complete window will be displayed.
Click [Finish >] and the installation will be completed.



- 4 In order to activate the Camera Driver, you will need to restart your computer. The Install window will be displayed to indicate when you will need to restart the computer. Click [OK] to restart the computer. Click [Cancel], and an autorun frame will be displayed.

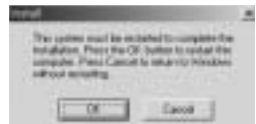



HOW TO SET UP THE SOFTWARE



Note

- Ensure that the Camera Driver has been installed before connecting the camera to the PC via the USB cable.
- Restart computer after Camera Driver installation.
- Should the computer not find the Camera Driver after installation or when you connect the camera to PC before Camera Driver installation, please re-install the Camera Driver using the following steps.

Trace [start menu → setting → controller → system → device manager] and if there is the Other device, click the right mouse button over the Other device. Then select Properties and click driver re-install. The Device driver update wizard will start.



1. Device driver update wizard will start



2. Select search method



3. Select search location and click [Browse...]



4. To select search location, trace
D:\(CD-ROM) → USB driver → English

- If problems are experienced after Driver installation, you have to remove the Camera Driver first and then re-install it.



DE SOFTWARE INSTALLEREN

MGI PhotoSuite III SE installeren

1 Click the MGI PhotoSuite III SE icon on autorun frame.

2 Select language.
Chinese(PRC), Chinese(Taiwan), English,
French(Standard), German, Italian, Spanish.

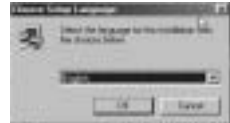

3 A Welcome window will be displayed.
Click [Next >] to move to the next step.

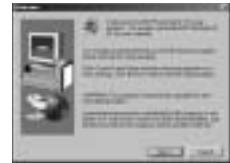

4 The Software License Agreement window will be displayed.
If you agree to this, click [Yes], the window will then move to the next step.
If you disagree, click [Cancel] and the install program will be canceled.



5 Select set up type.
Full : the program will be installed with all the options.
Custom : you can choose what you would like to install.





HOW TO SET UP THE SOFTWARE

Setting up the MGI PhotoSuite III SE

- 6 Start Copying Files window will display.
Click [Next >] to start installation.



- 7 The MGI Registration window will be displayed before completing installation.
Send : send your name and e-mail address to MGI.
Register now : move to the on-line registration window.
Register later : postpone registration.



- 8 Installation is completed.



You should restart computer after finishing installation.



HOW TO SET UP THE SOFTWARE

Setting up the MGI PhotoVista

1 Click the MGI PhotoVista icon on the autorun window.

2 Select language.
English, Deutsch, japanese, french are available.



3 A Welcome window will be displayed.
Click [Next >] to move to the next step.



4 The Software License Agreement window will be displayed. If you agree to it, click [Yes].
This will take you to the next step.
If you disagree, click [Cancel] and the install program will be canceled.



5 Select a folder where you would like PhotoVista to be installed. The default folder is C:\Program Files\MGI\Photovista. If you want to install PhotoVista in a different folder, click [Browse..] and select a folder.





HOW TO SET UP THE SOFTWARE

Setting up the MGI PhotoVista

- 6 Select the Program Folder where MGI PhotoVista will be installed.



- 7 The Start Copying Files window will display.
Click [Next >] to start installation.



- 8 The Online Registration window will display.
Click [Continue..] to continue.
The Online Registration Utility window will be displayed.
The *mark means that it is a required field.
Click [Cancel] should you not wish to register.



- 9 Set up is complete.
Click [Finish] to finish set up.





HOW TO USE EDITING SOFTWARE

MGI PhotoSuite III SE

This software is only compatible with Windows.

To open MGI PhotoSuite III SE, click the [start → programs → MGI PhotoSuite III SE → MGI PhotoSuite III SE] and MGI PhotoSuite III SE will then open.











HOW TO USE EDITING SOFTWARE

MGI PhotoSuite III SE

► An introduction to the Welcome screen

	Get Get images.
	Prepare A number of photo editing activities can be performed within this module.
	Compose Use your photos in a variety of fun, creative and interesting ways.
	Organize Organize your photos and other media files into albums.
	Share Save your results to show to others.
	Print Print hard copies of photos and projects.









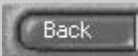

HOW TO USE EDITING SOFTWARE

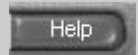
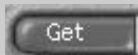
MGI PhotoSuite III SE

► Introdution to navigation bar



	Back return to the previous step.
	Home Return to Welcome screen.
	Help Display help window.
	Get Get images.
	Prepare A number of photo editing activities can be performed within this module.
	Compose Use your photos in a variety of fun and interesting ways.
	Organize Organize your photos and other media files into albums.
	Share Save your results to show to others.
	Print Print hard copies of photos and projects.
	Browse Browse the web site.



HOW TO USE EDITING SOFTWARE

MGI PhotoSuite III SE

GET : Get images

► To obtain images from the computer

1 To acquire images, Click the large [Get] button on the Welcome screen, or the [Get] button on the Navigation bar. Click [Computer] from the list of options displayed on the activity panel.



2 The Open file selector is displayed. Now select the image file and click [open].



3 The Welcome screen will change to the next work step, with the selected image displayed.

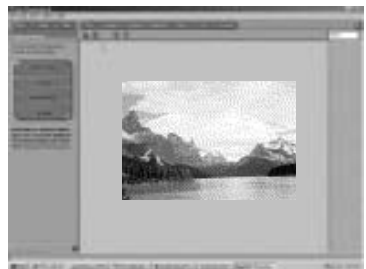



HOW TO USE EDITING SOFTWARE

MGI PhotoSuite III SE

- ▶ When you obtain images from the digital camera.



Note

- When you connect a PC to the Camera, use the following sequence :
 1. Turn the Mode dial to PC mode.
 2. Turn the power on.
 3. Connect the USB cable.
- ※ Refer to page 49 for more information about connecting the cable.

- 1 To acquire images, click the large [Get] button on the Welcome screen, or the [Get] button on the Navigation bar.



- 2 Click [Computer] from the list of options displayed on the activity panel. The Open file selector is displayed. Click [Look in :] to choose Removable Disk() and click [open] for the open file window to be displayed.





HOW TO USE EDITING SOFTWARE

MGI PhotoSuite III SE

- 3 Select [Digital camera(:)] and select folder.
Then select image and click [Open].



- 4 The Welcome screen will change to the next work
step, with the selected image displayed.

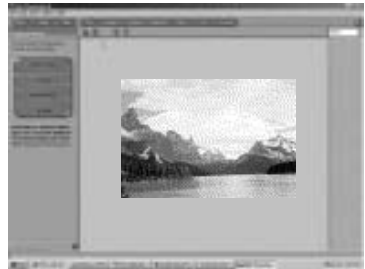

Reference

When you use the Digimax 130, only [Computer] and [Album] from the list of options displayed are available. You will be able to obtain images from the digital camera.

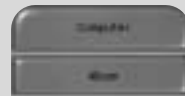

[Computer and Album Only]



HOW TO USE EDITING SOFTWARE

MGI PhotoSuite III SE

► Acquiring images from an Album.

1 To acquire images, click the the large [Get] button on the Welcome screen, or the [Get] button on the Navigation bar. Click [Album] from the list of options displayed on the activity panel.

2 After selecting Album on the ① Choose a photo album, click an image in the album and click [Open].

3 The Welcome screen will change to the next work step, with the selected image displayed.



※ Refer to page 71 for more information about creating an Album.



HOW TO USE EDITING SOFTWARE

MGI PhotoSuite III SE

PREPARE

When the image is loaded, the step changes to Prepare automatically.

■ Menu of [PREPARE] step

· **Rotate & Crop**

You can rotate, flip or crop images along with a host of others.

· **Touchup**

Remove Red eye, Remove Scratches etc.. are available in this menu.

· **Special Effects**

A number of special effects can be applied.

· **Stitching**

Join a series of photos together to create a sweeping panoramic effect.



[Initial image]



[Rotated image]



HOW TO USE EDITING SOFTWARE

MGI PhotoSuite III SE

COMPOSE

Add Text , Compound Images etc.. are available in this step.

■ Menu of [COMPOSE] steps

- **Collage** : A collage consists of several photos or sections of photos arranged together on a common background.
- **Photo Layouts** : The Photo Layouts activity includes many collage and layout options.
- **Card & tag** : Use your photos to create items such as Gift Tags, Greeting Cards, Invitations, Postcards, and Sports Cards.
- **Calendars** : Use your photos to create a variety of calendars (monthly, quarterly,seasonal, yearly).
- **Collections** : Photos can also be used to create a variety of items for business purposes.

Add frames and boarder effects to your photos with the predefined templates.





HOW TO USE EDITING SOFTWARE

MGI PhotoSuite III SE

ORGANIZE

Organize your photos and other media files into albums.

■ Menu of [ORGANIZE] step

- ① Choose a photo album to view or edit
Select Album : To create an Album, click [Organize] in the welcome screen or navigation bar.
Album.. : Open Master Album.
- ② Select a photo, and choose an action below.
Open: Open selected image.
Delete: Delete selected image.
Properties..: view image information.
- ③ Choose an action to manage your album.
Add: click [Add] to add an image to an Album.
Sort: click [Sort] to Sort saved images.
Search: click [Search] to Search saved images.
Reset: click [Reset] to reset the setting.
Update: click [Update] to update images.
Create Slide Show..: click [Create Slide Show] to create a Slide Show.
Always start on this page: If you select this option, the program will start in [Organize].





HOW TO USE EDITING SOFTWARE

MGI PhotoSuite III SE

► Creating an Album

1 To create an Album, click the large Organize button on the Welcome screen, or the Organize button on the Navigation bar.

2 Click [Album..] in ① Choose a photo album to view or edit.



3 The Master Album window will be displayed, then click [New..].



4 Put a new Album name in the New Album window and click [OK]. A new album will now be created.





HOW TO USE EDITING SOFTWARE

MGI PhotoSuite III SE

SHARE

► Saving images

1 Saving or sharing images.

■ Menu of [SHARE] step

• Save

To save the active file according to its current name and path.

• Save As

To assign a new name or path to the file.

• Send E-mail

e-mailing images.

• Send to Kodak PhotoNet Online

Sending images to Kodak PhotoNet.

• Share Your Pictures At GatherRoom.com

Sending images to GatherRoom.com and sharing images.

• Slide Show

Viewing images as a slide show.



2 Click [SAVE] and the Save Project window will be displayed. Enter the file name and click [Save(S)] to save an image.





HOW TO USE EDITING SOFTWARE

MGI PhotoSuite III SE

PRINT

► Printing images

1 You can print images.

■ Menu of [PRINT] step

• Print

Printing images.

• Print Multiples

Print multiple copies of a photo or project, or one copy of each of the photos included in an album, according to a predefined template.



2 Choose a printer, choose an orientation, choose the print size, choose the number of copies. You can then print the images.



Reference

For more information, please refer to the Help file in [Help → MGI PhotoSuite III help].



HOW TO USE EDITING SOFTWARE

MGI PhotoVista

MGI Photovista is an easy-to-use program that lets you create spectacular 360° panoramic images in a snap.

This software is only compatible with Windows.

To open MGI Photovista, click [start button → programs → MGI Photovista → MGI Photovista] and it will open.

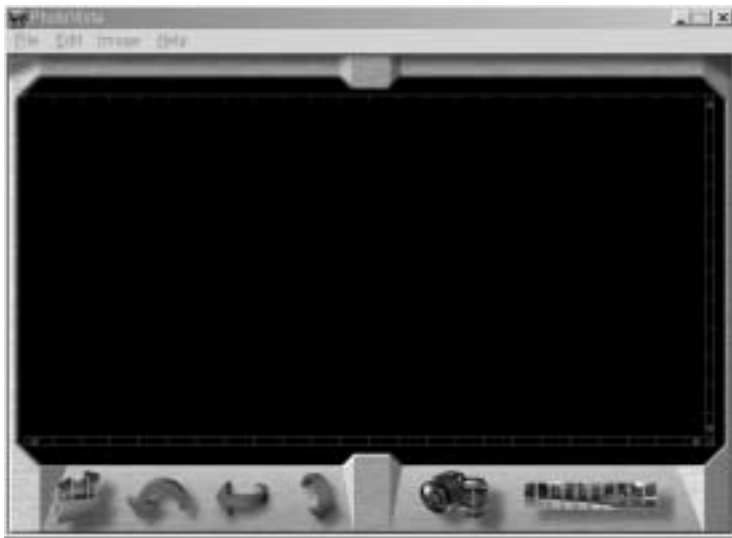









HOW TO USE EDITING SOFTWARE

MGI PhotoVista



► Introduction

	Open the Image Source Load the first image source of the panorama
	Rotate Images Rotates all selected images counterclockwise
	Flip Image Horizontally Flips the selected image horizontally
	Flip Image Vertically Flips the selected image vertically
	Select Lens Select lens for effect
	Stitch Panorama Creating a panoramic effect



HOW TO USE EDITING SOFTWARE

MGI PhotoVista

► Opening an image source and creating panoramic effects.

- 1 Click [open image source] in the menu bar to select the first image of the sequence.
A dialogue box will then be displayed.



BUTTON	DESCRIPTION
Add	Add image to source file
Add All	Add all images to source file
Remove	Remove image from source file
Remove All	Remove all images from source file
Sort	Images are sorted by file name
Reverse	Images are sorted by file name in reverse order



HOW TO USE EDITING SOFTWARE

MGI PhotoVista

- 2 The file names are Displayed in the Select Lens window. Click [Select Lens] to select a lens.



- 3 When you click [Stitch Panorama], the Stitch Options window will be displayed.
- When checking Full 360° panorama.



- 4 360° panorama image will be displayed.





HOW TO USE EDITING SOFTWARE

MGI PhotoVista

► Saving images

1 Click [File] in Stitched_Result menu to save a panoramic image.

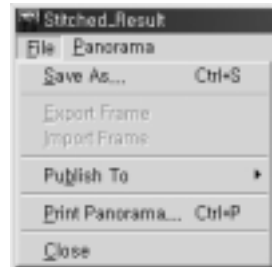

2 To save a panoramic image as a JPG or BMP file format, click [Save As..].



3 Click [Publish Panorama] to send the image to a designated server for sharing purposes.





HOW TO USE EDITING SOFTWARE

MGI PhotoVista

- 4 Click [Upload Pictures] and images are sent to www.GatherRound.com

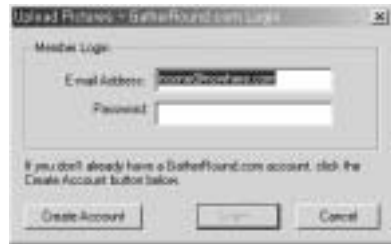

- 5 Click [Print Panorama] to print it.



Reference

For more information, please refer to the Help file in [Help → Quick Start Tutorial].



SETTING UP CAMERA DRIVER FOR MAC

Setting up Camera Driver for Mac

1 Insert CD-ROM.
Click SAMSUNG USB Driver installer that is in Digimax 130 folder. and Camera Driver installation for Mac will start.



2 Select Install Location and click [Install].



3 Click [Cancel] and the installation will be canceled.
Click [Continue] and the installation will progress.



4 Installation was successful.
Click [Continue] for additional installation.
Click [Restart] to restart the computer.

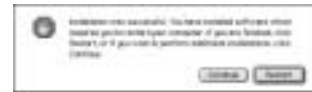

5 After restarting computer, a new folder will be made automatically on the desktop when you connect camera to Mac.

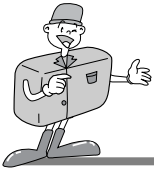

SETTING UP CAMERA DRIVER FOR MAC

Note

- Please make sure of restarting computer after installation.
- Don't take off the USB cable or turn off the power during the image download or opening the image file. It may make the system shutdown.
- It is impossible to transfer image from Mac to camera and delete image that is in Removable Disk.

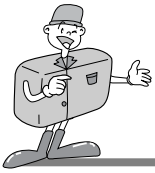

MEMO

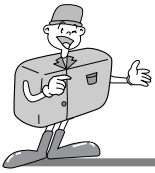

MEMO



SAMSUNG TECHWIN CO., LTD.
OPTICS & DIGITAL IMAGING DIVISION
145-3, SANGDAEWON 1-DONG, JUNGWON-GU, SUNGNAM-
CITY, KYUNGKI-DO, KOREA 462-121
TEL : (82) 31-740-8086, 8088, 8090, 8092, 8099
FAX : (82) 31-740-8398, 8399

SAMSUNG OPTO-ELECTRONICS AMERICA, INC.
HEADQUARTERS
40 SEAVIEW DRIVE, SECAUCUS, NJ07094
TEL : (1) 201-902-0347
FAX : (1) 201-902-9342
WESTERN REGIONAL OFFICE
18600 BROADWICK ST.,
RANCHO DOMINGUEZ, CA 90220
TEL : (1) 310-537-7000
FAX : (1) 310-537-1566

SAMSUNG U.K. LIMITED.
PHOTO PRODUCTS DIV.
SAMSUNG HOUSE, 3 RIVERBANK WAY,
GREAT WEST ROAD, BRENTFORD,
MIDDLESEX, TW8 9RE, U.K.
TEL : (44) 20-8232-3348
FAX : (44) 20-8569-8385

SAMSUNG DEUTSCHLAND GmbH
SAMSUNG HAUS
AM KRONBERGER HANG 6, 65824 SCHWALBACH,
GERMANY
TEL : (49) 6196-66 53 01
FAX : (49) 6196-66 53 33

SAMSUNG FRANCE S.A.R.L.
BP 51 TOUR MAINE MONTPARNASSE 33,
AV. DU MAINE 75755,
PARIS CEDEX 15, FRANCE
TEL : (33) 1-4279-2282
FAX : (33) 1-4320-4510

S.MARKET COM.IMP.EXP.LTDA
Av.zaki narchi 1392. v. guilherme cep : 02029-001
SÃO PAULO-SP BRAZIL
TEL : (55) 11-6221-6833
FAX : (55) 11-6221-6833

SAMSUNG TECHWIN MOSCOW OFFICE
KOSMODAMIANSKAYA NABEREZNA 40/42,
MOSCOW, 113035, RUSSIA
TEL : (7) 095-937-7950
FAX : (7) 095-937-4851

SAMSUNG (Aust.) PTY. LTD.
LEVEL 33, NORTHPOINT BLDG., 100 MILLER STREET,
NORTH SYDNEY,
NSW 2060, AUSTRALIA
TEL : (61) 2-9955-3888
FAX : (61) 2-9955-4233

TIANJIN SAMSUNG OPTO-ELECTRONICS CO.,LTD.
7 PINGCHANG ROAD NANKAI DIST., TIANJIN
P.R CHINA
POST CODE:300190
TEL : (86) 22-2761-8867
FAX : (86) 22-2761-8864

* Internet address - [http : //www.samsungcamera.com/](http://www.samsungcamera.com/)



The CE Mark is a Directive conformity mark of the
European Community (EC)

6806-1142

Free Manuals Download Website

<http://myh66.com>

<http://usermanuals.us>

<http://www.somanuals.com>

<http://www.4manuals.cc>

<http://www.manual-lib.com>

<http://www.404manual.com>

<http://www.luxmanual.com>

<http://aubethermostatmanual.com>

Golf course search by state

<http://golfingnear.com>

Email search by domain

<http://emailbydomain.com>

Auto manuals search

<http://auto.somanuals.com>

TV manuals search

<http://tv.somanuals.com>