

SAMSUNG

SAMSUNG CAMERA

User Manual

Digital Camera

Digimax 200

Thank you for buying a Samsung Camera. This manual will guide you through using the Digimax 200, including taking pictures, downloading images and using MGI PhotoSuite software. Please read this manual before using your new camera.

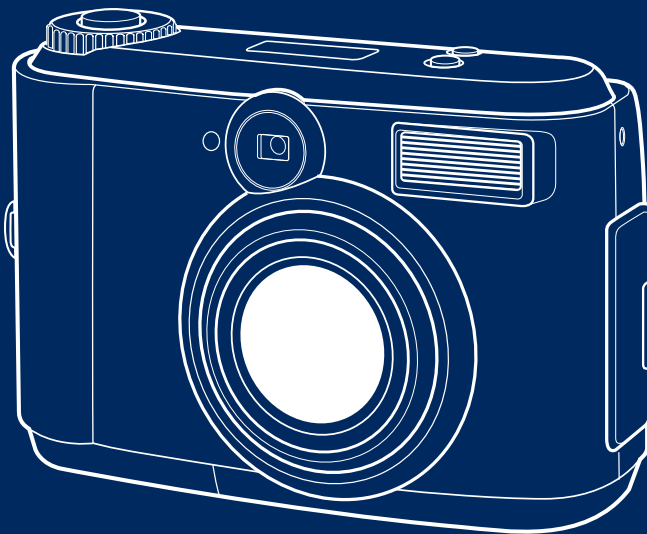

ENGLISH



SPECIAL FEATURES

Thank you for buying a Samsung Digital Camera.
This digital camera possesses the following features.

- ▶ A high resolution of 2.1 mega pixels
- ▶ 2x digital zoom
- ▶ Moving image function
- ▶ USB interface function
- ▶ 1.5 inch TFT LCD monitor

FCC warning

- This device has been tested in accordance with the limits of a class B digital device under item 15 of the FCC rules. These limits are designed to provide protection against harmful interference in commercial installation.

This equipment generates, absorbs and can emit radio frequency energy. If it is not installed and used in accordance with the instructions, it may cause harmful interference to radio communication.

There is however, no guarantee that interference will not occur in a some situations.

Should any interference occur when this device is in operation, please try one or more of the following measures.

- Change the location and direction of any aerial.
 - Increase distance between camera and affected device.
 - Use a different socket away from the affected device.
 - Please contact a Samsung agent or a radio/TV engineer.
- This device complies with part 15 of the FCC Rules.



MANUFACTURE'S CONTENTS

MANUFACTURE'S CONTENTS

Please check that you have the correct contents before using this product.

Digital camera



SmartMedia™
card



2 x AA Batteries



Pouch



Driver & application software
CD ROM



User manual



Warranty card



USB cable



Video cable



Camera strap



Accessories (Optional)

AC Adapter (3V / 1.5A)





THIS DIGITAL CAMERA CAN BE USED FOR



Viewing images on TV

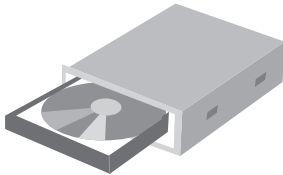

Recording images onto CD

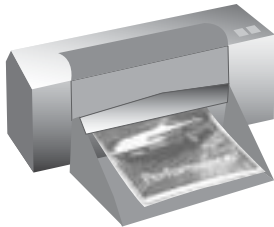

Printing images



Editing images on a PC



THIS DIGITAL CAMERA CAN BE USED FOR

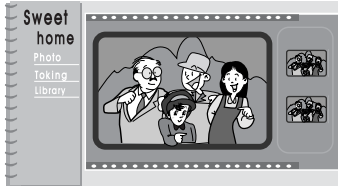

Creation of
a digital photo album



Inserting images
directly into any
electronic document

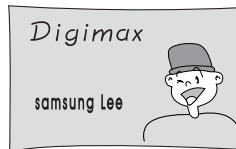

Taking a self-portrait
and using the image
to personalize name
cards

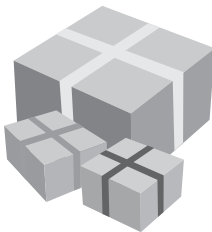

You can even create your
own unique gift-wrap paper
by using your digital
images.

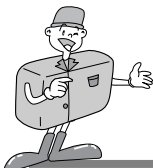

CONTENTS

Ready

- Getting to know your camera 7
- Safety note 8
- Identification of features 10
 - Product Exterior 10
 - Viewfinder 12
 - LCD panel indicator 13
- Ready 14
 - Connecting to Power 14
 - Using the batteries 14
 - Using the AC power adapter 15
 - Attaching the strap 15
 - Inserting the SmartMedia™ card 16
 - Removing the SmartMedia™ card 16

Basic

- Camera working mode 19
 - Camera working mode 19
- Taking pictures 20
 - Now let's take a picture 20
- Setting up the shooting function 23
 - Shooting functions details using LCD panel 23
 - Select the flash mode 23
 - Macro picture indicator 24
 - Checking the battery 24

Advanced

- Setting up the shooting function 27
 - LCD menu 27
 - Details of every function mode 29
 - Record mode 29
 - Play mode 32
 - Motion mode 35
 - Set up mode 36
 - PC mode 37
- Connection to an external monitor 38
 - Connection to an external monitor 38
- How to download the images into your PC ... 39
- Note in using 42
 - Caution 42
 - Warning indicator 43
- Before contacting a service center 44
- Specification 46
- System requirements Digimax 200 47

Software

- How to set up the software 48
 - Setting up the MGI PhotoSuite III SE 48
- How to use editing software 50
 - MGI PhotoSuite III SE 50



GETTING TO KNOW YOUR CAMERA

- Prior to using this camera, please read the user manual thoroughly.
- Keep the manual in a safe place.

About the image mark

This manual contains instructions on using this camera that will help you to use this camera safely and correctly. This will help prevent danger and injury to others.



Warning

This is a descriptive statement warning of the result if the instructions are ignored or not understood.



Note

This explains use of the camera, please refer to this.



Reference

This should assist further in the operation of the camera.



SAFETY NOTE

WARNING

- Do not attempt to modify this camera in any way. This may result in fire, injury, electric shock or severe damage to you or your camera. Internal inspection, maintenance and repairs should be carried out by your dealer or Samsung Camera Service Center.
- Do not use the flash in close proximity to the people or animals. Positioning the flash too close to your subject's eyes, may cause eyesight damage. Do not attempt to photograph children using a flash, closer than 1 meter proximity.
- When taking photographs, never point the lens of the camera directly into very strong light. This may result in permanent damage to the camera or your eyesight.
- Please do not use this product in close proximity to flammable or explosive gases, as this could increase the risk of explosion.
- For safety reasons keep this product and accessories out of reach of children or animals to prevent accidents e.g.:
 - Swallowing batteries or small camera accessories.
In case of accidents, please consult a doctor immediately.
 - There is a risk of permanent eye damage if the flash is operated at a distance of less than one meter from a person's eyes.
 - There is a possibility of injury from the camera's moving parts.
- Should any form of liquid enter the camera, do not use it. Switch off the camera, and then disconnect the power source (batteries or AC Power Adapter). You must contact your dealer or Samsung Camera Service Center. Do not continue to use the camera as this may cause a fire or electric shock.
- Turn the camera off immediately, then disconnect the power source (batteries or AC Power Adapter). Then contact your dealer or Samsung Camera Service Center. Do not continue to use the camera as this may cause a fire or electric shock.
- Do not insert or drop metallic or inflammable foreign objects into the camera through access points e.g. CARD slot and battery chamber. This may cause a fire or electric shock.
- Do not operate this camera with wet hands. This could pose a risk of electric shock.



SAFETY NOTE



NOTE

- Do not leave this camera in places subject to extremely high temperatures, such as a sealed vehicle, direct sunlight or other places of extreme variances in temperature. Exposure to extreme temperatures may adversely affect the camera's internal components and could cause a fire.
- When in use, do not cover the camera or AC Power Adapter. This may cause heat to build up and distort the camera case or cause a fire.
- Always use the camera and its accessories in a well-ventilated area. Leakage, overheating, or burst batteries could result in fire or injury. Do not short circuit, heat or dispose of batteries in fire. Do not use old batteries with new ones, or mix brands of batteries. Ensure the batteries are positioned correctly with regard to polarity (+ / -).
- When the camera is not in use for long periods, always unplug the camera from its power source (batteries or AC Power Adapter) for safety purposes. Leaking batteries can cause fire and pollution to the environment.
- Allowing dust to accumulate in the camera over a long period is hazardous as extreme circumstances may cause a fire. It is best to clean your camera prior to seasonal periods of high humidity. Consult your dealer or Samsung Camera Service Center for information on the cost of cleaning your camera.
- Do not move the camera while it is switched on, if you are using the AC Power Adapter. After use, always switch off the camera before unplugging the adapter from the AC Power wall socket. Then make sure that any connector cords or cables to other devices are disconnected before moving the camera. Failure to do so may damage the cords or cables and cause a fire or electric shock.



IDENTIFICATION OF FEATURES

Product Exterior (Top / Front)

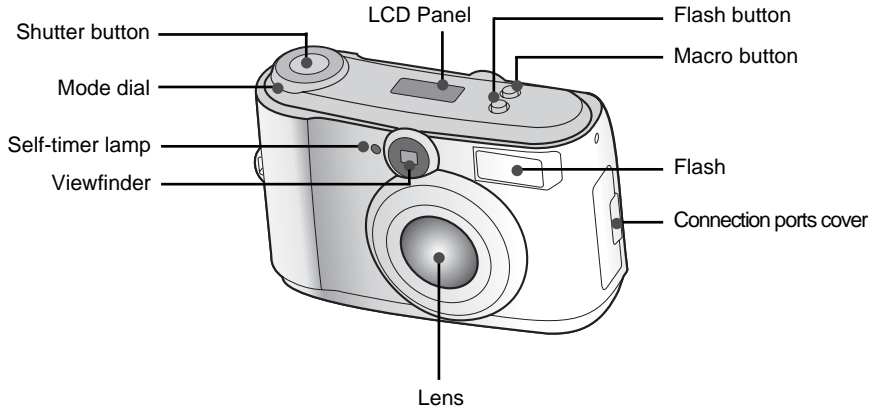

Product Exterior (Rear)

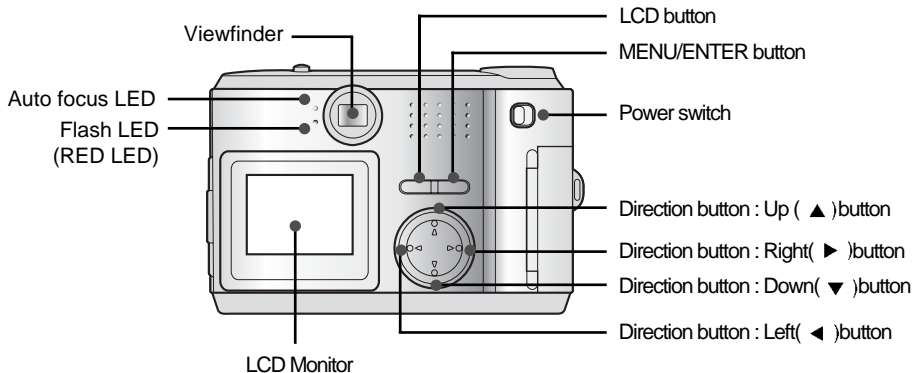



IDENTIFICATION OF FEATURES

Product Exterior (Side / Bottom)

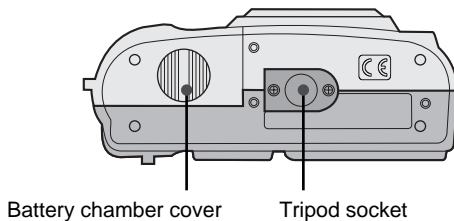
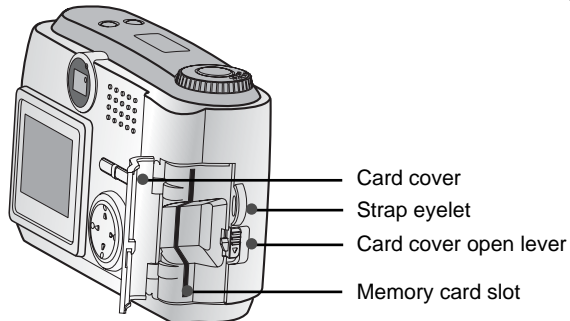
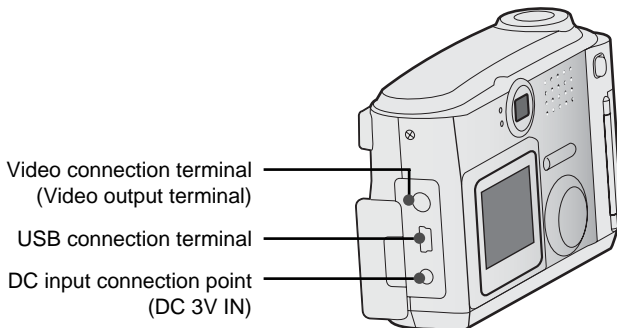



IDENTIFICATION OF FEATURES

Viewfinder



← Picture area frame

← Focus mark



Reference

- Vertical and Horizontal shots are taken in the same way.
 - Avoid obstructing the lens or the flash when you take a picture.
- A picture can be spoiled when a finger, hair or camera strap is in front of the lens or the flash.



Note

Please use the LCD monitor when using Macro mode (0.2m~0.6m).

As there can be some differences between what is seen through the viewfinder and the resulting image when taken at a range closer than 1.5m. It is recommended that you use the LCD monitor to compose the shot.



IDENTIFICATION OF FEATURES

LCD panel indicator

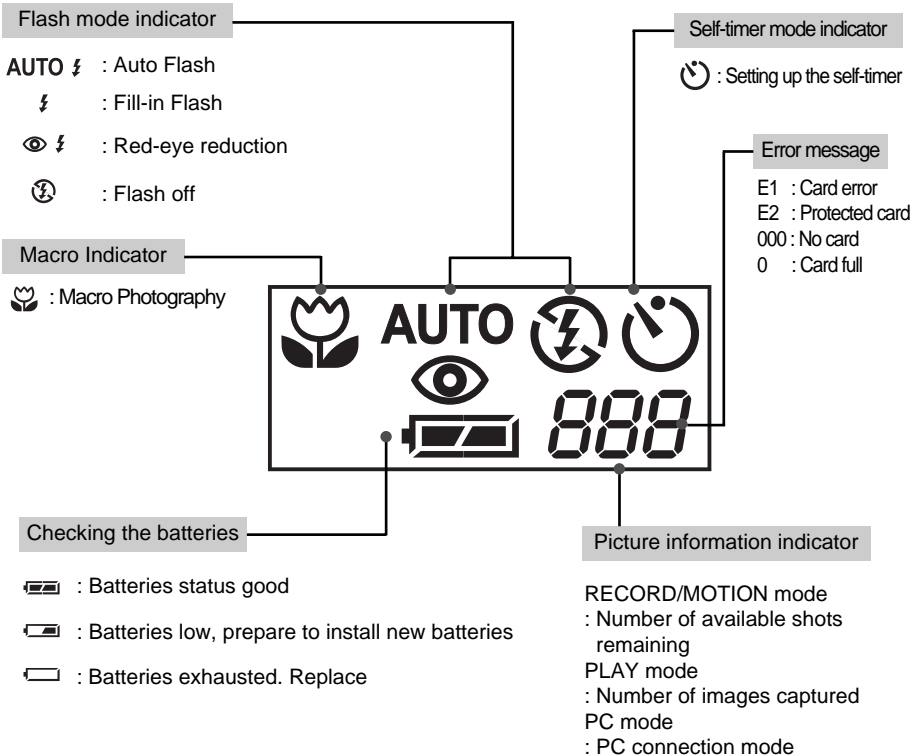

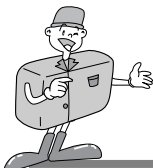

READY

Connecting to Power

There are two ways in which to provide the camera with power. Either use batteries (AA Alkaline or Ni-MH) or, alternatively, use an AC Adaptor.

■ Using the batteries

- 1 Open the battery chamber cover by pushing in the direction of the arrow.
- 2 Insert the batteries taking note of the polarity (+ / -).
- 3 To close the battery chamber cover, push it until it clicks.

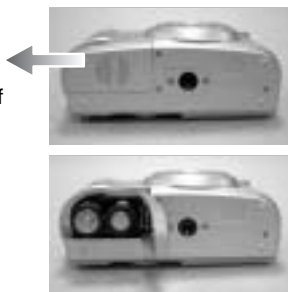

Note

Important information about battery usage

Please remove the batteries if the camera will not be used for long periods.

Batteries can lose power over time and are prone to leak if kept inside the camera.

Do not use manganese batteries as they cannot deliver sufficient power.

Low temperatures (below 0°C) can cause the camera to work for a shorter period of time due to reduced battery performance. The batteries will recover at normal temperatures.

Do not use old and new batteries or different types together.

Extended use of the camera may cause the camera body to become warm.

This is perfectly normal.

If you are planning to use this camera for long periods of time, it is advisable to use an AC adapter.



READY

■ Using the AC power adapter

- If you have access to a main supply, using an AC Adapter allows the camera to be used for long periods of time.
- Plug the adapter into the connection point on the camera.
Please ensure that you use an AC adapter with the correct specification for the camera.
- Failure to do so may affect your warranty.



WARNING

- Always turn off the power before taking the AC adapter out of the main supply.
- Keep the metallic part of camera away from any metallic material to prevent fatal damage.

Attaching the strap

- **To prevent accidental damage to the camera, always use the camera strap.**

Refer to the illustrations below





READY

Inserting the SmartMedia™ card

- 1 Pull down the card cover open lever in the direction of the arrow to open.
- 2 Inserting the SmartMedia™ card.
- 3 To close the card cover, push the card cover toward the open switch until you hear a click.



Removing the SmartMedia™ card

- 1 Turn the power off using the power switch.
- 2 Open the cover.
- 3 Remove the card.





READY



Reference

Using an 8MB SmartMedia™ card, the specification / shooting capacity will be as follows.
(This is based on the conditioning standard of our company)

Image resolution	Recorded picture quality	File format	Number of shots
L (1600 × 1200 pixels)	Super fine quality	. J P G	7 ± 1
	Fine quality	. J P G	14 ± 1
	Normal quality	. J P G	30 ± 2
S (800 × 600 pixels)	Super fine quality	. J P G	24 ± 2
	Fine quality	. J P G	52 ± 3
	Normal quality	. J P G	83 ± 4

※ The number of normal shots can vary according to the picture content.

Using a new SmartMedia™ card for the first time

- Before using the CARD, it must be initialized
- Initializing prepares the CARD for recording data
- For more details, please refer to the page 34



Note

- If used over extended periods, SmartMedia™ cards may deteriorate and performance may be impaired. If this occurs, it is best to replace with a new SmartMedia™ card. Should this be the case, you will need to purchase a new SmartMedia™ card.
- Always turn the power off when replacing the SmartMedia™ card



READY

Preserving the memory card data

- If the card is subjected to any of the following, the recorded data may become corrupted:
 - When the card is used incorrectly.
 - If the power is switched off while initializing, reading or removing the card.
- It is advisable to copy important data onto other media as back-up e.g. floppy disks, hard disks etc.
- Samsung cannot be held responsible for lost data



Note

Important information whilst using the SmartMedia™ card

- If you switch off the camera while it is reading, initializing or playing, the information on the SmartMedia™ card may be corrupted.
- The SmartMedia™ card is an electronic precision device.
- Do not bend, drop or subject the card to any heavy impact.
- Do not store the SmartMedia™ card in an environment with strong electronic or magnetic fields, e.g. near loud speakers or TV receivers.
- Please do not use or store in an environment where there are extremes of temperature.
- Do not allow the SmartMedia™ card to come into contact with dirt.
Should this happen, clean the dirt off with a soft cloth.
- Do not allow the camera to get into contact with sand, water or other contaminants.
- Damage caused in this way will invalidate the warranty and may damage the camera beyond economic repair.
- Please keep the SmartMedia™ card in its case when not in use.
- During and after periods of extended use, you may notice that the SmartMedia™ card is warm. This is perfectly normal.



CAMERA WORKING MODE

Camera working mode

You can select the appropriate working mode by using the mode dial located at the top of the camera. This digital camera has 5 working modes. These are listed below.

- Record mode(📷)

This mode is used for taking normal pictures between 0.6m ~ infinity and close range photography between 0.2m ~ 0.6m.

Press Marco (👉) button, then you will get the close up pictures

- Play mode(▶)

In this mode, the stored images on the memory card including still images and motion images, can be reviewed on the LCD monitor on the back of the camera or on an external monitor using a Video output terminal.

- Motion mode(📹)

In this mode, you can record the motion image within the recording time you specify

- Set up mode(⚙️)

In this mode, you can set up the functions of DATE/TIME, LCD BRIGHTNESS, VIDEO MODE, BEEP, RESET TO DEFAULT, LANGUAGE.

- PC mode(💻)

You can download still images and motion images stored on the memory card directly to your PC.

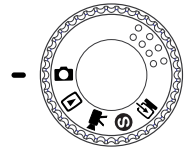

[MODE DIAL]





TAKING PICTURES

Now let's take a picture

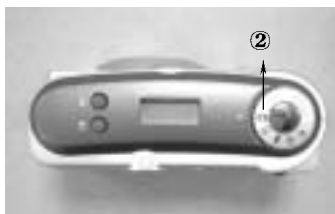
- 1 To switch on the POWER switch (①)
After the power is turned on you will hear one beep sound and then you will hear one more beep sound after the camera is ready



- 2 Turn the mode dial to the RECORD mode (②) and select the desired mode (Macro or Normal) according to the object distance. To check the macro status, please ensure the macro () button has been pressed. This is located on the top of the camera. Check if the () icon is seen on LCD panel. If not, press the macro button again.
Macro () : between 0.2m ~ 0.6m
Normal : between 0.6m ~ infinity

Note

You must select the appropriate shooting mode (macro or normal), depending on the camera/subject distance.

- 3 Select the desired image quality and file size on Record menu under Record mode ().
This can be selected by pressing the MENU/ENTER button.



TAKING PICTURES



Reference

If there is insufficient memory available

- To check the status of the remaining card memory, turn mode dial to record or motion mode. If the card is full, the message "CARD FULL" and "0" will appear in the LCD monitor and LCD panel respectively.
- To extend the amount of memory on the camera, replace the SmartMedia™ card or delete unnecessary images stored on the SmartMedia™ card.

- 4 Set up the picture function using the LCD panel and the LCD monitor.
For details of shooting function on the LCD monitor, please refer to page 27~37
- 5 You can compose your picture by using the viewfinder or the LCD monitor.
In macro mode, you should compose your picture composition using the LCD monitor.



Note

Extensive use of the LCD monitor to review the potential picture will drain the batteries in a short period of time. To safeguard against this, please use the Viewfinder.

- 6 When taking pictures, press the shutter button gently to avoid camera shake.
Press the shutter button down halfway, you will see the AF LED is blinking and the autofocus will be activated.
Pressing the shutter button down fully, will take a picture and the data regarding the picture will be stored. The LCD counter display will reduce by one and the auto focus LED will stop flashing.



TAKING PICTURES

Note

- Under certain conditions, the auto focus system may not perform as expected.
 - When photographing an object that has little contrast.
 - If the subject is highly reflective or shiny.
 - If the subject is moving at high speed.
 - When the subject only features horizontal lines or when the subject is very thin.
 - When the chosen subjects are at various distances from the camera

Reference

LED status mark is beside the viewfinder.

During the image is storing onto the memory card, the green LED flash.

The LED will cease when the image and data has been safely stored on the memory card.

After the green LED light has gone out, you can resume taking pictures.





SETTING UP THE SHOOTING FUNCTION

Shooting Functions details using LCD panel

Select the Flash mode

- Four different flash modes can be selected by pressing the flash button which is located on the top of the camera.
- Use the correct flash to suit the environment.

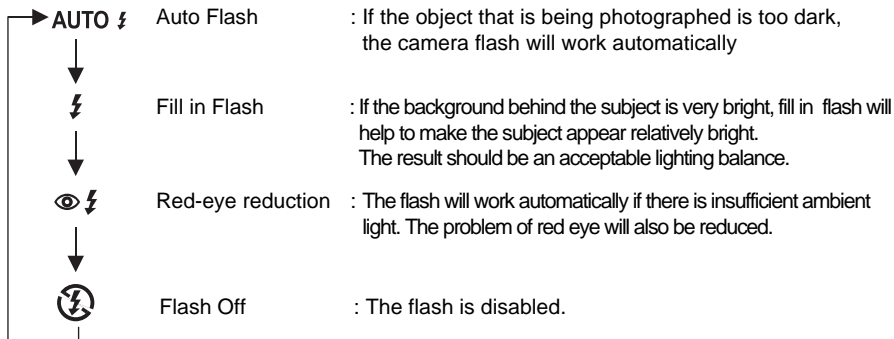

Reference

Using the flash frequently will reduce the life of the batteries.

Under normal operating conditions, the charging time for the flash is normally under 10seconds.

If the batteries are weak, the charging time will be longer.



Note



The effective distance for flash is from 0.5m to 3m.



SETTING UP THE SHOOTING FUNCTION

Shooting Functions details using LCD panel

Macro picture indicator

- When the Macro button is operated, a symbol () will appear both on LCD panel and on the top left side of the LCD monitor (when LCD is ON).
- When you press the Macro button again, then it will back to the normal shooting mode, the symbol () will disappear.

Checking the battery

The battery status symbol is shown on LCD panel when you switch on the power button.



: Batteries status good



: Batteries low, prepare to install new batteries



: Batteries exhausted. Replace



SETTING UP THE SHOOTING FUNCTION

Indicator for the number of remaining shots, status of the memory card and other information. Camera and memory card status is shown as follows:

- When the memory card is set up properly
The number of available pictures is determined by the image quality selected and the recording size.
The maximum pictures available will be 999 (subject to memory size and picture quality).
The LCD panel will count as far as 999 pictures. If this number of shots is exceeded, the counter will remain at 999.
- When the memory card is not set up properly
" No card " and "000" symbol will show on LCD monitor and LCD panel respectively.
No functions and no buttons can be operated.
If there is no card, the three audible warning " beep " will sound.
- When card memory is low:
The video function will not operate if there is less than 2MB of memory available on the card.
A warning will appear on the LCD monitor.
At this point, the menu cannot be set and the shutter release will not operate.
- Indicator for the card error
When the error occurs while the using of the camera, a symbol " E1" and "Card error" will appear on the LCD panel and TFT LCD respectively.



Reference

When the memory capacity is low, it will not be possible to take a picture.



SETTING UP THE SHOOTING FUNCTION

- The following options are available on the LCD monitor by pressing the "MENU/ENTER" button.
- It is important that the correct mode is selected on the mode dial before you attempt to operate the "MENU/ENTER" function.

Menu Mode	Function Detail Items	
RECORD	Quality EV Compensation White Balance Resolution Self Timer Digital Zoom	Superfine <input type="checkbox"/> Fine <input type="checkbox"/> Normal -1.8 ~ -1.3 ~ <input type="checkbox"/> 0 ~ +1.3 ~ +1.8 <input type="checkbox"/> AUTO <input type="checkbox"/> DAYLIGHT FLUORESCENT TUNGSTEN <input type="checkbox"/> 1600 × 1200 <input type="checkbox"/> 800 × 600 <input type="checkbox"/> OFF <input type="checkbox"/> ON <input type="checkbox"/> OFF <input type="checkbox"/> ON
PLAY	Slideshow Picture info Thumbnail Erase DPOF Digital Zoom Exit	<input type="checkbox"/> 2 <input type="checkbox"/> 4 <input type="checkbox"/> 6 <input type="checkbox"/> 8 <input type="checkbox"/> 10 <input type="checkbox"/> ON <input type="checkbox"/> OFF <input type="checkbox"/> OFF <input type="checkbox"/> ON <input type="checkbox"/> OFF <input type="checkbox"/> ON ONE ALL FORMAT <input type="checkbox"/> Quantity : 0, 1, 2, 3, 4, 5, 6, 7, 8, 9 <input type="checkbox"/> OFF <input type="checkbox"/> ON
MOTION	Recording time	5 <input type="checkbox"/> 10 <input type="checkbox"/> 15 <input type="checkbox"/> 20
SET UP	Date / Time LCD Brightness Video mode Beep Reset to Default Language	dd - mm - yyyy (01-01-2001) hh : mm AM / PM darker brighter <input type="checkbox"/> NTSC <input type="checkbox"/> PAL <input type="checkbox"/> ON <input type="checkbox"/> OFF <input type="checkbox"/> YES <input type="checkbox"/> NO <input type="checkbox"/> ENGLISH <input type="checkbox"/> DEUTSCH <input type="checkbox"/> FRANÇAIS <input type="checkbox"/> ESPAÑOL 中國語 한국어
PC		Please connect the camera to your PC with a USB cable for images downloading

To download images, please connect the camera and your PC via a USB cable

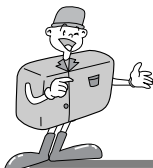

SETTING UP THE SHOOTING FUNCTION

LCD menu

■ RECORD Mode

- Quality : To select a compression rate
- EV Compensation : To select the exposure compensation
- White Balance: To obtain more naturally colored images depending on light conditions.
- Resolution : To select the image size.
- Self Timer : To allow the photographer to also be in the picture
- Digital Zoom : To enlarge an area of the object being photographed.
You can set up or cancel the digital zoom function by choosing " on " or " off ".

■ PLAY Mode

- Slideshow : You can view each image at a set interval using the slideshow function.
- Picture Info : You can view the picture information such as date/time, picture quality, flash, resolution and file name on the LCD monitor.
- Thumbnail : The thumbnail screen allows you to view up to 9 images at a time.
- ERASE : To erase ONE / ALL images saved in the memory card or to format the card.
- DPOF : Digital Print Order Format.
- Digital Zoom : To enlarge an area of the object being photographed.

■ MOTION Mode :

- Recording Time : To select the time you would like recorded.

■ SET UP Mode

- Date / Time : This function sets the date and time of the camera.
- LCD Brightness : Here you can adjust the brightness of the TFT LCD monitor.
- Video mode : To view still images from the moving images you have taken on TV.
You will need to choose from either (NTSC or PAL) video output.
- Beep : For a " beep " to sound when any button or function key is pressed if the function is on.
- Reset to default : All the functions you have selected will be overridden by the original settings installed in the camera during manufacturing.
- Language : To select the language you want. There are 6 different languages available which are English, German, French, Spanish, Traditional chinese and Korean.



SETTING UP THE SHOOTING FUNCTION

■ PC Mode :

To download the images from camera to PC

When the camera is connected to PC successfully you will be heard the beep sound (beep-)

Note

- After you have selected and set the required functions, press the "MENU/ ENTER" button to save these, before quitting each menu mode.
- About the issue that AVI file downloaded from your camera can't play back on Window please refer to below solution.
 - Please install "QuickTime" software in your PC
("QuickTime" is a trademark of Apple Computer, Inc.)
 - Please install the DirectX8.0 in your PC. Driver is served from camera driver or Microsoft homepage.
- User must login as an Administrator or own the Administrator privilege to install DirectX 8.0a Runtime under Windows 2000.
- Or the DirectX Setup will show the below message and can not install completely. Current logon user doesn't have the Administrator privilege. Please logon again as an Administrator or contact your PC Administrator.
- When you press the shutter button in the Set Up menu on the LCD monitor, the camera will not take a picture.
Please ensure that you press the "MENU/ ENTER" button to save the function you have selected.
- The PC connection function will only operate after you have turned the Mode dial to PC Mode. Even if the camera is connected to the PC via USB, unless PC Mode has been selected, the function will not operate.
- After the camera is connected to PC, the TFT LCD will be turned off automatically.
But the camera will not turned off until the camera is disconnected from PC.



SETTING UP THE SHOOTING FUNCTION

Details of Every Function Mode

RECORD MODE

In RECORD mode, after you have pressed the " MENU/ENTER " button, on the RECORD menu screen you can change the set status on it by using the UP (▲) or DOWN buttons (▼) first and then by pressing the RIGHT (►) or LEFT buttons (◀) to select your choice. Press the MENU / ENTER Button to set up the Record Menu.

- By selecting QUALITY, you can change the compression rate of the picture.
The symbol of ★ ★ ★ means that the quality is set to "Super Fine"
The symbol of ★ ★ means that the quality is set to "Fine"
The symbol of ★ means that the quality is set to "Normal"
- EV COMPENSATION allows you to increase or decrease the exposure.

RECORD MENU
QUALITY
EV COMPENSATION
WHITE BALANCE
RESOLUTION
SELF TIMER
DIGITAL ZOOM
FINE

This camera will automatically control the exposure, but you can also select exposure compensation.
Select the exposure value by using the RIGHT and LEFT directional buttons after moving the cursor bar onto EV.
If you increase the exposure, you will obtain a brighter image.
If you decrease the exposure, you will obtain a darker image.

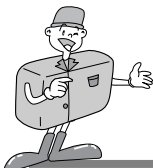

SETTING UP THE SHOOTING FUNCTION



Reference

Start setting the exposure compensation : 0 EV

The set range of the exposure compensation is : -1.8 ~ -1.3 ~ 0 ~ +1.3 ~ + 1.8

The selected exposure compensation will stay the same until the power has been turned off.

When you switch on the power again, the exposure compensation will automatically set itself to 0 EV (canceling the exposure compensation).

Be cautious when using exposure compensation, as the LCD monitor looks black and exposure will be minimal when using the (-) exposure compensation.

The LCD monitor looks white and over-saturation can happen if you see the (+) exposure compensation.

- WHITE BALANCE function is used to help obtain more naturally colored images, depending on light conditions.
The colours of the captured images may alter according to lighting conditions.
 - Auto : The camera automatically selects the optimum white balance depending on the conditions of the ambient lighting.
 - Day Light : The white balance should be used to obtain shots in normal outdoor light conditions
 - Fluorescent Light : This white balance is suitable for indoor shooting under fluorescent light conditions.
 - Tungsten : This white balance is suitable for indoor shooting with artificial or tungsten lighting.
- RESOLUTION is related to file size. You can choose the size (1600 x 1200 or 800 x 600) by pressing the RIGHT / LEFT button to set it.



Reference

The image quality and recording size determines the number of images that can be shot.

The recording size stored in the memory can not be changed. Once an image is captured, the size of the stored file cannot be altered.



SETTING UP THE SHOOTING FUNCTION

- The " SELF TIMER " function is used when the photographer also wants to be in the picture.

If you select " ON ", the indicator () is displayed on LCD panel and LCD monitor (when LCD monitor is powered on)

The image will be captured 10 seconds later after you have pressed the shutter button and the function is then cancelled.



Reference

The Self Timer Lamp will flash with beep sound while the self timer is in operation.

7 seconds after pressing the shutter button, the Self Timer Lamp will flash slowly in 1 second intervals.

In the last 3 seconds, the Self Timer Lamp light will be blinking quickly in 1/2 second intervals.

- If you select " DIGITAL ZOOM " on, the function of the digital zoom is selected. It is cancelled automatically after the pictured image is stored in the memory card.



Reference

Pictures taken using the digital zoom take a little longer to download.

Please allow extra time between shots.



SETTING UP THE SHOOTING FUNCTION

Details of Every Function Mode

PLAY MODE

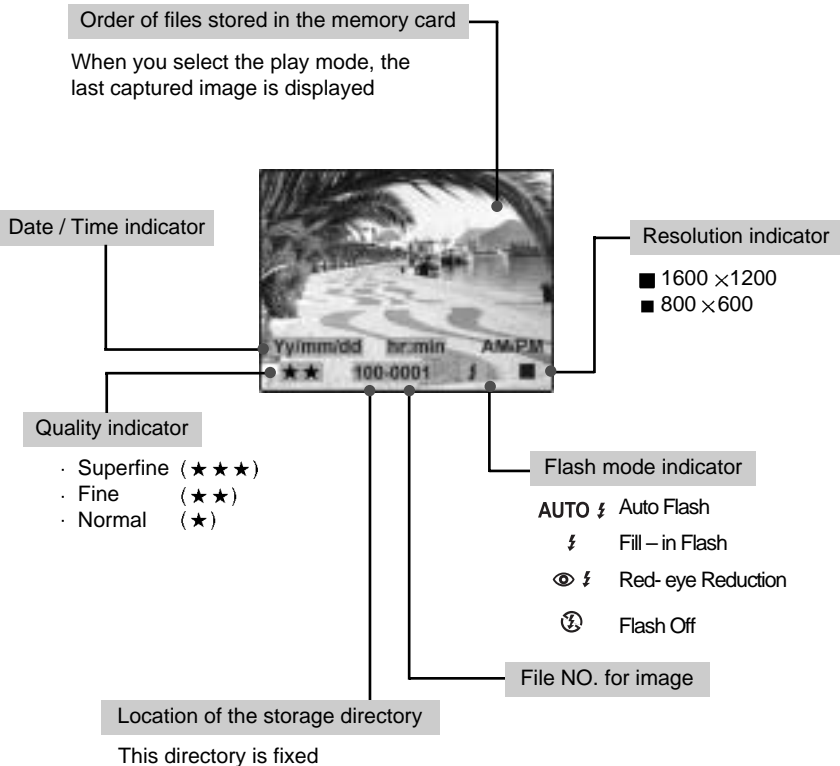



SETTING UP THE SHOOTING FUNCTION

After set up is completed, please press the " MENU / ENTER " button to save your selections , before you quit this menu.

- **SLIDE SHOW**

Images can be displayed automatically at pre-set intervals.

To save power, the camera will switch off automatically if there is no operation of camera for 10 second after presentation of all images stored in the memory card.

- **PICTURE INFO**

When this function is " ON ", you can view the picture information of date/time, image quality, file No. flash, and image resolution on the LCD monitor.

- **THUMBNAIL**

This function allows you to view 9 individual images at the same time on the LCD monitor.

To select the image you require in the thumbnail screen, move the UP (▲) or DOWN button (▼).

To view the selected picture, just press " MENU/ENTER " to enlarge the thumbnail for easy viewing.

To select the previous 9 thumbnail images or the next 9 thumbnails, just move the LEFT button (◀) or RIGHT button (▶).





SETTING UP THE SHOOTING FUNCTION

- **ERASE**

In this mode, you can erase data (One / All) or format the SmartMedia™ card.

- Erase One

After moving the bar cursor to " ONE " and pressing " MENU/ENTER " , you will be asked " ARE YOU SURE ? " .

If you do want to proceed with deleting, press " YES". The last single image you select will be deleted from the memory card after you press the " MENU/ENTER " button.

If you select " NO ", the screen will return to the PLAY Menu, and no images will be deleted.

- Erase All

All image data which is saved in the SmartMedia™ card will be erased if you choose " ALL " and press the " MENU/ENTER " button and then choose " YES " .

- Format

This function is for formatting a SmartMedia™ card.

- During the formatting the symbol " Please wait" will be appeared on the LCD monitor.



SETTING UP THE SHOOTING FUNCTION

- DPOF (Direct Print Order Format)

You can print the saved images stored in the SmartMedia™ card. The selected image will be printed out in the quantity you set up in the DPOF menu. The quantity you can choose for every image is 0 ~ 9. If you select " 0 ",no image will be printed. If you select " 2 ", then the image you selected will be printed twice.

- DIGITAL ZOOM

There is 2x digital zoom available in play mode. When the digital zoom function is set to " ON", the picture is divided into 4 area.

To view one of them, please use the RIGHT button (►) or LEFT button (◀).

MOTION MODE

Press the MENU/ENTER button to set up the Motion Menu.
To record a moving image, please set the recording time and press the " MENU/ENTER" button. Then press the shutter button to start recording. To obtain a good quality AVI file, please do not shake the camera when recording. Move it slowly and smoothly.

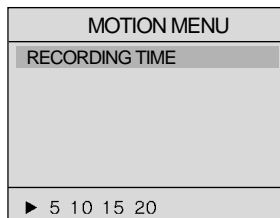



SETTING UP THE SHOOTING FUNCTION

SET UP MODE

Press the MENU/ENTER Button to set up the Set up Menu

- **DATE / TIME**

The date and time can be changed in this menu. When the cursor is moved to this function, you will be able to enter the date and time with the 4 directional buttons. Once you have completed this, press the MENU/ENTER button again. The date and time you have changed is now saved and displayed on the LCD monitor.

- **LEFT / RIGHT button**

To select the item you would like to set, such as month, date, year, hour, minutes, AM/PM.

- **UP / DOWN button**

To change the date or time.

- The DOWN button is for setting the previous date or time such as 02/02/2002 to 01/01/2001 and 02:00 AM to 01:00 AM.

- The UP button is for setting the later date or time such as 01/01/2001 to 02/02/2002 and 01:00 AM to 02:00 AM.

- **LCD BRIGHTNESS**

This function allows you adjust the LCD brightness to your preference. To make it darker or brighter, move the LEFT / RIGHT button to choose. Move the cursor to the left to make it darker and to the right to make it brighter.

- **VIDEO MODE**

You can set up the video output signal from the camera in NTSC or PAL type depending on the type of machine (monitor or TV, etc.) to which the camera is connected. Select what is compatible with the Video type of the outer monitor. Press the MENU/ENTER button after you have selected the video output type you require.

- **BEEP**

You can select whether to have the beep turned on or off.

When it is ON, you will hear one " Beep" sound once you press any button of the camera. And 2 sounds of " beep-beep " acts as a warning, meaning that the environment is not ideal for taking a picture, but the camera is still functional.

And 3 sounds of " beep-beep-beep" means the camera failed to execute the command you have ordered. Please check the camera status (no memory card ? no image ? too dark environment...etc ?)

SET UP MENU
DATE TIME
LCD BRIGHTNESS
VIDEO MODE
BEEP
RESET TO DEFAULT
LANGUAGE
21 - 11 - 2001
10 : 25 AM



SETTING UP THE SHOOTING FUNCTION

- **RESET TO DEFAULT**

All of the functions will be reset to default when you select "ON ", except the DATE/TIME, VIDEO MODE and LANGUAGE you have set.

- **LANGUAGE**

There are 6 languages available for your choice in the camera which includes English, German, French, Spanish, Traditional chinese, Korean.

Press the " MENU/ENTER" button after you have selected the language version you want.

PC MODE

To download the still or moving images saved in the memory card, please power on the camera and select PC mode from the Mode Dial, and then plug the USB cable into your computer and ensure that it is connected securely. If the connection is successful, the symbol " PC" appeared on the LCD panel and LCD monitor will be turned off automatically.

Please **DO NOT** remove the USB cable while the image data is being transferred, otherwise the downloading will be stopped.



Note

While in PC mode, you will not be able to execute the functions of other modes.

If you change the Mode dial to another function, the camera will have no connection to the PC even though the USB cable might be connecting the camera to it.

Please therefore ensure that the Mode dial is in PC mode when you wish to download images from the camera to the PC.



CONNECTION TO AN EXTERNAL MONITOR

Connection to an external monitor

Connect the video connection terminal on the camera to an external monitor with a video cable. Set the camera PLAY mode in order to view the Moving / Still images on the external monitor. The LCD monitor of the camera will be changed to "ON" or "OFF" by pressing the LCD button. The information on the external screen will be exactly the same as on the LCD monitor on the camera.

Selecting the Video output type

You can select an NTSC or PAL video output signal, depending on the external equipment and the video output selected on the camera.



Reference

When using a TV as an external monitor, you will need to select the external or AV channel.

If there is noise (the picture is fuzzy) please refer to your TV manual for more information.

If the picture is not in the center of the screen, please use the TV controls to center it.

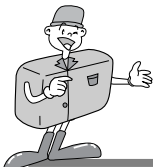

HOW TO DOWNLOAD THE IMAGES INTO YOUR PC

- 1 Connect the digital camera to your computer, it will create a new disk named " Removable Disk ".
All the images stored the SmartMedia™ card can be found in the folder " 100sscscam " which is under the directory " DCIM " in the " Removable Disk ".
Please note that the " Removable Disk " only exists when the digital camera is connected to the computer.
i.e. : 3 images in JPG files in " Removable Disk, DCIM / 100sscscam".



- 2 You can delete the images or copy them to another hard disc in your computer if you wish.
i.e. : Copy the images to Hard Disk " C / My documents " .





HOW TO DOWNLOAD THE IMAGES INTO YOUR PC

- 3 Start MGI PhotoSuite III SE and click on " File" and then click on " Open ".



- 4 Choose the image(s) you would like to preview and edit.
i.e. Choose the 3 images in " My Documents ".





HOW TO DOWNLOAD THE IMAGES INTO YOUR PC

- 5 If more than 1 image is selected, please switch to "Photos" which is on the upper right corner of the screen and thumbnails of the selected images will appear.



- 6 Double click on one thumbnail and it will turn into a normal size image and you can now start editing it by using the editing tool-bars on the left side of the screen.





NOTE IN USING

Caution!

- This camera is composed of very sophisticated parts.
If exposed to any of the following unsuitable environmental conditions, the camera operations will be impaired.
The camera should be kept away from:
 - Severe changes in temperature and humidity.
 - Dust and dirt
 - Direct sunlight or the inside of a vehicle in hot weather.
 - Do not place the camera in an environment where there is high magnetism or excessive vibration.
 - An area with high explosives or highly flammable materials
 - Pesticides, etc
- Never bring into contact with sand
If sand gets into electronic devices like a Digital camera, it can cause severe malfunctions. Please ensure that there is no contact with sand or similar particles.
- Always be careful not to expose the camera to extremes in temperature.
If the device is transferred from a very cold to a very hot environment or vice versa, condensation can occur inside the device.
If moisture gets into the camera, turn off the device and wait about 1 hour until all moisture has evaporated.
Similarly, moisture build up can occur in the SmartMedia™ card.
If this happens, turn off the device and remove the Memory Card. Wait until the moisture has dispersed.
- Caution with the Lens.
Avoid direct sunlight to lens. Direct sunlight can affect Complementary CCD(Charge coupled device) by causing overheating and fading.
- If the Digital camera is not used for a long period, electric discharge can occur. Please make sure the device, batteries, and SmartMedia™ card are stored separately.
- Maintenance
To clean the Lens or the LCD panel, a soft brush should be used. If this does not work, lens-cleaning paper with lens cleaning fluid can be used.
Clean the camera with a soft cloth or a mild detergent.
Please ensure that it is a mild detergent otherwise it may cause deterioration, deformation or paint flaking off.
The LCD monitor can be damaged very easily. Please ensure that it does experience any sharp impact.



NOTE IN USING

- Do not attempt to disassemble or modify the device by yourself.
- The power can be turned off if exposed to shock. This is for the protection of the memory card, which means that you will be able to just turn the camera on again and use it.
- The flash may fire if the camera is exposed to static electricity. This does not affect the workings of the camera and is not a fault.
- The warning indicator displayed on the LCD monitor is as follows.

Warning Indicator

Warning indicator	Warning contents	Treatment
NO CARD	<ul style="list-style-type: none">· No memory card· The card cannot be read	<ul style="list-style-type: none">· Insert the memory card.· Insert the memory card again
CARD FULL	<ul style="list-style-type: none">· The card is full	<ul style="list-style-type: none">· Replace the card with the new one.
NO IMAGE	<ul style="list-style-type: none">· No images in SmartMedia™ card	<ul style="list-style-type: none">· Take picture and save it onto the SmartMedia™ card
PROTECTED CARD	<ul style="list-style-type: none">· The card is in the condition of protection	<ul style="list-style-type: none">· To record a picture, please remove the protection sticker

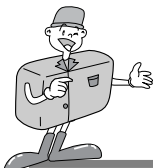

BEFORE CONTACTING A SERVICE CENTER

Symptoms	Causes	Steps
The power is not turned on	<ul style="list-style-type: none"> The batteries need replacing The AC Power Adapter is not connected 	<ul style="list-style-type: none"> Replace the batteries with new ones Connect the AC Power Adapter
The power is turned off during use	<ul style="list-style-type: none"> The batteries need replacing The camera has automatically turned itself off. The card is taken out before the image is saved onto it. The adapter has not been connected properly 	<ul style="list-style-type: none"> Replace the batteries with new ones Power on. Do not remove the memory card while you save the image. Plug the adapter in correctly
The battery power is draining quickly	<ul style="list-style-type: none"> The external temperature is too cold The camera is using both old and new batteries 	<ul style="list-style-type: none"> Keep batteries at the correct temperature Replace all batteries with new ones
Camera does not take pictures when the Shutter button is being pressed	<ul style="list-style-type: none"> The camera is not set to RECORD mode SmartMedia™ card is not inserted The memory card has not been initialized. Memory card is almost drained The batteries are weak The power has not been switched on 	<ul style="list-style-type: none"> Set it to RECORD mode After turning off the camera, insert the Card Initialize Insert new Card from manufacturer Replace the batteries with new ones Power on
The focus cannot be adjusted	<ul style="list-style-type: none"> You have selected the incorrect shooting mode 	<ul style="list-style-type: none"> If the subject is closer than 0.6m, select macro mode and if the subject is beyond 0.6m, select normal mode
The flash does not work	<ul style="list-style-type: none"> The camera flash is turned off 	<ul style="list-style-type: none"> Please change the flash mode to Fill in or Auto
The incorrect date/time is displayed	<ul style="list-style-type: none"> The wrong date/time is displayed or has been saved as basic numbers 	<ul style="list-style-type: none"> Select the appropriate date in SETUP mode
Camera fails to work by any button or switch	<ul style="list-style-type: none"> Camera is not working properly 	<ul style="list-style-type: none"> Remove the batteries and insert them again.

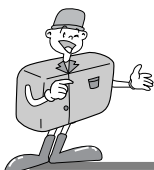

BEFORE CONTACTING A SERVICE CENTER

Symptoms	Causes	Steps
The card error indicator is on with the memory card inserted.	<ul style="list-style-type: none"> · Unable to start using the memory card. 	<ul style="list-style-type: none"> · Format the memory card and use it
There is something wrong with the color of the captured image	<ul style="list-style-type: none"> · There are problems using the W.B mode. 	<ul style="list-style-type: none"> · Set up the right one for each light source. Refer to W.B. on the page 30
The screen is too bright	<ul style="list-style-type: none"> · There is excessive exposure 	<ul style="list-style-type: none"> · Reset exposure compensation.
The screen is not very clear	<ul style="list-style-type: none"> · The LCD cover is smudged or dirty 	<ul style="list-style-type: none"> · You should clean the LCD cover
The play screen is not displayed on the external Monitor.	<ul style="list-style-type: none"> · The video cable is not connected to the camera or external monitor. 	<ul style="list-style-type: none"> · Connect the cable properly
The camera does not download files with USB cable into PC	<ul style="list-style-type: none"> · Cable is not connected properly · Camera is off. · There is no battery or the adapter is not connected. · The mode dial is not on the PC connection mode. · OS is not Window 98/98SE/2000/ME or PC is not equipped with USB port. 	<ul style="list-style-type: none"> · Check the connections · Turn on the camera · Insert new batteries or connect with AC Power Adapter · Use the PC connection mode. · Install Windows 98/98SE/2000/ME

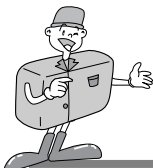

SPECIFICATION

Image Sensor	1/2.7" CCD with 2.1 Mega pixels
Lens	f=6.8mm (35mm film equivalent : 43mm) F2.8 / F4.0 / F5.6 / F8.0
Digital Zoom	Record mode : 2X, Play mode : 2X
Viewfinder	Real image optical viewfinder
LCD Monitor	1.5" color TFT LCD
Focusing	Auto focusing
Focusing Range	Normal : 0.6m ~ infinity , Macro : 0.2 ~ 0.6m
Shutter	Mechanical and Electronic shutter
Shutter Speed	1/4 ~ 1/1,000 sec
Exposure	Program AE / Exposure compensation ± 1.8 EV (0.3EV steps)
ISO Equivalent	100, 200 (Automatic)
White Balance	Auto / Manual (Daylight, Fluorescent, Tungsten)
Flash	Auto flash / Fill-in flash / Red - eye reduction / Flash off
Flash Range	0.5 ~ 3.0m
Self-timer	10 sec.
Video Clips	Size : 320x240 Recording time : up to 20 sec
Storage	SmartMedia™ card
File Format	JPEG (DCF compliant), DPOF, AVI (Motion JPEG) compliant
Image size	Large : 1600x1200 pixels, Small : 800x600 pixels
Storage Capacity (8MB)	Large : Super fine 7 \pm 1, Fine 14 \pm 1, Normal 30 \pm 2 Small : Super fine 24 \pm 2, Fine 52 \pm 3, Normal 83 \pm 4
Image Play	Single image / Thumbnail / Slide show
Interface	Digital output connector : USB Video output : NTSC / PAL (user selectable) DC power input connector : 3.0V
Power Source	2 x AA alkaline (high capacity recommended) / Ni-MH batteries. AC adapter (optional)
Dimensions (W x H x D)	103 x 69 x 42.7mm / 4.0 x 2.7 x 1.7in
Weight	172g / 6.1oz (without batteries and card)
Software	Camera driver, MGI PhotoSuite

* Specifications are subject to change without prior notice.



SYSTEM REQUIREMENTS DIGIMAX 200

System Requirments	
FOR WINDOWS	PC with processor better than MMX Pentium 233MHz Windows 98/98SE/2000/ME Minimum 64MB RAM 100MB of available hard-disk space USB port CD-ROM drive 800 ×600 pixels, 16-bit color display compatible monitor. (24-bit color display recommended)
FOR MACINTOSH	Power Mac G3 or later Mac OS 9.x Minimum 64MB RAM 50MB of available hard-disk space USB port CD-ROM drive

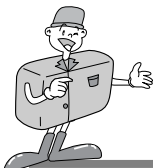

HOW TO SET UP THE SOFTWARE

Setting up the MGI PhotoSuite III SE

1 Click the MGI PhotoSuite III SE icon on autorun frame.

2 Select language.
Chinese(PRC), Chinese(Taiwan), English,
French(Standard), German, Italian, Spanish.

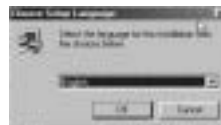

3 A Welcome window will be displayed.
Click [Next >] to move to the next step.



4 The Software License Agreement window will be displayed.
If you agree to this, click [Yes], the window will then
move to the next step.
If you disagree, click [Cancel] and the install program
will be canceled.



5 Select set up type.
Full : the program will be installed with all the options.
Custom : you can choose what you would like to install.





HOW TO SET UP THE SOFTWARE

Setting up the MGI PhotoSuite III SE

- 6 Start Copying Files window will display.
Click [Next >] to start installation.



- 7 The MGI Registration window will be displayed before completing installation.
Send : send your name and e-mail address to MGI.
Register now : move to the on-line registration window.
Register later : postpone registration.



- 8 Installation is completed.



You should restart computer after finishing installation.



HOW TO USE EDITING SOFTWARE

MGI PhotoSuite III SE

This software is only compatible with Windows.

To open MGI PhotoSuite III SE, click the [start → programs → MGI PhotoSuite III SE → MGI PhotoSuite III SE] and MGI PhotoSuite III SE will then open.











HOW TO USE EDITING SOFTWARE

MGI PhotoSuite III SE

► An introduction to the Welcome screen

	Get Get images.
	Prepare A number of photo editing activities can be performed within this module.
	Compose Use your photos in a variety of fun, creative and interesting ways.
	Organize Organize your photos and other media files into albums.
	Share Save your results to show to others.
	Print Print hard copies of photos and projects.





HOW TO USE EDITING SOFTWARE

MGI PhotoSuite III SE

► Introduciton to navigation bar

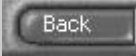

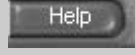
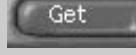
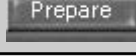
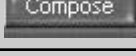
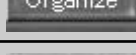
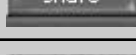
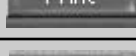
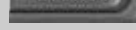
	Back return to the previous step.
	Home Return to Welcome screen.
	Help Display help window.
	Get Get images.
	Prepare A number of photo editing activities can be performed within this module.
	Compose Use your photos in a variety of fun and interesting ways.
	Organize Organize your photos and other media files into albums.
	Share Save your results to show to others.
	Print Print hard copies of photos and projects.
	Browse Browse the web site.



HOW TO USE EDITING SOFTWARE

MGI PhotoSuite III SE

GET : Get images

► To obtain images from the computer

1 To acquire images, Click the large [Get] button on the Welcome screen, or the [Get] button on the Navigation bar. Click [Computer] from the list of options displayed on the activity panel.



2 The Open file selector is displayed. Now select the image file and click [open].



3 The Welcome screen will change to the next work step, with the selected image displayed.

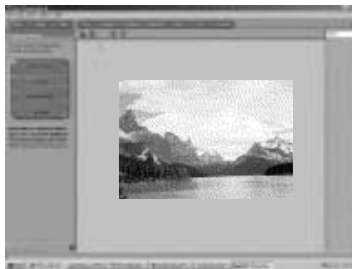

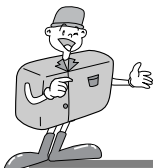

HOW TO USE EDITING SOFTWARE

MGI PhotoSuite III SE

- ▶ When you obtain images from the digital camera.



Note

- When you connect a PC to the Camera, use the following sequence :
 1. Turn the Mode dial to PC mode.
 2. Turn the power on.
 3. Connect the USB cable.

1 To acquire images, click the large [Get] button on the Welcome screen, or the [Get] button on the Navigation bar.



2 Click [Computer] from the list of options displayed on the activity panel. The Open file selector is displayed. Click [Look in :] to choose Removable Disk() and click [open] for the open file window to be displayed.





HOW TO USE EDITING SOFTWARE

MGI PhotoSuite III SE

- 3 Select [Removable Disk (:)] and select folder.
Then select image and click [Open].



- 4 The Welcome screen will change to the next work step, with the selected image displayed.

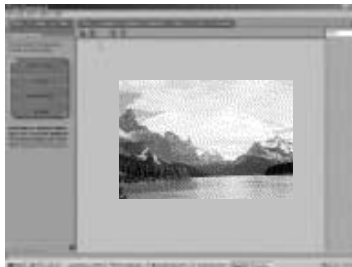



HOW TO USE EDITING SOFTWARE

MGI PhotoSuite III SE

► Acquiring images from an Album.

1 To acquire images, click the the large [Get] button on the Welcome screen, or the [Get] button on the Navigation bar. Click [Album] from the list of options displayed on the activity panel.

2 After selecting Album on the ① Choose a photo album, click an image in the album and click [Open].

3 The Welcome screen will change to the next work step, with the selected image displayed.

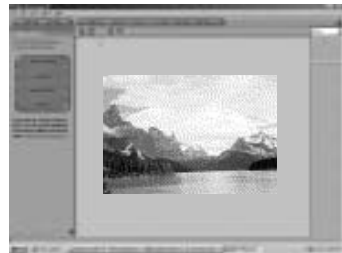



HOW TO USE EDITING SOFTWARE

MGI PhotoSuite III SE

PREPARE

When the image is loaded, the step changes to Prepare automatically.

■ Menu of [PREPARE] step

· Rotate & Crop

You can rotate, flip or crop images along with a host of others.

· Touchup

Remove Red eye, Remove Scratches etc.. are available in this menu.

· Special Effects

A number of special effects can be applied.

· Stitching

Join a series of photos together to create a sweeping panoramic effect.





HOW TO USE EDITING SOFTWARE

MGI PhotoSuite III SE

COMPOSE

Add Text , Compound Images etc.. are available in this step.

■ Menu of [COMPOSE] steps

- **Collage** : A collage consists of several photos or sections of photos arranged together on a common background.
- **Photo Layouts** : The Photo Layouts activity includes many collage and layout options.
- **Card & tag** : Use your photos to create items such as Gift Tags, Greeting Cards, Invitations, Postcards, and Sports Cards.
- **Calendars** : Use your photos to create a variety of calendars (monthly, quarterly, seasonal, yearly).
- **Collections** : Photos can also be used to create a variety of items for business purposes.

Add frames and boarder effects to your photos with the predefined templates.





HOW TO USE EDITING SOFTWARE

MGI PhotoSuite III SE

ORGANIZE

Organize your photos and other media files into albums.

■ Menu of [ORGANIZE] step

- ① Choose a photo album to view or edit
Select Album : To create an Album, click [Organize] in the welcome screen or navigation bar.
Album.. : Open Master Album.
- ② Select a photo, and choose an action below.
Open : Open selected image.
Delete : Delete selected image.
Properties.. : view image information.
- ③ Choose an action to manage your album.
Add: click [Add] to add an image to an Album.
Sort: click [Sort] to Sort saved images.
Search: click [Search] to Search saved images.
Reset: click [Reset] to reset the setting.
Update: click [Update] to update images.
Create Slide Show.. : click [Create Slide Show] to create a Slide Show.
Always start on this page : If you select this option, the program will start in [Organize].





HOW TO USE EDITING SOFTWARE

MGI PhotoSuite III SE

► Creating an Album

1 To create an Album, click the large Organize button on the Welcome screen, or the Organize button on the Navigation bar.

2 Click [Album..] in ① Choose a photo album to view or edit.



3 The Master Album window will be displayed, then click [New..].



4 Put a new Album name in the New Album window and click [OK]. A new album will now be created.





HOW TO USE EDITING SOFTWARE

MGI PhotoSuite III SE

SHARE

► Saving images

1 Saving or sharing images.

■ Menu of [SHARE] step

- **Save**
To save the active file according to its current name and path.
- **Save As**
To assign a new name or path to the file.
- **Send E-mail**
e-mailing images.
- **Send to Kodak PhotoNet Online**
Sending images to Kodak PhotoNet.
- **Share Your Pictures At GatherRoom.com**
Sending images to GatherRoom.com and sharing images.
- **Slide Show**
Viewing images as a slide show.



- 2 Click [SAVE] and the Save Project window will be displayed. Enter the file name and click [Save(S)] to save an image.





HOW TO USE EDITING SOFTWARE

MGI PhotoSuite III SE

PRINT

► Printing images

1 You can print images.

■ Menu of [PRINT] step

- **Print**
Printing images.
- **Print Multiples**
Print multiple copies of a photo or project, or one copy of each of the photos included in an album, according to a predefined template.



2 Choose a printer, choose an orientation, choose the print size, choose the number of copies. You can then print the images.



Reference

For more information, please refer to the Help file in [Help → MGI PhotoSuite III help].

Free Manuals Download Website

<http://myh66.com>

<http://usermanuals.us>

<http://www.somanuals.com>

<http://www.4manuals.cc>

<http://www.manual-lib.com>

<http://www.404manual.com>

<http://www.luxmanual.com>

<http://aubethermostatmanual.com>

Golf course search by state

<http://golfingnear.com>

Email search by domain

<http://emailbydomain.com>

Auto manuals search

<http://auto.somanuals.com>

TV manuals search

<http://tv.somanuals.com>