

SAMSUNG

SAMSUNG CAMERA

User Manual

Digital Camera

Digimax 240

Thank you for buying a Samsung Camera. This manual will guide you through using the Digimax 240, including taking images, downloading images and using the MGI PhotoSuite III SE software.

Please read this manual before using your new camera.

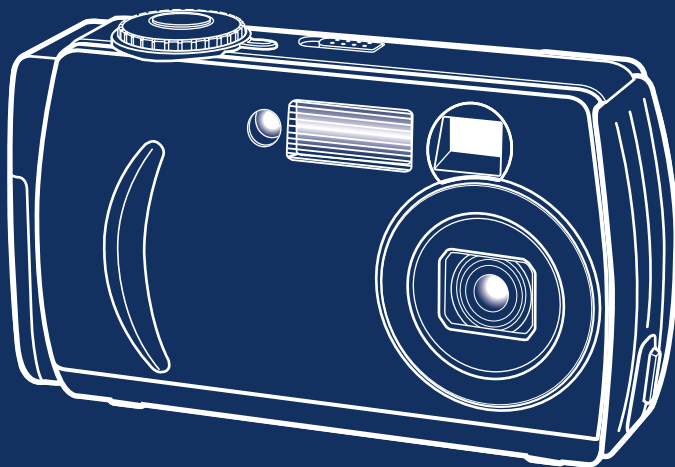

ENGLISH

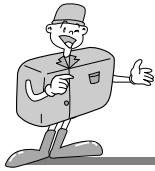

Instructions

- Use this camera in the following order

**Set up
the camera driver**

Before connecting the USB cable to the PC and this camera, you have to set up the camera driver. Install the camera driver that is contained in the Application S/W CD-ROM. (p.99)

Take a picture

Take a picture
(p.35~57)

**Insert the
USB cable**

Insert the supplied USB cable into the PC USB port and the camera USB connection terminal. (p.86~88)

**Check the camera
power**

Check the camera power. If the power is turned off, slide the camera switch to power it on. (p.38)

**Check
[Removable Disk]**

Open Window's EXPLORER and search [Removable Disk]. (p.87)



Special features

This digital camera has the following features.

- A fine resolution of 2.0 mega pixels
- A 3X optical and 2X digital zoom lens
- Movie clip recording function
- Date imprinting on a still image
- Multiple language support

An FCC warning

- This device has been tested in accordance with the limits of a class B digital device under item 15 of the FCC rules. These limits are designed to provide protection against harmful interference in commercial installation. This equipment generates, absorbs and can emit radio frequency energy. If it is not installed and used in accordance with the instructions, it may cause harmful interference to radio communication. There is however, no guarantee that interference will not occur in a some situations. Should any interference occur when this device is in operation, please try one or more of the following measures.
 - Change the location and direction of any aerial.
 - Increase distance between the camera and affected device.
 - Use a different socket away from the affected device.
 - Please contact a Samsung agent or a radio/TV engineer.
- This device complies with part 15 of the FCC Rules.



Contents

Ready

● Getting to know your camera	6
● Safety note	7
● This digital camera can be used for	10
● Manufacturer' s contents	12
● Identification of features	13
■ Product Exterior(Front / Top / Side)	13
■ Product Exterior (Back)	14
■ Viewfinder/ AF indicator lamp/ Flash indicator lamp	15
■ LCD monitor indicator	17
■ Camera mode definition	19
• MOVIE CLIP mode	19
• STILL IMAGE mode	19
• PLAY mode	19
• SETUP mode	19
■ LCD monitor menu indicator	21
● Preparation	27
■ Connecting to a Power source	27
• Using the batteries	27
• Battery condition indicator	27
• Using the AC power adapter	29
• Using the Digimax battery pack (Optional : SBP-3603)	29
■ Inserting the memory card	30
■ Removing the memory card	32
■ Instructions on how to use the memory card	32

Advanced

● Recording mode	35
■ Starting Recording Mode	35
• Recording a Movie clip	35
• Recording a still image	36
■ Using the camera button to adjust the camera	38
• POWER switch	38
• SHUTTER button	38
• LCD button	39
• MENU button	40
• ZOOM (W/T) button	41
• 5-function button	42
• UP button	43
• PAUSE/REPLAY/DOWN button	43
• FLASH / LEFT button	43
• SELF-TIMER / RIGHT button	46
• OK button	47
• MACRO button	47
■ Using the LCD monitor to adjust the camera	48
• IMAGE SIZE	49
• IMAGE QUALITY	50
• EV COMPENSATION	52
• WHITE BALANCE	53
• DIGITAL ZOOM	55
• QUICK VIEW	56
• LCD BRIGHTNESS	57
● Play mode	58
■ Starting Play Mode	58
• Playing back a still image	58
• Playing back a movie clip	59
• PLAY mode functions are listed below	59
■ Setting up the play back function by using the camera button	61
• Power switch	61
• LCD button	61
• DELETE button	62



Contents

Advanced

- MENU button 63
- THUMBNAIL / ZOOM W button 64
- ZOOM T button 65
- 5-function button 66
- UP button 67
- PLAY/STOP/DOWN button 67
- LEFT button 67
- RIGHT button 68
- OK button 68
- Setting up the play back function using the LCD monitor 69
 - SLIDE SHOW 69
 - PROTECT 70
 - DELETE ALL 71
 - LCD BRIGHTNESS 72
 - COPY TO CARD 73
 - DPOF (Digital Print Order Format) 75
- SETUP mode 76
 - Starting the SETUP mode 76
 - BEEP 76
 - FORMAT 77
 - POWER OFF 78
 - RESET 79
 - DATE IMPRINT 80
 - DATE TYPE 81
 - DATE SETUP 82
 - VIDEO OUT 83
 - LANGUAGE 85
- PC mode 86
 - Starting PC mode 86
- Important notes 89
 - Caution! 89
 - Warning indicator 91
- Before contacting a service center 92
 - Please check the following 92
- Specifications 94

Software

- Software manual 96
 - Software Notes 96
 - About software 97
 - Setting up the application software 99
 - Removing the USB Driver for Windows 98SE 107
 - Removable Disk 109
 - Removing the removable disk 110
 - Windows 98SE 110
 - Windows 2000/ME/XP 110
 - Setting up the USB Driver for MAC 112
 - Using the USB Driver for MAC 112
 - Digimax Viewer 113
 - MGI PhotoSuite III SE 114
 - GET 117
 - PREPARE 121
 - COMPOSE 122
 - ORGANIZE 123
 - SHARE 127
 - PRINT 128
- FAQ 129

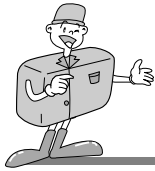

Getting to know your camera

Thank you for buying a Samsung Digital Camera.

- Prior to using this camera, please read the user manual thoroughly.
- Keep the manual in a safe place.

About the symbols

This manual contains instructions on using this camera that will help you to use this camera safely and correctly.

This will help prevent danger and injury to others.



DANGER

DANGER

DANGER indicates an imminently hazardous situation which, if not avoided, will result in death or serious injury.



WARNING

WARNING

WARNING indicates a potentially hazardous situation, which, if not avoided, could result in death or serious injury.



CAUTION

CAUTION

CAUTION indicates a potentially hazardous situation, which, if not avoided, may result in a minor or moderate injury.



NOTICE

NOTICE indicates a factor, which, if not avoided, may result in camera malfunction or poor image quality.



INFORMATION

INFORMATION indicates a factor, which should assist further in the operation of the camera.



Safety note



DANGER

- Do not attempt to modify this camera in any way. This may result in fire, injury, electric shock or severe damage to you or your camera. Internal inspection, maintenance and repairs should be carried out by your dealer or Samsung Camera Service Center.
- Please do not use this product in close proximity to flammable or explosive gases, as this could increase the risk of explosion.

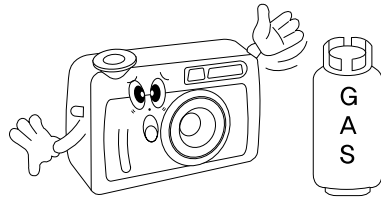
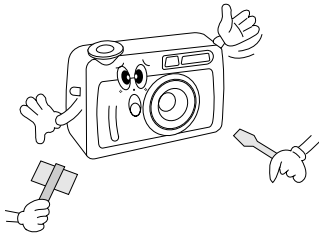

- Should any form of liquid or a foreign object enter the camera, do not use it. Switch off the camera, and then disconnect the power source (batteries or AC Power Adapter). You must contact your dealer or Samsung Camera Service Center. Do not continue to use the camera as this may cause a fire or electric shock.
- Do not insert or drop metallic or inflammable foreign objects into the camera through access points e.g. Memory card slot and battery chamber. This may cause a fire or electric shock.
- Do not operate this camera with wet hands. This could pose a risk of electric shock.

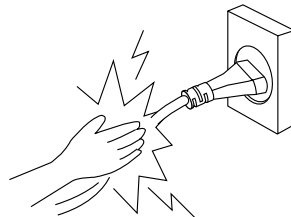



Safety note



WARNING

- Do not use the flash in close proximity to people or animals. Positioning the flash too close to your subject's eyes, may cause eyesight damage.
- When taking photographs, never point the lens of the camera directly into very strong light. This may result in permanent damage to the camera or your eyesight.

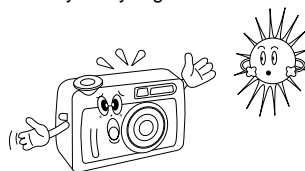
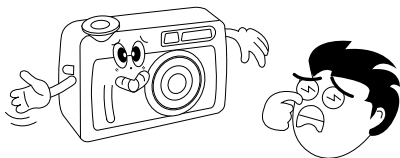

- For safety reasons keep this product and accessories out of reach of children or animals to prevent accidents e.g.:
 - Swallowing batteries or small camera accessories. In case of accidents, please consult a doctor immediately.
 - There is a risk of permanent eye damage if the flash is operated at a distance of less than one meter from a person's eyes.
 - There is a possibility of injury from the camera's moving parts.
- Do not leave this camera in places subject to extremely high temperatures, such as a sealed vehicle, direct sunlight or other places of extreme variances in temperature. Exposure to extreme temperatures may adversely affect the camera's internal components and could cause a fire.
- When in use, do not cover the camera or AC Power Adapter. This may cause heat to build up and distort the camera body or cause a fire. Always use the camera and its accessories in a well-ventilated area.

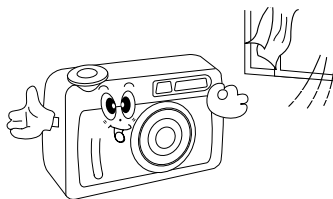



Safety note



CAUTION

- Leaking, overheating, or burst batteries could result in fire or injury.
 - Use batteries with the correct specification for the camera.
 - Do not short circuit, heat or dispose of batteries in fire.
 - Do not use old batteries with new ones, or mix brands of batteries.
 - Ensure the batteries are positioned correctly with regard to polarity (+ / -).
- When the camera is not in use for long periods, always unplug the camera from its power source.
- Do not fire the flash while it is in contact with hands or any objects. Do not touch the flash after using it continuously. It may cause burns.
- Do not move the camera while it is switched on, if you are using the AC Power Adapter. After use, always switch off the camera before unplugging the adapter from the AC Power wall socket. Then make sure that any connector cords or cables to other devices are disconnected before moving the camera. Failure to do so may damage the cords or cables and cause a fire or electric shock.

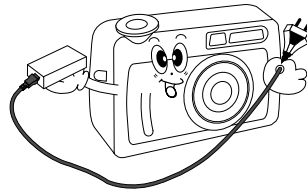



This digital camera can be used for

Viewing images on TV
(refer to page 83)

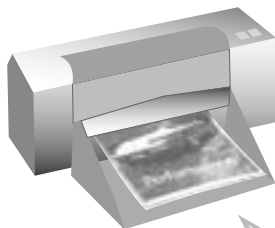

Printing images using a dedicated printer, DPOF-compatible printer or DPOF-equipped photo lab.
(refer to page 75)



Taking a picture.
(refer to page 35 ~ 57)



Downloading image files from camera to computer.
(refer to page 86 ~ 88)



Editing images on a PC
(refer to page 114 ~ 128)



This digital camera can be used for

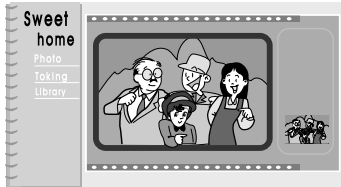

Creation of a digital photo album



Inserting images directly into any electronic document

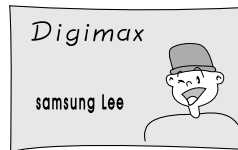

Taking a self-portrait and using the image to personalize name cards

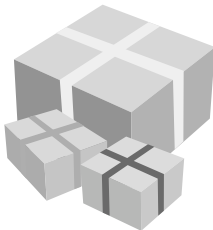

You can even create your own unique gift-wrap paper by using your digital images



Manufacturer's contents

Please check that you have the correct contents before using this product.

marked contents are optional.

Digital camera



2 AA Alkaline Batteries



Pouch



Video cable



USB cable



Camera strap



User manual



Product warranty



Applications S/W-
Driver CD-ROM



SD memory card



Battery pack
(SBP-3603)



AC Adapter
(3.3V)



SAMSUNG Ni-MH Battery Pack : SNB-2012 KIT

Battery charger



2 AA Ni-MH
Batteries



AC adapter(3.3V)



Digimax Battery I-Pack : SBP-1103 KIT

Battery charger Rechargeable
battery



AC adapter(5V)



Warning

Do not insert the Digimax Battery I-Pack (SBP-1103 Kit) AC adapter plug (5V, optional) to the DC input connection point as this results in electric shock or severe damage to your camera. Please ensure that you use an AC adapter (3.3V, optional) with the correct specification for the camera.



Identification of features

Product Exterior(Front / Top / Side)

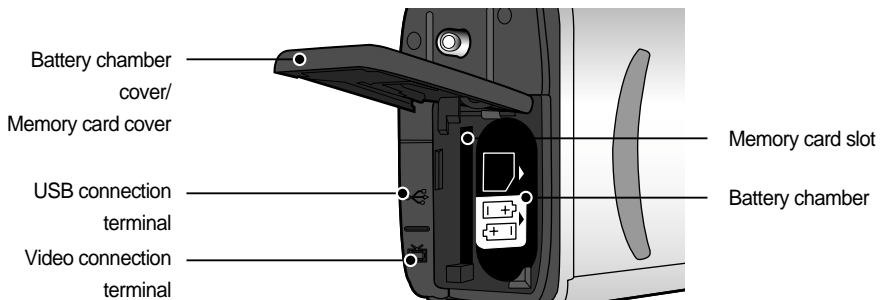
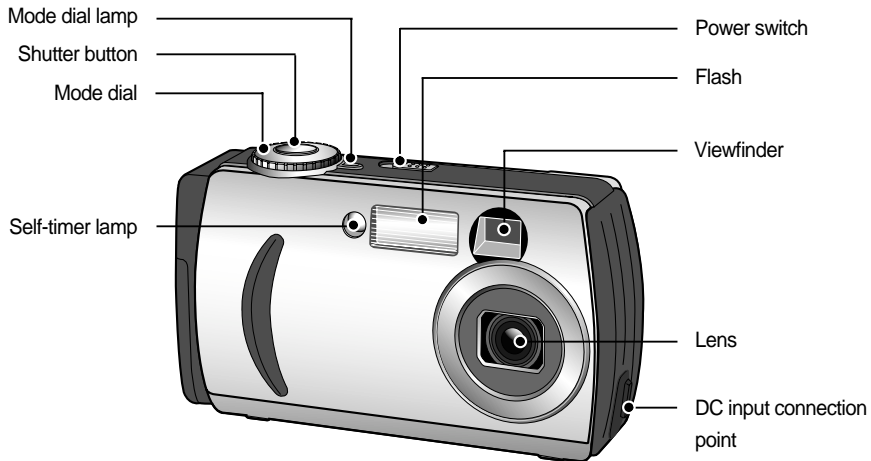

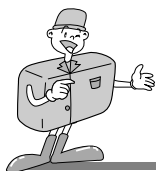

Identification of features

Product Exterior (Back)

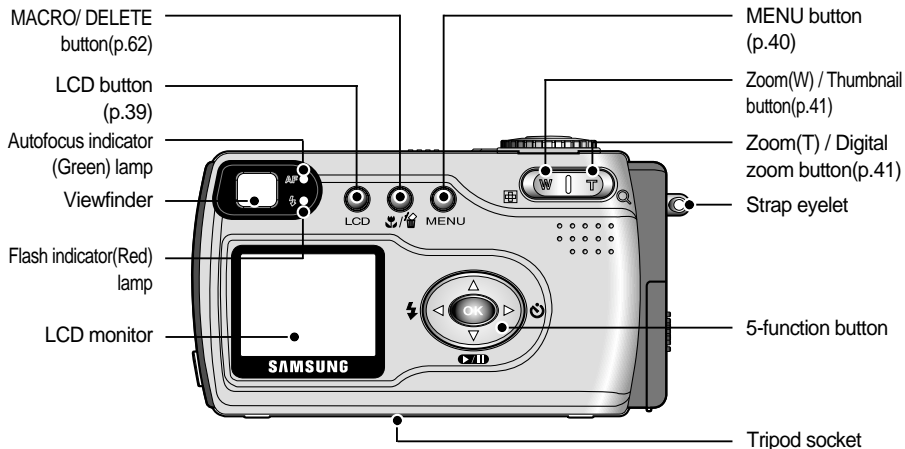

UP(▲) button (p.43)

FLASH/ LEFT(◀) button (p.43)

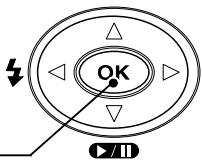

SELF-TIMER/ RIGHT(▶) button (p.46)

OK button (p.47)

PLAY/STOP/ DOWN(▼) button (p.43)

[5-function button]



Identification of features

Viewfinder/ AF indicator lamp/ Flash indicator lamp

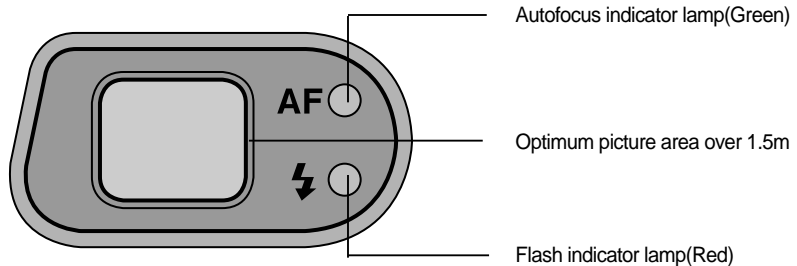

■ Camera status lamp

lamp	Status	Camera status
AF/Flash lamp	Off	System ready
AF indicator lamp	Blinking (Green)	When the autofocus can't activate (when the shutter button is pressed half way down)
		In dark conditions
		Image processing(compression/decompression)
		USB busy(PC mode)
Flash lamp	Illuminating (Red)	The flash is being charged
		The flash is ready for firing (when the shutter button is pressed half way down)
		Power on processing



Identification of features



INFORMATION

■ Self-timer lamp

Color	Status	Camera condition
Red	Blinking	For the first seven seconds, the LED blinks slowly. For the final three seconds, the LED blinks quickly.
	Blinking once	When the shutter button is released after being pressed.

■ Beep

Beep sound	Time	Camera condition
Normal beep	Once	When the camera power is turned on/off. Rotating the mode dial/ pressing the shutter button/ Pressing the camera buttons
Error beep	3 times	When an error occurs
Self-timer beep	Once	A beep will sound when the self-timer lamp blinks

- To hear the beep sound, you have to set the beep sound to "ON" in the setup mode menu.

■ Mode dial lamp

Color	Status	Camera condition
Green	Blinking once	When the camera power is turned on/off. / When the shutter button is released after being pressed.
	Blinking twice	Rotating the mode dial(changing the camera working mode)
	Illuminating	When the LCD monitor is turned off (by pressing the LCD button) The camera buttons are not operated for over 60sec. The camera is in PC mode.



Identification of features

LCD monitor indicator

The LCD monitor displays information about the shooting conditions.

■ Recording mode

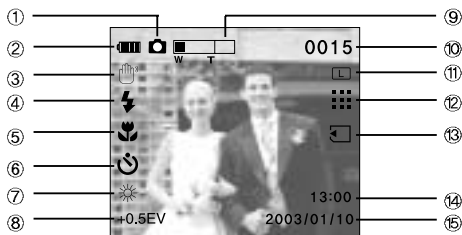

[Image & Full Status]

No.	Description	Icons	Page
1	Recording mode		p.35/36
2	Battery		p.27
3	Camera shake warning		p.37/44
4	Flash		p.44
5	Macro indicator		p.47
6	Self-timer		p.46
7	White balance	AUTO	p.54
8	Exposure compensation	+0.5 EV (Exposure Value)	p.52
9	Digital zoom(Large image size)		p.55
10	Number of available shots remaining(still image)	0015	
	Recording time (movie clip)	00:20	
11	Image size		p.49



Identification of features

No.	Description	Icons	Page
12	Quality		p.50
13	Memory card indicator		p.30
14	Time	13:00	
15	Date	2003/01/10	

■ Play mode

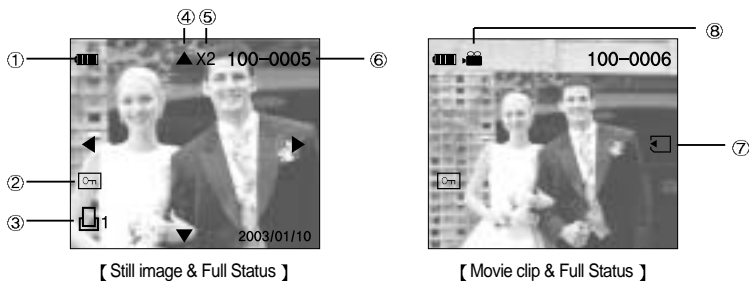

No.	Description	Icons	Page
1	Battery		p.27
2	Protect indicator		p.70
3	DPOF indicator		p.74
4	Digital zoom indicator		p.55
5	Digital zoom magnification rate indicator	X2	p.65
6	Number of stored images	100-0005	
7	Memory card indicator		p.30
8	Movie clip indicator		p.35



Identification of features

Camera mode definition

You can select the desired working mode by using the mode dial located on the top of the camera. This digital camera has 4 working modes. These are listed below

■ MOVIE CLIP mode ()

This mode is used for movie clips.

The flash is changed to FLASH OFF when this mode is selected.

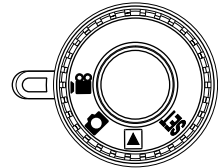

[Mode dial]

■ STILL IMAGE mode ()

This mode is used for still image shots

Normal : 0.8m ~ infinity

Macro : Wide - 0.1m ~ 0.8m

Tele - 0.4m ~ 0.8m

■ PLAY mode ()

In this mode, the stored images on the memory can be viewed on the LCD monitor on the back of the camera or on an external monitor using a video output terminal.

■ SETUP mode ()

In this mode, you can set up basic settings such as BEEP, FORMAT, POWER OFF, RESET, DATE/TIME, VIDEO OUT, LANGUAGE.



INFORMATION

■ PC mode

Your computer will recognize the camera as a Removable Disk when connected by the USB cable. You can transfer images between the computer and the camera. You have to install the camera driver before connecting the USB cable. The camera working mode will be changed to PC mode by connecting the USB cable.



Identification of features

■ Selecting camera mode and menu

You can select a camera mode or a camera mode menu by pressing the MODE dial or MENU button as below.

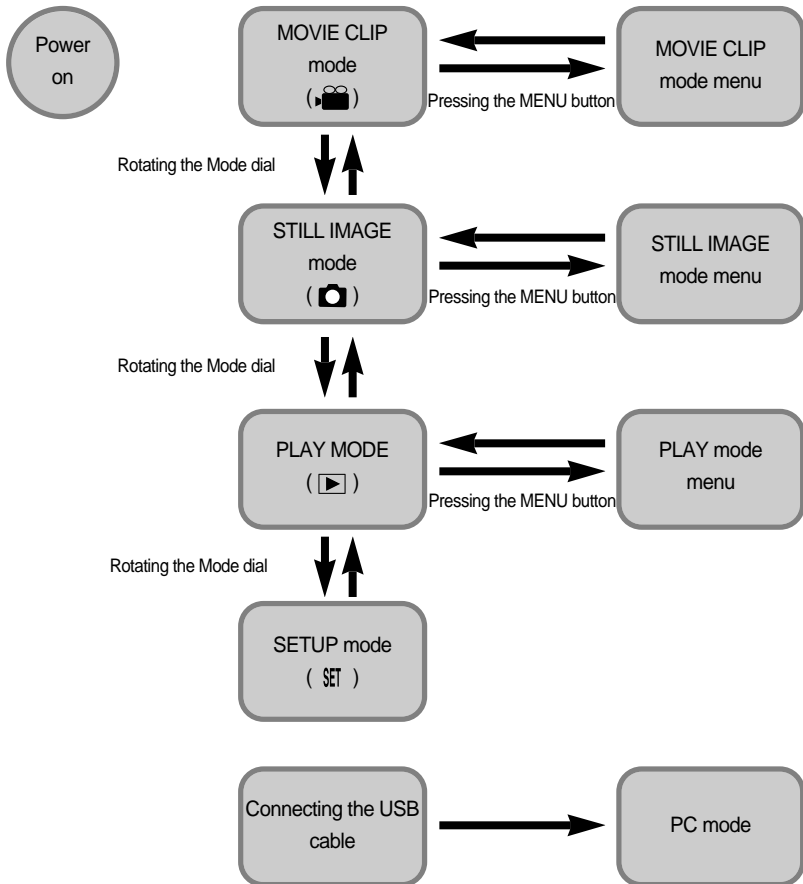



Identification of features

LCD monitor menu indicator

Each mode has a menu as shown below. * marked sub menu is the default setting.

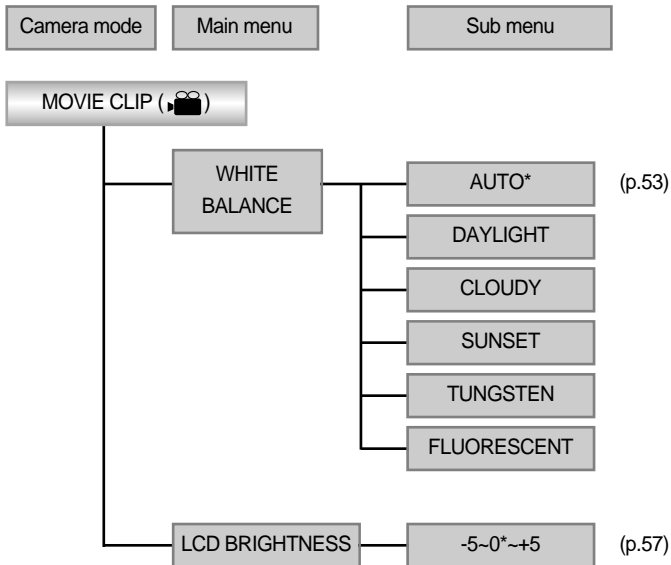



Identification of features

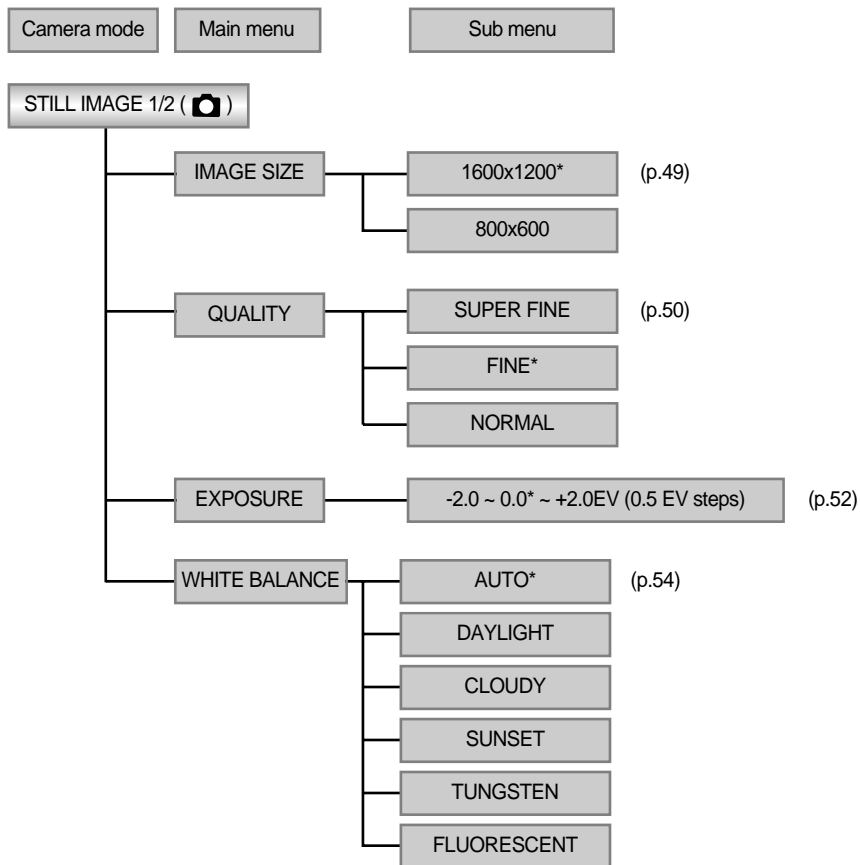



Identification of features

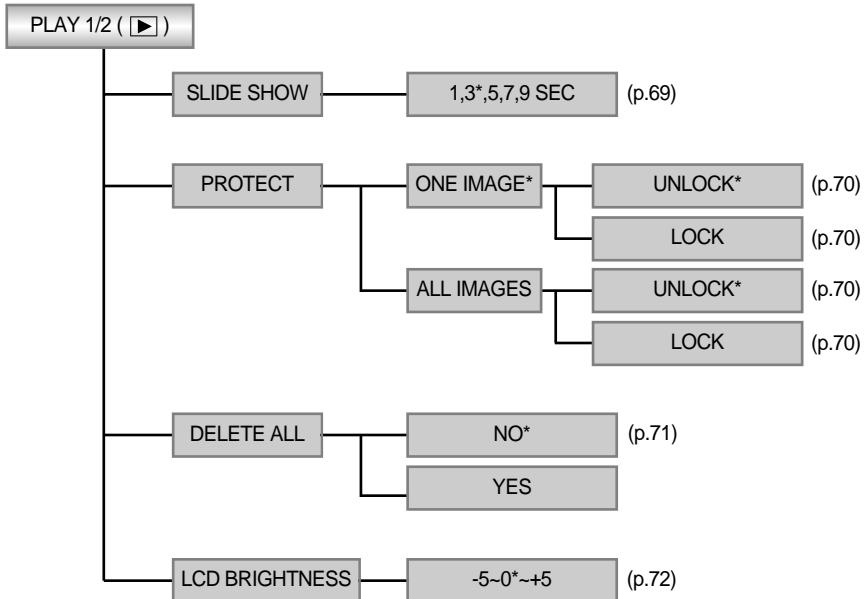
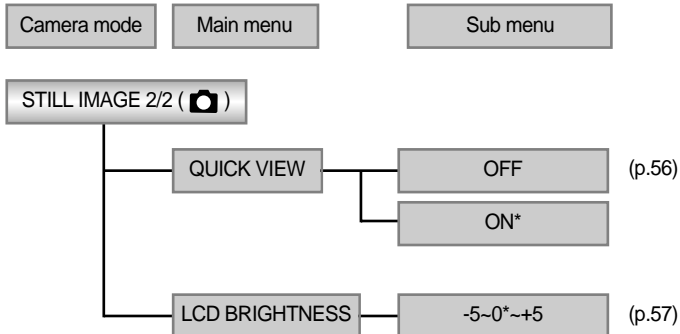

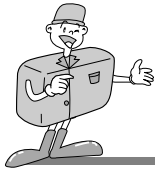

Identification of features

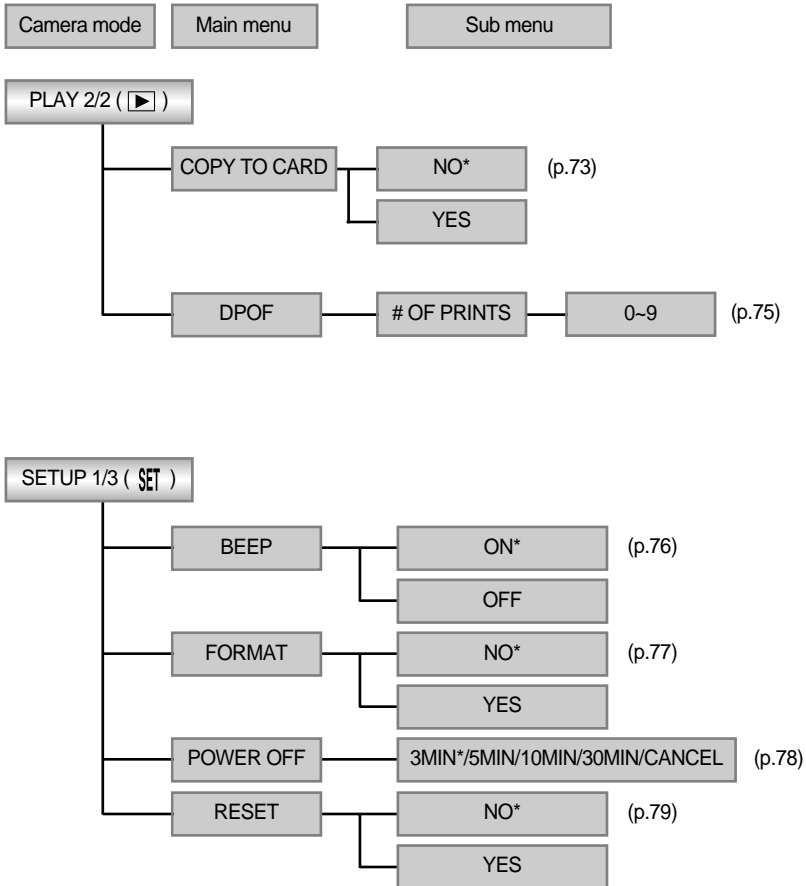

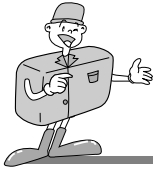

Identification of features

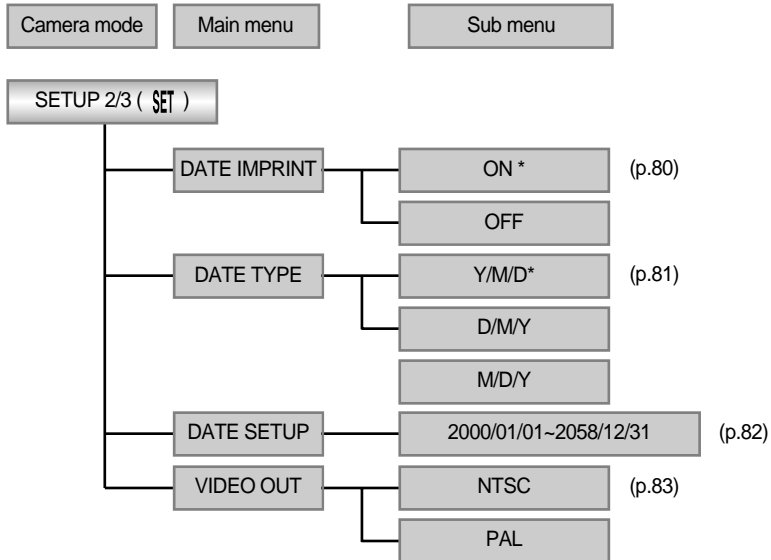

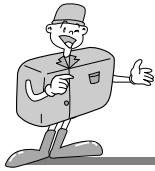

Identification of features

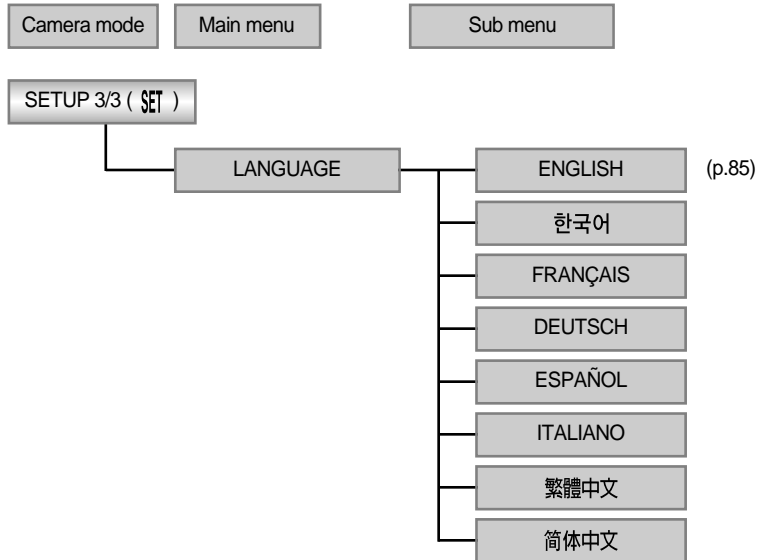

INFORMATION

- There is no associated menu in PC mode and the LCD monitor is always turned off in PC mode.



Preparation

Connecting to a Power source

There are two ways in which to provide the camera with power. You can use batteries(AA Alkaline, Ni-MH, CR-V3), or alternatively, you can use an AC(100V ~ 250V) Adapter (DC 3.3V 2.0A).

■ Using the batteries

1. Open the battery chamber cover by pushing in the direction of the arrow.
2. Insert the batteries taking note of the polarity (+ / -).
3. To close the battery chamber cover, push it until it clicks.

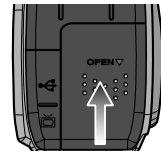
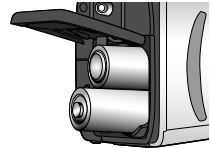
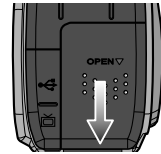

■ Battery condition indicator

There are 3 indicators for battery condition that are displayed on the LCD monitor.

 : The batteries are fully charged.

 : Prepare new batteries.

 : There is no battery capacity. Replace with new batteries.



Preparation



INFORMATION

- The date & time setting menu will be displayed on the LCD monitor in the following circumstances:
Check the date & time. If the date & time are incorrect, change them before taking a picture.
 - When the camera is used for the first time.
 - Even if the batteries or AC adapter are removed, it is necessary to reset the time /date.
- This camera will automatically switch off when not in use for a period of time.
Refer to [POWER OFF] function(p.78).



NOTICE

- Important information about battery usage
 - Please remove the batteries if the camera will not be used for long periods. Batteries can lose power over time and are prone to leaking if kept inside the camera.
 - We recommend high capacity ALKALINE batteries as manganese batteries cannot deliver sufficient power.
 - Low temperatures (below 0°C) can affect the performance of the batteries and you may experience reduced battery life.
 - Batteries will usually recover at normal temperatures.
 - Do not use old and new batteries at the same time.
 - During extended use of the camera, the camera body may become warm. This is perfectly normal. If you are planning to use this camera for long periods of time, it is advisable to use an AC adapter.



Preparation

■ Using the AC power adapter

- If you have access to a mains supply, using an AC Adapter allows the camera to be used for long periods of time. If you connect the camera to a computer, it is advisable to use an AC adapter, as this will enable extended use.
- Plug the adapter into the connection point (DC IN 3.3V) on the camera.

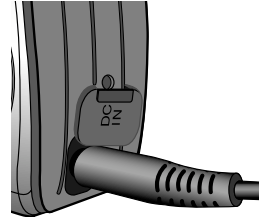

DANGER

- Always turn off the power before taking the AC adapter out of the mains supply.
- As with all mains powered devices, safety is important. Ensure that neither the camera nor adapter comes into contact with water or metallic materials.
- Please ensure that you use an AC adapter with the correct specification for the camera (3.3v 2.0A). Failure to do so may affect your warranty.

● Using the Digimax battery pack (Optional : SBP-3603)

The Digimax Battery Pack is a rechargeable external Li-ion battery for use with most digital cameras.

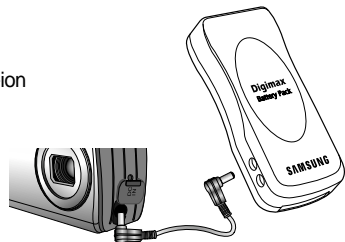

These optional battery packs provide long lasting power and their operating performances are much improved over Ni-MH and Alkaline batteries. This is due to the mass storage lithium ion cell. Contact your local dealer or the nearest authorized Samsung camera service center to buy the optional battery packs.



Preparation

Inserting the memory card

The camera comes with 8MB of internal flash memory, allowing you to store images and movie clips in the camera. However, you can expand the memory capacity by using an optional memory card so that you can store more images and movie clips.

1. Turn off the camera power and pull the memory card cover in the direction of the arrow to open.

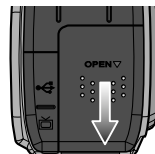

2. Insert the memory card all the way into the memory card slot. The Label stuck to the memory card and the front side of the camera should face in the same direction. The memory card pins and the LCD monitor should face in the same direction. The memory card will then be fitted.

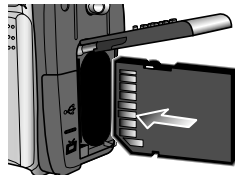

3. To close, push the memory card cover against the arrow until you hear a click.
 - Once the CARD is inserted, the memory card indicator will appear on the LCD monitor.
 - If the CARD does not fit, check that it is inserted correctly. Do not force the memory card.

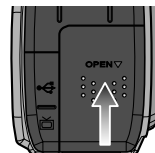

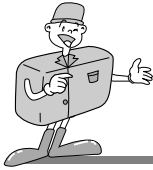

Preparation

The SD memory card has a write protect switch that prevents image files from being deleted or formatted. By sliding the switch to the bottom of the memory card, the data will be protected. By sliding the switch to the top of the memory card, the data protection will be canceled. Check the switch position before taking an image.

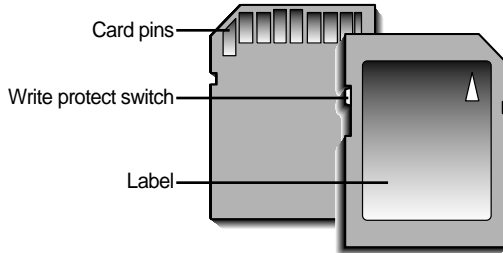

【 SD(Secure Digital) memory card 】



Preparation

Removing the memory card

1. Turn the power off using the power switch.
2. Open the memory card cover and press the memory card as shown in the image and release.
3. Remove the memory card and close the memory card cover.

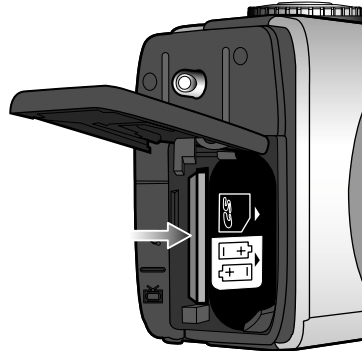

NOTICE

- Don't remove the memory card when the AF lamp(Green) is illuminated as this may cause damage to data in the memory card.

Instructions on how to use the memory card

- Using a new memory card for the first time
 - Before using the memory card, it must be initialized.
 - Format prepares the memory for recording data.
 - Refer to page 77 for information on [FORMAT].



Preparation

■ Memory capacity

- When using the internal memory, the specified shooting capacity will be as follows. (These figures are intended as an indication of expected performance)

Recorded image size	Recorded image quality	Number of shots
		Internal Memory
1600X1200 (Large)	Super Fine	10
	Fine	15
	Normal	20
800 X 600 (Small)	Super Fine	30
	Fine	45
	Normal	60

- These figures are approximate as image capacities can be affected by variables such as memory performance and subject matter.

■ Maintenance of the memory card

- Turn off the camera power whenever the CARD is being inserted or removed.
- Repeated use of the CARD will eventually reduce the memory card's performance. Should this be the case, you will need to purchase a new CARD. Wear and tear on the CARD is not covered by the Samsung Warranty.
- The CARD is an electronic precision device. Do not bend, drop or subject the memory card to any heavy impact.
- Do not store the CARD in an environment with strong electronic or magnetic fields, e.g. near loud speakers or TV receivers.
- Please do not use or store in an environment where there are extremes in temperature.
- Do not allow the CARD to become dirty or to come into contact with any liquid. Should this happen, clean the memory card with a soft cloth.
- Please keep the CARD in its case when not in use.
- During and after periods of extended use, you may notice that the CARD is warm. This is perfectly normal.

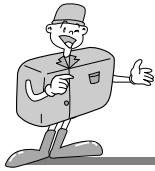

Preparation

■ Preserving the memory card data

- If the memory card is subjected to any of the following, the recorded data may become corrupted :
 - When the CARD is used incorrectly.
 - If the power is switched off or the CARD is removed while recording, deleting(formatting) or reading.
- Samsung cannot be held responsible for lost data.
- It is advisable to copy important data onto other media as back-up e.g. floppy disks, hard disks, CD etc.



INFORMATION

- If there is no memory card, the memory card indicator will not be displayed on the LCD monitor.
- If there is insufficient memory available:
 - If you press the shutter button for the shot, the following message is displayed and the camera will not operate.

MEMORY FULL !

To optimize the amount of memory in the camera, replace the CARD or delete unnecessary images stored on the memory.



Recording mode

Starting Recording Mode

- If the CARD is inserted in the camera, all the camera functions are applied only to the CARD.
- If the CARD is not inserted in the camera, all the camera functions are applied only to the internal memory.

■ Recording a Movie clip

1. Insert the batteries(p.27). Insert the batteries taking note of the polarity (+ / -).
2. Insert the CARD(p.30). As this camera has an 8MB internal memory, you do not need to insert the SD memory card. If the CARD is not inserted, an image will be stored in the internal memory. To expand memory capacity, insert the CARD. If the CARD is inserted, an image will be stored on the CARD.
3. Close the memory card cover.
4. Slide the power switch to turn on the camera. (When you turn on the camera power, the date/time setting menu may be displayed. If the date/time is incorrect, reset the date/time before taking a picture. (p.82)
5. Select the MOVIE CLIP() mode by rotating the mode dial.

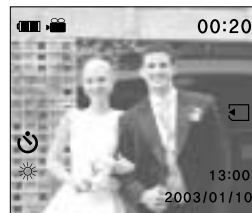
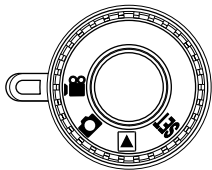

【MOVIE CLIP mode】

6. The MOVIE CLIP mode icon and available recording time will display on the LCD monitor. (max. 3min)



Recording mode

7. Point the camera towards the subject and compose the shot by using the viewfinder or LCD monitor. Press the shutter button and movie clips are recorded for as long as the available recording time. Movie clips will still be recorded if the shutter button is released. The movie clip icon will blink during the recording process.
- If you wish to stop recording, press the shutter button again.
 - Image size and type are listed below.
 - Image size : QVGA (320 x 240)
 - File type : *.AVI



NOTICE

- The available recording time depends on the memory capacity.
- The flash is changed to FLASH OFF when this mode is selected.
- The zoom function can't be activated in the movie clip mode.

■ Recording a still image

- Steps 1 - 4 are the same as those for recording a still image.
5. Select the STILL IMAGE () mode by rotating the mode dial.
 6. Point the camera towards the subject and compose the image by using either the viewfinder or LCD monitor.
 7. Press the shutter button to capture an image.

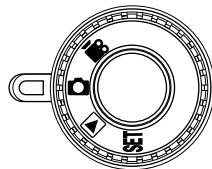



Recording mode



INFORMATION

- Under the following conditions, the date/time setting menu may be displayed. If the date/time is incorrect, reset the date/time before taking a picture. (p.82)
 - When you use this camera for the first time.
 - Whenever the AC adapter and batteries are removed.



NOTICE

- Under certain conditions the auto focus system may not perform as expected.
 - When photographing a subject that has little contrast.
 - If the subject is highly reflective or shiny.
 - If the subject is moving at high speed.
 - When the subject matter has only horizontal lines or the subject is very narrow (such as a stick or flagpole).
 - When there is strong reflected light, or when the background is very bright.
 - In dark conditions
- Camera shake warning.

When the Flash Off or Slow synchro mode is selected, the camera shake warning indicator () may appear on the LCD monitor

In this case, use a tripod, support the camera on a solid surface or change the flash mode to flash shot mode.
- Backlight compensated shot

When taking an outdoor shot, avoid facing the sun, as the image may be dark because of the strong backlight. In backlight conditions, please use exposure compensation (p.52).
- Avoid obstructing the lens or the flash when you capture an image.
- As there can be some differences between what is seen through the Viewfinder and the resulting image when taken at a range closer than 1.5m, it is recommended that you use the LCD monitor to compose the shot.
- Using the LCD monitor extensively will drain the batteries.

We recommend turning off the LCD monitor and using the optical viewfinder as often as possible in order to extend battery life.
- To avoid images being unclear, keep within the focus range.

Normal	: 0.8m ~ infinity	
Macro	: Wide : 0.1m ~ 0.8m	Tele : 0.4m ~ 0.8m

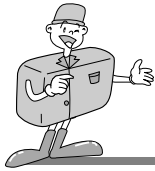

Recording mode

Using the camera button to adjust the camera

- The STILL IMAGE/MOVIE CLIP mode function can be set up by using the camera button.

POWER switch

- Used for turning the camera power on / off.
- If this camera isn't operated during the specified time (about 60 SEC.), the camera power will be idle (LCD monitor : Off, Mode dial lamp : Blinking) automatically.

To use the camera again, press any of the camera buttons except the power switch.

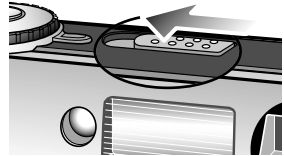

SHUTTER button

- Used for taking images in the RECORDING (STILL IMAGE/ MOVIE CLIP).
- Pressing the shutter button down halfway activates the autofocus and the AF indicator lamp blinks quickly. After selecting the focus, the AF indicator lamp will illuminate. While the AF indicator lamp is illuminated, pressing the shutter button down fully will take the image.

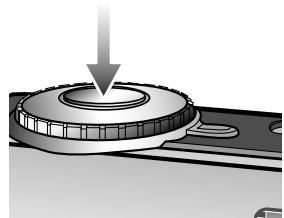



Recording mode

LCD button

- Pressing the LCD button in the RECORDING(STILL IMAGE, MOVIE CLIP) mode will change the display as shown below.

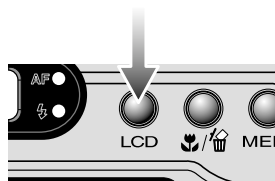

- STILL IMAGE mode

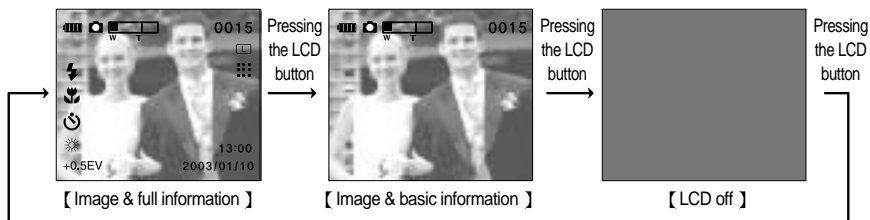

- MOVIE CLIP mode

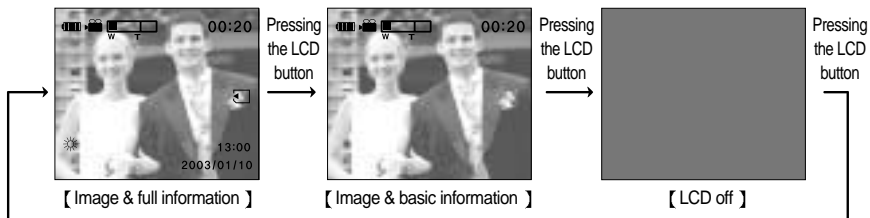

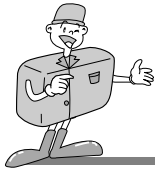

Recording mode

MENU button

- When you press the MENU button, a menu related to each camera mode will be displayed on the LCD monitor. Pressing it again will return the LCD to the initial display.

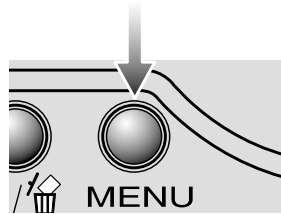

[MENU off]

Pressing the
MENU button

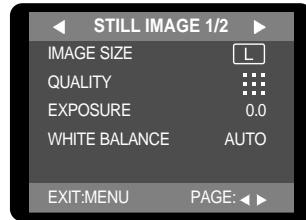

[MENU on]

- A menu option can be displayed when the following are selected : STILL IMAGE mode, MOVIE CLIP mode, PLAY mode and SETUP mode. There is no menu available when the PC mode is selected. Refer to page 86~88 for information on the camera mode menu.



Recording mode

ZOOM (W/T) button

- Used for digital or optical zooming in / out (STILL IMAGE mode)
- This camera has a 3X optical zoom and a 2X digital zoom function. Using both will offer a total zoom ratio of 6X.
- When you press the zoom (W/T) button, the zoom bar will display in the upper left of the LCD monitor.

■ Optical Zoom

● Zoom TELE

Press zoom button T. This will zoom into the subject i.e. the subject will appear nearer.

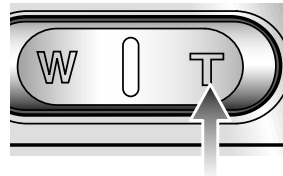

● Zoom WIDE

Press zoom button W. This will zoom out from the subject i.e. the subject will appear further away. Pressing the W button continuously will set the camera to its minimum zoom setting i.e. the subject appears at its furthest from the camera.

● Digital Zoom

- You can use the digital zoom only in the large image size.
- The digital zoom will operate only when the optical zoom is at its maximum. When the subject appears to be at its closest, pressing the T button will operate the digital zoom.



【 A normal image 】

Pressing the ZOOM T button



Pressing the ZOOM W button

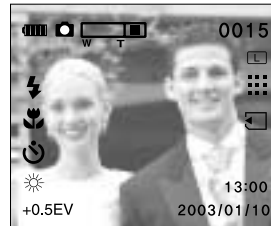

【 Digital zoomed image 】



Recording mode

NOTICE

- The digital zoom cannot be used in the MOVIE CLIP mode.
- The digital zoom only applies to the LARGE(1600X1200) image size.
- An image that is taken by using the digital zoom is stored as an 800x600 image size.
- The digital zoom function doesn't apply to a SMALL(800 X 600) image size.

5-function button

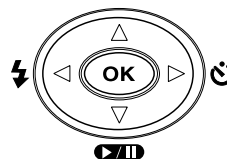

Explanation of the 5-function button

[5-function button]

BUTTON	MENU DISPLAY	STILL IMAGE mode	MOVIE CLIP mode	Page
UP(▲) button	ON	Makes the menu cursor move up	Makes the menu cursor move up	p.43
	OFF	No function	No function	
DOWN(▼) button	ON	Makes the menu cursor move down	Makes the menu cursor move down	p.43
	OFF	No function	No function	
LEFT(◀) button	ON	Makes the menu cursor move to main menu	Makes the menu cursor move to main menu	p.43
	OFF	Selecting the flash mode	No function	
RIGHT(▶) button	ON	Makes the menu cursor move to sub menu	Makes the menu cursor move to sub menu	p.46
	OFF	Select / Cancel the self-timer	Select / Cancel the self-timer	
OK button	ON	Confirming the selection	Confirming the selection	p.47
	OFF	No function	No function	



Recording mode

UP(▲) button

- When the menu is displayed on the LCD monitor, pressing the UP(▲) button makes the menu cursor move up.

DOWN(▼) button

- When the menu is displayed on the LCD monitor, pressing the DOWN(▼) button makes the menu cursor move down.

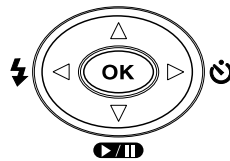

FLASH(⚡)/ LEFT(◀) button

- When the menu is displayed on the LCD monitor, pressing the LEFT(◀) button makes the menu cursor move to the main menu.
- When the menu is not displayed on the LCD monitor, the LEFT (◀) button operates as the FLASH button(⚡).

■ Selecting the flash mode

- The flash activates only in the STILL IMAGE mode.

1. Do not turn the LCD monitor off.
2. Select the STILL IMAGE mode by rotating the mode dial.
3. Press the FLASH button(⚡) until the desired FLASH mode indicator displays on the LCD monitor. Use the correct flash to suit the environment.

■ The default of each mode is listed below.

- STILL IMAGE mode : Auto flash
- MOVIE CLIP mode : Flash off(fixed)



[Selecting the Auto flash]



Recording mode

■ Flash mode indicator

FLASH MODE	Indicator	Definition
Auto flash		If the subject or background is dark, the camera flash will operate automatically.
Auto & Red eye reduction		If a subject or background is dark, the camera flash will work automatically and will reduce the red-eye effect by using the red-eye reduction function.
Slow synchro	 	When you take an image at night, a slow shutter speed results in the background and the subject being bright. We recommend using a tripod. When you take an image in a low lighting condition, the camera shake warning indicator () will display on the LCD monitor
Fill in flash		The flash fires regardless of available light.
Flash off	 	The flash does not fire. Select this mode when capturing images at a place where flash photography is prohibited. When you take an image, the camera shake warning indicator () will display on the LCD monitor

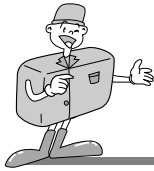

Recording mode



NOTICE

- Using the flash frequently will reduce the life of the batteries. Under normal operating conditions the charging time for the flash is normally within 10 seconds. If the batteries are weak, the charging time will be longer.
- Take photographs within the flash range.
 - The flash range
The flash ranges are listed below
 - WIDE(W) : 0.5m ~ 2.5m
 - TELE(T) : 0.5m ~ 1.8m
- In the macro mode, the flash is turned to Flash off automatically.
- The image quality is not guaranteed if the subject is too close or highly reflective.



Recording mode

SELF-TIMER(☺)/ RIGHT(▶) button

- When the menu is displayed on the LCD monitor, pressing the RIGHT(▶) button makes the menu cursor move to sub menu.
- When the menu is not displayed on the LCD monitor, the RIGHT(▶) button operates as the SELF-TIMER button(☺) in RECORDING(STILL IMAGE/ MOVIE) mode.
- This function is used when the photographer would also like to be in the picture.

■ Selecting the self-timer

- The self-timer activates only in RECORDING (STILL IMAGE/ MOVIE CLIP) mode.
 - Use a tripod or place the camera on a stable surface.
1. Do not turn the LCD monitor off.
 2. Select RECORDING (STILL IMAGE/ MOVIE CLIP) mode by rotating the mode dial.
 3. If the self-timer indicator is displayed on the LCD monitor by pressing the SELF-TIMER button(☺), the setting is completed. Press the self-timer button again, and the self-timer is canceled.
 4. Pressing the shutter button will allow an interval of ten seconds before the image is taken. After that, the self-timer is cancelled.
- In MOVIE CLIP mode, the movie clip can be recorded as long as the memory allows. To stop the recording, press the shutter button.



INFORMATION

- The default is OFF.
- The self-timer LED lamp(red) will blink for 10 seconds after the SELF-TIMER button has been pressed.
 - For the first seven seconds, the LED blinks slowly.
 - For the final three seconds, the LED blinks quickly.
- If you want to cancel the self-timer operation, press the self-timer button again.



Recording mode

OK button

- When the menu is displayed on the LCD monitor, the OK button is used for confirming data that is changed by using the ▲/▼/◀/▶ buttons.

MACRO() button

- Used for macro shots

■ Selecting the Macro focus

1. Turn the camera power on.
2. Select the STILL IMAGE mode by rotating the mode dial.
3. Press the Macro button and the Macro indicator will be displayed on the LCD monitor() .
4. Point the camera towards the subject and compose the image by using either the viewfinder or LCD monitor. (When you take an image at a range closer than 1.5m, it is recommended that you use the LCD monitor to compose the shot.)
5. Take a picture



NOTICE

- Photography range in the macro mode :
Wide : 0.1m ~ 0.8m
Tele : 0.4m ~ 0.8m
- In the macro mode, the flash is turned to Flash off automatically.



Recording mode

Using the LCD monitor to adjust the camera

- Recording functions can be changed by using the LCD monitor.
- In the RECORDING (STILL IMAGE/MOVIE CLIP) mode, pressing the MENU button displays the menu on the LCD monitor.
- The following functions are available, depending on the mode you have selected (STILL IMAGE, MOVIE CLIP).

Mode	STILL IMAGE mode	MOVIE CLIP mode	PAGE
IMAGE SIZE	O	X	p.49
IMAGE QUALITY	O	X	p.50
EV COMPENSATION	O	X	p.52
WHITE BALANCE	O	O	p.53
QUICK VIEW	O	X	p.56
LCD BRIGHTNESS	O	O	p.57



INFORMATION

- The menu will not be displayed on the LCD monitor under the following conditions:
 - When another button is being operated.
 - While image data is being processed. (When the green LED next to the viewfinder blinks)
 - When there is no battery capacity.
 - When the flash is charged
- When the menu is showing on the LCD monitor, it is not possible to operate the shutter button i.e. take an image. To take an image, simply cancel the menu display by pressing the MENU button. The menu will no longer show and the camera is ready to take an image.



Recording mode

IMAGE SIZE

- In the STILL IMAGE mode, you can select the image size.
- A large image uses more memory, so increasing image size will reduce the total number of shots you can store on a memory.
- The image sizes are listed below.

L 1600X1200

S 800X600

■ Selecting the image size

1. Turn the camera power on.
2. Select the STILL IMAGE mode by rotating the mode dial.
3. Do not turn the LCD monitor off.
4. Press the MENU button to display the menu on the LCD monitor.
5. Press the UP(▲)/ DOWN(▼) button and select [IMAGE SIZE].
6. Press the RIGHT(▶) button and the sub menu will display.
7. Press the UP(▲)/ DOWN(▼) button and select [L] or [S].
8. Press the OK button to confirm the setting.

The default is [1600x1200 [L]].

9. Press the MENU button to cancel the menu display.

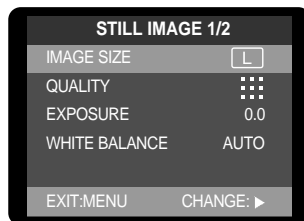

[STILL IMAGE mode]



[STILL IMAGE mode]



Recording mode

IMAGE QUALITY

- In the STILL IMAGE mode, you can select the image quality. (Data compression rate)
- The higher the QUALITY setting, the better the final image will be. However, the high quality setting will require more memory and therefore reduce the number of images you can store on the memory. SUPER FINE is the highest quality and NORMAL is the lowest setting. Choose the setting appropriate for your needs. The image qualities are listed below.



SUPER FINE



FINE



NORMAL

■ Selecting the image quality

1. Turn the camera power on.
2. Select the STILL IMAGE mode by rotating the mode dial.
3. Do not turn the LCD monitor off.
4. Press the MENU button to display the menu on the LCD monitor.
5. Press the UP(▲)/ DOWN(▼) button and select [QUALITY].
6. Press the RIGHT(▶) button and the sub menu will display.
7. Press the UP(▲)/ DOWN(▼) button and select [SUPER FINE], [FINE] or [NORMAL].
8. Press the OK button to confirm the setting.
The default is [FINE].
9. Press the MENU button to cancel the menu display.

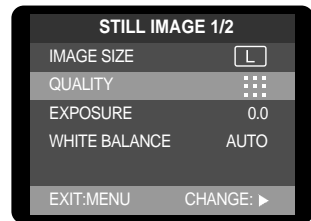

[STILL IMAGE mode]



[STILL IMAGE mode]



Recording mode



NOTICE

- The image file is stored in *.jpg.
- This file format complies with DCF (Design rule for Camera File system)

JPEG

JPEG [Joint Photographic Experts Group] : The name of the committee that designed the standard image compression algorithm. The JPG file format is designed for compressing digital images without harmful influence to the original image. It is the most common type of compressed image file format used in the world wide web.



Recording mode

EV COMPENSATION

- This camera automatically adjusts the exposure according to the ambient lighting conditions. However, you can select the exposure value by using the [EXPOSURE] sub menu.
- In the STILL IMAGE mode, you can select the exposure value.
- If you increase the exposure value, the image will be brighter.
- If you decrease the exposure value, the image will be darker.

■ Selecting the exposure value

1. Turn the camera power on.
2. Select the STILL IMAGE mode by rotating the mode dial.
3. Do not turn the LCD monitor off.
4. Press the MENU button in the STILL IMAGE mode to display the menu on the LCD monitor.
5. Press the UP(▲) / DOWN(▼) button and select [EXPOSURE].
6. Press the RIGHT(▶) button and the sub menu will display.
7. Press the UP(▲) / DOWN(▼) button and select the desired [EXPOSURE] sub menu.
8. Press the OK button to confirm the setting.
The default is [0.0EV].
9. Press the MENU button to cancel the menu display.

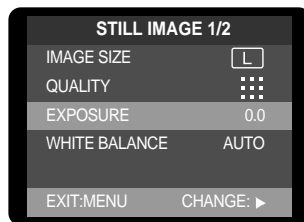

【 STILL IMAGE mode 】



【 STILL IMAGE mode 】



Recording mode



NOTICE

- Exposure compensation setting range : -2.0 ~ +2.0 EV (0.5 EV steps)
- This change to the exposure will remain until the camera is switched off. When the camera is turned on again, the exposure compensation setting returns to 0.0EV (discarding the exposure compensation).
- When you have selected a change in exposure value, the value is displayed on the LCD.
- Decreasing or increasing the exposure value may lead to images being under or over exposed (too dark or too bright). Review your images using the LCD monitor to check that they have been successful.

WHITE BALANCE

- Different lighting conditions may cause a color cast on your images.
- The white balance control allows you to adjust the colors to appear more natural looking.
- The changed white balance value is maintained until the camera power is off.
- There are 6 white balance menus : AUTO/ DAYLIGHT/ CLOUDY/ SUNSET / TUNGSTEN/ FLUORESCENT

■ Selecting the white balance

1. Turn the camera power on.
2. Select the RECORDING(STILL IMAGE/ MOVIE CLIP) mode by rotating the mode dial.
3. Do not turn the LCD monitor off.
4. Press the MENU button in the STILL IMAGE mode to display menu on the LCD monitor.



[STILL IMAGE mode]



Recording mode

5. Press the UP(▲) / DOWN(▼) button and select [WHITE BALANCE].
6. Press the RIGHT(►) button and the sub menu will display.
7. Press the UP(▲) / DOWN(▼) button and select the desired white balance sub menu.
8. Press the OK button to confirm the setting.
The default is [AUTO].
9. Press the MENU button to cancel the menu display.



【 STILL IMAGE mode 】



INFORMATION

- AUTO : The camera automatically selects the appropriate white balance settings, depending on the prevailing lighting conditions.
- DAYLIGHT : For taking images outside on a bright day.
- CLOUDY : For taking images under a cloudy and overcast sky.
- SUNSET : For taking images at sunset
- TUNGSTEN : For taking images under tungsten (standard light bulb) lighting.
- FLUORESCENT : For taking images under fluorescent lighting



Recording mode

DIGITAL ZOOM

■ Using the Digital zoom

1. Select the maximum(3X) optical zoom by pressing the ZOOM T button.
2. Press the ZOOM T button and the digital zoom will be activated.



[A normal image]

Pressing the ZOOM
T button



Pressing the ZOOM
W button

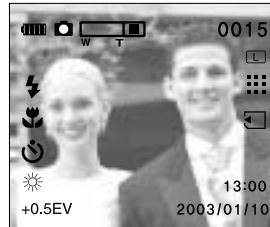

[Digital zoom image]



INFORMATION

- To use the digital zoom the LCD monitor has to be turned on.
- Images taken using the digital zoom may take a little longer for the camera to process. Allow time for this to take place.
- The digital zoom cannot be used in the MOVIE CLIP mode.
- You may notice a decrease in image quality when using the digital zoom.
- The digital zoom only applies to a LARGE(1600X1200) image size.
- An image that is taken by using the digital zoom is stored as an 800x600 image size.
- The digital zoom function doesn't apply to the SMALL(800 X 600) image size.

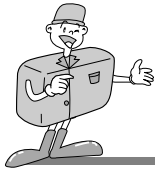

Recording mode

QUICK VIEW

- In STILL IMAGE mode, you can select the quick view menu.
- You can briefly review the last image captured.

■ Selecting the quick view function

1. Turn the camera power on.
2. Select the STILL IMAGE mode by rotating the mode dial.
3. Do not turn the LCD monitor off.
4. Press the MENU button to display [STILL IMAGE 1/2] menu on the LCD monitor.
5. Select [STILL IMAGE 2/2] menu by pressing the RIGHT(▶) button.
6. Press the UP(▲)/ DOWN(▼) button and select [QUICK VIEW].
7. Press the RIGHT(▶) button and the sub menu will display.
8. Press the UP(▲)/ DOWN(▼) button and select the desired sub menu.
9. Press the OK button to confirm the setting.
The default is [ON].
10. Press the MENU button to cancel the menu display.

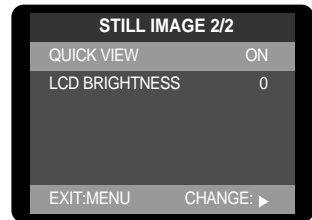

[STILL IMAGE mode]

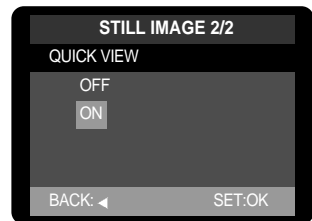

[STILL IMAGE mode]

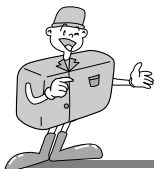

Recording mode

LCD BRIGHTNESS

- In STILL IMAGE/MOVIE CLIP mode, you can select the LCD brightness.
- You may adjust the LCD brightness. Brightness range : -5 ~ 0 ~ +5

■ Selecting the LCD brightness

1. Turn the camera power on.
2. Select the MOVIE CLIP/STILL IMAGE mode by rotating the mode dial.
3. Do not turn the LCD monitor off.
4. Press the MENU button in the STILL IMAGE mode to display [STILL IMAGE 1/2] menu on the LCD monitor.
5. Select [STILL IMAGE 2/2] menu by pressing the RIGHT(▶) button.
6. Press the UP(▲)/ DOWN(▼) button and select [LCD BRIGHTNESS].
7. Press the RIGHT(▶) button and the sub menu will display.
8. Press the UP(▲)/ DOWN(▼) button and select the desired sub menu.
9. Press the OK button to confirm the setting.
The default is [0].
10. Press the MENU button to cancel the menu display.

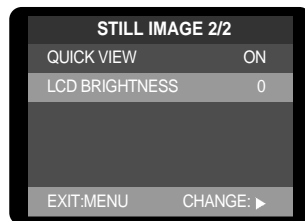

【 STILL IMAGE mode 】



【 STILL IMAGE mode 】

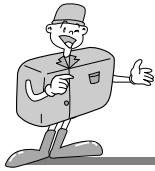

Play mode

Starting Play Mode

- Turn the camera on and select the PLAY mode by rotating the MODE dial. The camera can now play back the images stored on a memory.
- You can set up the PLAY mode function by using the camera buttons and LCD monitor.

■ Playing back a still image

1. Slide the power switch to turn on the camera.

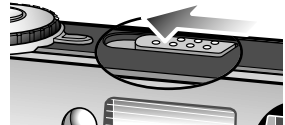

2. Select the PLAY mode by rotating the mode dial.

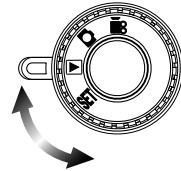

3. The last image stored on the memory is displayed on the LCD monitor.



4. Select an image that you want to play back by pressing LEFT(◀) / RIGHT(▶) button.

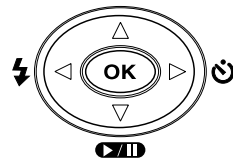



Play mode

■ Playing back a movie clip

Steps from 1-3 are the same as those to play back a still image.

4. Select the movie clip that you want to play back by using the LEFT(◀)/RIGHT(▶) button. If you select a movie clip file, the movie clip indicator(🎞️) will be displayed on the LCD monitor.
5. Press the OK button or PLAY/STOP/DOWN button to play back a movie clip
 - To pause playing back a movie clip, press the PLAY/STOP/DOWN(▼) button again.
 - Press the PLAY/STOP/DOWN(▼) button and the movie clip will restart.
 - To stop play back, press LEFT(◀)/RIGHT(▶) button.



■ PLAY mode functions are listed below

Camera button	Thumbnail, Enlarging a image	
	Image information, Movie clip play/pause/stop	
LCD monitor	Play back	Slide Show, Protect, Delete All, LCD brightness, Copy to memory card
	Print setting (DPOF)	Quantity

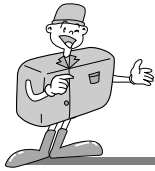

Play mode



NOTICE

- If there are no images stored on the internal memory or the memory card, a [NO IMAGE !] message will be displayed on the LCD monitor.



INFORMATION

- If the memory card is inserted in the camera, all the camera functions are applied only to the CARD.
- If the CARD is not inserted in the camera, all the camera functions are applied only to the internal memory.
- The last image stored on the internal memory will be displayed on the LCD monitor.
- If the SD memory card is inserted, the last image stored on the SD memory card will be displayed.
- The LCD monitor will remain in operation until the camera is switched off in PLAY mode.
- The menu will not display on the LCD monitor under the following circumstances:
 - When another button is being pressed.
 - While image data is being processed.
(While the green LED next to the viewfinder is blinking)
 - When there is no battery capacity.
 - When the flash is charged



Play mode

Setting up the play back function by using the camera button

- You can set up the PLAY mode function by using the camera buttons.

Power switch

- Used for turning the camera power on / off.
- If this camera is not in operation during the specified time(about 60 SEC), the camera power will idle(LCD monitor : Off, Mode dial lamp : illuminating) automatically.
- The camera power will be turned off automatically during periods of inactivity. This is done to reduce battery drain. The camera can be reactivated by sliding the power switch again.

LCD button

- Pressing the LCD button in the PLAY mode will change the display as shown below.

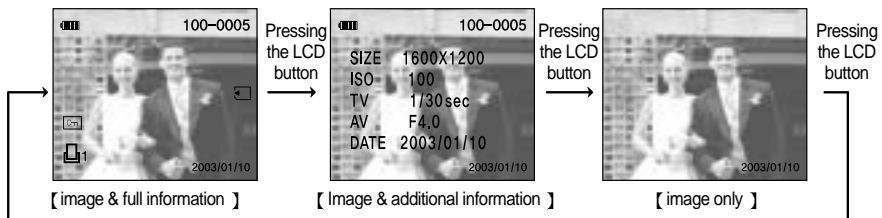

You can view image information(Image size, ISO, Shutter speed, Aperture value, Recording date) in <Image with additional information> mode

Ex) SIZE : 1600 X 1200 → image size ISO : 100 → ISO
 TV : 1/30 sec → shutter speed AV : F 4.0 → aperture value
 DATE : 2003/01/10 → recording date

ADVANCED

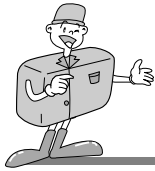







Play mode

DELETE button

- This deletes an image stored on the internal memory or memory card.

■ Deleting an image

A protected image can't be deleted.

1. Turn the camera power on.
2. Select the PLAY mode() by rotating the mode dial.
3. Select an image that you want to delete by pressing the LEFT()/ RIGHT() button.
4. Press the DELETE button() and a message will display as shown alongside on the LCD.
5. Select [NO] or [YES] by pressing the LEFT() / RIGHT() button.
6. Press the OK button.

[Selecting NO] : The image will be displayed on the LCD monitor.

[Selecting YES] : Once an image has been deleted, the next image in the sequence will appear on the LCD display. (If the last stored image is deleted, the previous image will appear.)



NOTICE

- Before deleting an image from the camera, you should download(p.87) the image to your computer or protect(p.70) the image, if you want to keep it.



Play mode

MENU button

- When you press the MENU button, the PLAY mode menu will be displayed on the LCD monitor. Pressing it again will return the LCD to the initial display.



【 menu off 】

Pressing the
MENU button

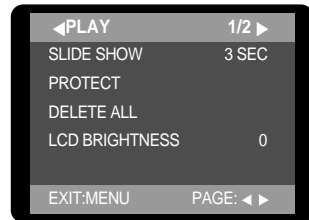

【 menu on 】



Play mode

THUMBNAIL / ZOOM W button





- You can view up to 9 images at a time by using the THUMBNAIL function.

■ Thumbnail display

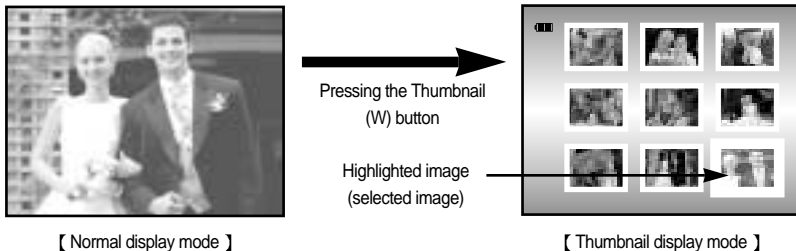
1. Turn the camera power on.
2. Select the PLAY mode by rotating the mode dial.
3. An image will be displayed on the LCD monitor.
4. Press the THUMBNAIL() button in the PLAY mode.

9-images will be displayed at the same time on the LCD monitor. The thumbnail display will highlight the image that had been showing at the time the thumbnail mode was selected.



5. Press the UP()/ DOWN()/ LEFT()/ RIGHT() button to move to the desired image.
The selected image is highlighted.

Icons are displayed to indicate the type of file selected.

() : Movie clip file () : DPOF indicator

() : Protect indicator

6. When viewing a thumbnail image, press the OK button or ZOOM T button and the selected shot will show in single display mode.



Play mode

ZOOM T button

- When viewing a single image in PLAY mode, use the ZOOM T button to enlarge the selected image.

■ Image enlargement

1. Turn the camera power on.
2. Select PLAY mode(▶) by pressing the MODE button.
3. Select a image that you want to enlarge by pressing the LEFT/ RIGHT button.
4. Press the Zoom T button and 2X enlarged image will display.
5. Different parts of the image can be viewed by pressing the ▲/ ▼/ ◀/ ▶ buttons.
6. Pressing the ZOOM W button will zoom back to the original full sized image.



[Normal display]

Pressing the Digital zoom(T) button



Pressing the Wide(W) button

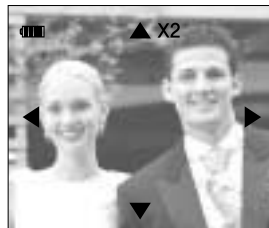

[2X scale of enlargement]



NOTICE

- Movie clips can't be enlarged
- If an image is enlarged, a loss of quality may occur.



Play mode

5-function button

- Explanation of the 5-function button

BUTTON	MENU DISPLAY	PLAY mode	Page
UP(▲) button	ON	Makes the menu cursor move up	p.67
	OFF	Moves upwards to select a previously stored image (Thumbnail display) Moves to the upper part of the image (Digital zoom)	
DOWN(▼) button	ON	Makes the menu cursor move down	p.67
	OFF	Playing back/ Pause a movie clip and slide show Moves downwards to select a later stored image (Thumbnail display) Moves to the lower part of the image (Digital zoom)	
LEFT(◀) button	ON	Makes the menu cursor move to the main menu	p.67
	OFF	Stopping the movie clip and slide show Selects a previous image(Normal or thumbnail display) Moves to the left part of the image(Digital zoom)	
RIGHT(▶) button	ON	Makes the menu cursor move to the sub menu	p.68
	OFF	Stops the movie clip and slide show Selects the next image (Normal or thumbnail display) Moves to the right part of the image (Digital zoom)	
OK button	ON	Selects or confirms a menu	p.68
	OFF	Stops the thumbnail display Playing back the movie clip and slide show	



Play mode

UP(▲) button

- When the menu is displayed on the LCD monitor, pressing the UP(▲) button makes the menu cursor move up.
- When the menu is not displayed on the LCD monitor, pressing the UP(▲) button activates the following.
 - Thumbnail display : Moves upwards to select a previously stored
 - Digital zoom : Moves to the upper part of the image

PLAY/STOP/DOWN(▼) button

- When the menu is displayed on the LCD monitor, pressing the DOWN(▼) button makes the menu cursor move down.
- When the menu is not displayed on the LCD monitor, pressing the DOWN(▼) button activates the following.
 - Thumbnail display : Moves downwards to select a later stored image
 - Digital zoom : Moves to the lower part of the image
 - A movie clip/ Slide show : playing back or Pause

LEFT(◀) button

- When the menu is displayed on the LCD monitor, pressing the LEFT(◀) button makes the menu cursor move to the main menu.
- When the menu is not displayed on the LCD monitor, pressing the LEFT(◀) button activates the following.
 - Normal / Thumbnail display : move to previous image
 - Digital zoom : Moves to the left part of the image
 - A movie clip/ Slide show : stops the playing back

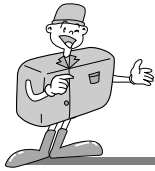

Play mode

RIGHT(▶) button

- When the menu is displayed on the LCD monitor, the RIGHT (▶) button makes the sub menu data change.
- When the menu is not displayed on the LCD monitor, pressing the RIGHT(▶) button activates the following.
 - Normal / Thumbnail display : move to next image
 - Digital zoom : Moves to the right part of the image
 - A movie clip/ Slide show : stops the playing back

OK button

- When the menu is displayed on the LCD monitor, the OK button is used for confirming data that is changed by using the ▲/▼/◀/▶ buttons.
- When the menu is not displayed on the LCD monitor, pressing the OK button activates the following.
 - Cancels the thumbnail display
 - Starts a movie clip / slide show



Play mode

Setting up the play back function using the LCD monitor

- PLAY mode functions can be changed by using the LCD monitor.
- In the PLAY mode, pressing the MENU button displays the menu on the LCD monitor.

SLIDE SHOW

- Images can be displayed continuously at pre-set intervals.
- This is useful and convenient for checking recorded images and for presentations.
- You can select the slide show play back time (1sec/ 3sec/ 5sec/ 7sec/ 9sec)

■ Starting the slide show

1. Turn the camera power on.
2. Select the PLAY mode() by rotating the mode dial.
3. Do not turn the LCD monitor off.
4. Press the MENU button to display the PLAY mode menu on the LCD monitor.
5. Press UP() /DOWN() and select the [SLIDE SHOW].
6. Press the RIGHT() button and the sub menu will display.
7. Press the UP() / DOWN() button and select the desired slide show play back time. Press the RIGHT() button and the slide show will start.
8. To pause or restart the slide show, press the PLAY/ STOP/DOWN() button.
9. To stop the slide show, press LEFT()/RIGHT() button or the MENU button.

Press the MENU button and the initial menu will be displayed.
Press the MENU button again and the menu will be cancelled.

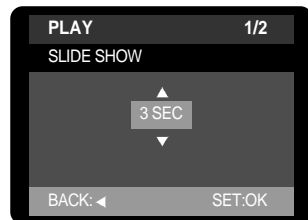
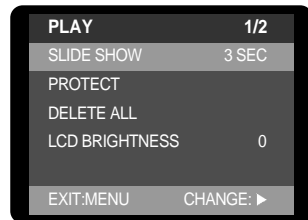

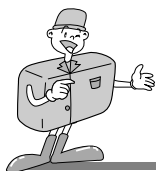

Play mode

PROTECT

- This is used to protect specific shots from being accidentally erased (LOCK). It also releases images that have been previously protected (UNLOCK).

■ Protecting images

1. Turn the camera power on.
2. Press the MODE button to select the PLAY mode().
3. Do not turn the LCD monitor off.
4. Select an image that you want to protect by pressing the LEFT()/ RIGHT() button.
5. Press the MENU button to display the PLAY mode menu on the LCD monitor.
6. Press the UP()/ DOWN() button and select [PROTECT].
7. Press the RIGHT() button and the sub menu will display.
8. Select [ONE IMAGE] or [ALL IMAGES] by pressing the UP()/ DOWN() button and press the RIGHT() button.
 - ONE IMAGE : This protects a single image.
 - ALL IMAGES : This protects all the images in the memory.
9. Select [LOCK] or [UNLOCK] by pressing the UP()/ DOWN() button and press the OK button.
 - LOCK : Sets up the PROTECT function.
 - UNLOCK : Discards the PROTECT function.
 - If you protect an image, the protect icon() will be displayed on the LCD monitor.



Protect indicator
Unprotected image do not
have an indicator.





Play mode



NOTICE

- An image in LOCK mode will be protected from [DELETE] or [DELETE ALL] functions, but will NOT be protected from the [FORMAT] function.

DELETE ALL

■ Deleting all images

- This enables you to clear all unprotected images from the memory.
- To delete the images or movie clips stored in the internal memory, remember not to insert the memory card in the camera. Otherwise, you will delete the images or movie clips stored in the memory card.

■ Deleting all images

1. Turn the camera power on.
2. Select the PLAY mode() by rotating the mode dial.
3. Do not turn the LCD monitor off.
4. Press the MENU button to display the PLAY mode menu on the LCD monitor.
5. Press UP(▲) /DOWN(▼) button and select [DELETE ALL].
6. Press the RIGHT(▶) button and the sub menu will display.
7. Select [YES] or [NO] by pressing the UP(▲)/ DOWN(▼) button and press the OK button.

- [Selecting NO] : The [DELETE ALL] menu will be displayed.
- [Selecting YES] : All the unprotected images are deleted. If there aren't protected images, all the images are deleted and [NO IMAGE!] message will display.

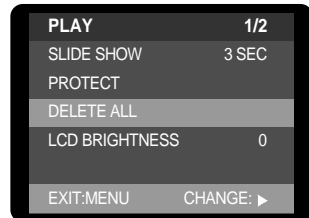



Play mode









NOTICE

- Remember that this will permanently delete unprotected images. Important shots should be stored on a computer before deletion takes place.

LCD BRIGHTNESS

- You may adjust the LCD brightness.
- Brightness range : -5 ~ 0 ~ +5

■ Selecting the LCD brightness

1. Turn the camera power on.
2. Select the PLAY mode() by rotating the mode dial.
3. Do not turn the LCD monitor off.
4. Press the MENU button to display the PLAY mode menu on the LCD monitor.
5. Press the UP()/DOWN() and select [LCD BRIGHTNESS].
6. Press the RIGHT() button and the sub menu will display.
7. Select the desired LCD brightness by pressing the UP()/DOWN() button.
8. Press the OK button to confirm the setting.
9. Press the MENU button to cancel the menu display.

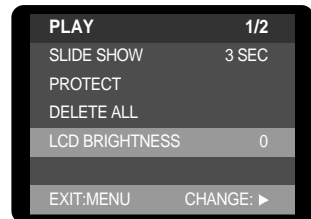



Play mode

COPY TO CARD

- This enables you to copy image files to the CARD.

■ Copying image files to the memory card

1. Insert a memory card.
2. Turn the camera power on.
3. Select the PLAY mode() by rotating the mode dial.
4. Do not turn the LCD monitor off.
5. Press the MENU button to display [PLAY 1/2] menu on the LCD monitor.
6. Select [PLAY 2/2] menu by pressing the RIGHT() button.
7. Press the UP()/ DOWN() button and select [COPY TO CARD].
8. Press the RIGHT() button and the sub menu will display.
9. Select [YES] or [NO] by pressing the UP()/ DOWN() button
10. Press the OK button to confirm the setting.

[Selecting NO] : [COPY TO CARD] menu will display.

[Selecting YES] : [COPY TO CARD] message will display.

After copying the images to the memory card, the last stored image of the last copied folder will be displayed on the LCD monitor

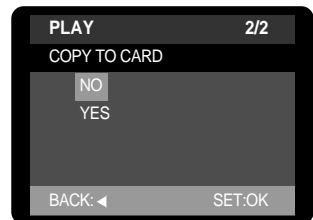
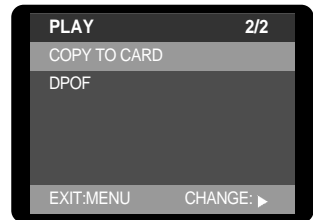



Play mode



INFORMATION

- If you select this menu and press the OK button without inserting the memory card, a [NO CARD !] message will display.
- If the memory card capacity is smaller than the internal memory, a [CARD FULL !] message will be displayed by rotating the mode dial to the RECORDING mode.
The rest of the image files that stored on the internal memory will not be copied.
Before doing [COPY TO CARD], delete unnecessary files.

■ The number of stored images in the PLAY mode

- The number of stored images in the PLAY mode will be displayed as shown below.



100 - 0005

100 : the SSCAM folder number

0005 : the stored image number

The image is stored on the 100SSCAM (Internal memory : SSCAM) sub folder that is created under the DCIM folder in the memory card (SD memory card / Multi Media Card).

After doing [COPY TO CARD], the last stored image of the last copied folder is displayed on the LCD monitor. When you take an image, the image is stored in the last copied folder.



Play mode

DPOF (Digital Print Order Format)

- DPOF(Digital Print Order Format) allows you to embed printing information on your memory card. Select the pictures to be printed and how many prints to make.
- Images can then be printed on DPOF printers, or at an increasing number of photo laboratories.
- This function is not available for Movie clips.
- The DPOF file is only stored on the memory card.
- To make a DPOF file for the images that are stored on the internal memory, apply the [COPY TO CARD] function first.

■ Setting up DPOF

1. Insert a memory card that has image files.
2. Turn the camera power on.
3. Select the PLAY mode(▶) by rotating the mode dial.
4. Do not turn the LCD monitor off.
5. Press the MENU button to display [PLAY 1/2] menu on the LCD monitor.
6. Select [PLAY 2/2] menu by pressing the RIGHT(▶) button.
7. Select [DPOF] by pressing the UP(▲)/ DOWN(▼) button.
8. Press the RIGHT(▶) button and the sub menu will display.
9. Press UP(▲) /DOWN(▼) and select [DPOF] sub menu.
 - # OF PRINTS : selects the number of prints
 - Number of prints selectable : 1 ~ 9
10. Press the OK button to confirm the setting.

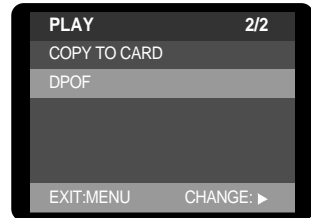

ADVANCED



INFORMATION

- When an image that has DPOF information is displayed, the DPOF indicator will be displayed on the LCD monitor.



Setup mode

Starting the SETUP mode

Rotate the mode dial to the SETUP mode, allowing you to set up the basic camera settings.

BEEP

- A beep will sound when you press the camera button and you can check the camera conditions.

■ Selecting the beep sound

1. Turn the camera power on.
2. Select the SETUP mode(**SET**) by rotating the mode dial.
3. [SETUP 1/3] menu will display.
4. Select [BEEP] by pressing the UP(**▲**)/ DOWN(**▼**) button.
5. Press the RIGHT(**▶**) button and the sub menu will display.
6. Press the UP(**▲**)/ DOWN(**▼**) button and select [ON] or [OFF]. Press the OK button to confirm the setting.
7. The default is [ON].

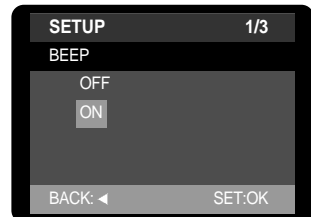
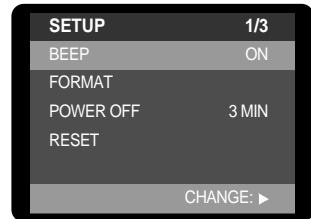



Setup mode

FORMAT

- Remove the memory card to format the internal memory.
- Insert the memory card to format the memory card.
- This is used for formatting the internal memory / SD memory card. All the files in the memory are deleted by [FORMAT] function.

■ Formatting the memory

1. Turn the camera power on.
2. Select the SETUP mode(**SET**) by rotating the mode dial.
3. [SETUP 1/3] menu will display.
4. Select [FORMAT] by pressing the UP(**▲**) / DOWN(**▼**) button and press the RIGHT(**▶**)button.
5. Select [NO] or [YES] by pressing the UP(**▲**) / DOWN(**▼**) button and press the OK button.

[Selecting YES] : the [FORMAT] message will be displayed on the LCD monitor and the menu will be displayed.

[Selecting NO] : SETUP menu will be displayed.
The default is [NO].

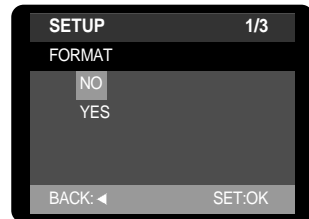
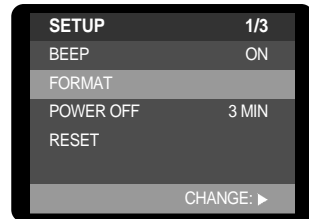

NOTICE

- All the files in the memory are deleted when using the [FORMAT] function. Before formatting the memory, it is advisable to copy important data onto other media as back-up e.g. floppy disks, hard disks, CD etc.



Setup mode

POWER OFF

- This function switches the camera off after a set amount of time in order to prevent unnecessary battery drainage.
- You can set the power to switch off at any specified time(3, 5, 10, 30MIN) from the last operation.
- If you select [CANCEL], the power off function will not operate.
- Note that the automatic power off does not operate if the camera is in slide show or PC mode.

■ Selecting the power off function

1. Turn the camera power on.
2. Select the SETUP mode(**SET**) by rotating the mode dial.
3. [SETUP 1/3] menu will display.
4. Press the UP(▲)/ DOWN(▼) button and select [POWER OFF].
5. Press the RIGHT(▶) button and the sub menu will display.
6. Select desired sub menu by pressing the UP(▲)/ DOWN(▼) button. The default is [3 MIN].
7. Press the OK button to confirm the setting.

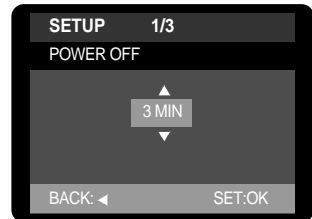
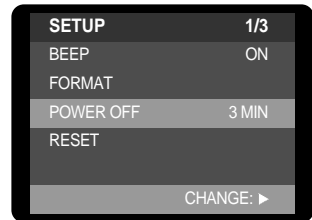

■ Time for power off

Power status	Period of time (Battery)	Period of time (AC adapter)
Idle mode(LCD monitor off)	About 60 sec	About 60 sec
Power off	User setting	30 MIN



INFORMATION

- Even if the batteries or AC adapter are removed and inserted again, the power off setting will be preserved.



Setup mode

RESET

- This menu allows you to reset the camera settings to the default.

■ Selecting the default camera setting

1. Turn the camera power on.
2. Select the SETUP mode(**SET**) by rotating the mode dial.
3. [SETUP 1/3] menu will display.
4. Press the UP(**▲**)/ DOWN(**▼**) button and select [RESET].
5. Press the RIGHT(**▶**) button and the sub menu will display.
6. Select [YES] or [NO] by pressing the UP(**▲**)/ DOWN(**▼**) button and press the OK button.

[Selecting YES]: All the camera settings are changed to the camera default setting.

[Selecting NO]: SETUP menu will display without resetting the camera system.

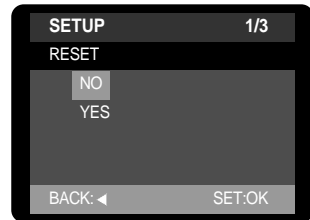
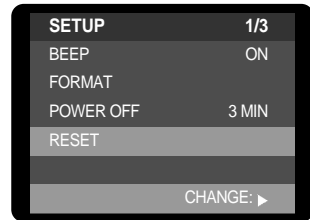

■ The default camera setting

Camera setting	Default	Camera setting	Default
Image size	1600 X 1200	White balance	Auto
Quality	Fine	EV compensation	0.0
Flash	Auto flash	Slide show	3 sec
LCD brightness	0	Power off	3 min
Quick View	ON	Beep	ON

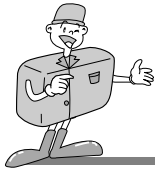

Setup mode

DATE IMPRINT

- There is an option to include DATE/TIME on still images.

■ Selecting the date imprint function

1. Turn the camera power on.
2. Select the SETUP mode() by rotating the mode dial.
3. [SETUP 1/3] menu will display.
4. Select [SETUP 2/3] menu by pressing the RIGHT() button.
5. Press the UP()/ DOWN() button and select [DATE IMPRINT].
6. Press the RIGHT() button and the sub menu will display.
7. Select [ON] or [OFF] by pressing the UP()/ DOWN() button. Press the OK button to confirm the setting.
8. The default is [ON].

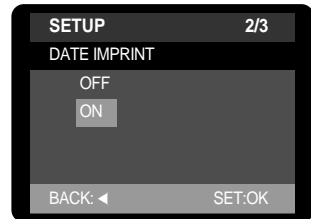
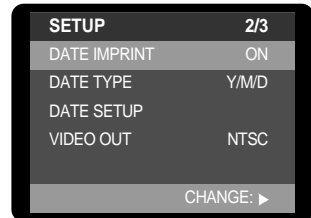

INFORMATION

- This function is not available in the movie clip mode.
- Date will be imprinted as DATE TYPE setting.
- The DATE IMPRINT function is unaffected by the camera being switched on and off.
- Imprinted date can be set in [DATE SETUP].
- Even though the [DATE IMPRINT] menu is set to [OFF] , the date will be displayed on the LCD monitor in the RECORDING(STILL IMAGE, MOVIE CLIP) mode.

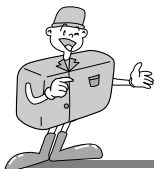

Setup mode

DATE TYPE

- You can select the date format that is imprinted on the image.
 - Y/M/D : year /month/ day
 - M/D/Y : month/ day /year
 - D/M/Y : day /month /year

■ Selecting the date format

1. Turn the camera power on.
2. Select the SETUP mode(**SET**) by rotating the mode dial.
3. [SETUP 1/3] menu will display.
4. Select [SETUP 2/3] menu by pressing the RIGHT(▶) button.
5. Press the UP(▲)/ DOWN(▼) button and select [DATE TYPE].
6. Press the RIGHT(▶) button and the sub menu will display.
7. Select the desired date format by pressing the UP(▲)/ DOWN(▼) button. Press the OK button to confirm the setting.
8. The default is [Y/M/D].

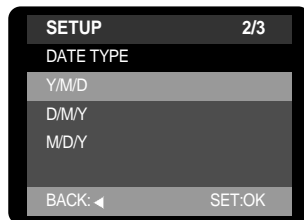
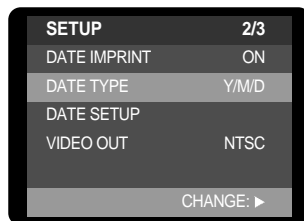



Setup mode

DATE SETUP

- You can change the imprinted date/time

■ Changing the date/time

1. Turn the camera power on.
2. Select the SETUP mode(**SET**) by rotating the mode dial.
3. [SETUP 1/3] menu will display.
4. Select [SETUP 2/3] menu by pressing the RIGHT(**▶**) button.
5. Press the UP(**▲**)/ DOWN(**▼**) button and select [DATE SETUP].
6. Press the RIGHT(**▶**) button and the sub menu will display.
You can change the date/time on the LCD monitor display by pressing the UP(**▲**)/ DOWN(**▼**)/ LEFT(**◀**)/ RIGHT(**▶**) button.
LEFT(**◀**)/ RIGHT(**▶**) button : you can select year/month/day, hour/minute by pressing these buttons.
UP(**▲**) button : Increases the number of items
DOWN(**▼**) button : Decreases the number of items
7. Press the OK button to confirm the setting.

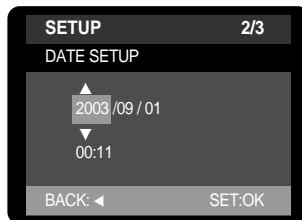
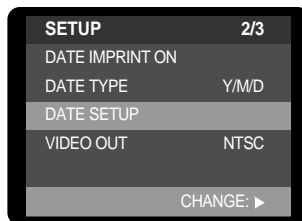

INFORMATION

- The selection range for date/time setup covers from 2000~2058.
(It is automatically programmed to allow for a leap year/ month)



NOTICE

- If the batteries or AC adapter are removed, it is necessary to reset the time /date.
- Recording date displays on the LCD monitor in the PLAY mode.(DATE IMPRINT : ON)



Setup mode

VIDEO OUT

- The Movie output signal from the camera can be NTSC or PAL. Your choice of output will be governed by the type of machine (monitor or TV, etc.) to which the camera is connected.
- Select the correct movie standard for the outer monitor. PAL mode can support only BDGHI.

■ Selecting the video out type

1. Turn the camera power on.
2. Select the SETUP mode(**SET**) by rotating the mode dial.
3. [SETUP 1/3] menu will display.
4. Select [SETUP 2/3] menu by pressing the RIGHT(**▶**) button.
5. Press the UP(**▲**)/ DOWN(**▼**) button and select [VIDEO OUT].
6. Press the RIGHT(**▶**) button and the sub menu will display.
7. Select [NTSC] or [PAL] by pressing the UP(**▲**)/ DOWN(**▼**) button.
8. Press the OK button to confirm the setting.

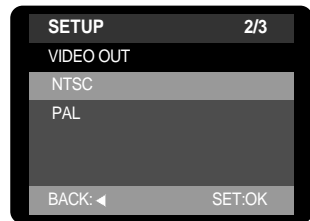
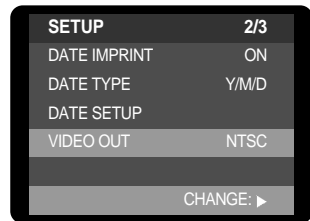

INFORMATION

- NTSC : U.S.A, Canada, Japan, South Korea, Taiwan, Mexico.
- PAL : Australia, Austria, Belgium, China, Denmark, Finland, Germany, U.K., Holland, Italy, Kuwait, Malaysia, New Zealand, Singapore, Spain, Sweden, Switzerland, Thailand, Norway.



Setup mode

■ Connecting to an external monitor

In STILL IMAGE/ MOVIE CLIP/ PLAY mode, you can view the stored still images or movie clips by connecting the camera to an external monitor via the video cable. When the camera is connected to an external monitor, the LCD monitor will be turned off automatically.

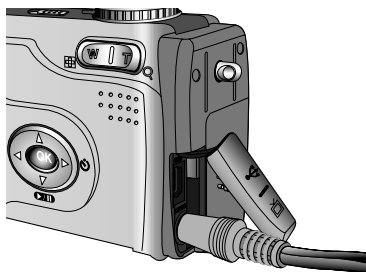

When the camera is connected to an external monitor, the menu will be visible on the external monitor and the menu functions are the same as those indicated on the LCD monitor.



INFORMATION

- When using a TV as an external monitor, you will need to select the external or AV channel of the TV.
- There will be a digital noise on the external monitor, but it is not a malfunction.
- If the image is not in the centre of the screen, use the TV controls to centre it.

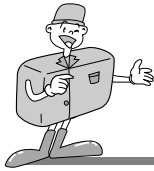

Setup mode

LANGUAGE

- There is a choice of languages that can be displayed on the LCD monitor.
- You can select English/ Korean/ German/ French/ Spanish/ Italian/ Taiwanese/ Chinese.

■ Selecting a language

1. Turn the camera power on.
2. Select the SETUP mode(**SET**) by rotating the mode dial.
3. [SETUP 1/3] menu will display.
4. Select [SETUP 3/3] menu by pressing the RIGHT(▶) button twice.
5. Press the UP(▲)/ DOWN(▼) button and select [LANGUAGE].
6. Press the RIGHT(▶) button and the sub menu will display.
7. Select desired the language by pressing the UP(▲)/ DOWN(▼) button.
8. Press the OK button to confirm the setting.

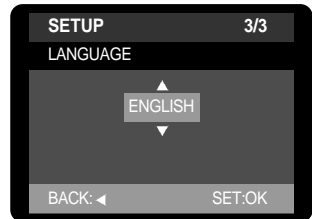
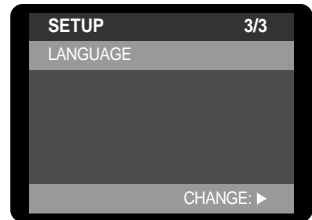

ADVANCED



INFORMATION

- The changed language is maintained until a new language is selected.



PC mode

Starting PC mode

- If you insert the USB cable to a USB connection terminal, the camera working mode will change to the PC mode automatically.
- In this mode, you can download stored images to your PC through the USB cable.
- There is no associated menu in PC mode and the LCD monitor is always turned off in PC mode.
- The AF indicator lamp blinks when the files are transferring via the USB connection.

■ Connecting the camera to PC

1. Turn the camera power on.
2. Turn the PC power on.
3. Connect the PC and the camera by the USB cable.
 - Insert the small plug of the USB cable to the camera USB connection terminal.
 - Insert the large plug of the USB cable to the USB port of PC
 - The plugs must be firmly inserted.

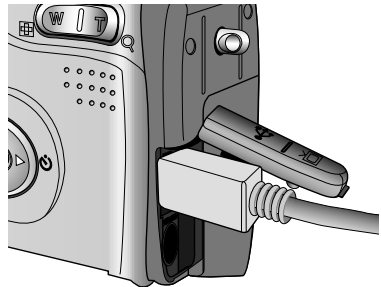

■ Disconnecting the camera and PC

Refer to the following page

- WIN 98SE : p.110
- WIN 2000/ME/XP : p.110



INFORMATION

- The camera driver must be installed before using PC mode in Windows 98/98SE. Refer to page 99 regarding installation.
- To save battery power, it is recommended that you use an AC adaptor (Optional) when connecting the camera to a PC.



PC mode

■ Downloading stored images

Once you have downloaded images to your PC, they can be edited and printed.

1. Connect the camera to your PC with the USB cable. (p.86)

2. On your computer's desktop display, select [My computer] and double click [Removable Disk → DCIM → 100SSCAM]. The image files will then be displayed.



3. Select an image and press the right mouse button.

4. A pop-up menu will open. Click [Cut] or [Copy] menu.

[Cut] : cuts a selected file.

[Copy] : copies files.





PC mode

5. Click a folder that you want to paste the file.
6. Press the right mouse button and a pop-up menu will open. Click [Paste].



7. An image file is transferred from camera to your PC.



- When the memory card is inserted, you can view the images are stored in the memory card.
- When the memory card is not inserted, you can view the images are stored in the internal memory.
- By using [Digimax Viewer], you can see the stored images in the memory directly on the PC monitor and you can copy or move the image files. (p.113)



Important notes

Caution!

- Your new Samsung camera is a precision instrument. Whilst it is designed to withstand general wear and tear, there are some important points that will help you get maximum service and reliability from your camera.

The following should be avoided :

- Severe changes in temperature and humidity.
 - Dust and dirt.
 - Direct sunlight or the inside of a vehicle in hot weather.
 - Environments where there is high magnetism or excessive vibration.
 - Areas with high explosives or which are highly flammable materials.
 - Pesticides, etc.
- Sand can be particularly troublesome to cameras.
 - Sand or other small particles can cause severe malfunctions.
 - Ensure that there is no contact with sand or similar particles.
 - Extremes in temperature may cause problems.
 - If the camera is transferred from a cold to a warm and humid environment, condensation can form on the delicate electronic circuitry. If this occurs, turn the camera off and wait for at least 1 hour until all moisture is dispersed. Moisture build up can also occur in the CARD. If this happens, turn off the camera and remove the CARD. Wait until the moisture has dispersed.



Important notes

- If the digital camera is not used for a long period, an electric discharge can occur. It is a good idea to remove the batteries and the CARD, the camera is not used for some time.

- If the camera is exposed to electronic interference, it will turn itself off to protect the CARD.

- Maintenance
 - Use a soft brush (available from photo stores) to GENTLY clean the lens and LCD assemblies. If this does not work, lens-cleaning paper with lens cleaning fluid can be used.
 - Clean the camera body with a soft cloth. Do not allow this camera to come into contact with solvent materials such as benzol, insecticide, thinners etc. This may damage the body shell of the camera and also affect its performance.
 - Rough handling can damage the LCD monitor. Take care to avoid damage and keep the camera in its protective carry case at all times when not in use.

- DO NOT attempt to disassemble or modify the camera. It contains delicate parts and there are high voltage circuits that can cause electric shocks.

- Under certain conditions, static electricity can cause the flash unit to fire. This is not harmful to the camera and is not a malfunction.

- When images are uploaded or downloaded, the data transfer may be affected by static electricity. In this case, disconnect and re-connect the USB cable before trying the transfer again.



Important notes

Warning indicator

There are several warnings that may appear in the LCD display

Warning indicator	Causes	Remedy
NO CARD !	<ul style="list-style-type: none">• A memory card is not inserted.• The camera can't recognize the memory card.	<ul style="list-style-type: none">• Insert a memory card and do [COPY TO CARD]• Turn off the camera and turn it on again
NO IMAGE !	<ul style="list-style-type: none">• There are no images stored on the internal memory or the CARD.	<ul style="list-style-type: none">• Take images.• Insert a CARD that is holding some images.
MEMORY FULL !	<ul style="list-style-type: none">• There is insufficient memory capacity to take an image.	<ul style="list-style-type: none">• Insert a new CARD• Delete unnecessary image files to free up some memory.
MEMORY ERROR !	<ul style="list-style-type: none">• The memory card has an error.	<ul style="list-style-type: none">• Insert a new memory card.



Before contacting a service center

Please check the following

Symptom	Causes	Remedy
The camera doesn't switch on	<ul style="list-style-type: none"> • There is low battery capacity • An AC Power Adapter is not connected 	<ul style="list-style-type: none"> • Insert fresh batteries • Connect an AC Power Adapter
The camera power is down whilst in use	<ul style="list-style-type: none"> • The batteries are exhausted • The Camera is turned off automatically due to the Auto power off function • The Adapter plug is not connected securely 	<ul style="list-style-type: none"> • Insert fresh batteries • Slide the power switch to reactivate camera • Remove and re-insert the plug
Batteries drain quickly	<ul style="list-style-type: none"> • The Camera is being used in low temperatures • Mixing old and new batteries or battery types 	<ul style="list-style-type: none"> • Keep the camera in warm conditions (i.e. inside a coat or jacket) and only remove it in order to take images • Insert fresh batteries (all of which should be of the same type)
Camera does not take images when pressing the Shutter button	<ul style="list-style-type: none"> • The memory is full • The CARD has not been formatted. • The memory is exhausted • The camera power is off • The batteries are exhausted • The camera working mode is positioned incorrectly 	<ul style="list-style-type: none"> • After turning the camera off, insert a new memory card or delete a stored image. • Format the memory • Insert a new memory card • Turn the camera power on • Insert fresh batteries • Change the camera working mode to the RECORDING mode.
The images are unclear	<ul style="list-style-type: none"> • The focus mode is not correct 	<ul style="list-style-type: none"> • Keep the focus range.
The flash does not fire	<ul style="list-style-type: none"> • FLASH OFF mode has been selected 	<ul style="list-style-type: none"> • Disengage the FLASH OFF mode
Incorrect date and time is displayed	<ul style="list-style-type: none"> • The date and time have been set incorrectly. 	<ul style="list-style-type: none"> • Reset the date and time correctly. (p.82)



Before contacting a service center

Please check the following

Symptom	Causes	Remedy
The camera buttons do not operate	<ul style="list-style-type: none">• Camera malfunction	<ul style="list-style-type: none">• Remove /re-insert batteries and switch camera on
The memory card error	<ul style="list-style-type: none">• Incorrect memory card format	<ul style="list-style-type: none">• Re-format the memory card. (p.77)
Color of image different to original scene	<ul style="list-style-type: none">• WHITE BALANCE setting is incorrect	<ul style="list-style-type: none">• Select appropriate WHITE BALANCE. (p.54)
Images are too bright	<ul style="list-style-type: none">• Exposure is excessive	<ul style="list-style-type: none">• Reset exposure compensation. (p.52)
The play back display is not very clear	<ul style="list-style-type: none">• The lens or LCD monitor is smudged or dirty	<ul style="list-style-type: none">• Clean the lens or LCD
The Date is not displayed on the LCD monitor in PLAY mode	<ul style="list-style-type: none">• Date imprint function is set to OFF.	<ul style="list-style-type: none">• Switch the Date imprint function ON. (p.80)
When using the PC's explorer, [Removable Disk] does not show	<ul style="list-style-type: none">• Cable connection is incorrect• The camera is off• There are no batteries, the batteries are exhausted or the AC adapter is not connected• The operating system is not Windows 98, 98SE, 2000, ME, XP/ Mac OS 8.6~10.2. Alternatively the PC does not support USB• USB driver is not installed.	<ul style="list-style-type: none">• Check the connection• Turn the camera on• Insert new batteries or check the adapter connection• Install Windows 98, 98SE, 2000, ME, XP/ Mac OS 8.6~10.2 to PC that supports USB• Install "USB Storage Driver"

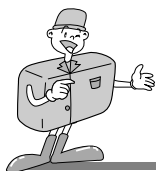

Specifications

Image Sensor	Type	1/3.2" CCD
	Effective Pixels	Approx. 2.0 Mega pixels
	Total Pixels	Approx. 2.1 Mega pixels
Lens	Focal Length	Samsung SHD lens f=5.2 ~ 15.6mm (35mm film equivalent : 39 ~ 117mm)
	F No.	F 2.8 ~ F 4.8
	Digital Zoom	Still Image mode : 2X (Large size only) Play mode : 2X
Viewfinder	Optical Viewfinder	Real image Optical Viewfinder
	LCD Monitor	1.6" color TFT LCD
Focusing	Type	TTL autofocus
	Range	Normal : 0.8m ~ infinity Macro : WIDE - 0.1m ~ 0.8m, TELE - 0.4m ~ 0.8m
Shutter	Type	Mechanical and Electronic shutter
	Speed	1/2 ~ 1/2,000sec.
Exposure	Control	Program AE
	Compensation	±2EV (0.5EV steps)
	ISO Equivalent	Auto
Flash	Modes	Auto/ Auto & Red-eye reduction / Slow synchro/ Fill-in/ Flash off
	Range	WIDE : 0.5 ~ 2.5m, TELE : 0.5 ~ 1.8m
	Recharging Time	Approx. 10 sec.
White Balance		Auto / Daylight / Cloudy / Sunset / Tungsten / Fluorescent
Shooting	Still Image	Single
	Movie Clip	Size : 320x240 pixels Recording time : max. 3min.
Self-timer		10 sec.
Storage	Media	Internal memory : 8MB flash memory External memory (Optional) : SD card (Up to 256MB guaranteed)
	File Format	Still Image : JPEG (DCF) / DPOF Movie Clip : AVI(MJPEG)
	Image Size	L:1600x1200 pixels, S:800x600 pixels



Specifications

	Capacity (8MB)	Large : Super fine 10, Fine 15, Normal 20 Small : Super fine 30, Fine 45, Normal 60 <ul style="list-style-type: none"> • These figures are measured by internal memory based. • These figures are measured under Samsung's standard conditions and may vary depending on shooting conditions and camera settings.
Image Play		Single image / Thumbnails / Slide show / Movie Clip
Interface		Digital output connector : USB DC power input connector : 3.3V Video output : NTSC / PAL (User selectable)
Power Source		2 x AA alkaline / 2 x Ni-MH / 2 x Ni-MN / CR-V3 batteries AC adapter (Optional)
Dimensions (WxHxD)		110x61.5x41mm / 4.3x2.4x1.6in
Weight		180g / 6.3oz (without batteries and memory card)
Software	Camera Driver	Storage Driver (Windows98/98SE/2000/ME/XP, Mac OS 8.6 ~10.2)
	Application	MGI PhotoSuite, Digimax Viewer

System Requirements	Digimax 240
For Windows	PC with processor better than MMX Pentium 266MHz (XP : Pentium II 300MHz) Windows 98/98SE/2000/ME/XP Minimum 32MB RAM (XP : 128MB) 110MB of available hard-disk space USB port, CD-ROM drive 800X600 pixels, 16-bit color display compatible monitor (24-bit color display recommended)
For Macintosh	Power Mac G3 or later Mac OS 8.6 ~ 10.2 Minimum 64MB RAM 110MB of available hard-disk space, USB port CD-ROM drive QuickTime 4.0 or later for Movie Clip

* Specifications are subject to change without prior notice.

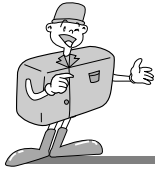

Software manual

Software Notes

Please ensure that you read the instruction manual carefully before use.

- The attached software is a camera driver and image editing software tool for Windows.
 - Under no circumstances should all or part of either the software or the user manual be reproduced.
 - Copyright for both software is licensed only for use with a camera.
 - In the unlikely event of a manufacturing fault, we will repair or exchange your camera. We cannot, however, be held responsible in any way for damage caused by inappropriate use.
 - Using a Hand-made PC or a PC that has not been guaranteed by the manufacturer is not covered by the Samsung warranty.
 - Before reading this manual, you should have a basic knowledge of computers and O/S (Operating Systems).
- ※ Windows is a registered trademark of Microsoft.
- ※ Macintosh, Mac is the registered trademark of Apple computer, USA.



Software manual

About software

After inserting the CD-ROM provided with this camera into the CD-ROM drive, the following window is automatically run.

Before connecting the camera to the PC, you should first install the camera driver.



NOTICE

- Disable other programs before installing the camera driver.



Setting up the application program

Access to the Samsung camera web-site.

Closing the auto run frame

- **Driver and Application** : for connecting the camera to the PC. All application programs (Digimax Viewer 1.0 for viewing images, MGI PhotoSuite III SE for editing images, and DirectX 8.1 for playing back movie clips) will be installed.

A USB Storage Driver is provided only for Windows.

A USB Driver for MAC is not included with the Application CD.

But you can use the camera with Mac OS 8.6~10.2.

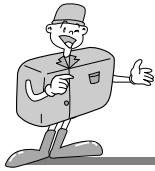

Software manual

■ Image Viewer Digimax Viewer 1.0 :

Program for viewing a stored image You can see the stored images in the memory directly on the PC monitor. And you can copy, move, delete the images and scale up /downscale the image sizes with Digimax Viewer. For windows only.

- Using Digimax Viewer (p.113)

■ Application MGI PhotoSuite III SE : Image editing program

Image editing program for downloaded images. For Windows only.

- Using MGI PhotoSuite III SE (p.114~128)

■ Internet link : You can visit the Samsung web-site through the internet.

- <http://www.samsungcamera.com> : English
- <http://www.samsungcamera.co.kr> : Korean



INFORMATION

- Check the system requirements (p.95) before setting up the driver.
- You should allow 5~10 seconds for running the automatic setup program according to the capability of the computer. If the frame does not show, run the [Windows Explorer] and select [Samsung.exe] in the CD-ROM Drive root directory.



Software manual

Setting up the application software

1. Click [Driver and Application] menu n the Autorun frame.



2. A [Welcome] window will open. Click the [Next>] button.



3. A [Start installation] window will open.
Click the [Next>] button.



INFORMATION

- If you select [Cancel] at the step 2, the camera driver installation will be cancelled and a window for installing Digimax Viewer 1.0 will be displayed.



Software manual

4. Installation is complete. Click the [Finish] button and the [Digimax Viewer 1.0] installation will be started.



5. The [Digimax Viewer 1.0] installation window will be displayed as shown alongside. Click [Next] button.



6. The Software License Agreement window will displayed. If you agree to it, click [Yes].



INFORMATION

- If you select [Cancel] at the step 5, the Digimax Viewer 1.0 installation will be cancelled and a window for installing MGI PhotoSuite III SE will be displayed.
- Refer to camera user manual (p.113) for using the Digimax Viewer 1.0.

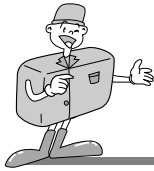

Software manual

7. Select a destination folder and click [Next].



8. Select the Program folder and click [Next].



9. Installation is complete. Click [OK] button and the [MGI PhotoSuite III SE] installation will be started.



NOTICE

- If you installed a secure program in your computer, the MGI PhotoSuite III SE installation can be delayed for about 10 ~ 20 seconds after clicking [OK] button at the step 9 or the installation can be cancelled.

10. The [Choose Setup Language] window will open. Select a language and click [OK] button.





Software manual



INFORMATION

- If you select [Cancel] at the step 10, the MGI PhotoSuite III SE installation will be cancelled and a window for installing DirectX 8.1 will be displayed.
- Refer to camera user manual (p.114~128) for using the MGI PhotoSuite III SE.

11. A [Welcome] window will be displayed.

Click [Next] to move to the next step.



12. The Software License Agreement window will be displayed.

If you agree to this, click [Yes] button.



13. A [Setup Type] window will open.

Select setup type and click [Next >] button.



14. If installation is completed correctly, Autoplay is registered automatically into the start menu program as shown alongside. Click [Next>] button.





Software manual

15. The MGI Registration window will be displayed.

Click the [Continue] button.



16. The [Online Registration Utility] window will be displayed.

Fill in the blanks and click the [Register] button.



17. Installation is complete. Click the [Finish] button.



18. [Windows (R) MGI PhotoSuite (R) III] window will open.

Read it and close the window.

19. All application programs are installed correctly.

Check [Yes, I want to restart my computer now.] button and click [Finish] button.



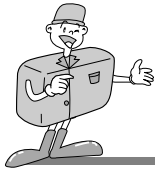

Software manual



NOTICE

- You must restart your computer after the installation, or your computer can't recognize the camera as a Removable disk.



INFORMATION

- If you have ever installed the DirectX program in your computer, the following windows will open.

19. The [DirectX 8.1] installation window will be displayed as shown alongside. Click [OK] button.



20. All application programs are installed correctly. Click [OK] button and the computer will restart.



21. After restarting the computer, connect the PC to the camera with the USB cable.

22. Turn the camera power on. [Found New Hardware Wizard] will open and the computer will recognize the camera.

- ※ If you have ever installed an image viewer program, the program will open. If the image viewer program opens, the camera driver was setup successfully.



Software manual

23. If you can see [Removable Disk] under [My computer], the camera driver installation is successful.

Now you can transfer image files from the camera to PC via the USB cable.



INFORMATION

- If you have installed the camera driver, [Found New Hardware Wizard] may not open.
- After the [Found New Hardware Wizard] window opens, a window may open to select the camera driver file location. In this case, select [C:\WINDOWS\INF\OTHER] folder. If you can't find [INF\OTHER] folder, check [Show all files] button in [Window's Explorer → View → Folder → option → View].

It is recommended that you use an AC adapter (Optional) when connecting the camera to a computer.

- Before connecting the camera to the PC, You should first install the camera driver first.



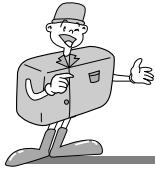

Software manual



INFORMATION

- After installing the camera driver, you have to restart your PC.
- If you connect the camera to the PC before installing the camera driver, the [Found New Hardware Wizard] will open. In this case, cancel the [Found New Hardware Wizard] and disconnect the connection. Install the camera driver and connect the camera and PC again.
- Should the computer not find the camera driver after installation, please try one or more of the following measures.
 1. Delete the camera driver (p.107~108), and re-install the driver.
 2. Refer to FAQ (p.129~130) to check for a possible solution to the problem.
 3. If your PC's central processing unit is VIA chip (This is shown in the USB Host Controller), download the patch file from the Samsung Camera web page.
(<http://www.samsungcamera.com>)



Software manual

Removing the USB Driver for Windows 98SE

1. Trace [Start → Settings] and click [Control Panel]



2. Double-click [Add/Remove programs].



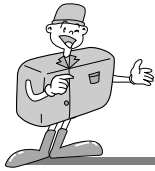

Software manual

3. The [Add/Remove Programs Properties] window will open. Click [Digimax 240 Mass Storage Driver] and click [Add/Remove] button.



4. A window will open.
Click [Next>] button.



5. Uninstall is complete.
Click the [Finish] button and the window will disappear.





Software manual

Removable Disk

To use this camera as a Removable Disk, install(p.99~106) the USB Driver.

1. Before turning the camera power on, connect the camera to the PC with the USB cable.
2. Click [Removable Disk] under [My computer] or [Windows Explorer].
3. Image files stored in the Removable Disk(DCIM → 100SSCAM) can be transferred to the PC.



NOTICE

Important information whilst using the Removable Disk

- The [Removable Disk] indicator will not show when the camera power is off.
- We recommend that you should copy the images to the PC to view them. Opening images directly from the removable disk may be subject to unexpected disconnection.
- When uploading images from the PC to the camera, ensure that the uploaded file names are not the same as those already stored on the memory.
- When you upload a file that is not taken by this camera to Removable Disk, the [FILE ERROR] message will be displayed on the LCD monitor in the PLAY mode, and nothing is displayed in THUMBNAIL mode.
- The green lamp next to the viewfinder will blink, when a file is transferred (copy or deletion) between the PC and the camera. Do not remove the USB cable until the lamp stops blinking. To remove the USB cable in Windows 2000/ME/XP, use the [Unplug or Eject Hardware] icon on the task bar.



[Green lamp]



Software manual

Removing the removable disk

■ Windows 98SE

1. Check whether the camera and PC are transferring a file. If the green camera status LED (next to viewfinder) blinks, you have to wait until the LED is off.
2. Unplug the USB cable.

■ Windows 2000/ME/XP

1. Check whether the camera and PC are transferring a file. If the green camera status LED (next to viewfinder) blinks, you have to wait until the LED is off.
2. Double-click the [Unplug or Eject Hardware] icon on the task bar.



3. The [Unplug or Eject Hardware] window will open. Select the [USB Mass Storage Device] and click the [Stop] button.





Software manual

4. The [Stop a Hardware device] window will open. Select the [USB Mass Storage Device] and click the [OK] button.

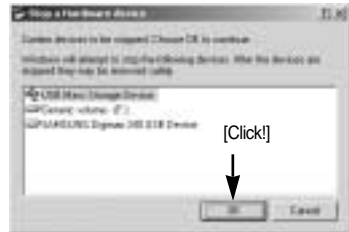

5. A [Safe to Remove Hardware] window will open. Click the [OK] button.



6. A [Unplug or Eject Hardware] window will open. Click the [Close] button and the removable disk will be removed safely.



7. Unplug the USB cable.



Software manual

Setting up the USB Driver for MAC

1. A USB Driver for MAC is not included with the Application CD as MAC OS support the camera driver.
2. Check the MAC OS. You can check the MAC OS version during MAC OS start-up.
This camera is compatible with MAC OS 8.6-10.2.
3. Connect the camera to the Macintosh and turn the camera power on in PC mode.
4. A new icon (Untitled) will be displayed on the desktop after connecting the camera to the MAC.

Using the USB Driver for MAC

1. Double click a new icon (Untitled) on the desktop and the folder in the memory will be displayed.
2. Select an image file and copy or move it to MAC.



NOTICE

If you use Mac OS 10.0 or later, you may experience happening an error when you transfer files from the PC to the camera.



Software manual

Digimax Viewer

This software is only compatible with Windows.

To open Digimax Viewer, click the [Start → Programs → Samsung Digimax Viewer 1.0 → Digimax Viewer 1.0] and Digimax Viewer 1.0 will then open.

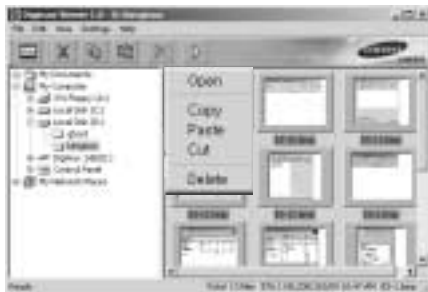

Select an image and press the right mouse button. A pop-up menu will open.

Open : allows you to view a selected sequence of images, one at a time.

Copy : copies files. After copying a file, select a folder where you want to paste the copied file. Click the right mouse button and a pop-up menu will open. Select [Paste] and the copied file is pasted.

Paste : pastes a copied file

Cut : cuts a selected file.

Delete : deletes a selected file

If the Auto Launch option is selected, this program will be executed automatically with recognizing the camera.

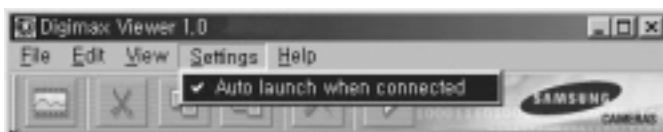

※ Refer to the [Help] menu in Digimax viewer about further information.



Software manual

MGI PhotoSuite III SE

This software is only compatible with Windows.







To open MGI PhotoSuite III SE, click the [Start → Programs → MGI PhotoSuite III SE → MGI PhotoSuite III SE] and MGI PhotoSuite III SE will then open.





Software manual

- An introduction to the Welcome screen









	<p>Get</p> <p>Get images.</p>
	<p>Prepare</p> <p>A number of photo editing activities can be performed within this module.</p>
	<p>Compose</p> <p>Use your photos in a variety of fun, creative and interesting ways.</p>
	<p>Organize</p> <p>Organize your photos and other media files into albums.</p>
	<p>Share</p> <p>Save your results to show to others.</p>
	<p>Print</p> <p>Print hard copies of photos and projects.</p>

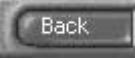

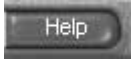
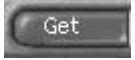
Software manual

■ Introduction to navigation bar



	Back Return to the previous step.
	Home Return to Welcome screen.
	Help Display help window.
	Get Get images.
	Prepare A number of photo editing activities can be performed within this module.
	Compose Use your photos in a variety of fun and interesting ways.
	Organize Organize your photos and other media files into albums.
	Share Save your results to show to others.
	Print Print hard copies of photos and projects.
	Browse Browse the web site.



Software manual

GET

■ To obtain images from the computer

1. To acquire images, Click the large [Get] button on the Welcome screen, or the [Get] button on the Navigation bar. Click [Computer] from the list of options displayed on the activity panel.



2. The Open file selector is displayed. Now select the image file and click [open].



3. The Welcome screen will change to the next work step, with the selected image displayed.



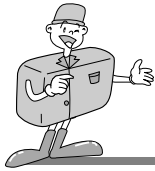

Software manual

■ When you obtain images from the digital camera.

Before transferring an image file, check the USB connection.

1. To acquire images, click the large [Get] button on the Welcome screen, or the [Get] button on the Navigation bar. Click [Computer] from the list of options displayed on the activity panel.



2. The Open file selector is displayed. Click [Look in :] to choose [Removable Disk(:)] and click [open] for the open file window to be displayed.



3. Select the [DCIM → 100SSCAM] folder. Then select an image and click [Open].





Software manual

4. The Welcome screen will change to the next work step, with the selected image displayed.



NOTICE

When you use the Digimax camera, only [Computer] and [Album] from the list of options displayed are available. You will be able to obtain images from the digital camera.



[Computer and Album Only]



Software manual

■ Acquiring images from an Album.

1. To acquire images, click the large [Get] button on the Welcome screen, or the [Get] button on the Navigation bar. Click [Album] from the list of options displayed on the activity panel.



2. After selecting Album on the [①Choose a photo album], click an image in the album and click [Open].



3. The Welcome screen will change to the next work step, with the selected image displayed.

※ Refer to page 124 for more information about creating an Album.



Software manual

PREPARE

When the image is loaded, the step changes to Prepare automatically.

■ Menu of [PREPARE] steps

Rotate & Crop

You can rotate, flip or crop images along with a host of others.



Touchup

Remove Red eye, Remove Scratches etc.. are available in this menu.

Special Effects

A number of special effects can be applied.

Stitching

Join a series of photos together to create a sweeping panoramic effect.



Software manual

COMPOSE

Add text, Compound Images etc. are available in this step.

■ Menu of [COMPOSE] steps

Collages : A collage consists of several photos or sections of photos arranged together on a common background.

Photo Layouts : The Photo Layouts activity includes many collage and layout options.

Cards & tags : Use your photos to create items such as Gift Tags, Greeting Cards, Invitations, Postcards, and Sports Cards.

Calendars : Use your photos to create a variety of calendars (monthly, quarterly, seasonal, yearly).

Collections : Photos can also be used to create a variety of items for business purposes.

Fun stuff : You can make magazine covers, Backgrounds, etc. in this menu.

Business : You can make business items such as business cards, certificates, signs, labels, promotions, name tags, stationary

Frames & Edges : Add frames and edge effects to your photos according to predefined templates.





Software manual

ORGANIZE

Organize your photos and other media files into albums.

■ Menu of [ORGANIZE] steps

[①] Choose a photo album to view or edit]

Select Album : To create an Album, click [Organize] in the welcome screen or navigation bar.

Album.. : Open Master Album.

[②] Select a photo, and choose an action below.]

- Open : Open selected image.
- Delete : Delete selected image.
- Properties... : view image information.

[③] Choose an action to manage your album.]

- Add : click [Add] to add an image to an Album.
- Sort : click [Sort] to Sort saved images.
- Search : click [Search] to Search saved images.
- Reset : click [Reset] to reset the setting.
- Update : click [Update] to update images.
- Create Slide Show : click [Create Slide Show] to create a Slide Show.

Always start on this page : If you select this option, the program will start in [Organize].

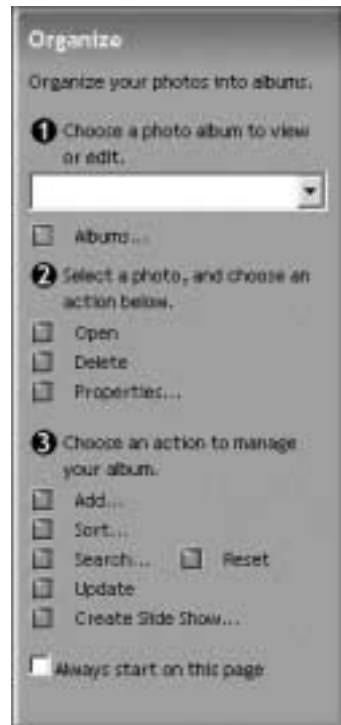

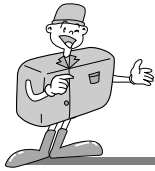

Software manual

■ Creating an Album

1. To create an Album, click the large Organize button on the Welcome screen, or the Organize button on the Navigation bar.
2. Click [Album..] in [①Choose a photo album to view or edit.]
3. The Master Album window will be displayed, then click [New..].
4. Put a new Album name in the New Album window and click [OK]. A new album will now be created.
5. [Master Album] window will open. Click [OK] button.

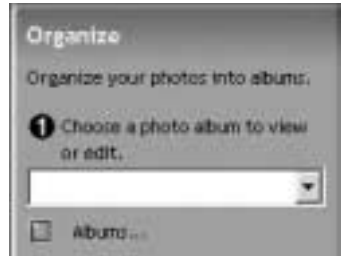



Software manual

■ Add images to the album

1. Select [ⓂChoose an action to manage your album. → Add..] to add images to the album.

[Click!]



2. Click [Computer] in Add Photos menu.

[Click!]

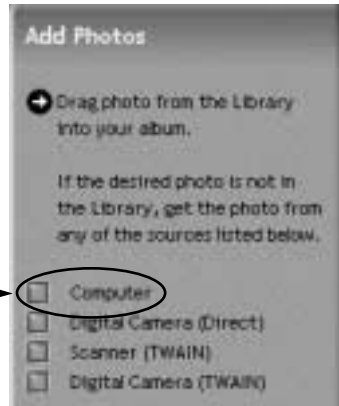

NOTICE

[Digital Camera(Direct)], [Scanner(TWAIN)], [Digital Camera(TWAIN)] sources can't be used.

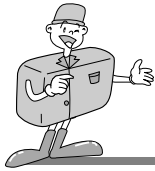

Software manual

3. [Add photo to Album] window will open. Select images that you want to add. Click [Add] button.



[Click!]

4. Adding images is complete.

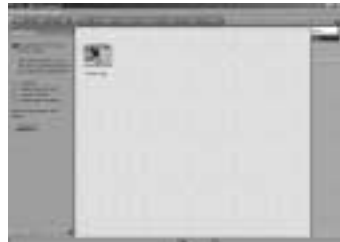



Software manual

SHARE

Saving or sharing images.

■ Menu of [SHARE] step

Save

To save the active file according to its current name and path.

Save As

To assign a new name or path to the file.

Send E-mail

e-mailing images.

Slide Show

Viewing images as a slide show.



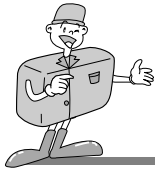

Software manual

PRINT

You can print images.

■ Menu for the [PRINT] step

Print

Printing images.

Print Multiples

Print multiple copies of a photo or project, or one copy of each of the photos included in an album, according to a predefined template.

- * Choose a printer, an orientation, the print size, and the number of copies. You can then print the images.



INFORMATION

For more information, please refer to the Help file in [Help MGI PhotoSuite III help].



FAQ

About USB

Please check the following if the USB connection malfunctions.

- [Case 1] The camera power is off.
 - Turn the camera power on. We recommend using an AC power adapter in PC mode. If you use batteries, check the battery condition.

- [Case 2] USB Driver is not installed correctly.
 - Install the USB Driver correctly. Refer to pages 99~106.

- [Case 3] The USB cable is not connected or you are using a cable with an incorrect specification.
 - Use a USB cable with the correct specification.

- [Case 4] Occasionally the computer recognizes the USB as another device.
 - Install the camera driver correctly. Turn the camera power off and remove the USB cable.
Connect the USB cable again and turn the camera power on. The computer should now recognize the camera.

- [Case 5] There is an unexpected error during file transfer.
 - Turn the camera power off and on again. Transfer the file again.

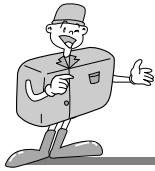

FAQ

About USB

[Case 6] How do I know my computer supports a USB Interface?

- Check the USB port in your computer or keyboard.
- Check OS version. USB Interface is available in Windows 98, 98SE, 2000, ME .XP.
- Check [Universal serial bus controller] in Device Manager.

Do the following to check [Universal serial bus controller].

Win 98/ME : Trace [Start → Setting → Controller → System → Device Manager
→ Universal serial bus controller]

Win 2K : Trace [Start → Setting → Controller → System → Hardware Device
Manager Universal serial bus controller].

Win XP : Trace [Start → Control Panel → Performance and Maintenance →
System → Hardware Device Manager → Universal Serial Bus
controller].

There must be USB Host Controller and USB root hub under [Universal serial bus
controller].

- When all the conditions mentioned above are met, the computer can support the USB interface.

[Case 7] When using USB hub.

- There may be a problem in connecting the camera to the PC through the USB hub if the PC and the hub are not compatible. Wherever possible, connect the camera to the PC directly.

[Case 8] Are other USB cables connected to the PC?

- The camera may malfunction when it is connected to the PC at the same time as another USB cable.. In this case, disconnect the other USB cable, and connect only one USB cable to the camera.



MEMO

SOFTWARE



SAMSUNG TECHWIN CO., LTD.
OPTICS & DIGITAL IMAGING DIVISION
145-3, SANGDAEWON 1-DONG, JUNGWON-
GU, SUNGNAM-CITY, KYUNGKI-DO, KOREA 462-121
TEL : (82) 31-740-8086, 8088, 8090, 8092, 8099
FAX : (82) 31-740-8398, 8111

SAMSUNG OPTO-ELECTRONICS AMERICA, INC.
HEADQUARTERS
40 SEAVIEW DRIVE, SECAUCUS, NJ07094, U.S.A.
TEL : (1) 201-902-0347
FAX : (1) 201-902-9342

WESTERN REGIONAL OFFICE
18600 BROADWICK ST.,
RANCHO DOMINGUEZ, CA 90220, U.S.A.
TEL : (1) 310-537-7000
FAX : (1) 310-537-1566

SAMSUNG OPTO-ELECTRONICS UK LTD.
SAMSUNG HOUSE, 3 RIVERBANK WAY,
GREAT WEST ROAD, BRENTFORD,
MIDDLESEX, TW8 9RE, U.K.
TEL : (44) 20-8232-3280
FAX : (44) 20-8569-8385

SAMSUNG OPTO-ELECTRONICS GMBH
AM KRONBERGER HANG 6
D-65824 SCHWALBACH/TS., GERMANY
TEL : (49) 6196 66 53 03
FAX : (49) 6196 66 53 66

SAMSUNG FRANCE S.A.S.
BP 51 TOUR MAINE MONTPARNASSE
33, AV .DU MAINE
75755, PARIS CEDEX 15, FRANCE
HOTLINE PHOTO NUMÉRIQUE :
00 800 22 26 37 27 (Numéro Vert-Appel Gratuit)
TEL : (33) 1-4279-2282/5
FAX : (33) 1-4320-4510

SAMSUNG TECHWIN MOSCOW OFFICE
KORP. 14 37-A LENNINGRADSKY PRO-KT
MOSCOW, 125167, RUSSIA
TEL : (7) 095-258-9296, 9298, 9299
FAX : (7) 095-258-9297

TIANJIN SAMSUNG OPTO-ELECTRONICS CO.,LTD.
7 PINGCHANG ROAD NANKAI DIST., TIANJIN
P.R CHINA
POST CODE:300190
TEL : (86) 22-2761-8867
FAX : (86) 22-2761-8864

* Internet address - [http : //www.samsungcamera.com/](http://www.samsungcamera.com/)



The CE Mark is a Directive conformity
mark of the European Community (EC)

6806-1384

Free Manuals Download Website

<http://myh66.com>

<http://usermanuals.us>

<http://www.somanuals.com>

<http://www.4manuals.cc>

<http://www.manual-lib.com>

<http://www.404manual.com>

<http://www.luxmanual.com>

<http://aubethermostatmanual.com>

Golf course search by state

<http://golfingnear.com>

Email search by domain

<http://emailbydomain.com>

Auto manuals search

<http://auto.somanuals.com>

TV manuals search

<http://tv.somanuals.com>