

SAMSUNG

SAMSUNG DIGIT*all*
everyone's invited™

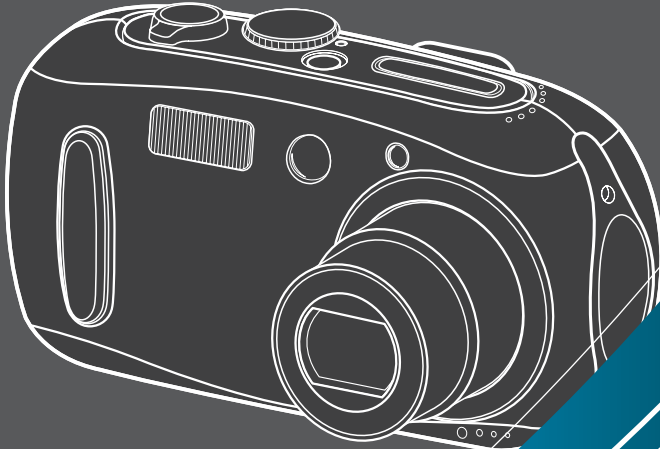

ENGLISH
• **Digimax V10**

SAMSUNG CAMERA

User's Manual

Digimax V700

Thank you for buying a Samsung Camera.

This manual will guide you through using the camera, including capturing images, downloading images and using the software applications. Please read this manual carefully before using your new camera.

Download from [Www.Somanuals.com](http://www.Somanuals.com). All Manuals Search And Download.

Instructions

- Use this camera in the following order

Set up the camera driver

Before connecting the camera to a PC, via the USB cable, you will need to set up the camera driver. Install the camera driver that is contained in Application software CD-ROM.(p.110)

Take a picture

Take a picture (p.22)

Insert the USB cable

Insert the supplied USB cable into the PC's USB port and the camera's USB connection terminal.(p.120)

Check the camera's power

Check the camera's power. If the power is turned off, press the camera button to turn it on.(p.29)

Check [Removable Disk]

Open Window's EXPLORER and search for [Removable Disk].(p.121)

- If you use a card reader to copy the images on the memory card to your PC, the images could be damaged. When transferring the images taken with the camera to your PC, be sure to use the supplied USB cable to connect the camera to your PC. Please note that the manufacturer holds no responsibility for loss or damage of images on the memory card due to the use of a card reader.

Contents

READY

● Getting to know your camera	5
● About the icons	5
● Danger	6
● Warning	6
● Caution	7
● An FCC warning	7
● System chart	8
● Identification of features	10
■ Front & Top	10
■ Back	10
■ Side/ 5-function button	11
■ Mode dial	11
● Connecting to a Power Source	14
■ Using the AC power adapter	15
■ Using the batteries	16
■ Removing the battery	16
● Instructions on how to use the memory card	17
● Inserting the memory card	19
● Removing the memory card	19
● When Using the Camera for the First Time	20

RECORDING

● LCD monitor indicator	21
● Starting the recording mode	22
■ How to use the AUTO mode	22
■ How to use the PROGRAM mode	23
■ How to use the APERTURE PRIORITY mode	23
■ How to use the SHUTTER PRIORITY mode	24
■ How to use the MANUAL mode	24
■ How to use the MySET mode	25
■ How to use the MOVIE CLIP mode	25
■ How to use the SCENE mode	27

■ How to use the VOICE RECORDING mode	27
● Things to Watch Out for When Taking Pictures	28
● Using the camera buttons to adjust the camera	29
■ POWER button	29
■ SHUTTER button/ Jog dial	29
● ZOOM W/T button	29
● Voice memo/ UP button	32
● Macro/ Down button (Focusing)	33
● Focus lock	34
● FLASH/ LEFT button	34
● Self-timer/ Remote/ Right button	37
● MENU/ OK button	39
● +/- button	40
● AEL/ASM button	43
● MF button	44
● LCD button	45
● Using the LCD monitor to adjust the camera settings	46
● How to use the menu	49
● Size	49
● Quality	50
● Metering	51
● Continuous shot	52
● Sharpness	53
● Effect	53
● Special Effect	54
● Special Effect : Preset focus frames	54
● Special Effect : Composite shots	55
● Special Effect : Photo Frame	56
● Save / Load a specific camera configuration (MySET)	57
● Scene	58
● Movie Clip frame stabiliser	59

Contents

PLAY

● Starting play mode	60
■ Playing back a still image	60
■ Playing back a movie clip	61
■ How to capture the movie clip	61
■ On camera movie trimming	62
■ Playing back a recorded voice	63
● LCD monitor indicator	64
● Using the camera buttons to adjust the camera	65
■ Thumbnail / Enlargement button	65
● Voice memo / Up button	66
● Play & Pause/ Down button	67
● LEFT/ RIGHT/ MENU/ OK button	68
● LCD button	68
● Delete button	69
● Album button (MF button)	70
● Setting up the play back function using the LCD monitor	73
● Starting the slide show	76
● Protecting images	77
● Deleting images	78
● Resize	79
● Rotating an image	80
● DPOF	81
● DPOF : STANDARD	81
● DPOF : INDEX	82
● DPOF : PRINT SIZE	82
● PictBridge	83
● PictBridge: Picture Selection	84
● PictBridge: Print Setting	85
● PictBridge: Printing	86
● PictBridge: DPOF print	86
● PictBridge : RESET	87

SETUP

● Setup menu	88
--------------------	----

● File name	89
● Auto power off	90
● Language	91
● Formatting a memory card	91
● Setting up the Date/ Time/ Date type	92
● Imprinting the recording date	92
● Sound	93
● Connecting an External Device (USB)	93
● Auto Focus lamp	94
● LCD brightness	94
● Selecting Video out type	95
● Quick view	96
● Initialisation	96
● Setting up the MYCAM menu	97
● Start up image	97
● Start up sound	98
● Shutter sound	98
● Important notes	99
● Warning indicator	101
● Before contacting a service centre	102
● Specifications	105

SOFTWARE

● Software Notes	107
● System Requirements	107
● About the software	108
● Setting up the application software	110
● Starting PC mode	120
● Removing the USB Driver for Windows 98SE	123
● Removable Disk	124
● Removing the removable disk	125
■ Setting up the USB Driver for MAC	126
■ Using the USB Driver for MAC	126
● Digimax Viewer 2.1	127
● Digimax Reader	128
● Using PhotImpression	130
● FAQ	132

Getting to know your camera

Thank you for buying a Samsung Digital Camera.

- Prior to using this camera, please read the user manual thoroughly.
 - When you require After Sales service, please bring the camera and the cause of the camera malfunction (such as Batteries, Memory card etc.) to the A/S centre.
 - Please check that the camera is operating properly prior to when you intend to use it (e.g. for a trip or an important event) to avoid disappointment. Samsung camera takes no responsibility for any loss or damages that may result from camera malfunction.
 - Keep the manual in a safe place.
- * Microsoft, Windows and Windows logo are registered trademarks of Microsoft Corporation incorporated in the United States and/or other countries.
- * All brand and product names appearing in this manual are registered trademarks of their respective companies.

About the icons

This manual contains instructions on using this camera that will help you to use this camera safely and correctly. This will help prevent danger and injury to others.



DANGER

DANGER indicates an imminently hazardous situation which, if not avoided, will result in death or serious injury.



WARNING

WARNING indicates a potentially hazardous situation, which, if not avoided, could result in death or serious injury.



CAUTION

CAUTION indicates a potentially hazardous situation, which, if not avoided, may result in a minor or moderate injury.

Danger

- Do not attempt to modify this camera in any way. This may result in fire, injury, electric shock or severe damage to you or your camera. Internal inspection, maintenance and repairs should be carried out by your dealer or Samsung Camera Service centre.
- Please do not use this product in close proximity to flammable or explosive gases, as this could increase the risk of explosion.
- Should any form of liquid or a foreign object enter the camera, do not use it. Switch off the camera, and then disconnect the power source (batteries or AC Power Adapter). You must contact your dealer or Samsung Camera Service centre. Do not continue to use the camera as this may cause a fire or electric shock.
- Do not insert or drop metallic or inflammable foreign objects into the camera through access points e.g. the memory card slot and battery chamber. This may cause a fire or electric shock.
- Do not operate this camera with wet hands. This could pose a risk of electric shock.

DANGER

Warning

- Do not use the flash in close proximity to people or animals. Positioning the flash too close to your subject's eyes, may cause eyesight damage.
- When taking photographs, never point the lens of the camera directly into very strong light. This may result in permanent damage to your eyesight.
- For safety reasons keep this product and accessories out of reach of children or animals to prevent accidents e.g.:
 - Swallowing batteries or small camera accessories. If an accident should occur, please consult a doctor immediately.
 - There is the possibility of injury from the camera's moving parts.
- Batteries and camera may become hot during prolonged use and it may result in camera malfunction. Should this be the case, allow the camera to sit idle for a few minutes to allow it time to cool.
- Do not recharge non rechargeable batteries. This may cause an explosion.
- Do not leave this camera in places subject to extremely high temperatures, such as a sealed vehicle, direct sunlight or other places of extreme variances in temperature. Exposure to extreme temperatures may adversely affect the camera's internal components and could cause a fire.
- When in use, do not cover the camera or AC Power Adapter. This may cause heat to build up and distort the camera body or cause a fire. Always use the camera and its accessories in a well-ventilated area.

WARNING

Caution

- Leaking, overheating, or burst batteries could result in fire or injury.
 - Use batteries with the correct specification for the camera.
 - Do not short circuit, heat or dispose of batteries in fire.
 - Do not insert the batteries with the reverse polarities.
- Remove the batteries when not planning to use the camera for a long period of time. Batteries may leak corrosive electrolyte and permanently damage the camera's components.
- Do not fire the flash while it is in contact with hands or objects. Do not touch the flash after using it continuously. It may cause burns.
- Do not move the camera while it is switched on, if you are using the AC Power Adapter. After use, always switch off the camera before unplugging the adapter from the wall socket. Then make sure that any connector cords or cables to other devices are disconnected before moving the camera. Failure to do so may damage the cords or cables and cause a fire or electric shock.

CAUTION

An FCC warning

- This device has been tested in accordance with the limits of a class B digital device under item 15 of the FCC rules. These limits are designed to provide protection against harmful interference in commercial installation. This equipment generates, absorbs and can emit radio frequency energy. If it is not installed and used in accordance with the instructions, it may cause harmful interference to radio communication. There is however, no guarantee that interference will not occur in some situations. Should any interference occur when this device is in operation, please try one or more of the following measures.
 - Change the location and direction of any aerial.
 - Increase distance between the camera and the affected device.
 - Use a different socket away from the affected device.
 - Please contact a Samsung agent or a radio/TV engineer.
- This device complies with part 15 of the FCC Rules.
- Changes or modifications not expressly approved by the party responsible for compliance could void user's authority to operate the equipment.

System chart

Please check that you have the correct contents before using this product. To buy the optional equipment, contact your nearest Samsung dealer or Samsung service centre.

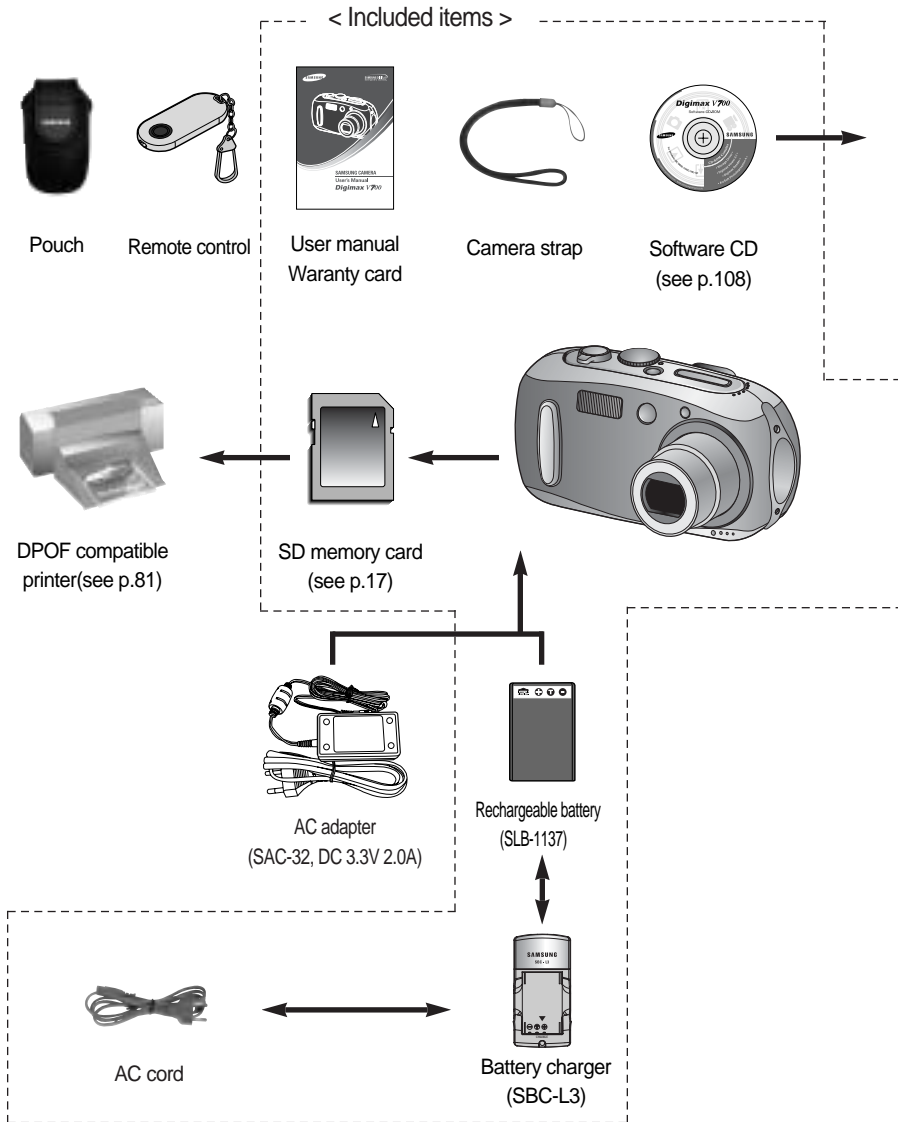

System chart



Computer
(see p.120)



PictBridge compatible
printer(see p.83)



USB cable



AV cable



External monitor
Yellow cable – Video
White colour - Voice
(see p.95)

System Requirements

For Windows

- PC with processor better than MMX Pentium 233MHz (XP : Pentium II 300MHz)
- Windows 98/98SE/2000/ME/XP
- Minimum 32MB RAM (XP : 128MB)
- 140MB of available hard-disk space
- USB port
- CD-ROM drive
- 800x600 pixels, 16-bit colour display compatible monitor (24-bit colour display recommended)

For Macintosh

- Power Mac G3 or later
- Mac OS 9.2 ~ 10.3
- Minimum 64MB RAM
- 110MB of available hard-disk space
- USB port
- CD-ROM drive
- QuickTime player
- DivX(for movie clip)

CAUTION

When you connect the camera to a computer, printer or external monitor, you have to use the USB/ AV cable supplied with the camera, or the external devices can't recognise the camera.

Identification of features

Front & Top

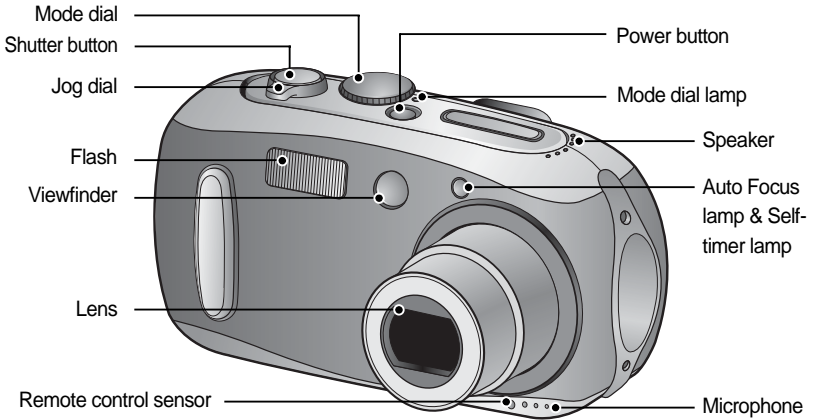

Back

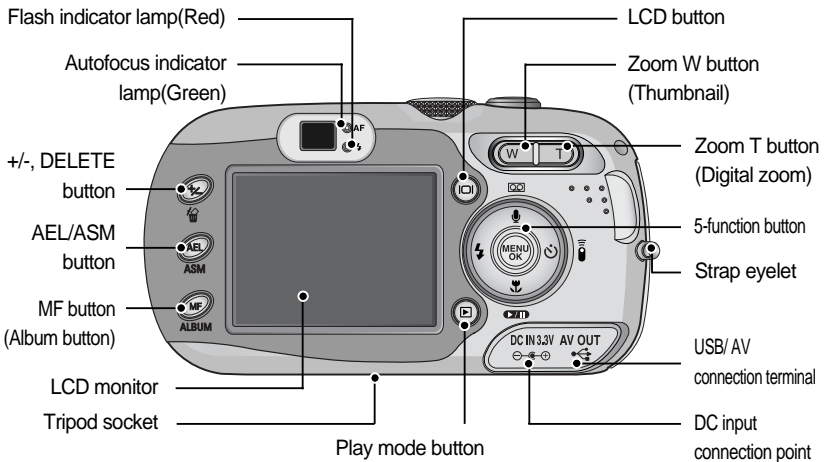

Identification of features

Side/ 5-function button

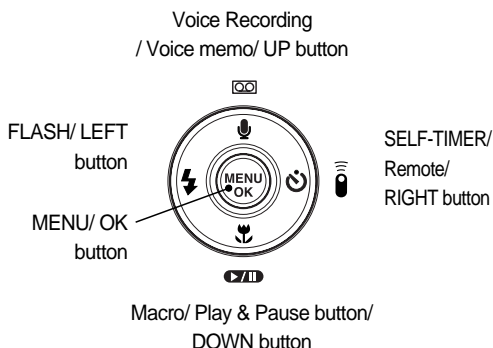
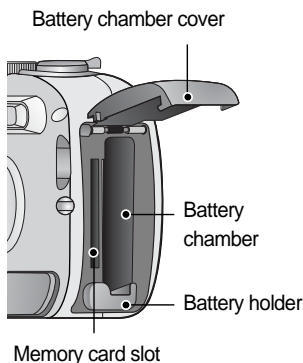

Mode dial

- You can select the desired working mode by using the mode dial located on the top of the camera. This digital camera has 8 recording modes. These are listed below.

- AUTO mode

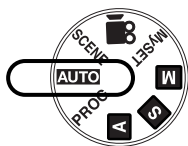

Please select this mode for quick and easy picture taking with minimal user interaction.

- PROGRAM mode



Selecting the automatic mode will configure the camera with optimal settings. You can still manually configure all functions except the iris and shutter speed.

Identification of features

- A (Aperture priority) shooting mode

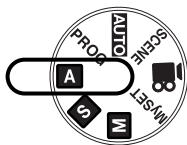

Set the aperture value for automatic exposure depends on the brightness of the object by automatic shutter speed setting in the camera.

- S (Shutter priority) shooting mode

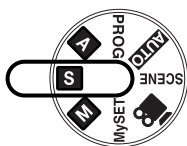

Set the shutter speed for automatic exposure depends on the brightness of the object by automatic aperture value setting in the camera.

- M (Manual) shooting mode

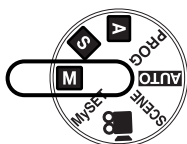

The user can manually set both the aperture value and the shutter speed.

- MySET mode

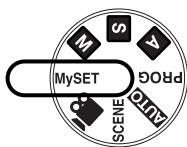

This mode allows users to save frequently used shooting settings for later use.

- MOVIE CLIP mode

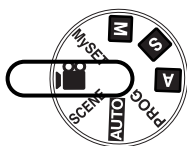

A movie clip can be recorded for as long as the available recording time of the memory capacity allows.

- Image size : 640X480, 320X240, 160X128 (user selectable)
- Movie clip file type : *.avi(MPEG-4)

- SCENE mode

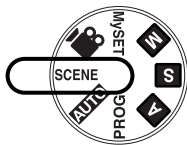

Use the menu to easily configure optimal settings for a variety of shooting situations. These include NIGHT, PORTRAIT, CHILDREN, LANDSCAPE, CLOSE UP, TEXT RECOGNITION, SUNSET, DAWN, BACKLIGHT, FIREWORKS and BEACH & SNOW scenes.

Identification of features

■ Self-timer lamp (Based on 10-second Self-timer; see p. 37)

Colour	Status	Camera Status
Red	Blinking	- For the first 8 seconds, the LED blinks at 1second intervals. - For the final 2 seconds, the LED blinks quickly at 0.25-second intervals.

■ Auto focus indicator lamp

Colour	Status	Camera Status
Green	Blinking	Recording Mode (lightly press the shutter button): Not focused PC Mode: Transmitting Data
	On	Recording Mode (lightly press the shutter button): Focused

■ Flash indicator lamp

Colour	Status	Camera Status
Red	Blinking	Flash in the process of charging
	ON	Flash ready

■ Mode dial lamp

Colour	Status	Camera Status
Green	ON	Turned off the LCD with the LCD button. PC Mode: When the USB cable is inserted.

■ Mode icons

MODE	AUTO	PROGRAM	A priority	S priority	Manual	MySET	VOICE RECORDING	MOVIE CLIP	PLAY		
Icon											
MODE	SCENE										
	Night	Portrait	Children	Landscape	Close up	Text	Sunset	Dawn	Backlight	Fireworks	Beach & Snow
Icon											

Connecting to a Power Source

- There are two ways in which to provide the camera with power. You can use batteries or alternatively, you can use an AC(100 ~ 250V) Adapter (DC 3.3V 2.0A).
- We recommend using rechargeable battery (SLB-1137).

INFORMATION

Important information about battery usage

- When the camera is not used, turn off the camera power.
- Do not charge the non rechargeable batteries. It may cause an explosion.
- Please remove the batteries if the camera will not be used for long periods.
- Batteries can lose power over time and are prone to leaking if kept inside the camera.
- Low temperatures (below 0°C) can affect the performance of the batteries and you may experience reduced battery life.
- Batteries will usually recover at normal temperatures.
- During extended use of the camera, the camera body may become warm.
This is perfectly normal.
- If the camera is in PC mode, slide show, playing back a voice recording or playing back a movie clip, it is recommended that you use an AC adapter.

Connecting to a Power Source

Using the AC power adapter (SAC-32, DC 3.3V 2.0A, optional)

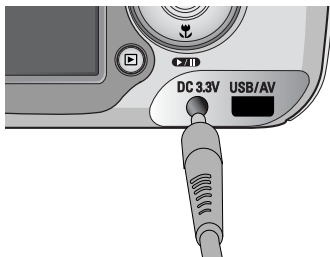

If you have access to a mains supply, using an AC Adapter (SAC-32, DC 3.3V 2.0A) allows the camera to be used for long periods of time. Plug the adapter into the connection point (DC IN 3.3V) on the camera. Remove the batteries from the camera when using an AC adapter.



DANGER

- Always turn off the power before taking the AC adapter out of the mains supply.
- As with all mains powered devices, safety is important. Ensure that neither the camera nor adapter comes into contact with water or metallic materials.
- Please ensure that you use an AC adapter (3.3V 2.0A) with the correct specification for the camera. Failure to do so may affect your warranty.

Connecting to a Power Source

Using the batteries

: If the camera does not turn on after you have inserted batteries, please check whether the batteries are inserted with the correct polarity(+/-).

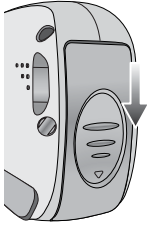

1. Open the battery chamber cover by pushing in the direction of the arrow.

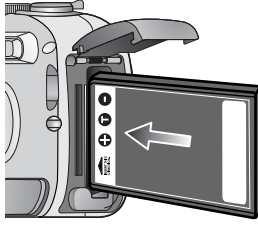

2. Insert the batteries taking note of the polarity (+ / -).

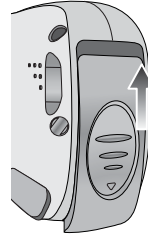

3. To close the battery chamber cover, push it until it clicks.

Removing the battery

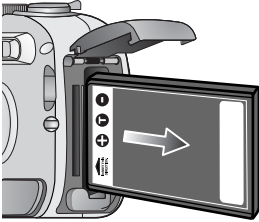



1. Turn off the camera power. Open the battery chamber cover and move the battery holder aside. The battery will be released.
2. Take out the battery and close the battery chamber cover.

INFORMATION

- When the battery chamber cover is opened, do not press the battery chamber cover by force. This may cause the battery chamber cover modification or breakage.

- There are 3 indicators for battery condition that are displayed on the LCD monitor.

Battery indicator			
Battery status	The batteries are fully charged	Prepare new batteries	There is no battery capacity. Replace with new batteries.

Instructions on how to use the memory card

Maintenance of the memory card

- Be sure to format the memory card (see p.91) if you are using a newly purchased memory for the first time, if it contains data that the camera cannot recognise, or if it contains images captured with a different camera.
- Turn off the camera power whenever the memory card is being inserted or removed.
- Repeated use of the memory card will eventually reduce the memory card's performance. Should this be the case, you will need to purchase a new memory card. Wear and tear on the memory card is not covered by the Samsung warranty.
- The memory card is an electronic precision device.
Do not bend, drop or subject the memory card to any heavy impact.
- Do not store the memory card in an environment with strong electronic or magnetic fields, e.g. near loud speakers or TV receivers.
- Please do not use or store in an environment where there are extremes in temperature.
- Do not allow the memory card to become dirty or to come into contact with any liquid. Should this happen, clean the memory card with a soft cloth.
- Please keep the memory card in its case when not in use.
- During and after periods of extended use, you may notice that the memory card is warm. This is perfectly normal.
- Do not use a memory card that is used in another digital camera.
To use the memory card in this camera, format first the memory card by using this camera.
- Do not use a memory card formatted by another digital camera or memory card reader.

Preserving the memory card data

- If the memory card is subjected to any of the following, the recorded data may become corrupted :
 - When the memory card is used incorrectly.
 - If the power is switched off or the memory card is removed while recording, deleting (formatting) or reading.
- Samsung cannot be held responsible for lost data.
- It is advisable to copy important data onto other media as back-up e.g. floppy disks, hard disks, CD etc.
- If there is insufficient memory available : If you press the shutter button for the shot, a [Card Full !] message will appear and the camera will not operate. To optimise the amount of memory in the camera, replace the memory card or delete unnecessary images stored on the memory.

Instructions on how to use the memory card

INFORMATION

- Don't remove the memory card when the Auto focus lamp(Green) is blinking as this may cause damage to data in the memory card.

- The camera can use SD Memory Cards and MMC (Multi Media Cards).
Please consult the enclosed manual for using the the MMC Cards.

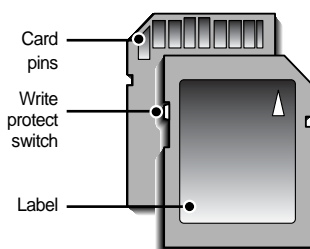

[SD(Secure Digital) memory card]

The SD memory card has a write protect switch that prevents image files from being deleted or formatted.

By sliding the switch to the bottom of the SD memory card, the data will be protected.

By sliding the switch to the top of the SD memory card, the data protection will be canceled. Slide the switch to the top of the SD memory card before taking a picture.

- When using a 32MB SD memory card, the specified shooting capacity will be as follows.
(These figures are intended as an indication of expected performance). These figures are approximate as image capacities can be affected by variables such as subject matter.

Recorded image size	TIFF	S. Fine	Fine	Normal	30 FPS	15FPS	
Still image	3072X2304	1	9	15	23	-	-
	2816X2112	1	10	18	26	-	-
	2592X1944	1	11	21	33	-	-
	2272X1704	2	14	26	40	-	-
	2048X1536	3	17	33	50	-	-
	1600X1200	4	30	51	60	-	-
	1024X768	11	60	106	129	-	-
640X480	22	121	165	202	-	-	
Movie clip	640X480	-	-	-	About 2MIN	About 4MIN	
	320X240	-	-	-	About 4MIN	About 7MIN	
	160X128	-	-	-	About 8MIN	About 15MIN	

Inserting the memory card

1. Turn off the camera's power and pull the battery chamber cover in the direction of the arrow to open.

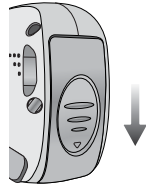

2. Have the front of the memory card facing toward the front of the camera (lens) and the card pins toward the back of the camera (LCD monitor), and then push the memory card into the card slot until you hear a click.

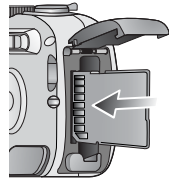

3. To close, push the battery chamber cover until you hear a click. If the memory card does not slide in smoothly, do not attempt to insert it by force. Check the direction of insertion, and then insert it correctly. Do not insert the memory card the wrong way round. Doing so may damage the memory card slot.

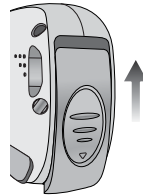

Removing the memory card

1. Turn the power off using the power button.
Open the battery chamber cover and press the memory card as shown in the image and release.
2. Remove the memory card and close the battery chamber cover.

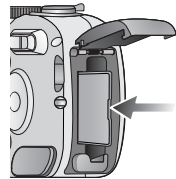

INFORMATION

- When the camera is turned on, inserting or removing the memory card makes the camera power be turned off.

When Using the Camera for the First Time

- If the camera is turned on for the first time, a menu will be displayed to set date, time and language in the LCD monitor. This menu will not be displayed after setting up the date, time and language. Set up the date, time and language before using this camera.

- Setting up the date, time and date type

1. Select the [D & Time] menu by pressing the UP/DOWN button and press the RIGHT button.
2. Press the UP/DOWN/LEFT/RIGHT button to select the desired sub menu and press the OK button.

RIGHT button : Selects YEAR/ MONTH/ DAY/ HOUR / MINUTE/DATE TYPE

LEFT button : Moves the cursor to the [D & Time] main menu if the cursor is at the first item of the date and time setup. In all other instances, the cursor will be shifted to the left of its current position.

UP/ DOWN button : changes the value of each item.

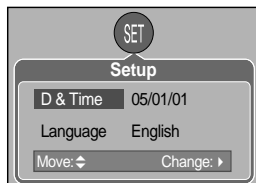

- Setting up the language

1. Select the [Language] menu by pressing the UP/DOWN button and press the RIGHT button.
2. Select the desired sub menu by pressing the UP/ DOWN button and press the OK button.

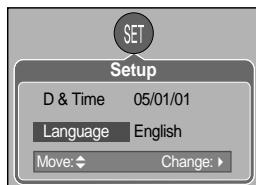

INFORMATION

- You can select 18 languages. These are listed below:
English, Korean, French, German, Spanish, Italian, S. Chinese, T. Chinese, Japanese, Russian, Portuguese, Dutch, Danish, Swedish, Finnish, Thai, BAHASA(MALAY/INDONESIAN) and Arabic.
- Even if the camera is restarted, the language setting will be maintained.

LCD monitor indicator

■ The LCD monitor displays information about the shooting functions and selections.

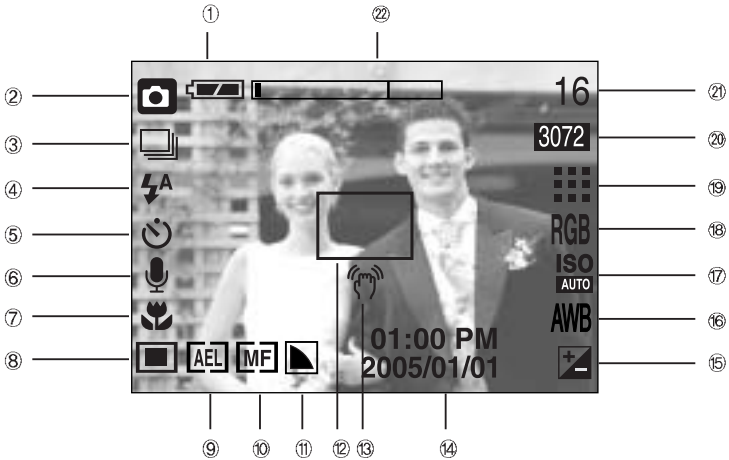

[Image & Full Status]

No.	Description	Icons	Page
1	Battery		p.16
2	Recording mode		p.11-12
3	Shooting type		p.52
4	Flash		p.34
5	Self-timer		p.37
6	Voice memo		p.32
7	Macro		p.33
8	Metering		p.51
9	AEL		p.43
10	Manual/ Continuous auto focus		p.44
11	Sharpness		p.53
12	Auto focus frame		
13	Camera shake warning		p.28
14	Date/ Time	2005/01/01 01:00 PM	

LCD monitor indicator

15	Exposure compensation		p.42
16	White Balance	AWB	p.41
17	ISO	ISO AUTO ISO 50 ISO 100 ISO 200 ISO 400	p.41
18	RGB	RGB	p.40
19	Image quality	TIFF	p.50
20	Image size	3072, 2816, 2592, 2272, 2048, 1600, 1024, 640	p.49
21	Number of available shots remaining	16	
	Remaining time (Movie clip/ Voice recording)	00:01:30/ 01:00:00	
22	Optical/ Digital Zoom bar		

Starting the recording mode

■ How to use the AUTO mode (**AUTO**)

1. Insert the batteries (p.16). Insert the batteries taking note of the polarity (+ / -).
2. Insert the memory card. (p.19)
3. Close the battery chamber cover.
4. Press the power button to turn on the camera.
(If the date/time that is displayed on the LCD monitor is incorrect, reset the date/time before taking a picture.)
5. Select the AUTO mode by rotating the mode dial.
6. Point the camera towards the subject and compose the image by using either the viewfinder or LCD monitor.
7. Press the shutter button to capture an image.

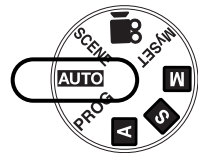

[AUTO mode]

INFORMATION

- If the auto focus frame turns to red when you press the shutter button down half way, it means that the camera cannot focus on the subject. Should this be the case, the camera is unable to capture an image clearly.

Starting the recording mode

■ How to use the PROGRAM mode (**PROG**)

- Selecting the automatic mode will configure the camera with optimal settings. You can still manually configure all functions except the aperture value and shutter speed. Steps from 1-4 are the same as those for AUTO mode.
5. Select the PROGRAM mode by rotating the mode dial.
 6. Press the menu button to configure advanced functions such as image size (p.49), quality (p.50), metering (p.51), continuous shooting (p.52), picture effects (p.53) and special effects (p.54).
 7. Point the camera towards the subject and compose the image by using either the viewfinder or LCD monitor.
 8. Press the shutter button to capture an image.

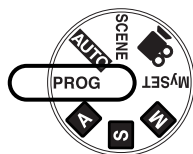

[PROGRAM mode]

■ How to use the APERTURE PRIORITY mode (**A**)

- Steps from 1-4 are the same as those for AUTO mode.
5. Select the APERTURE PRIORITY mode by rotating the mode dial.
 6. Select the desired aperture value by rotating the jog dial.
 7. Point the camera towards the subject and compose the image by using either the viewfinder or LCD monitor.
 8. Press the shutter button to capture an image.
- * Smaller Aperture values make the object sharp but blur the background. Larger Aperture values make both the object and background sharp.

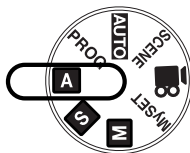

[Aperture priority mode]

Starting the recording mode

■ How to use the SHUTTER PRIORITY mode (**S**)

Steps from 1-4 are the same as those for AUTO mode.

5. Select the SHUTTER PRIORITY mode by rotating the mode dial.
6. Select the desired shutter speed by rotating the jog dial.
7. Point the camera towards the subject and compose the image by using either the viewfinder or LCD monitor.
8. Press the shutter button to capture an image.

* High Shutter speeds can capture a moving object in a still image as if the object is not moving. Low Shutter speeds can capture a moving object with an 'active' effect.

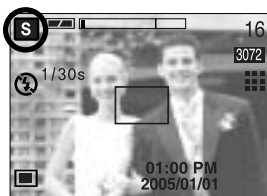
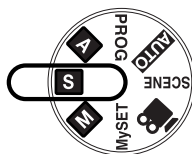

[Shutter Priority mode]

■ How to use the MANUAL mode (**M**)

Steps from 1-4 are the same as those for AUTO mode.

5. Select the MANUAL mode by rotating the mode dial.
6. Press the ASM button to select the shutter speed or the aperture value. Then select the desired shutter speed or aperture value by rotating the jog dial.
7. Point the camera towards the subject and compose the image by using either the viewfinder or LCD monitor.
8. Press the shutter button to capture an image.

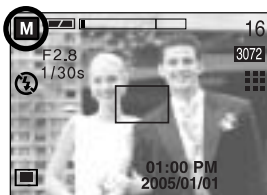
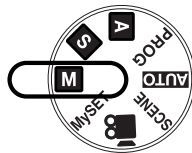

[Manual mode]

Starting the recording mode

■ How to use the MySET mode (MySET)

This mode allows users to save frequently used shooting settings for later use.

Steps from 1-4 are the same as those for AUTO mode.

5. Select the MySET mode by rotating the mode dial.
6. Press the menu button.
7. Use the Left/Right buttons to select the [Load Myset] menu tap. Use the Up/Down buttons to select desired MySET number.
8. Press the OK button to load the camera configuration saved in the MySET number and close the menu screen.
9. Point the camera towards the subject and compose the image by using either the viewfinder or LCD monitor.
10. Press the shutter button to capture an image.

Please see page 57 for details of the MySET shooting mode and menus.

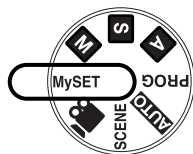

[MySET mode]

■ How to use the MOVIE CLIP mode ()

Steps from 1-4 are the same as those for AUTO mode.

5. Select the MOVIE CLIP mode by rotating the mode dial.
6. The MOVIE CLIP mode icon and available recording time will display on the LCD monitor.
7. Point the camera towards the subject and compose the image by using either the viewfinder or LCD monitor. Press the shutter button and movie clips are recorded for as long as the available recording time. Movie clips will still be recorded if the shutter button is released.

* If you wish to stop recording, press the shutter button again.

* Image size and type are listed below.

- Image size : 640X480, 320X240,
160X128(Selectable)
- File type : *.avi(MPEG-4)

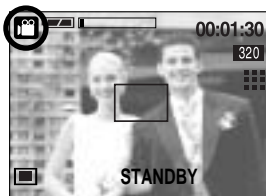
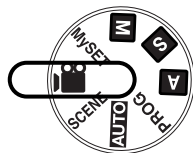

[MOVIE CLIP mode]

Starting the recording mode

■ Pausing while recording a movie clip (Successive Recording)

This camera allows you to temporarily stop during unwanted scenes, while recording a movie clip. Using this function, you can record your favourite scenes into a movie clip without having to create multiple movie clips.

● Using Successive Recording

Steps from 1-6 are the same as those for MOVIE CLIP mode.

7. Point the camera towards the subject and compose the image by using the viewfinder or LCD monitor. Press the shutter button and movie clips are recorded for as long as the available recording time. Movie clips will still be recorded if the shutter button is released.

8. Press the Pause button() to pause recording.

9. Press the Pause button() again to resume the recording.

10. If you wish to stop recording, press the shutter button again.



[Successive recording of a movie clip]

Starting the recording mode

■ How to use the SCENE mode (**SCENE**)

Use the menu to easily configure optimal settings for a variety of shooting situations. These include NIGHT, PORTRAIT, CHILDREN, LANDSCAPE, CLOSE UP, TEXT RECOGNITION, SUNSET, DAWN, BACKLIGHT, FIREWORKS and BEACH & SNOW scenes.

Steps from 1-4 are the same as those for AUTO mode.

5. Select the SCENE mode by rotating the mode dial.
6. Press the menu button and select the [Scene] menu by pressing the left and right button.
7. Select the desired [Scene] sub menu by pressing the UP and DOWN buttons and press the OK button. Please see page 58 for detailed descriptions for each screen.
8. The current scene icon is displayed at the top left of the LCD.
9. Point the camera towards the subject and compose the image by using either the viewfinder or LCD monitor.
10. Press the shutter button to capture an image.

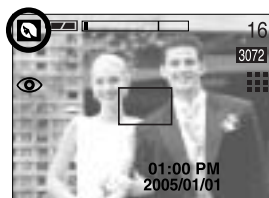
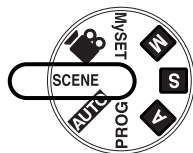

[SCENE mode]

■ How to use the VOICE RECORDING mode (**VO**)

1. Select the VOICE RECORDING mode by pressing the Voice recording button twice. (In Movie clip mode, press the Voice recording button once to select the VOICE RECORDING mode)
 2. Press the shutter button to record a voice.
 - Press the shutter button once and voice is recorded for as long as the available recording time (Max : 1 hour) allows. The recording time will be displayed on the LCD monitor. Voice will still be recorded if the shutter button is released.
 - If you wish to stop recording, press the shutter button again.
 - File type : *.wav
- * A distance of 40cm between you and the camera (microphone) is the best distance to record sound.

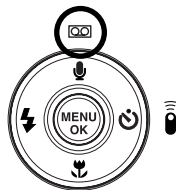

[VOICE RECORDING mode]

Things to Watch Out for When Taking Pictures

- Pressing the shutter button down half way.

Lightly press the shutter button to confirm focus and flash battery charge.

Press the shutter button all way down to take the picture.

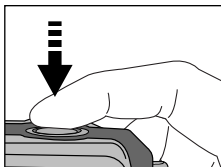

[Lightly press the shutter button]

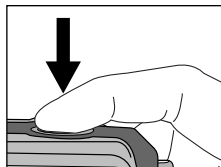

[Press the shutter button]

- The available recording time may vary depending on shooting conditions and camera settings.
- When the Flash Off or Slow synchro mode is selected in a low lighting condition, the camera shake warning indicator () may appear on the LCD monitor. In this case, use a tripod, support the camera on a solid surface or change the flash mode to flash shot mode.
- Compensated shooting against the light :
Please do not take pictures to the sunlight direction. Taking a picture against the sun may make the picture dark. To take a picture against the sun, please use the [Backlight] in the scene shooting mode (see page 58), fill-in flash (see page 36), spot metering(see page 51), or exposure compensation (see page 42).
- Avoid obstructing the lens or the flash when you capture an image.
- As there can be some differences between what is seen through the Viewfinder and the resulting image when taken at a range closer than 1.5m, it is recommended that you use the LCD monitor to compose these shots.
- Using the LCD monitor extensively will drain the batteries.
We recommend turning off the LCD monitor and using the optical viewfinder as often as possible in order to extend battery life.
- Under certain conditions the auto focus system may not perform as expected.
 - When photographing a subject that has little contrast.
 - If the subject is highly reflective or shiny.
 - If the subject is moving at high speed.
 - When there is strong reflected light, or when the background is very bright.
 - When the subject matter has only horizontal lines or the subject is very narrow (such as a stick or flagpole).
 - When the surroundings are dark.

Using the camera buttons to adjust the camera

- The RECORDING (AUTO, PROGRAM, APERTURE PRIORITY, SHUTTER PRIORITY, MANUAL, MySET, MOVIE CLIP, SCENE) mode function can be set up by using the camera buttons.

POWER button

- Used for turning the camera's power on / off.
- If there is no operation during the specified time, the camera's power will be turned off automatically to save battery life. Refer to page 90 for more information about the auto power off function.
- Pressing the power button for over 3 seconds will deactivate the start-up sound and sound function.

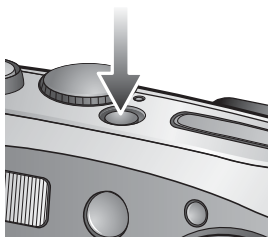

SHUTTER button/ Jog dial

- Used for taking an image or recording voice in the RECORDING mode.
- In MOVIE CLIP mode :
Pressing the shutter button down fully starts the process for recording a movie clip. Press the shutter button once and the movie clip is recorded for as long as the available recording time in the memory allows. If you wish to stop recording, press the shutter button again.
- In STILL IMAGE mode
Pressing the shutter button down halfway activates the autofocus and checks the condition of the flash. Pressing the shutter button down fully takes the image and stores the relevant data regarding the shot. If you select voice memo recording, the recording will start after the camera has finished storing the image data.
- Jog dial : Set focus distance while using the manual focusing (see page 44).
Set the aperture value and shutter speed in the A/S/M shooting mode (see page 43).

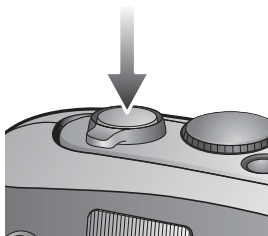

ZOOM W/T button

- If the menu is not displayed, this button works as the OPTICAL ZOOM or DIGITAL ZOOM button.



ZOOM W/T button

- This camera has a 3X optical zoom and a 10X digital zoom function. Using both will offer a total zoom ratio of 30X.

● TELE Zoom

Optical zoom TELE

: Pressing the ZOOM T button. This will zoom into the subject i.e. the subject will appear nearer.

Digital zoom TELE

: When the maximum (3X) optical zoom is selected, pressing the ZOOM T button activates the digital zoom software. Releasing ZOOM T button stops the digital zooming at the required setting. Once the maximum digital zoom (10X) is achieved, pressing the ZOOM T button will have no effect.

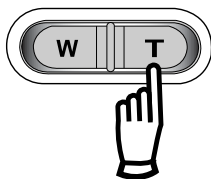

● WIDE Zoom

Optical zoom WIDE

: Pressing the ZOOM W button. This will zoom out from the subject i.e. the subject will appear further away. Pressing the ZOOM W button continuously will set the camera to its minimum zoom setting i.e. the subject appears at its furthest from the camera.

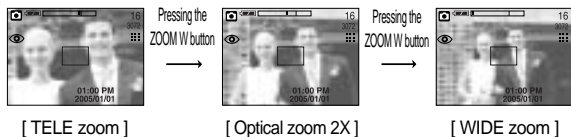
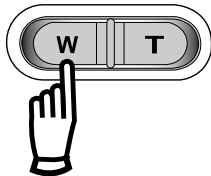

Digital zoom WIDE

: When the digital zoom is in operation, pressing the ZOOM W button will reduce the digital zooming in steps. Releasing ZOOM W button stops digital zooming. Pressing the ZOOM W button will reduce the digital zoom and then it will continue to reduce the optical zoom until the minimum setting is reached.

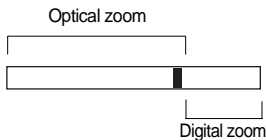

ZOOM W/T button

INFORMATION

- To use the digital zoom the LCD monitor has to be turned on.
- Images taken using the digital zoom may take a little longer for the camera to process. Allow time for this to take place.
- The digital zoom cannot be used in movie clip shots.
- If the movie clip is being recorded, the zoom operation cannot be activated.
- You may notice a decrease in image quality when using the digital zoom.
- To view more clear digital zoom image, press the shutter button halfway at the maximum (3X) optical zoom position and press the zoom T button again.
- The digital zoom can't be activated in the [Night], [Children], [Close up], [Text] and [Fireworks] scene modes.
- Take care not to touch the lens to avoid taking an unclear image and possibly causing camera malfunction. If the image is dim, turn the camera power off and on again to modify the lens position.
- Take care not to press the lens as this may cause a camera malfunction.
- When the camera is turned on, take care not to touch the camera's moving lens parts as this may cause the resulting image to be dim and unclear.
- Take care not to touch the lens during zoom operation as this may cause damage.

Voice memo(🎤) / UP button

- While the menu is showing, press the UP button to move up the submenu cursor.
 - When the menu is not displayed on the LCD monitor, the UP button operates as the voice memo (🎤) button. You can add your voice-over to a stored still image.
- Recording a voice memo
1. Rotate the MODE DIAL to select a RECORDING mode with the exception of MOVIE CLIP mode.
 2. Press the VOICE MEMO (🎤) button. If the voice memo indicator is displayed on the LCD monitor, the setting is completed.

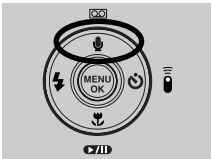

[Preparing for Voice Memo]



[Recording Voice Memo]

3. Press the shutter button and take a picture. The picture is stored on the memory card.
4. Voice memo will be recorded for ten seconds from the moment the picture is stored.
In the middle of the sound recording, pressing the shutter button will stop the voice memo.

INFORMATION

- A distance of 40cm between you and the camera (microphone) is the best distance to record sound.

Macro() / Down button (Focusing)

- While the menu is showing, press the DOWN button to move from the main menu to a submenu, or to move down the submenu cursor.
- When the menu is not showing, you can use the MACRO/ DOWN button to take macro pictures (within the distance range of 4-80 cm).

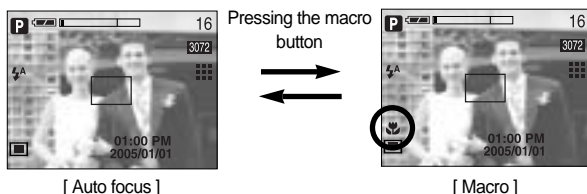

● Types of focus modes and focus ranges

Unit : cm

Focus type	Auto		Macro		Auto macro	
	WIDE	TELE	WIDE	TELE	WIDE	TELE
Focus range	80 ~ ∞	80 ~ ∞	4 ~ 80	25 ~ 80	4 ~ ∞	25 ~ ∞

INFORMATION

- When the macro mode is selected, it is possible that camera shake will occur. If this is the case, use a tripod to eliminate this.
- When you take a picture within 20cm(MACRO focus), select the FLASH OFF mode.
- In the AUTO mode, the Auto macro will be selected by pressing the macro button.

- Available focusing method, by recording mode
(O:Selectable, X:Not selectable, ∞:Infinity focus range)

Mode		P	A	S	M	My				
Auto	O	O	O	O	O	O	O	O		
Macro	X	O	O	O	O	O	O	X		
Auto macro	O	X	X	X	X	X	X	X		
Mode					T					
Auto	O	O	∞	X	X	∞	∞	O	∞	O
Macro	X	X	X	O	O	X	X	X	X	X
Auto macro	X	X	X	X	X	X	X	X	X	X

Focus lock

- To focus on the subject positioned outside of the centre, use the focus lock function.
- Using the Focus Lock
 1. Ensure the subject in the centre of the autofocus frame.
 2. Press the SHUTTER button halfway. When the green auto lights up, it means the camera is focused on the subject. Be careful not to press the SHUTTER button all the way down to avoid taking an unwanted pictured.
 3. With the SHUTTER button still pressed down only halfway, move the camera to recompose your picture as desired, and then press the SHUTTER button completely to take the picture. If you release your finger from the SHUTTER button, the focus lock function will be cancelled.



1. The image to be captured

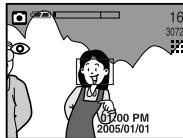

2. Press the SHUTTER button halfway and focus on the subject



3. Recompose the picture and fully depress the SHUTTER button

FLASH (⚡) / LEFT button

- When the menu is displayed on the LCD monitor, pressing the LEFT button makes the cursor shift to the left tab.
- When the menu is not displayed on the LCD monitor, the LEFT button operates as the FLASH (⚡) button.
- Selecting the flash mode
 1. Rotate the MODE DIAL to select a RECORDING mode with the exception of MOVIE CLIP and VOICE RECORDING modes.
 2. Press the Flash button until the desired flash mode indicator displays on the LCD monitor.
 3. A flash mode indicator will be displayed on the LCD monitor. Use the correct flash to suit the environment.

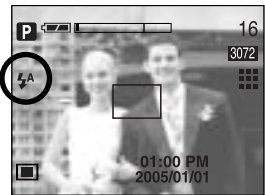

[Selecting the Auto flash]

FLASH(⚡) / LEFT button

- Flash range

Unit : m

ISO	AUTOFOCUS		MACRO		AUTO MACRO	
	WIDE	TELE	WIDE	TELE	WIDE	TELE
AUTO	0.8~3.0	0.8~2.0	0.2~0.8	0.25~0.8	0.2~3.0	0.25~2.0

INFORMATION

- Using the flash frequently will reduce the life of the batteries.
- Under normal operating conditions the charging time for the flash is normally within 7 seconds. If the batteries are weak, the charging time will be longer.
- During the continuous shot, movie clip mode, the flash function will not operate.
- Take photographs within the flash range.
- The image quality is not guaranteed if the subject is too close or highly reflective.

FLASH(⚡) / LEFT button

● Flash mode indicator

Icon	Flash mode	Description
	Auto flash	If the subject or background is dark, the camera flash will operate automatically.
	Auto & Red eye reduction	If a subject or background is dark, the camera flash will work automatically and will reduce the red-eye effect by using the red-eye reduction function.
	Fill in flash	The flash fires regardless of available light. The intensity of the flash will be controlled, according to the prevailing conditions. The brighter the background or subject is, the less intense the flash will be.
	Slow synchro	The flash will operate in conjunction with a slow shutter speed in order to obtain the correct exposure. We recommend using a tripod for this function. When you take an image in a condition with poor light, the camera shake warning indicator () will display on the LCD monitor.
	Flash off	The flash does not fire. Select this mode when capturing images in a place or situation where flash photography is prohibited. When you capture an image in a poorly lit condition, the camera shake warning indicator () will display on the LCD monitor.

● Available flash mode, by recording mode

	X	O	X	X	X	O	X	X	X	X	X	X	X	X	X	X	O
	O	O	X	X	X	O	X	O	O	X	X	X	X	X	X	X	X
	X	O	O	O	O	O	X	X	X	X	X	X	X	X	O	X	X
	X	O	O	X	X	O	O	X	X	X	X	X	X	X	X	X	X
	O	O	O	O	O	O	O	O	O	O	O	O	O	O	O	X	O

Self-timer (🕒) / Remote (📡) / Right button

- When the menu is displayed on the LCD monitor, pressing the Right button makes the cursor shift to the right tab. The right button can also be used to move to a sub menu to select a different setting.
 - When the menu is not displayed on the LCD monitor, the RIGHT button operates as the Self-timer (🕒) and Remote (📡) button. This function is used when the photographer would also like to be in the image.
- Using the self-timer and remote control.
1. Rotate the mode dial to the RECORDING mode.
 2. Press the SELF-TIMER button until the desired mode indicator displays on the LCD monitor. A self-timer icon or remote control icon appears on the LCD monitor.



[Selecting the 2 SEC self-timer]

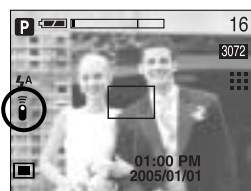

[Selecting the remote control]

- Selecting a self-timer : When you press the SHUTTER button, the picture will be taken after the specified time has elapsed and the self-timer function will be canceled.
- Selecting a remote mode : Pressing the shutter button of remote control will allow an interval of 2 seconds before the image is taken. In the remote mode, the shutter button of the camera can't be activated. After taking a picture, the remote mode will be maintained. But, pressing the power button, rotating the mode dial, pressing the play mode button and pressing the self-timer button will cancel the remote mode.

● Description of Self-timer/Remote mode

Icon	Mode	Description
🕒 ^{2S}	2s	Pressing the shutter button will allow an interval of 2 seconds before the image is taken.
🕒	10s	Pressing the shutter button will allow an interval of 10 seconds before the image is taken.
🕒 ²	Double	A picture will be taken after about 10 seconds and 2 seconds later a second picture will be taken.
📡	Remote mode	You can take a picture by remote control instead of using the shutter button of the camera.

Self-timer(☺) / Remote (📶) / Right button

● Self-timer/ remote mode setting

Mode dial	Setting ( marked camera working mode is the default setting.)
AUTO	Off → 2s self-timer → 10s self-timer → Double self-timer → Remote
PROGRAM	
A/S/M, MySET	
SCENE	
MOVIE CLIP	Off → 10s self-timer → Remote

INFORMATION

- When taking a picture using the self-timer, the self-timer lamp works as follows:
 - 2 second self-timer setting : The self-timer lamp blinks at 0.25 second interval for 2 seconds.
 - 10 second self-timer setting : The self-timer lamp blinks at 1 second interval for the first 8 seconds. It blinks at 0.25 second interval for the remaining 2 seconds.
- If you operate the Mode dial and Self-timer button during the self-timer operation, the self-timer function is canceled.
- Use a tripod to prevent the camera from shaking.
- In Movie Clip mode, only the 10s self-timer and remote will work.

● Remote control range

When you take a picture by using the remote control, refer to the illustrations shown alongside about the remote control range.

[Shutter button on the remote control]

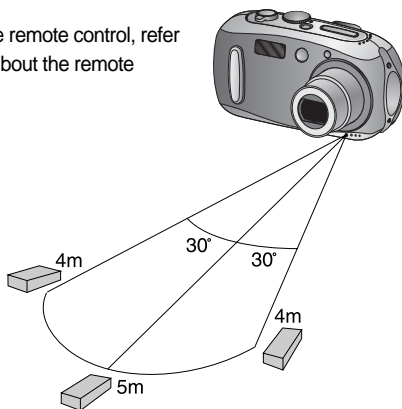
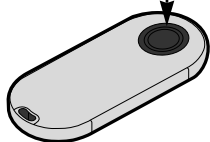

Self-timer(🕒) / Remote (📶) / Right button

● Replacing batteries for the remote control

Make sure the + polarity is toward the top and the - polarity is toward the bottom while installing batteries for the remote control. Replace batteries for the remote control in the local service centre. Use the CR 2025 3V batteries.

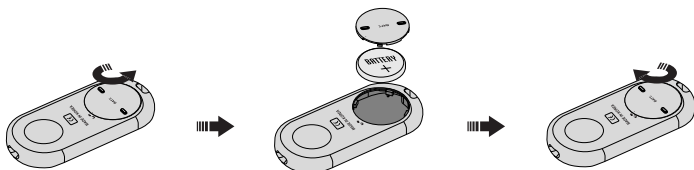

MENU/ OK button

- If the menu is displayed, use the 5-Function buttons to change the data values and for your changes to be accepted
- If the menu is not displayed, press the MENU/OK button to display a menu for the current camera mode on the LCD monitor. Press the button again to return to the previous state.

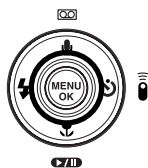

Pressing
the MENU
button

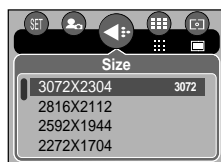



[Menu on]

- There is no menu for VOICE RECORDING mode.
- The menu screen may not show on the LCD when another button is pressed or image data is being processed. (The green lamp next to the view finder blinks)

+/- button

- You can use the +/- button to adjust the values for the RGB, ISO, white balance and exposure compensation.

Main menu	Sub menu	Available camera mode
RGB	R (Red), G (Green), B (Blue)	P A S M MySET  SCENE ()
ISO	AUTO, 50, 100, 200, 400	P A S M MySET
WHITE BALANCE	AUTO, DAYLIGHT, CLOUDY, FLUORESCENT H, FLUORESCENT L, TUNGSTEN, CUSTOM.	P A S M MySET 
Exposure compensation	-2.0~0.0~+2.0(1/3EV steps)	P A S MySET

- RGB : Allows the user to adjust the R (Red), G (Green), and B (Blue) values of the images to be captured.

● Setting RGB Values

1. Press the +/- button, and then use the UP and DOWN buttons to select the RGB icon ().
The RGB menu bar will appear as shown.
2. Use the UP/ DOWN/ LEFT and RIGHT buttons to select the desired RGB value.

- Up/Down Button: Navigates between R, G, and B icons.

- Left/Right Button: Changes value of each icon.

3. When you press the +/- button again, the value you set will be saved and RGB setup mode will end.

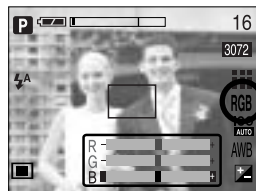

+/- button

- ISO: You can select the ISO sensitivity when taking pictures.

The speed or specific light-sensitivity of a camera is rated by ISO numbers.

- Selecting an ISO Sensitivity

1. Press the +/- button, and then use the UP and DOWN buttons to select the ISO icon (). The ISO menu bar will appear as shown.
2. Use the LEFT and RIGHT buttons to select the desired ISO sensitivity value.

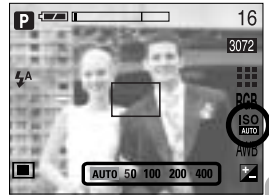







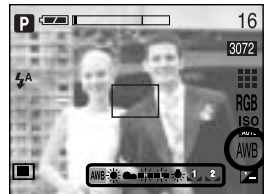

- AUTO : The camera's sensitivity is automatically changed by variables such as lighting value or subject brightness.
 - 50, 100, 200, 400 : You can increase the shutter speed while the same amount of light is present, by increasing the ISO sensitivity. However, the image may be saturated in high luminance. The higher the ISO value, the higher the camera's sensitivity to light is and therefore the greater its capacity to take pictures in dark conditions. However, the noise level in the image will increase as the ISO value increases, making the image appear coarse.
3. When you press the +/- button again, the value you set will be saved and ISO setup mode will end.

- White balance : The white balance control allows you to adjust the colours to appear more natural looking.

- Selecting a White Balance

1. Press the +/- button, and then use the UP and DOWN buttons to select the white balance icon (). The white balance menu bar will appear as shown.
2. Use the LEFT and RIGHT buttons to set the white balance to the desired value. The value you set will be displayed on the LCD monitor.



- AUTO  : The camera automatically selects the appropriate white balance settings, depending on the prevailing lighting conditions.
- DAYLIGHT  : For taking images outside.
- CLOUDY  : For taking images under a cloudy and overcast sky.
- Fluorescent H  : For shooting under daylight fluorescent types of three-way fluorescent lighting.
- Fluorescent L  : Shooting under white fluorescent lighting.
- TUNGSTEN  : For shooting under tungsten (standard light bulb) lighting.
- CUSTOM  : Allows the user to set the white balance according to the shooting condition.

Different lighting conditions may cause a colour cast on your images.

3. Press the +/- button again. The value you set will be saved and White Balance setup mode will end.

+/- button

● Using the Custom White Balance

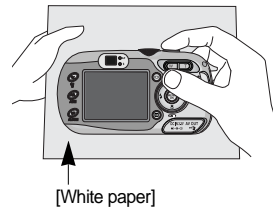
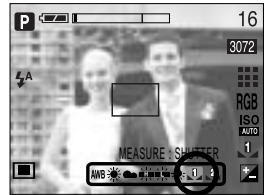

White balance settings may vary slightly depending on the shooting environment. You can select the most appropriate white balance setting for a given shooting environment by setting up the custom white balance.

1. Select the CUSTOM () menu of the White Balance. You can select CUSTOM 1 or CUSTOM 2 white balance.
2. Place a sheet of white paper in front of the camera so that the LCD monitor shows only white, and then press the SHUTTER button.
3. The value you set will be saved.
 - The custom white balance value will be applied, starting with the next picture you take.
 - The user configured white balance will remain effective until it is overwritten.



- Exposure compensation : This camera automatically adjusts the exposure according to the ambient lighting conditions. You can also select the exposure value by using the +/- button.

● Compensating Exposure

1. Press the +/- button, and then use the UP and DOWN buttons to select the exposure compensation icon (). The exposure compensation menu bar will appear as shown.
2. Use the LEFT and RIGHT buttons to set the desired exposure compensation factor.
3. Press the +/- button again. The value you set will be saved and the Exposure Compensation setup mode will close. If you change the exposure value, the exposure indicator () will be displayed on the bottom of the LCD monitor.
 - * A negative exposure compensation value reduces the exposure.
 - Note that a positive exposure compensation value increases the exposure and the LCD monitor will appear white or you may not get good pictures.

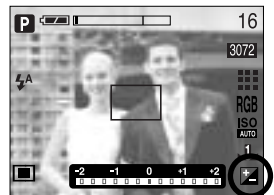

AEL/ASM button

■ The camera measures brightness of the object and automatically set the best exposure value. If difference between the exposure values of the object and background is too great, use the AEL button to manually set the exposure value against sunlight or in strong light. This button is available in the PROGRAM, Aperture priority(A), Shutter priority(S), MySET and MOVIE CLIP mode.

● Use the automatic exposure lock.

1. Ensure the subject in the centre of the autofocus frame.
2. Move the camera to point the automatic focus mark on the object of desired exposure.
3. Press the AEL button to lock the exposure and display the AEL icon in the bottom of the LCD.
4. Focus the camera again and press the shutter button again for shooting.



[Screen for shooting]



[Focus to the object and
press the AEL button]



[Refocus and fully press]
the shutter button]

■ You can use the ASM button to select the Aperture Value and Shutter speed in the Manual mode.

● Using the ASM button in the M mode

1. Rotate the MODE DIAL to select the M mode.
2. Press the ASM button and the aperture value and shutter speed are displayed. To select the aperture value or shutter speed, press the ASM button. The selected item is then highlighted in red.
3. Rotate the jog dial to select the aperture value and shutter speed. Press the SHUTTER button to take the picture.

※ In the Manual mode, the exposure information will be displayed by pressing the shutter button down halfway. ()

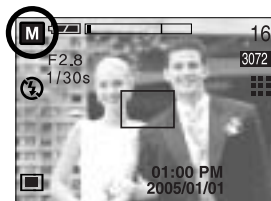

MF button

Use this button to select the focusing method.

- **Automatic focusing** : Slightly press the shutter to let the camera measure distance to the object and select the best focusing.
If successfully focused with the slight press of the shutter, the automatic focusing mark is turned green.
- **Manual focusing** : Where the automatic focusing is not available, for example, in very dark conditions, use the manual focus. Please be careful when using the manual focus as the picture can be blurred easily.
- **Manual focusing.**

1. Press the MF button to display the MF bar.
The MF icon is displayed in the bottom of the LCD.



2. Use the jog dial to set the focus distance.
Turn to the left : Move the focus farther.
Turn to the right : Move the focus closer.

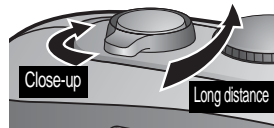

INFORMATION

- Focus distance of 0.04–0.25m are only supported in the Wide zoom. If you take a picture within 0.2m, select the Flash off mode as the flash range is 0.2m or farther.
- The focus value displayed in the LCD while manually focusing is measured from the end of the lens

LCD() button

- You can check the recording status in the LCD monitor. In any mode with the exception of VOICE RECORDING mode, pressing the LCD button will change the display as shown below.

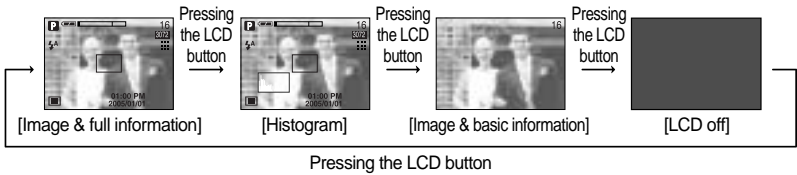

■ Histogram

Shows you the distribution of brightness in recorded images. If the bars in the histogram are higher towards the right, the image may be too bright. If the bars are higher on the left, the image may be too dark. If the lighting conditions are too bright to check the subject by using the LCD monitor, checking the histogram will enable more precise exposure control for the shots.

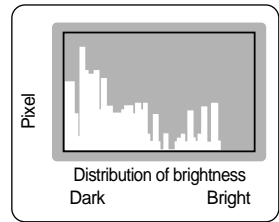

- If the LCD monitor is turned off, the mode dial lamp will light up.

Using the LCD monitor to adjust the camera settings











- You can use the menu on the LCD monitor to set up recording functions. In any mode with the exception of VOICE RECORDING mode, pressing the MENU button displays the menu on the LCD monitor.

INFORMATION















- The menu will not be displayed on the LCD monitor in the following circumstances:
 - When another button is being operated.
 - While image data is being processed.
(when the green lamp next to the viewfinder blinks)
 - When there is no battery capacity.

- The following functions are available, depending on the mode you have selected.





The items indicated by are default settings.

Menu tab	Main menu	Sub menu	Camera working mode	Page		
	Size	3072X2304	      SCENE	p.49		
		2816X2112				
		2592X1944				
		2272X1704				
		2048X1536				
		1600X1200				
		1024X768				
		640X480				
		640X480				p.49
		320X240				
160x128						
	Frame Rate	30 FPS		p.50		
		15 FPS				

Using the LCD monitor to adjust the camera settings

Menu tab	Main menu	Sub menu	Camera working mode	Page	
	Quality	TIFF		p.50	
		S. Fine			
		Fine			
		Normal			
	Metering	Multi		p.51	
		Spot			
	Shooting	Single		p.52	
		Continuous			
		AEB			
		AFB			
	Sharpness	Soft		p.53	
		Normal			
		Vivid			
	Effect	Normal		p.53	
		B & W			
		Sepia			
		Negative			
	Special Effect	HighLight	Off		p.54
			Range 1		
			Range 2		
			Range 3		
		Composite	Off		p.55
			2 Parts		
			3 Parts		
			4 Parts		
		Photo Frame	Off		p.56
			Frame1		
			Frame2		
			Frame3		

Using the LCD monitor to adjust the camera settings

Menu tab	Main menu	Sub menu	Camera working mode	Page
	Save Myset	Myset1	P A S M	p.57
		Myset2		
		Myset3		
	Load Myset	Myset1	My	p.57
		Myset2		
		Myset3		
	Scene	Night, Portrait, Children, Landscape, Close up, Text, Sunset, Dawn, Backlight, Firework, Beach&Snow	SCENE	p.58
	Stabilizer	Off		p.59
		On		

* Menus are subject to change without prior notice.

How to use the menu

1. Turn on the camera and press the MENU button. A menu for each camera mode appears. However, there is no menu for Voice Recording mode ().
2. Use the LEFT and RIGHT buttons to navigate through the menus.

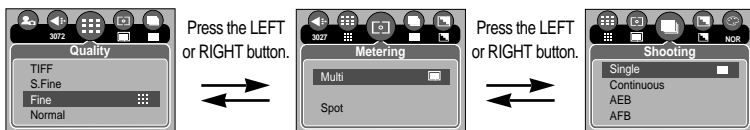

3. Use the UP and DOWN buttons to select a sub menu.

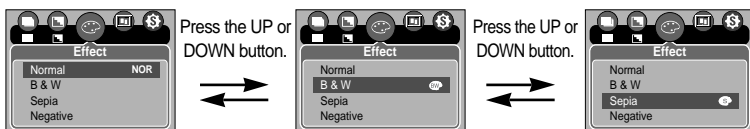

4. Select a sub menu, and then press the OK button. The value you set will be saved and the menu will disappear.

Size

- You can select the image size appropriate for your application.

Mode	STILL IMAGE mode								MOVIE CLIP mode		
Icon	3072	2816	2592	2272	2048	1600	1024	640	640	320	160
Size	3072X2304	2816X2112	2592X1944	2272X1704	2048X1536	1600X1200	1024X768	640X480	640X480	320X240	160X128

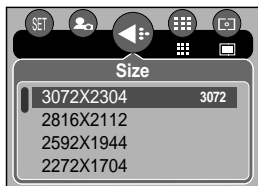

[PROGRAM mode]

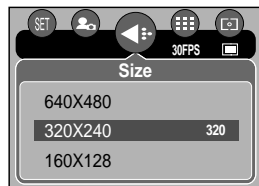

[MOVIE CLIP mode]

INFORMATION

- The higher the resolution, the lower the number of available shots will be because high resolution images require more memory than lower resolution images.

Quality

- You can select the compression ratio appropriate for your application of the captured images. The higher the compression ratio, the lower the picture quality.

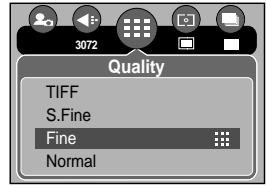

[PROGRAM mode]

Mode	STILL IMAGE mode				MOVIE CLIP mode	
Icon	TIFF					
Sub menu	TIFF	S. Fine	Fine	Normal	30FPS	15FPS
File Format	tif	jpeg	jpeg	jpeg	avi	avi

INFORMATION

- TIFF is the highest quality and Normal is the lowest setting.
Choose the setting appropriate for your needs.
- The TIFF file format is for professionals and provides the best quality.
However, large file size reduces number of available pictures to take and increases saving time to the memory card.
- [Please Wait !] message is displayed while saving a TIFF file to the memory card.
- If you select the TIFF file format, the double self-timer can't be selected.
- This file format complies with the DCF(Design rule for Camera File system).
- JPEG (Joint Photographic Experts Group): JPEG is the image compression standard developed by the Joint Photographic Experts Group. This type of compression is most commonly used for compressing photos and graphics because it can compress the files efficiently without damaging the data.

Metering

- If you cannot obtain suitable exposure conditions, you can change the metering method to take brighter pictures.

Multi () : Exposure will be calculated based on an average of the available light in the image area.
However, the calculation will be biased towards the centre of the image area.
This is suitable for general use.

Spot () : Only the rectangular area in the centre of the LCD monitor will be metered for light. This is suitable when the subject in the centre is exposed correctly, regardless of the back lighting.

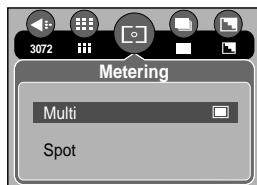

[PROGRAM mode]

Continuous shot

- You can select continuous shot, AEB (Auto Exposure Bracketing) and AFB (Auto Focus Bracketing). If you select CONTINUOUS, AEB or AFB, the flash will automatically be set to Flash Off.

[Single]: Take one picture only

[Continuous]: Images will be taken continuously until the shutter button is released. The shooting capacity depends on the memory.



[PROGRAM mode]

[AEB]: You can select the exposure bracket range ($\pm 0.3\text{EV}$ step, 6 steps) by rotating the jog dial. Three pictures are taken in a series in different exposure value. Use this menu if it is hard to decide exposure of the object.



[AFB]: You can select the focus bracket range (± 1 step, 3 steps) by rotating the jog dial. Three pictures are taken in a series in different focus range. Use this menu if it is hard to decide distance of the object.



INFORMATION

- If less than 3 pictures are available in the memory, the Sequential and the AEB, AFB shooting are not available.
- If you select 3072X2304 or 2816X2112 image size, the maximum numbers of continuous shot are 3.
- It is best to use a triangular support for the AEB shooting for saving time is long and hand shaking may occur.
- If the [TIFF] or [S. Fine] quality is selected and the [Shooting] sub menu is changed to [Continuous], [AEB] or [AFB], the image quality is changed to the [Fine] sub menu automatically.
- The self-timer can't be activated during the continuous shooting.

Sharpness

- You can adjust the sharpness of the picture you want to take. You cannot check the sharpness effect on the LCD monitor before you take a picture, because this function is applied only when the captured image is stored on the memory.

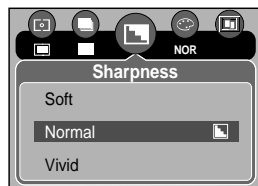

[PROGRAM mode]

Sub menu	Icon	Description
Soft		The edges of the image are softened. This effect is suitable for editing images on your PC.
Normal		The edges of the image are sharp. This is suitable for printing.
Vivid		The edges of the image are emphasized. The edges will appear sharp, but noise may occur in the recorded image.

Effect

- By using the camera's digital processor, it is possible to add special effects to your images.

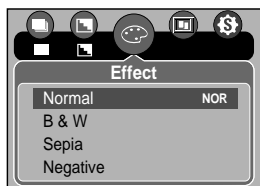

[PROGRAM mode]

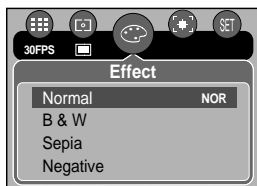

[MOVIE CLIP mode]

- Normal : No effect is added to the image.
- B & W : Converts the image to black and white.
- Sepia : Captured images will be stored in a sepia tone (a gradient of yellowish brown colours).
- Negative : Save the image in negative mode.

Special Effect

- By using the camera's digital processor, it is possible to add special effects to your images. You can select this menu only in the PROGRAM, MySET, Aperture priority, Shutter priority and MANUAL modes.
- You can select this menu only in the 2592x1944, 2272x1704, 2048x1536, 1600x1200, 1024x768, 640x480 image size. If the [3072X2304] or [2816X2112] image size is selected and one of the special effect menu is selected, the image size is changed to the [2592X1944] automatically.
- You can select the preset focus frame, Composite shots and Photo frame function. If a special effect is selected, the rest special functions set before are cancelled automatically.
- Even if the camera is turned off, the special effect setting will be preserved. To cancel the special effect, select the [Off] sub menu of each menu.
- If you select the [TIFF] image size and select the [Special Effect] menu, the image size will be changed to the [S.Fine] image size automatically.
- If you select a special effect menu and select [Continuous], [AEB] or [AFB] menu, the special effect menu will be cancelled automatically.

Special Effect : Preset focus frames

- You can make the subject stand out from its surroundings. The subject will be sharp and in focus while making the rest out of focus.

1. Select the PROGRAM, MySET, Aperture priority, Shutter priority or MANUAL modes. Then press the menu button.
2. Press the LEFT/ RIGHT button and select the [Special Effect] menu tab.
3. Select the [Highlight] menu by pressing the UP/ DOWN button and press the Right button.
4. Select a desired sub menu by pressing the UP/ DOWN button and press the OK button.
 - [Off] : The preset focus frame will not be added.

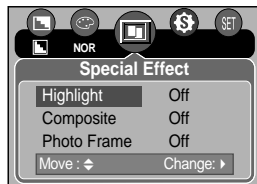

[Range 1]

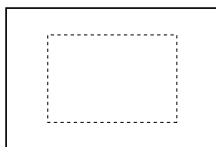

[Range 2]

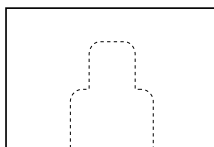

[Range 3]

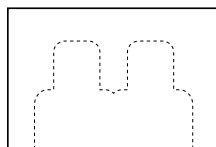

5. Press the menu button twice and the menu will disappear. If you select the [Range 1~3] menu, the preset focus frame area will appear.



Special Effect : Composite shots

■ You can combine 2–4 different shots in a still image.

1. Select the PROGRAM, MySET, Aperture priority, Shutter priority or MANUAL modes. Then press the menu button.
2. Press the LEFT/ RIGHT button and select the [Special Effect] menu tab.
3. Select the [Composite] menu by pressing the UP/ DOWN button and press the Right button.
4. Select a desired sub menu by pressing the UP/ DOWN button and press the OK button.
 - [Off] : cancels the composite shots
 - [2 Parts] : 2 different shots are combined in a still image.
 - [3 Parts] : 3 different shots are combined in a still image.
 - [4 Parts] : 4 different shots are combined in a still image.
5. Press the menu button twice and the menu will disappear.
6. The number of frames you selected in step 4 is displayed on the LCD monitor. Press the shutter button to start the composite shots.

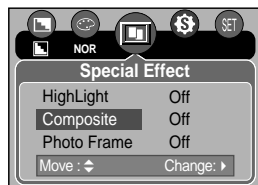

※ Selecting 2 composite shots



INFORMATION

- You can use the flash button, self-timer button, macro button, voice memo button, +/- button and the Zoom W/T button during the composite shots.
- If you change the image size, press the camera buttons (Play mode button, Voice recording (Pressing the UP button twice)) or rotate the mode dial during the composite shots, the captured images aren't saved and the first step of the composite shot will display on the LCD monitor. Do not press the camera buttons or rotate the mode dial during the composite shots.
- The voice memo will start after taking the last composite shot.

Special Effect : Photo Frame

■ You can add 3 types of frame-like borders to a still image you want to capture.

1. Select the PROGRAM, MySET, Aperture priority, Shutter priority or MANUAL modes. Then press the menu button.
2. Press the LEFT/ RIGHT button and select the [Special Effect] menu tab.
3. Select the [Photo Frame] menu by pressing the UP/ DOWN button and press the Right button.
4. Select a desired sub menu by pressing the UP/ DOWN button and press the OK button.
 - [Off] : The photo frame will not be added.

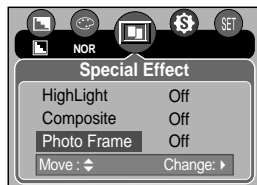

[Frame 1]

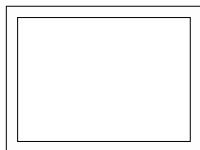

[Frame 2]



[Frame 3]



5. Press the menu button twice and the menu will disappear. If you select the [Frame 1~3] menu, the preset focus frame area will appear.



Save / Load a specific camera configuration (MySET)

- Use the MySET mode to save frequently used camera settings (Save Myset) and use it later (Load Myset)

- Saving the camera configuration : Available in the PROGRAM, A, S and M shooting mode.

1. Use the camera buttons and menu to set desired camera configuration.
2. Press the menu button in any mode except AUTO, VOICE RECORDING, MOVIE CLIP, SCENE and MySET mode.
3. Press the Left/Right buttons to select the [Save Myset] menu tap.
4. Press the Up/Down buttons to select desired MySET slot number to save.
5. Press the OK button to save the current configuration in the selected MySET slot and close the menu.

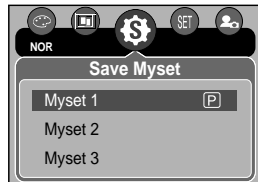

[PROGRAM mode]

- Loading the saved camera configuration: available in the MySET shooting mode.

1. Turn the mode dial to select the MySET shooting mode and press the menu button.
2. Press the Left/Right buttons to select the [Load Myset] menu tap.
3. Press the Up/Down buttons to select a MySET slot number to load.
4. Press the OK button to set the camera configuration as saved in the MySET slot.

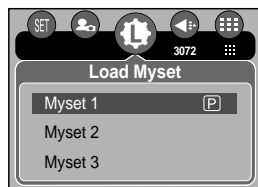

[MySET mode]

* The current MySET slot number is displayed in the top left of the LCD.

INFORMATION

- Saving is available for the following camera functions.

Functions using the camera buttons - Macro, flash, white balance, ISO, RGB, Exposure value, Aperture value and Shutter speed.

Functions using the menu screen - Size, quality, metering, effect, sharpness and continuous shot.

Scene

- Select the [Scene] submenu to automatically configure optimal settings, depending on the selected scene. Only available in the SCENE Mode.

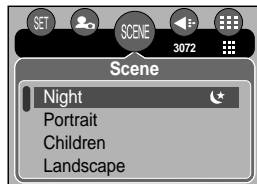

[SCENE mode]

Sub menu	Icon	Description
Night		Use this for shooting still images at night or in other dark conditions.
Portrait		To take a picture of a person
Children		To take a still picture of moving children
Landscape		Scenery with green woods or blue sky
Close up		Close-up shooting for small objects such as plants and insects
Text		Use this mode to shoot a document
Sunset		For taking pictures of sunsets
Dawn		Daybreak scenes
Backlight		Portrait without shadows caused by backlight
Firework		Firework scenes
Beach&Snow		For ocean, lake, beach and snowscape scenes

INFORMATION

- When the close-up, sunset, dawn, fireworks are selected, it is possible that camera shake will occur. If this is the case, use a tripod to eliminate this.
- In the [Children] and [Close up] scene mode, the Continuous Automatic Focusing (CAF) function will be activated and the CAF icon is displayed at the bottom of the LCD monitor.
- Continuous automatic focusing : The camera keeps focusing while the object is moving even if the shutter button is not slightly pressed. Note that using the Continuous automatic focusing uses more battery than the Automatic focusing does.

Movie Clip frame stabiliser

- This function helps stabilise images captured during movie recording.
You can select this menu only in the MOVIE CLIP mode.

- How to use this function

1. Select the MOVIE CLIP mode by rotating the mode dial and press the menu button. Select the [Stabilizer] menu and press the right button.
2. Select a desired sub menu by pressing the Up/Down button and press the OK button.

[Off] : Movie clip frame stabilizer function becomes disabled.

[On] : Prevents camera shake during movie recording.

The recording frame range will become narrower than when you select the [Off] menu. Pre-view frames may not display smoothly on the LCD monitor, but stored movie clips have no problems.

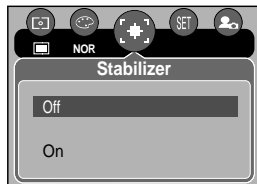

INFORMATION

- When you select the [On] sub menu, the movie clip frame range will be narrow depending on the movie clip size.

Starting play mode

- Turn the camera on and select Play mode by pressing the play mode button ().
The camera can now play back the images stored in the memory.
- If you have turned on the camera by pressing the POWER button, you can press the PLAY MODE button once to switch to Play mode and press it again to switch to Recording mode.
- You can turn the power on with the play mode button. The camera is turned on in play mode. Press the play mode button again to turn off the camera. Switch the mode dial to change to another shooting mode while the camera is on.
- You can set up the PLAY mode function by using the camera buttons and LCD monitor.
- If you press the PLAY button to switch to Play mode, the camera lens will retract into the camera body for protection of the lens after about 10 seconds.

● Playing back a still image

1. Select the PLAY mode by pressing the play mode button ().



2. The last image stored on the memory is displayed on the LCD monitor.



3. Select an image that you want to view by pressing the LEFT / RIGHT button.

※ Press and hold the LEFT or RIGHT button to play back the images quickly.



INFORMATION

- Manner mode : Pressing the play mode button for more than 3 seconds changes the buzzer and start-up sound setting to OFF.
- Even if the camera's power is off, you can start the play mode by pressing the play mode button.

Starting play mode

■ Playing back a movie clip

Steps from 1-2 are the same as those to play back a still image.

3. Select the recorded movie clip that you want to play back by using the LEFT/RIGHT button. If you select a movie clip, the movie clip indicator () will be displayed on the LCD monitor.

4. Press the play & pause button () to play back a movie clip file.

- To pause a movie clip file while playing it back, press the play & pause button again.

- Pressing the play & pause button again will cause the movie clip file will restart.

- To rewind the movie clip while it is playing, press the LEFT button. To fast forward the movie clip, press the RIGHT button.

- To stop playback of the movie clip, press the play & pause button, and then press the LEFT or RIGHT button.

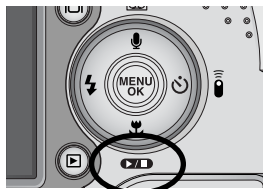

■ Movie clip capture function: capture still images from the movie clip.

● How to capture the movie clip

Steps 1-2 are the same as those for playing back a still image.

3. Select the recorded movie clip that you want to play back by using the LEFT/RIGHT button.

4. Press the Play/Pause button to play the movie clip

5. Press the Play/Pause button while playing the movie clip. Then press the Shutter button.

6. The paused movie clip is saved in a new file name.

* The captured movie clip file has same size as the original movie clip (640X480, 320X240, 160X128).

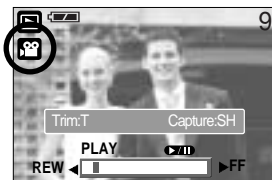

[Paused]

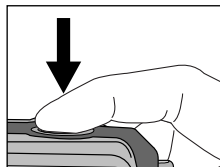

[Press the shutter button]

Starting play mode

- On camera movie trimming : You can extract desired frames of movie clip during the movie clip play back.

1. Select a desired movie clip in the play mode.
2. Play back the movie clip by pressing the Play & Pause button.
3. Press the Pause button at the point of the movie clip that you want to start extracting.
4. Press the T button. The start point doesn't display on the status bar, but the start point will be selected.
5. Press the Play button and the extracted range will be displayed on the status bar.
6. At the point of movie clip that you want to stop extracting, press the Pause button.
7. Press the T button and a confirmation window will display.



8. Select a desired sub menu by pressing the UP/DOWN button and press the OK button.
[Trimming] : The extracted frames are saved as a new file name.
[Cancel] : The movie trimming will cancel.



INFORMATION

- If the running time is under 10 seconds, the movie clip can't be trimmed.
- If you want to extract the movie clip at the beginning of the frame, press the Zoom T button before starting the movie clip.
- If the time line bar passes by the start point by pressing the REW(Left) button, the first frame of the movie clip will display.
- If you doesn't specify the ending point of the movie clip, the trimming confirmation window will display at the point of the last frame.

Starting play mode

■ Playing back a recorded voice

Steps from 1-2 are the same as those to play back a still image.

3. Select the recorded voice that you want to play back by using the LEFT/RIGHT button. If you select a recorded voice file, the voice indicator () will be displayed on the LCD monitor.

4. Press the play & pause button () to play back a recorded voice file.

- To pause a recorded voice file, while playing it back, press the play & pause button again.
- To resume playback of the voice file, press the play & pause button.
- To rewind the voice file while it is playing, press the LEFT button.
- To fast forward the voice file, press the RIGHT button.
- To stop playback of the voice file, press the play & pause button, and then press the LEFT or RIGHT button.

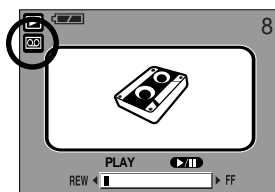

LCD monitor indicator

■ The LCD monitor displays information about the shooting conditions.



No.	Description	Icon	Page
1	Battery		p.16
2	Play mode		
3	File Type		
4	Voice memo		p.66
5	Protect indicator		p.77
6	DPOF indicator		p.81
7	Stored image number	9	
8	TIFF file	TIFF	

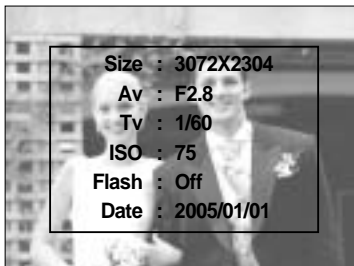

■ If you press the LCD button, you can check the following recording information:



Size : 3072X2304	Size
Av : F2.8	Aperture value
Tv : 1/60	Shutter speed
ISO : 75	ISO sensitivity
Flash : Off	Whether or not the flash is used.
Date : 2005/01/01	Recording date

Using the camera buttons to adjust the camera



■ In Play mode, you can use the buttons on the camera to conveniently set up the Play mode functions.

Thumbnail () / Enlargement () button

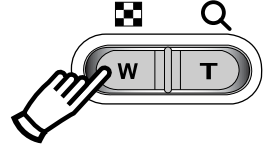
- You can view multiple pictures, enlarge a selected picture, and crop and save a selected area of an image.
- Thumbnail display
 1. While an image is displayed full screen, press the thumbnail button.
 2. The thumbnail display will highlight the image that had been showing at the time the thumbnail mode was selected.
 3. Press the 5 function button to move to a desired image.
 4. To view an image separately, press the enlargement button ().



[Normal display mode]

Pressing the thumbnail button ()
↔
Pressing the enlargement button ()
→
Highlighted image



[Thumbnail display mode]

- Image enlargement
 1. Select an image that you want to enlarge and press the enlargement button.
 2. Different parts of the image can be viewed by pressing the 5 function button.
 3. Pressing the thumbnail button will zoom back to the original full sized image.
 - You can tell whether the image displayed is an enlarged view by checking the image enlargement indicator shown at the bottom left of the LCD monitor. (If the image is not an enlarged view, the indicator will not be displayed.) You can also check the area of enlargement.
 - TIFF, Movie clips and WAV files can't be enlarged.
 - If an image is enlarged, a loss of quality may occur.

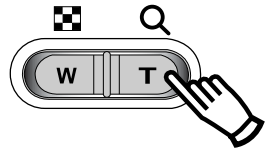

Thumbnail() / Enlargement() button

- The maximum enlargement rate in proportion to the image size.

Image size	3072	2816	2592	2272	2048	1600	1024	640
Maximum enlargement rate	X12.0	X11.0	X10.1	X8.8	X8.0	X6.2	X4.0	X2.5

- Trimming : You can extract part of the image that you want and save it separately.

1. Select an image that you want to enlarge and press the enlargement button.
2. Different parts of the image can be viewed by pressing the 5 function button.
3. Press the MENU button and a message will be displayed as shown alongside.
4. Select a desired sub menu by pressing the UP/ DOWN button and press the OK button.
 - [Trimming] : The trimmed image will save as a new file name, and display on the LCD monitor.
 - [Cancel] : The trimming menu will disappear.

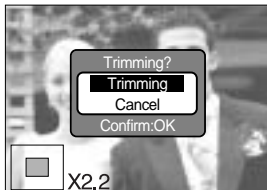

* If there is little memory space to save the trimmed image, the image can't be trimmed.

Voice () memo / Up button

- When the menu is displayed on the LCD monitor, pressing the UP button makes the menu cursor move up.
- When the menu is not displayed on the LCD monitor, the UP button operates as the voice memo button. You can add your voice to a stored still image.

- Adding a Voice Memo to a Still Image

1. Press the LEFT/ RIGHT button to select an image that you wish to add sound to.
2. Press the voice memo button () and the voice memo indicator will display. The camera is now ready to record a voice memo.



Voice () memo / Up button

3. Press the shutter button to start recording and voice will be recorded to the still image for 10 seconds.
While the voice is recording, the recording status window will be displayed as shown alongside.



4. The recording can be stopped by pressing the shutter button again.

5. The () icon will be displayed on the LCD monitor after voice memo recording has finished.

- Voice memos can't be recorded onto movie clip files.
- A distance of 40cm between you and the camera (microphone) is the best distance to record sound.
- The voice memo will be saved in *.wav format, but has the same file name as the still image to which it corresponds.
- If you add a new voice memo to the still image that already has a voice memo, the existing voice memo will be erased.



Play & Pause () / Down button

- In Play mode, the play & pause/ down button works as follows:

- If the menu is displayed

Press the DOWN button to move from the main menu to a sub menu, or to move down the sub menu cursor.

- If a still image with a voice memo, a voice file, or a movie clip is playing

In Stop mode : Plays a still image with a voice memo, a voice file, or a movie clip.

During playback : Temporarily stops playback.

In Pause mode : Resumes playback



[Voice recording is stopped]

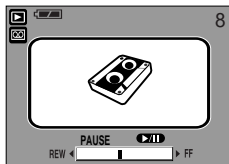

[Voice recording is playing]



[Voice recording is paused]

LEFT/ RIGHT/ MENU/ OK button

■ LEFT / RIGHT/ MENU/ OK buttons activate the following.

- LEFT button : While the menu is showing, press the LEFT button to select the menu tab to the left of the cursor.
- RIGHT button : While the menu is showing, press the RIGHT button to select the menu tab to the right of the cursor, or to move an secondary menu.
- MENU button : When you press the MENU button, the play mode menu will be displayed on the LCD monitor. Pressing it again will return the LCD to the initial display.
- OK button : When the menu is displayed on the LCD monitor, the OK button is used for confirming data that is changed by using the 5 function button.

LCD () button

■ The shooting information will be displayed on the LCD monitor.

The last image stored in the memory is displayed on the LCD monitor by pressing the play mode button.

Pressing the LCD() button in the PLAY mode will change the display as shown below. [Image & Icons] → [Image & Information] → [Image only]

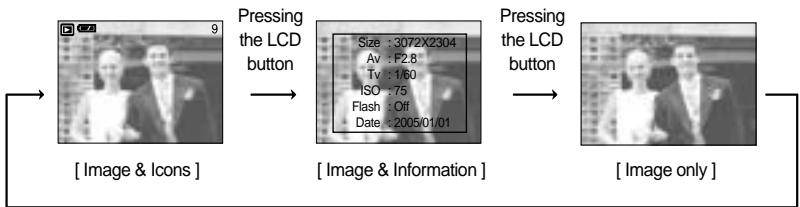
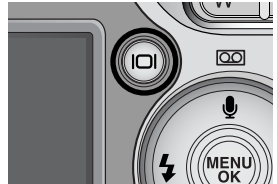

Pressing the LCD button

Delete () button

■ This deletes images stored on the memory card.

● Deleting Images in Play Mode

1. Select an image that you want to delete by pressing the LEFT / RIGHT button and press the DELETE () button.
2. A message will display as shown alongside on the LCD monitor.
3. Select the submenu values by pressing the UP/DOWN button and then press the OK button.
If [Delete] is selected: deletes the selected images.
If [Cancel] is selected: cancels "Delete Image".



● Deleting Images in Thumbnail Display Mode

1. Use the Up/Down/Left/Right buttons to select an image to delete.
2. Press the Delete button to display the following message in the LCD monitor.
3. Select the submenu values by pressing the UP/DOWN button and then press the OK button.
If [Delete] is selected: deletes the selected images.
If [Cancel] is selected: cancels "Delete Image".

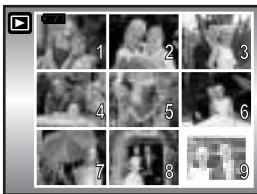

Press the DELETE button.

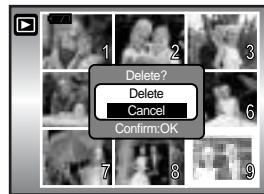

INFORMATION

- Before deleting images from the camera, you should protect (p.77) or download images (p.121) to your computer that you wish to keep.

Album button (MF button)

- You can organise the captured still images(except for the TIFF file type image) into albums by using the MF button.
- This camera has 8 albums and each album can take up to 100 images.
- The album menu loading time depends on the memory card type.

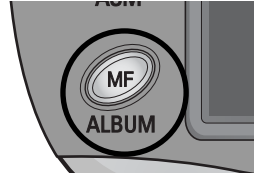

- How to use the album
- Selecting the album

1. In the play mode, press the MF button.

2. Select the [Select] menu by pressing the Up/Down button and press the Right button.



3. Select a desired album by pressing the Up/Down/Left/Right buttons and press the OK button.

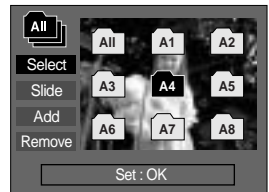

- Inserting still images into the album

1. Select an album.

2. Select the [Add] menu by pressing the Up/Down button and press the Right button.



Album button (MF button)

3. Select the still images you wish to add by pressing the Up/Down/Left/Right buttons and press the Zoom T button. ✓ marks are displayed on the selected images.
* To cancel the selection, press the Zoom T button again.



4. Press the OK button and a confirmation window will display. Select a desired sub menu by pressing the UP/ DOWN button and press the OK button.
[Add] : Inserts the selected images into the album.
[Cancel] : Cancels the inserting images.

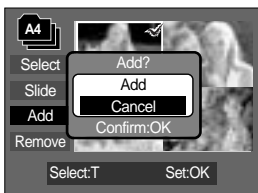

● Removing still images from the album

1. Select an album.
2. Select the [Remove] menu by pressing the Up/Down button and press the Right button.
3. Select a desired sub menu and press the OK button.
 - [Select] : Specific still images in the album can be removed.
 - [All] : All of the still images in the album will be removed.



※ If [Select] is selected :

- Select images that you want to remove by pressing the Up/Down/Left/Right buttons and press the Zoom T button. ✓ marks are displayed on the selected images.
4. Press the OK button and a confirmation window will display.
Select a desired sub menu by pressing the UP/ DOWN button and press the OK button.
[Remove] : Removes the selected images from the album.
[Cancel] : Cancels the removing images.
* The removed images are not deleted from the memory, but just removed from the album.

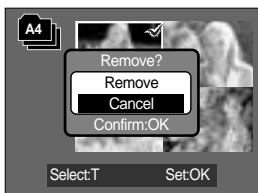

Album button (MF button)

● Playing back the albums

◎ Playing back all of the albums

1. Select [All] menu and press the OK button.
All of the albums will be selected.
2. Select the [Slide] menu by pressing the Up/Down button and press the Right button.
 - ※ You can select [Start], [Interval], [Repeat] and [Effect] menus.
 - [Start] : Start the slide show
 - [Interval] : Set the slide show play interval
 - [Repeat] : Choose to repeat the slide show after finishing the first cycle.
 - [Effect] : Unique screen effects can be used for the slide show.
3. Select the [Start] menu by pressing the Up/Down button and press the OK button to start the slide show.
4. To stop the slide show, Press the Play & Pause button and MENU/OK button.

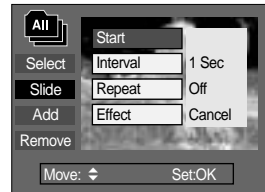

◎ Playing a desired album

1. Select a desired album and press the OK button.
2. Select the [Slide] menu by pressing the Up/Down button and press the Right button.
 - ※ You can Select the [Start], [Interval], [Repeat] and [Effect] menu.
3. Select the [Start] menu and press the OK button to start the slide show.
4. To stop the slide show, press the Play & Pause button and MENU/OK button.

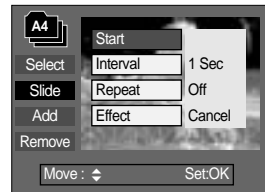







INFORMATION

- If an image is deleted from the memory, the image doesn't display on an album.
- An image can't be added twice into the same album.
- An image can be added into the different albums.



Setting up the play back function using the LCD monitor

- PLAY mode functions can be changed by using the LCD monitor. In the PLAY mode, pressing the MENU button displays the menu on the LCD monitor. The menus you can set up in Play mode are as follows. To capture an image after setting up the play menu, press the PLAY mode button or shutter button.





Menu tab	Main menu	Sub menu	Secondary menu	Page
	Slide	Start	-	p. 76
		Interval	1, 3, 5, 10sec	
		Repeat	Off, On	
		Effect	Cancel Effect 1, 2, 3, 4	
	Protect	Select	Unlock / Lock	p. 77
		All Pics		
	Delete	Select	-	p. 78
		All Pics	-	
	Resize	2816x2112	-	p. 79
		2592x1944	-	
		2272x1704	-	
		2048x1536	-	
		1600x1200	-	
		1024x768	-	
		640x480	-	
		User Image	-	
	Rotate	Right 90 °	-	p. 80
		Left 90 °	-	
		180 °	-	
		Horizontal	-	
		Vertical	-	
	DPOF	Standard	Select/ All Pics/ Cancel	p. 81
		Index	No/ Yes	
		Size	Select/ All Pics/ Cancel	

Setting up the play back function using the LCD monitor

- This menu is available while the camera is connected to a PictBridge supporting printer (direct connection to the camera, sold separately) with a USB cable.

Menu tab	Main menu	Sub menu	Secondary menu	Page
	Images	One Pic	-	p. 84
		All Pics	-	
	Auto Set	No	-	p. 85
		Yes	-	
	Custom Set	Size	Auto	p. 85
			Postcard	
			4X6	
			2L	
			A4	
			Letter	
			A3	
		Layout	Auto	
			Full	
			1	
			2	
			4	
			8	
			9	
		Type	16	
			Auto	
Plain				
Photo				
		Fastphoto		

Setting up the play back function using the LCD monitor

Menu tab	Main menu	Sub menu	Secondary menu	Page
	Custom Set	Quality	Auto	p. 85
			Draft	
			Normal	
			Fine	
		Date	Auto	
			Off	
			On	
		File Name	Auto	
			Off	
On				
	Print	Standard	-	p. 86
		Index	-	
	DPOF Print	No	-	p. 86
		Yes	-	
	Reset	No	-	p. 87
		Yes	-	

※ Menus are subject to change without prior notice.

Starting the slide show

■ Images can be displayed continuously at pre-set intervals. You can view the slide show by connecting the camera to an external monitor.

1. Press the play mode button and press the menu button.
2. Press the LEFT/ RIGHT button and select the [Slide] menu tab.



● Start the slide show: The slide show can start only in the [Start] menu.

1. Use the Up/Down buttons to select the [Start] menu.
2. Press the OK button to start the slide show.
 - Press the Pause button to pause the slide show.
 - Press the Pause button () again to resume the slide show.
 - To stop the slide show, press the play & pause button, and then press the LEFT or RIGHT button.

● Setting play interval: Set the slide show play interval.

1. Select the [Interval] sub menu by pressing the UP/DOWN button and press the RIGHT button.
2. Use the Up/Down buttons to select the desired interval.
3. Press the OK button to save the configuration.

● Repeat setting : setting the slide show to repeat after the first cycle.

1. Use the Up/Down buttons to select the [Repeat] menu and press the Right button.
2. Use the Up/Down buttons to select the desired sub menu.
 - [On] selected : The slide show is repeated until cancelled.
 - [Off] Selected : The slide show is closed after one cycle.
3. Press the OK button to save the configuration.

INFORMATION

- The loading time depends on the image size and quality.
- While the slide show is playing, only the first frame of a MOVIE file is displayed.

Starting the slide show

- Configure slide show effects: Unique screen effects can be used for the slide show.

1. Select the [Effect] sub menu by pressing the UP/ DOWN button and press the RIGHT button.
2. Use the Up/Down Button to select the type of effect.
[Cancel] : Normal display.
[Effect 1] : Image is displayed slowly.
[Effect 2] : Image is displayed slowly from the centre outwards.
[Effect 3] : Image moves from the top left.
[Effect 4] : The image slides diagonally from top left to bottom right.
3. Press the OK button to confirm the setting.



Protecting images

- This is used to protect specific shots from being accidentally erased (Lock). It also unprotects images that have been previously protected (Unlock).

- Protecting Images

1. Press the play mode button and press the menu button.
2. Press the LEFT/ RIGHT button and select the [Protect] menu tab.
3. Select a desired sub menu by pressing the UP/ DOWN button and press the OK button.

[Select] : Selection window for an image to be protected/released is displayed.

- Up/Down/Left/Right : Select an image
- Zoom W/T Button : Protect/release the image
- Menu Button : Your changes will be saved and the menu will disappear.

[All Pics] : Protect/release all saved images

- Zoom W/T Button : Protect/release the images
- Menu Button : Your changes will be saved and the menu will disappear.

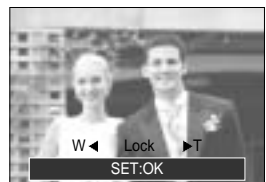

Protecting images

- If you protect an image, the protect icon will be displayed on the LCD monitor. (An unprotected image has no indicator)
- An image in LOCK mode will be protected from the delete function or [Delete] functions, but will NOT be protected from the [Format] function.

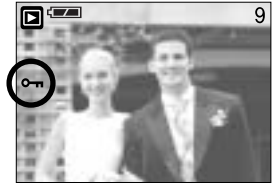

Deleting images

- Of all the files stored in the memory card, the unprotected files in the DCIM subfolder will be deleted. Remember that this will permanently delete unprotected images. Important shots should be stored on a computer before deletion takes place. The startup image is stored in the camera's internal memory (i.e., not on the memory card) and it will not be deleted even if you delete all files on the memory card.

● Deleting images

1. Press the play mode button and press the menu button.
2. Press the LEFT/ RIGHT button and select the [Delete] menu tab.
3. Select a desired sub menu by pressing the UP/ DOWN button and press the OK button.

[Select]: Selection window for an image to delete is displayed.

- Up/Down/Left/Right: Select an image

- Zoom T Button: Select the image for deletion.

(✓ mark)

- OK Button: Press the OK Button to display the confirmation message. Select the [Delete] menu and press the OK Button again to delete ✓ marked images.

[All Pics] : Displays confirmation window. Select the [Delete] menu and press the OK button to delete all unprotected images. If there are no protected images, a [No Image!] message will display.

4. After deletion, the screen will be changed to the play mode screen.

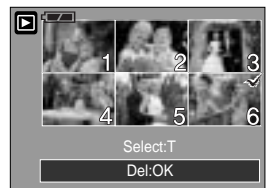

Resize

■ Change the resolution (size) of pictures taken. Select the [User Image] to save an image to be the start-up image. The resized image will have a new file name.

1. Press the play mode button and press the menu button.
2. Press the LEFT/ RIGHT button and select the [Resize] menu tab.
3. Select a desired sub menu by pressing the UP/ DOWN button and press the OK button.

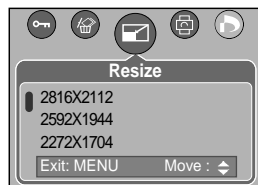

● Image Resize Types

Resize	2816X 2112	2592X 1944	2272X 1704	2048X 1536	1600X 1200	1024X 768	640X 480	User Image
3072	O	O	O	O	O	O	O	O
2816	X	O	O	O	O	O	O	O
2592	X	X	O	O	O	O	O	O
2272	X	X	X	O	O	O	O	O
2048	X	X	X	X	O	O	O	O
1600	X	X	X	X	X	O	O	O
1024	X	X	X	X	X	X	O	O
640	X	X	X	X	X	X	X	O

INFORMATION

- A large sized image can be resized to a smaller sized image, but not vice versa.
- Only JPEG images can be resized.
TIFF, Movie clip(AVI) and Voice recording(WAV) files can't be resized.
- You can change the resolution of only those files compressed in the JPEG 4:2:2 format.
- The resized image will have a new file name. The [User Image] image is stored not on the memory card but on the internal memory.
- Only two [User Image] images can be saved. If you save a new [User Image] image, the existing startup image will be deleted in order.
- If the memory capacity is insufficient to store the resized image, a [Card Full!] message will display on the LCD monitor and the resized image will not be stored.

Rotating an image

- You can rotate the stored images by various degrees.
- Once the playback of the rotated picture is finished, it will switch back to the original state.

1. Press the play mode button and press the menu button.
2. Press the LEFT/ RIGHT button and select the [Rotate] menu tab.
3. Select a desired sub menu by pressing the UP/ DOWN button.
4. Press the OK button and the rotated image will be displayed. If you display the rotated image on the LCD monitor, empty spaces may appear to the left and right of the image.

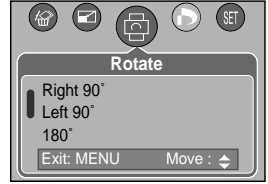

[Right 90°] : Rotate picture in a clock-wise direction



[Left 90°] : Rotate picture in a counter clock-wise direction



[180°] : Rotate picture 180 degrees



[Horizontal] : Rotate picture horizontally



[Vertical] : Rotate picture vertically

DPOF

- DPOF(Digital Print Order Format) allows you to embed printing information on your memory card's MISC folder. Select the pictures to be printed and how many prints to make.
- The DPOF indicator will display on the LCD monitor when an image that has DPOF information plays back. Images can then be printed on DPOF printers, or at an increasing number of photo labs.
- This function is not available for Movie clips and Voice recording files.

DPOF : STANDARD

- This function allows you to embed print quantity information on a stored image.

1. Press the play mode button and press the menu button.
2. Press the LEFT/ RIGHT button and select the [DPOF] menu tab.
3. Select the [Standard] menu by pressing the UP/ DOWN button and press the RIGHT button.
4. Select a desired sub menu by pressing the UP/ DOWN button and press the OK button.

[Select]: Selection window for an image to print is displayed.

- Up/Down/Left/Right: Select an image to print.
- Zoom W/T Button: Select the number of prints.

[All Pics] : Configure number of prints for all pictures except movie and voice files.

- Zoom W/T Button: Select the number of prints.

[Cancel] : Cancel the print setup.

5. Press the OK button to confirm the setting. If an image carries DPOF instructions, the DPOF indicator () will show.

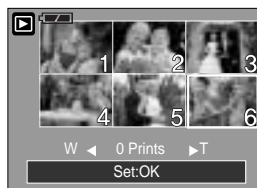
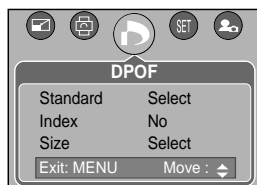

DPOF : INDEX

- Images (except for movie clips and voice file) are printed as index type.

1. Press the play mode button and press the menu button.
2. Press the LEFT/ RIGHT button and select the [DPOF] menu tab.
3. Select the [Index] menu by pressing the UP/ DOWN button and press the RIGHT button.
4. Select a desired sub menu by pressing the UP/ DOWN button.

If [No] is selected : Cancel the index print setting.

If [Yes] is selected : The image will be printed in index format.

5. Press the OK button to confirm the setting.



DPOF : PRINT SIZE

- You can specify the print size when printing images stored on the memory card. The [Size] menu is available only for DPOF 1.1 compatible printers.

● Setting the Print Size

1. Press the play mode button and press the menu button.
2. Press the LEFT/ RIGHT button and select the [DPOF] menu tab.
3. Select the [Size] menu by pressing the UP/ DOWN button and press the RIGHT button.
4. Select a desired sub menu by pressing the UP/ DOWN button and press the OK button.

[Select] : Selection window for an image to be changed printed size is displayed.

- Up/Down/Left/Right : Select an image.

- Zoom W/T Button : Change the print size.

- OK button : Your changes will be saved and the menu will disappear.

[All Pics] : Change print size of all saved images

- Zoom W/T button : Change the print size

- OK button : Confirm the changed setting.

[Cancel] : Cancel all of the print size settings.

- * DPOF [Size] secondary menu : Cancel, 3X5, 4X6, 5X7, 8X10



PictBridge

■ You can use the USB cable to connect this camera to a printer that supports PictBridge (sold separately) and print the stored images directly. TIFF, Movie clips and voice files cannot be printed. You can set up the following settings from the PictBridge menu.

Images	: Select the pictures to be printed.
PRINTER SETUP	: Setting up printing(Auto Set/Custom Set)
Print	: Printing pictures
DPOF Print	: Printing the DPOF files
Reset	: Initialising the PictBridge functions

● Connecting the Camera to a Printer

1. Press the POWER button to turn on the camera.
2. In a mode other than Voice Recording mode, press the MENU button.
3. Press the LEFT/ RIGHT button and select [Setup] menu tab.
4. Select [USB] menu by pressing the UP/ DOWN button and press the RIGHT button.
5. Select [Printer] menu by pressing the UP/ DOWN button and press the OK button.
6. Press the menu button twice and the menu will disappear.
7. Use the supplied USB cable to connect the camera to the printer as shown below.
8. Turn on the printer to connect the camera to the printer.

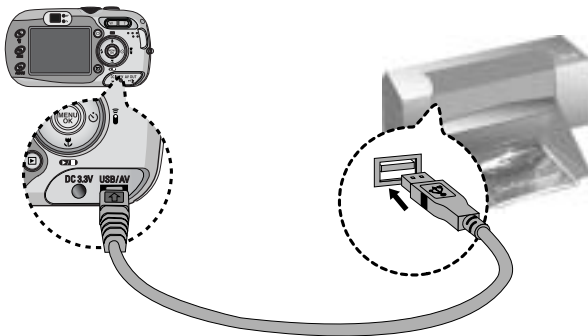
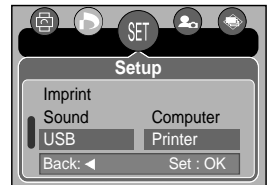

※ If you selected [Computer] in Step 5, when you connect the camera to your printer, the Mode dial lamp(Green) will illuminate and the connection will not be established. In this case, disconnect the USB cable, and then follow the procedure from Step 2 and onward.

PictBridge: Picture Selection

■ Select pictures to print

1. Connect the camera to your printer. The USB menu must be set to [Printer] before you connect the camera to the printer. (See p.83)
2. The [Images] menu will appear.
3. Use the UP and DOWN buttons to select the desired submenu value, and then press the OK button.



When [One Pic] is selected : The PictBridge function will be applied only to the picture currently displayed.

When [All Pics] is selected : The PictBridge function will be applied to all pictures, excluding TIFF, movie clips and voice files.

● Setting the Number of Copies to Print

- Select [One Pic] or [All Pics]. A screen where you can set the number of copies to print will appear as shown below.



[When [One Pic] is selected]



[When [All Pics] is selected]

- Press the Up/Down button to select the number of prints.
- Use the Left/Right button to select another picture and select the number of prints for another picture.
- After setting the number of prints, press the OK button to save.
- Press the Shutter button to return to the menu without setting the number of prints.

PictBridge: Print Setting

■ AUTO SET

1. Connect the camera to your printer. The USB menu must be set to [Printer] before you connect the camera to the printer. (See p.83)
2. Use the LEFT and RIGHT buttons to select the [Auto Set] menu tab.
3. Use the UP and DOWN buttons to select the desired submenu value, and then press the OK button.
[No] : [Custom Set] values are kept.
[Yes] : All values in the [Custom Set] are automatically changed.



■ CUSTOM SET : You can select the Paper Size, Print Format, Paper Type, Print Quality, Date Print, and File Name Print menus for printed pictures.

1. Connect the camera to your printer. The [USB] menu must be set to [Printer] before you connect the camera to the printer. (See p.83)
2. Use the LEFT and RIGHT buttons to select the [Custom Set] menu tab.
3. Use the UP and DOWN buttons to select the desired submenu value, and then press the RIGHT button.
4. Use the UP and DOWN buttons to select the desired submenu value, and then press the OK button.



■ The menus you can set up are as follows:

Menu	Function	Sub menu
Size	Setting the size of the printing paper	Auto, Postcard, 4x6, 2L, A4, Letter, A3
Layout	Setting the number of pictures to be printed on a sheet of paper	Auto, Full, 1, 2, 4, 8, 9, 16
Type	Setting the quality of the printing paper	Auto, Plain, Photo, Fastphoto
Quality	Setting the quality of the picture to be printed	Auto, Draft, Normal, Fine
Date	Setting whether to print the date	Auto, Off, On
File Name	Setting whether to print the file name	Auto, Off, On

- ※ Some menu options are not supported in all manufacturer and printer models. If not supported, the menus are still displayed in the LCD, but are not selectable.
- ※ If the setting values are not changed in the automatic/manual setting, the setting values are automatically kept.

PictBridge: Printing

■ Printing Pictures

1. Connect the camera to your printer. The USB menu must be set to [Printer] before you connect the camera to the printer. (See p.83)
2. Use the LEFT and RIGHT buttons to select the [Print] menu tab.
3. Use the UP and DOWN buttons to select the desired submenu value, and then press the OK button.

[Standard] : Print the pictures stored in the memory

card in set numbers. One picture is printed on one piece of paper.

[Index] : Print multiple images on one sheet of paper.

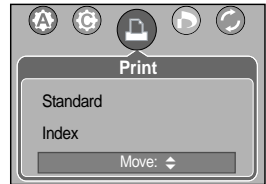

4. The screen shown on the right will appear and the picture will be printed. If no picture is selected, the [No Image !] message will be displayed. Press the Menu/OK button while printing to cancel the printing and the [Print] menu is displayed.

※ Number of pictures in a index print varies depends on the printer used.



■ DPOF PRINT : This allows you to directly print the files with DPOF information.

1. Connect the camera to your printer. The [USB] menu must be set to [Printer] before you connect the camera to the printer. (See p.83)
2. Use the LEFT and RIGHT buttons to select the [DPOF Print] menu tab.
3. Use the UP and DOWN buttons to select the desired submenu value, and then press the OK button.

[No] : Cancel the printing

[Yes] : Directly print the file with the DPOF information

※ Depending on the manufacturer and printer model, some menus may not be available. With a printer without supporting the DPOF, the menu is still displayed but not available.



PictBridge : RESET

■ Initialises user-changed configurations.

1. Connect the camera to your printer. The [USB] menu must be set to [Printer] before you connect the camera to the printer. (See p.83)
2. Use the LEFT and RIGHT buttons to select the [Reset] menu tab.
3. Use the UP and DOWN buttons to select the desired submenu value, and then press the OK button.
 - If [No] is selected : Settings will not be reset.
 - If [Yes] is selected : All print and image settings will be reset.



※ Default print setting varies depending on the printer manufacturer.







For your printer's default setting, refer to the user's guide that came with your printer.

Setup menu

■ In this mode, you can set up basic settings.

You can use the setup menu in all camera modes, except Voice Recording mode.

The items indicated by  are default settings.

Menu tab	Main menu	Sub menu	Secondary menu	Page	
	File	Reset	-	p.89	
		 Series	-		
	Power Off	Off, 1,  3, 5, 10 min	-	p.90	
	Language	ENGLISH	РУССКИЙ	p.91	
		한국어	PORTUGUÊS		
		FRANÇAIS	DUTCH		
		DEUTSCH	DANSK		
		ESPAÑOL	SVENSKA		
		ITALIANO	SUOMI		
		简体中文	ไทย		
		繁體中文	BAHASA		
	Format	No		-	p.91
		Yes	-	-	
	D&Time	05/01/01 13:00	-	p.92	
		 yy/mm/dd	-		
		dd/mm/yy	-		
		mm/dd/yy	-		
	Imprint	Off		-	p.92
		Date	-	-	
		D & Time	-	-	
	Sound	Off	-	p.93	
		Low	-		
		 Medium	-		
		High	-		

Setup menu

Menu tab	Main menu	Sub menu	Secondary menu	Page
	USB	Computer	-	p.93
		Printer	-	
	AF Lamp	Off	-	p.94
		On	-	
	LCD	Dark	-	p.94
		Normal	-	
		Bright	-	
	Video Out	NTSC	-	p.95
		PAL	-	
	Quick View	Off/ 0.5, 1, 3sec	-	p.96
	Reset	No	-	p.96
		Yes	-	

* Menus are subject to change without prior notice.

File name

■ This function allows the user to select the file naming format.

● Assigning File Names

1. In any mode with the exception of Voice Recording mode, press the MENU button.
2. Press the LEFT/ RIGHT button and select the [Setup] menu tab.
3. Select the [File] menu by pressing the UP/ DOWN button and press the RIGHT button.
4. Select a desired sub menu by pressing the UP/ DOWN button and press the OK button.

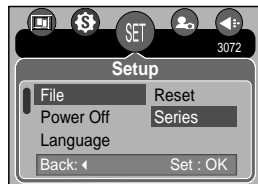

[Reset] : After using the reset function, the next file name will be set from 0001 even after formatting, deleting all or inserting a new memory card.

[Series] : New files are named using numbers that follow the previous sequence, even when a new memory card is used, or after formatting, or after deleting all pictures

5. Press the menu button twice and the menu will disappear.

File name

INFORMATION

- The first stored folder name is 100SSCAM, and the first file name is SV100001.
- File names are assigned sequentially from SV100001 → SV100002 → ~ → SV109999.
- The folder number is assigned sequentially from 100 to 999 as follows
: 100SSCAM → 101SSCAM → ~ → 999SSCAM.
- The files used with the memory card conform to the DCF(Design rule for Camera File systems) format.

Auto power off

- This function switches the camera off after a set amount of time in order to prevent unnecessary battery drainage.

● Setting Power Off

1. In any mode with the exception of Voice Recording mode, press the MENU button.
2. Press the LEFT/ RIGHT button and select the [Setup] menu tab.
3. Select the [Power Off] menu by pressing the UP/ DOWN button and press the RIGHT button.
4. Select a desired sub menu by pressing the UP/ DOWN button and press the OK button.

[Off] : The power off function will not operate.

[1, 3, 5, 10min] : The power will turn off automatically if not used for the period of time specified.

5. Press the menu button twice and the menu will disappear.

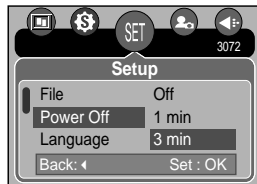

INFORMATION

- Even if the batteries or AC adapter are removed and inserted again, the power off setting will be preserved.
- Note that the automatic power off function will not operate if the camera is in PC mode, slide show, playing back a voice recording, playing back a movie clip or during composite shooting.

Language

- There is a choice of languages that can be displayed on the LCD monitor. Even if the batteries or AC adapter are removed and inserted again, the language setting will be preserved.

● Setting Language

1. In any mode with the exception of Voice Recording mode, press the MENU button.
2. Press the LEFT/ RIGHT button and select the [Setup] menu tab.
3. Select the [Language] menu by pressing the UP/ DOWN button and press the RIGHT button.
4. Select a desired sub menu by pressing the UP/ DOWN button and press the OK button.



LANGUAGE sub menu : English, Korean, French, German, Spanish, Italian, S. Chinese, T. Chinese, Japanese, Russian, Portuguese, Dutch, Danish, Swedish, Finnish, Thai, BAHASA(MALAY/ INDONESIAN) and Arabic.

5. Press the menu button twice and the menu will disappear.

Formatting a memory card

- This is used for formatting the memory card. If you run [Format] on the memory card, all images, including the protected images, will be deleted. Be sure to download important images to your PC before formatting the memory card.

● Formatting a Memory Card

1. In any mode other than Voice Recording mode, press the MENU button.
2. Press the LEFT/ RIGHT button and select the [Setup] menu tab.
3. Select the [Format] menu by pressing the UP/ DOWN button and press the RIGHT button.
4. Select a desired sub menu by pressing the UP/ DOWN button and press the OK button.

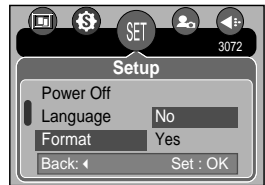

If [No] is selected : The memory card will not be formatted.

Press the menu button twice and the menu display will disappear.

If [Yes] is selected : A [Please Wait !] message appears and the memory card will be formatted. If you ran FORMAT in Play mode, a [No Image !] message will appear.

INFORMATION

- Be sure to run [Format] on the following types of memory card.
 - A new memory card, or an unformatted memory card.
 - A memory card that has a file this camera can't recognise or one that has been taken from another camera.
- Always format the memory card using this camera. If you insert a memory card that has been formatted using other cameras, memory card readers, or PCs, you will get a [Card Error!] message.

Setting up the Date/ Time/ Date type

- You can change the date and time that will be displayed on the captured images and set up the date type.

- Setting Date/Time & Selecting Date Format

1. In any mode with the exception of Voice Recording mode, press the MENU button.
2. Press the LEFT/ RIGHT button and select the [Setup] menu tab.
3. Select the [D & Time] menu by pressing the UP/ DOWN button and press the RIGHT button.
4. Use the UP, DOWN, LEFT, and RIGHT buttons to select the desired submenu value, and then press the OK button.

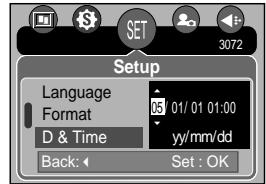

RIGHT button : Selects the year/month / day/hour / minute date type.
LEFT button : Moves the cursor to the [D & Time] main menu if the cursor is at the first item of the date and time setup. In all other cases, the cursor will be shifted to the left of its current position.

UP and DOWN buttons : Changes the setting value.

- Date type : [yy/mm/dd] / [dd/mm/yy] / [mm/dd/yy]

5. Press the menu button twice and the menu will disappear.

Imprinting the recording date

- There is an option to include DATE/TIME on still images.

- Date Imprinting

1. In any mode with the exception of Voice Recording mode, press the MENU button.
2. Press the LEFT/ RIGHT button and select the [Setup] menu tab.
3. Select the [Imprint] menu by pressing the UP/ DOWN button and press the RIGHT button.
4. Use the UP and DOWN buttons to select the desired date imprint type, and then press the OK button.

[Off] : The DATE & TIME will not be imprinted on the image file.

[Date] : Only the DATE will be imprinted on the image file.

[D & Time] : The DATE & TIME will be imprinted on the image file.

5. Press the menu button twice and the menu will disappear.

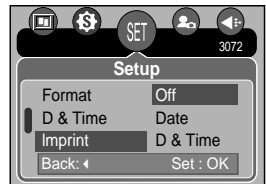

* The Date & Time are imprinted at the bottom right side of the still image.

* The date will be imprinted as a DATE TYPE setting.

* TIME is imprinted in the following way : [Hour : Minute] and hours are shown using the 24 hour clock.

* The imprint function is applied only to still images except for the images taken in the [Text] scene mode.

Sound

■ If you set the operation sound to ON, various sounds will be activated for camera startup, when button are pressed, and if there is a card error, so that you can be aware of the camera operation status.

● Setting Operation Sounds

1. In any mode with the exception of Voice Recording mode, press the MENU button.
2. Press the LEFT/ RIGHT button and select the [Setup] menu tab.
3. Select the [Sound] menu by pressing the UP/ DOWN button and press the RIGHT button.
4. Select a desired sub menu by pressing the UP/ DOWN button and press the OK button.
[Sound] sub menu : Off/ Low/ Medium/ High
5. Press the menu button twice and the menu will disappear.

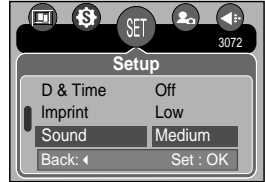

Connecting an External Device (USB)

■ You can select an external device to which you want to connect the camera using the USB cable.

● Selecting an External Device

1. In any mode with the exception of Voice Recording mode, press the MENU button.
2. Press the LEFT/ RIGHT button and select the [Setup] menu tab.
3. Select the [USB] menu by pressing the UP/ DOWN button and press the RIGHT button.
4. Select a desired sub menu by pressing the UP/ DOWN button and press the OK button.

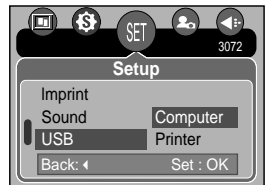

[Computer] : Select this if you want to connect the camera to your PC.

Refer to page 120 for instructions on how to connect the camera to your PC.

[Printer] : Select this if you want to connect the camera to your printer.

Refer to page 83 for instructions on how to connect the camera to your printer.

5. Press the menu button twice and the menu will disappear.

Auto Focus lamp

■ You can turn on and off the Auto Focus lamp

● How to set up the lamp

1. In any mode with the exception of Voice Recording mode, press the MENU button.
2. Press the LEFT/ RIGHT button and select the [Setup] menu tab.
3. Select the [AF Lamp] menu by pressing the UP/ DOWN button and press the RIGHT button.
4. Select a desired sub menu by pressing the UP/ DOWN button and press the OK button.

If [Off] is selected : The AF lamp will not light up.

If [On] is selected : The AF lamp will light up.

※ If you select [Off] menu and take an image in poorly lit condition or select the [Night] scene mode, the camera may not take exact focus.

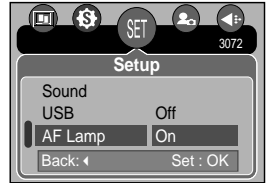

LCD brightness

■ You can adjust the LCD brightness.

● Adjusting LCD Brightness

1. In any mode with the exception of Voice Recording mode, press the MENU button.
2. Press the LEFT/ RIGHT button and select the [Setup] menu tab.
3. Select the [LCD] menu by pressing the UP/ DOWN button and press the RIGHT button.
4. Select a desired sub menu by pressing the UP/ DOWN button and press the OK button.
[LCD] sub menu : Dark, Normal, Bright
5. Press the menu button twice and the menu will disappear.

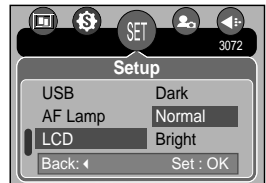

Selecting Video out type

- The Video output signal from the camera can be NTSC or PAL.

Your choice of output will be governed by the type of device (monitor or TV, etc.) to which the camera is connected. PAL mode can support only BDGHI.

● Setting the Video Out Type

1. In any mode with the exception of Voice Recording mode, press the MENU button.
2. Press the LEFT/ RIGHT button and select the [Setup] menu tab.
3. Select the [Video Out] menu by pressing the UP/ DOWN button and press the RIGHT button.
4. Select a desired sub menu by pressing the UP/ DOWN button and press the OK button.
[Video Out] sub menu : NTSC, PAL
5. Press the menu button twice and the menu will disappear.

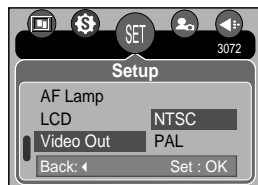

● Connecting to an external monitor

In RECORDING/ PLAY mode, you can view the stored still images or movie clips by connecting the camera to an external monitor via the AV cable. When the camera is connected to an external monitor, the LCD monitor will be turned off automatically.

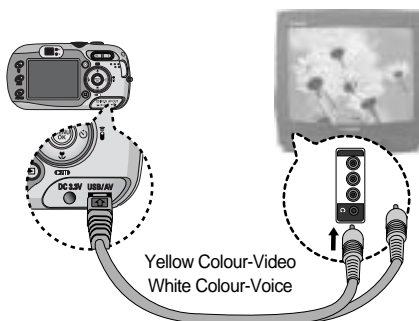

INFORMATION

- NTSC : U.S.A, Canada, Japan, South Korea, Taiwan, Mexico.
- PAL : Australia, Austria, Belgium, China, Denmark, Finland, Germany, U.K., Holland, Italy, Kuwait, Malaysia, New Zealand, Singapore, Spain, Sweden, Switzerland, Thailand, Norway.
- When using a TV as an external monitor, you will need to select the external or AV channel of the TV.
- There will be a digital noise on the external monitor, but it is not a malfunction.
- If the image is not in the centre of the screen, use the TV controls to centre it.
- When the camera is connected to an external monitor, the menu will be visible on the external monitor and the menu functions are the same as those indicated on the LCD monitor.

Quick view

- If you enable Quick View before capturing an image, you can view the image you just captured on the LCD monitor for the duration set in the [Quick View] setup. Quick view is possible only with still images.

● Setting Quick View

1. In any mode with the exception of Voice Recording mode, press the MENU button.
2. Press the LEFT/ RIGHT button and select the [Setup] menu tab.
3. Select the [Quick View] menu by pressing the UP/ DOWN button and press the RIGHT button.
4. Select a desired sub menu by pressing the UP/ DOWN button and press the OK button.
[off] : The quick view function can't be activated.
[0.5, 1, 3sec] : The captured image is briefly displayed during the selected time.
5. Press the menu button twice and the menu will disappear.

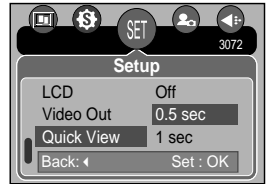

Initialisation

- All camera menu and function settings will be restored to their default values. However, values for DATE/ TIME, LANGUAGE, and VIDEO OUT will not be changed.

● Initialising the Camera

1. In any mode with the exception of Voice Recording mode, press the MENU button.
2. Press the LEFT/ RIGHT button and select the [Setup] menu tab.
3. Select the [Reset] menu by pressing the UP/ DOWN button and press the RIGHT button.
4. Select a desired sub menu by pressing the UP/ DOWN button and press the OK button.
If [No] is selected : Settings will not be restored to their defaults.
If [Yes] is selected : All settings will be restored to their defaults.

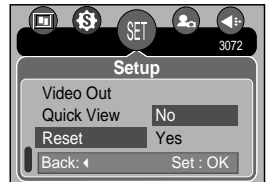

Setting up the MYCAM menu

- You can set up a start up image, start up sound and shutter sound. Every camera working mode (with the exception of Voice recording mode) has the MyCAM menu. The items indicated by are default settings.

Menu tab	Main menu	Sub menu		Page
	S.Image	Off	LOGO	p.97
		User Image 1	User Image 2	
	S.Sound	Off	Sound 1	p.98
		Sound 2	Sound 3	
	SH.Sound	Off	Sound 1	p.98
		Sound 2	Sound 3	

* Menus are subject to change without prior notice.

Start up image

- You can select the image that is first displayed on the LCD monitor whenever the camera is turned on.
- Setting a Startup Image
 1. In any mode with the exception of Voice Recording mode, press the MENU button.
 2. Press the LEFT/ RIGHT button and select the [Mycam] menu tab.
 3. Select the [S.Image] menu by pressing the UP/ DOWN button and press the RIGHT button.
 4. Select a desired sub menu by pressing the UP/ DOWN button and press the OK button.
 5. Press the menu button twice and the menu will disappear.

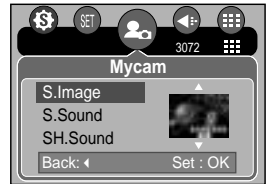

INFORMATION

- Use a saved image for the start-up image with the [User Image] in the [Resize] menu in the play mode.
- The start-up image will not be deleted by deleting all images or [Format] menu.
- The User images will be deleted by [Reset] menu.

Start up sound

■ You can select the sound that is activated whenever the camera is turned on.

● Setting the Startup Sound

1. In any mode with the exception of Voice Recording mode, press the MENU button.
2. Press the LEFT/ RIGHT button and select the [Mycam] menu tab.
3. Select the [S.Sound] menu by pressing the UP/ DOWN button and press the RIGHT button.
4. Select a desired sub menu by pressing the UP/ DOWN button and press the OK button.
5. Press the menu button twice and the menu will disappear.

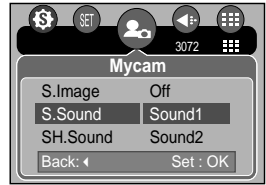

Shutter sound

■ You can select the shutter sound.

● Selecting the Shutter Sound

1. In any mode with the exception of Voice Recording mode, press the MENU button.
2. Press the LEFT/ RIGHT button and select the [Mycam] menu tab.
3. Select the [SH.Sound] menu by pressing the UP/ DOWN button and press the RIGHT button.
4. Select a desired sub menu by pressing the UP/ DOWN button and press the OK button.
5. Press the menu button twice and the menu will disappear.

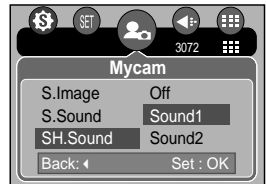

Important notes

Be sure to observe the following precautions!

- This unit contains precision electronic components. Do not use or store this unit in the following locations.
 - Areas exposed to severe changes in temperature and humidity.
 - Areas exposed to dust and dirt.
 - Areas exposed to direct sunlight or the inside of a vehicle in hot weather.
 - Environments where there is high magnetism or excessive vibration.
 - Areas with high explosives or highly flammable materials.

- Do not let the unit come into contact with dust, vinyl goods, or chemicals, such as insecticides, for an extended period of time.

- Sand can be particularly troublesome to cameras.
 - Do not let sand get inside the unit when using it on beaches, coastal dunes, or other areas where there is lots of sand.
 - Doing so may result in failure or may permanently render the unit unusable.

- Handling the camera
 - Never drop the camera or subject it to severe shocks or vibrations.
 - This camera is not waterproof. To avoid dangerous electrical shocks, never hold or operate the camera with wet hands.
 - If you use this camera in wet places, such as beach or pool, do not let water or sand get inside the camera.

- Extremes in temperature may cause problems.
 - If the camera is transferred from a cold to a warm and humid environment, condensation can form on the delicate electronic circuitry. If this occurs, turn the camera off and wait for at least 1 hour until all moisture is dispersed. Moisture build up can also occur in the memory card. If this happens, turn off the camera and remove the memory card. Wait until the moisture has dispersed.

Important notes

■ Caution on Using the Lens

- If the lens is subjected to direct sunlight, it could result in discoloration and deterioration of the image sensor.
- Pay attention not to get fingerprints or foreign substances on the surface of the lens.

■ If the digital camera is not used for a long period, an electric discharge can occur.

It is a good idea to remove the batteries and the memory card if you do not intend using the camera for an extended period of time.

■ If the camera is exposed to an electronic interference, it will turn itself off to protect the memory card.

■ Camera Maintenance

- Use a soft brush (available from photo stores) to gently clean the lens and LCD assemblies. If this does not work, lens-cleaning paper with lens cleaning fluid can be used. Clean the camera body with a soft cloth. Do not allow this camera to come into contact with solvent materials such as benzol, insecticide, thinners etc. This may damage the body shell of the camera and also affect its performance. Rough handling can damage the LCD monitor. Take care to avoid damage and keep the camera in its protective carry case at all times when not in use.

■ Do not attempt to disassemble or modify the camera.

■ Under certain conditions, static electricity can cause the flash unit to fire. This is not harmful to the camera and is not a malfunction.

■ When images are uploaded or downloaded, the data transfer may be affected by static electricity. In this case, disconnect and re-connect the USB cable before trying the transfer again.

■ Before an important event or going on a trip, you should check the camera condition.

- Take a picture for testing the camera condition and prepare extra batteries.
- Samsung cannot be held responsible for camera malfunctions.

Warning indicator

- There are several warnings that may appear on the LCD display.

Card Error !

- Memory card error
 - Turn off the camera power and turn it on again
 - Insert the memory card again
 - Insert the memory card and format the memory card (p.91)

No Card !

- A memory card is not inserted
 - Insert a memory card
- The camera can't recognise the memory card
 - Insert the memory card again
 - Turn off the camera power and turn it on again

Card Locked !

- The memory card is locked
 - SD memory card : Slide the write protect switch to the top of the memory card

Card Full !

- There is insufficient memory capacity to take an image
 - Insert a new memory card
 - Delete unnecessary image files to free up some memory

No Image !

- There are no images stored on the memory card
 - Take images
 - Insert a memory card that is holding some images

File Error !

- File error
 - Format the memory card
- Memory card error
 - Contact a camera service centre

Low Battery !

- There is low battery capacity
 - Insert charged battery

Warning indicator

Low Light !

- When taking pictures in dark places
 - Use a tripod and take pictures in Flash Photography mode

Set USB

- [USB] sub menu and connected device are not matched.
 - Reconfigure [USB] in the [Setup] menu.

Out Of Number

- When selecting too many printing pages in the PictBridge menu.
 - Select printing page within the limitation.

Before contacting a service centre

- Please check the following

The camera doesn't switch on

- There is low battery capacity.
 - Insert charged battery.
- Batteries are inserted incorrectly with the reverse polarities.
 - Insert the batteries according to the polarity marks (+, -).

The camera power ceases while in use.

- The batteries are exhausted.
 - Insert charged battery.
- The Camera is turned off automatically.
 - Turn off the camera power and turn it on again.

Batteries drain quickly

- The Camera is being used in low temperatures.
 - Keep the camera in warm conditions (i.e. inside a coat or jacket) and only remove it in order to take images.

Before contacting a service centre

Camera does not take images when pressing the Shutter button

- There is insufficient memory capacity.
 - Delete unnecessary image files
- The memory card has not been formatted
 - Format the memory card (p.91)
- The memory card is exhausted
 - Insert a new memory card
- The memory card is locked
 - Refer to [Card Locked !] error message (p.101)
- The camera's power is off
 - Turn the camera power on
- The batteries are exhausted
 - Insert charged battery.
- Batteries are inserted incorrectly with the reverse polarities.
 - Insert the batteries according to the polarity marks (+, -).

The camera suddenly stops working while in use

- The camera was stopped due to a malfunction
 - Remove /re-insert batteries and switch the camera on

The images are unclear

- A picture was taken within 0.8 m from the subject without setting an appropriate macro mode
 - If the subject is closer than 0.8m, select macro shot mode
- Taking a picture beyond the flash range
 - Take a picture within the flash range
- The lens is smudged or dirty
 - Clean the lens

The flash does not fire

- Flash off mode has been selected
 - Dis-engage flash off mode
- The camera mode can't use the flash
 - Refer to the FLASH instruction (p.34)

Incorrect date and time is displayed

- The date and time have been set incorrectly or the camera has adopted the default settings
 - Reset the date and time correctly

Before contacting a service centre

The images don't play back

- Incorrect file name (Violation of DCF format)
 - Do not change the image file name

Colour of image is different to the original scene

- White balance setting is incorrect
 - Select appropriate White balance

Images are too bright

- Exposure is excessive
 - Reset exposure compensation

No image on external monitor

- The external monitor has not been connected properly with the camera
 - Check the connection cables
- There are incorrect files in the memory card
 - Insert a memory card that has correct files

When using the PC's explorer, the [Removable Disk] file does not show

- Cable connection is incorrect
 - Check the connection
- The camera is off
 - Turn the camera on
- The operating system is not Windows 98, 98SE, 2000, ME, XP/ Mac OS 9.2 ~ 10.3.
Alternatively the PC does not support USB
 - Install Windows 98, 98SE, 2000, ME, XP/ Mac OS 9.2 ~ 10.3 to PC that supports USB
- The camera driver is not installed
 - Install a [USB Storage Driver]

Specifications

Image Sensor	Type	1/1.8" CCD
	Effective Pixel	Approx. 7.1 Mega-pixel
	Total Pixel	Approx. 7.4 Mega-pixel
Lens	Focal Length	Schneider Lens f = 7.8 ~ 23.4 mm (35mm film equivalent : 38 ~ 114 mm)
	F No.	F2.8 ~ F5.1
	Digital Zoom	Still Image mode : 1.0X ~ 10.0X Play mode : 1.0X ~ 12.0X (depends on image size)
Viewfinder	Optical Viewfinder	Real image optical viewfinder
	LCD Monitor	2.0" Colour TFT LCD (118,080 dots)
Focusing	Type	TTL auto focus, Manual focus
	Range	Normal : 80cm ~ infinity Macro : 4 ~ 80cm (Wide), 25 ~ 80cm (Tele) Auto Macro : 4cm ~ infinity (Wide), 25 ~ infinity (Tele)
Shutter	Type	Mechanical and Electronic shutter
	Speed	Auto : 1 ~ 1/2,000 sec. Manual : 15 ~ 1/2,000 sec. Night : 8 ~ 1/2,000 sec.
Exposure	Control	Program AE, Shutter Priority AE, Aperture Priority AE or Manual Exposure Metering : Multi, Spot
	Compensation	±2.0EV (1/3EV steps)
	ISO Equivalent	Auto, 50, 100, 200, 400
Flash	Modes	Auto, Auto & Red-eye reduction, Slow sync, Fill-in, Off
	Range	Wide : 0.2 ~ 3.0m, Tele : 0.25 ~ 2.0m
	Recharging Time	Approx. 7 sec.
Sharpness		Soft, Normal, Vivid
Effect		Normal, B&W, Sepia, Negative, RGB
White Balance		Auto, Daylight, Cloudy, Fluorescent_H, Fluorescent_L, Tungsten, Custom1, Custom 2
Voice Recording		Voice Recording (max. 1 hour) Voice Memo in Still Image (max. 10 sec.)
Date Imprinting		Date&Time, Date, Off (user selectable)
Shooting	Still Image	Modes : Auto, Program, A, S, M, MySET, Scene * Scene : Night, Portrait, Children, Landscape, Close-up, Text, Sunset, Dawn, Backlight, Fireworks, Beach/Snow Shooting : Single, Continuous, AEB, AFB Self-timer : 2 sec., 10 sec., Double, Remote control
	Movie Clip	With audio (recording time : memory capacity dependent) Size : 640x480, 320x240, 160x128 Frame rate : 30 fps, 15 fps

Specifications

Storage	Media	SD : up to 1GB guaranteed (MMC Compatible)
	File Format	Still Image : JPEG (DCF), EXIF 2.2, DPOF 1.1, PictBridge 1.0 Movie Clip : AVI (MPEG-4) Audio : WAV
	Image Size	3072 : 3072x2304pixels, 2816 : 2816x2112pixels, 2592 : 2592x1944pixels, 2272 : 2272x1704pixels, 2048 : 2048x1536pixels, 1600 : 1600x1200pixels, 1024 : 1024x768pixels, 640 : 640x480pixels
	Capacity (32MB)	3072 : Super fine 9 Fine 15 Normal 23 TIFF 1 2816 : Super fine 10 Fine 18 Normal 26 TIFF 1 2592 : Super fine 11 Fine 21 Normal 33 TIFF 1 2272 : Super fine 14 Fine 26 Normal 40 TIFF 2 2048 : Super fine 17 Fine 33 Normal 50 TIFF 3 1600 : Super fine 30 Fine 51 Normal 60 TIFF 4 1024 : Super fine 60 Fine 106 Normal 129 TIFF 11 640 : Super fine 121 Fine 165 Normal 202 TIFF 22 * These figures are measured under Samsung's standard conditions and may vary depending on shooting conditions and camera settings.
Image Play	Type	Single image, Thumbnails, Slide show, Album organisation, Movie clip
	Editing	Trimming, Resizing, Rotating
Interface		Digital output connector : USB 2.0 Audio : Mono Video output : NTSC, PAL (user selectable) DC power input connector : 3.3V
Power Source		Rechargeable battery : Li-ion SLB-1137 (3.7V, 1,130mAh) AC Adapter : SAC - 32(DC 3.3V, 2.0A)
Dimensions (W x H x D)		105 x 56.5 x 29.5 mm(excluding the projecting parts of the camera)
Weight		Approx. 150g (without batteries and card)
Operating Temperature		0 ~ 40°C
Operating Humidity		5 ~ 85%
Software	Camera Driver	Storage Driver (Windows98/98SE/2000/ME/XP, Mac OS 9.2 ~ 10.3)
	Application	Digimax Viewer, Digimax Reader, Arcsoft Photolmpression
Special Features		MPEG-4 VGA 30fps Movie Clip Text recognition(Digimax Reader included) A World Superior Schneider Lens

* Specifications are subject to change without prior notice.

* All trademarks are the property of their respective owners.

Software Notes

Please ensure that you read the instruction manual carefully before use.

- . The attached software is a camera driver and image editing software tool for Windows.
- . Under no circumstances should all or part of either the software or the user manual be reproduced.
- . Copyrights for software are licensed only for use with a camera.
- . In the unlikely event of a manufacturing fault, we will repair or exchange your camera. We cannot, however, be held responsible in any way for damage caused by inappropriate use.
- . Using a Hand-made PC or a PC and OS that has not been guaranteed by the manufacturer is not covered by the Samsung warranty.
- . Before reading this manual, you should have a basic knowledge of computers and O/S (Operating Systems).

System Requirements

For Windows	For Macintosh
PC with processor better than MMX Pentium 233MHz (XP : Pentium II 300MHz)	Power Mac G3 or later
Windows 98/98SE/2000/ME/XP	Mac OS 9.2 ~ 10.3
Minimum 32MB RAM (XP : 128MB) 140MB of available hard-disk space	Minimum 64MB RAM 110MB of available hard-disk space
USB port	USB port
CD-ROM drive	CD-ROM drive
800x600 pixels, 16-bit colour display compatible monitor (24-bit color display recommended)	QuickTime player DivX(for movie clip)

About the software

After inserting the software CD provided with this camera into the CD-ROM drive, the following window should automatically run.



Before connecting the camera to the PC, you should first install the camera driver.

■ **Camera driver : This enables images to transfer between the camera and PC.**

This camera uses the USB Storage Driver as the camera driver. You can use the camera as a USB card reader. After installing the driver and connecting this camera to the PC, you can find [Removable Disk] in [Windows Explorer] or [My computer]. A USB Storage Driver is provided only for Windows. A USB Driver for MAC is not included with the Application CD. But you can use the camera with Mac OS 9.2 ~ 10.3.

■ **XviD codec : This makes movie clips(MPEG-4) recorded with this camera play back on a PC.**

To play back a movie clip recorded with this camera, you must install the XviD codec. If a movie clip recorded with this camera does not play well, install this code. This software is only compatible with Windows.

If a movie clip can't play back on the Mac OS, please visit the following site.

<http://www.divx.com/divx/mac/>

■ **Digimax Viewer : This is a program for viewing stored images.**

You can see the stored images in the memory directly on a PC monitor. You can also copy, move or delete the images and enlarge/downscale the image sizes with Digimax Viewer.

This software is only compatible with Windows.

About the software

■ Digimax Reader : Text recognition program

You can save an image file that was captured in the TEXT mode as a text file with this program. This software is only compatible with Windows.

■ PhotoImpression : Image editing program.

You can edit or store still images that you download from the camera. This software is only compatible with Windows.

INFORMATION

- Be sure to check the system requirements before installing the driver.
- You should allow 5~10 seconds for running the automatic setup program according to the capability of the computer. If the frame does not show, run the [Windows Explorer] and select [Samsung.exe] in the CD-ROM Drive root directory.

Setting up the application software

To use this camera with a PC, install the application software first.

After this has been done, the stored images in the camera can be moved to the PC and can be edited by an image editing program.

INFORMATION

- Close other programs before installing the application software.
- Before installing the application software, disconnect the USB connection.

You can visit the Samsung web-site through the internet.

<http://www.samsungcamera.com> : English

<http://www.samsungcamera.co.kr> : Korean

1. Click the [Install] menu in the Autorun frame.
The camera driver is installed automatically.

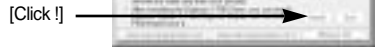

2. Installation is complete.
Click the [Finish] button.



3. A windows to check whether the PC has XviD codec or not will display.

[Preview] : You can check the movie clip display condition.

[Install] : The XviD codec is installed.

[Cancel] : The XviD codec is not installed and a window for installing the application softwares will display.

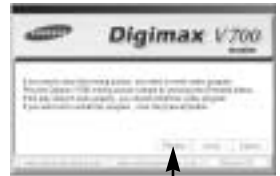

※ If you didn't click the [Preview] button, the [Install] button can't be selected.

Setting up the application software

4. If an error listed below takes place during the preview, click the [Install] button to install the XviD codec.

- Only a voice plays back.
- An error message displays and the movie clip does not play back.

* A window shown alongside may display according to the system requirements.

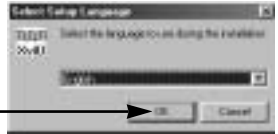

5. The XviD codec installation window will be displayed as shown alongside. Click the [Next(N)>] button.



6. The Software License Agreement window will be displayed. If you agree to this, select [I accept the agreement] and click [Next>] button. the window will then move to the next step. If you disagree, select [I do not accept the agreement] and click [Cancel] button. The installation program will be cancelled.



※ The XviD codec is distributed according to the GNU General Public License and everyone can copy, distribute and change this codec. For more information, see the License documents.

Setting up the application software

7. The XviD information window will display.
Click the [Next>] button.



8. The destination selection window will open.
Click [Next >] button.
To copy the files to another folder, click [Browse...]
and choose a folder you want.



9. A window will open, asking you to choose a folder to
which program icons will be added.
Click [Next >] button.
If you want to add the program icons to a different folder,
choose another folder, and then click [Next >] button.



10. The [Select Additional Tasks] window will display.
Select the additional tasks and click the [Next>] button.



Setting up the application software

11. The XviD codec is ready to install.

Click the [Install] button.



12. Installation is complete.

Click the [Finish] button.



13. A window where you can choose the program you want to install will appear. Click [Install].

For information on application software, please refer to page 108.



INFORMATION

- If you select [Exit] at step 13, the application program installation will be cancelled.

14. The [Digimax Viewer 2.1] installation window will be displayed as shown alongside.

Click the [Next] button.



Setting up the application software

INFORMATION

- If you select [Cancel] at step 14, a window for installing Digimax Reader will be displayed.

15. The Software License Agreement window will be displayed.

If you agree to this, click [Yes], the window will then move to the next step.

If you disagree, click [No] and the installation program will be canceled.

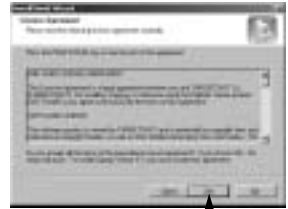

[Click !]

16. A destination selection window will open.

Click [Next >].

To copy to the files to another folder, click [Browse..] and choose a folder you want.



[Click !]

17. A window will open, asking you to choose a folder to which program icons will be added.

Click [Next >] button.

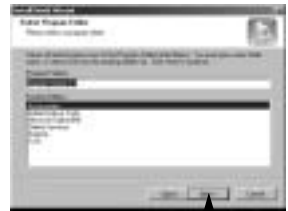

[Click !]

18. Digimax Viewer installation is successfully completed.

Click the [Finish] button to install Digimax Reader.

* The system will not reboot even the [Yes, I want to restart the computer now] option is selected.

* The real frame 18 can be different with the illustration according to the system requirements.



[Click !]

Setting up the application software

19. A window will be displayed as shown alongside.
Click the [INSTALL] button.

- Check the [MANUAL] button. Instructions for using Digimax reader will be displayed.
- Click the [EXIT] button and Digimax reader installation will be cancelled and a window for installing PhotoImpression will be displayed.



[Click !]

20. A window will open.
Click the [Next(N)>] button.



[Click !]

21. The Software License Agreement window will be displayed. If you agree to this, click [Yes], the window will then move to the next step. If you disagree, click [No] and the installation program will be cancelled.



[Click !]

22. A destination selection window will open.
Click [Next >].
To copy to the files to another folder, click [Browse...] and choose a folder you want.



[Click !]

Setting up the application software

23. Digimax Reader Installation is completed.
Click the [Finish] button and PhotoImpression installation will be started. The system will not reboot even if the [Yes, I want to restart the computer now] option is selected.



*The real frame 23 can be different with the illustration according to the system requirements.

24. The PhotoImpression installation window will be displayed as shown alongside.
Click the [OK] button.



25. A Welcome window will be displayed.
Click the [Next >] button.



26. The Software License Agreement window will be displayed.
If you agree to this, click [Yes], the window will then move to the next step.
If you disagree, click [No] and the installation program will be canceled.

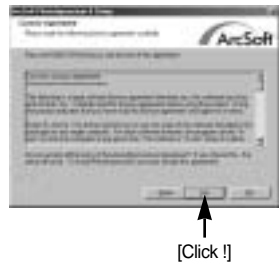

Setting up the application software

27. A destination selection window will open.

Click [Next >].

To copy to the files to another folder, click [Browse...] and choose a folder you want.



[Click !]

28. The [Select Components] window will appear.

Click [Next >] button.



[Click !]

29. A window will open, asking you to choose a folder to which program icons will be added.

Click [Next >] button.

If you want to add the program icons to a different folder, choose another folder, and then click [Next >] button.



[Click !]

30. PhotoImpression Installation is completed.

Click the [Finish] button.

* The system will not reboot even if the [Yes, I want to restart the computer now] option is selected.

* The real frame 30 can be different with the illustration according to the system requirements.



[Click !]

Setting up the application software

31. To apply changes, you must restart the computer.
Select [Yes, I want to restart my computer now], and then click [Finish].



[Click !]

32. After restarting the computer, connect the PC to the camera with the USB cable.

33. Turn the camera power on.
[Found New Hardware Wizard] will open and the computer will recognise the camera.

* If you have ever installed an image viewer program or your OS is Windows XP, an image viewer program will open.

If the image viewer program opens, the camera driver was setup successfully.



34. If you can see [Removable Disk] under [My computer], the camera driver installation was successful.

Now you can transfer image files from the camera to PC via the USB cable.



Setting up the application software

INFORMATION

- If you have installed the camera driver, [Found New Hardware Wizard] may not open.
- On a Windows 98 or 98 SE system, the Found New Hardware Wizard dialog box opens and a window asking you to select a driver file may appear. In this case, specify "USB Driver" in the CD supplied. (for Windows 98 and 98 SE).
- Before connecting the camera to the PC, You should first install the camera driver.
- After installing the camera driver, you have to restart your PC.
- If you connect the camera to the PC before installing the camera driver, the [Found New Hardware Wizard] will open.
In this case, cancel the [Found New Hardware Wizard] and disconnect the camera. Install the camera driver and connect the camera to the PC again.
- Should the computer not find the camera driver after installation, please try one or more of the following measures.
 1. Delete the camera driver (p.123), and re-install the driver.
 2. Refer to FAQ (p.132) to check for a possible solution to the problem.
 3. If your PC's central processing unit is VIA chip (This is shown in the USB Host Controller), download the patch file from the Samsung Camera web page. (<http://www.samsungcamera.com>)

Starting PC mode

- If you connect the USB cable to a USB port on your PC and then turn on the power, the camera will automatically switch to "computer connection mode".
- In this mode, you can download stored images to your PC through the USB cable.
- The LCD monitor is always turned off in PC mode.
- The auto focus lamp will blink when the files are transferring via the USB connection.

■ Connecting the camera to a PC

1. Turn the PC power on.
2. Turn the camera power on.
3. In any mode other than Voice Recording mode, press the MENU button.
4. Press the LEFT/ RIGHT button and select the [Setup] menu tab.
5. Select the [USB] menu by pressing the UP/ DOWN button and press the RIGHT button.
6. Use the UP and DOWN buttons to select [Computer], and then press the OK button.
7. Press the menu button twice and the menu will disappear.
8. Connect the PC and the camera via the USB cable.
 - Insert the small plug of the USB cable into the camera USB connection terminal.
 - Insert the large connector of the USB cable into the USB port of the PC.
 - The plugs must be firmly inserted.

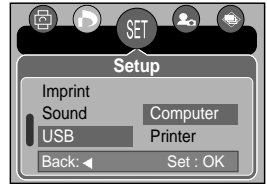

- ※ If you selected [Printer] in Step 6, when you connect the camera to your computer, the [Connecting Printer] message will be displayed on the LCD monitor and the connection will not be established. In this case, disconnect the USB cable, and then follow the procedure from Step 3 and onward.

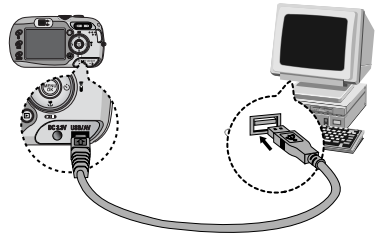

- Disconnecting the camera and PC : Refer to page 125 (Removing the removable disk).

INFORMATION

- The camera driver must be installed before using PC mode.
- To save battery power, it is recommended that you use an AC adapter (Optional) when connecting the camera to a computer.

Starting PC mode

■ Downloading stored images

You can download the still images stored on the camera to your PC's hard disk and print them or use a photo editing software to edit them.

1. Connect the camera to your PC with the USB cable.

2. On your computer's desktop display, select [My computer] and double click [Removable Disk → DCIM → 100SSCAM].

The image files will then be displayed.



3. Select an image and press the right mouse button.



4. A pop-up menu will open.

Click [Cut] or [Copy] menu.

- [Cut] : cuts a selected file.

- [Copy] : copies files.



5. Click a folder where you want to paste the file.

Starting PC Mode

6. Press the right mouse button and a pop-up menu will open. Click [Paste].



7. An image file is transferred from the camera to your PC.



- By using [Digimax Viewer], you can see the stored images in the memory directly on the PC monitor and you can copy or move the image files.

Removing the USB Driver for Windows 98SE

■ To remove the USB driver, refer to the process shown below.

1. Trace [Start → Settings] and click [Control Panel].



2. Double-click [Add/Remove programs].

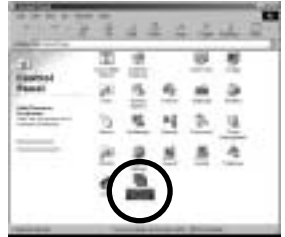

3. The [Add/Remove Programs Properties] window will open.
Click [Digimax V700] and click the [Add/Remove] button.



4. Uninstallation is complete.
Click the [Finish] button and the window will disappear.



Removable Disk

■ To use this camera as a Removable Disk, install (p.110) the USB Driver.

1. Before turning the camera power on, connect the camera to the PC with the USB cable.
2. Click [Removable Disk] under [My computer] or [Windows Explorer].
3. Image files stored in the Removable Disk (DCIM →100SSCAM) can be transferred to the PC.

INFORMATION

Important information whilst using the Removable Disk

- The [Removable Disk] indicator will not show when the camera power is off or the USB cable is removed.
- We recommend that you should copy the images to the PC to view them. Opening images directly from the removable disk may be subject to unexpected disconnection.
- When uploading images from the PC to the camera, ensure that the uploaded file names are not the same as those already stored on the memory.
- When you upload a file that is not taken by this camera to Removable Disk, the [File Error!] message will be displayed on the LCD monitor in the PLAY mode, and nothing is displayed in THUMBNAIL mode.
- The auto focus lamp will blink, when a file is transferred (copy or deletion) between the PC and the camera. Do not remove the USB cable until the lamp stops blinking. To remove the USB cable in Windows 2000/ME/XP, use the [Unplug or Eject Hardware] icon on the task bar.



Removing the removable disk

■ Windows 98/98SE

1. Check whether the camera and PC are transferring a file. If the auto focus lamp blinks, you have to wait until the lamp is turned off.
2. Unplug the USB cable.

■ Windows 2000/ME/XP

(The illustrations may be different from the real display in accordance with the Windows O/S.)

1. Check whether the camera and PC are transferring a file. If the auto focus lamp blinks, you have to wait until the lamp is turned off.

2. Double-click the [Unplug or Eject Hardware] icon on the task bar.



[Double-click!]

3. The [Unplug or Eject Hardware] window will open. Select the [USB Mass Storage Device] and click the [Stop] button.



[Click!]

4. The [Stop a Hardware device] window will open. Select the [USB Mass Storage Device] and click the [OK] button.

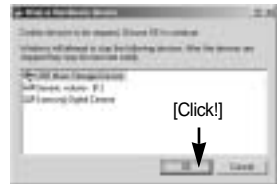

[Click!]

5. A [Safe to Remove Hardware] window will open. Click the [OK] button.



[Click!]

Removing the removable disk

6. A [Unplug or Eject Hardware] window will open.
Click the [Close] button and the removable disk will be removed safely.



7. Unplug the USB cable.

[Click!]

Setting up the USB Driver for MAC

1. A USB Driver for MAC is not included with the software CD as MAC OS supports the camera driver.
2. Check the MAC OS. You can check the MAC OS version during MAC OS start-up. This camera is compatible with MAC OS 9.2 ~ 10.3.
3. Connect the camera to the Macintosh and turn the camera power on.
4. A new icon will be displayed on the desktop after connecting the camera to the MAC.

Using the USB Driver for MAC

1. Double click a new icon on the desktop and the folder in the memory will be displayed.
2. Select an image file and copy or move it to MAC.

CAUTION

- For Mac OS 10.0 or later : First complete uploading from computer to camera and then remove the removable disk with the Extract command.
- If a movie clip can't play back on the Mac OS, please visit the following site.
<http://www.divx.com/divx/mac/>

Digimax Viewer 2.1

■ This software is only compatible with Windows.

1. To open Digimax Viewer, click the [Start → Programs → Samsung → Digimax Viewer 2.1 → Digimax Viewer 2.1] and Digimax Viewer 2.1 will then open.



2. If the [Auto Launch] option is selected, this program will be executed automatically with recognizing the camera.



3. You can easily use the Digimax viewer 2.1 program as it offers a FILE menu and TOOL bar. And, you can use the pop up menu. Click an image and press the right mouse button.



Digimax Viewer functions are listed below.

- Basic functions : Copy, Move, Delete, Rotate, Rename, changing file type, Resize, Property.
- Advanced functions : Print, Slide show, Export, Sending e-mail, On-line print, Web album etc.

INFORMATION

- Before deleting images from the camera, you should download images to your computer that you wish to keep.
- Refer to the [Help] menu in Digimax viewer 2.1 for further information.

Digimax Reader

- Digimax Reader is a Text recognition program. You can save an image file that is captured in the Text mode, as a text file with this program.
This software is only compatible with Windows.
- To start the program, click [Start → Programs → Digimax Reader Eng].
The following screen will appear.

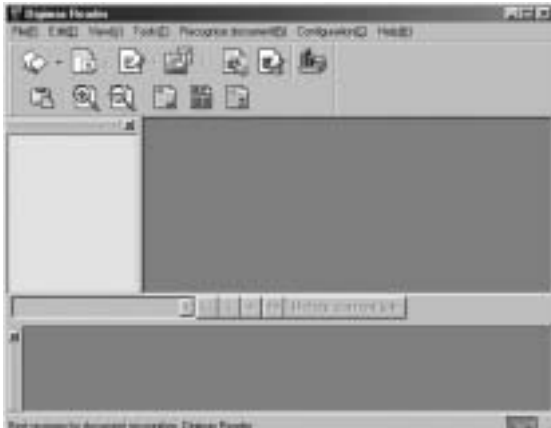

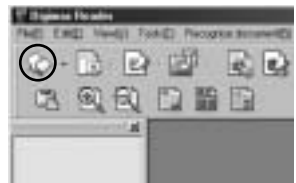

- How to use the Digimax Reader
 1. Connect the camera and the PC with a USB cable and download the images that were stored in the camera to the PC.
* Please see page 120 ~ 122 for details on Connecting a camera and PC, Downloading images.
 2. Run the Digimax Reader.
 3. Click the Open () icon as shown alongside.

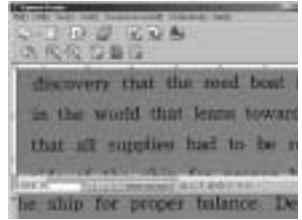

Digimax Reader

4. Select the image you want to save as a text file.
* Only an image that was taken with SAMSUNG camera can be opened.



5. Click the Area Analysis() icon to scan the image.



6. Part of the image you selected will be displayed as shown.

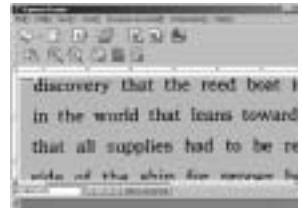

7. Click the Character Recognition() icon. The part selected in the previous step will be recognized as text.

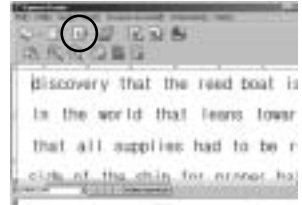

8. To save the section as a text, click the Save() icon. A window as shown alongside will be displayed.



Digimax Reader

9. Select a file type that you want to.

Selectable file type : *.TXT, *.HWP, *.DOC, *.RTF

INFORMATION

- To get an image that can be recognized as a text :
 - Keep a distance of 20cm between the subject and the camera.
 - The subject need to be centered.
 - Avoid the camera shake to get a good image.
- Refer to the [Help] menu in Digimax Reader for further information.

Using PhotoImpression

· With PhotoImpression, you can edit or store still images that you downloaded from the camera. This software is only available in Windows version.

· To start the program, click [Start → Programs → ArcSoft PhotoImpression 4 → PhotoImpression 4]. The following screen will appear.

[Help Button]

[Command Button]







[Tool Bar]











Using Photolmpression

· You can use Photolmpression to perform the following tasks.

■ Command Button

Button	Description
	Imports a picture from an album, a source folder, or the camera/scanner, or captures screen shots of what is being viewed on the current monitor.
	Selects Cut, Resize, Edit Image, Insert Text, Enhance Picture, Insert Effects, or Layer.
	Performs Insert Frame, Insert Borders, Insert Calendar, Insert Greeting Cards, Insert Template, or Connect with Other Software.
	Saves the edited picture, and sends an e-mail or uses it as the background image.
	Outputs the edited picture according to your preferences.

■ Tool Bar

Button	Description	Button	Description
	Resize Layer		Rotate Layer
	Flip Layer Horizontally		Rotate All Layers
	Undo		Redo
	Copy		Paste
	Delete Layer		Close Picture

INFORMATION

- For detailed instructions on how to use Photolmpression, please refer to the program's Help.

FAQ

■ Please check the following if the USB connection malfunctions.

[Case 1]

The camera power is off.

- Turn the camera power on. We recommend using an AC power adapter in PC mode.

[Case 2]

USB Driver is not installed correctly.

- Install the USB Driver correctly. Refer to page 110.

[Case 3]

The USB cable is not connected or you are using a cable with an incorrect specification.

- Use a USB cable with the correct specification.

[Case 4]

The camera is not recognized by your PC.

Sometimes, the camera may appear under [Unknown Devices] in Device Manager.

- Install the camera driver correctly.
Turn off the camera, remove the USB cable, plug in the USB cable again, and then turn on the camera.

[Case 5]

There is an unexpected error during file transfer

- Turn the camera power off and on again. Transfer the file again.

[Case 6]

How do I know my computer supports a USB Interface?

- Check the USB port in your computer or keyboard.
- Check the OS version. A USB Interface is available in Windows 98, 98SE, 2000, ME .XP.
- Check [Universal Serial Bus controllers] in Device Manager. Do the following to check [Universal Serial Bus controllers].
 - Win 98/ME : Trace [Start → Settings → Control Panel → System → Device Manager → Universal Serial Bus controllers].
 - Win 2000 : Trace [Start → Settings → Control Panel → System → Hardware → Device Manager → Universal Serial Bus controllers].
 - Win XP : Trace [Start → Control Panel → Performance and Maintenance → System → Hardware → Device Manager → Universal Serial Bus controllers].

FAQ

There must be USB Host Controller and USB root hub under [Universal Serial Bus controllers].

In addition, double-click on the USB Universal Host Controller and the USB Root Hub to check if the Device Status states "This device is working properly". If the Device Status says the device is "not working properly", click the "Driver" tab and then click [Update Driver] or [Reinstall Driver].

- When all the conditions mentioned above are met, the computer can support the USB interface.

[Case 7]

When using the USB hub.

- There may be a problem in connecting the camera to the PC through the USB hub if the PC and the hub are not compatible. Wherever possible, connect the camera to the PC directly.

[Case 8]

Are other USB cables connected to the PC?

- The camera may malfunction when it is connected to the PC at the same time as another USB cable. In this case, disconnect the other USB cable, and connect only one USB cable to the camera.

[Case 9]

When I open the Device Manager (by clicking Start → (Settings) → Control Panel → (Performance and Maintenance) → System → (Hardware) → Device Manager), there are 「Unknown Devices」 or 「Other Devices」 entries with a yellow question mark(?) beside them or devices with an exclamation mark(!) beside them.

- Right-click on the entry with the question(?) or exclamation (!) mark and select "Remove". Restart the PC and connect the camera the again. For Windows 98 PC, remove the camera driver also, restart the PC, and then reinstall the camera driver.
- Double-click on the entry with the question (?) or exclamation (!) mark, click the "Driver" tab, and click [Update Driver] or [Reinstall Driver]. If a message appears asking you to specify the location of the appropriate device driver, specify "USB Driver" in the CD supplied.

FAQ

■ When the movie clip doesn't play back on the PC

※When the movie clip recorded by the camera doesn't play back on the PC, the causes are mostly codec installed on the PC.

●When A codec for play back the movie clip isn't installed

→ Install the codec as listed below.

[Installing a codec for Windows]

- 1) Insert the CD provided with the camera
- 2) Run the windows explorer and select [CD-ROM drive:\Xvid] folder and click the Xvid-1.0.2.exe file.

[Installing a codec for Mac OS]

- 1) Visit the following site for downloading the codec.<http://www.divx.com/divx/mac>
- 2) Click the [Free Download] button located upper right side of the page and a window for downloading the DivX codec will display.
- 3) Select Mac OS you use and click the [Download] button. Save it on a folder you want to.
- 4) Run the downloaded file and the codec for playing back the movie clip will be installed.

● When the DirectX 8.1 or later is not installed

→ Install the DirectX 8.1 or later

- 1) Insert the CD provided with the camera
- 2) Run the windows explorer and select [CD-ROM drive:\ USB Driver\DirectX 8.1] folder and click the DXSETUP.exe file. The DirectX will be installed. Visit the following site for downloading the DirectX.<http://www.microsoft.com/directx>

FAQ

● **If a PC (Windows 98) stops responding while the camera and PC are connected repeatedly**

→ If a PC (Windows 98) is turned on for a long time and connect the camera repeatedly, the PC may not recognise the camera. In this case, re-start the PC.

● **If a PC connected with the camera stops responding while the Windows is starting.**

→ In this case, disconnect the PC and the camera and the windows will start correctly.

If the problem happens continuously, set the Legacy USB Support to disable and re-start the PC. The Legacy USB Support is in the BIOS setup menu. (The BIOS setup menu differs from the PC manufacturers and some BIOS menus don't have Legacy USB Support) If you can't change the menu by yourself, contact to the PC manufacturer or BIOS manufacturer.

● **If the movie clip can't be deleted, removable disk can't be extracted or an error message displays during the file transfer.**

→ If you install only the Digimax Viewer, the problems mentioned above occasionally happen.

- Close the Digimax Viewer program by clicking the Digimax Viewer icon on the Taskbar.
- Install all the application programs included in the software CD. (You must install the Movie clip codec)



SAMSUNG

SAMSUNG TECHWIN CO., LTD.
OPTICS & DIGITAL IMAGING DIVISION
145-3, SANGDAEWON 1-DONG, JUNGWONGU,
SUNGNAM-CITY, KYUNGKI-DO, KOREA
462-121
TEL : (82) 31-740-8086,8088, 8090, 8092, 8099
FAX : (82) 31-740-8398, 8111
www.samsungcamera.com

SAMSUNG OPTO-ELECTRONICS AMERICA, INC.
HEADQUARTERS
40 SEAVIEW DRIVE, SECAUCUS, NJ07094, U.S.A.
TEL : (1) 201-902-0347
FAX : (1) 201-902-9342

WESTERN REGIONAL OFFICE
18600 BROADWICK ST.,
RANCHO DOMINGUEZ, CA 90220, U.S.A.
TEL : (1) 310-900-5263/5264
FAX : (1) 310-537-1566
www.samsungcamerausa.com

SAMSUNG OPTO-ELECTRONICS UK LIMITED
SAMSUNG HOUSE
1000 HILLSWOOD DRIVE
HILLSWOOD BUSINESS PARK
CHERTSEY KT16 OPS U.K.
TEL : 00800 12263727
(free for calls from UK only)
SERVICE HOTLINE : 01932455320
www.samsungcamera.co.uk

SAMSUNG OPTO-ELECTRONICS GMBH
AM KRONBERGER HANG 6
D-65824 SCHWALBACH/TS., GERMANY
TEL : (49) 6196 66 53 03
FAX : (49) 6196 66 53 66
www.samsungcameras.de

SAMSUNG FRANCE S.A.S.
BP 51 TOUR MAINE MONTPARNASSE
33, AV. DU MAINE
75755, PARIS CEDEX 15, FRANCE
HOTLINE PHOTO NUMÉRIQUE :
00 800 22 26 37 27 (Numéro Vert-Appel Gratuit)
TEL : (33) 1-4279-2200
FAX : (33) 1-4538-6858
www.samsungphoto.fr

SAMSUNG TECHWIN MOSCOW OFFICE
RUSSIA, 125167, MOSCOW LENNINGRADSKY,
PR-KT, 37-A, KORP14
TEL : (7) 095-258-9299/96/98
FAX : (7) 095-258-9297
<http://www.samsungcamera.ru>

TIANJIN SAMSUNG OPTO-ELECTRONICS CO.,LTD.
7 PINGCHANG ROAD NANKAI DIST., TIANJIN
P.R.CHINA
POST CODE:300190
TEL : (86) 22-2761-8867
FAX : (86) 22-2761-8864
www.samsungcamera.com.cn

* Internet address - <http://www.samsungcamera.com/>



The CE Mark is a Directive conformity
mark of the European Community (EC)

6806-2500

Free Manuals Download Website

<http://myh66.com>

<http://usermanuals.us>

<http://www.somanuals.com>

<http://www.4manuals.cc>

<http://www.manual-lib.com>

<http://www.404manual.com>

<http://www.luxmanual.com>

<http://aubethermostatmanual.com>

Golf course search by state

<http://golfingnear.com>

Email search by domain

<http://emailbydomain.com>

Auto manuals search

<http://auto.somanuals.com>

TV manuals search

<http://tv.somanuals.com>