



SAMSUNG

User Manual

TL500

This user manual includes detailed usage instructions for your camera. Please read this manual thoroughly.

 [Click a topic](#)

Common questions

Quick reference

Contents

Basic functions

Extended functions

Shooting options

Playback/Editing

Appendixes

Index

Health and safety information

Always comply with the following precautions and usage tips to avoid dangerous situations and ensure peak performance of your camera.



Warning—situations that could cause injury to yourself or others



Caution—situations that could cause damage to your camera or other equipment



Note—notes, usage tips, or additional information



Safety warnings

Do not use your camera near flammable or explosive gases and liquids

Do not use your camera near fuels, combustibles, or flammable chemicals. Do not store or carry flammable liquids, gases, or explosive materials in the same compartment as the camera or its accessories.

Keep your camera away from small children and pets

Keep your camera and all accessories out of the reach of small children and animals. Small parts may cause choking or serious injury if swallowed. Moving parts and accessories may present physical dangers as well.

Prevent damage to subjects' eyesight

Do not use the flash in close proximity (closer than 1 m/3 ft) to people or animals. Using the flash too close to your subject's eyes can cause temporary or permanent damage.

Handle and dispose of batteries and chargers with care

- Use only Samsung-approved batteries and chargers. Incompatible batteries and chargers can cause serious injuries or damage to your camera.
- Never dispose of batteries in a fire. Follow all local regulations when disposing of used batteries.
- Never place batteries or cameras on or in heating devices, such as microwave ovens, stoves, or radiators. Batteries may explode when overheated.
- Do not use a damaged power supply cord, plug, or loose outlet when charging batteries. This may cause a fire or electric shock.



CAUTION

Safety precautions

Handle and store your camera carefully and sensibly

- Do not allow your camera to get wet—liquids can cause serious damage. Do not handle your camera with wet hands. Water damage to your camera can void your manufacturer's warranty.
- Do not expose the camera to direct sunlight or high temperatures for an extended period of time. Prolonged exposure to sunlight or extreme temperatures can cause permanent damage to your camera's internal components.
- Avoid using or storing your camera in dusty, dirty, humid, or poorly-ventilated areas to prevent damage to moving parts and internal components.
- Remove the batteries from your camera when storing it for an extended period of time. Installed batteries may leak or corrode over time and cause serious damage to your camera.
- Protect your camera from sand and dirt when using it on beaches or in other similar areas.
- Protect your camera from impact, rough handling, and excessive vibration to avoid serious damage.
- Exercise caution when connecting cables or adapters and installing batteries and memory cards. Forcing the connectors, improperly connecting cables, or improperly installing batteries and memory cards can damage ports, connectors, and accessories.
- Do not insert foreign objects into any of your camera's compartments, slots, or access points. Damage due to improper use may not be covered by your warranty.
- Do not swing your camera by the strap. This may cause injury to yourself or others.
- Do not paint your camera, as paint can clog moving parts and prevent proper operation.
- Paint or metal on the outside of the camera may cause allergies, itchy skin, eczema, or swelling for people with sensitive skin. If you have experience any of these symptoms, stop using the camera immediately and consult a doctor.

Protect batteries, chargers, and memory cards from damage

- Avoid exposing batteries or memory cards to very cold or very hot temperatures (below 0° C/32° F or above 40° C/104° F). Extreme temperatures can reduce the charging capacity of your batteries and can cause memory cards to malfunction.
- Prevent batteries from making contact with metal objects, as this can create a connection between the + and – terminals of your battery and lead to temporary or permanent battery damage. Also, this may cause a fire or electric shock.
- Prevent memory cards from making contact with liquids, dirt, or foreign substances. If dirty, wipe the memory card clean with a soft cloth before inserting in your camera.
- Do not allow liquids, dirt, or foreign substances to come in contact with the memory card slot. Doing so may cause the camera to malfunction.
- Turn off the camera when inserting or removing the memory card.
- Do not bend, drop, or subject memory cards to heavy impact or pressure.
- Do not use memory cards that have been formatted by other cameras or by a computer. Reformat the memory card with your camera.
- Never use a damaged charger, battery, or memory card.

Use only Samsung-approved accessories

Using incompatible accessories may damage your camera, cause injury, or void your warranty.

Protect your camera's lens

- Do not expose the lens to direct sunlight, as this may discolor the image sensor or cause it to malfunction.
- Protect your lens from fingerprints and scratches. Clean your lens with a soft, clean, debris-free lens cloth.



Important usage information

Allow only qualified personnel to service your camera

Do not allow unqualified personnel to service the camera or attempt to service the camera yourself. Any damage that results from unqualified service is not covered by your warranty.

Ensure maximum battery and charger life

- Overcharging batteries may shorten battery life. After charging is finished, disconnect the cable from your camera.
- Over time, unused batteries will discharge and must be recharged before use.
- Disconnect chargers from power sources when not in use.
- Use batteries only for their intended purpose.

Exercise caution when using the camera in humid environments

When transferring the camera from a cold environment to a warm and humid one, condensation can form on the delicate electronic circuitry and memory card. In this situation, wait for at least 1 hour until all moisture has evaporated before using the camera.

Check that the camera is operating properly before use

The manufacturer takes no responsibility for any loss of files or damage that may result from camera malfunction or improper use.

Copyright information

- Microsoft Windows and the Windows logo are registered trademarks of the Microsoft Corporation.
- Mac is a registered trademark of the Apple Corporation.
- HDMI, the HDMI logo and the term "High Definition Multimedia Interface" are trademarks or registered trademarks of HDMI Licensing LLC.

- Camera specifications or contents of this manual may be changed without prior notice due to upgrade of camera functions.
- For Open Source License information, refer to the "OpenSourceInfo.pdf" in the provided CD-ROM.

Organization of the user manual

Basic functions 13

Learn about your camera's layout, icons, and basic functions for shooting.

Extended functions 32

Learn how to take a photo by selecting a mode and how to record a video or voice memo.

Shooting options 46

Learn about the options you can set in Shooting mode.



Playback/Editing 75

Learn how to play back photos, videos, or voice memos and edit photos or videos. Also, learn how to connect your camera to your computer, photo printer, TV, or HDTV.

Appendixes 102

Refer to settings, error messages, specifications, and maintenance tips.

Indications used in this manual

Shooting mode	Indication
Smart Auto	
Program	P
Aperture Priority	A
Shutter Priority	S
Manual	M
DUAL IS	
Scene	SCN
Movie	

Shooting mode icons

These icons indicate that a function is available in the corresponding modes. The **SCN** mode may not support functions for all scenes.

For example:

Adjusting the exposure manually (EV)

P A S 





Depending on the intensity of the ambient light, your photos may be too bright or dark. In these cases, you can adjust the exposure to get a better photo.



Darker (-) Neutral (0) Brighter (+)

Available in the Program, Aperture Priority, Shutter Priority, DUAL IS, and Movie modes

Icons used in this manual

Icon	Function
	Additional information
	Safety warnings and precautions
[]	Camera buttons. For example, [Shutter] represents the shutter button.
()	Page number of related information
→	The order of options or menus you must select to perform a step; for example: Select  → White Balance (represents select  , and then White Balance).
*	Annotation

Abbreviations used in this manual

Abbreviation	Definition
AEL	Auto Exposure Lock
AF	Auto Focus
DIS	Digital Image Stabilization
DPOF	Digital Print Order Format
EV	Exposure Value
OIS	Optical Image Stabilization
WB	White Balance

Expressions used in this manual

Pressing the shutter

- Half-press [**Shutter**]: press the shutter halfway down
- Press [**Shutter**]: press the shutter all the way down

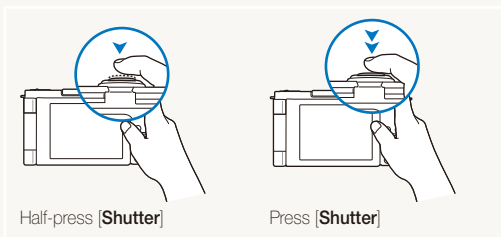

Exposure (Brightness)

The amount of light that enters your camera determines the exposure. You can alter the exposure with shutter speed, aperture value, and ISO speed. By altering the exposure, your photos will be darker or lighter.

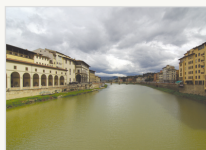

Normal exposure

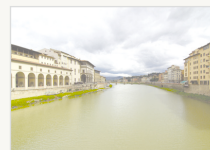

Overexposure (too bright)





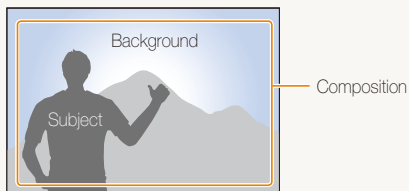







Subject, background, and composition

- **Subject:** the main object of a scene, such as a person, animal, or still life
- **Background:** the objects around the subject
- **Composition:** the combination of a subject and background



Common questions

You can get answers to common questions. Solve problems easily by setting shooting options.

	The subject's eyes appear red.	<p>This is caused by a reflection from the camera flash.</p> <ul style="list-style-type: none">• Set the flash option to  Red-eye or  Red-eye Fix. (p. 52)• If the photo has already been taken, select  Red-eye Fix in the edit menu. (p. 87)
	Photos have dust spots.	<p>Dust particles floating in the air may be captured in photos when using the flash.</p> <ul style="list-style-type: none">• Turn off the flash or avoid taking photos in a dusty place.• Set ISO speed options. (p. 55)
	Photos are blurred.	<p>This may be caused by taking photos in low light conditions or holding the camera incorrectly.</p> <ul style="list-style-type: none">• Press [Shutter] halfway down to make sure the subject is focused. (p. 30)• Use the  DUAL mode. (p. 41)
	Photos are blurred when shooting at night.	<p>As the camera tries to let in more light, the shutter speed slows. This can make it difficult to steady the camera and may result in camera shake.</p> <ul style="list-style-type: none">• Select  Night in the SCN mode. (p. 35)• Turn on the flash. (p. 52)• Set ISO speed options. (p. 55)• Use a tripod to prevent your camera from shaking.
	Subjects come out too dark because of backlighting.	<p>When the light source is behind the subject or when there is a high contrast between the light and dark areas, the subject may come out shaded.</p> <ul style="list-style-type: none">• Avoid shooting in front of the sun.• Select  Backlight in the SCN mode. (p. 35)• Set the flash option to  Fill in. (p. 52)• Adjust the exposure. (p. 65)• Set the metering option to  Spot if a bright subject is in the center of the frame. (p. 66)

Quick reference



Taking photos of people

- **SCN** mode > Beauty Shot, Portrait, Children ▶ 35
- Red-eye, Red-eye Fix (to prevent or correct red-eye) ▶ 52
- Face Detection ▶ 60



Taking photos at night or in the dark

- **SCN** mode > Night, Dawn, Fireworks ▶ 35
- Flash options ▶ 52
- ISO speed (to adjust the sensitivity to light) ▶ 55



Taking action photos

- **S** mode ▶ 50
- Continuous ▶ 50



Taking photos of text, insects, or flowers

- **SCN** mode > Close Up, Text ▶ 35
- Macro, Auto Macro, Manual Focus (to take close-up photos) ▶ 56
- White Balance (to change the color tone) ▶ 67



Adjusting the exposure (brightness)

- WB BKT (to take 3 photos of the same scene with different white balance) ▶ 50
- AE BKT (to take 3 photos of the same scene with different exposure settings) ▶ 50
- ISO speed (to adjust the sensitivity to light) ▶ 55
- EV (to adjust exposure) ▶ 65
- Metering ▶ 66



Applying a different effect

- PSS BKT (to take 9 photos of the same scene with different photo styles) ▶ 50
- Photo styles (to apply tones) ▶ 71
- Smart filter effects ▶ 72
- Image adjustment (to adjust saturation, sharpness, or contrast) ▶ 73



Reducing camera shake

- Optical Image Stabilization (OIS) ▶ 29
- **DUAL** mode ▶ 41

- Viewing files by category in Smart Album ▶ 78
- Deleting all files on the memory card ▶ 80
- Viewing files as a slide show ▶ 81
- Viewing files on a TV or HDTV ▶ 89
- Connecting your camera to a computer ▶ 91
- Adjusting sound and volume ▶ 104
- Adjusting the brightness of the display ▶ 105
- Formatting the memory card ▶ 105
- Changing the display language ▶ 105
- Setting the date and time ▶ 106
- Troubleshooting ▶ 117

Contents

Basic functions	13	Extended functions	32
Unpacking	14	Using the Smart Auto mode	33
Camera layout	15	Using the Scene mode	35
Using the screen	18	Using the Beauty Shot mode	35
Attaching a strap	18	Using the Program mode	37
Attaching a lens cap	19	Using the Aperture Priority, Shutter Priority, or Manual mode	38
Inserting the battery and memory card	20	Using the Aperture Priority mode	39
Charging the battery and turning your camera on	21	Using the Shutter Priority mode	39
Charging the battery	21	Using the Manual mode	40
Turning on your camera	21	Using the DUAL IS mode	41
Performing the initial setup	22	Recording a video	42
Learning icons	23	Using the Smart Scene Detection mode	43
Selecting options	24	Recording voice memos	45
Setting the display and sound	26	Recording a voice memo	45
Changing the information displayed	26	Adding a voice memo to a photo	45
Setting the sound	26		
Taking photos	27		
Zooming	28		
Reducing camera shake (OIS)	29		
Tips for getting a clearer photo	30		

Shooting options	46	Using face detection	60
Selecting a resolution and quality	47	Detecting faces	60
Selecting a resolution	47	Taking a self-portrait shot	61
Selecting image quality	48	Taking a smile shot	61
Using the timer	49	Detecting eye blinking	62
Using burst modes	50	Using smart face recognition	62
Taking continuous photos	50	Registering faces as your favorites (My Star)	63
Taking bracketed photos	51	Adjusting brightness and color	65
Shooting in the dark	52	Adjusting the exposure manually (EV)	65
Preventing red-eye	52	Locking the exposure value	66
Using the flash	52	Changing the metering option	66
Adjusting the ISO speed	55	Selecting a light source (White balance)	67
Changing the camera's focus	56	Improving your photos	71
Using macro	56	Applying photo styles	71
Using auto focus	56	Applying smart filter effects	72
Using selection focus	57	Adjusting your photos	73
Using tracking auto focus	58	Using smart range	74
Adjusting the focus area	59		

Playback/Editing	75
Playing back	76
Starting Playback mode	76
Viewing photos	81
Playing a video	82
Playing voice memos	83
Editing a photo	84
Resizing photos	84
Rotating a photo	84
Applying photo styles	85
Applying smart filter effects	86
Correcting exposure problems	87
Creating a print order (DPOF)	88
Viewing files on a TV or HDTV	89
Transferring files to your computer (for Windows)	91
Transferring files using Intelli-studio	92
Transferring files by connecting the camera as a removable disk	94
Disconnecting the camera (for Windows XP)	95
Transferring files to your computer (for Mac)	96
Using Samsung RAW Converter	97
Installing Samsung RAW Converter	97
Opening Samsung RAW Converter	97
Using the Samsung RAW Converter Interface	98
Editing RAW format files	99
Saving RAW files as JPEG/TIFF formats	100
Printing photos with a photo printer (PictBridge)	101

Appendixes	102
Camera settings menu	103
Accessing the settings menu	103
Sound	104
Display	104
Settings	105
Error messages	108
Camera maintenance	109
Cleaning your camera	109
About memory cards	110
About the battery	111
Using optional accessories	114
Using optional flash units	114
Using an optional conversion lens	115
Using an optional remote control	116
Before contacting a service center	117
Camera specifications	120
FCC notice	124
Index	125

Basic functions

Learn about your camera's layout, icons, and basic functions for shooting.

Unpacking	14
Camera layout	15
Using the screen	18
Attaching a strap	18
Attaching a lens cap	19
Inserting the battery and memory card	20
Charging the battery and turning your camera on	21
Charging the battery	21
Turning on your camera	21
Performing the initial setup	22
Learning icons	23
Selecting options	24
Setting the display and sound	26
Changing the information displayed	26
Setting the sound	26
Taking photos	27
Zooming	28
Reducing camera shake (OIS)	29
Tips for getting a clearer photo	30

Unpacking

Check your product box for the following items.



Camera

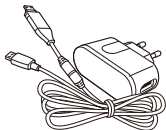

AC adapter/USB cable
(AD44-00143A)/(AD39-00165A)



Software CD-ROM
(User Manual included)
(AD46-00335A)

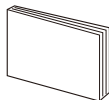

Quick Start Manual
(AD68-04860A)

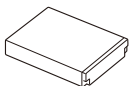

Rechargeable battery
(4302-001226)

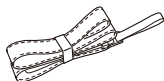

Strap
(AD63-04468A)

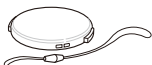

Lens cap/Lens cap strap
(AD97-19036A)/(AD63-02591A)

Optional accessories



Camera case



Conversion lens
(AD97-18678A)

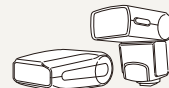

Flash
(AD97-18489A/
AD81-08615A)

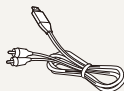

A/V cable
(AD39-00146A)

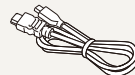

HDMI cable
(AD39-00179A)

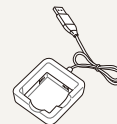

Battery charger
(AD44-00164A)



Remote control
(AD59-00164A)



Memory card



The illustrations may differ from your actual items.

Camera layout

Before you start, familiarize yourself with your camera's parts and their functions.

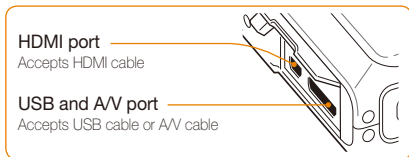
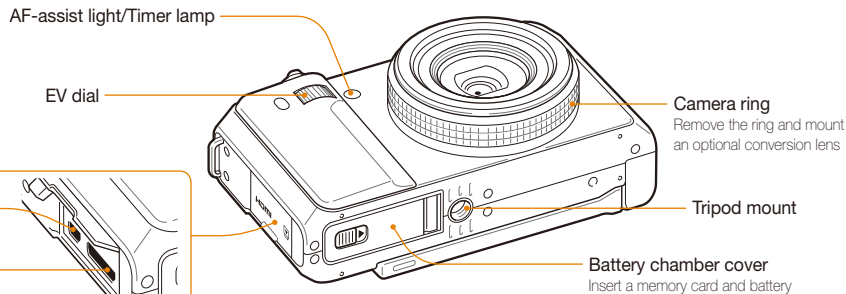
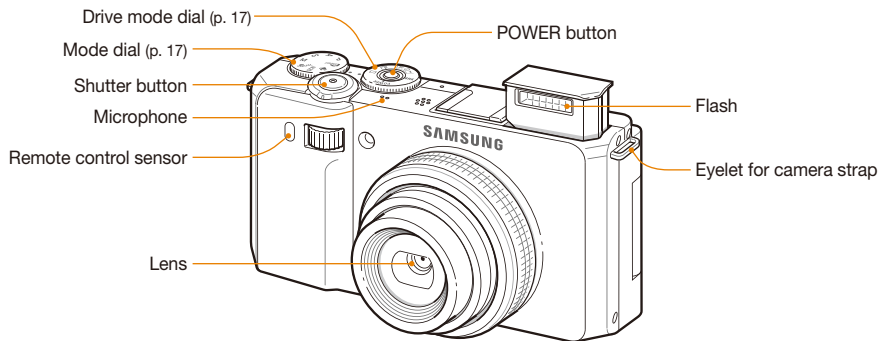

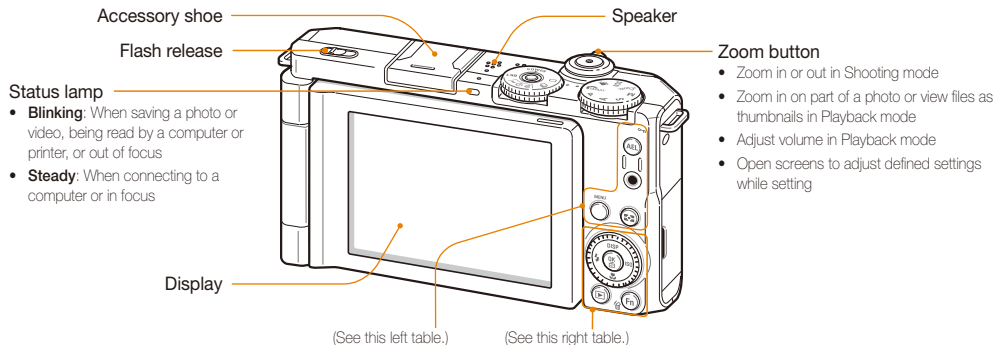







Button	Description
AEL	<ul style="list-style-type: none"> • Lock the adjusted exposure value in Shooting mode. • Protect the displayed file in Playback mode.
Recorder	Start recording a video.
MENU	Access options or menus.
Metering	Change the metering option.

Button	Description		
Navigation	When pressing:		
	In Shooting mode	While setting	
	DISP	Change the display option	Move up
	Change the macro option	Move down	
Change the flash option	Move left		
ISO	Change the ISO option	Move right	
OK	When rotating:		
	Scroll to an option or menu.		
	Adjust aperture value in Shooting mode.		
	Scroll through files in Playback mode.		
Playback	Enter Playback mode.		
Function	Access options in Shooting mode.		
	Delete files in Playback mode.		

Mode dial

Icon	Mode	Description
	Smart Auto	Take a photo by letting the camera select a scene mode it detects.
P	Program	Take a photo by setting options.
A	Aperture Priority	Take a photo by adjusting the aperture value. (The shutter speed is set automatically.)
S	Shutter Priority	Take a photo by adjusting the shutter speed. (The aperture value is set automatically.)
M	Manual	Take a photo by adjusting both the aperture value and shutter speed.
	DUAL IS	Take a photo using options suitable for reducing camera shake.
SCN	Scene	Take a photo using options preset for a specific scene.
	Movie	Check the configured settings to record a video.

Drive mode dial

Icon	Mode	Description
	Single	Take a single photo.
	Continuous	<ul style="list-style-type: none"> While you are pressing [Shutter], the camera takes photos continuously. The maximum number of photos depends on the capacity of your memory card.
	10 Sec	Take a photo in 10 seconds.
	2 Sec	Take a photo in 2 seconds.
BKT	Bracket	<p>According to a bracketing option,</p> <ul style="list-style-type: none"> Take 9 photos with different photo styles. Take 3 photos with different white balance. Take 3 photos with different exposures.

Using the screen

Swing the screen outwards 180° and rotate it up or down for high- and low-angle photos or self portraits. You can rotate the screen a maximum of 90° downward or 180° upward.

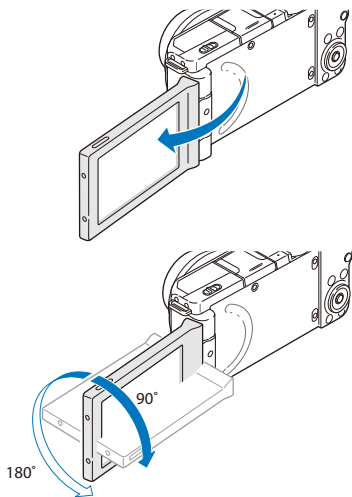

- Fold the screen when not in use.
- Rotate the screen only within the angle allowed.

Attaching a strap

Attach a strap to carry your camera conveniently.

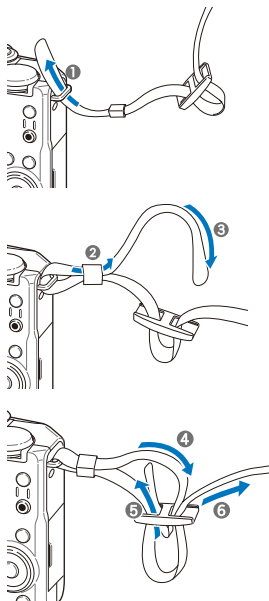

Attaching a lens cap

Attach a lens cap with a lens cap strap to protect the camera lens.

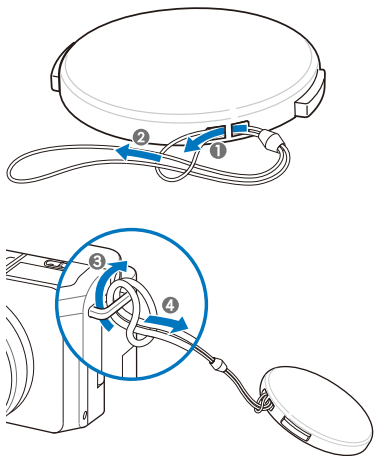

Inserting the battery and memory card

Learn how to insert the battery and an optional memory card into the camera.

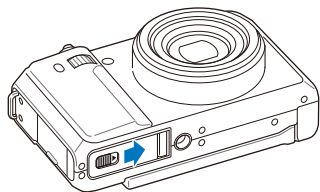

Insert a memory card with the gold-colored contacts facing down.

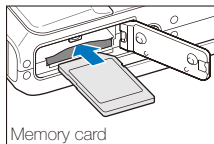

Insert the battery with the Samsung logo facing down.

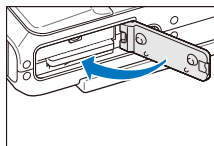
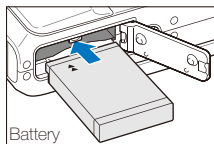

Removing the battery and memory card

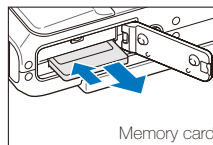

Push the card gently until the card disengages from the camera, and then pull it out of the slot.

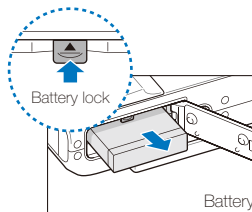

Push the lock up to release the battery.



The internal memory can be used as a temporary storage device when the memory card is not inserted.

Charging the battery and turning your camera on

Charging the battery

Before using the camera for the first time, you must charge the battery. Attach the USB cable to the AC adapter, and then plug the end of cable with the indicator light into your camera.

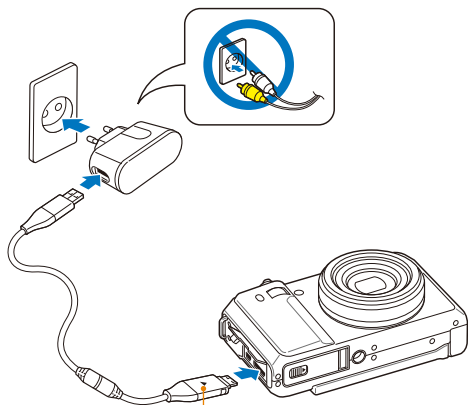

Indicator light

- **Red:** Charging
- **Green:** Fully charged

Turning on your camera

Press **[POWER]** to turn your camera on or off.

- The initial setup screen appears when you turn on the camera for the first time. (p. 22)

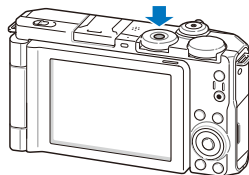

Turning on your camera in Playback mode

Press **[▶]**. The camera turns on and accesses Playback mode immediately.

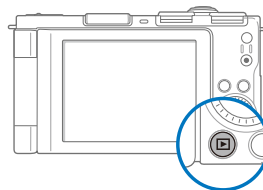

When you turn on your camera by pressing and holding **[▶]** for about 5 seconds, the camera does not emit any camera sounds.

Performing the initial setup

When the initial setup screen appears, follow the steps below to configure the camera's basic settings.

1 Press [POWER].

- The initial setup screen appears when you turn on the camera for the first time.

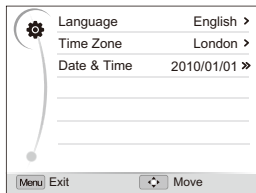

2 Press [ISO] to select **Language**, and then press [ISO] or [OK].

3 Press [DISP] or [▼] to select a language, and then press [OK].

4 Press [DISP] or [▼] to select **Time Zone** (Time Zone), and then press [ISO] or [OK].

5 Press [DISP] or [▼] to select **Home** (Home), and then press [OK].

6 Press [⚡] or [ISO] to select a time zone, and then press [OK].

- To set the daylight-saving time, press [DISP].



7 Press [DISP] or [▼] to select **Date & Time** (Date & Time), and then press [ISO] or [OK].

8 Press [⚡] or [ISO] to select an item.

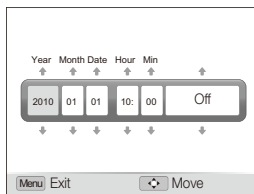

9 Press [DISP] or [▼] to set the date and time or select a date format, and then press [OK].

Learning icons

The icons displayed will change according to the mode you select or the options you set.

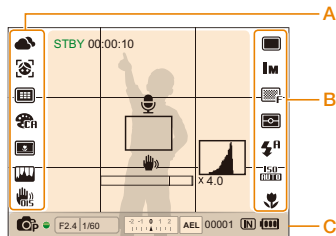

A. Icons on the left

Icon	Description
	White balance
	Face detection
	Focus area option
	Photo style
	Smart filter effect
	Image adjustment (sharpness, contrast, saturation)
	Optical Image Stabilization (OIS)

B. Icons on the right

Icon	Description
	Single shot
	Continuous shots
	Timer
	Bracketing
	Remote control
	Photo resolution
	Video resolution
	Frame rate
	Photo quality
	Metering option
	Flash option
	Flash intensity
	ISO speed
	Auto focus option

C. Information

Icon	Description
	Selected shooting mode
F2.4	Aperture value
1/60	Shutter speed
	Exposure value
	Exposure value lock
00001	Available number of photos
	Internal memory
	Memory card inserted
	<ul style="list-style-type: none"> Fully charged Partially charged (Red): Charging needed
00:00:10	Available recording time
	Voice memo
	Auto focus frame
	Camera shake
	Zoom ratio x4.0
	Histogram (p. 26)

Selecting options

You can select options by pressing **[MENU]** and using the navigation buttons (**[DISP]**, **[↓]**, **[↔]**, **[ISO]**).



You can also access shooting options by pressing **[Fn]** or rotating the EV dial, but some options will not be available.

- 1 In Shooting mode, press **[MENU]**.
- 2 Press or rotate the navigation button to scroll to an option or menu.
 - Press **[DISP]** or **[↓]** to move up or down; press **[↔]** or **[ISO]** to move left or right.

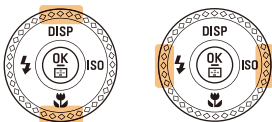

- Rotate the navigation button any direction.



- 3 Press **[OK]** to confirm the highlighted option or menu.

Going back to the previous menu

Press **[MENU]** again to go back to the previous menu.



Press **[Shutter]** to return to Shooting mode.

E.g. Selecting the white balance option in Program mode

1 Rotate the mode dial to **P**.



2 Press **[MENU]**.

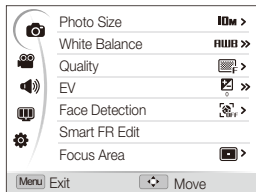

3 Rotate the navigation button or press **[DISP]** or **[↓]** to scroll to , and then press **[ISO]** or **[OK]**.

4 Rotate the navigation button or press **[DISP]** or **[↓]** to scroll to **White Balance**, and then press **[ISO]** or **[OK]**.

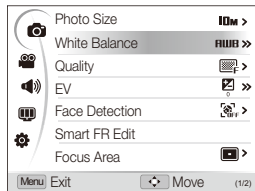

5 Rotate the navigation button or press **[↓]** or **[ISO]** to scroll to the white balance option.

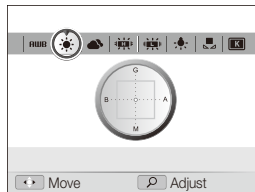

6 Press **[OK]** to save your settings.

7 Press **[MENU]** to switch to Shooting mode.

Setting the display and sound

Learn how to change the basic information the camera displays and the sound settings.

Changing the information displayed

Select the information displayed in Shooting or Playback mode.

Press **[DISP]** repeatedly to change the information displayed.

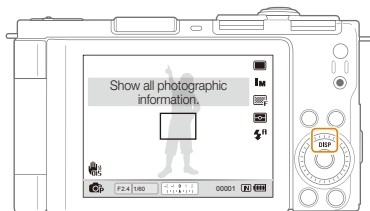

Mode	Information display option
Shooting	• Hide all information about shooting.
	• Hide information about shooting, except information of the bottom line.
	• Display all information about shooting.
	• Display histogram.
Playback	• Hide all information about the current file.
	• Display all information about the current photo.
	• Display information about the current file, except the shooting settings and histogram.

About a histogram

A histogram is a graph that displays how light is distributed in your photo. If the histogram has a high peak on the left, your photos are dark. A peak on the right of the graph means that your photos are bright. The height of the peaks is related to color information. The more of a particular color, the taller the peak.



Underexposed

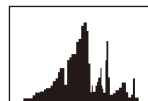

Well Exposed



Overexposed

Setting the sound

Set whether your camera emits a specified sound when you operate your camera.

- 1 In Shooting or Playback mode, press **[MENU]**.
- 2 Select **[Speaker Icon]** → **Beep Sound** → an option.

Option	Description
Off	The camera does not emit any sounds.
1/2/3	The camera emits sounds.

Taking photos

Learn basic actions to take photos easily and quickly in the Smart Auto mode.

- 1 Rotate the mode dial to  SMART.



- 2 Swing the screen and rotate it up or down properly.
- 3 Align your subject in the frame.

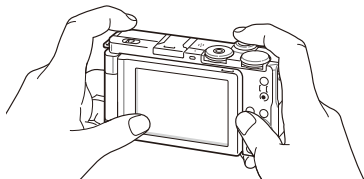

- Fold the screen back against the body of the camera for normal use.

- 4 Half-press **[Shutter]** to focus.
 - A green frame means the subject in focus.
 - A red frame means the subject is out of focus.

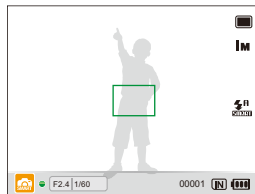

- 5 Press **[Shutter]** to take a photo.



See page 30 for tips to get clearer photos.

Zooming

You can shoot close-up photos by adjusting the zoom. Your camera has a 3X optical zoom and 4X digital zoom. By using both, you can zoom in up to 12 times.

Rotate **[Zoom]** right to zoom in on your subject. Rotate **[Zoom]** left to zoom out.

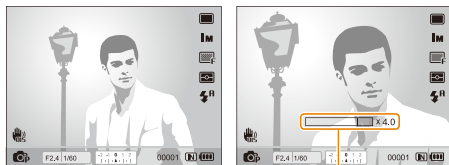

Zoom ratio



Digital zoom

If the zoom indicator is in the digital range, your camera is using the digital zoom. The picture quality may deteriorate when you use the digital zoom.

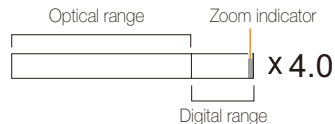

- The digital zoom is not available when using **SMART**, **DUAL**, **SCN** (in some scenes), and **AF** modes and when using **Face Detection**, **Manual Focus**, **Smart Filter**, and **Tracking AF**.
- It may take longer to save a photo when using the digital zoom.

Reducing camera shake (OIS) P A S M SCN

Reduce camera shake optically in Shooting mode.

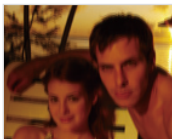

Before correction



After correction

1 In Shooting mode, press **[MENU]**.

2 Select  → **OIS** → an option.

Option	Description
	Off: Deactivate the OIS function.
	On: Activate the OIS function.



- OIS may not function properly when:
 - You move your camera to follow a moving subject.
 - You use digital zoom.
 - There is too much camera shake.
 - The shutter speed is slow.
(For example, when you select **Night** in the **SCN** mode)
 - The battery is low.
 - You take a close-up shot.
- If you use the OIS function with a tripod, your images may be blurred by the vibration of the OIS sensor. Deactivate the OIS function when you use a tripod.
- If the camera is impacted, the display will be blurry. In this case, turn off the camera and turn it on again to use the OIS function correctly.
- In some scene modes, the OIS function is unavailable.

Tips for getting a clearer photo

☺ Holding your camera correctly

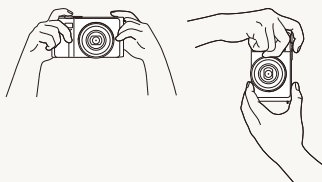

Make sure nothing is blocking the lens.

☺ Half-pressing the shutter button

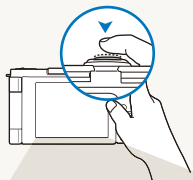

Half-press **[Shutter]** and adjust the focus. Focus and exposure will be adjusted automatically.

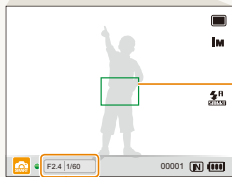

Focus frame

- Press **[Shutter]** to take the photo if displayed in green.
- Change the frame and half-press **[Shutter]** again if displayed in red.

The aperture value and shutter speed are set.

☺ Reducing camera shake



- Set the Optical Image Stabilization option to reduce camera shake optically. (p. 29)
- Select the **DUAL** mode to reduce camera shake both optically and digitally. (p. 41)

☺ When (👉) is displayed

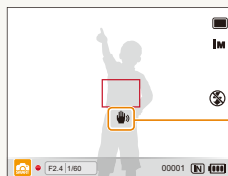

Camera shake

When shooting in the dark, avoid setting the flash option to **Slow Sync** or **Off**. The aperture remains open longer and it may be harder to hold the camera still.

- Use a tripod or set the flash option to **Fill in**. (p. 52)
- Set ISO speed options. (p. 55)

Preventing your subject from being out of focus

It may be difficult to get your subject in focus when:

- There is little contrast between the subject and background.
(When your subject is wearing a color of clothing that is similar to the background.)
- The light source behind the subject is too bright.
- The subject is shiny.
- The subject includes horizontal patterns, such as blinds.
- The subject is not positioned in the center of the frame.



Use the focus lock

Half-press **[Shutter]** to focus. When the subject is in focus, you can reposition the frame to change the composition.

When you are ready, press **[Shutter]** to take your photo.

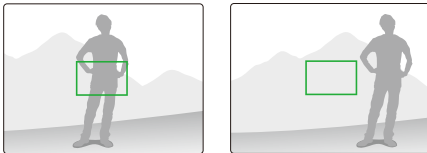

- When you take photos in low light



Turn on the flash.
(p. 52)

- When subjects are moving fast

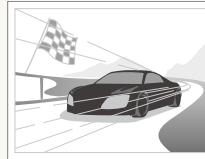

Use the continuous
or motion capture
function. (p. 50)

Extended functions

Learn how to take a photo by selecting a mode and how to record a video or voice memo.





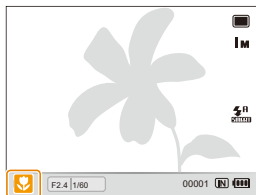

Using the Smart Auto mode	33
Using the Scene mode	35
Using the Beauty Shot mode	35
Using the Program mode	37
Using the Aperture Priority, Shutter Priority, or Manual mode	38
Using the Aperture Priority mode	39
Using the Shutter Priority mode	39
Using the Manual mode	40
Using the DUAL IS mode	41
Recording a video	42
Using the Smart Scene Detection mode	43
Recording voice memos	45
Recording a voice memo	45
Adding a voice memo to a photo	45

Using the Smart Auto mode

In this mode, your camera automatically chooses the appropriate camera settings based on a detected type of scene. The Smart Auto mode will be helpful if you are not familiar with the camera settings for various scenes.

- 1 Rotate the mode dial to .
- 2 Align your subject in the frame.
 - The camera selects a scene automatically. An appropriate scene mode icon appears at the bottom left of the screen.





Icon	Description
	Appears when taking photos of landscapes.
	Appears when taking photos with bright white backgrounds.
	Appears when taking photos of landscapes at night. This is available only when the flash is off.
	Appears when taking portraits at night.
	Appears when taking photos of landscapes with backlighting.
	Appears when taking portraits with backlighting.

Icon	Description
	Appears when taking portraits.
	Appears when taking close-up photos of objects.
	Appears when taking close-up photos of text.
	Appears when taking photos of sunsets.
	Appears when taking photos of clear skies.
	Appears when taking photos of forested areas.
	Appears when taking close-up photos of colorful subjects.
	Appears when taking close-up portraits of people.
	Appears when the camera and subject are stable for a while. This is available only when you are shooting in the dark.
	Appears when taking photos of actively moving subjects.
	Appears when taking photos of fireworks. This is available only when you use a tripod.

3 Half-press [**Shutter**] to focus.

4 Press [**Shutter**] to take the photo.



- If the camera does not recognize a proper scene mode,  appears and the default settings are used.
- Even if there is a face detected, the camera may not select a portrait mode depending on the subject's position or lighting.
- The camera may not select the correct scene depending on shooting environments, such as camera shake, lighting, and distance to the subject.
- Even if you use a tripod, the  mode may not be detected depending on the subject's movement.

Using the Scene mode

Take a photo with options preset for a specific scene.

- 1 Rotate the mode dial to **SCN**.
- 2 Select a scene.

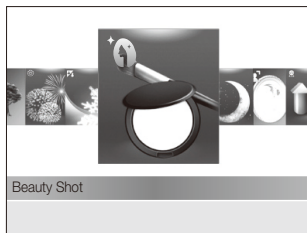

- To change the scene mode, press **[MENU]**, and then select **SCENE** → the scene mode of your choice.
 - For the Beauty shot mode, see "Using the Beauty Shot mode."
- 3 Align your subject in the frame and half-press **[Shutter]** to focus.
 - 4 Press **[Shutter]** to take the photo.

Using the Beauty Shot mode

Take a photo of a person with options to hide facial imperfections.

- 1 Rotate the mode dial to **SCN**.
- 2 Select **Beauty Shot**.
- 3 To make the subject's skin tone appear lighter (face only), press **[MENU]**.
- 4 Select **📷** → **Face Tone** → an option.
 - Select a higher setting to make skin tone appear lighter.

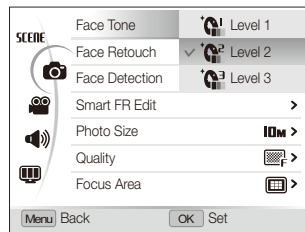

5 To hide facial imperfections, select **Face Retouch** → an option.

- Select a higher setting to hide a greater number of imperfections.

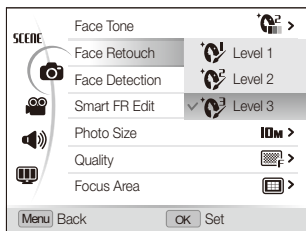

6 Press **[MENU]** to switch to Shooting mode.

7 Align your subject in the frame and half-press **[Shutter]** to focus.

8 Press **[Shutter]** to take the photo.



The focus distance will be set to **Auto Macro**.

Using the Program mode

In the Program mode, you can set various options except the shutter speed and aperture value, which the camera sets automatically.

- 1 Rotate the mode dial to **P**.
- 2 Set options. (For a list of options, refer to “Shooting options.”)
- 3 Align your subject in the frame and half-press [**Shutter**] to focus.

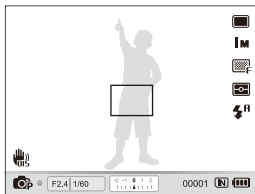

- 4 Press [**Shutter**] to take the photo.

Using the Aperture Priority, Shutter Priority, or Manual mode

Adjust aperture value or shutter speed to control the exposure of your photos. You can use these options in the Aperture Priority, Shutter Priority, and Manual modes.

Aperture value

The aperture is a hole through which light is admitted. You can adjust the aperture value to control how much light reaches the lens when you capture a photo. By decreasing the aperture value (opening the aperture wider), more light will enter and objects that are farther away will appear out of focus. This is good for close-up or portrait shots to draw attention to the main subject.

Alternatively, as you increase the aperture value, objects from near to far are in sharp focus. This is good for landscape shots to show the entire scope of the scene.



Big aperture value



Small aperture value

Shutter speed

Shutter speed controls how long the camera's shutter remains open when you capture a photo. When you decrease the shutter speed, more light enters your camera and the photo will appear brighter. However, a slower shutter speed can also result in blurry photos if either the subject or the camera is moving.

When you increase the shutter speed, the photo will appear darker. However, a faster shutter speed will also reduce the blurring if your subject or the camera is in motion.



Slow shutter speed



Fast shutter speed

Using the Aperture Priority mode

The Aperture Priority mode allows you to manually set the aperture value while the camera automatically selects an appropriate shutter speed.

- 1 Rotate the mode dial to **A**.
- 2 Rotate the navigation button to adjust the aperture value.
 - See page 38 for more information about the aperture value.

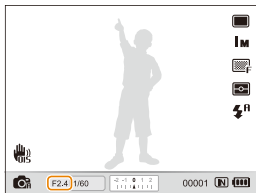

- 3 Set options. (For a list of options, refer to “Shooting options.”)
- 4 Align your subject in the frame and half-press [**Shutter**] to focus.
- 5 Press [**Shutter**] to take the photo.

Using the Shutter Priority mode

The Shutter Priority mode allows you to manually set the shutter speed while the camera automatically selects an appropriate aperture value.

- 1 Rotate the mode dial to **S**.
- 2 Rotate the EV dial to adjust the shutter speed.
 - See page 38 for more information about the shutter speed.

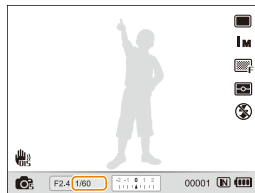

- 3 Set options. (For a list of options, refer to “Shooting options.”)
- 4 Align your subject in the frame and half-press [**Shutter**] to focus.
- 5 Press [**Shutter**] to take the photo.

Using the Manual mode

The Manual mode allows you to manually adjust both the aperture value and the shutter speed.

- 1 Rotate the mode dial to **M**.
- 2 Rotate the EV dial to adjust the shutter speed.
- 3 Rotate the navigation button to adjust the aperture value.

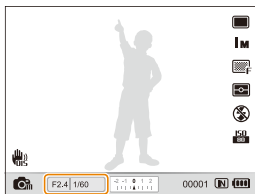

- 4 Set options. (For a list of options, refer to “Shooting options.”)
- 5 Align your subject in the frame and half-press **[Shutter]** to focus.
- 6 Press **[Shutter]** to take the photo.

Using the DUAL IS mode

Reduce camera shake and prevent blurred photos with Optical and Digital Image Stabilization functions.

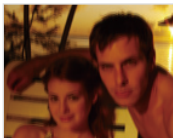

Before correction



After correction

- 1 Rotate the mode dial to  **DUAL**.
- 2 Align your subject in the frame and half-press [**Shutter**] to focus.
- 3 Press [**Shutter**] to take the photo.



- The digital zoom will not work in this mode.
- The photo will be corrected optically only when taken with a light source that is brighter than fluorescent light.
- If your subject is moving rapidly, the photo may be blurry.
- Set the Optical Image Stabilization option to reduce camera shake in different shooting modes. (p. 29)

Recording a video

Record videos of up to 20 minutes in length. The recorded video is saved as an H.264 (MPEG-4.AVC) file.



- H.264 (MPEG-4 part10/AVC) is a high-compression video format established by international standard organizations ISO/IEC and ITU-T.
- Some memory cards may not support high definition recording. In this case, set a lower resolution. (p. 47)
- When the Optical Image Stabilization is activated, your video may be recorded with the OIS operation sound.
- The zoom sound may be recorded if you use the zoom while recording a video.

- 1 In Shooting mode, press **[MENU]**.
- 2 Select → **Frame Rate** → a frame rate (the number of frames per second).
 - As the number of frames increases, action appears more natural, but the file size is increased.
- 3 Select **Voice** → a sound option.

Option	Description
OFF	Off: Record a video without sound.
	On: Record a video with sound.
	Zoom Mute: Record a video without sound while zooming.

- 4 Press **[MENU]** to switch to Shooting mode.

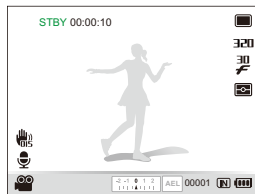

- 5 Set other options as desired.
(For options, refer to “Shooting options.”)
- 6 Press (Recorder) to start recording.
- 7 Press (Recorder) again to stop recording.



- You do not need to rotate the mode dial to to record a video. You can start recording a video in any mode by pressing (Recorder).
- If you press **[Shutter]** while recording a video, the current screen is captured and saved. The saved photo has the same resolution as the video.

To pause recording

The camera allows you to pause temporarily while recording a video. With this function, you can record several scenes as a single video.

Press **[OK]** to pause while recording. Press it again to resume.

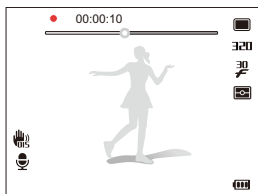

Using the Smart Scene Detection mode

In this mode, your camera automatically chooses the appropriate video settings based on a detected type of scene.

- 1 In Shooting mode, press **[MENU]**.
- 2 Select  → **Smart Scene Detection** → **On**.
- 3 Press **[MENU]** to switch to Shooting mode.
- 4 Align your subject in the frame.
 - The camera selects a scene automatically. An appropriate scene mode icon appears at the bottom left of the screen.

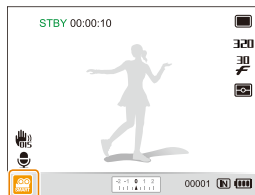

Icon	Description
	Appears when recording videos of landscapes.
	Appears when recording videos of clear skies.
	Appears when recording videos of forested areas.
	Appears when recording videos of sunsets.

5 Press  (Recorder) to start recording.

6 Press  (Recorder) again to stop recording.



- If the camera does not recognize a proper scene mode,  will not change and the default settings are used.
- The camera may not select the correct scene depending on shooting environments, such as camera shake, lighting and distance to the subject.
- In the Smart Scene Detection mode, you cannot set smart filter effects and photo styles.

Recording voice memos

P A S M HDDUAL SCN

Learn how to record a voice memo that you can play back at any time. You can add a voice memo to a photo as a short reminder of shooting conditions.

 You get the best sound quality when recording 40 cm away from the camera.

Recording a voice memo

- 1 In Shooting mode, press **[MENU]**.
- 2 Select  → **Voice** → **Record**.
- 3 Press **[Shutter]** to record.
 - You can record voice memos of up to 10 hours in length.
 - Press **[OK]** to pause or resume recording.



- 4 Press **[Shutter]** to stop.
 - Press **[Shutter]** again to record a new voice memo.
- 5 Press **[MENU]** to switch to Shooting mode.

Adding a voice memo to a photo

- 1 In Shooting mode, press **[MENU]**.
- 2 Select  → **Voice** → **Memo**.
- 3 Press **[MENU]** to switch to Shooting mode.
- 4 Align your subject in the frame and take a photo.
 - The camera begins to record a voice memo right after you take the photo.
- 5 Record a short voice memo (10 seconds maximum).
 - Press **[Shutter]** to stop recording a voice memo.

 You cannot add a voice memo to a photo if you set the burst mode.

Shooting options

Learn about the options you can set in Shooting mode.

Selecting a resolution and quality	47	Using face detection	60
Selecting a resolution	47	Detecting faces	60
Selecting image quality	48	Taking a self-portrait shot	61
Using the timer	49	Taking a smile shot	61
Using burst modes	50	Detecting eye blinking	62
Taking continuous photos	50	Using smart face recognition	62
Taking bracketed photos	51	Registering faces as your favorites (My Star) ...	63
Shooting in the dark	52	Adjusting brightness and color	65
Preventing red-eye	52	Adjusting the exposure manually (EV)	65
Using the flash	52	Locking the exposure value	66
Adjusting the ISO speed	55	Changing the metering option	66
Changing the camera's focus	56	Selecting a light source (White balance)	67
Using macro	56	Improving your photos	71
Using auto focus	56	Applying photo styles	71
Using selection focus	57	Applying smart filter effects	72
Using tracking auto focus	58	Adjusting your photos	73
Adjusting the focus area	59	Using smart range	74

Selecting a resolution and quality





Learn how to change the image resolution and quality settings.

Selecting a resolution



As you increase the resolution, your photo or video will include more pixels, so it can be printed on larger paper or displayed on a larger screen. When you use a high resolution, the file size will also increase.

When taking a photo:

- 1 In Shooting mode, press **[MENU]**.
- 2 Select  → **Photo Size** → an option.

Option	Description
10M	3648 X 2736: Print on A2 paper in wide ratio (4:3).
	3648 X 2432: Print on A2 paper in panorama ratio (3:2) or play back on an HDTV.
8M	3264 X 2448: Print on A3 paper.
	3648 X 2048: Print on A3 paper in panorama ratio (16:9).
	2736 X 2736: Print on A3 paper in 1:1 ratio.
5M	2592 X 1944: Print on A4 paper.
3M	2048 X 1536: Print on A5 paper.
	1920 X 1080: Print on A5 paper in panorama ratio (16:9) or play back on an HDTV.
1M	1024 X 768: Attach to email.

When recording a video:







- 1 In the  mode, press **[MENU]**.
- 2 Select  → **Movie Size** → an option.

Option	Description
640	640 X 480: Play back on a general TV.
320	320 X 240: Post on a web page.

Selecting image quality P A S M SCN

Photos you take are saved in JPEG or RAW format. Higher quality images will result in larger sizes.

- 1 In Shooting mode, press **[MENU]**.
- 2 Select  → **Quality** → an option.

Option	Description
	Super Fine
	Fine
	Normal
	RAW
	RAW + S.Fine
	RAW + Fine
	RAW + Normal

The options may differ depending on the shooting mode.



If you set the burst mode, you cannot take photos in RAW format, and a RAW option will be set to **Normal**.

What are RAW files?

Photos captured by a camera are often transformed to JPEG format and stored in the memory according to the settings of the camera at the time of shooting. RAW files are not transformed to JPEG format and are stored in the memory without any changes. RAW files have the file extension "RAW" (For example:"SAM-9999 RAW").

To adjust and calibrate exposures, white balances, tones, contrasts, and colors of the RAW files, use the Samsung RAW Converter program supplied in the software CD-ROM. (See page 97.)

Using the timer

SMART P A S M ^{HD}DUAL SCN 

Learn how to set the timer to delay shooting.

1 Rotate the drive mode dial to **2** or **10**.

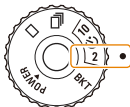

Take a photo
in 2 seconds.

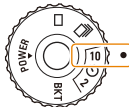

Take a photo
in 10 seconds.

2 Press **[Shutter]** to start the timer.

- The AF-assist light/timer lamp blinks. The camera will automatically take a photo at the specified time.



- Half-press **[Shutter]** to cancel the timer.
- Depending on the selected face detection option, the timer is not available.

Using burst modes

P A S M SCN

It can be difficult to take photos of fast-moving subjects or capture natural facial expressions and gestures of your subjects in photos. Also, it can be difficult to adjust the exposure correctly and select a proper light source. In these cases, select one of the burst modes.



- You can use the flash, only when you select **Single**.
- Depending on the selected face detection option, some burst options are not available.

Taking continuous photos

- 1 Rotate the drive mode dial to



- 2 Press and hold **[Shutter]**.

- While you are pressing **[Shutter]**, the camera takes photos continuously.
- The maximum number of photos depends on the capacity of your memory card.



- When taking continuous photos, the status lamp may blink.
- Even if the drive mode dial is rotated to , your camera may take a single photo depending on the selected options or modes.

Taking bracketed photos

1 Rotate the drive mode dial to **BKT**.



2 Press **[Shutter]**.

- If **WB BKT** or **AE BKT** is selected, the camera takes 3 photos continuously.
- If **PSS BKT** is selected, the camera takes 9 photos. The original photo is saved automatically and you can select one additional photo to save.





Use a tripod to prevent blurry photos.

Selecting a bracketing option

1 In Shooting mode, press **[MENU]**.

2 Select  → **Bracket**.

3 Select a bracketing option.

Option	Description
	PSS BKT: Take 9 photos with different photo styles.
	WB BKT: Take 3 photos with different white balance options.
	AE BKT: Take 3 photos with selected exposures.

4 Adjust the color for the selected light source or select an exposure value.

5 Press **[OK]** to save your settings.

Shooting in the dark

Learn how to take photos at night or in low light conditions.

Preventing red-eye P SCN

If the flash fires when you take a photo of a person in the dark, a red glow may appear in the eyes. To prevent this, select **Red-eye** or **Red-eye Fix**. Refer to flash options in "Using the flash."





Using the flash SMART P A S M SCN



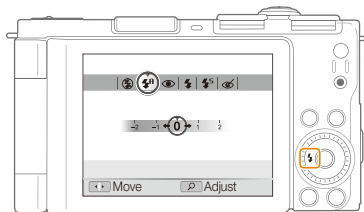

Use the flash when taking photos in the dark or when you need more light on your photos.

1 In Shooting mode, press [Flash].



2 Select an option.

Option	Description
	Off: <ul style="list-style-type: none">The flash does not fire.Camera shake warning () will be displayed when shooting in low light.
	Auto: The camera will select a proper flash setting for the detected scene in the SMART mode.

Option	Description
	<p>Red-eye*:</p> <ul style="list-style-type: none"> The flash fires when the subject or background is dark. The camera reduces red-eyes.
	<p>Fill in:</p> <ul style="list-style-type: none"> The flash always fires. Light intensity is adjusted automatically.
	<p>Slow Sync:</p> <ul style="list-style-type: none"> The flash fires and the shutter stays open longer. Select this when you want to capture ambient light to reveal more details in the background. Use a tripod to prevent your photos from blurring.
	<p>Red-eye Fix*:</p> <ul style="list-style-type: none"> The flash fires when the subject or background is dark. The camera corrects red-eyes through its advanced software analysis.
	<p>Auto: The flash fires automatically when the subject or background is dark.</p>

The options may differ depending on the shooting mode.

* There is an interval between two bursts of the flash. Do not move until the flash fires a second time.



- Flash options are not available if you rotate the drive mode dial to  or **BKT**, or select **Blink Detection**.
- Make sure that your subjects are within the recommended distance from the flash. (p. 120)
- If there is reflected light or much dust in the air, tiny spots may appear on your photo.

Adjusting the flash intensity

Adjust the flash intensity to avoid overexposure or underexposure.

- In Shooting mode, press .
- Scroll to an option.
- Rotate **[Zoom]** right.



4 Adjust the intensity.

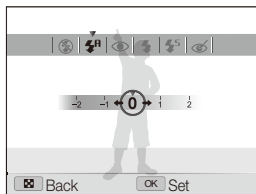

5 Press [OK] to save your settings.



- Adjusting the flash intensity may not be effective if:
 - The subject is too close to the camera.
 - You set a high ISO speed.
 - The exposure value is too big or too small.
- In some shooting modes, you cannot use this function.

How to use the flash

Slide the flash release to pop the flash up when it is need.

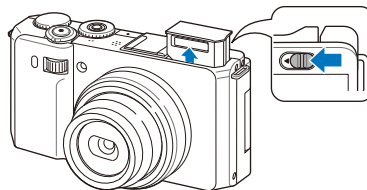

When the flash unit is closed, the flash does not fire regardless of the selected option. When the flash unit pops up, the flash fires according to the selected option.



- While not in use, keep the flash unit closed to prevent damage.
- Forcing open the flash unit may cause damage to your camera.

Press down gently to close.

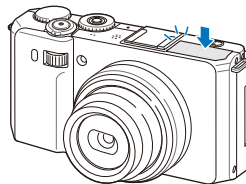

Adjusting the ISO speed P A S M

The ISO speed is the measure of a film's sensitivity to light as defined by the International Organization for Standardization (ISO). The higher ISO speed you select, the more sensitive to light your camera becomes. With a higher ISO speed, you can get a better photo without using the flash.

1 In Shooting mode, press **[ISO]**.

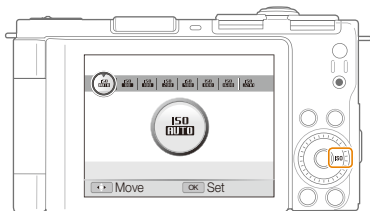

2 Select an option.

- Select **ISO AUTO** to use an appropriate ISO speed based on the brightness of the subject and lighting.



The higher ISO speed you select, the more image noise you may get.

Changing the camera's focus

Learn how to adjust the camera's focus according to your subjects.

Using macro P A S M

Use macro to take close-up photos of subjects, such as flowers or insects. Refer to macro options in "Using auto focus."



- Try to hold the camera very still to prevent blurry photos.
- Turn off the flash if the distance to the subject is less than 40 cm.



Using auto focus P A S M

To take sharp photos, select the appropriate focus according to your distance from the subject.

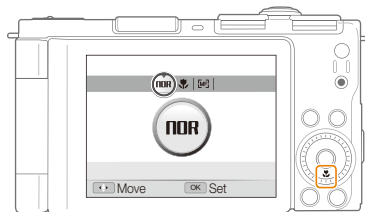
1 In Shooting mode, press .



2 Select an option.

Option	Description
nOR	Normal (AF): Focus on a subject farther than 80 cm.
	Macro: Focus on a subject 5-80 cm away (50-80 cm away when using zoom).
	Auto Macro: Focus on a subject farther than 5 cm (farther than 50 cm away when using zoom).
	Manual Focus: Focus on a subject by manually adjusting the focus distance. (p.57)

The options may differ depending on the shooting mode.

Adjusting the focus distance manually

- 1 In Shooting mode, press [M].
- 2 Scroll to **Manual Focus**.
- 3 Rotate [Zoom] right.
- 4 Adjust the focus distance.

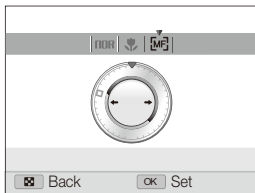

- 5 Press [OK] to save your settings.



- When you adjust the focus distance manually and the subject is out of focus, the photo may become blurry.
- If you use this function, you cannot set some focus area options.
- If you use this function, you cannot set face detection options.

Using selection focus PASM ^{HD}DUAL

You can focus on a particular part of your scene. Select where you want to focus.

- 1 In Shooting mode, press [MENU].
- 2 Select [Focus Area] → **Focus Area** → **Selection AF**.
- 3 Press [MENU] to switch to Shooting mode.

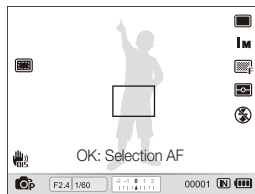

- 4 Press [OK].
- 5 Move the frame to the area you want to focus and press [OK].
- 6 Press [Shutter] to take the photo.
 - Press [OK] to change the focus area.



If you use this function, you cannot set face detection, photo style options, and smart filter effects.

Using tracking auto focus P A S M

Tracking AF allows you to track and auto focus on your subject, even when you are moving.

- 1 In Shooting mode, press **[MENU]**.
- 2 Select  → **Focus Area** → **Tracking AF**.
- 3 Press **[MENU]** to switch to Shooting mode.
- 4 Focus on the subject you want to track and press **[OK]**.
 - A focus frame appears on the subject and follows the subject as you move the camera.

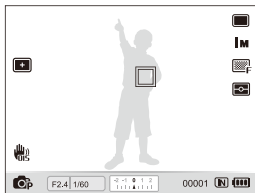

- The white frame means that your camera is tracking the subject.
- The green frame means that your subject is in focus when you half-press **[Shutter]**.







- Tracking a subject may fail when:
 - The subject is too small or the subject moves excessively.
 - The subject is backlit or you are shooting in a dark place.
 - Colors or patterns on the subject and the background are the same.
 - The camera shakes excessively.In these cases, the focus frame appears as a white single-line frame.
- If the camera fails to track the subject, you must reselect the subject to track.
- If the camera fails to fix the focus, the focus frame changes to a red single-line frame.
- If you use this function, you cannot set face detection, photo style options, and smart filter effects.

Adjusting the focus area **P A S M** **SCN**

You can get clearer photos by selecting an appropriate focus area according to your subject's location in the scene.

- 1 In Shooting mode, press **[MENU]**.
- 2 Select  → **Focus Area** → an option.

Option	Description
	Center AF: Focus on the center (suitable when subjects are located in the center).
	Multi AF: Focus on one or more of 9 possible areas.
	Selection AF: Focus on the area you select. (p. 57)
	Tracking AF: Focus on and track the subject. (p. 58)

The options may differ depending on the shooting mode.

Using face detection P A S M QUAL SCN

If you use face detection options, your camera can automatically detect a human face. When you focus on a human face, the camera adjusts the exposure automatically. Take photos quickly and easily by using **Blink Detection** to detect closed eyes or **Smile Shot** to capture a smiling face. You can also use **Smart Face Recognition** to register faces and prioritize the focus on them.



- In some **SCN** modes, face detection is unavailable.
- Face detection may not be effective when:
 - The subject is far from the camera. (The focus frame will appear orange for **Smile Shot** and **Blink Detection**.)
 - It is too bright or too dark.
 - The subject is not facing the camera.
 - The subject is wearing sunglasses or a mask.
 - The subject is in backlighting or the lighting condition is unstable.
 - The subject's facial expression changes remarkably.
- Face detection is not available when you use a photo style, smart filter effect, or image adjustment option, or when you use **Selection AF**, **Manual Focus**, or **Tracking AF**.
- Face detection is not available when you set the burst mode.
- If you select a face detection option while using the digital zoom, the digital zoom changes to the optical zoom automatically.
- Depending on the selected face detection option, the timer is not available or some timer options are not available.
- Depending on the selected face detection option, some burst options are not available.
- When you take photos of detected faces, they will be registered in the face list.
- You can view registered faces in order of priority in Playback mode. (p. 77) Even though faces are registered successfully, they may not be classified in Playback mode.
- The detected face in Shooting mode may not appear in the face list or Smart Album.

Detecting faces

Your camera automatically detects human faces (up to 10 human faces).

- 1 In Shooting mode, press **[MENU]**.
- 2 Select  → **Face Detection** → **Normal**.

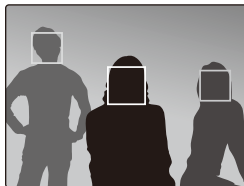

- The nearest face appears in a white focus frame and the rest of the faces appear in gray focus frames.



The closer you are to the subject, the quicker your camera will detect faces.

Taking a self-portrait shot

Take photos of yourself. The focus distance will be set to close-up and your camera will emit a beep.

- 1 In Shooting mode, press **[MENU]**.
- 2 Select  → **Face Detection** → **Self-Portrait**.
- 3 Press **[MENU]** to switch to Shooting mode.
- 4 Swing and rotate the screen for self portraits.
- 5 When you hear a quick beep, press **[Shutter]**.

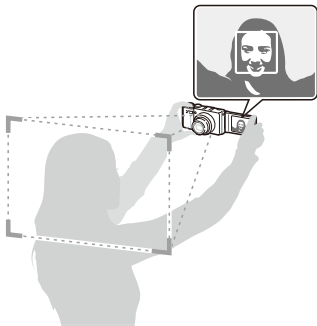

Taking a smile shot

The camera automatically releases the shutter when it detects a smiling face.

- 1 In Shooting mode, press **[MENU]**.
- 2 Select  → **Face Detection** → **Smile Shot**.
- 3 Press **[MENU]** to switch to Shooting mode.
- 4 Align a smiling face in the frame.
 - When the camera detects the smiling face, it takes a photo automatically.

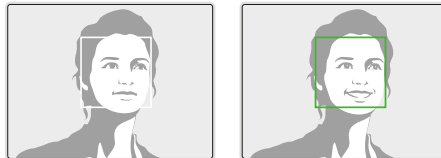

- When your subject smiles broadly, your camera can detect the smile more easily.

Detecting eye blinking

If your camera detects closed eyes, it will automatically take 2 photos in succession.

- 1 In Shooting mode, press **[MENU]**.
- 2 Select  → **Face Detection** → **Blink Detection**.





When blink detection fails, **"Picture taken with eyes closed."** message appears. Take another photo.

Using smart face recognition

The camera automatically registers faces that you frequently photograph (up to 10 people). This feature will automatically prioritize the focus on those faces. This feature is available only when you use a memory card.

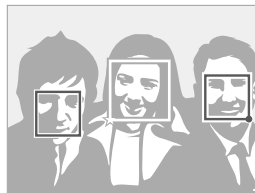
- 1 In Shooting mode, press **[MENU]**.
- 2 Select  → **Face Detection** → **Smart Face Recognition**.



- The nearest face appears in a white focus frame and the rest of the faces appear in gray focus frames.
-  : Indicates favorite faces (To register favorite faces, see page 63).
-  : Indicates faces that the camera automatically registers.



- The camera may recognize and register faces incorrectly depending on lighting conditions, unusual changes in the subject's pose or face, and whether or not the subject is wearing glasses.
- The camera can automatically register up to 12 faces. If the camera recognizes a new face when there are 12 registered faces, it will replace the face in the lowest priority with the new one.
- The camera can detect up to 10 faces in one scene.

Registering faces as your favorites (My Star)

You can register your favorite faces to prioritize the focus and exposure on those faces. This feature is available only when you use a memory card.

- 1 In Shooting mode, press **[MENU]**.
- 2 Select  → **Smart FR Edit** → **My Star** .
- 3 Align your subject's face with the oval guideline and press **[Shutter]** to register the face.
 - If the subject's face is not aligned with the oval guideline, the white frame will not appear.
 - You can take photos of a subject's face directly from the front, to the left side, to the right side, from above, or from below.
 - Take photos of one person at a time when registering faces.

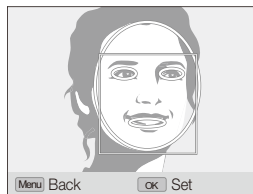

4 When you are finished taking the photos, the face list appears.

- Your favorite faces are indicated with a ★ on the face list.



- You can register up to 8 favorite faces.
- The flash option will be set to **Off**.

Viewing your favorite faces

1 In Shooting mode, press **[MENU]**.

2 Select  → **Smart FR Edit** → **Face List** .



- To change the ranking of the favorite faces, press **[Fn]** and select **Edit Ranking** . (p. 77)
- To cancel the favorite faces, press **[Fn]** and select **Delete My Star** . (p. 77)

Adjusting brightness and color

Learn how to adjust the brightness and color for better image quality.

Adjusting the exposure manually (EV)

P A S  

Depending on the intensity of the ambient light, your photos may be too bright or dark. In these cases, you can adjust the exposure to get a better photo.



Darker (-)



Neutral (0)



Brighter (+)

- 1 In Shooting mode, press **[MENU]**.
- 2 Select  → **EV**.
- 3 Select a value to adjust the exposure.
- 4 Press **[OK]** to save your settings.



- Once you adjust the exposure, the setting will remain the same. You may need to change the exposure value later to avoid overexposing or underexposing photos you take later.
- If you cannot decide on an appropriate exposure, change the bracketing mode to **AE BKT** and rotate the drive mode dial to **BKT**. The camera takes photos with different exposures. (p. 50)

Using the EV dial

- 1 In Shooting mode, press the EV dial.

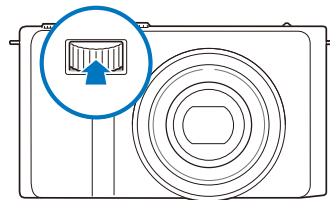

- 2 Rotate the EV dial to adjust the exposure.

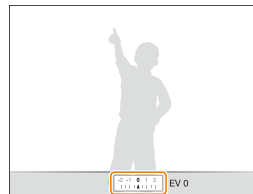

- +: Brighter
- -: Darker

- 3 Press the EV dial again to save your settings.

Locking the exposure value

The adjusted exposure value locks when **[AEL]** is pressed, and remains locked until **[AEL]** is pressed again.

- 1 Adjust the exposure manually.
- 2 Press **[AEL]**.

- The AEL icon turns on.

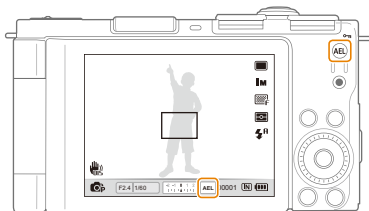

Changing the metering option

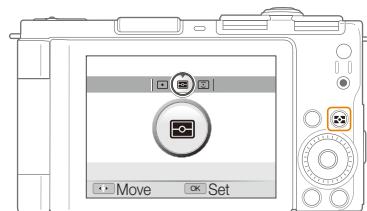

The metering mode refers to the way in which a camera measures the quantity of light. The brightness and lighting of your photos will vary depending on the metering mode you select.

- 1 In Shooting mode, press **[M]**.



- 2 Select an option.

Option	Description
	<p>Spot:</p> <ul style="list-style-type: none">• Your camera measures only the light intensity of the very center of the frame.• If a subject is not in the center of the scene, your photo may be improperly exposed.• Suitable for a subject with backlighting.

Option	Description
	<p>Multi:</p> <ul style="list-style-type: none"> Your camera divides the scene into several areas, and then measures the light intensity of each area. Suitable for general photos.
	<p>Center-weighted:</p> <ul style="list-style-type: none"> Your camera averages the meter reading of the entire frame with emphasis placed on the center. Suitable for photos with subjects in the center of the frame.

Selecting a light source (White balance)

P A S M  

The color of your photo depends on the type and quality of the light source. If you want the color of your photo to be realistic, select an appropriate lighting condition to calibrate the white balance, such as Auto WB, Daylight, Cloudy, or Tungsten, or adjust color temperature manually. You can also adjust color for the preset light sources so that the colors of the photo match the actual scene under mixed lighting conditions.



 (Auto WB)



 (Daylight)











 (Cloudy)



 (Tungsten)

- 1 In Shooting mode, press **[MENU]**.
- 2 Select  → **White Balance** → an option.

Option	Description
	Auto WB: Use automatic settings depending on the lighting conditions.
	Daylight: Select when taking outdoor photos on a sunny day.
	Cloudy: Select when taking outdoor photos on a cloudy day or in shadows.
	Fluorescent_H: Select when shooting under a daylight fluorescent or three-way fluorescent light.
	Fluorescent_L: Select when shooting under white fluorescent light.
	Tungsten: Select when taking indoor photos under incandescent bulbs or halogen lamps.
	Custom Set: Use your pre-defined settings. (p. 69)
	Color Temperature: Adjust the color temperature of the light source. (p. 69)

Customizing preset white balance options

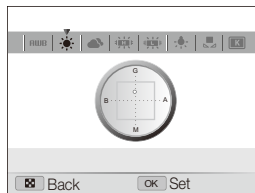

- 1 In Shooting mode, press **[MENU]**.
- 2 Select  → **White Balance**.
- 3 Scroll to a white balance option.
- 4 Rotate **[Zoom]** right.
- 5 Press or rotate the navigation button to adjust the value on the coordinates.



- G: Green
- A: Amber
- M: Magenta
- B: Blue

- 6 Press **[OK]** to save your settings.

Defining your own white balance

- 1 In Shooting mode, press **[MENU]**.
- 2 Select  → **White Balance**.
- 3 Scroll to **Custom Set** (, ).
- 4 Aim the lens at a piece of white paper.

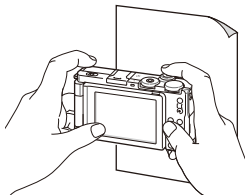

- 5 Press **[Shutter]**.

Adjusting color temperature

- 1 In Shooting mode, press **[MENU]**.
- 2 Select  → **White Balance**.
- 3 Scroll to **Color Temperature**.
- 4 Rotate **[Zoom]** right.
- 5 Press or rotate the navigation button to adjust the color temperature.

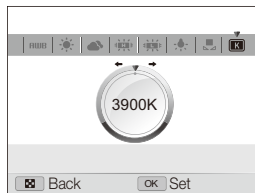

- 6 Press **[OK]** to save your settings.

Color temperature

Color temperature is a measurement in degrees Kelvin that indicates the hue of a specific type of light source. As the color temperature increases, the color distribution becomes cooler. Alternatively, as the color temperature decreases, the color distribution becomes warmer.

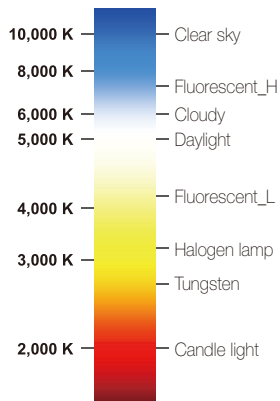

Improving your photos

Learn how to improve your photos by applying photo styles, colors, or smart filter effects, or by making some adjustments.

Applying photo styles **P A S M**

Apply a different photo style to your photos, such as Soft, Vivid, or Forest.



Soft



Vivid



Forest

- 1 In Shooting mode, press **[MENU]**.
- 2 Select  → **Photo Style Selector** → an option.
 - Select **Custom RGB** to define your own RGB tone.



- When you select **Sketch**, the photo automatically resizes to **5m** or smaller.
- If you use this function, you cannot set the smart filter and image adjustment options.

Defining your own RGB tone

- 1 In Shooting mode, press **[MENU]**.
- 2 Select  → **Photo Style Selector**.
- 3 Scroll to **Custom RGB**.
- 4 Rotate **[Zoom]** right.
- 5 Select a color (R: Red, G: Green, B: Blue).

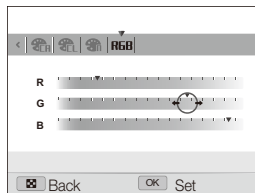

- 6 Adjust the amount of the selected color.
(-: less or +: more)
- 7 Press **[OK]** to save your settings.

Applying smart filter effects P A S M

Apply various filter effects to your photos to create unique images.



Miniature



Vignetting







Fish-eye

1 In Shooting mode, press **[MENU]**.

2 Select  → **Smart Filter**.

3 Select an effect.

Option	Description
	Normal: No effect.
	Miniature: Make a photo of a life-size location or object look like a photo of a miniature scale model. Blurring parts of the photo makes the scene seem much smaller than it actually is.
	Vignetting: Apply the retro-looking colors, high contrast, and strong vignette effect.
	Fish-eye: Distort close objects to imitate the visual effect of a fisheye lens.



- If you select **Miniature** when recording a video, the miniature recording time is displayed with the  icon and is shorter than the real recording time.
- If you select **Miniature** when recording a video, the sound will not be recorded.
- If you use this function, you cannot set the photo style and image adjustment options.

Adjusting your photos P A S M

Adjust the contrast, sharpness, and saturation of your photos.

1 In Shooting mode, press **[MENU]**.

2 Select  → **Image Adjust**.

3 Select an adjustment option.

- Contrast
- Sharpness
- Saturation

4 Select a value to adjust the selected item.

Contrast option	Description
-	Decrease the color and brightness.
+	Increase the color and brightness.

Sharpness option	Description
-	Soften the edges on your photos (suitable for editing the photos on your computer).
+	Sharpen the edges to improve the clarity of your photos. This may also increase the noise on your photos.

Saturation option	Description
-	Decrease the saturation.
+	Increase the saturation.



- Select **0** if you do not want to apply any effects. (suitable for printing)
- If you use this function, you cannot set the face detection options, photo style, and smart filter effects.

Using smart range P A S M

Your camera takes two photos with different exposures, and then overlays the bright area of the underexposed photo and the dark area of the overexposed photo.





Without smart range effect



With smart range effect

- 1 In Shooting mode, press **[MENU]**.
- 2 Select  → **Smart Range**.
- 3 Select an option.

Option	Description
	Off: The smart range effect is off.
	On: The smart range effect is on.



- The smart range effect may be affected by camera shake, lighting, movement of the subject, and the shooting environment.
- When taking photos at night, slow the ISO speed to reduce noise in your photos.
- When taking photos at night, use a tripod to prevent blurry photos.

Playback/Editing

Learn how to play back photos, videos, or voice memos and edit photos or videos. Also, learn how to connect your camera to your computer, photo printer, TV, or HDTV.

Playing back	76	Transferring files to your computer	
Starting Playback mode	76	(for Windows)	91
Viewing photos	81	Transferring files using Intelli-studio	92
Playing a video	82	Transferring files by connecting the camera	
Playing voice memos	83	as a removable disk	94
Editing a photo	84	Disconnecting the camera (for Windows XP)	95
Resizing photos	84	Transferring files to your computer	
Rotating a photo	84	(for Mac)	96
Applying photo styles	85	Using Samsung RAW Converter	97
Applying smart filter effects	86	Installing Samsung RAW Converter	97
Correcting exposure problems	87	Opening Samsung RAW Converter	97
Creating a print order (DPOF)	88	Using the Samsung RAW Converter Interface	98
Viewing files on a TV or HDTV	89	Editing RAW format files	99
		Saving RAW files as JPEG/TIFF formats ...	100
		Printing photos with a photo printer	
		(PictBridge)	101

Playing back

Learn actions to play back photos, videos, or voice memos, and manage files.

Starting Playback mode

View photos or play videos and voice memos stored in your camera.

- 1 Press [▶].
 - The most recent file you have taken or recorded is displayed.
 - If the camera is off, it turns on.
- 2 Rotate the navigation button or press [⏏] or [ISO] to scroll through files.
 - Press and hold [⏏] or [ISO] to scroll through files quickly.



- If you want to view files stored in the internal memory, remove your memory card.
- The camera will not properly play back files that are too large or those taken with cameras from other manufacturers.

Display in Playback mode

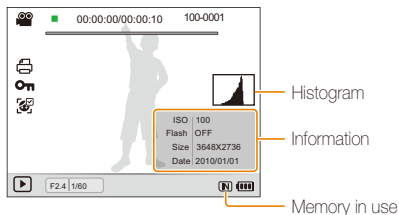



Icon	Description
	Video file
	Photo includes a voice memo
00:00:00/ 00:00:10	Playback time – Total playback time
100-0001	Folder name – File name
	Print order has been set (DPOF)
	Protected file
	Photo includes a registered face; Available only when you use a memory card

Ranking your favorite faces

You can change the ranking of your favorite faces. This feature is available only when you use a memory card.

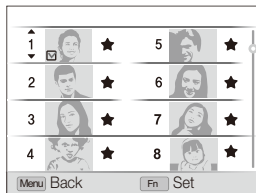
- 1 In Playback mode, press **[MENU]**.
- 2 Select  → **Face List Edit** → **Edit Ranking** .
- 3 Scroll to a face from the list and press **[OK]**.



- 4 Rotate the navigation button or press **[DISP]** or  to change the ranking of the face, and then press **[Fn]**.

Canceling your favorite faces

You can delete your favorite faces. This feature is available only when you use a memory card.

- 1 In Playback mode, press **[MENU]**.
- 2 Select  → **Face List Edit** → **Delete My Star**.
- 3 Scroll to a face and press **[OK]**.
- 4 Press **[Fn]**.
- 5 Select **Yes**.

Viewing files by category in Smart Album

View and manage files by categories, such as date, file type, or week.

- 1 In Playback mode, rotate **[Zoom]** left.
- 2 Press **[MENU]**.
- 3 Select a category.

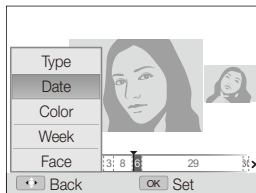

Option	Description
Type	View files by the file type.
Date	View files by the date they were saved.
Color	View files by the dominant color of the image.
Week	View files by the weekday they were saved.
Face	View files by recognized faces and favorite faces. (Up to 20 people)



It may take some time for the camera to open Smart Album or to change the category and recognize files.

- 4 Rotate the navigation button or press **[↓]** or **[ISO]** to scroll through files.
 - Press and hold **[↓]** or **[ISO]** to scroll through files quickly.
- 5 Press **[OK]** to return to the normal view.

Viewing files as thumbnails

Scan thumbnails of files.



In Playback mode, rotate **[Zoom]** left to display 9 or 20 thumbnails. Rotate **[Zoom]** right to return to the previous mode.

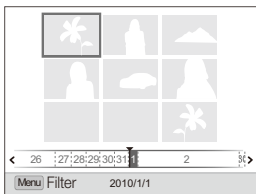

To	Do this
Scroll through files	Rotate the navigation button or press [DISP] , [↓] , [↑] , or [ISO] .
Delete files	Press [Fn] and select Yes .

Protecting files

Protect your files from accidental deletion.

- 1 In Playback mode, press **[MENU]**.
- 2 Select **Protect** → **Select**.
 - To protect all files, select **All** → **Lock**.
- 3 Select the file you want to protect and press **[OK]**.
 - Press **[OK]** again to cancel your selection.

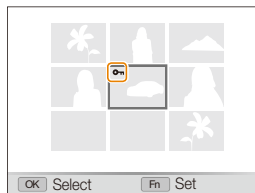

- 4 Press **[Fn]**.



While viewing a file, you can protect the file by pressing **[AEL]**.

Deleting files

Delete single files or all files at once. You cannot delete protected files.

To delete a single file,

- 1 In Playback mode, select a file and press **[Fn]**.
- 2 Select **Yes** to delete the file.

To delete multiple files,

- 1 In Playback mode, press **[Fn]**.
- 2 Select **Multiple Delete**.
- 3 Select files you want to delete and press **[OK]**.
 - Press **[OK]** again to cancel your selection.
- 4 Press **[Fn]**.
- 5 Select **Yes**.

To delete all files,

- 1 In Playback mode, press **[MENU]**.
- 2 Select  → **Delete** → **All** → **Yes**.

Copying files to the memory card

You can copy files from the internal memory to a memory card.

- 1 In Playback mode, press **[MENU]**.
- 2 Select  → **Copy to Card**.
- 3 Select **Yes** to copy files.

Viewing photos

Zoom in on part of a photo or view photos in a slide show.

Enlarging a photo



In Playback mode, rotate **[Zoom]** right to enlarge a photo. Rotate **[Zoom]** left to reduce a photo.

The enlarged area and zoom ratio are indicated on the top of the screen. The maximum zoom ratio may vary depending on the resolution.

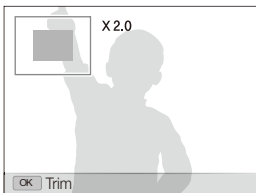

To	Do this
Move the enlarged area	Press [DISP] , [↓] , [←] , or [ISO] .
Trim the enlarged photo	Press [OK] . It will be saved as a new file.

Starting a slide show

You can apply effects and audio to your slide show.

- 1 In Playback mode, press **[MENU]**.
- 2 Select .
- 3 Select a slide show effect option.
 - Skip to step 5 to start a slide show with no effects.

Option	Description
Images	Set the photos you want to view as a slide show. <ul style="list-style-type: none"> • All: View all photos in a slide show. • Date: View photos captured on a specific date in a slide show. • Select: View selected photos in a slide show.
Interval	<ul style="list-style-type: none"> • Set the interval between photos. • This is available when Off is selected in the effect option.
Effect	<ul style="list-style-type: none"> • Select a transition effect. • Select Off for no effects.
Music	Select a background audio.

4 Set the slide show effect.

5 Select **Start** → **Play**.

- To loop the slide show, select **Repeat**.
- Press **[OK]** to pause or resume the slide show.



To stop the slide show and switch to Playback mode, press **[OK]**, and then **[↵]** or **[ISO]**.

Playing a video

You can play a video, capture an image from a video, or crop a video.

1 In Playback mode, select a video and press **[OK]**.

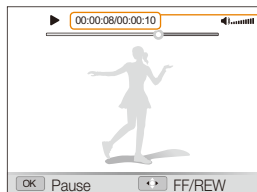

Playback time/
Total playback time

2 Use the following buttons to control playback.

Press	To
[↵]	Scan backward. The camera scans backward in 2X, 4X, and 8X increments when you press [↵] .
[OK]	Pause or resume playback.
[ISO]	Scan forward. The camera scans forward in 2X, 4X, and 8X increments when you press [ISO] .
[Zoom] left or right	Adjust the volume level.

Trimming a video during playback

- 1 Press **[OK]** at the point where you want the new video to begin, and rotate **[Zoom]** right.
- 2 Press **[OK]** to resume playback.
- 3 Press **[OK]** at the point where you want the new video to end, and rotate **[Zoom]** right.
- 4 Select **Yes**.



- The original video should be at least 10 seconds long.
- The edited video is saved as a new file.

Capturing an image during playback

- 1 Press **[OK]** at the point where you want to save a still image.
- 2 Press **[📷]**.



A captured image has the same resolution as the original video file and is saved as a new file.

Playing voice memos

Playing a voice memo

- 1 In Playback mode, select a voice memo and press **[OK]**.
- 2 Use the following buttons to control playback.

Press	To
[⏮]	Scan backward.
[OK]	Pause or resume playback.
[ISO]	Scan forward.
[📷]	Stop playback.
[Zoom] left or right	Adjust the volume level.

Adding a voice memo to a photo

- 1 In Playback mode, select a photo and press **[MENU]**.
- 2 Select **[🗣️]** → **Voice Memo** → **On**.
- 3 Press **[Shutter]** to record a short voice memo (10 seconds maximum).
 - Press **[Shutter]** to stop recording a voice memo.



Playing a voice memo added to a photo

- In Playback mode, select a photo that includes a voice memo, and then press **[OK]**.
- Press **[OK]** to pause or resume playback.

Editing a photo

Perform photo editing tasks, such as resizing, rotating, eliminating red-eyes, and adjusting brightness, contrast, or saturation.

Resizing photos

- 1 In Playback mode, select a photo and press **[MENU]**.
- 2 Select  → **Resize** → an option.
 - Select  to save the photo as a start image. (p. 104)

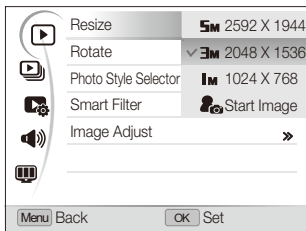

 Available options differ depending on the size of the selected photo.

Rotating a photo

- 1 In Playback mode, select a photo and press **[MENU]**.
- 2 Select  → **Rotate** → an option.

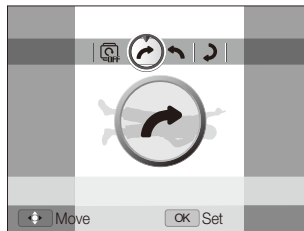

 The rotated photo will be saved as the same file, not a new file.

Applying photo styles

Apply a different photo style to the photo, such as Soft, Vivid, or Forest. The edited photo will be saved as a new file but it could be resized to a lower resolution.



Soft

Vivid

Forest

- 1 In Playback mode, select a photo and press **[MENU]**.
- 2 Select **[▶]** → **Photo Style Selector** → an option.
 - If you select **Custom RGB**, you can define your own RGB and photo style.

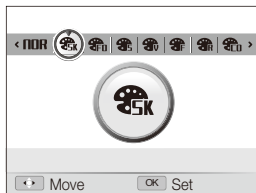

Defining your own RGB tone

- 1 In Playback mode, select a photo and press **[MENU]**.
- 2 Select **[▶]** → **Photo Style Selector**.
- 3 Scroll to **Custom RGB**.
- 4 Rotate **[Zoom]** right.
- 5 Select a color (R: Red, G: Green, B: Blue).

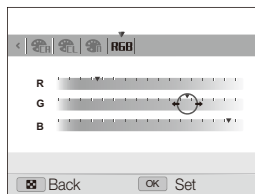

- 6 Adjust the amount of the selected color.
(-: less or +: more)

Applying smart filter effects

Apply various filter effects to your photos to create unique images. The edited photo will be saved as a new file but it could be resized to a lower resolution.



Miniature



Vignetting



Fish-eye

- 1 In Playback mode, select a photo and press **[MENU]**.
- 2 Select  → **Smart Filter**.
- 3 Select an effect.

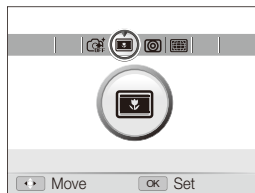

Correcting exposure problems

Remove red-eye; hide facial imperfections; adjust brightness, contrast, or saturation; or add noise to the photo. The edited photo will be saved as a new file but it could be resized to a lower resolution.

Removing red-eye



- 1 In Playback mode, select a photo and press **[MENU]**.
- 2 Select  → **Image Adjust** → **Red-eye Fix**.

Hiding facial imperfections

- 1 In Playback mode, select a photo and press **[MENU]**.
- 2 Select  → **Image Adjust** → **Face Retouch**.
- 3 Select a level.
 - As the number increases, the face becomes clearer.

Adjusting brightness/contrast/saturation

- 1 In Playback mode, select a photo and press **[MENU]**.
- 2 Select  → **Image Adjust**.
- 3 Select an adjustment option.

Option	Description
	Brightness
	Contrast
	Saturation

- 4 Select a value to adjust the selected item.
(-: less or +: more)

Adding noise to the photo

- 1 In Playback mode, select a photo and press **[MENU]**.
- 2 Select  → **Image Adjust** → **Add Noise**.

Creating a print order (DPOF)

Select photos to be printed and set options, such as number of copies or paper size. Because the customized options are saved in the MISC folder of the memory card, you can print photos conveniently by taking only the memory card to a print shop without your camera.



- The memory card can be taken to a print shop that supports DPOF (Digital Print Order Format) or you can print photos directly through a DPOF-compatible printer at home.
- Wide photos may print with the left and right edges cut off, so be aware of the dimensions of your photos.
- You cannot set the DPOF for the photos stored in the internal memory.

- 1 In Playback mode, press **[MENU]**.
- 2 Select → **DPOF** → **Standard** → an option.

Option	Description
Select	Print the selected photos.
All	Print all photos.
Reset	Reset your settings.

- 3 If you select **Select**, scroll to a photo and rotate **[Zoom]** left or right to select the number of copies. Repeat for the photos you want, and then press **[Fn]**.
 - If you select **All**, press **[DISP]** or to select the number of copies, and then press **[OK]**.

- 4 Press **[MENU]**.
- 5 Select → **DPOF** → **Size** → an option.

Option	Description
Select	Specify the print size for the selected photo.
All	Specify the print size for all photos.
Reset	Reset your settings.

- 6 If you select **Select**, scroll to a photo and rotate **[Zoom]** left or right to select the print size. Repeat for the photos you want, and then press **[Fn]**.
 - If you select **All**, press **[DISP]** or to select the print size, and then press **[OK]**.

Printing photos as thumbnails

- 1 In Playback mode, press **[MENU]**.
- 2 Select → **DPOF** → **Index** → **Yes**.



If you specify the print size, you can print photos only with DPOF 1.1-compatible printers.

Viewing files on a TV or HDTV

Play back photos or videos by connecting your camera to a TV using the A/V cable.

- 1 In Shooting or Playback mode, press **[MENU]**.
- 2 Select **⚙️** → **Video Out**.
- 3 Select a video signal output according to your country or region. (p. 106)
- 4 Turn off your camera and TV.
- 5 Connect your camera to your TV using the A/V cable.

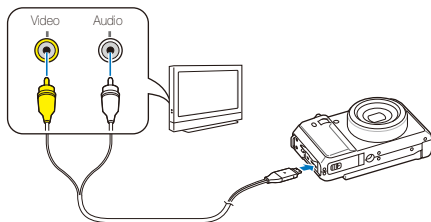

- On some TVs, digital noise may occur or part of an image may not appear.
- Images may not appear centered on the TV screen depending on your TV settings.
- You can capture photos or videos while the camera is connected to a TV.

- 6 Turn on your TV and select the video output mode using the TV remote control.
- 7 Turn on your camera and press **[▶]**.
- 8 View photos or play videos using the buttons on your camera.

Viewing files on an HDTV

You can view high-quality and uncompressed photos or videos on an HDTV using the optional HDMI cable. HDMI (High Definition Multimedia Interface) is supported by most HDTVs.

- 1 In Shooting or Playback mode, press **[MENU]**.
- 2 Select  → **HDMI Size**.
- 3 Select an HDMI resolution. (p. 107)
- 4 Turn off your camera and HDTV.

- 5 Connect your camera to your HDTV using the optional HDMI cable.

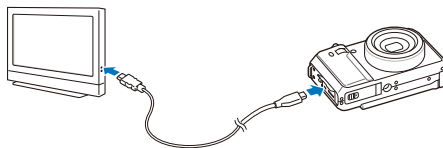

- 6 Turn on your camera.
 - The HDTV turns on automatically and the camera screen is displayed.
 - If you turn Anynet+ off, the HDTV does not turn on automatically.
- 7 View files using the buttons on your camera or the remote control of your HDTV.



- If your HDTV supports the Anynet+(CEC) profile, turn Anynet+ on in the settings menu (p. 107) to control all connected Samsung A/V devices with the TV remote control.
- Connection time to a HDTV may vary with the type of SD card used. A faster SD card will not necessarily result in a faster HDMI transfer, due to the main function of the card is to improve transfer rate during shooting.

Transferring files to your computer (for Windows)

Transfer files to your computer using the built-in Intelli-studio program. You can also edit files or upload files to your favorite websites.

Requirements

Item	Requirements
CPU	Intel® Pentium® 4, 3.0GHz or higher/ AMD Athlon™ FX, 2.2GHz or higher
RAM	Minimum 512MB RAM (1 GB and above recommended)
OS	Windows XP SP2/Vista/7
Hard disk capacity	250MB or more (1GB or more recommended)
Others	<ul style="list-style-type: none">• CD-ROM drive• nVIDIA Geforce 7600GT or higher/ATI X1600 series or higher• 1024 x 768 pixels, 16-bit color display compatible monitor (1280 x 1024 pixels, 32-bit color display recommended)• USB 2.0 port, Microsoft DirectX 9.0c or later



- Intelli-studio may not perform correctly on some computers, even when the computer meets the requirements.
- If your computer does not meet the requirements, videos may not play correctly or it may take longer to edit videos.
- Install DirectX 9.0c or above before you use the program.
- You must use Windows XP/Vista/7 or Mac OS 10.4 or later to connect the camera as a removable disk.





Using a self-assembled PC or a PC and OS that are not supported may void your warranty.

Transferring files using Intelli-studio

Intelli-studio starts automatically when you connect the camera to your computer with the USB cable.

 The battery charges while the camera is connected to a computer with the USB cable.

- 1 In Shooting or Playback mode, press **[MENU]**.
- 2 Select  → **PC Software** → **On**.
- 3 Turn off the camera.
- 4 Connect the camera to your computer with the USB cable.

 You must plug the end of the cable with the indicator light (▲) into your camera. If the cable is reversed, it may damage your files. The manufacturer is not responsible for any loss of data.

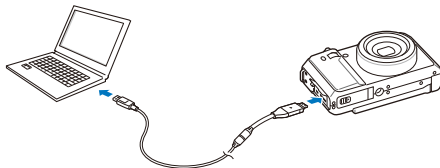

- 5 Turn on the camera.
 - The computer recognizes the camera automatically.

 If you set the USB option to **Select Mode**, select **Computer** from the pop-up window.

- 6 Select a folder on your computer to save new files to.
 - If your camera has no new files, the pop-up window for saving new files will not appear.
- 7 Select **Yes**.
 - New files are transferred to the computer.

 For Windows Vista and Windows 7, select **Run iStudio.exe** from the AutoPlay window.

Using Intelli-studio

Intelli-studio is a built-in program that allows you to play back and edit files. You can also upload files to websites, such as Flickr or YouTube. For details, select **Help** → **Help** in the program.



- If you install Intelli-studio on your computer, the program launches more quickly. To install the program, select **Tool** → **Install Intelli-studio on PC**.
- You cannot edit files directly on the camera. Transfer files to a folder on your computer before editing.
- You cannot copy files in your computer to the camera.
- Intelli-studio supports the following formats:
 - Videos: MP4 (Video: H.264, Audio: AAC), WMV (WMV 7/8/9), AVI (MJPEG)
 - Photos: JPG, GIF, BMP, PNG, TIFF

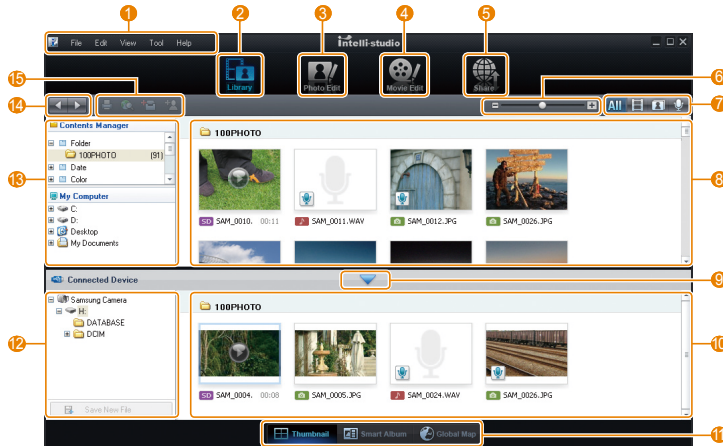

Number	Description
1	Open menus.
2	Display files in the selected folder.
3	Change to the Photo edit mode.
4	Change to the Video edit mode.
5	Change to the Sharing mode. (You can send files by email or upload files to websites, such as Flickr or YouTube.)
6	Enlarge or reduce the thumbnails in the list.
7	Select a file type.
8	View files of the selected folder on your computer.
9	Show or hide files of the connected camera.
10	View files of the selected folder on the camera.
11	View files as thumbnails, in Smart Album, or on a map.
12	Browse folders in the connected device.
13	Browse folders in your computer.
14	Move to the previous or next folder.
15	Print files, view files on a map, store files in My Folder, or register faces.

Transferring files by connecting the camera as a removable disk

You can connect the camera to your computer as a removable disk.

- 1 In Shooting or Playback mode, press **[MENU]**.
- 2 Select  → **PC Software** → **Off**.
- 3 Turn off the camera.
- 4 Connect the camera to your computer with the USB cable.



You must plug the end of the cable with the indicator light (▲) into your camera. If the cable is reversed, it may damage your files. The manufacturer is not responsible for any loss of data.

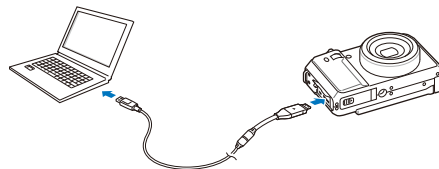

5 Turn on the camera.

- The computer recognizes the camera automatically.



If you set the USB option to **Select Mode**, select **Computer** from the pop-up window.

6 On your computer, select **My Computer** → **Removable Disk** → **DCIM** → **100PHOTO**.

7 Select the files you want and drag or save them to your computer.

Disconnecting the camera (for Windows XP)

The way to disconnect the USB cable for Windows Vista and 7 is similar.

- 1 If the status lamp on your camera is blinking, wait until it stops.
- 2 Click  on the tool bar at the bottom right of your PC screen.



- 3 Click the pop-up message.
- 4 Remove the USB cable.



The camera can not be removed safely when Intelli-studio is running. End the program before disconnecting the camera.

Transferring files to your computer (for Mac)

When you connect the camera to a Macintosh computer, the computer recognizes the camera automatically. You can transfer files directly from the camera to the computer without installing any programs.



Mac OS 10.4 or later is supported.

1 Connect your camera to a Macintosh computer with the USB cable.



You must plug the end of the cable with the indicator light (▲) into your camera. If the cable is reversed, it may damage your files. The manufacturer is not responsible for any loss of data.

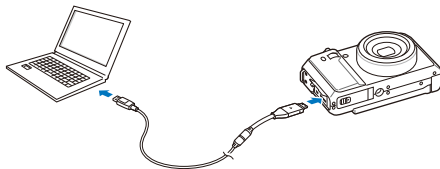

2 Turn on the camera.

- The computer recognizes the camera automatically and a removable disk icon is displayed.



If you set the USB option to **Select Mode**, select **Computer** from the pop-up window.

3 Double-click the removable disk icon.

4 Transfer photos or videos to the computer.

Using Samsung RAW Converter

Photos captured by a camera are often transformed to jpeg formats and stored in the memory according to the settings of the camera at the time of shooting. RAW files are not transformed to jpeg formats and are stored in the memory without any changes. With Samsung RAW Converter, you can calibrate exposures, white balances, tones, contrasts, and colors of photos.



- You can download the Samsung RAW Converter program for Macintosh from the Samsung website.
- The Samsung RAW Converter program supplied on the CD-ROM is compatible only with Windows XP and Vista.

Installing Samsung RAW Converter

- 1 Insert the installation CD in a compatible CD-ROM drive.
- 2 When the setup screen is displayed, click **Samsung Digital Camera Installer** to start installation.



- 3 Select **Samsung RAW Converter** from the program selection screen, and then click **Install**.
- 4 Follow the on-screen instructions to install Samsung RAW Converter.
- 5 When the installation is complete, click **Exit**.

Opening Samsung RAW Converter

On your computer, select **Start** → **All Programs** → **Samsung RAW Converter** → **Samsung RAW Converter**.

Using the Samsung RAW Converter Interface

For details about using Samsung RAW Converter, click **Help** → **Open software manual**.

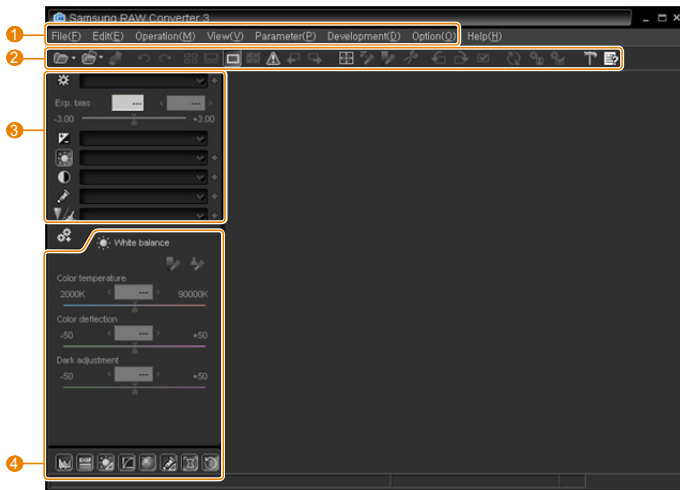

Number	Description
1	Menu
2	Toolbar

Number	Description
3	Editing tools
4	Open/Close the fine adjustment window for the editing tools

Editing RAW format files

If you edit the RAW format files with the Samsung RAW Converter, you can maintain high image quality. You can also edit JPEG and TIFF format files.

To adjust the exposure of of an image

- 1 Select **File** → **Open file** and open a file.
- 2 From the editing tools, select .
- 3 Adjust the exposure with the scroll bar.

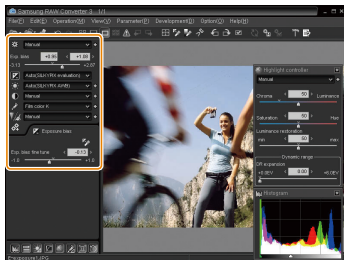

Original image
P Mode, Aperture: f=8,
Shutter Speed: 1/15 sec,
ISO=100



Changed image after correcting
the exposure

- You can view the brightness of the image from the histogram window.

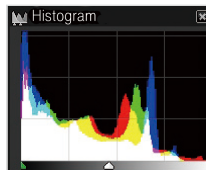

Original image

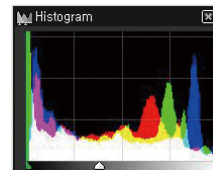

Changed image after correcting
the exposure

To adjust the tone of an image

- 1 Select **File** → **Open file** and open a file.
- 2 From the editing tools, select .
- 3 Adjust the tone with the scroll bar.

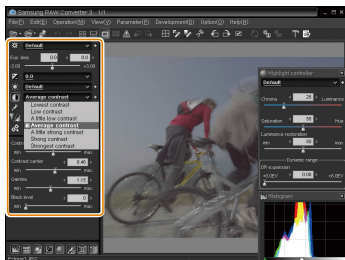

Original image
P Mode, Aperture: f=8,
Shutter Speed: 1/15 sec,
ISO=100



Changed image after correcting
the contrast

Saving RAW files as JPEG/TIFF formats

- 1 Select **File** → **Open file** and open a file.
- 2 Select **File** → **Development**.
- 3 Select a file format (JPEG or TIFF) and select **Save**.

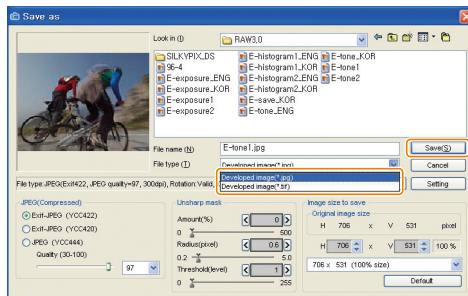



Printing photos with a photo printer (PictBridge)

Print photos with a PictBridge-compatible printer by connecting your camera directly to the printer.

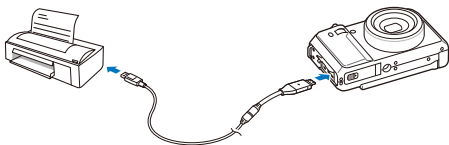
- 1 In Shooting or Playback mode, press **[MENU]**.
- 2 Select  → **USB**.
- 3 Select **Printer**.
- 4 With the printer on, connect your camera to the printer with the USB cable.



- 5 Turn on your camera.
 - The printer recognizes the camera automatically.
- 6 Press  or **[ISO]** to select a photo.
 - Press **[MENU]** to set printing options. See "Configuring print settings."
- 7 Press **[OK]** to print.
 - Printing starts. Press  to cancel printing.

Configuring print settings

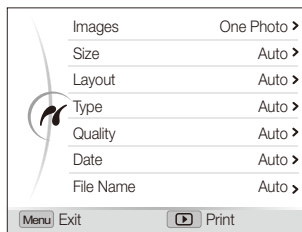

Option	Description
Images	Select whether to print the current photo or all photos.
Size	Specify the size of the print.
Layout	Create thumbnail prints.
Type	Select the type of paper.
Quality	Set the printing quality.
Date	Set to print the date.
File Name	Set to print the name of the file.
Reset	Reset the print options.



Some options are not supported by some printers.

Appendixes

Refer to settings, error messages, specifications, and maintenance tips.

Camera settings menu	103
Accessing the settings menu	103
Sound	104
Display	104
Settings	105
Error messages	108
Camera maintenance	109
Cleaning your camera	109
About memory cards	110
About the battery	111
Using optional accessories	114
Using optional flash units	114
Using an optional conversion lens	115
Using an optional remote control	116
Before contacting a service center	117
Camera specifications	120
FCC notice	124
Index	125



Camera settings menu

Learn about various options that configure your camera's settings.

Accessing the settings menu

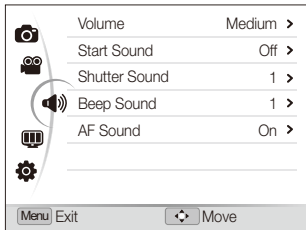
- 1 In Shooting or Playback mode, press **[MENU]**.
- 2 Select a menu.



Menu	Description
	Sound: Set various camera sounds and the volume. (p. 104)
	Display: Customize the display settings, such as brightness. (p. 104)
	Settings: Change the settings for the camera system, such as memory format, default file name, and USB mode. (p. 105)

- 3 Select an option and save your settings.

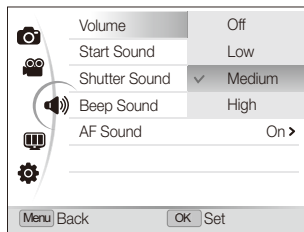

- 4 Press **[MENU]** to return to the previous screen.

Sound

* Default



Item	Description
Volume	Adjust the volume of any sound. (Off, Low, Medium*, High)
Start Sound	Select a sound to be emitted when you turn on your camera. (Off*, 1, 2, 3)
Shutter Sound	Select a sound to be emitted when you press the shutter button. (Off, 1*, 2, 3)
Beep Sound	Select a sound to be emitted when you press the buttons or switching modes. (Off, 1*, 2, 3)
AF Sound	Set a sound to be emitted when you half-press the shutter button. (Off, On*)

Display

* Default

Item	Description
Function Description	Display a brief description of an option or menu. (Off, On*)
Grid Line	Select a guide to help you compose a scene. (Off*, 3 X 3, 2 X 2, +, X)
Start Image	Set a start image to display when the camera turns on. <ul style="list-style-type: none"> • Off*: Display no start image. • Logo: Display a default image stored in the internal memory. • User Image: Display the image you want. (p. 84)  <ul style="list-style-type: none"> • Only one start image can be saved in the internal memory. • If you select a new photo as a start image or reset your camera, the current image is deleted. • A wide image or image in 3:2 ratio cannot be set as a start image.

* Default

Item	Description
Display Brightness	Adjust the brightness of the screen. (Auto*, Dark, Normal, Bright)  Normal is fixed in Playback mode even if Auto is selected.
Quick View	Set the duration for reviewing a captured image before returning to Shooting mode. (Off, 0.5 sec*, 1 sec, 3 sec)
Power Save	If you perform no operations for 30 seconds, the camera automatically switches to Power save mode. Press any button to deactivate the Power save mode. (Off*, On)  If the Power save mode is deactivated, the display will dim to save battery life when you perform no operations for about 30 seconds.



Settings

* Default

Item	Description
Format	Format the internal memory and the memory card. All files-including the protected files-are deleted. (No, Yes)  If you use a memory card used with cameras from other manufacturers or a memory card reader, or one formatted on a computer, your camera may read the card incorrectly. Format the card before using it.
Reset	Reset menus and shooting options. Date and time, language, and video output settings are not reset. (No, Yes)
Language	Select a language for the display text.
Time Zone	Select regions for the home time zone and the visit time zone. <ul style="list-style-type: none"> • Home: Set the time zone of your home country. Use this option when you reset the camera or when you return to your home country from another time zone. • Visit: If you are visiting a different time zone, use this option to set the time zone as a secondary clock. The secondary clock calculates the time in the current time zone based on your home time zone.

Item	Description
Date & Time	Set the date and time and select a date format. (Off*, dd/mm/yyyy, mm/dd/yyyy, yyyy/mm/dd)
File No.	Specify how to name files. <ul style="list-style-type: none"> • Reset: Set the file number to start from 0001 after inserting a new memory card, formatting a memory card, or deleting all files. • Series*: Set the file number to follow the previous file number after inserting a new memory card, formatting a memory card, or deleting all files.
	 <ul style="list-style-type: none"> • The default name of the first folder is 100PHOTO and the default name of the first file is SAM_0001. • The file number increases one at a time from SAM_0001 to SAM_9999. • The folder number increases one at a time from 100PHOTO to 999PHOTO. • The maximum number of files that can be stored in one folder is 9999. • The camera defines file names according to the Digital rule for Camera File system (DCF) standard. If you change the names of files intentionally, the camera may not play back the files.

* Default

Item	Description
Imprint	Set whether to print the date and time on your photos when printing. (Off*, Date, Date & Time)  <ul style="list-style-type: none"> • The date and time will be displayed on the bottom-right corner of the photo in yellow. • The date and time may not be printed on some printer models. • If you select Text in the SCN mode, the date and time is not printed.
Auto Power Off	Set the camera to automatically turn off when you are not using it. (Off, 1 min, 3 min*, 5 min, 10 min)  <ul style="list-style-type: none"> • Your settings will not change after you replace the battery. • The camera will not automatically turn off when: <ul style="list-style-type: none"> - It is connected to a computer or printer. - You are playing a slide show or videos. - You are recording a voice memo.
Video Out	Set the video signal output according to your region. <ul style="list-style-type: none"> • NTSC*: USA, Canada, Japan, Korea, Taiwan, Mexico. • PAL (supports only BDGHI): Australia, Austria, Belgium, China, Denmark, Finland, Germany, England, Italy, Kuwait, Malaysia, New Zealand, Singapore, Spain, Sweden, Switzerland, Thailand, Norway.

* Default

Camera settings menu

* Default

Item	Description
AF Lamp	Set an assistant light to help you focus in dark places. (Off, On*)
Conversion lens	Set to use an optional conversion lens with your camera. (Off*, On)
Remote	Set to use an optional remote control with your camera. (Off*, On)
Anynet+ (HDMI-CEC)	Set to control the camera connected to a Samsung HDTV that supports Anynet+(CEC) with the TV remote control. <ul style="list-style-type: none"> • Off: View files without using an HDTV remote control. • On*: Control the camera with an HDTV remote control.
HDMI Size	Select the resolution of photos when playing back files on an HDTV with the HDMI cable. (NTSC: 1080i* , 720p , 480p / PAL: 1080i* , 720p , 576p)  <ul style="list-style-type: none"> • If the HDTV does not support the selected resolution, the HDTV automatically selects the next lower resolution. • If you select 480p or 576p, the playback menus and Smart Album are not available when the camera is connected to a TV.

* Default

Item	Description
USB	Set the function the camera uses when it is connected to a computer or printer via a USB cable. <ul style="list-style-type: none"> • Select Mode*: Select a USB mode when you connect your camera to another device. • Computer: Connect your camera to a computer for transferring files. • Printer: Connect your camera to a printer for printing files.
PC Software	Set Intelli-studio to start automatically when you connect your camera to your computer. (Off, On*)

Error messages

When the following error messages appear, try these remedies.

Error message	Suggested remedies
Card Error	<ul style="list-style-type: none">• Turn off your camera and then turn it on again.• Remove your memory card and insert it again.• Format your memory card. (p. 105)
Card Locked	Unlock the memory card. 
Card not supported.	The inserted memory card is not compatible with your camera. Insert a SD or SDHC memory card.
DCF Full Error	File names do not match the DCF standard. Transfer the files on the memory card to your computer and format the card. (p. 105)
File Error	Delete the damaged file or contact a service center.
File system not supported.	Your camera does not support the FAT file structure of the inserted memory card. Format the memory card on the camera.
Low Battery	Insert a charged battery or recharge the battery.
Memory Full	Delete unnecessary files or insert a new memory card.
No Image File	Take photos or insert a memory card that has some photos.

Camera maintenance

Cleaning your camera

Camera lens and display

Use a blower brush to remove dust and wipe the lens gently with a soft cloth. If any dust remains, apply lens cleaning liquid to a piece of cleaning paper and wipe gently.

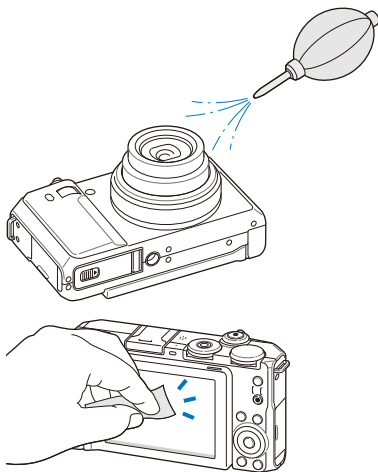

Camera body

Wipe gently with a soft, dry cloth.

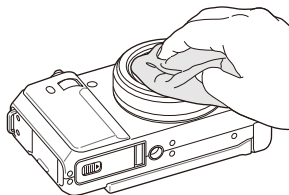

- Never use benzene, thinners, or alcohol to clean the device. These solutions can damage the camera or cause it to malfunction.
- Do not press on the lens cover or use a blower brush on the lens cover.

About memory cards

Memory cards you can use

You can use SD (Secure Digital), or SDHC (Secure Digital High Capacity) memory cards.

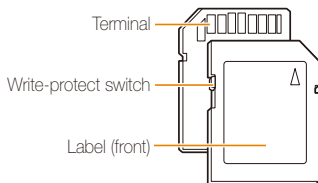

You can prevent files from being deleted by using a write-protect switch on the SD or SDHC card. Slide the switch down to lock or slide it up to unlock. Unlock the card when shooting.

Memory card capacity

The memory capacity may differ depending on shooting scenes or shooting conditions. These capacities are based on a 1 GB SD card:

	Size	Super Fine	Fine	Normal	RAW	RAW + S.Fine	RAW + Fine	RAW + Normal
P h o t o s	10M	180	328	451	41	31	37	39
		201	363	497	42	32	37	40
	8M	220	392	531	42	33	38	40
		235	420	568	42	34	38	40
		235	419	568	42	34	38	40
	5M	319	542	707	43	36	40	42
	3M	471	746	928	44	39	42	43
		645	967	1,161	45	41	43	44
	1M	1,056	1,331	1,458	46	43	44	44

	Size	30 FPS	15 FPS
* V i d e o s	640	Approx. 25' 50"	Approx. 48' 36"
	320	Approx. 68' 47"	Approx. 99' 53"

* The recordable time may vary if you use the zoom.
Several videos were recorded in succession to determine the total recording time.

About the battery

Use only Samsung-approved batteries.

Battery specifications

Mode	SLB-11A
Type	Lithium-ion battery
Cell capacity	1130 mAh
Voltage	3.8 V
Charging time (when the camera is switched off)	Approx. 150 min

Battery life

Shooting time / Number of photos		Shooting conditions (when the battery is fully charged)
Photos	Approx. 120 min/ Approx. 240 shots	<p>This is measured under the following conditions: in the P mode, 10M resolution, Fine quality, OIS on.</p> <ol style="list-style-type: none"> 1. Set the flash option to Fill in, zoom in or out, and take a single shot. 2. Set the flash option to Off, zoom in or out, and take a single shot. 3. Perform steps 1 and 2 for 30 seconds and repeat for 5 minutes. Then turn off the camera for 1 minute. 4. Repeat steps 1 to 3.
Videos	Approx. 100 min	Record videos at 640 X 480 resolution and 30 fps.

- The figures above are based on Samsung's test standards. Your results may differ depending on your actual usage.
- Several videos were recorded in succession to determine the total recording time.

Notes about charging the battery

- If the indicator light is off, make sure that the battery is inserted correctly.
- Turn off your camera when charging.
- Turn on your camera after charging the battery for more than 10 minutes.
- Using the flash or recording videos depletes the battery quickly. Charge the battery until the indicator light turns green.
- If the indicator light blinks in orange or does not illuminate, reconnect the cable, or remove the battery and insert it again.
- If you charge the battery when the cable is overheated or the temperature is too high, the indicator light may turn orange. Charging will start when the battery cools down.

Notes about charging with a computer connected

- Use only the provided USB cable.
- The battery may not be charged when:
 - You use a USB hub.
 - Other USB devices are connected to your computer.
 - You connect the cable to the port on the front side of your computer.
 - The USB port of your computer does not support the power output standard (5 V, 500 mA).



Personal injury or death can occur if the battery is handled carelessly or improperly. For your safety, follow these instructions for proper battery handling:

- The battery can ignite or explode if not handled properly. If you notice any deformities, cracks, or other abnormalities in the battery, immediately discontinue use of the battery and contact your manufacturer.
- Use only authentic, manufacturer-recommended battery chargers and adapters and charge the battery only by the method described in this user manual.
- Do not place the battery near heating devices or expose to excessively warm environments, such as the inside of an enclosed car in the summertime.
- Do not place the battery in a microwave oven.
- Avoid storing or using the battery in hot, humid places, such as spas or shower enclosures.
- Do not rest the device on flammable surfaces, such as bedding, carpets, or electric blankets for a prolonged period.
- When the device is switched on, do not leave it in any confined space for a prolonged period.
- Do not allow battery terminals to come in contact with metallic objects, such as necklaces, coins, keys, or watches.
- Use only authentic, manufacturer-recommended, Lithium-ion replacement batteries.

- Do not disassemble the battery or puncture the battery with any sharp object.
- Avoid exposing the battery to high pressure or crushing forces.
- Avoid exposing the battery to major impacts, such as dropping it from high places.
- Do not expose the battery to temperatures of 60° C (140° F) or above.
- Do not allow the battery to come in contact with moisture or liquids.
- Battery shall not be exposed to excessive heat such as sunshine, fire or the like.

Disposal guidelines

- Dispose of the battery with care.
- Do not dispose of the battery in a fire.
- Disposal regulations may differ by country or region. Dispose of the battery in accordance with all local and federal regulations.

Guidelines for charging the battery

Charge the battery only by the method described in this user manual. The battery can ignite or explode if not charged properly.

Using optional accessories

Using optional flash units

Attach an optional flash unit to the camera accessory shoe. Remove the accessory shoe cover and mount the flash unit on the accessory shoe.

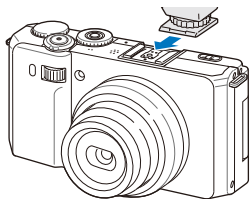

- For details about the flash unit, see the manual provided with the flash unit.
- Your camera is compatible with the following types of flash units: SEF20A, SEF42A
- Fully charge the flash unit before using with your camera.
- When the optional flash unit is attached, do not pop the default flash up.

Using an optional conversion lens

You can increase your camera's range and depth of field by attaching an optional conversion lens.

- 1 Remove the stock camera ring by turning it counter-clockwise.

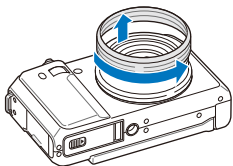

- 2 Mount the conversion lens by turning it clockwise until it locks into place.

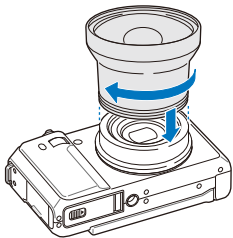

- 3 In Shooting or Playback mode, press **[MENU]**.

- 4 Select  → **Conversion lens** → **On**.



- After setting to use the conversion lens, the optical and digital zooms are not available.
- If you do not set **Conversion lens** to **On** after attaching the conversion lens, rotating **[Zoom]** left or right will turn your camera off.

Using an optional remote control

The camera takes a photo 2 seconds after you press the shutter button on the remote control. You can use the remote control only when the drive mode dial is rotated to .

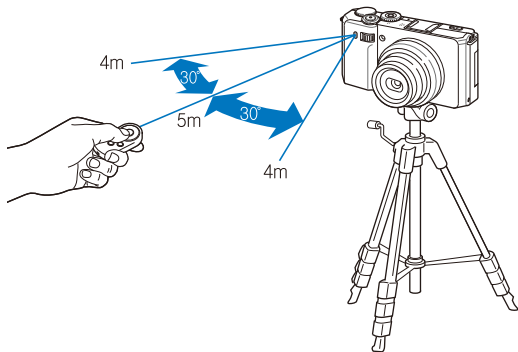



- 1 In Shooting or Playback mode, press **[MENU]**.
- 2 Select  → **Remote** → **On**.

Before contacting a service center

If you are having trouble with your camera, try these troubleshooting procedures before contacting a service center. If you have attempted the troubleshooting solution and are still having problems with your device, contact your local dealer or service center.

Situation	Suggested remedies
Cannot turn on the camera	<ul style="list-style-type: none"> • Make sure that the battery is inserted. • Make sure that the battery is inserted correctly. • Charge the battery.
The power turns off suddenly	<ul style="list-style-type: none"> • Charge the battery. • Your camera may be in Power save mode. (p. 105) • The camera may turn off to prevent the memory card from being damaged due to an impact. Turn on your camera again.
The camera is losing battery power quickly	<ul style="list-style-type: none"> • The battery may lose power more quickly in low temperatures (below 0° C). Keep the battery warm by putting it into your pocket. • Using the flash or recording videos depletes the battery quickly. Recharge if needed. • Batteries are consumable parts that must be replaced over time. Get a new battery if the battery life is diminishing quickly.

Situation	Suggested remedies
Cannot take photos	<ul style="list-style-type: none"> • There is no space on the memory card. Delete unnecessary files or insert a new card. • Format the memory card. (p. 105) • The memory card is defective. Get a new memory card. • The memory card is locked. Unlock the card. (p. 110) • Make sure that the camera is switched on. • Charge the battery. • Make sure that the battery is inserted correctly.
The camera freezes	Remove the battery and insert it again.
The flash does not work	<ul style="list-style-type: none"> • The flash option may be set to Off. (p. 52) • You cannot use the flash in the  DUAL, , or some SCN modes.
The flash fires unexpectedly	The flash may fire due to static electricity. This is not a malfunction of the camera.

Situation	Suggested remedies
The date and time are incorrect	Set the date and time in the display settings menu. (p. 106)
The display or buttons do not work	Remove the battery and insert it again.
The camera screen works poorly	If you use your camera at low temperatures, it will cause the camera screen to malfunction or discolor. For better performance of your camera screen, use your camera at normal temperatures.
The memory card has an error	The memory card has not been formatted. Format the card. (p. 105)
Cannot play back files	If you change the name of a file, your camera may not play the file (the name of the file should meet the DCF standard). If you encounter this situation, play back files on your computer.
The photo is blurry	<ul style="list-style-type: none"> • Make sure that the focus option you set is suitable for close-up shots. (p. 56) • Make sure that the lens is clean. If not, clean the lens. (p. 109) • Make sure that the subject is within range of the flash. (p. 120)

Situation	Suggested remedies
The colors in the photo do not match the actual scene	An incorrect white balance can create unrealistic color. Select the proper white balance option to suit the light source. (p. 67)
The photo is too bright	Your photo is overexposed. <ul style="list-style-type: none"> • Adjust the aperture value or the shutter speed. (p. 39) • Turn off the flash. (p. 52) • Adjust the ISO speed. (p. 55) • Adjust the exposure value. (p. 65)
The photo is too dark	Your photo is underexposed. <ul style="list-style-type: none"> • Adjust the aperture value or the shutter speed. (p. 39) • Turn on the flash. (p. 52) • Adjust the ISO speed. (p. 55) • Adjust the exposure value. (p. 65)
The TV does not display your photos	<ul style="list-style-type: none"> • Make sure that the camera is correctly connected to the external monitor with the A/V cable. • Make sure that your memory card contains photos.

Situation	Suggested remedies
An optional flash unit does not fire	<ul style="list-style-type: none"> • Make sure that the optional flash unit is turned on. • Make sure that the optional flash unit is correctly mounted on the accessory shoe.
Your computer does not recognize your camera	<ul style="list-style-type: none"> • Make sure that the USB cable is connected correctly. • Make sure that your camera is switched on. • Make sure that you are using a supported operating system.
Your computer disconnects the camera while transferring files	The file transfer may be interrupted by static electricity. Disconnect the USB cable and connect it again.
Your computer cannot play videos	You can play videos only with the Intelli-studio program. Install the program on your computer. (p. 93)

Situation	Suggested remedies
Intelli-studio is not functioning properly	<ul style="list-style-type: none"> • End Intelli-studio and restart the program. • You cannot use Intelli-studio on Macintosh computers. • Make sure that the PC Software is set to On in the settings menu. (p. 107) • Depending on your computer's specification and environments, the program may not launch automatically. In this case, click Start → My Computer → Intelli-studio → iStudio.exe on your computer.
Cannot set the DPOF for RAW files	You cannot set the DPOF for RAW files.
Cannot lock the exposure value by pressing [AEL]	You cannot lock the exposure value in  mode.

Camera specifications

Image sensor			
Type	1/1.7" (Approx. 10.9 mm) High Sensitive CCD		
Effective pixels	Approx. 10 mega-pixels		
Total pixels	Approx. 10 mega-pixels		
Lens			
Focal length	Schneider-KREUZNACH lens f = 5.2 - 15.6 mm (35 mm film equivalent: 24 - 72 mm)		
F-stop range	F1.8 (W) - F2.4 (T)		
Digital zoom	<ul style="list-style-type: none"> • Still image mode: 1.0X - 4.0X • Play mode: 1.0X - 11.4X (depending on image size) 		
Display			
Type	AMOLED		
Feature	3.0" (Approx. 7.6 cm) VGA Rotating		
Focusing			
Type	TTL auto focus (Center AF, Multi AF, Selection AF, Tracking AF, Face Detection AF, Smart Face Recognition AF)		
Range		Wide (W)	Tele (T)
	Normal (AF)	80 cm - infinity	80 cm - infinity
	Macro	5 cm - 80 cm	50 cm - 80 cm
	Auto Macro	5 cm - infinity	50 cm - infinity
	Manual Focus	5 cm - infinity	50 cm - infinity

Shutter speed

- Auto: 1/8 - 1/1,500 sec.
- Program: 1 - 1/1,500 sec.
- Aperture Priority, Shutter Priority, Manual: 16 - 1/1,500 sec
- Night: 8 - 1/1,500 sec.
- Fireworks: 2 sec.

Exposure

Control	Program AE, Shutter Priority AE, Aperture Priority AE, Manual Exposure
Metering	Multi, Spot, Center-weighted
Compensation	±2EV (1/3EV steps)
ISO equivalent	Auto, 80, 100, 200, 400, 800, 1600, 3200

Flash

Mode	Off, Auto, Red-eye, Fill in, Slow Sync, Red-eye Fix
Range	<ul style="list-style-type: none"> • Wide: 0.2 m - 6.2 m (ISO Auto) • Tele: 0.5 m - 5.1 m (ISO Auto)
Recharging time	Approx. 4 sec. (depending on battery condition)

Shake reduction

DUAL IS [Optical Image Stabilization (OIS) + Digital Image Stabilization (DIS)]

Camera specifications

Effect		
Shooting mode	<ul style="list-style-type: none"> Photo Style Selector: Normal, Sketch, Defog, Soft, Vivid, Forest, Retro, Cool, Calm, Classic, Negative, Custom RGB Image Adjust: Sharpness, Contrast, Saturation Smart Filter: Normal, Miniature, Vignetting, Fish-eye 	
White Balance		
Auto WB, Daylight, Cloudy, Fluorescent_H, Fluorescent_L, Tungsten, Custom Set, Color Temperature		
Date Imprinting		
Date & Time, Date, Off		
Shooting		
Photos	<ul style="list-style-type: none"> Modes: Smart Auto (White, Macro Color, Fireworks, Portrait, Night Portrait, Backlight Portrait, Macro Portrait, Backlight, Landscape, Action, Tripod, Night, Macro, Macro Text, Blue Sky, Sunset, Natural Green), Auto, Program, DUAL IS, Beauty Shot, Night, Scene (Frame Guide, Portrait, Landscape, Close Up, Text, Sunset, Dawn, Backlight, Fireworks, Beach & Snow) Drive: Single, Continuous, Bracket Timer: 10 Sec, 2 Sec, Remote (Optional) 	
		<ul style="list-style-type: none"> Modes: Smart Scene Detection (Landscape, Blue Sky, Natural Green, Sunset Sky), Movie Format: H.264 (MPEG-4, AVC), (Max recording time: 20 min) Size: 640 X 480 (30 FPS, 15 FPS), 320 X 240 (30 FPS, 15 FPS) Frame Rate: 30 FPS, 15 FPS Voice: Off, On, Zoom Mute OIS: On, Off Video editing (embedded): Pause during recording, Still image capture, Time trimming
		Playback
		Single image, Thumbnails, Multi slide show, Movie clip, Smart Album * Smart Album category: Type, Date, Color, Week, Face
		Edit
		Resize, Rotate, Photo Style Selector, Image Adjust
		Effect
		<ul style="list-style-type: none"> Photo Style Selector: Normal, Sketch, Defog, Soft, Vivid, Forest, Retro, Cool, Calm, Classic, Negative, Custom RGB Image Adjust: Red-eye Fix, Face Retouch, Brightness, Contrast, Saturation, Add Noise Smart Filter: Normal, Miniature, Vignetting, Fish-eye

Voice recording

- Voice Recording (Max 10 hours)
- Voice Memo in a photo (Max. 10 sec.)

Storage

Media	<ul style="list-style-type: none"> • Internal memory: Approx. 22 MB • External memory (Optional): <ul style="list-style-type: none"> - SD card (up to 4 GB guaranteed) - SDHC card (up to 8 GB guaranteed) <p>Internal memory capacity may not match these specifications.</p>
File format	<ul style="list-style-type: none"> • Photo: JPEG (DCF), EXIF 2.21, DPOF 1.1, PictBridge 1.0 • Video: H.264 (MPEG-4.AVC) • Audio: AAC

		For 1GB SD						
		Super Fine	Fine	Normal	RAW	RAW + S.Fine	RAW + Fine	RAW + Normal
Image size	10M	180	328	451	41	31	37	39
	4M	201	363	497	42	32	37	40
	8M	220	392	531	42	33	38	40
	7M	235	420	568	42	34	38	40
	1M	235	419	568	42	34	38	40
	5M	319	542	707	43	36	40	42
	3M	471	746	928	44	39	42	43
	2M	645	967	1,161	45	41	43	44
	1M	1,056	1,331	1,458	46	43	44	44
		These figures are measured under Samsung's standard conditions and may vary depending on shooting conditions and camera settings.						
Interface								
Digital output connector	USB 2.0							
Audio output	Mono (Internal speaker), Mono (Microphone)							
Video output	<ul style="list-style-type: none"> • AV: NTSC, PAL (selectable) • HDMI 1.4: NTSC, PAL (selectable) 							
DC power input connector	20 pin, 4.4 V							

Power source

Rechargeable
battery

Lithium-ion battery (SLB-11A, 1130 mAh)

The power source may differ depending on your region.

Dimensions (W x H x D)

114.4 x 64.6 x 30 mm

Weight

356 g (without battery and memory card)

Operating temperature

0 - 40° C

Operating humidity

5 - 85 %

Software

Intelli-studio, Samsung RAW Converter

Specifications are subject to change without prior notice.

- **NOTE:**

This equipment has been tested and found to comply with the limits for a Class B digital device, pursuant to part 15 of the FCC Rules. These limits are designed to provide reasonable protection against harmful interference in a residential installation. This equipment generates, uses and can radiate radio frequency energy and, if not installed and used in accordance with the instructions, may cause harmful interference to radio communications. However, there is no guarantee that interference will not occur in a particular installation. If this equipment does cause harmful interference to radio or television reception, which can be determined by turning the equipment off and on, the user is encouraged to try to correct the interference by one or more of the following measures:

- Reorientate, or relocate, the receiving antenna.
- Increase the distance between the equipment and receiver.
- Connect the equipment into an outlet on a circuit different from that to which the receiver is connected.
- Consult the dealer or an experienced radio / TV technician for help.

- **CAUTION:**

Changes or modifications not expressly approved by the manufacturer responsible for compliance could void the user's authority to operate the equipment.

- **Declaration of Conformity**

Trade Name	: Samsung Electronics America, Inc.
Model No.	: Samsung TL500
Responsible Party	: Samsung Electronics America, Inc.
Address	: 105 Challenger Road Ridgefield Park NJ
Telephone No.	: 1-800-SAMSUNG (726-7864)

This device complies with Part 15 of the FCC Rules.

Operation is subject to the following two conditions:

- (1) This device may not cause harmful interference, and
- (2) this device must accept any interference received, including interference that may cause undesired operation.



Samsung Eco-mark

It is Samsung's own symbol mark is used to effectively communicate Samsung's environmental friendly product activities to the consumers. The mark represents Samsung's continuous effort on development of environmental conscious products.

Index

A

Adjusting

- Brightness 87
- Contrast
 - in Playback mode 87
 - in Shooting mode 73
- Saturation
 - in Playback mode 87
 - in Shooting mode 73
- Sharpness 73

AEL 66

AF Lamp 107

AF Sound 104

Anynet+ 107

Aperture Priority mode 39

Aperture value 38

Auto mode 27

B

Battery

- Charging 112
- Life 111
- Specifications 111

Beauty Shot mode 35

Blink detection 62

C

Camera shake 30

Capturing an image from a video 83

Cleaning

- Body 109
- Display 109
- Lens 109

D

Date and time 106

Deleting files 80

Digital Image Stabilization 41

Digital zoom 28

Disconnecting the device 95

Display brightness 105

Display type 26

DPOF 88

Drive mode dial 17

Dual IS mode 41

E

Editing 84

Enlarging 81

Error messages 108

Exposure 65

F

Face detection

- Blink Detection 62
- Normal 60
- Self-portrait 61
- Smart Face Recognition 62
- Smile Shot 61

Facial brightness 35

Flash

- Auto 53
- Fill in 53
- Off 52
- Red-eye 53
- Red-eye Fix 53
- Slow Sync 53

Focus area

- Center AF 59
- Multi AF 59
- Selection AF 57
- Tracking AF 59

Focus distance

- Auto Macro 56
- Macro 56
- Manual Focus 57
- Normal (AF) 56

Format 105

Frame rate 42

Function button 16

Function description 104

G

Grid lines 104

H

Half-pressing 7

HDMI Size 107

HDTV 90

High Dynamic Range 74

I

Icons 23

Image adjust

- add noise 87
- brightness 87
- contrast 87
- face retouch 87
- red-eye fix 87
- saturation 87

Imprint 106

Intelli-studio 93

ISO speed 55

L

Light source
(White balance) 67

Locking exposure 66

M

Macro 56

Maintenance 109

Manual mode 40

Memory card

- Capacity 110
- SD 110
- SDHC 110

MENU button 16

Metering

- Center-weighted 67
- Multi 67
- Spot 66

Mode dial 17

Movie mode 42

Muting

- Camera 21
- Video 42

My Star

- Canceling faces 77
- Ranking 77
- Registering faces 63

N

Navigation button 16

O

Opening flash 52

Opening screen 18

Optical Image
Stabilization (OIS) 29, 41

P

Photo quality 48

Photo styles

- in Playback mode 85
- in Shooting mode 71

Playback button 21

Playback mode 76

Printing photos 101

Print order 88

Program mode 37

Protecting files 79

Q

Quick View 105

R

RAW files 48

Recording

- Video 42
- Voice memo 45

Red-eye

- in Playback mode 87
- in Shooting mode 52

Reset 105**Resizing 84****Resolution**

- Photo 47
- Video 47

RGB tone

- in Playback mode 85
- in Shooting mode 71

Rotating

- Photo 84
- Screen 18

S**Samsung RAW Converter 97****Scene mode 35****SD, SDHC 110****Self-portrait 61****Service center 117****Settings**

- Accessing 103
- Camera 105
- Display 104
- Sound 104

Shooting mode

- Aperture Priority 39
- Dual IS 41
- Manual 40
- Movie 42
- Program 37
- Scene 35
- Shutter Priority 39
- Smart Auto 33

Shutter Priority mode 39**Shutter speed 38****Slide show 81****Smart Album 78****Smart Auto mode 33****Smart Face Recognition 62****Smart filter effect**

- in Playback mode 86
- in Shooting mode 72

Smart Scene Detection mode 43**Smile shot 61****Start image 104****T****Timer 49****Tracking focus 58****Transferring files**

- for Mac 96
- for Windows 91

V**Video**

- Playing 82
- Recording 42

Video Out 106**Viewing files**

- as thumbnails 79
- by category 78
- on TV 89
- Slide show 81

Voice memo

- Playing 83
- Recording 45

Volume 104**W****White Balance 67****Z****Zoom button 16****Zooming 28**



Please refer to the warranty that came with your product or visit our website <http://www.samsung.com/> for after-sales service or inquiries.



Download from [Www.Somanuals.com](http://www.Somanuals.com). All Manuals Search And Download.

Free Manuals Download Website

<http://myh66.com>

<http://usermanuals.us>

<http://www.somanuals.com>

<http://www.4manuals.cc>

<http://www.manual-lib.com>

<http://www.404manual.com>

<http://www.luxmanual.com>

<http://aubethermostatmanual.com>

Golf course search by state

<http://golfingnear.com>

Email search by domain

<http://emailbydomain.com>

Auto manuals search

<http://auto.somanuals.com>

TV manuals search

<http://tv.somanuals.com>