

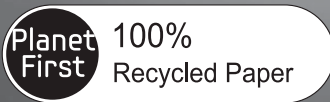

DW-FG720 Series
DW-FG520 Series

Dishwasher user manual



This manual is made with 100% recycled paper.

imagine the possibilities

Thank you for purchasing this Samsung product. To receive a more complete service, please register your product at

www.samsung.com/register



Features of your new Samsung dishwasher

Your new dishwasher will change the way you feel about washing kitchenware. From its specialised features to its energy efficiency, your new Samsung dishwasher ensures that washing your kitchenware is as easy and enjoyable as possible.

1. 3-Tier Filtration System

Your new Samsung dishwasher's 3-tier filtration system filters every last bit of food from your dishes, cups, cooking utensils and cutlery. The advanced filtration system thoroughly filters out and collects all food remains so that you can rest assured knowing that your dishes will come out spotless.

Samsung dishwashers have the most powerful filtration systems in their class.

2. Condensing Drying Technology

Your new Samsung dishwasher utilizes the latent thermal energy from the final rinse cycle to drying the load. This not only saves energy, but also prevents steam from escaping the dishwasher and injuring you and your loved ones.

This user manual contains important information concerning the use and care of your new Samsung dishwasher. Refer to the manual for detailed instructions on using the control panel and for tips on how to get the best out of the latest features and technologies of your new dishwasher. The "Programme Chart" section contains a summarised table of the available programmes, and the "Troubleshooting" section contains information on solving common problems.

Safety instructions

Congratulations on your new Samsung dishwasher. This manual contains important information on the installation, use and care of your appliance. Please take time to read this manual to take full advantage of your dishwasher's many benefits and features.

WHAT YOU NEED TO KNOW ABOUT SAFETY INSTRUCTIONS











Please read this manual thoroughly to ensure that you know how to safely and efficiently operate the extensive features and functions of your new appliance and retain it at a safe place near the appliance for your future reference. Use this appliance only for its intended purpose as described in this user manual.

Warning and important safety instructions in this manual do not cover all possible conditions and situations that may occur. It is your responsibility to use common sense, caution, and care when installing, maintaining, and operating your dishwasher.

Because the following operating instructions cover various models, the characteristics of your dishwasher may differ slightly from those described in this manual and not all warning signs may be applicable. If you have any questions or concerns, contact your nearest service centre or find help and information online at www.samsung.com.

IMPORTANT SAFETY SYMBOLS AND PRECAUTIONS

Important safety symbols







	Hazards or unsafe practices that may result in severe personal injury and/or property damage.
	Hazards or unsafe practices that may result in personal injury and/or property damage.
	To reduce the risk of fire, explosion, electric shock, or personal injury when using your dishwasher, follow these basic safety precautions:
	Do NOT attempt.
	Do NOT disassemble.
	Do NOT touch.
	Follow directions explicitly.
	Unplug the power plug from the wall socket.
	Make sure the appliance is grounded to prevent electric shock.
	Call the service centre for help.
	Note

These warning symbols are here to prevent injury to you and others. Please follow them explicitly.













Keep these instructions in a safe place and ensure that new users are familiar with the content. Pass them on to any future owner.

Safety instructions



Important safety precautions

-  This appliance conforms to current safety requirements. Inappropriate use can, however, lead to personal injury and damage to property.
To avoid the risk of accidents and damage to the appliance, please read these instructions carefully before using it for the first time. They contain important information on its safety, use and maintenance.
-  As with any equipment using electricity and moving parts, potential hazards exist. To safely operate this appliance, become familiar with its operation and exercise care when using it.
-  Do not let children (or pets) play on or in your dishwasher. The dishwasher door does not open easily from the inside, and children may be seriously injured if trapped inside.
-  Children should be supervised to ensure that they do not play with the appliance.
-  If the plug (power supply cord) is damaged, it must be replaced by the manufacturer or its service agent or a similarly qualified person in order to avoid a hazard.
-  This appliance must be positioned to be accessible to the power plug after installation, the water supply tabs and the drain pipes.

INSTRUCTIONS WHEN USING YOUR DISHWASHER

-  This dishwasher is not designed for commercial use. It is intended for use in domestic households and in similar working and residential environments such as:
 - Shops
 - Offices and showroomsand by residents in establishments such as:
 - Hostels and guest houses.
-  It must only be used as a domestic appliance as specified in these user manual, for cleaning domestic crockery and cutlery. Any other usage is not supported by the manufacturer and could be dangerous.
-  The manufacturer cannot be held liable for damage resulting from incorrect or improper use or operation.
-  Do not use solvents in the dishwasher. Danger of explosion.
-  Do not inhale or ingest dishwasher detergent. Dishwasher detergents contain irritant or corrosive ingredients which can cause burning in the nose, mouth and throat if swallowed, or inhibit breathing. Consult a doctor immediately if detergent has been swallowed or inhaled.
-  Avoid leaving the door open unnecessarily, as you could trip over it.
-  Do not sit or lean on the opened door. This could cause the dishwasher to tip and be damaged, and you could get injured.
-  Only use detergent and rinse aid formulated for domestic dishwashers. Do not use washing-up liquid.
-  Do not fill the rinse aid reservoir with powder or liquid detergent. This will cause serious damage to the reservoir.
-  In an appliance with a cutlery basket (depending on model), cutlery is cleaned and dried more if placed in efficiently the basket with the handles downwards. However, to avoid the risk of injury, place knives and forks etc. with the handles upwards.
-  Plastic items which cannot withstand being washed in hot water, such as disposable plastic containers, or plastic cutlery and crockery should not be cleaned in the dishwasher. The high temperatures in the dishwasher may cause them to melt or lose shape.
-  On models with **Delay Start** function, make sure that the dispenser is dry before adding detergent. Wipe dry if necessary. Detergent will clog if poured into a damp dispenser and may not be thoroughly dispersed.
-  Knives and other utensils with sharp points must be loaded in the basket with their points down or placed in a horizontal position.

INSTRUCTIONS FOR PROTECTING YOUR CHILDREN

-  This appliance is not a toy! To avoid the risk of injury, keep children well away and do not allow them to play in or around the dishwasher or to use the controls. They will not understand the potential dangers posed by it. They should be supervised whenever you are working in the kitchen. There is also a danger that children playing might shut themselves in the dishwasher.
-  This appliance can be used by children aged from 8 years and above and persons with reduced physical, sensory or mental capabilities or lack of experience and knowledge if they have been given supervision or instruction concerning use of the appliance in a safe way and understand the hazards involved. Children shall not play with the appliance. Cleaning and user maintenance shall not be made by children without supervision.
-  Older children may only use the dishwasher when its operation has been clearly explained to them and they are able to use it safely, recognising the dangers of misuse.

Safety instructions



KEEP CHILDREN AWAY FROM DETERGENTS! Dishwasher detergents contain irritant and corrosive ingredients which can cause burning in the mouth, nose and throat if swallowed, or inhibit breathing. Keep children away from the dishwasher when the door is open. There could still be detergent residues in the cabinet. Consult a doctor immediately if your child has swallowed or inhaled detergent.

INSTRUCTIONS FOR INSTALLING YOUR DISHWASHER



Before setting up the appliance, check it for any externally visible damage. Under no circumstances should you use a damaged appliance. A damaged appliance could be dangerous.



The dishwasher must only be plugged into the electricity supply via a suitable switched socket. The electrical socket must be easily accessible after the dishwasher is installed so that it can be disconnected from the electricity supply at any time. (Refer to the "Checking the accessories" section on page 10).



There must be no electrical sockets behind the dishwasher. Danger of overheating and fire risk if the dishwasher were to be pushed up against a plug.



The dishwasher must not be installed under a hob. The high radiant temperatures which are sometimes generated by a hob could damage the dishwasher. For the same reason it should not be installed next to open fires or other appliances which give off heat, such as heaters etc.



Do not connect the dishwasher to the mains supply until it has been fully installed and any adjustment has been made to the door springs.



Before connecting the appliance, check that the connection data on the data plate (voltage and connected load) match the mains electricity supply. If in any doubt, consult a qualified electrician.



The electrical safety of this appliance can only be guaranteed when continuity is complete between it and an effective grounding system. It is most important that this basic safety requirement is present and regularly tested and where there is any doubt the electrical system in the house should be checked by a qualified electrician. The manufacturer cannot be held liable for the consequences of an inadequate grounding system (e.g. electric shock).



Do not connect the appliance to the mains electricity supply by a multi-socket unit or an extension lead. These do not guarantee the required safety of the appliance (e.g. danger of overheating).



This appliance may only be installed in mobile installations such as ships if a risk assessment of the installation has been carried out by a suitably qualified engineer.



The plastic housing of the water connection contains an electrical component. The housing must not be submerged in water.



There are electrical wires in the hose of Aqua-Stop. Never cut the water inlet hose, even if it is too long.



Installation, maintenance and repairs may only be carried out by a suitably qualified and competent person in strict accordance with current national and local safety regulations. Repairs and other work by unqualified persons can be dangerous. The manufacturer cannot be held liable for unauthorised work.



The integrated waterproof system offers protection from water damage, provided the following conditions are met:

- The dishwasher is correctly installed and plumbed in.
- The dishwasher is properly maintained and parts are replaced where it can be seen that this is necessary.
- The stopcock has been turned off when the appliance is not used for a longer period of time (e.g. during holidays).
- The waterproof system will work even if the appliance is switched off. However, the appliance must remain connected to the electricity supply.



A damaged appliance can be dangerous. If the dishwasher gets damaged, switch it off at the mains and call your dealer or the service department.



Unauthorised repairs could result in unforeseen dangers for the user, for which the manufacturer cannot accept liability. Repairs should only be undertaken by an approved service technician.



Faulty components must only be replaced by original spare parts. Only when these parts are fitted can the safety of the appliance can be guaranteed.



Always disconnect the dishwasher from the electrical supply for maintenance work (switch off at the wall socket and remove the plug).



If the connection cable is damaged it must be replaced with a special cable, available from the manufacturer. For safety reasons, this must only be fitted by the service department or an authorised service technician.



In countries where there are areas which may be subject to infestation by cockroaches or other vermin, pay particular attention to keeping the appliance and its surroundings in a clean condition at all times. Any damage which may be caused by cockroaches or other vermin will not be covered by the guarantee.



In the event of a fault or for cleaning purposes, the appliance is only completely isolated from the electricity supply when:

- it is switched off at the wall socket and the plug is withdrawn, or
- it is switched off at the mains, or
- the mains fuse is disconnected, or
- the screw-out fuse is removed (in countries where this is applicable).



Do not make any alterations to the appliance, unless authorised to do so by the manufacturer.



Never open the casing/housing of the appliance.

Tempering with electrical connections or components and mechanical parts is highly dangerous and can cause operational faults or electric shock.



While the appliance is under guarantee, repairs should only be undertaken by a service technician authorised by the manufacturer. Otherwise the guarantee will be invalidated.



When installing the product, make sure there is space at the top, left, right and back of the product to ensure proper ventilation.

If there is insufficient space between the product and the sink, it may damage the sink or allow mold to grow.

Contents

SETTING UP YOUR DISHWASHER

9

- 9 Checking the parts and control panel
- 11 Meeting the installation requirements
- 12 Installing your dishwasher (only for installing under the sink)

BEFORE USING THE PRODUCT FOR THE FIRST TIME

15

- 15 Using the Sound On/Off function
- 15 Using rinse aid

LOADING YOUR DISHWASHER

16

- 16 Dishwashing guidelines
- 16 Using the baskets
- 20 Using detergent

OPERATING YOUR DISHWASHER

22

- 22 Basic instructions
- 22 Using the programme selection buttons
- 23 Using the Delay Start function
- 23 Using the digital display
- 24 Using additional functions

CLEANING AND MAINTAINING YOUR DISHWASHER

25

- 25 Cleaning the exterior
- 25 Cleaning the wash cabinet
- 25 Cleaning the filters
- 26 Cleaning the spray arms
- 27 Storing your dishwasher

TROUBLESHOOTING AND INFORMATION CODES

28

- 28 Check these points if your dishwasher...
- 30 Information codes

PROGRAMME CHART

31

- 31 Programme chart

APPENDIX

32

- 32 Disposing the dishwasher and helping the environment
- 32 Declaration of conformity
- 32 Specifications

FOR STANDARD TEST

33

Setting up your dishwasher

Be sure to have your technician follow these instructions closely to ensure the safe and normal operation of your new dishwasher.

CHECKING THE PARTS AND CONTROL PANEL

When your dishwasher has been unpacked, make sure that you've received all the parts shown below. If your dishwasher was damaged during shipping, or if you do not have all the parts, contact Samsung Customer Service or your Samsung dealer.

 Keep the packaging out of the reach of children to ensure their safety, after unpacking your dishwasher.

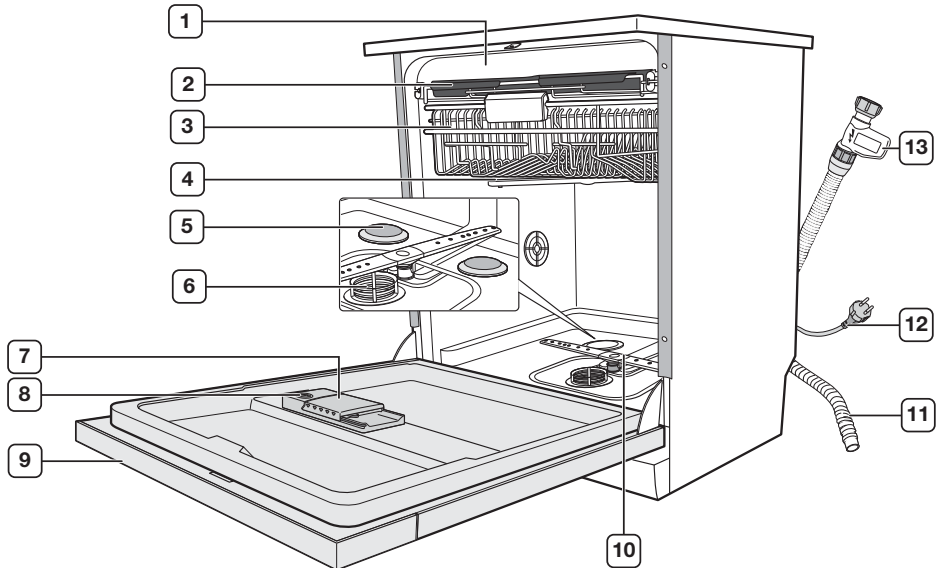

1	Top spray arm (not shown)	8	Rinse aid reservoir
2	Cutlery tray (DW-FG720) Cutlery basket (DW-FG520) (see page 19)	9	Control panel (in front of the door)
3	Upper basket	10	Lower spray arm
4	Upper spray arm	11	Drain hose
5	Intensive zone spray disk (DW-FG720)	12	Power cord
6	Filter combination	13	Aqua-Stop
7	Detergent dispenser		

Setting up your dishwasher

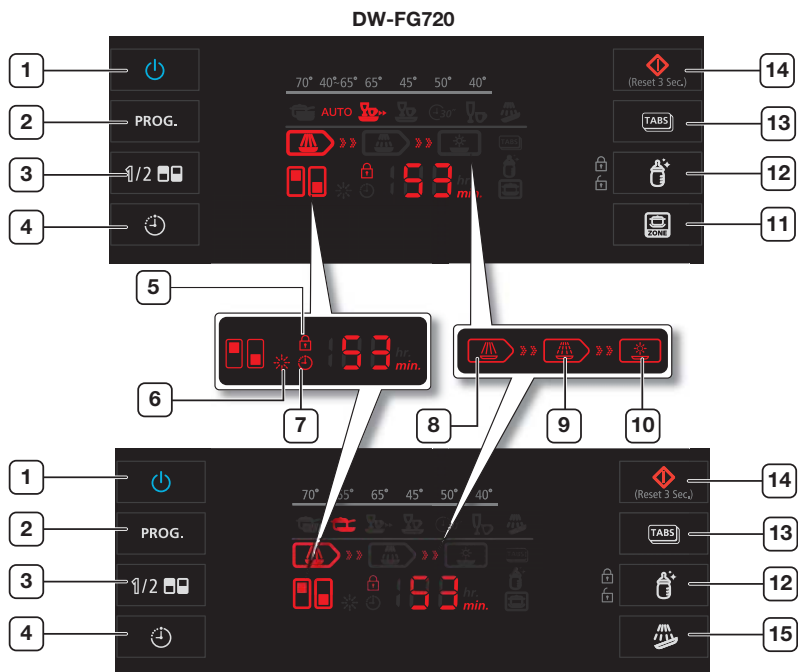

1	Power button	9	Rinse indicator
2	Programme selection buttons	10	Drying indicator
3	Half Load button	11	Intensive Zone button (DW-FG720)
4	Delay Start button	12	Sanitize/Child Lock button
5	Child Lock indicator	13	Multi Tabs button
6	Rinse Refill indicator	14	Start/Reset button
7	Delay Start indicator	15	Prewash button (DW-FG520)
8	Wash indicator		

Checking the accessories

- User manual
- Warranty card

10_ Setting up your dishwasher

MEETING THE INSTALLATION REQUIREMENTS

Power supply and grounding



Do not use an extension cord.
Only use the power cord that came with the dishwasher.

When preparing for the installation, ensure that your power supply offers:

- An AC 220-240V/50Hz fuse or a circuit breaker.
- An individual branch circuit serving your dishwasher.

Your dishwasher must be grounded. If your dishwasher malfunctions or breaks down, grounding will reduce the risk of electric shock by providing a path of least resistance for the electric current.

Your dishwasher comes with a power cord and a grounded, three-prong plug that can be inserted into a properly installed and grounded outlet.



Do not connect the ground wire to a plastic plumbing line, gas line, or hot water pipe.

Improperly connecting the grounding conductor can result in electric shock.

Check with a qualified electrician or technician if you are unsure whether your dishwasher has been properly grounded.



Do not modify the plug provided with the dishwasher. If it does not fit the outlet, have a proper outlet installed by a qualified electrician.

Water supply



Do not drink the water from inside the dishwasher.

- The dishwasher may be connected to a cold or hot water supply, max 60°C.
- A stopcock with a 3/4" male thread must be provided on tap.
- The water pressure must be between 0.05MPa and 0.8MPa. If the water pressure is too low, the water supply valve may not operate properly causing the dishwasher to turn off. If the water pressure is too high, a pressure reducer valve must be fitted.



You can reduce the risk of leaks and water damage by:

- Making water taps easily accessible.
- Turning off the taps when the dishwasher is not in use.
- Periodically checking the fittings for leaks.

Using Aqua-Stop

The Aqua-Stop was invented as the perfect leakage protection system.

It is attached to the water supply hose and automatically cuts off the water flow in the event of damage to the hose.



Aqua-Stop is an electrical component.

- Take care that you do not damage the Aqua-Stop.
- Do not twist or bend the water supply hose connected to the Aqua-Stop.



If the Aqua-Stop has been damaged, shut off the water taps and pull out the power plug right away. Once these steps have been taken, contact Samsung Customer Service or a qualified technician.

Drain

If you are using a drain exclusively for the dishwasher, connect the drain hose to a drain that is between 30cm to 70cm off the ground.

Connecting the drain hose to a drain more than 80cm off the ground can result the water in the dishwasher flowing back or draining incompletely.

Setting up your dishwasher

Flooring

For best performance, your dishwasher must be installed on a solid, even floor.

Wooden floors may need to be reinforced to minimize vibrations. Carpeting and soft tiles are contributing factors to vibrations and may cause your dishwasher to move slightly while operating.



Never install your dishwasher on a platform or poorly supported structure.

Ambient temperature

Do not install your dishwasher in an area exposed to freezing temperatures. Your dishwasher always retains some water in the water valve, pump and hose and if the water freezes in the machine or hoses, it may damage the appliance and its components.

INSTALLING YOUR DISHWASHER (ONLY FOR INSTALLING UNDER THE SINK)

STEP1. Removing the work top

1. Remove the 2 screws from the upper part on the back of the dishwasher.

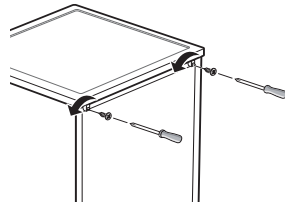

2. Slide the work top backward and then lift it up to separate it.

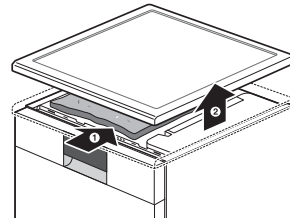

You may dispose the plastic part that is supporting the work top.

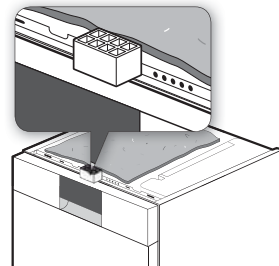

STEP2. Leveling the dishwasher

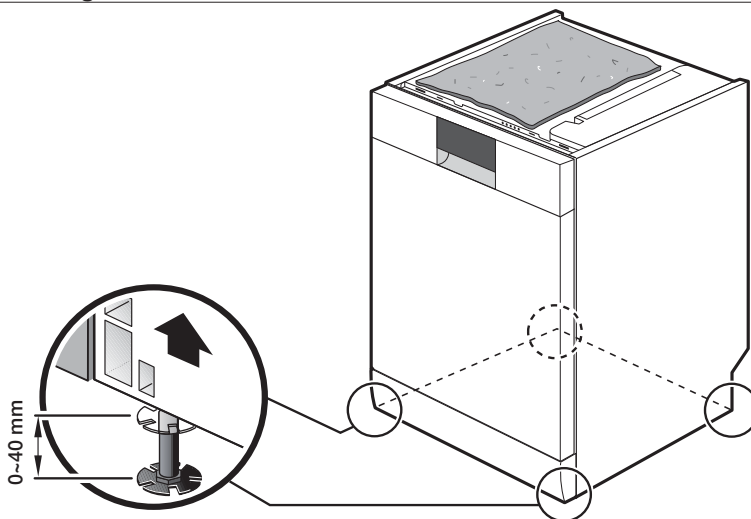

1. You can adjust the height of the product by turning the legs.
 - Slightly lift up the front and back of the product and turn the legs to adjust the height.
 - You can adjust the height up to 40 mm.
2. Push the product into the space under the sink and make sure that the product is level using the leveler.
 - Take care that the hoses or power cord is not twisted. when you push the product into the space under the sink.
3. Install the product so that there is a space of at least 4 mm between the top of the product and the bottom of the top plate of the sink.



After the installation, do not bind the power cord with a cable tie that has a metal wire in it.

Setting up your dishwasher

STEP3. Connecting the hoses and powering

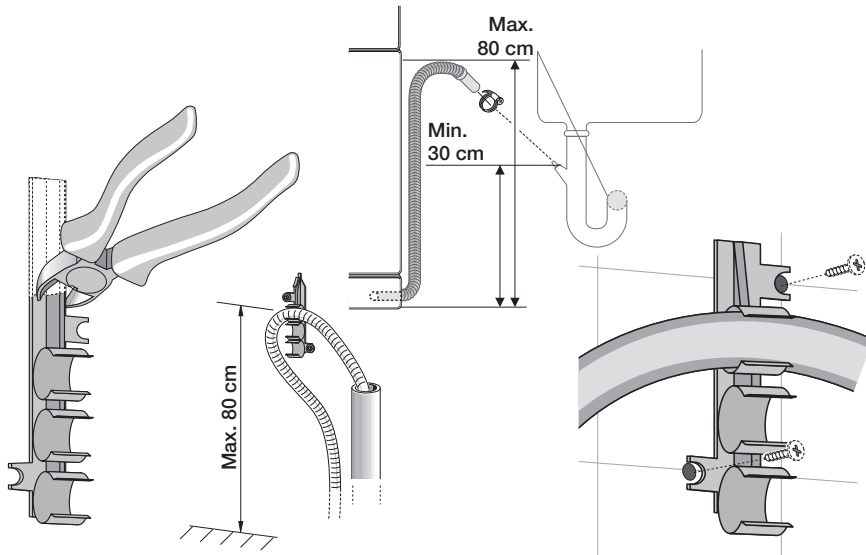

1. Remove the hose holder which is attached to the product and cut off part of the holder as shown in the figure.
2. Discard the part you have just cut off and use only the part that is shown by the figure.
3. Fix it to the wall by fastening the 2 screws.
4. Insert the drain hose into the fixed hose holder.
Install the drain hose so that it is placed within a range of 30 cm to 80 cm from the bottom.
5. Connect the drain hose to the drain outlet.



- Take care when you connect the drain hose that it does not move during a draining cycle.
- Confirm that no parts of the drain hose, supply hose or power cord are bent or folded.

6. Open the door and remove all foam, paper packaging, and unnecessary parts.
7. Turn on the circuit breaker you turned off before you began the installation.
8. Open the water supply valve to supply water to the dishwasher.
9. Turn on the dishwasher, and then select and run a cycle.



Check if the power turns on correctly and if there is any water leakage while the dishwasher is operating. If no errors occur while it is operating, turn off the dishwasher, and then go to No.5 of above.









If an error has occurred, turn off the dishwasher, close the water supply valve, and then refer to the user manual or contact a service centre as referring to the contact list on the back cover.



Make sure to check for water leakage on both ends of the water supply line and drain hose connector.

Before using the product for the first time

USING THE SOUND ON/OFF FUNCTION

1. While holding down the **Delay Start**  and **Half Load**  buttons, press the **Power**  button to access the setting to activate/deactivate the **Sound On/Off** function.
2. Press the **Sanitize**  button to activate or deactivate the **Sound On/Off** function.
 - “Rinse Refill ” indicator turns on to indicate that **Sound On** function has been activated.
 - “Rinse Refill ” indicator turns off to indicate that **Sound Off** function has been activated. Even though **Sound Off** function has been activated, the error sound plays when an error occurs.
3. To exit the **Sound On/Off** setting, press the **Power**  button.

USING RINSE AID

Filling the rinse aid reservoir

As soon as the rinse aid refill indicator lights up on the control panel, refill with rinse aid. Your dishwasher has been designed to use liquid rinse aid only.

Using a powdered rinse aid will clog up the reservoir opening and cause the dishwasher to malfunction.

Rinse aid improves the drying performance of the dishwasher.



Do not add regular detergent into the rinse aid reservoir.

1. Remove the rinse aid reservoir cap by rotating it counterclockwise.

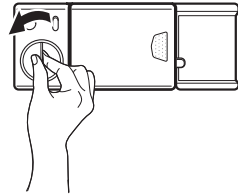

2. Fill the rinse aid reservoir with rinse aid.



Use the viewing port when filling the rinse aid.



Do not fill the reservoir above the rinse aid level as the rinse aid may overflow during the wash cycle.

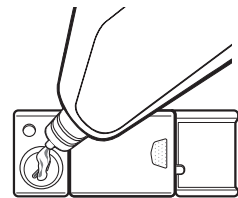

3. Turn the rinse aid setting to a rinse aid amount between 1 and 6. The higher the level, the more rinse aid will be used.

If you are unable to rotate the rinse aid leveller with ease, try using a coin.

4. Close the rinse aid reservoir cap by rotating it clockwise.

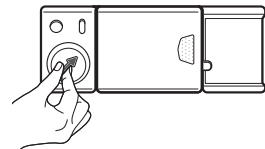

Loading your dishwasher

DISHWASHING GUIDELINES

Follow these simple guidelines to get the best results and save energy.

Before loading dishes



Remove food remains such as bones, fruit seeds, etc. and waste such as toothpicks, paper napkins, etc. from your dishes. Food remains and waste can damage your dishes, make noise and even result in a product malfunction.



Do not wash items that are covered with ash, sand, wax, lubricating grease or paint. These materials will damage the dishwasher and ash does not dissolve and will distribute in hole interior.

Items not suitable for the dishwasher

- Copper, brass, tin, ivory and aluminium items or with an adhesive
- Non-heat resistant plastics
- Craft items, antiques, valuable vases and decorative glassware
- Colours painted over a glaze
- Wooden cutlery and crockery or items with wooden parts
- Delicate glassware, or glassware containing lead crystal



Silverware that has been in contact with foods containing sulphur can become discoloured. These include egg yolks, onions, mayonnaise, mustard, fish, fish brine and marinades.

- Clouding may occur on glasses after frequent washing. Do not wash delicate glassware, or glassware containing lead crystal in the dishwasher.



Aluminium components (e.g. grease filters) must not be cleaned with caustic, alkaline cleaning agents. These may damage the material, or in extreme cases, cause a severe chemical reaction. Use only items e. g. glasses, porcelain and cutlery which the manufacturer declare as dishwasher-proof.

USING THE BASKETS

Handling the baskets



Do not use excessive force to slide the baskets in or out. This may damage the baskets and the items inside the baskets.

Using the upper basket

Use the upper basket for mainly small, light or delicate items such as cups, saucers, glasses, dessert bowls, etc.

Adjusting the upper basket

You can adjust the height of the upper basket for additional clearance for placing large items in either the upper or lower basket.

 Remove all items from the cup selves before adjusting the height. Failing to do so may damage the items and the basket.

1. Pull out the upper basket.
2. **To raise the upper basket:** Hold the upper basket on both sides and gently pull it up as far as possible.

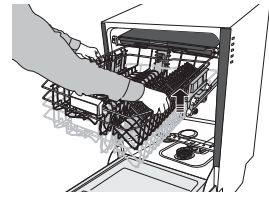

3. **To lower the upper basket:** Hold the upper basket on both sides, and lift it up for a short step. And then push it down gently.

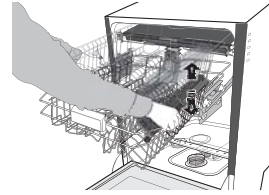

 Whenever you adjust the height, make sure that the upper spray arm will not become caught on the dishes loaded in the lower basket as it spins.

 Make sure that the upper basket is level. If the upper basket is raised on one side, it will prevent the door from closing fully and cause problems with the dishwasher operation.

 Do not raise the upper basket on one side only. Doing so will prevent the door from closing fully and consequently cause problems with the dishwasher's operation.

Using the lower basket

Use the lower basket for large plates and heavy items such as serving platters, pans, pots, bowls, etc. Small items such as saucers can also be placed in the lower basket.

 Do not place delicate glassware in the lower basket.

Loading your dishwasher

Using the hinged spikes

Foldable hinged spikes allow you to make room in the lower basket for large items.

1. Flatten the hinged spikes by pressing them down.

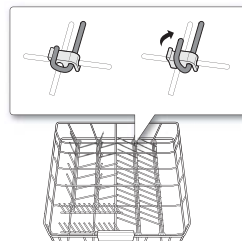



Using the cutlery tray (DW-FG720)

 The cutlery tray inserts can be detached from the cutlery tray. For example, you can remove one side of the inserts to make room for larger items in the upper basket.

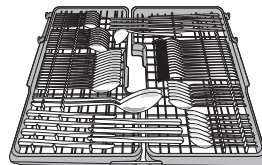
1. Arrange the cutlery in the cutlery tray inserts as shown.



2. Attach the inserts to the cutlery tray.

-  Placing large items such as cake cutters in the tray can result in interference with the top spray arm.
-  If spoon handles do not fit between the holders, then place them the other way round.

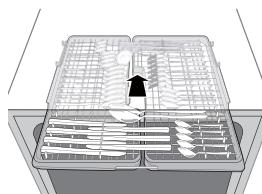

3. Remove the cutlery tray inserts from the cutlery tray after the end of the programme.

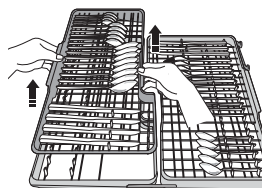

Using the cutlery basket (DW-FG520)

The cutlery basket has cover so that each knife, spoon, or fork can be placed on individual stands to prevent chipping and discolouration.

1. Place the different types of cutlery in the baskets as shown.

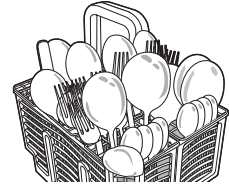

For safety purposes, place knives in the knife rack.

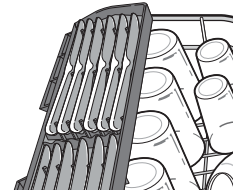

2. Place the cutlery basket in the lower basket.



If you are washing a small amount of cutlery only, you may separate the cutlery basket and use only one side.

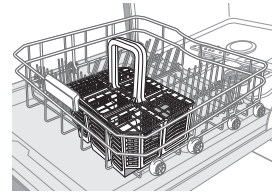

Do not place long items inside the cutlery basket. The handle may be too long and interfere with the upper spray arm.

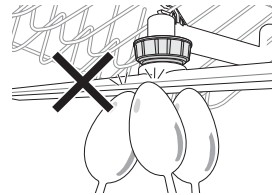

The cutlery basket can be used with the cover opened.

1. Raise the cover and attach it to the handle as shown in the diagram.



To separate the cutlery basket into two baskets, pull one side of the cutlery basket in the direction of the arrow in the figure while holding the other side.

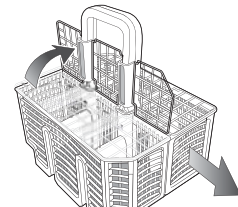

Loading your dishwasher

Using the cup selves

You can place cups, small items and long cooking utensils on the cup selves. This is also a very convenient way to wash wine glasses. Place wine glasses on the pegs of the cup selves. The cup selves can also be folded back when not in use.

 Do not adjust the level of the upper basket with the glass supports propped up. This will make it impossible to push in the upper basket.

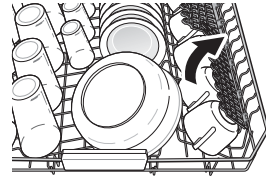

USING DETERGENT

All dishwasher programme, except for for **Prewash** , require detergent in the detergent compartment. Add the correct amount of detergent for the selected programme to ensure the best performance.

 Use dishwasher detergent only. Regular detergent produces too much foam, which may decrease the dishwasher's performance or cause it to malfunction.

 Do not breathe in the fumes of dishwasher detergent or swallow it. Dishwasher detergent contains irritants and caustic chemicals that can induce respiratory conditions. If you have inhaled the fumes of detergent or swallowed it, seek medical attention immediately.

 Keep dishwasher detergent out of the reach of children.

Filling the detergent dispenser

1. Open the detergent dispenser flap by pushing the detergent dispenser release catch.

 The flap is always opened at the end of a dishwashing cycle.

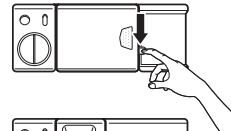

2. Add the recommended amount of detergent into the main wash detergent compartment.

3. Close the flap by pushing it to the left and then pressing it down.

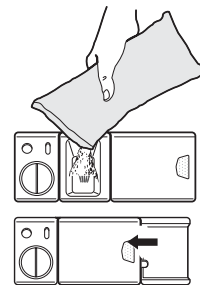

4. For better cleaning result, especially if you have very dirt items, add small amount(about 8 g) of detergent on the door. That will act in prewash phase.

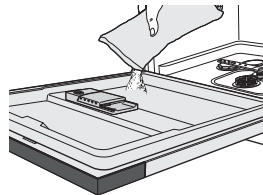

Using multi tabs

You can also use 2-in-1, 3-in-1, or 4-in-1 multi tabs.

Multi tabs, depending on the type, combine dishwasher detergent with rinse aid.



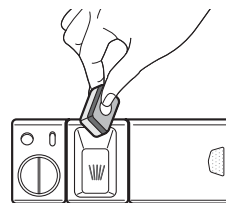

 Refer to the manufacturer's instructions before using a multi tab product and verify that it is suitable for the water hardness level in your area.

1. Push the detergent dispenser's release catch and open the detergent dispenser flap.
2. Add the multi tab into the main wash detergent compartment and close the flap.
3. Push the **Multi Tabs**  button on the control panel to activate the Multi Tabs function.









Operating your dishwasher

BASIC INSTRUCTIONS

1. Open the door.
2. Load the baskets.
 Do not overload the baskets.
3. Make sure the spray arms are not obstructed.
4. Add the appropriate amount of dishwasher detergent into the dispenser and on the door (if required).
5. Push the **Power**  button to turn on the dishwasher.
6. Select a programme appropriate for the type of load using the **PROG.** button. (Refer to the "Using the programme selection buttons" section on page 22.)
The indicator for the selected programme illuminates.
7. Select any additional functions.
This turns on the corresponding indicators.
8. Push the **Start/Reset**  button and close the door to start.
9. Short time after the end of the programme, open the door and push the **Power**  button to turn off the dishwasher.
10. Unload the baskets.
 Unload the lower basket, the upper basket, and the cutlery tray (if loaded) in this order.
This will prevent water from the upper basket dropping onto items in the lower basket.

USING THE PROGRAMME SELECTION BUTTONS

Select a programme appropriate for the type of load and soiling using the **PROG.** button.

Symbol	Programme	Description
	Intensive 70 °C	Heavily soiled items include pots and pans
Auto	Daily Auto 40 ~ 65 °C (DW-FG720)	Lightly to heavily soiled daily using items, automatic detection of the amount of soils
	Daily Intensive 65 °C (DW-FG520)	Normally soiled daily using items
	Express 65 °C	Normally soiled daily using items, with short cycle time
	Normal 45 °C	Normally soiled daily using items, with reduced energy and water consumptions
	Quick 50 °C	Lightly soiled with very short cycle time
	Delicate 40 °C	Lightly soiled delicate items
	Prewash (DW-FG720)	Cold rinse for remove only dirt on dishes stored for a long time or soaking dishes which are dried up before other programme running.

-  **Using the Prewash function (DW-FG520)**
Press the **Prewash**  button to use the Prewash function.

Interrupting a programme

If you open the door while a programme is in progress, the programme is temporarily halted. To resume the programme, simply close the door.



The water in the dishwasher may be extremely hot.





Only open the door when absolutely necessary and exercise extreme caution.

Changing a programme

If a programme has already started and you want to change it, follow the instructions below:







If the detergent dispenser flap has been opened, do not change the programme.



1. Open the door to interrupt the programme.
2. Push and hold the **Start/Reset**  button for 3 seconds to reset the programme.
 -  • Once the programme is reset, the dishwasher will perform a 1 minute drain. You will be able to change the programme once the draining ends.
 - To skip the draining process, press the **Power**  button to turn the dishwasher off and then press the button again to turn it back on. You will have to select additional functions again.
3. Change the programme and push the **Start/Reset**  button.
4. Close the door to start the new programme.

USING THE DELAY START FUNCTION

You can set the dishwasher to start a programme at a later time by choosing a delay of between 1 and 24 hours (in 1 hour increments).

1. Open the door and load the baskets.
2. Add the appropriate amount of dishwasher detergent into the dispenser and on the door (if required).
3. Push the **Power**  button to turn on the dishwasher.
4. Select the programme and functions.
5. Set the delay time using the **Delay Start**  button.
6. Push the **Start/Reset**  button. The **Delay Start**  indicator lights up, and the clock begins to count down.
7. To cancel the **Delay Start** function, press and hold the **Start/Reset**  button for 3 seconds to reset the programme.

USING THE DIGITAL DISPLAY

The digital display shows the remaining wash time, status information (“**Delay Start** ”, “**Rinse Refill** ”, and “**Child Lock** ”) and error codes.

If an error occurs while the product is operating, the code associated with the error is displayed and a beeping sound will be played. Refer to the “Information codes” section on page 30.

Time display

The time display area indicates the time remaining until the end of the selected programme in hours and minutes.

For detailed information on programme times, refer to the “Programme chart” section on page 31.

The time remaining may vary even with the same programme. This can be due to difference in water temperature, the reactivation cycle, and the size and state of the load.

Operating your dishwasher

Rinse Refill indicator

If the “Rinse Refill ” indicator is lit, it means the dishwasher is low on rinse aid and requires a refill. To refill the rinse aid reservoir, refer to the “Filling the rinse aid reservoir” section on page 15.

USING ADDITIONAL FUNCTIONS

Intensive Zone (DW-FG720)



Use this function for hard-to-clean, heavily soiled dishes, pot & pan, and dishes with heavy oil. Locate items above the Intensive zone spray disk (Refer to the “Checking the parts and control panel” section on page 9) and press the **Intensive Zone**  button.

Half Load

For small amount of loading items, use either the upper or lower basket only to save energy.

Press the **Half Load** /2 button to select the upper or lower basket.

Multi Tabs

If you wish to use a 2-in-1, 3-in-1, or 4-in-1 multi tablet detergent, select a programme and then push the **Multi Tabs**  button. (The Multi Tabs function is available with all programme except **Prewash** .)

Selecting the Multi Tabs function turns on the “Rinse Refill ” indicator. However, this does not mean that a refill is required.

Sanitize

Push the **Sanitize**  button for the best possible hygiene in your dishwasher. At the final rinse it heat up to 70 °C and hold this temperature for a several minutes.

This function is available with all programme except **Prewash**  and **Delicate** .

Child Lock

The Child Lock function locks all buttons so that the selected programme cannot be changed.

Activating/Deactivating

To activate or deactivate the Child Lock function, push and hold the **Sanitize**  button for 3 seconds.

The “Child Lock ” indicator turns on to indicate that Child Lock function has been activated.

Activating the Child Lock function locks all buttons.

Cleaning and maintaining your dishwasher

Keeping your dishwasher clean improves its performance, reduces unnecessary repairs, and prolongs its life.

CLEANING THE EXTERIOR

It's best to clean spills on the exterior of your dishwasher as they occur. Use a soft, damp piece of cloth to gently wipe away spills and dust from the control panel.



Do not use benzene, wax, thinner, chlorine bleach, or alcohol. These chemicals may discolour the inner walls of the dishwasher and cause stains.



Do not clean the dishwasher by sprinkling water over it. In particular, protect the electrical components from coming into contact with water.



If your dishwasher has a stainless steel door panel, it can be cleaned with a stainless steel cleaner for Home Appliances or similar product using a clean, soft cloth.

CLEANING THE WASH CABINET

If there are limescale or grease deposits in the cabinet, remove these by damp cloth or run a programme which has highest rinsing temperature without any loading items after filling detergent dispenser with dishwasher detergent.



Do not remove the front seal on the container. Removing the seal can cause the dishwasher to leak or malfunction.

CLEANING THE FILTERS

1. Turn off the dishwasher.
2. Rotate the filter insert counterclockwise to unfasten and then detach the filter insert.

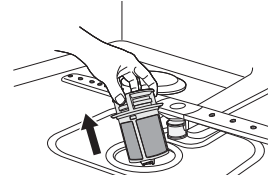
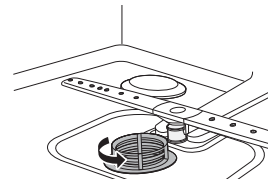

3. Remove the fine filter (flat rectangular).

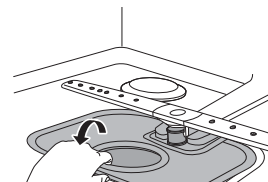

Cleaning and maintaining your dishwasher

4. Disassemble the coarse filter and micro filter.

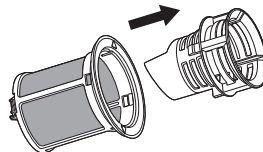

5. Remove any dirt or other remains from the filters and rinse them under running water.

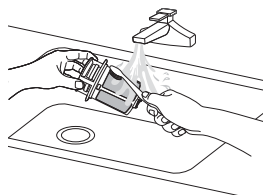

6. Reassemble the filters in the reverse order of the disassembly, replace the filter insert, and rotate clockwise to the close arrow.



If the filter insert is not closed properly, the performance will be decreased.

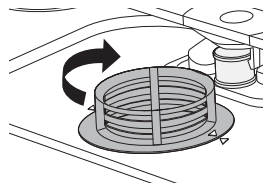

CLEANING THE SPRAY ARMS

If the dishwasher continues to perform poorly or the jets on the spray arms seem clogged, clean the spray arms. When removing the spray arms, take care as they break easily.



Turn off the dishwasher before removing the spray arms.

Cleaning the spray arms

1. Remove the cutlery tray insert (DW-FG720). (Refer to the "Using the baskets" section on page 16.)
2. Rotate the handle on the middle of the top spray arm in the counterclockwise direction and detach the arm.

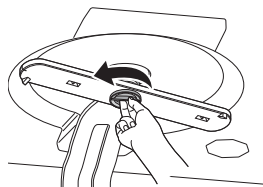

3. Unfasten and remove the nut holding the upper spray arm in place and detach the arm.



4. Remove the lower basket.
5. Firmly pull the lower spray arm upward at once to remove it.

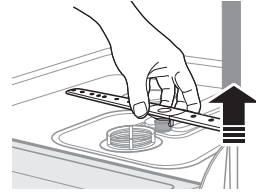

6. Use a pointed object such as a toothpick to push out food particles in the spray arm's jets.

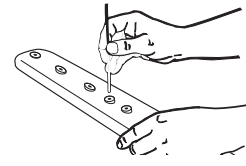

7. Rinse thoroughly under running water.
8. Reattach the spray arms and check that they rotate freely.

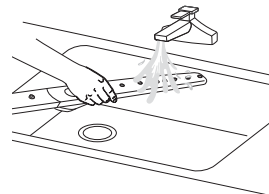

STORING YOUR DISHWASHER

If you need to store your dishwasher for an extended period of time, first drain the unit fully and then disconnect the water hose.

Your dishwasher can become damaged if water is left in the hoses and internal components before storing it. After draining and disconnecting the dishwasher, be sure to turn off the water supply valve and circuit breaker.

Troubleshooting and information codes

CHECK THESE POINTS IF YOUR DISHWASHER...

PROBLEM	POSSIBLE CAUSE	SOLUTION
Will not start.	The door is not closed completely. The Start/Reset ⬇ button is not selected.	Check that the door is latched and closed completely. Press the Start/Reset ⬇ button before closing the door.
	No programme is selected.	Select a programme.
	The power cord is not connected.	Connect the power cord.
	There is no water supplied.	Check that the water supply valve is open.
	The control panel is locked.	Deactivate the Child Lock function to unlock the control panel.
Has a bad odour.	There is water left over from the last cycle.	Add detergent without loading dishes and run the Daily Auto Auto programme to clean the dishwasher.
Has water remaining after the programme has finished.	The drain hose is folded or clogged.	Straighten and unclog the hose.
Has food particles remaining on the dishes.	An inappropriate programme was been selected.	Select a programme according to the soil level of the dishes as directed in this manual.
	The filter is contaminated or not correctly fasten.	Clean the filter and make sure the filters are fitted properly.
	No dishwasher detergent or not enough detergent is being used.	Use an automatic dishwasher detergent or use more detergent.
	The pressure of the supplied water is low.	The water supply pressure must be between 0.05 MPa and 0.8 MPa.
	Spray arm jets are clogged.	Clean the spray arms.
	The dishes are improperly loaded.	Rearrange the dishes so they have good water access and do not interfere with spray arm and dispenser operation.
Does not dry dishes well.	There is no rinse aid in the dispenser or not enough rinse aid was used.	Check the dispenser and add rinse aid. Check rinse aid setting.
	Multi taps were used without selecting the Multi Tap function.	Select the Multi Tap function or use rinse aid.

PROBLEM	POSSIBLE CAUSE	SOLUTION
Is too noisy.	The dishwasher beeps when the dispenser cover is opened and during the initial stage of draining the pump operation.	This is a normal operation.
	The dishwasher is not level.	Ensure that the dishwasher is level.
	There is a 'chopping' sound because an arm is bumping against the dishes.	Rearrange the dishes.
Leaves a yellow or brown film on cups or dishes	This can occur from coffee and tea soils.	Use programme with higher temperature.
Does not have any indicators lit.	The power cord is not connected.	Connect the power cord.
Does not have smoothly rotating arms.	The arms are clogged with food particles.	Clean the arms.

Troubleshooting and information codes

INFORMATION CODES

Information codes are displayed to help you better understand what is occurring with your dishwasher. If any of the codes below occur, you should select the Reset option and follow the respective instruction.

CODE SYMBOL	MEANING	SOLUTION
bE2	Button key error	Check any button is pressed more than 30 sec.
3E, AE	Internal communication error	Turn off and restart the appliance.
5E	Drain error	Check whether the drain hose is clogged or folded.
4E	Water supply error	Make sure the water supply valve open.
4E1	Hot water supply	Make sure the temperature of supplied water is not higher than 80 °C.
HE, HE1	Heater error	Turn off and unplug the power plug, close water supply valve and contact service centre.
tE	Temperature sensor error	
1E	Low water level error	
PE	Flow changer error	Turn off and restart the appliance.
LE	Leakage error	Turn off and unplug the power plug, close water supply valve and contact service centre.
OE	Over water level error	

 For more information about the error codes, or if you are unable to resolve the problem using the suggested solution, refer to the back of this manual and contact your Samsung Customer Service centre.

Programme chart

PROGRAMME CHART

Soil level	Intensive 70	Daily Auto 40-65 (DW-FG720)	Daily Intensive 65 (DW-FG520)	Express 65	Normal 45	Quick 50	Delicate 40	Prewash
Amount of food remains	Heavy	Very light to Heavy	Normal	Normal	Normal	Light	Light	Very light
Programme sequence	Prewash ► Mainwash ► 1st rinse ► 2nd rinse ► Hot rinse ► Dry ► End	Prewash ► Mainwash ► 1st rinse ► (2nd rinse) ► Hot rinse ► Dry ► End	Prewash ► Mainwash ► 1st rinse ► Hot rinse ► Dry ► End	Prewash ► Mainwash ► 1st rinse ► Hot rinse ► Dry ► End	Prewash ► Mainwash ► 1st rinse ► Hot rinse ► Dry ► End	Mainwash ► 1st rinse ► Hot rinse ► End	Prewash ► Mainwash ► 1st rinse ► Hot rinse ► Dry ► End	Cold rinse ► End
Washing time (Min)	148	90~148	118	87	149	34	83	17
Water consumption (L)	17	9.1~17	13.9	11.6	12.0 (DW-FG720) 11.8 (DW-FG520)	10.5	10.1	3.7

 The wash time may differ depending on the temperature of the supplied water.

Appendix

DISPOSING THE DISHWASHER AND HELPING THE ENVIRONMENT

Your dishwasher is manufactured from recyclable materials. If you decide to dispose of it, please observe your local waste disposal regulations. Cut off the power cord so that the appliance cannot be connected to a power source.

Remove the door so that animals and children cannot get trapped inside the appliance.

Do not exceed the detergent quantities recommended in the detergent manufacturers' instructions.

DECLARATION OF CONFORMITY

This product complies with the requirements of these directives:

EMC-Directive 2004/108/EC

Low Voltage Directive 2006/95/EC

SPECIFICATIONS

MODEL		DW-FG720, DW-FG520	
Power		AC 220 ~ 240 V / 50 Hz	
Type		Free Standing	
Water pressure		0.05 - 0.8 MPa	
Wash capacity (place settings)		15 (DW-FG720), 13 (DW-FG520)	
Rated power		2000 ~ 2300 W	
Dimension		598 mm(W) X 845 mm(H) X 570 mm(D)	
Weight	Model	DW-FG720	DW-FG520
	Unpacked	48.5 kg	47.0 kg
	Packed	51.5 kg	50.0 kg

For standard test

 The diagrams below show the proper way to load the baskets based on the Australian/New Zealand Standard (AS/NZS 2007.2 & 6400).

- Washing capacity: 15 (DW-FG720) / 13 (DW-FG520) place settings
- Test standard: AS/NZS 2007.2 & 6400
- Position of upper basket: Low
- Programme: **Normal** 
- Additional options: None
- Rinse aid setting: 3
- Dosage of the standard detergent
 - 15PS : 8g + 25g
 - 13PS : 7g + 24g
- For the arrangement of the items, refer Figure A, B, C.
- Drying condition : Opened door (50mm)

15 place settings



< Figure A-1: Lower basket >

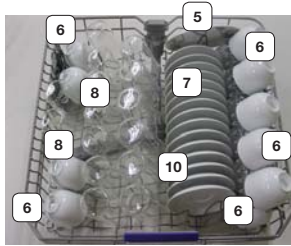

< Figure B-1: Upper basket >

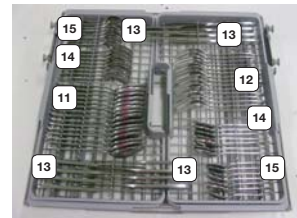

< Figure C-1: Cutlery tray >

1	Soup plate	6	Cup	11	Soup spoon
2	Dinner plate	7	Saucer	12	Fork
3	Dinner plate	8	Glass	13	Knife
4	Dessert dish	9	Small bowl, Middle bowl	14	Dessert spoon
5	Dessert dish	10	Big bowl	15	Tea spoon

For standard test

13 place settings

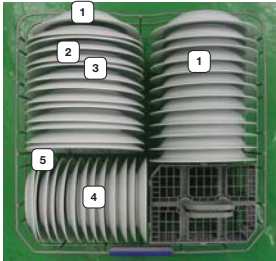

<Figure A-2: Lower basket>



< Figure B-2: Upper basket>

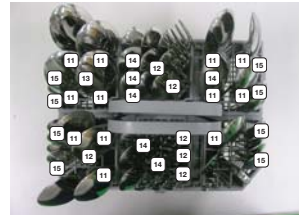

<Figure C-2: Cutlery basket>

1	Soup plate	6	Cup	11	Soup spoon
2	Dinner plate	7	Saucer	12	Fork
3	Dinner plate	8	Glass	13	Knife
4	Dessert dish	9	Small bowl, Middle bowl	14	Dessert spoon
5	Dessert dish	10	Big bowl	15	Tea spoon

Drying condition

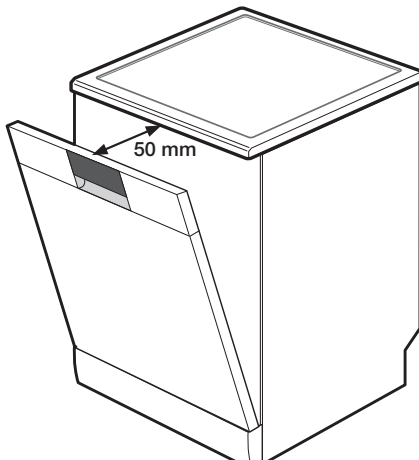

Note



QUESTIONS OR COMMENTS?

COUNTRY	CALL	OR VISIT US ONLINE AT
AUSTRIA	0810 - SAMSUNG (7267864, 0.07/min)	www.samsung.com
BELGIUM	02-201-24-18	www.samsung.com/be (Dutch) www.samsung.com/be_fr (French)
CZECH	800 - SAMSUNG (800-726786)	www.samsung.com
DENMARK	70 70 19 70	www.samsung.com
FINLAND	030 - 6227 515	www.samsung.com
FRANCE	01 48 63 00 00	www.samsung.com
HUNGARY	06-80-SAMSUNG(726-7864)	www.samsung.com
ITALIA	800-SAMSUNG(726-7864)	www.samsung.com
LUXEMBURG	261 03 710	www.samsung.com
NETHERLANDS	0900-SAMSUNG (0900-7267864) (0,10/min)	www.samsung.com
NORWAY	815-56 480	www.samsung.com
POLAND	0 801 1SAMSUNG(172678) 022-607-93-33	www.samsung.com
PORTUGAL	80820-SAMSUNG(726-7864)	www.samsung.com
SLOVAKIA	0800-SAMSUNG(726-7864)	www.samsung.com
SPAIN	902 - 1 - SAMSUNG (902 172 678)	www.samsung.com
SWEDEN	0771 726 7864 (SAMSUNG)	www.samsung.com
U.K	0845 SAMSUNG (7267864)	www.samsung.com/ch www.samsung.com/ch_fr (French)
SWITZERLAND	0848 - SAMSUNG (7267864, CHF 0.08/min)	www.samsung.com
AUSTRALIA	1300 362 603	www.samsung.com
NEW ZEALAND	0800 SAMSUNG (0800 726 786)	www.samsung.com
TURKEY	444 77 11	www.samsung.com
SOUTH AFRICA	0860-SAMSUNG(726-7864)	www.samsung.com
U.A.E / IRAN	800-SAMSUNG(726-7864)	www.samsung.com
BAHRAIN	8000-4726	www.samsung.com
JORDAN	800-22273	www.samsung.com

Code No.: DD68-00093B_EN

Free Manuals Download Website

<http://myh66.com>

<http://usermanuals.us>

<http://www.somanuals.com>

<http://www.4manuals.cc>

<http://www.manual-lib.com>

<http://www.404manual.com>

<http://www.luxmanual.com>

<http://aubethermostatmanual.com>

Golf course search by state

<http://golfingnear.com>

Email search by domain

<http://emailbydomain.com>

Auto manuals search

<http://auto.somanuals.com>

TV manuals search

<http://tv.somanuals.com>