

OKI[®]
People to People Technology™



OKIFAX[®] 5400

FACSIMILE

OKIFAX 5400 Handbook



Every effort has been made to ensure that the information in this handbook is complete, accurate, and up-to-date. Okidata assumes no responsibility for the results of errors beyond its control. Okidata also cannot guarantee that changes in software and equipment made by other manufacturers and referred to in this handbook will not affect the applicability of the information in it. Mention of software products manufactured by other companies does not necessarily constitute endorsement by Okidata.

Copyright 1999 by Okidata. All Rights Reserved

First Edition: June, 1999

Written and produced by the Okidata Training and Publications Department.

Please address any comments on this publication by mail to:

Okidata
Training and Publications Department
2000 Bishops Gate Boulevard
Mount Laurel, NJ 08054-4620

or by email to:

pubs@okidata.com

Please visit Okidata's multilingual web site at:

<http://www.okidata.com>

OKI, OKIDATA, and OKIFAX are registered trademarks/ marques déposées/marcas registrada, and OKIcare, OKI On-Site, and OKI Extend are trademarks of Oki Electric Industry Company, Ltd.

ENERGY STAR is a registered trademark of the United States Environmental Protection Agency.

Windows is either a registered trademark or a trademark of Microsoft Corporation in the United States and/or other countries



As an ENERGY STAR® partner, Okidata has determined that this product meets the ENERGY STAR guidelines for energy efficiency.

Contents

Introduction	10	Programming Required Information	25
Features	10	FCC Telephone Consumer Protection Act	25
Product Options	11	Date and Time	26
Installation	13	Fax Identification	26
For Your Safety: Installation Hints	13	To Program Your Fax ID:	27
Getting Started	14	Getting to Know Your Fax Machine	29
Where to Install Your Fax Machine	14	Component Identification	29
Unpacking	14	Front of the Unit	29
What You Should Receive	14	Back of the Unit	30
Attaching the Document Stacker	15	Inside the Unit	31
Removing the Protective Sheet	16	Locating the Serial Number	31
Installing the Toner Cartridge	17	Control Panel Keys and Indicators	32
Toner Cartridge and Image Drum Unit Handling	19	The Speed Dial (One Touch) Keypad	37
Emergency First Aid	19	Using the One Touch Keys for Dialing	37
Loading Paper	20	Using the One Touch Keys for Selecting Functions and Programming	37
Connecting the Telephone Line	22	List of One Touch Keys with Descriptions	37
Connecting an External Telephone or Answering Machine	22	Signal Tones	39
Connecting The External Handset (Option)	23	Dual Access	40
Connecting Power	24		

Using Your Fax with Your Computer	41	Fax Forwarding Mode [FWD]	56
Connect to Your Computer	41	PC Mode [PC]	56
Setting Basic Features	42	Incoming Call Parameters	57
Control Panel Keys and Indicators	42	Ring Response: User Function 11	57
Navigating Programming Levels	43	Incoming Ring: User Function 16	57
Viewing Your Current Settings	43	Distinctive Ring: User Function 12	57
User Function Settings	43	Setting Distinctive Ring	57
User Function Settings List	44	Remote Receive: User Function 17	59
Changing Your User Function Settings	50	PC/Fax Switch (MFP Option):	
Dial Parameter Settings	51	User Function 22	59
Dial Parameter Settings List	51	Monitor Volume: User Function 06	59
Changing Your Dial Parameter Settings	52	Buzzer Volume: User Function 07	59
Service Function Settings	53	Paper Size Settings	60
Service Function Settings List	53	First Paper Size: User Function 13	60
Changing Your Service Function Settings	53	Using the OTHER setting, with MFP Option Installed ...	60
Changing the Language	54	Second Paper Size: User Function 14	60
Answering Mode	54	Connecting to a PBX	60
Setting the Answering Mode	54	Basic Faxing Operations	62
Changing the Answering Mode	54	Preparing Documents for Faxing	62
Answering Mode Options	55	Guidelines	62
Auto Receive Mode [FAX]	55	Document Size	62
Manual Receive Mode [TEL]	55	Multiple Page Documents	63
Telephone/Fax Automatic Switch Mode [T/F]	55	Loading Documents	63
Using Your Fax with an Answering Machine [TAD]	56		
Memory Reception Mode [MEM]	56		

Sending a Fax to a Single Location	64	Chain Dialing	78
Search Key Dialing	66	Creating a Chain Dial Number	78
Real-Time Dialing	66	Using a Chain Dial Number	79
Redialing	66	Auto Dial Faxing	79
Confirming Results	66	Programming Auto Dial Numbers	79
Stopping a Transmission	67	Copying	81
Shortcut Fax Number Programming	67	Quantity and Resolution	81
Receiving Faxes	68	Making Copies	81
Receiving Faxes Manually	68	Using the Manual Paper Feeder	82
Receiving Faxes in Memory	69	Sending a Fax to Multiple Locations	
Memory Reception Mode [MEM]	69	(Broadcasting)	85
No Paper Reception	69	Performing a Broadcast Operation	85
Canceling Messages Stored in Memory	70	Sending A Fax to a Group	87
Rejecting Unsolicited (Junk) Fax Messages (Closed		What is a Group?	87
Network Option)	70	Programming Groups	88
Power Failures and Memory	71	Search	88
Using Voice Request	72	Add	88
Initiating a Voice Request	72	Delete	89
Answering a Voice Request	72	Sending to a Group	89
Programming Your Speed Dial Directory	73	Relay Faxing	90
One Touch Faxing	73	What is Relay Faxing?	90
Programming One Touch Keys	73	Relay Initiating Station	91
Using the One Touch Keys for Dialing	76	Relay Key Station	91
Using the One Touch Keys for Selecting Functions		Relay Broadcast Report	91
and Programming	76	Initiating a Relay Broadcast	92
List of One Touch Keys	76		

Advanced Operations	94	Transmit Preparation	107
Sending a Fax at a Later Date and Time	94	What is it?	107
Features and Limitations	94	Setting the Forwarding Number	
Sending a Delayed Fax from the Document Feeder	95	(Call Forwarding)	108
Sending a Delayed Fax from Memory	96	Working with Dual Access	109
Canceling a Delayed Transmission	98	What You Can Do While Sending a Fax	109
Confidential Faxes (Security Feature)	98	What You Can Do While Receiving a Fax	109
Creating a Personal (Confidential) Mailbox	98	What You Can Do While Making Copies	110
Changing Your Password	99	Reports	111
Closing (Deleting) a Mailbox	101	Understanding Reports	111
Sending Confidential Faxes	102	Activity Report	111
Receiving Confidential Faxes	102	What is it?	111
Printing Confidential Messages	103	What information does it provide?	111
Personal Mailboxes (Security Feature)	103	How to Print	112
Polling	104	How to Interpret	112
What is Standard Polling?	104	Broadcast Confirmation Report (MCF)	112
What is Bulletin Polling?	104	What is it?	112
Sending Documents Requested by Another Fax		What information does it provide?	112
Machine (Polling Transmission)	104	How to Print	113
To Cancel Polling	105	How to Interpret	113
Dialing Another Fax Machine to Request Documents		Broadcast Entry Report	113
(Polling Reception)	105	What is it?	113
Fax on Demand (Bulletin Polling)	106	What information does it provide?	113
Opening a Personal Box for Polling	106	How to Print	113
Loading a Document for Polling	107	How to Interpret	113

Confidential Reception Report	114	Power Outage Report	119
What is it?	114	What is it?	119
What information does it provide?	114	What information does it provide?	119
How to Print	114	How to Print	119
How to Interpret	114	How to Interpret	119
Configuration Report	114	Printing Reports	120
What is It?	114	Using 6/Report Print One Touch key	121
What Information Does it Provide?	115	Codes Used in Reports	121
How to Print	115	Communication Codes	121
How to Interpret	115	Result Codes	122
User Function Settings List	115	Service Codes	122
Message Confirmation Report (MCF)	116	Problem Solving	123
What is it?	116	Clearing a Document Jam	123
What information does it provide?	116	Clearing a Paper Jam	124
How to Print	117	Printing a Cleaning Page	127
Automatic	117	Replacing the Toner Cartridge	128
On Demand (Manual)	118	For Your Safety: Handling the Toner Cartridge	131
How to Interpret	118	Working with the Image Drum Cartridge	131
Phone Directory	118	For Your Safety: Handling the Image Drum	132
What is it?	118	The CHANGE DRUM SOON Message	132
What information does it provide?	118	When to Replace the Image Drum Cartridge	133
How to Print	118	Replacing the Image Drum Cartridge	133
How to Interpret	118	Resetting the Drum Counter	136

Display Panel Messages	137	You set your fax machine for delayed transmission	
Normal Display	137	but it did not send.	144
Error Messages	137	Your fax machine disconnected before you could	
Reading the Print Counters	139	answer a voice request.	144
Problem Checklist	140	Your fax machine will not poll a remote fax machine.	145
The display is blank.	140	Someone tried to send you a confidential fax	
Nothing happens when you press the control		but nothing happened.	145
panel keys.	140	Your fax machine is connected to a PBX and	
The display tells you to replace paper even		you cannot dial out.	145
though there is paper in the paper tray.	141	You want to answer an external telephone but your	
Your documents jam in the scanner.	141	fax machine always answers first.	145
Your fax machine won't dial.	141	Your received faxes sometimes look distorted.	145
The display shows a communication error.	142	You are constantly receiving unsolicited	
You sent a fax but the image the remote fax		advertising on your fax machine.	145
machine received was very poor.	142	Your fax machine does not immediately switch to	
You sent a fax but it was received completely blank. ..	142	TEL mode when you make or receive a voice call.	146
You keep getting reports you do not want.	143	You are experiencing problems communicating with	
The image received on your fax machine was		a remote location in a very noisy telephone area.	146
very poor.	143	Firmware	147
You tried dialing with a One Touch key or an		Identifying Your Current Firmware Version	147
Auto Dial code but nothing happened.	143	Upgrading Your Firmware	147
Your fax machine does not answer the phone		Serial Number of Your Fax Machine	147
or receive faxes.	144	Security	148
Your received documents are light or have vertical		Confidential Faxes	148
streaks on them and you are not out of toner.	144	Rejecting Unsolicited (Junk) Fax Messages	148
		Closed Network Option	148

Safety	150
Installation Hints	150
Operation and Maintenance	151
Handling the Consumables	151
Toner Cartridge	151
Image Drum Cartridge	152
Emergency First Aid	152
Service and Support	153
Your Dealer	153
Okidata on the Internet	153
Contacting Okidata Customer Support	153
Purchasing Supplies and Options	154
Supplies	154
Options	154
User Function Settings	155
User Function Settings List	155
Changing Your User Function Settings	160
Dial Parameter Settings.....	161
Dial Parameter Settings	161
Dial Parameter Settings List	161
Changing Your Dial Parameter Settings	163
Service Function Settings	164
Service Function Settings List	164
Glossary	165
Index	175

Introduction

Thank you for purchasing this OKIFAX 5400 fax machine. It uses advanced LED technology to transfer faxed and copied images to plain paper quickly and sharply. The Multifunction Printer Option (MFP Option, also referred to as the PC Interface) allows it to function as a scanner and 600 dpi class printer for your computer as well. The MFP Option must be purchased separately.

Features

- 30 One Touch keys.
- 99 Auto Dial numbers.
- 20 groups.
- 16 mailboxes for confidential reception.
- Fax communication at up to 14,400 bits per second (bps), or up to 33,600 bps with the optional modem upgrade.
- 2.5 MB of built-in memory.
- A fax forwarding feature that lets your fax machine receive messages into memory and automatically forward the messages to another remote fax machine.
- Year 2000 compliant: all years are recorded in four digits.
- Advanced memory management: memory is freed up as pages are sent for more efficient transmission of long documents.
- A search feature to allow you to look for pre-programmed telephone numbers by name.
- Personal boxes for confidential reception/transmission and bulletin polling.
- Automatic redial and page re-transmission when a telephone number is busy or when problems occur in communication.
- Advanced transmission and reception features, including delayed transmission, transmission to multiple locations, relay broadcast initiate, and polling.

- Advanced memory transmission and reception features, including automatic reception into memory.
- Reports to help you keep track of your fax machine's operations and settings.
- Advanced memory transmission and reception features, including automatic reception into memory.
- High-speed scanning of original documents while dialing, so your fax is ready to send as soon as connections are made.
- Photo (halftone) transmission in up to 64 shades of gray.
- An advanced dual access feature, which allows you to load and prepare multiple documents for transmission while your fax machine is sending or receiving another message.
- A manual paper tray to let you load a different type of paper while making copies.
- A closed network feature to let you limit who can send faxes to your fax machine and whom your fax machine can send faxes to.
- A convenience copy feature that lets you make up to 99 sorted copies of an original document

Product Options

- Non-battery backup memory expansion cards add to existing storage capacity.
 - 1 MB card adds capacity to store up to 80 pages. Order Number 70029101.
 - 2 MB card adds capacity to store up to 160 pages. Order Number 70029201.
- Battery backup memory expansion cards replace existing storage capacity with memory that preserves information when power is turned off or interrupted:
 - 1.5 MB card provides total capacity to store up to 120 pages. Order Number 70031501.
 - 2.5 MB card provides total capacity to store up to 200 pages. Order Number 70031601.
 - 4 MB card provides total capacity to store up to 320 pages. Order Number 40231622.
- Handset with cradle connects directly to your fax machine and works exactly like a telephone. Order Number 70031801.

- Second Paper Tray adds an additional capacity of 500 sheets. When the main tray runs out, your fax machine automatically switches to the second tray for uninterrupted printing. Order Number 70029401.
- 33.6K BPS Modem Upgrade increases the transmission speed of the fax machine. Order Number 40838501.
- Multifunction Printer (MFP Option) allows the fax machine to be used as a scanner and backup printer. Order Number 70035201

Installation

For Your Safety: Installation Hints

- Install your fax machine in a dust-free location away from direct sunlight.
- Do not plug your fax machine into a power source shared by equipment that produces electrical noise (i.e., air conditioners, etc.).
- Leave electronic adjustments to authorized service personnel.
- The LINE terminal connects your fax machine to a standard telephone line. To avoid damage to your telephone system or to the fax machine, do not plug your fax machine into anything other than a standard RJ-11C jack.
- Your fax machine is intended to be grounded electrically and is equipped with a three-wire grounded power cord. For your safety, do not attempt to defeat your power cord's grounding plug.
- The power outlet should be located near the equipment and should be easily accessible.
- The TEL port on the back of the unit is only suitable for two-wire devices. Not all standard telephones will respond to incoming ringing when connected to an extension socket.
- This equipment may not necessarily provide for the effective hand-over of a call from a telephone connected to the same line.

Getting Started

To install your new fax machine, follow the instructions from the “Unpacking” to the “Programming Required Information” sections of this handbook. You must complete these steps for your fax machine to operate properly.

If you have purchased an option package for your fax machine, refer to the documentation you received with that option for installation instructions.

Where to Install Your Fax Machine

- Place your fax machine in a dust-free location away from direct sunlight.
- Allow several inches of space on each side of the machine to ensure adequate ventilation.
- Make sure that both power and telephone outlets are available nearby.
- Choose a location where the relative humidity is between 20% and 80%, and where the temperature is between 50°F (10°C) and 92°F (32°C).

Unpacking

What You Should Receive

Before you begin, be sure that all the items listed below are included in your package.

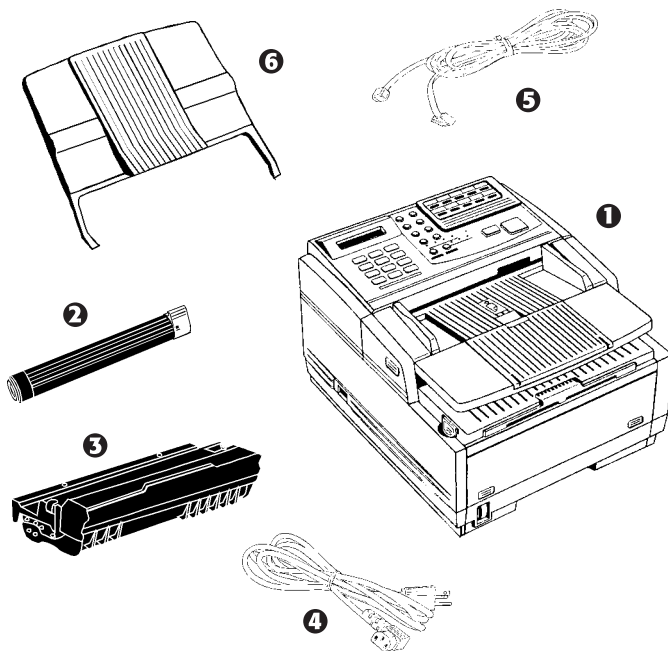

- 1 OKIFAX 5400
- 2 Toner cartridge (wrapped)
- 3 Image drum cartridge (inside machine)
- 4 Power cord
- 5 Telephone line cord
- 6 Document staker tray
- 7 Documentation (Not shown):

Quick Reference

Handbook

Warranty, Regulatory Information, and Specifications

Refer to the illustrations in the “Getting to Know Your Fax Machine” section of this handbook to identify the components.

- ! ***If any items are missing, contact your dealer***
- ***immediately. Keep your packing materials and carton in case you ever need to ship or transport the unit.***

Attaching the Document Stacker

Slip the document staker indents over the tabs on the rear of the unit so that they click into place.

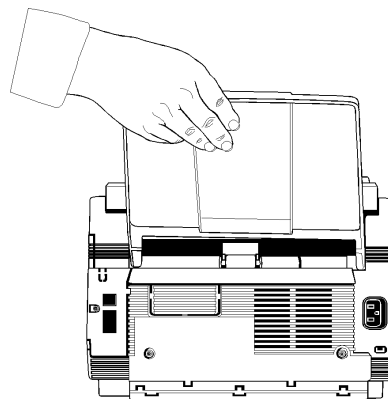

Removing the Protective Sheet

1 Lift up the document table.

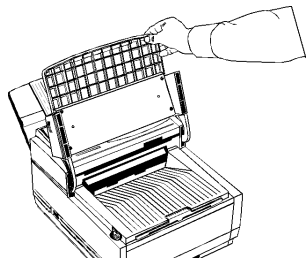

2 Press in the cover release buttons on the side of the copy stacker until it clicks open. Lift up the stacker.

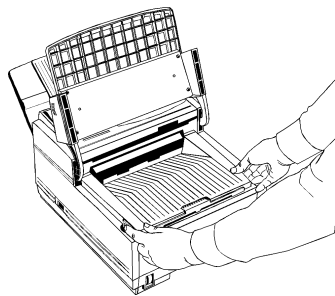

3 Take out the image drum cartridge.

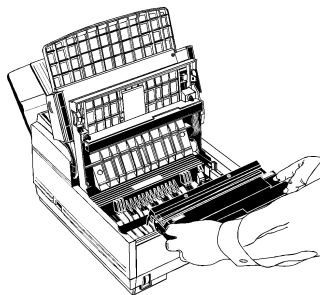

4 Remove the protective sheet. Be careful not to touch the green surface of the drum.

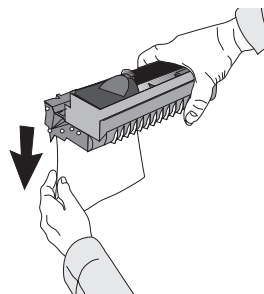

5 Replace the image drum cartridge.

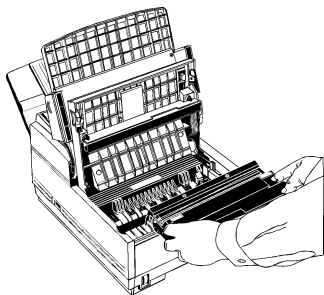

Installing the Toner Cartridge

1 Remove the sponge and discard.

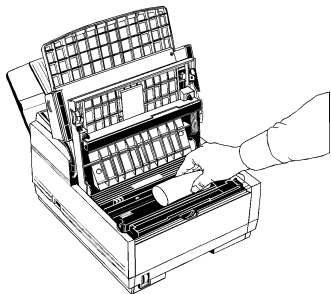

- ! **Warning: Be careful when handling the toner cartridge.**
- **Do not let toner spill on your clothing or other porous materials. If you experience any problems with toner, refer to the “Safety, Handling the Consumables, Toner Cartridge” section of this handbook.**

2 Unwrap the toner cartridge and gently shake it to distribute the toner. Then carefully peel the tape from the bottom of the toner cartridge.

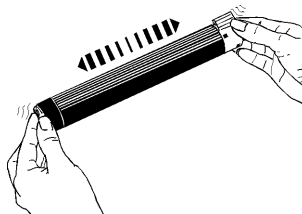

3 With the ridged side facing up and the blue lever on your right, insert the toner cartridge into the image drum unit, left end first.

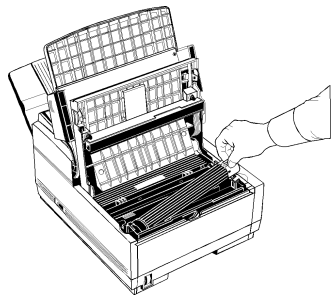

4 Push the lever forward to secure the cartridge.

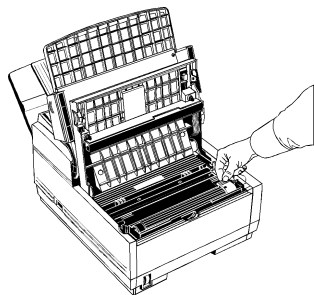

5 Close the copy stacker—push down until you hear both sides click into place.

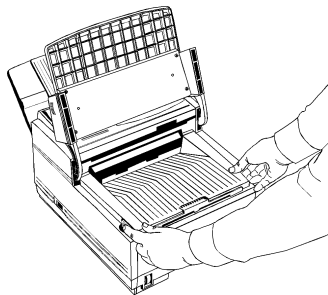

6 Close the document table.

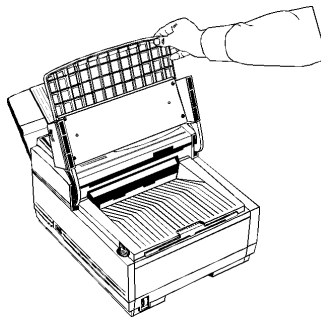

Toner Cartridge and Image Drum Unit Handling

- Leave unused toner cartridges and image drum units in their packages until needed.
- When replacing a toner cartridge or image drum unit, reuse the packaging to dispose of the old toner cartridge or image drum unit.
- Do not expose these components to light for more than five minutes.
- Never expose the green drum (inside the image drum unit) to direct sunlight.
- Always hold the image drum unit by the ends, never by the middle.
- Never touch the surface of the green drum inside the image drum unit.
- Be careful when removing the toner cartridge. Do not let it touch your clothing or porous materials. The toner powder causes permanent stains.
- Small amounts of toner spilled on skin or clothing can be readily removed with soap and cold water. Using heated water will make removing the stain much more difficult.

Emergency First Aid

If toner is swallowed

Dilute by giving two glasses of water and induce vomiting by administering Syrup of Ipecac (follow the manufacturer's instructions). Seek medical attention. Never attempt to induce vomiting or give anything by mouth to a person who is unconscious.

If toner is inhaled

Take person to an open area for fresh air. Seek medical attention.

If toner gets in the eyes

Flush eyes with large quantities of cool water for 15 minutes, keeping eyelids open with fingers. Seek medical attention.

For more information

Refer to the Material Safety Data Sheet in the *Warranty, Regulatory Information, and Specifications* booklet.

Loading Paper

Your fax machine can hold up to 250 sheets of standardweight (20 lb.) paper. For best results, use paper specially made for laser printers or photocopiers. It can use letter, legal, and A4 size paper.

Your fax machine automatically reduces the vertical length of the page images it receives to fit on the paper loaded in it, down to 75% of the original length. For example, if you are receiving a document created originally on legal-size paper, your fax machine can reduce the received pages to fit on letter or A4 paper.

- ! ***Your fax machine is set at the factory to use letter-size paper. To use a different paper size, change the setting of User Function 13, 1'ST PAPER SIZE to match your new paper size. Refer to the "Setting Basic Features, User Function Settings" section of this handbook.***

- 1 Pull the paper tray out of the machine.

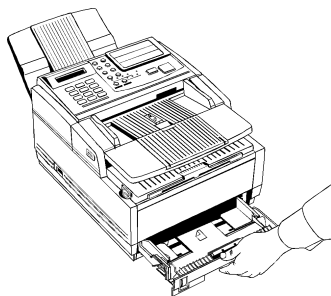

- 2 Adjust the paper guides to the width of your paper.

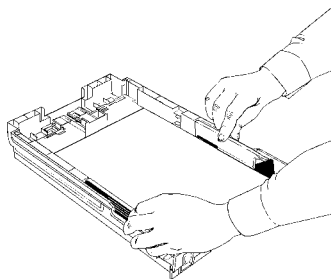

3 If necessary, lift and adjust for the length of your paper.

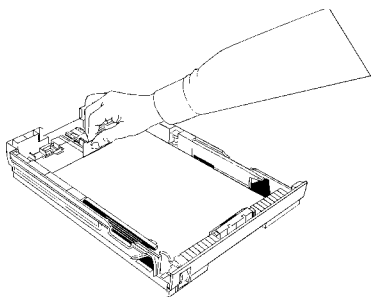

4 If you are using legal-size paper, pull out the extension at the back of the paper tray.

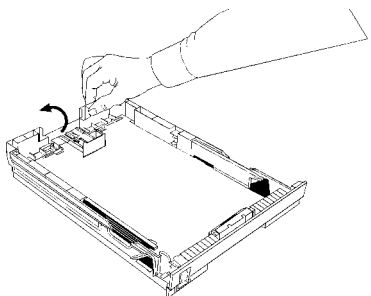

5 Remove the paper from its wrapper (up to 250 sheets). Note the “print side” notice printed on the label. Fan the paper.

6 Load the paper into the paper tray, print side DOWN.

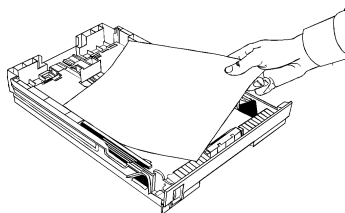

! ***Be sure the paper is under the tabs on the sides of the tray. Do not fill past the Paper Full mark. If necessary readjust the guides for a snug—but not tight—fit.***

7 Replace the paper tray. Push it forward until it locks.

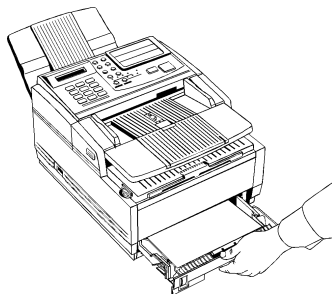

Connecting the Telephone Line

Insert one end of the telephone cord into the LINE jack in the back of the machine, and the other end into your wall telephone jack.

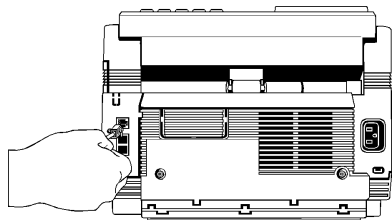

- ! *Now, you can connect either an external telephone or the external handset option for your fax machine. Refer to the “Connecting an External Telephone or Answer Machine” section of this handbook.*

Connecting an External Telephone or Answering Machine

- ! *Any external telephone or answering machine connected to the fax machine must be FCC and CSA approved.*

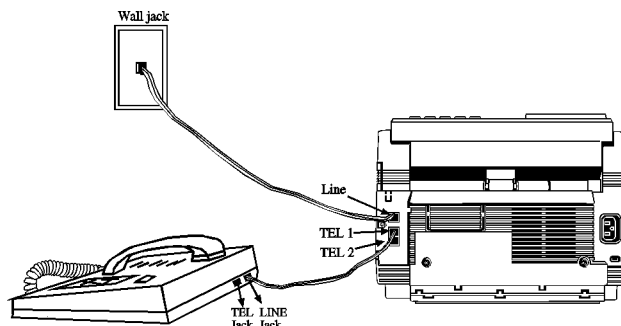

- Insert one end of the telephone cord into the TEL 1 or TEL 2 jack on the back of the fax machine, and the other end into the jack in your external device.
- To connect both an answering machine and a telephone, first connect your answering machine to your fax machine, then plug your external telephone's cord into the telephone jack on your answering machine.

- ! *You must have the TAD mode feature turned on for an answering machine to work with your fax machine.*
- *Refer to the “Answering Mode, Setting the Answering Mode” section of this handbook.*

Connecting The External Handset (Option)

If you purchased the external handset option with your fax machine, follow these instructions to install it.

- 1 Using the supplied screw, connect the handset cradle to its base.

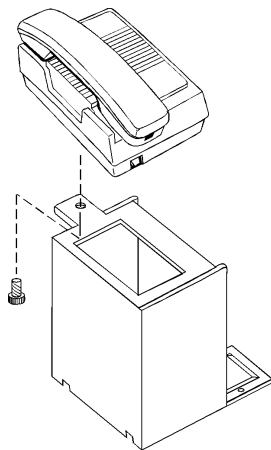

- 2 Position the handset cradle on the left side of the fax machine.

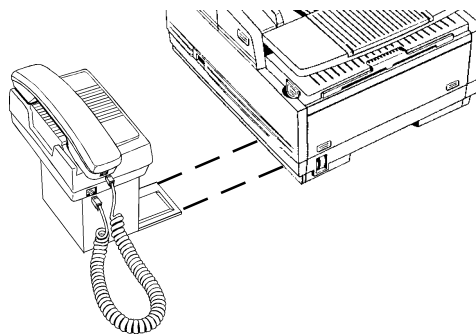

- 3 Plug one end of the handset cord into the handset and the other end into the jack on the front of the cradle. Place the handset in the cradle.

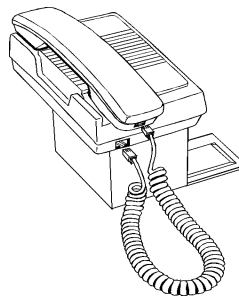

- 4 Insert the supplied telephone cord into the jack located on the back of the cradle.
- 5 Feed the telephone cord from the back of the cradle through the cable run (1) located on the back of the fax machine.

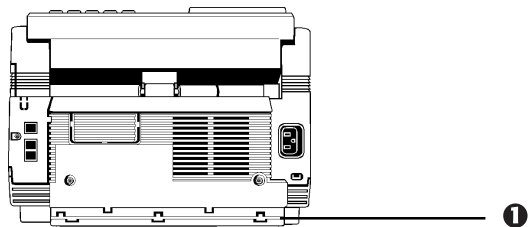

- 6 Insert the end of the cord into the TEL 1 or TEL 2 jack on the back of the fax machine.

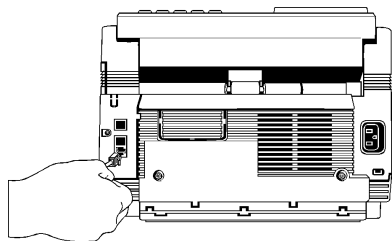

- ! *The two TEL jacks are provided to allow you to connect both an external handset and an answering machine.*

Connecting Power

- 1 Make sure the power switch is off.

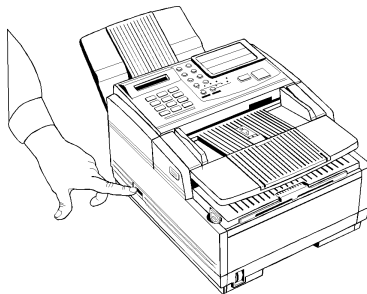

2 Plug the power cord into the back of the unit.

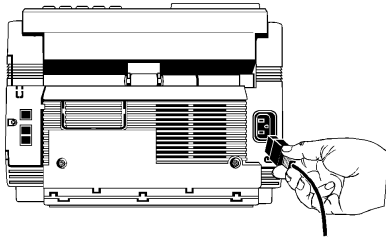

- 3 Plug the other end into a grounded AC power outlet.
- 4 Turn on your fax machine. After the unit warms up, the time and current answering mode appear on the display. Your fax machine is now in standby mode, ready to send or receive faxes.

Programming Required Information

FCC Telephone Consumer Protection Act

The Federal Communications Commission Telephone Consumer Protection Act of 1991 makes it unlawful for any person to use a computer or other electronic device to send any message via a telephone fax machine unless such message clearly contains in a margin at the top or bottom of each transmitted page or on the first page of the transmission, the date and time it is sent and an identification of the business or other entity, or other individual sending the message, and the telephone number of the sending machine or such business, other entity, or individual.

To comply with this law, you must enter the following information in your fax unit.

- Date and Time
- Fax Identification (Name and Telephone Number)
which identifies the source of your fax transmission

Refer to the following sections for instructions on how to program this information.

Date and Time

Fax machines must accurately identify the date, time, sender and the telephone number of the sending fax machine on each page of every fax they send. You are required by law to program this information into your fax machine.

- 1 Press the Select Function key.
- 2 Press the 9/User Program One Touch key located on the One Touch keypad.
- 3 On the numeric keypad, press 3. The display shows

3:CLOCK ADJUSTMENT.

- 4 Press the Yes ◀ key. The display shows the currently set date and time.
- 5 Using the numeric keypad, enter the new date (month/day/year) and time in 24-hour format. Examples: 8:00 AM is 08:00; 8:00 PM is 20:00.
- 6 Press the Yes ◀ key to confirm your entry.
- 7 Press the Select Function key to finish.

Fax Identification

Fax machines must accurately identify the date, time, sender and the telephone number of the sending fax machine on each page of every fax they send. You are required by law to program this information into your fax machine.

Sender ID:

This is a descriptive title that identifies the sender—usually the location of your fax machine or the name of your company or office and the fax machine's number. It is printed at the top of every fax you send. You can enter up to 32 characters. The first 16 characters of your Sender ID will also be used as your Personal ID. This Personal ID appears on the displays or reports of other Oki fax machines you communicate with.

TSI/CSI:

This is the telephone number of your fax machine; it appears on the displays of other non-Oki fax machines you communicate with.

Call Back Number:

This is a telephone number (not a fax number) which the operator of the remote machine can use to reach you. If you

use the voice request function (Refer to the “Basic Faxing Operations, Using Voice Request” section of this handbook) while communicating with another fax machine and no one is there to answer, your fax machine automatically sends a cover letter with a call back message. The message is printed on a separate sheet with the message “Please call back” and a telephone number where you can be reached—the number entered here.

To Program Your Fax ID:

- 1 Press the Select Function key.
- 2 Press the 9/User Program One Touch key. The display shows

1:FUNC. PROGRAMMING.

- 3 On the numeric keypad, press 4. The display shows

4:SYSTEM DATA PRG.

- 4 Press the Yes ◀ key. The display shows

NO=<TSI/CSI>, ID=<SENDER ID>.

- 5 After the display clears, enter the full telephone number of your fax machine using the numeric keypad.

! *Use the Hyphen key to enter a “+” character for international numbers, and use the Space One Touch key to enter spaces.*

- 6 Press the Start key to save your entry.
- 7 Enter your Sender ID. This is a descriptive title up to 32 characters long. Refer to the instructions below.
 - To enter numbers, use the numeric keypad (press once)
 - To enter spaces, use the 14/Space One Touch key
 - To enter hyphens, use the Hyphen key
 - To enter alphabet characters, locate the character you want on the numeric keypad.
 - Press that key repeatedly until the character appears on the display.
 - To enter a unique character, press the 0/Unique key repeatedly until the character you want appears on the display. The following characters are available: ! # & ‘ () * + , - . / : ; = ? · ã ß ñ ö ü Æ Å Ø æ å ø
 - To enter two successive letters/numbers using the same key, press the No ▶ key to move to the next character.
 - To move the cursor to make corrections, press the Yes ◀ and No ▶ keys.

8 Press the Start key to save your entry. The display shows

NO=<CALL BACK NO.>.

9 After the display clears, use the numeric keypad to enter the telephone number for call back messages.

Enter up to 20 characters.

! *Use the 14/Space One Touch key to enter spaces.*



10 Press the Start key to save your entry.

11 Press the Select Function key to finish.

Getting to Know Your Fax Machine

Component Identification

Front of the Unit

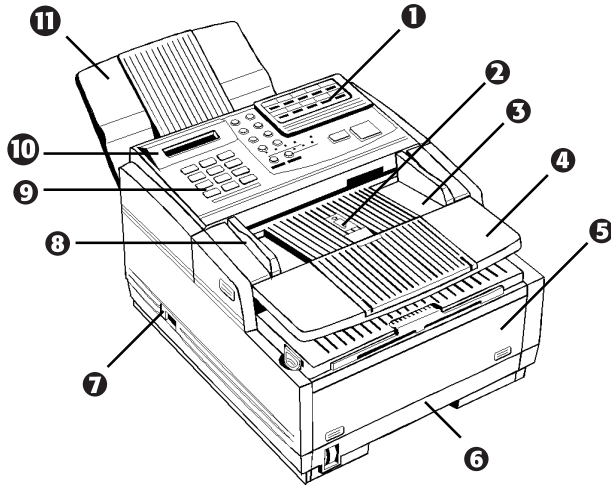

1 One Touch Keypad

Use for preprogrammed one touch dialing or for setting functions.

2 Paper Path Icon

Load documents here face down.

3 Document Table

Covers the copy stacker and holds original documents to be faces or copied.

4 Document Table Extension

Flips out to support longer documents.

5 Front Panel

Gives you access to the manual paper feeder. This allows you to bypass the paper tray and feed a different type of paper directly into the fax machine.

6 Paper Tray

Holds up to 250 sheets of paper.

7 Power Switch

Press I to turn on, 0 to turn off.

8 Document Guides

Adjust these guides to the page width of the documents that are to be copied or faxed.

9 Numeric Keypad

Use to enter phone numbers, auto dial numbers, or information programmed into the fax machine.

10 Display Panel

Shows status of machine and faxes in progress

11 Document Stacker

Holds your original documents after they are faxed or copied.

Back of the Unit

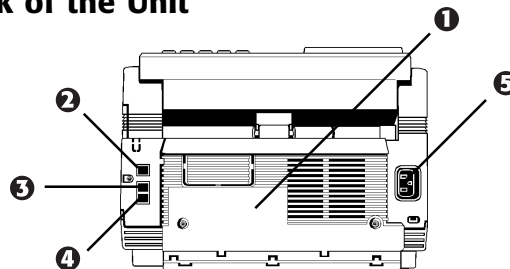

1 Back Cover

Open this cover to expose the expansion slot to install the

- optional memory expansion board and / or
- Multifunction Printer Option (MFP, also known as the PC interface).

2 LINE Jack

Jack for connecting to an outside telephone line.

3 TEL 1 Jack

4 TEL 2 Jack

Jacks for connecting to an optional handset, external phone, or answering machine.

5 AC Power Inlet

Plug the supplied AC power cord into this inlet.

Inside the Unit

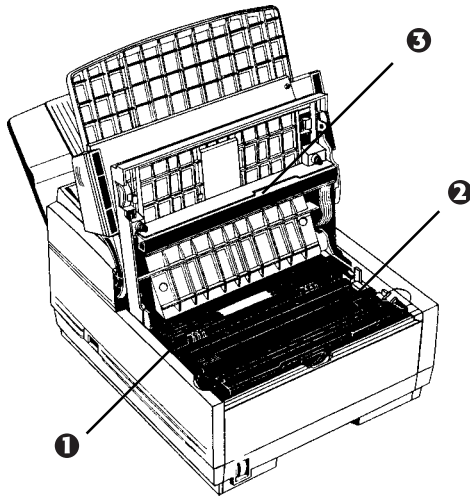

1 Image Drum Cartridge

The image drum cartridge contains the green photosensitive drum that receives images from the LED print head and transfers them to the printing paper.

2 Toner Cartridge

This black cylinder, installed inside the image drum cartridge, contains the black powder that forms the image on the paper. You need to install a new toner cartridge when the **REPLACE TONER CART** message appears on the display.

3 LED Printhead

This black bar writes received or copied images onto the image drum. You should clean this bar each time you change the toner cartridge.

Locating the Serial Number

The serial number of your fax machine is on a label on the side or back of your fax machine.

The label will say “S/N”.

An example serial number is: 401A0154693.

Control Panel Keys and Indicators

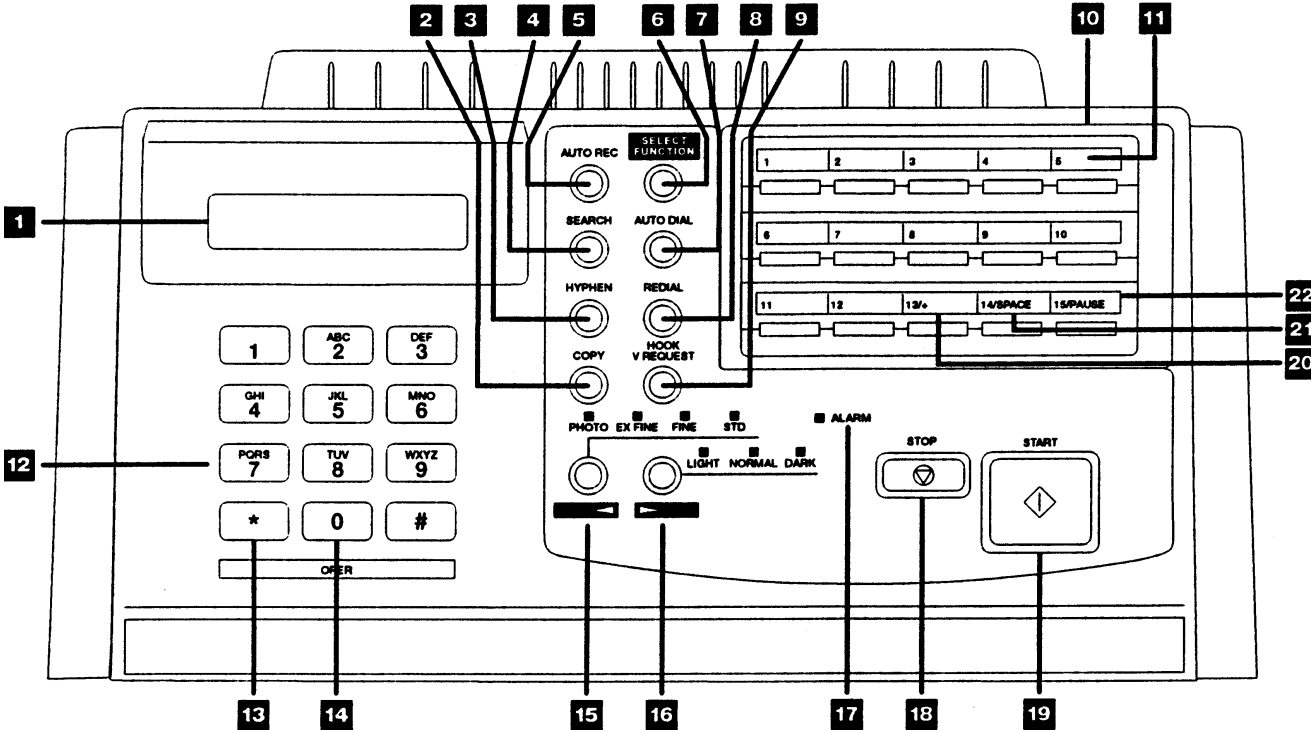

1 Display Panel

Refer to this display for instructions and information while your fax machine is performing operations or while you are entering information or changing settings.

2 Copy key

After loading a document, press this key to make a copy. When no documents are loaded, press this key once to display a Message Confirmation Report about your last transmission on the LCD Display Panel, and a second time to receive a printed report. You can also use the Copy key to program a manually entered fax number into a One Touch key or Auto Dial number. Refer to the “Programming Your Speed Dial Directory, One Touch Faxing and Auto Dial Faxing” sections of this handbook for details.

3 Hyphen key

When programming One Touch keys and Auto Dial telephone numbers, use this key to tell your fax machine to pause briefly before it dials the rest of the telephone number.

4 Search key

The One Touch keys and Auto Dial numbers can be programmed to have a name or location ID associated with their telephone numbers. Using this key by itself or in combination with the numeric keypad, you can search for these numbers alphabetically. You can also use the Search key to search for unassigned One Touch keys and Auto Dial numbers.

5 Auto Rec key

Use this key to switch your fax machine’s answering mode. The answering mode controls how your fax machine answers incoming calls and receives faxes. The display will always indicate your current selection. Refer to the “Answering Mode, Setting the Answering Mode” section of this handbook for more information about the answering modes available.

6 Select Function key

Use this key to activate your fax machine’s advanced transmission and reception functions, to obtain reports and to start programming functions. To select a function, press the Select Function key, then press the One Touch key labeled with the function you want to use. While

programming or selecting other functions, pressing the Select Function key a second time takes you directly back to your fax machine's standby mode.

7 Auto Dial key

Auto Dial numbers are abbreviated numbers for rapid dialing. Rather than dialing the entire telephone number, you can enter a 2-digit Auto Dial number instead. You can also use the Location IDs (names) associated with Auto Dial numbers to search for these locations by name using the Search key.

8 Redial key

Press this key to manually redial the last number dialed.

9 Hook/V. Request key

Press this key to open a telephone line for manual dialing. You can hear the dialing through your fax machine's speaker.

If you have an optional telephone handset or external telephone connected to your fax machine, you can also use this key to initiate or answer a request for voice communication during a fax communication. Press this

key while transmitting to signal the operator at the other fax machine that you want to talk to him or her at the end of your transmission or after reception of any page has been completed. To answer a voice request, press this key after lifting your telephone handset.

10 One Touch keypad

Each of the keys on this keypad can be programmed with a fax number. You can dial this number by pressing the corresponding key. Refer to the "Programming Your Speed Dial Directory, One Touch Faxing" section of this handbook for details. The keys are also used to control and program fax machine functions.

11 One Touch labels

After programming a location into a One Touch key, write the location's name on the One Touch label. Lift off the plastic cover above the One Touch label, use a pencil to write in the name, then replace the cover.

12 Numeric keypad

When dialing, these 12 keys work just like the keypad on a telephone. Also, use the keypad to enter numbers, letters and other characters while programming functions or information. After pressing the Search key, use the numeric keypad to alphabetically search for the names of locations programmed into your fax machine.

13 */Tone key

If your fax machine is set to pulse dialing, this key allows you to switch from pulse to tone dialing during your current call. You can also use this key while programming to create numbers with mixed pulse-then-tone operation.

14 0/Unique key

When dialing, use this key to enter a zero. When programming your Sender ID or a Location ID, you can use this key to enter a variety of unique characters, including: ! # & ' () * + , - . / : ; = ? · ä ß ñ ö ü Æ Å Ø æ å ø.

15 Transmit Resolution/Yes ◀ key

After you load a document, use this key to change the transmission resolution used. Use STD for standard originals, FINE and EX.FINE for detailed or small print originals, and PHOTO for originals that include colors or many shades of gray.

Use this key also as the Yes ◀ key when making selections or to move your cursor to the left while entering information.

16 Type of Original/No ▶ key

Use this key to select the document contrast after you load a document for transmission. Use LIGHT for originals that are too light, NORMAL for documents with good contrast, and DARK for originals that are too dark.

Use this key also as the No ▶ key when making selections or to move your cursor to the right while entering information.

17 Alarm indicator

This indicator glows red and an alarm sounds to notify you of any problem that occurs. Check the display panel for an explanation of the problem. To turn the alarm indicator off, press the Stop key and correct the problem.

18 Stop key

This key cancels the operation currently in progress and turns off the Alarm Indicator. After loading paper, installing a new toner cartridge, or correcting an alarm condition, press this key to turn off the Alarm Indicator. While you are programming, pressing the Stop key takes you back step-by-step through the programming functions you have already selected.

19 Start key

Press this key to initiate the operation indicated on the display or to confirm information you have entered into the display.

20 Plus key

In addition to its function as a programmable One Touch key, this key is used for chain dialing, which allows you to dial a number using any combination of One Touch keys, Auto Dial numbers, and the numeric keypad. When

programming a chain dial number into a One Touch key or Auto Dial number, press the Plus key (One Touch keys 13 and 28) at the end of the first part of the number to indicate that this is a chain dial number. Refer to the “Programming Your Speed Dial Directory, Chain Dialing” section of this document for details.

21 Space key

Use One Touch keys 14 and 29 on the One Touch Keypad to enter spaces while programming. Unlike the Pause and Hyphen keys, spaces are used for easier reading only and have no effect on dialing.

22 Pause key

Use One Touch keys 15 and 30 on the One Touch keypad to enter automatic 3-second pauses in dialing when programming telephone numbers. Pauses in telephone numbers are marked by a “P” symbol.

The Speed Dial (One Touch) Keypad

The One Touch keys are your fax machine's most important tool. Use them for quick, one-touch dialing, and to access most functions and programming options.

Using the One Touch Keys for Dialing

To use a One Touch key for dialing, just press the appropriate One Touch key. For each key, you can program up to two telephone numbers: a primary number, which will always be dialed first, and an optional alternate number which will be automatically dialed if the first number is busy or if there is no answer. You can also use the Search key to find locations programmed into One Touch keys.

- ! ***One Touch Keys available: keys 1–15 on the main One Touch panel and keys 16–30 beneath the main One Touch panel. To access One Touch keys 16–30, simply lift the main One Touch keypad by the latch on the left side of the cover. When you're finished, close the keypad to continue normal operation and programming.***

Using the One Touch Keys for Selecting Functions and Programming

Use One Touch keys 1–10 for selecting special transmission and reception functions, for obtaining reports, and for quick access to programming functions.

To select a function:

- 1 Press the Select Function key.
- 2 Press the corresponding One Touch key.

List of One Touch Keys with Descriptions

1/Delayed TX key

Use this key to send a fax at a later time and date (within three days). Refer to the “Advanced Operations, Sending a Fax at a Later Date and time” section of this handbook.

2/Broadcast Feeder TX key

Use this key to send a fax to multiple locations or to switch from memory to the document feeder when preparing to send a fax. Refer to the “Sending a Fax to Multiple Locations (Broadcasting)” section of this handbook.

3/Confidential TX key

Use this key to send a confidential document to a mailbox (a secure memory storage area) in the receiving fax machine. Refer to the “Advanced Operations, Confidential Faxes (Security Feature)” section of this handbook.

4/Relay Initiate TX key

Use this key to set up a relayed fax transmission. During a relayed fax transmission, your fax machine initiates the transmission by sending a document to a second fax machine, which then broadcasts the message to a number of other fax machines. Refer to the “Relay Faxing” section of this handbook.

5/Polling key

When a document is loaded on the document tray, use this key to set your fax machine to wait for another fax machine to call and request the document to be sent (polling transmission). When no document is loaded, use this key to call another fax machine and request it to send the documents loaded into it (polling reception). Refer to the “Advanced Operations, Polling” section of this handbook.

6/Report Print key

Use this key to print reports or phone lists manually. Refer to the “Reports” section of this handbook.

7/Counter Display key

Your fax machine keeps track of the number of pages it has printed and scanned. Use this key to check the print and scan counters. It can also be used to reset the drum counter after replacing the image drum unit. Resetting the drum counter is available only when the **CHANGE DRUM SOON** message displays.

8/Location Program key

Use this key to program One Touch keys, Auto Dial numbers and groups. Refer to the “Programming Your Speed Dial Directory” section of this handbook.

9/User Program key

Use this key to program identification information, to set the clock, and to change function and dial parameter settings.

10/Message Print From Memory key

Your fax machine is set to receive messages into memory and not print them when it runs low on toner. Using this key you can force messages to print, although print quality may be poor because toner is low. This key is also used to print confidential fax messages received into mailboxes in your fax machine's memory. Refer to the "Advanced Operations, Confidential Faxes (Security Feature)" section of this handbook.

When no messages are in memory, use this key to print a cleaning page to clear accumulated toner from the image drum. Refer to the "Problem Solving, Printing a Cleaning Page" section of this handbook.

Signal Tones

Your fax machine makes a number of sounds to inform you of specific conditions.

Key Select tone: This is a short beep that occurs every time you press a key.

Error tones: If you press a wrong or inappropriate key, your fax machine emits three short beeps. If it experiences a problem during communications, it emits three long beeps. Press the Stop key to turn the error tone off, then print a Message Confirmation Report to check the source of the problem—to do this, press the Copy key twice with no documents loaded.

Voice Request tone: During a fax session, either you or the person at the remote fax machine may initiate a voice request. When the person at the remote machine either initiates or answers your voice request, your fax machine emits a repetitive warbling sound.

End of Session tone: At the end of every successful fax session, your fax machine emits a short beep to inform you that there were no errors or problems in the communication.

Off-Hook Alarm tone: If it is equipped with the optional handset, and if the handset is left off the hook, your fax machine emits an intermittent warbling sound. To turn off the sound, hang up the handset and press the Stop key.

Dual Access

Your fax machine's dual access feature allows you to load and prepare to transmit (send) a document while your fax machine is receiving or sending another fax from memory. This feature increases your productivity and reduces the time you spend waiting for operations to finish.

Once you have loaded a document and the display shows **SELECT LOCATION**, your fax machine is ready for you to prepare the next transmission.

Refer to the "Working with Dual Access" section of this handbook for further information.

Using Your Fax with Your Computer

By installing the Multifunction Printer Option (MFP), you may connect your fax machine to your computer, allowing you to work using both machines. You may use your fax machine as a scanner or printer. Incoming faxes may be saved directly to your computer's hard drive.

For information on installing and using the MFP Option, refer to the documentation provided with the option.

Refer to the “Answering Mode, PC Mode [PC]” section of this handbook for information on setting the answering mode of your fax machine to work with the MFP Option.

Refer to the “Setting Basic Features, PC/Fax Switch” section of this handbook for information on saving incoming faxes directly to your computer's disk without being printed.

Connect to Your Computer

- 1 Make sure that both the computer and the fax machine are turned off.
- 2 Connect the end of the interface cable to your computer. Tighten the screws to secure it.
- 3 Connect the other end of the cable to the fax machine. Fasten the cable in place with the wire clips.

Setting Basic Features

Control Panel Keys and Indicators

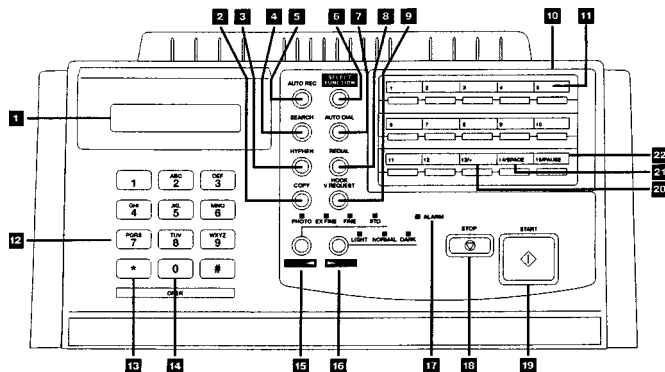

- 1 Display Panel
- 2 Copy key
- 3 Hyphen key
- 4 Search key
- 5 Auto Rec key
- 6 Select Function key
- 7 Auto Dial key
- 8 Redial key
- 9 Hook/V. Request key
- 10 One Touch keypad
- 11 One Touch labels
- 12 Numeric keypad
- 13 */Tone key
- 14 0/Unique key

- 15 Transmit Resolution/Yes ◀ key
- 16 Type of Original/No ▶ key
- 17 Alarm indicator
- 18 Stop key
- 19 Start key
- 20 Plus key
- 21 Space key
- 22 Pause key

Navigating Programming Levels

Many of your fax machine's features and functions have settings which can be changed to customize its operation. These settings are accessed through different programming levels: user functions, dial parameters, and service functions.

The user functions control a broad range of features, such as when certain reports print and how the machine response to incoming calls.

The dial parameters control how the machine dials fax numbers; in most cases, the settings are determined by the type of telephone service you have.

Your Authorized OKIFAX Dealer must change the service functions.

Viewing Your Current Settings

The configuration report lists the current settings of all user functions, among other things. Refer to the "Reports, Configuration Report" section of this handbook.

To print a configuration report:

- 1 Press the Select Function key.
- 2 Press the 6/Report Print One Touch key.
The display shows 1:ACTIVITY REPORT.
- 3 Using the numeric keypad, press 4.
The display shows 4:CONFIGURATION.
- 4 Press the Yes ◀ key. The report prints.

User Function Settings

User function settings allow you to customize the general operation of your fax machine. Refer to the following User Function Settings List to determine which settings you may need to change, then refer to the "Changing Your User Function Settings" part of this section to make the change.

User Function Settings List

01 MCF(SINGLE-LOC.)

This function automatically prints a Message Confirmation Report after each single-location transmission or polling transmission. The report provides information about the transmission. Refer to the “Reports, Message Confirmation Report” section of this handbook.

Available settings are ON and OFF (default).

02 MCF(MULTI-LOC.)

This function automatically prints a Message Confirmation Report after each multiple-location transmission. The report provides information about the transmission. Refer to the “Reports, Message Confirmation Report” section of this handbook.

Available settings are ON (default) and OFF.

03 ERR REPORT (MCF)

This function automatically prints a Message Confirmation Report every time an error occurs during a transmission or polling transmission operation. The report provides information about the transmission. Refer to the “Reports, Message Confirmation Report” section of this handbook.

Available settings are ON (default) and OFF.

04 IMAGE IN MCF

When a message confirmation of a memory transmission is printed, this function adds a portion of the first page of the document that was sent. This feature makes it easier to identify a fax, but it may present security problems if you are sending sensitive documents.

Available settings are ON (default) and OFF.

05 SENDER ID

This function controls the printing of your fax machine’s Sender ID on the faxes you send. Refer to the “Programming Required Information, Fax Identification” section of this handbook for details. When turned on, the Sender ID will be printed on each page slightly outside the image area of your document. The default setting is ON.

- ! *In order to meet FCC requirements, you must have this*
- *feature set to ON and have a valid Sender ID programmed in your fax machine.*

06 MONITOR VOLUME

This function sets the volume for telephone line monitoring during dialing.

Available settings are LOW (default), HIGH, and OFF.

07 BUZZER VOLUME

This function sets the volume of the various tones your fax machine emits during operation. Available settings are LOW, MIDDLE (default), and HIGH.

08 CLOSED NETWORK

This function allows you to program your fax machine to refuse to communicate with locations whose telephone numbers have not been programmed into your One Touch keys or Auto Dial locations. Using this function, you can set up a closed network of fax machines. Refer to the “Security, Rejecting Unsolicited (Junk) Fax Messages” section of this handbook. If you do not want your fax machine to transmit faxes to or receive faxes from locations outside your network, select T/R. If you only want your fax machine to refuse to receive faxes from outside your network, select RX.

Available settings are OFF (default), T/R, and RX.

09 TX MODE DEFAULT

Your fax machine is set for the STD (standard) resolution setting and the NORMAL contrast setting. If you consistently send faxes that require some other combination of transmission modes, use this function setting to change the default modes. While you are programming, the new default combinations appear on the lights above the Yes ◀ and the No ▶ keys. The default is STD/NORMAL.

10 T/F TIMER PROG.

When set to the telephone/fax answering mode, your fax machine automatically distinguishes between incoming voice and fax calls. If the incoming call is a voice call, the fax machine rings to tell you to pick up the handset. If you do not answer, the fax machine automatically switches back to fax mode to allow the calling party to send a fax. The T/F TIMER function controls how long it waits before switching back to fax mode.

Available settings are 20 SECONDS or 35 SECONDS (default).

11 RING RESPONSE

This function controls how long your fax machine waits before answering an incoming telephone call. The available settings are 1 RING (default), 5 SECONDS, 10 SECONDS, 15 SECONDS, or 20 SECONDS.

- ! *At the default 1-ring setting, your fax machine answers calls immediately, and you will not hear any ring. If you need to hear the ring, change to one of the other settings.*

12 DISTINCTIVE RING

Some telephone carriers offer a service called Distinctive Ring. Distinctive Ring lets you have different numbers on one line, each with its own distinctive ring. You can then use one number exclusively as a fax number without the expense of a second line. (Your local telephone carrier can provide you with more information about this service, which usually has an additional charge.) To use this function, refer to Setting Distinctive Ring below.

Available settings are OFF (default) and ON.

- ! *You must have your local telephone carrier's Distinctive Ring service.*

Your fax machine must be in FAX or PC answer mode, and the PBX dial parameter must be set to OFF. Other modes—TEL, TEL/FAX, or TAD—will override Distinctive Ring.

This feature may not work properly if you have a telephone other than a genuine Oki optional handset connected to your fax machine.

Setting Distinctive Ring

To set up your fax machine to recognize another ring pattern:

- 1 Press the Select Function key.
- 2 Press the 9/User Program One Touch key.

The display shows

1:FUNC. PROGRAMMING.

- 3 Press the Yes ◀ key. The display shows

FUNCTION NO. [].

4 Using the numeric keypad, enter 12. The display shows

DISTINCTIVE RING, OFF.

5 Press the No ► key two times. The display changes to

DISTINCTIVE RING, SET.

6 Press the Yes ◀ key. The display changes to

SETUP FAX RING
CALL FAX NUMBER NOW.

7 Using a separate telephone line, dial the number assigned to the fax machine within 90 seconds—if you don't have access to a second line, have someone else make the call for you. When your fax machine begins to ring, it automatically detects and remembers its assigned ring pattern. Be sure to let it ring until either **RESULT=OK** or **RESULT=NG** displays. When the fax machine has successfully finished programming its ring pattern, the display shows **RESULT=OK**.

! *Occasionally, your fax machine may not be able to detect its ring pattern on the first try. If this happens, the display shows **RESULT=NG**. Follow the instructions again from Step 6.*

8 Press the Yes ◀ key to confirm your selection.

9 Press the Select Function key to finish.

13 1'ST PAPER SIZE

This function allows you to specify the size of paper you are using in the paper tray.

Available settings are letter (default), A4, legal 13, legal 14, and OTHER.

Using the OTHER setting, with MFP Option installed

The MFP Option must be installed to work with the OTHER setting.

When using the fax machine as a PC printer, you can load A5 and B5 size paper into the paper tray. However, reports and standard size faxes (letter, legal, or A4) will not print completely on these paper sizes. Select the OTHER setting when you have these or other smaller sizes loaded; this

prevents faxes and reports from printing partially. When OTHER is selected, faxes are stored in the fax machine and only print when you have loaded a standard paper size and changed the 1ST PAPER SIZE setting to match the paper loaded.

- ! **Important:** *If you use the OTHER setting, be sure to reset your fax machine to a standard paper size as soon as you are finished. Otherwise you cannot receive faxes.*
- **Keep in mind that when you select OTHER, power outage reports do not print—this is the only notification that power to the fax machine has been disrupted.**

14 2ND PAPER SIZE

This function allows you to specify the size of the paper you are using in the optional second paper tray, and only appears if that option is installed. Refer to User Function 13, 1st Paper Size for details.

15 USER LANGUAGE

This function allows you to switch between the two languages programmed into your fax machine. Available settings are ENG. (English, the default) and SPA. (Spanish), FRE. (French), or POR. (Portuguese), depending on what fax machine language configuration you purchased.

16 INCOMING RING

This function controls the telephone ringing sound your fax machine makes when a call comes in. When set to off, it does not ring during incoming calls. The available settings are:

- ON (default): Only rings when set to Manual Receive [TEL] mode or when the RING RESPONSE function is set to 5, 10, or 20 seconds.
- OFF: Does not ring when a call comes in.
- DRC (distinctive ring cancel): Rings for each incoming call with the same tone, even if you have set function setting 12, DISTINCTIVE RING to on.

17 REMOTE RECEIVE

This function lets you use an attached phone to tell your fax machine to switch from telephone to fax mode so it can receive an incoming fax. Use the keypad of an external telephone to enter the remote receive number you have programmed into your fax machine.

In addition, if your fax machine is in TAD mode, a caller can enter the programmed remote receive number after leaving a voice message; this enables the fax machine to receive a fax from the caller. Refer to the “Answering Mode, Using Your Fax with an Answering Machine [TAD]” section of this handbook.

Available settings are OFF (default), 00, 11, 22, 33, 44, 55, 66, 77, 88, 99, **, and ##.

18 MEM./FEEDER SW.

The fax unit is set to scan documents in and transmit them from memory. This function controls how manual feed transmissions are performed. Available settings are FEEDER (the default setting) and MEMORY.

To perform a manual feed transmission with FEEDER

selected:

- 1 Press Select Function
- 2 Press BROADCAST↔ FEEDER TX
The display shows
FEEDER TX
YES(LOC.) NO(→)

- 3 Enter the location, then press START.

If you do a lot of broadcast transmissions, change this setting to MEMORY.

To perform a broadcast transmission with MEMORY selected:

- 1 Press Select Function.
- 2 Press BROADCAST↔ FEEDER TX
The display shows
BROADCAST/MEMORY TX
YES(LOC./#) NO(→)

- 3 Enter the list of locations, then press START.

19 NOT USED

20 ECMFUNCTION

The Error Correction Mode (ECM) function may help your fax machine improve communication in areas where telephone line conditions are marginal. Refer to the “Problem Solving” section of this handbook for other suggestions if you have communication problems.

Available settings are ON (default) and OFF.

21 REMOTE DIAGNOSIS

The remote diagnostics feature allows a service person remotely to dial and service your fax machine.

Available settings are ON and OFF (default).

22 PC/FAX SWITCH

This function is active only when the Multifunction Printer Option is installed and your fax machine is set to the PC Fax answering mode. In that case, incoming faxes are saved directly to the PC’s disk without being printed. If the PC is turned off or not functioning, the fax machine acts as a stand-alone fax machine and prints incoming faxes when this PC/FAX SWITCH function is set to ON (default). If this function is set to OFF, the fax machine will not accept incoming faxes when the PC is turned off or not functioning.

23 ONE TOUCH PARAM

This function allows you to activate the Echo Protection feature for a specific One Touch key, without changing the normal settings. Echo Protection can improve communication with a location in a noisy telephone area. For instructions on changing One Touch Parameters settings for a One Touch key, refer to the “Programming Your Speed Dial directory, One Touch Faxing” section of this handbook.

Changing Your User Function Settings

- 1 Press the Select Function key.
- 2 Press the 9/User Program One Touch key.
The display shows

1:FUNC. PROGRAMMING.
- 3 Press the Yes ◀ key. The display shows

FUNCTION NO. [].

- Using the numeric keypad, enter the 2-digit number of the function you want to change. The display shows the name of the selected function.
- Repeatedly press the No ► key until the setting you want appears in the display.

! *If you are changing the TX MODE DEFAULT settings, the new settings appear on the lights above the Yes ◀ and the No ▶ keys*

- Press the Yes ◀ key to confirm your selection. The name of the next function setting appears in the display.
- Press the Select Function key to finish.

Dial Parameter Settings

These functions allow you to control the way your fax machine dials telephone numbers. Refer to the Dial Parameter Settings List below to determine which settings you may need to change, then refer to “Changing Your Dial Parameter Settings” part of this section to make the change.

Dial Parameter Settings List

1 REDIAL TRIES

This function controls how many times your fax machine automatically redials a number that is busy or does not answer.

Available settings are from 0 to 10 tries.

Default: 3 tries.

2 REDIAL INTERVAL

This function controls how long your fax machine waits between each automatic redial attempt.

Available settings are from 1 to 6 minutes.

Default: 3 minutes.

3 DIAL TONE DETECT

This function allows your fax machine to wait for and detect a dial tone before proceeding with dialing.

Available settings are ON and OFF.

Default: OFF.

4 BUSY TONE DETECT

This function allows your fax machine to detect a busy tone when sending a fax.

Available settings are ON and OFF.

Default: ON.

5 MF(TONE)/DP (PULSE)

This function sets the dialing method. Use the MF setting for Touch-Tone dialing, or the DP setting for pulse dialing. Default: MF (TONE).

6 PBX LINE

Turn this function on if your fax machine is connected to a PBX (Private Branch Exchange—a phone system used to route internal calls). Once this function has been turned on and the access digit function has been programmed using the Dial Prefix parameter (below), your fax machine recognizes the access digit you use in your PBX to get an outside line. Refer to Dial Parameter 8, Dial Prefix function for more information.

Refer to the “Setting Basic Features, Connecting to a PBX” section of this handbook for instructions on changing this setting.

Available settings are ON and OFF.

Default: OFF.

7 AUTO START

When this function is turned on, your fax machine automatically dials as soon as you press a One Touch key or enter an Auto Dial code—you do not have to press Start.

Available settings are ON and OFF.

Default: ON.

8 DIAL PREFIX

If your fax machine is connected to a PBX, use this function to specify the access digit used to obtain an outside line from your PBX. You can enter a number with up to four digits. When this parameter is programmed, the fax machine recognizes the access digit when you enter a number and automatically pauses for an outside line before dialing the rest of the number.

Refer to the “Setting Basic Features, Connecting to a PBX” section of this handbook for instructions on changing this setting.

Available settings are ON and OFF.

Default: OFF.

Changing Your Dial Parameter Settings

- 1 Press the Select Function key.
- 2 Press the 9/User Program One Touch key.
- 3 On the numeric keypad, press 2. The display shows 2:DIAL PARAMETER.
- 4 Press the Yes ◀ key until the display shows the dial parameter you want to change.
- 5 Repeatedly press the No ▶ key until the setting you want appears in the display.
- 6 Press the Yes ◀ key to confirm your selection. The name of the next dial parameter setting appears in the display.
- 7 Press the Select Function key to finish.

Service Function Settings

In many cases, service function settings greatly change the way your fax machine operates. To change any of these settings, contact your Authorized OKIFAX Dealer.

Service Function Settings List

1 LONG DOC. SCAN

Normally fax machine does not scan documents longer than 14 inches (360 mm). When this function is on, your fax machine can scan and transmit documents of any length for up to one hour.

2 MDY/DMY

This function specifies how fax machine displays and prints the date: month/day/year or day/month/year.

3 TIME/DATE PRINT

This function specifies how the time and date are printed on the fax messages you transmit. Available settings are: do not print date and time, print date and time at the top of the first page only, and print date and time at the top of every page.

4 TSI PRINT

When this function is on, the phone number of the sending fax machine prints at the top of each page of the message.

5 NO TONER MEM.RX

When this function is on, your fax machine automatically receives messages in memory when it is low on toner.

Changing Your Service Function Settings

To change any of these settings, contact your Authorized OKIFAX Dealer.

Changing the Language

Your fax machine comes with two languages installed: English and one other language. The other language will be Spanish, French or Portuguese, depending on the type of unit you bought. These languages appear on the display and in reports. Follow the instructions below to switch languages.

- 1 Press the Select Function key.
- 2 Press the 9/User Program One Touch key.

The display shows

1:FUNC. PROGRAMMING.

- 3 Press the Yes ◀ key. The display shows

FUNCTION NO. []
ENTER 01-23.

- 4 Use the numeric keypad to enter 15. The display shows
USER LANGUAGE.

- 5 Press the No ▶ key to switch to the other installed language.
- 6 To accept the language change, press the Yes ◀ key.
- 7 Press the Select Function key to finish.

Answering Mode

Setting the Answering Mode

The answering mode determines how your fax machine handles incoming fax and voice calls. The standby display shows the current answering mode.

Changing the Answering Mode

- 1 Press the Auto Rec key. A description of your current selection displays.
- 2 Press the Auto Rec key again. Your fax machine switches to the next setting.
- 3 Continue pressing the Auto Rec key until the selection you want appears on the display. After a short pause, your fax machine returns to standby mode displaying the new setting.

Answering Mode Options

The answering mode you choose depends on how you use your fax machine and what telephone equipment is connected to it. Read through the mode descriptions below, then follow the instructions to change to the mode that best fits your needs.

Auto Receive Mode [FAX]

If your fax machine is connected to a telephone line reserved only for fax communications, use the Auto Receive mode. Your fax machine assumes all incoming calls are fax messages and automatically receives them.

Manual Receive Mode [TEL]

If you use the same line for both fax and telephone calls and the majority of your incoming calls are telephone calls, then the TEL answering mode is your best choice. Each time someone calls, your fax machine rings like a telephone—it does not automatically answer. You can answer from either an external handset or telephone connected to your fax machine. If you pick up the handset and hear fax tones, press the Start key to receive the fax. If you do not answer the phone and someone tries to send you a fax message, your machine will not accept it.

Telephone/Fax Automatic Switch Mode [T/F]

When incoming calls are a mixture of fax and telephone calls, your best choice is the Telephone/Fax mode. In this mode, your fax machine detects whether the incoming call is a fax or voice call. When the call is from another fax machine, your machine switches to fax mode and automatically receives the message. When the call is a voice call, your fax machine rings like a telephone. If you do not answer within 35 seconds, your fax machine switches back to fax mode to allow the calling party to send a fax manually.

Using Your Fax with an Answering Machine [TAD]

TAD is Telephone Answering Device / Fax Automatic Switch Mode.

Use this mode to connect an answering machine to your fax machine. Like Telephone/Fax mode, the Telephone Answering Device mode detects whether an incoming call is a fax or voice call. If it is a fax call, your fax machine receives the fax. If it is a voice call, your fax machine rings just as it does in Manual Receive mode. If no one answers the call, your answering machine activates, allowing the calling party to leave a message. If you set the Remote Receive User Function Number 17 (Refer to the “User Function” section of this handbook), the caller can send a fax at any time during or after the recorded message by using their keypad to enter the remote receive number you have programmed. This number activates fax reception. Add something like this to your answering machine message: “To send a fax now, press XX [the programmed number].”

Memory Reception Mode [MEM]

When set to this mode, your fax machine stores received faxes in memory and does not print them out immediately.

Fax Forwarding Mode [FWD]

When set to this mode, your fax machine receives all fax messages into memory, and then automatically resends them to the forwarding number you have programmed into the machine. Refer to the “Answering Mode, Fax Forwarding Mode [FWD]” section of this handbook for details on how to set the forwarding number. This mode is available only if a forwarding number has been programmed.

PC Mode [PC]

Use this mode if you have the Multifunction Printer Option (also known as the PC interface option) installed in your fax machine and want to store incoming faxes on your computer’s hard disk instead of printing immediately. If your computer is off or not functioning, your fax machine acts as a standalone fax machine and prints any incoming faxes.

Incoming Call Parameters

Ring Response: User Function 11

This function controls how long your fax machine waits before answering an incoming telephone call. The available settings are 1 RING (default), 5 SECONDS, 10 SECONDS, 15 SECONDS, or 20 SECONDS.

- ! *At the default 1-ring setting, your fax machine answers*
- *calls immediately, and you will not hear any ring. If you need to hear the ring, change to one of the other settings.*

Incoming Ring: User Function 16

This function controls the telephone ringing sound your fax machine makes when a call comes in. When set to off, it does not ring during incoming calls. The available settings are:

- ON (default): Only rings when set to Manual Receive [TEL] mode or when the RING RESPONSE function is set to 5, 10, or 20 seconds.
- OFF: Does not ring when a call comes in.
- DRC (distinctive ring cancel): Rings for each incoming call with the same tone, even if you have set function setting 12, DISTINCTIVE RING to on.

Distinctive Ring: User Function 12

Some telephone carriers offer a service called Distinctive Ring. Distinctive Ring lets you have different numbers on one line, each with its own distinctive ring. You can then use one number exclusively as a fax number without the expense of a second line. (Your local telephone carrier can provide you with more information about this service, which usually has an additional charge.) To use this function, refer to Setting Your Fax Machine's Ring Pattern below. Available settings are OFF (default) and ON.

- ! *You must have your local telephone carrier's Distinctive*
- *Ring service. Your fax machine must be in FAX or PC answer mode, and the PBX dial parameter must be set to OFF. Other modes—TEL, TEL/FAX, or TAD—will override Distinctive Ring. This feature may not work properly if you have a telephone other than a genuine Oki optional handset connected to your fax machine.*

Setting Distinctive Ring

To set up your fax machine to recognize another ring pattern:

1 Press the Select Function key.

2 Press the 9/User Program One Touch key.

The display shows

1:FUNC. PROGRAMMING.

3 Press the Yes ◀ key. The display shows

FUNCTION NO. [].

4 Using the numeric keypad, enter 12. The display shows

DISTINCTIVE RING, OFF.

5 Press the No ▶ key two times. The display changes to

DISTINCTIVE RING, SET.

6 Press the Yes ◀ key. The display changes to

SETUP FAX RING
CALL FAX NUMBER NOW

7 Using a separate telephone line, dial the number assigned to the fax machine within 90 seconds.

If you don't have access to a second line, have someone else make the call for you. When your fax machine begins to ring, it automatically detects and remembers its assigned ring pattern. Be sure to let it ring until either **RESULT=OK** or **RESULT=NG** displays. When the fax machine has successfully finished programming its ring pattern, the display shows **RESULT=OK**.

! *Occasionally, your fax machine may not be able to detect its ring pattern on the first try. If this happens, the display shows **RESULT=NG**. Follow the instructions again from Step 6.*

8 Press the Yes ◀ key to confirm your selection.

9 Press the Select Function key to finish.

Remote Receive: User Function 17

This function lets you use an attached phone to tell your fax machine to switch from telephone to fax mode so it can receive an incoming fax. Use the keypad of an external telephone to enter the remote receive number you have programmed into your fax machine.

In addition, if your fax machine is in TAD mode, a caller can enter the programmed remote receive number after leaving a voice message. This enables the fax machine to receive a fax from the caller. Refer to the “Answering Mode, Using Your Fax with an Answering Machine [TAD]” section of this handbook.

Available settings are OFF (default), 00, 11, 22, 33, 44, 55, 66, 77, 88, 99, **, and ##.

PC/Fax Switch (MFP Option): User Function 22

This function is active only when the Multifunction Printer Option is installed and your fax machine is set to the PC Fax answering mode. In that case, incoming faxes are saved directly to the PC's disk without being printed. If the PC is turned off or not functioning, the fax machine acts as a stand-alone fax machine and prints incoming faxes when this PC/FAX SWITCH function is set to ON (default). If this function is set to OFF, the fax machine will not accept incoming faxes when the PC is turned off or not functioning.

Monitor Volume: User Function 06

This function sets the volume for telephone line monitoring during dialing. Available settings are LOW (default), HIGH, and OFF.

Buzzer Volume: User Function 07

This function sets the volume of the various tones your fax machine emits during operation. Available settings are LOW, MIDDLE (default), and HIGH.

Paper Size Settings

First Paper Size: User Function 13

This function allows you to specify the size of paper you are using in the paper tray. Available settings are letter (default), A4, legal 13, legal 14, and OTHER.

Using the OTHER setting, with MFP Option Installed

The MFP Option must be installed to work with the OTHER setting.

When using the fax machine as a PC printer, you can load A5 and B5 size paper into the paper tray. However, reports and standard size faxes (letter, legal, or A4) will not print completely on these paper sizes. Select the OTHER setting when you have these or other smaller sizes loaded; this prevents faxes and reports from printing partially. When OTHER is selected, faxes are stored in the fax machine and only print when you have loaded a standard paper size and changed the 1ST PAPER SIZE setting to match the paper loaded.

- ! *Important: If you use the OTHER setting, be sure to reset your fax machine to a standard paper size as soon as you are finished. Otherwise, you cannot receive faxes. Keep in mind that when you select OTHER, power outage reports do not print—this is the only notification that power to the fax machine has been disrupted.*

Second Paper Size: User Function 14

This function allows you to specify the size of the paper you are using in the optional second paper tray, and only appears if that option is installed. Refer to User Function Setting 13 for details.

Connecting to a PBX

A PBX (Private Branch Exchange) is a private telephone system used to route internal calls. If you have to dial a prefix (access digit) to get an outside line, then your line is connected to a PBX.

If you are connecting your fax machine to a PBX, follow the instructions below. It can then detect the access digit at the

beginning of phone numbers you dial or program, and automatically waits for a dial tone before dialing the rest of the number.

! *Some PBX installations may require additional adjustments to your fax machine. If you continue to have difficulty with fax communication after following these steps, contact your Authorized OKIFAX Dealer.*

- 1 Press the Select Function key.
- 2 Press the 9/User Program One Touch key.
- 3 On the numeric keypad, press 2. The display shows 2:DIAL PARAMETER.
- 4 Press the Yes ◀ key until the display shows PBX LINE, [OFF].
- 5 Press the No ▶ key. The display changes to PBX LINE, [ON].
- 6 Press the Yes ◀ key until the display shows DIAL PREFIX, [OFF].
- 7 Press the No ▶ key. The display changes to DIAL PREFIX, [] ENTER 4DIGITS.
- 8 Using the numeric keypad, enter the number you normally

dial from your PBX to obtain an outside line. An example of this is dialing 9 before the number, such as 9-555-1212.

- 9 Press the 14/Space One Touch key repeatedly until the display changes.
 - 10 Press the Yes ◀ key.
 - 11 Press the Select Function key to finish. Keep in mind that all of the outside telephone numbers you program into your fax machine have to begin with your PBX's access digit.
- ! *To turn off the PBX LINE and DIAL PREFIX functions, follow Steps 1-7 above. At Step 8, press the Space key four times. Then skip to Step 10.*

Basic Faxing Operations

This section explains how to load documents for faxing, how to send and receive faxes, how to use the closed network and voice request features, and how your fax machine handles power interruptions.

Preparing Documents for Faxing

Use the information in this section to make sure your documents scan and fax easily and clearly.

Guidelines

- Try to use good quality documents for your fax transmissions. Documents that are typed or written with a black felt-tip pen on white (or light) paper work best.
- Do not send documents that are not rectangular.
- Never use documents that have wet or sticky surfaces, wrinkles, staples, or paper clips. However, your fax

machine can transmit documents that have been subject to normal wear, such as documents with staple holes, letter folds and minor corner folds.

- If you are not sure how a document will fax, try making a copy first: load the document face down and press the Copy key.
- If your documents are heavily bent, creased or torn, make a copy on a photocopier and send the copy instead.

Document Size

- All documents must have a minimum width of 5.8" (148 mm) and a minimum length of 5" (128 mm).
- Documents cannot be wider than 8.5" (216 mm) or longer than 14" (356 mm).

- ! *Your fax machine can be set to accept documents of unlimited length—see your Authorized OKIFAX Dealer.*

Multiple Page Documents

Your fax machine can scan paper with a basis weight between 13 pounds (50 g/m²) and 28 pounds (105 g/m²). You can load up to 30 sheets of standard 20-pound (80 g/m²) paper, such as photocopier paper. If you use lighter or heavier paper, you can load up to 15 sheets. For very heavy paper, load and send pages individually.

- For multiple-page documents, do not load paper thinner than 0.003" (0.08 mm) or thicker than 0.005" (0.13 mm).
- For single-page documents, do not load paper thinner than 0.002" (0.06 mm) or thicker than 0.006" (0.15 mm).

Loading Documents

To prevent paper jams and problems during operation, stack your documents neatly, aligning their edges, before loading. Do not load documents of different sizes at the same time.

- ! **Tip:** You can load and prepare to transmit a document while your fax machine is still sending or receiving another message, as long as the document feeder is clear. To do this, load the document, select your location and press the Start key. Your document will be sent as a priority when the current communication ends.

- 1 Adjust the document guides to the width of the paper you are using.

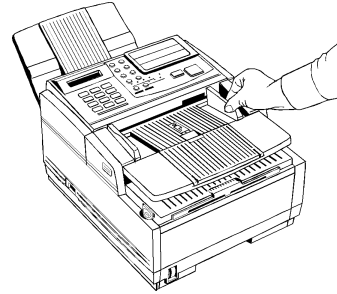

- 2 Stack your documents neatly, then insert them face down into the document feeder. Readjust the document guides for a snug fit.

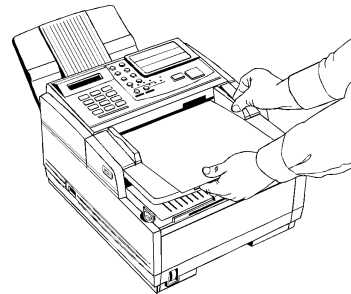

- 3 Your fax machine will grip the documents and pull the bottom page into the machine.
- 4 To obtain the best possible quality for the type of document you are scanning or faxing, use the Yes ◀ key to set the resolution of your document. For most normal documents, the default STD setting works well.

For normal office documents, use STD (Standard) resolution, which scans at 200 x 100 dpi

For documents with small type or other fine details, use

- FINE resolution, which scans at 200 x 200 dpi or
- EX. FINE resolution, which scans at 200 x 400 dpi

For documents with photos or many shades of gray, use PHOTO resolution, which scans at 200 x 200 dpi

- 5 If necessary, use the No ▶ key to adjust the level of contrast in your document.

For most documents, the default NORMAL setting works best.

- For documents with normal contrast, use NORMAL contrast.
- For documents that are too light, use LIGHT contrast.
- For documents that are too dark, use DARK contrast.

- 6 Your documents are now ready for faxing or copying.

Sending a Fax to a Single Location

- 1 Load your documents.
- 2 Select a location. Refer to the instructions below.

To dial using a One Touch key

Press the One Touch key. To reach One Touch keys 16–30, lift the main One Touch key pad.

To dial using an Auto Dial number

Press the Auto Dial key, then enter the two-digit Auto Dial number on the numeric keypad.

To dial using the numeric keypad

Dial as you would on a normal telephone.

If you make a mistake, press the Yes ◀ key to go back and re-enter the number.

Press the Start key when you have finished entering numbers.

To dial using an external telephone

Pick up the handset of your external telephone and dial the number of the machine you wish to transmit to. If the receiving fax machine is in automatic reception mode, you will hear a high-pitched tone. If a person answers the phone, ask them to press the Start key on their machine.

3 If necessary, press the Start key to begin the transmission.

Below are explanations for some of the messages you may see during a typical fax transmission.

- ! ***By default, One Touch keys and Auto Dial numbers begin transmission automatically, without pressing the Start key. The Auto Start setting lets you change this. Refer to the “Dial Parameters Settings” section of this handbook.***

(location)

The remote location's Personal ID, TSI/CSI, Location ID or the telephone number you entered identifies the location during transmission.

DIALING

Your fax machine is dialing the number.

CALLING

The line is ringing.

SENDING/XX.X

Your fax machine is sending the message. XX.X indicates the transmission speed in bits per second.

RESULT = OK

The fax was sent successfully.

COMMUN. ERROR

If the red alarm indicator lights and you see this or another error message, a problem occurred during the communication. Try resending the fax. Refer to the “Problem Solving” section of this handbook for assistance.

Search Key Dialing

If you are not sure which One Touch key or Auto Dial number contains the location you want to call, use the Search key to look through an alphabetical list of all of the Location IDs programmed into your fax machine.

- 1 When selecting locations, press the Search key. The display shows

ENTER 1'ST CHAR.

- 2 Repeatedly press the Search key to look through the entire list of locations in alphabetical order, or locate the letter you want on the numeric keypad, and press that key repeatedly to look through Location IDs beginning with that letter.

Real-Time Dialing

Normally, your fax machine dials the entire number of the location you have selected at one time. Occasionally, you may need to dial numbers in real time—one digit at a time.

If your fax machine is equipped with a handset, you can dial in real time by picking up the handset, or you can press the Hook/Voice Request key.

Redialing

If the line is busy or if there is no answer, your fax machine waits, and then automatically redials the number. The dial parameter settings determine how many times it redials and how long it waits between attempts. Refer to the “Dial Parameters Settings” section of this handbook.

If your fax machine is transmitting from memory and a communication error occurs, it automatically redials the number and tries to resend the fax.

You can redial a number manually at any time by pressing the Redial key.

- ! *If a power loss occurs, the redial information is lost.*
- *Refer to the “Basic Faxing Operations, Power Failures and Memory” section of this handbook.*

Confirming Results

After transmission, press the Copy key once (with no documents loaded) to see the result of your transmission (Message Confirmation [MCF]) on the display. To print the MCF report, press the Copy key a second time. Refer to the “Reports” section of this handbook.

Stopping a Transmission

To stop a transmission in progress, follow the instructions below.

- 1 Press the Stop key twice. The display shows **STOPPED**.
- 2 If documents are stuck partway through the document feeder, you may see a **RELOAD DOCUMENT** message on the display. Press the Stop key again. Your fax machine feeds the document the rest of the way through the document feeder.

Shortcut Fax Number Programming

This convenient feature lets you program a number into your fax machine for future use while you're sending a fax to it. It even finds the first available One Touch key (or Auto Dial number, if all the One Touch keys are programmed) for you to program.

Use the following procedure:

- 1 Load the document.
- 2 Enter the fax number using the numerical keypad.

- 3 Press the Copy key. The display shows **ONE TOUCH NO.[xx]**.
The number in brackets [xx] is the next unprogrammed One Touch key number.
If all the One Touch keys are programmed, the display shows **AUTO DIAL NO.[xx]**, with the number of the next unprogrammed Auto Dial number shown in brackets [xx].
- 4 Press Yes ◀ to program the location to the number shown or
press Search to cycle through the available unprogrammed keys/numbers,
then press Yes ◀ to program to the number you want.
Press No ▶ to stop the process.
- 5 The display reads
NO=5551212 [the fax number you entered] ID=.

Press Start, then enter the location ID. This is a descriptive title up to 15 characters long. Refer to the instructions below.

- To enter numbers, use the numeric keypad (press once)
- To enter spaces, use the Space One Touch key
- To enter hyphens (-), use the Hyphen key
- To enter alphabetical characters, locate the character you want on the numeric keypad.
- Press that key repeatedly until the character appears on the display.
- To enter a unique character, press the 0/Unique key repeatedly until the character you want appears.
The following characters are available: ! # & ' () * + , - . / : ; = ? · ã ß ñ ö ü Æ Å Ø æ å ø.
- To enter two successive letters/numbers on the same key, press the No ► key to move to the next character. Move the cursor to make corrections, press the Yes ◀ and No ► keys

6 Press Start. The display shows

NO=<LOCATION>.

7 Press Start. The display shows **PROGRAMMING**, then **DIALING**, and the fax machine dials the number and sends the fax.

Receiving Faxes

Receiving Faxes Manually

If your fax machine is set to the manual receive [TEL] mode, it treats all incoming calls as voice conversations, and does not automatically receive faxes.

- ! ***You must have a handset connected to the fax machine in order to receive faxes manually.***

To receive a fax while in manual receive mode:

- 1 When your telephone or fax machine rings, pick up the telephone handset connected to it. If a person is on the line, carry on your conversation.

- 2 If a remote fax machine is on the line, or if a person wishes to fax you a document after a conversation, press the Start key.
- 3 When the **RECEIVING** message appears on the display, hang up the handset.
- 4 After you receive the fax, a long beep tells you that the transmission was successful.

Receiving Faxes in Memory

- ! *This section does not apply when the fax machine is in PC Fax mode. In that case, all faxes are automatically stored on the computer's hard drive, regardless of the conditions explained below.*

Memory Reception Mode [MEM]

When your fax machine is set to Memory Reception mode, it receives all messages into its memory without printing them out. The display shows

MSG. IN MEMORY

To print messages stored in the machine's memory, switch to Auto Receive mode.

Press the Auto Rec. key repeatedly until the display shows

AUTO RECEIVE MODE

The display shows (for a few seconds)

PROGRAMMING

The messages stored in the machine's memory print.

No Paper Reception

When your fax machine runs out of paper, incoming faxes are stored in the machine's memory.

The display shows:

MSG. IN MEMORY, REPLACE PAPER

Load more paper.

Your fax machine automatically prints out any messages in memory as soon as paper is loaded.

Canceling Messages Stored in Memory

It is possible to erase messages received in memory without printing them.

- 1 After you have followed the instructions to print out messages stored in memory, the display shows

MSG. IN MEMORY, PRINTING.

- 2 To erase the message instead of printing it, press the Stop key. The display shows

CANCEL?

- 3 Press the Yes ◀ key to erase the message from your fax machine's memory.

If there are more messages in memory, the display shows

MSG. IN MEMORY, PRINTING

Follow the steps above for each message you want to erase.

- ! **WARNING:** *You cannot identify which message you are erasing.*

Rejecting Unsolicited (Junk) Fax Messages (Closed Network Option)

The closed network option lets you set your fax machine to only transmit faxes to or receive faxes from locations programmed into One Touch keys or Auto Dial numbers. You can also set it to receive faxes only from those programmed locations. This is one way of reducing the number of unsolicited faxes, such as advertisements you receive. To use the closed network function, follow the instructions below.

- 1 Press the Select Function key.
- 2 Press the 9/User Program One Touch key. The display shows

1:FUNC. PROGRAMMING.

- 3 Press the Yes ◀ key. The display shows

FUNCTION NO. [].

4 Using the numeric keypad, enter 08. The display shows

08:CLOSED NETWORK nnn

Where nnn is the current setting of this function.

The settings are: RX, T/R, or OFF

5 Press the No ► key until the setting you want appears in the display.

RX: limits reception only.

T/R: limits both transmission and reception.

OFF: no limits on transmission or reception.

6 Press the Yes ◀ key to confirm the new setting.

7 Press the Select Function key to finish.

Power Failures and Memory

If power to your fax machine is interrupted, the problems listed below will occur.

! *You can prevent these problems by installing an optional memory expansion board with a battery back-up system that protects stored information for at least one hour.*

- Any messages your fax machine has scanned into its memory but not yet transmitted will be lost. This includes messages stored for bulletin polling.
- Any messages your fax machine has received into its memory but not yet printed will be lost.
- If you have loaded documents on your fax machine's document feeder, any dialing or transmission settings will be lost.
- Redial information is lost.

When power is restored, your fax machine prints a power outage report to inform you of the power failure. Use this report to determine which received messages you may have lost, and to determine which transmissions you may have to resend. Refer to the "Reports" section of this handbook for more information.

Using Voice Request

The voice request feature allows you to have a conversation with a person at a remote fax machine after a fax communication is finished. Either the person sending or receiving the fax can initiate a voice request.

If you are sending a fax, you can answer a voice request only after all pages have been transmitted. If you are receiving a fax, you can answer a voice request after reception of each page.

You will know if the person on the other fax machine has issued a voice request when you hear a warbling tone. If you do not respond in approximately six seconds, the voice request is automatically cancelled.

- ! ***You need to have either the optional handset or an external telephone attached to the fax machine in order to use the voice request function.***

You can use the voice request function only when you are using the document feeder to send a fax directly to a single location. You cannot use it with memory, delayed, relay, or broadcast faxing.

You cannot use the voice request function when your are operating the fax unit at transmission speeds greater than 14,400 bits per second.

Initiating a Voice Request

- 1 During a fax communication, press the Hook V Request key.
- 2 When the other party answers your request, your fax machine emits a repetitive warbling sound. The display shows

LIFT HANDSET, PRESS VOICE REQUEST.

- 3 Lift your handset and press the Voice Request key.

- ! ***If you press your Voice Request key to initiate a voice request in TX mode, but no one is there to answer, your fax machine automatically sends a call back message to the remote site. This message includes a telephone number where you can be reached.***

Answering a Voice Request

Lift the handset and press the Hook V Request key.

Programming Your Speed Dial Directory

Faxing is easier when you program frequently used fax numbers into the One Touch keys and use the Auto Dial numbers available in your fax machine. Your fax machine also allows you to organize the programmed numbers into groups for easier faxing to multiple locations.

The One Touch keys are your fax machine's most important tool. Use them for quick, one-touch dialing, and to access most functions and programming options.

One Touch Faxing

Programming One Touch Keys

The fax unit has 30 One Touch key locations available: keys 1–15 are on the main One Touch panel; keys 16–30 are beneath the main One Touch panel. You can store up to two fax numbers with 32 digits in each One Touch key: a main number and an optional alternate number which will be called if the main number is busy.

You can also enter a 16-character Location ID (name) for each One Touch key.

- ! *To find One Touch keys that are not yet programmed,*
- *repeatedly press the Search key.*

- 1 Press the Select Function key.

- 2 Press the 8/Location Program One Touch key. The display shows

LOCATION PROGRAMMING
ENTER (SRCH, OT, A/D, #).

Where

SRCH represents Search (press the Search key)

OT represents One Touch

A/D represents Auto Dial

represents Group

- 3 Press a One Touch key to program.

- ! *To program or use One Touch keys 16-30, grasp the One Touch keyboard latch and swing the main One Touch panel out of the way. You can then select from keys 16-30. When you are finished, close the One Touch keypad and continue.*

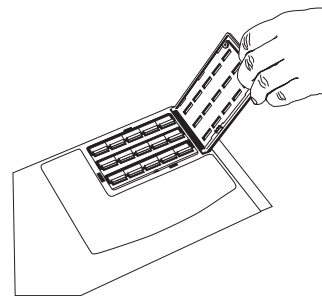

- 4 The display briefly shows

NO=<FAX NO.>,
ID=<LOCATION ID>

or a previously programmed fax number and Location ID.

- 5 After the display clears, enter the main fax number. Refer to the instructions below.
 - To enter numbers, use the numeric keypad (press once)
 - To enter spaces, press the 14/Space One Touch key
 - To enter hyphens (-), press the Hyphen key
 - To enter pauses (i.e., to wait for long distance or outside lines), press the 15/Pause One Touch key
 - To add a switch from pulse to tone dialing for part of the call, press the */Tone key
 - To move the cursor to make corrections, press the Yes ◀ and No ▶ keys
- 6 Press the Start key to enter the number.
- 7 Enter the Location ID. This is a descriptive title up to 16 characters long. Refer to the instructions below.
 - To enter numbers, use the numeric keypad (press once)
 - To enter spaces, press the 14/Space One Touch key
 - To enter hyphens (-), press the Hyphen key
 - To enter alphabet characters, locate the character you want on the numeric keypad. Press that key repeatedly until the character appears in the display.

- To enter a unique character, press the 0/Unique key repeatedly until the character you want appears in the display. The following characters are available: ! # & ' () * + , - . / : ; = ? · ä ß ñ ö ü Æ Å Ø æ å ø.
 - To enter two successive letters/numbers on the same key, press the No ▶ key to move to the next character.
 - To move the cursor to make corrections, press the Yes ◀ and No ▶ keys
- 8 Press the Start key. The display shows (for about three seconds).

NO=**<OR LOCATION>**

- 9 Enter the optional alternate fax number, if desired. Refer to the instructions following Step 5.
- 10 Press the Start key to finish programming the One Touch key.
The display shows

**LOCATION
PROGRAMMING.**

- 11 To continue programming One Touch keys, go back to Step 3. If you are finished programming, press the Select Function key.
- 12 Lift off the plastic cover above the One Touch label. Using a pencil, write in the location name for your One Touch key(s). Then replace the cover.

Using the One Touch Keys for Dialing

To use a One Touch key for dialing, just press the appropriate One Touch key. For each key, you can program up to two telephone numbers: a primary number, which will always be dialed first, and an optional alternate number which will be automatically dialed if the first number is busy or if there is no answer. You can also use the Search key to find locations programmed into One Touch keys.

- ! *The fax unit has keys 1–15 available on the main One Touch panel, and keys 16–30 available beneath the main One Touch panel. To access One Touch keys 16–30, lift the main One Touch keypad by the latch on the left side of the cover. When you're finished, close the keypad to continue normal operation and programming.*

Using the One Touch Keys for Selecting Functions and Programming

Use One Touch keys 1–10 for selecting special transmission and reception functions, for obtaining reports, and for quick access to programming functions.

To select a function:

- 1 Press the Select Function key.
- 2 Press the corresponding One Touch key.

List of One Touch Keys

1/Delayed TX key

Use this key to send a fax at a later time and date [which you specify (within three days)]. Refer to the “Advanced Operations, Sending a Fax at a Later Date and Time” section of this handbook.

2/Broadcast Feeder TX key

Use this key to send a fax to multiple locations or to switch from memory to the document feeder when preparing to send a fax. Refer to the “Sending a Fax to Multiple Locations (Broadcasting)” section of this handbook.

3/Confidential TX key

Use this key to send a confidential document to a mail box (a secure memory storage area) in the receiving fax machine. Refer to the “Advanced Operations, Confidential Faxes (Security Feature)” section of this handbook.

4/Relay Initiate TX key

Use this key to set up a relayed fax transmission. During a relayed fax transmission, your fax machine initiates the transmission by sending a document to a second fax machine, which then broadcasts the message to a number of other fax machines. Refer to the “Relay Faxing” section of this handbook.

5/Polling key

When a document is loaded on the document tray, use this key to set your fax machine to wait for another fax machine to call and request the document to be sent (polling transmission). When no document is loaded, use this key to call another fax machine and request it to send the documents loaded into it (polling reception). Refer to the “Advanced Operations, Polling” section of this handbook.

6/Report Print key

Use this key to print reports or phone lists manually. Refer to the “Reports” section of this handbook for details.

7/Counter Display key

Your fax machine keeps track of the number of pages it has printed and scanned. Use this key to check the print and scan counters. It can also be used to reset the drum counter after replacing the image drum unit. This feature is available only when the “CHANGE DRUM SOON” message displays.

8/Location Program key

Use this key to program One Touch keys, Auto Dial numbers and groups. Refer to the Programming Your Speed Dial Directory” section of this handbook.

9/User Program key

Use this key to program identification information, to set the clock, and to change function and dial parameter settings.

10/Message Print From Memory key

Your fax machine is set to receive messages into memory and not print them when it runs low on toner. Using this key, you can force messages to print, although print quality may be poor because toner is low. This key is also used to print confidential fax messages received into mailboxes in your fax machine's memory. Refer the "Advanced Operations, Confidential Faxes (Security Feature)" section of this handbook.

When no messages are in memory, use this key to print a cleaning page to clear accumulated toner from the image drum. Refer to the "Problem Solving, Printing a Cleaning Page" section of this handbook.

Chain Dialing

Each fax number you enter or program into your fax machine can be up to 32 digits long. There may be situations where you need to dial a number longer than that. Or you may want to program portions of a number separately. For example, you may frequently send to different extensions at the same company, or individuals may need to enter a department code after the phone number for accounting purposes. These are situations where the chain dialing feature is helpful.

Creating a Chain Dial Number

- 1 Program up to the first 31 digits of the number into a One Touch key or Auto Dial number.
- 2 Press the 8/Location Program One Touch key to make this a chain dial number.
- 3 Program the rest of the number into another One Touch key or Auto Dial number
or
you can leave the second part of the number unprogrammed and enter it manually on the numeric keypad.

Using a Chain Dial Number

- 1 Select the One Touch key or Auto Dial number programmed with the first part of the chain dial number.
- 2 The display will show

PRESS OT/AD/SRCH KEY.

- 3 Select the One Touch key or Auto Dial number programmed with the second part of the chain dial number. If the second part of the chain dial number was not programmed, enter it manually on the numeric keypad.
- 4 Press the Start key to begin sending the fax.

Auto Dial Faxing

Programming Auto Dial Numbers

For each Auto Dial number, you can enter a fax number up to 32 digits long and a Location ID (name) up to 15 characters long.

To program Auto Dial numbers:

- 1 Press the Select Function key.
- 2 Press the 8/Location Program One Touch key.
The display shows

LOCATION PROGRAMMING.

- 3 Press the Auto Dial key.
- 4 Using the numeric keypad, enter a 2-digit number for the Auto Dial number you want to program. Up to 99 Auto Dials numbers can be programmed.
- 5 The display briefly shows

NO=<FAX NO.>,
ID=<LOCATION ID>

or a previously programmed fax number and location.

- 6 After the display clears, enter the fax number. Refer to the instructions below.
 - To enter numbers, use the numeric keypad (press once)
 - To enter spaces, press the 14/Space One Touch key
 - To enter hyphens (-), press the Hyphen key
 - To enter pauses (i.e., to wait for long distance or outside lines), press the 15/Pause One Touch key
 - To add a switch from pulse to tone dialing for part of the call, press the */Tone key
 - To move the cursor to make corrections, press the Yes ◀ and No ▶ keys
- 7 Press the Start key to register the number.
- 8 Enter the Location ID. This is a descriptive title up to 16 characters long. Refer to the instructions below.
 - To enter numbers, use the numeric keypad (press once)
 - To enter spaces, press the 14/Space One Touch key
 - To enter hyphens (-), press the Hyphen key
 - To enter alphabet characters, locate the character you want on the numeric keypad. Press that key repeatedly until the character appears in the display.
 - To enter a unique character, press the 0/Unique key repeatedly until the character you want appears in the display. The following characters are available: ! # & ' () * + , - . / : ; = ? · ä ß ñ ö ü Æ Å Ø æ å ø.
 - To enter two successive letters/numbers on the same key, press the No ▶ key to move to the next character.
 - To move the cursor to make corrections, press the Yes ◀ and No ▶ keys
- 9 Press the Start key to finish programming the One Touch Key. The display shows

 AUTO DIAL NO. []
- 10 To continue programming Auto Dial numbers, go back to Step 4. If you are finished, press the Select Function key.

Copying

Quantity and Resolution

You can use your fax machine as a stand-alone copier to make up to 99 copies of a document at one time.

FINE is the default resolution for copies.

To change to a finer resolution, press the Yes ◀ key before you press the Copy key.

For normal office documents,

Use STD (Standard) resolution

The resolution of this scan is 100 x 200 dpi

For documents with small type or other fine details,

Use FINE or EX. FINE resolution

The resolution of a FINE scan is 200 x 200 dpi

The resolution of an EX.FINE scan is 200 x 400 dpi

For documents with photos, or many shades of gray,

Use PHOTO resolution

The resolution of a PHOTO scan is 200 x 200 dpi

Making Copies

To make copies:

- 1 Adjust the document guides to the width of the paper you are using.

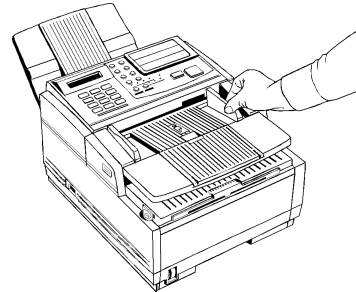

- 2 Neatly stack your documents, then insert them face down into the document feeder. Readjust the document guides for a snug fit. Your fax machine will grip the documents, and pull the bottom page into the machine.

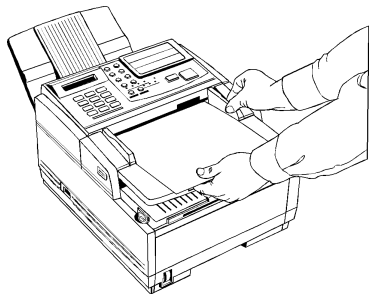

- 3 Press the Copy key. The display shows **PRG. NO. OF COPIES, [1SETS]**. If you want to make just one copy, you are finished. Your fax machine will pause briefly, then begin copying.
- 4 To make multiple copies, enter the number of copies you want to make on the numeric keypad. Then press the Copy key again. Your fax machine begins making copies.
- 5 To stop the copying process, press the Stop key.

Using the Manual Paper Feeder

Your fax machine's manual paper feeder allows you to make copies on a different type of paper than what you normally keep in the paper tray.

- ! *The paper you use in the manual feeder must be the same size as the paper in the paper tray—if it isn't, the paper will jam.*
- *If you do want to put a different size paper in the manual feeder, change the 1ST PAPER SIZE function setting to the size you want to use. Refer to the "Setting Basic Features, User Function Settings" section of this document. When you are finished, be sure to reset 1ST PAPER SIZE to match the paper in the tray.*

To make copies using the manual paper feeder, follow the instructions below.

- 1 Load your documents face down in the document feeder.

2 Press in on the lower half of your fax machine's front panel indents, just above the paper tray.

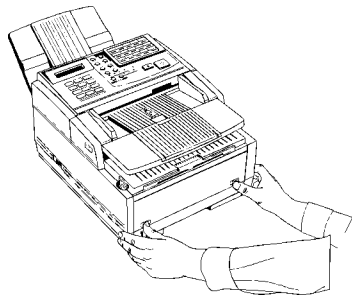

3 Pull the manual paper feeder down until it is horizontal.

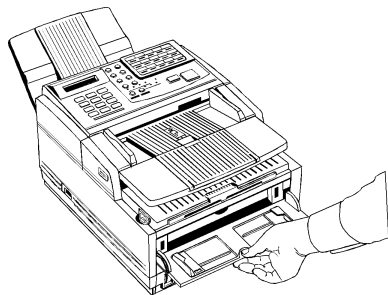

4 Adjust the paper guides on the feeder.

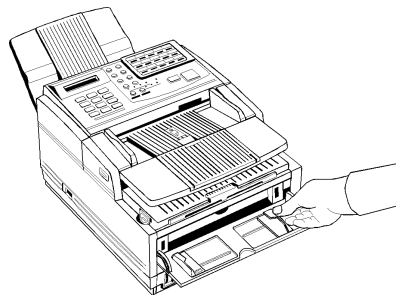

5 Insert a sheet of paper face up. Adjust the guides again to ensure that the paper is straight.

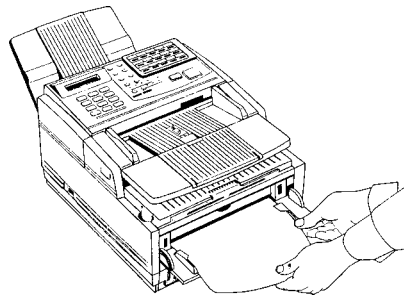

- 6 Press the Copy key (refer to the instructions above). If you are making more than one copy, or copying a multi-page document, insert additional sheets when the previous sheet is all the way through the machine.

Sending a Fax to Multiple Locations (Broadcasting)

The broadcasting feature allows you to send one document to as many as 139 locations at the same time. For each broadcast operation, you can select up to 30 single-location One Touch keys or One Touch keys programmed as groups, and up to 99 auto Dial Codes, as well as 10 manually entered numbers (Key Entries).

Performing a Broadcast Operation

- ! *These instructions assume that you have the default setting for User Function 18 (FEEDER) engaged. If you have the MEMORY setting engaged, skip step 4.*

- 1 Load your documents.
- 2 Press the Select Function key.
- 3 Press the 2/BROADCAST ↔ FEEDER TX One Touch key. The display shows FEEDER TX.
- 4 Press the No ► key.
- 5 Select a location. Refer to the instructions below.
 - To select using a One Touch key, press the One Touch key (to access One Touch keys 16–30, lift the main One Touch keypad).
 - To select using an Auto Dial number, press the Auto Dial key, then enter the two-digit Auto Dial number on the numeric keypad.
 - To select using a group, use the numeric keypad, press the # key, then enter the number of the group you want to use.
 - To select using a number dialed on the numeric keypad, dial as you would on a normal telephone.

- 6 Press the Yes ◀ key to confirm your selection.
- 7 Repeat Steps 4 and 5 as often as necessary to continue selecting locations.
- 8 When you are finished selecting locations, press the No ▶ key at the **SELECT LOCATION(S)** message.
- 9 If you have selected multiple locations, your fax machine asks if you want to confirm your selections with a printed report before proceeding. If you do, press the Yes ◀ key. After the report is printed, the display shows **BEGIN SCANNING?** If you want to make corrections, press the No ▶ key and go back to Step 4. To remove a location, select the location in the same way, but press the No ▶ key to delete it from your transmission.
- 10 When all of your selections are correct, press the Start key. Your fax machine scans the documents into memory and begins transmitting the message.

Sending A Fax to a Group

What is a Group?

A group is a collection of programmed locations. Once you have programmed some One Touch keys or Auto dial numbers, you can use these programmed locations to create groups. Using groups, you can easily send the same fax to multiple locations. You can program up to 20 groups, each having up to 129 numbers.

What is an example of a group? Let's imagine that you work with a team of several co-workers. Each co-worker is at a unique geographic location. You have programmed each co-worker's fax number as a One-Touch key. Your group would be the collection of all of the co-workers' fax numbers.

When would you use a group? Let's imagine that you must send a weekly status report to all of your co-workers on the team. Using the group feature allows you to send the one report to all of the co-workers' locations.

- ! ***Faxing to a group is different from relay broadcasting.***
- ***In relay broadcasting, one fax is sent to a remote machine. The remote machine then relays the fax to a group of fax numbers.***

Programming Groups

- 1 Press the Select Function key.
- 2 Press the 8/Location Program One Touch key. The display shows **LOCATION PROGRAMMING**.
- 3 On the numeric keypad, press the # key. The display shows **GROUP SETTING**.
- 4 Using the numeric keypad, enter the two-digit group number (01 to 20) you want to program.
- 5 The display shows

[the number of your current group]
SELECT LOC.(S)

- 6 You can now add a location to your group (or delete a location from it).
You can also search for a location. Refer to the instructions below.

Search

Refer to Steps 1 through 6, above.

To search for a location by name, keep pressing the Search key until the location you want appears.

- Press Yes ◀ to add it to the group.
- Press No ▶ to delete it from the group.

Add

Refer to Steps 1 through 6, above.

To add a One Touch location:

- 1 Press the One Touch key.
- 2 Press Yes ◀ to add it to the group.

To add an Auto Dial location:

- 1 Press Auto Dial.
- 2 Enter the 2-digit Auto Dial number.
- 3 Press Yes ◀ to add it to the group.

Delete

Refer to Steps 1 through 6, above.

To delete a previously added One Touch location,

- Press the One Touch key.
- Press No ► to delete it from the group.

To delete a previously added Auto Dial location,

- Press the Auto Dial key.
- Enter the 2-digit location Auto Dial number.
- Press No ► to delete it from the group.

- 7 After you have completed your selection by pressing Yes ◀ or No ►, the display shows

SELECT LOC.

Continue to add or delete locations from your group.

- 8 When you are finished programming your group, press the No ► key.
The display shows

LOCATION PROGRAMMING.

- 9 To program another group, go back to Step 3. If you are finished, press the Select Function key.

Sending to a Group

- ! *These instructions assume that you have the default setting for User Function 18 (FEEDER) engaged. If you have the MEMORY setting engaged, skip step 4.*

- 1 Load your document(s).
- 2 Press the Select Function key.
- 3 Press the 2/BROADCAST ↔ FEEDER TX One Touch key.
The display shows FEEDER TX.
- 4 Press No ►.
- 5 Press the # key, then the two-digit number (01-20) for the group.
- 6 Press No ► twice.
- 7 Press the Start key.

The fax unit scans the document(s) into memory and begins transmitting the message.

Relay Faxing

What is Relay Faxing?

Relay faxing allows one fax machine to send a document to another fax machine, which then re-sends the document to a number of other locations. Two different fax machines are involved in transmitting a relay fax: the relay initiating station and the relay key station (hub).

What is an example of Relay Faxing? Imagine that you need to send a fax to a number of locations in another area code. With Relay Faxing, you (the relay initiating station) send one fax (transmission) long distance to one fax (the relay key station). The relay key station then sends the fax to all of the other faxes/locations in the area code, at local rates.

- ! *Relay Faxing is different from group faxing. In Group Faxing, a fax is sent to a preprogrammed group of locations directly from the fax machine. At this writing, the OKIFAX 2600 is the only Oki fax machine that can function as a relay key station.*

Relay Initiating Station

Your fax machine can act as the relay initiating station, which starts the relay broadcast by sending the original documents.

Before you can program your fax machine to initiate a relay broadcast, you will need to obtain the following information from the operator of the unit you intend to use as a relay key station:

Relay Password

This is the 4-digit relay key word that is programmed into the relay key station.

Relay Group Numbers

These 2-digit numbers are the numbers of groups of locations programmed into the relay key station.

Relay Key Station

The relay key station is the fax unit that receives the original fax message and then automatically relays or broadcasts the message to other remote fax machines.

For this feature to be available, the relay key station must be an OKIFAX 2600.

Relay Broadcast Report

After the relay broadcast is completed, it is possible for the relay key station to send a fax back to your fax machine confirming the success of the relay broadcast. For this function to work, your fax machine's own telephone number must be programmed into Auto Dial number 99.

- ! ***Be sure to program the number in the format the relay***
- ***key station uses for dialing. For example, be sure to include the access digit, if required.***

Initiating a Relay Broadcast

- 1 Load your documents.
- 2 Press the Select Function key.
- 3 Press the 4/Relay Initiate TX One Touch key.
 - a. The first time you use this feature, the display shows:

RELAY PASSWORD
ENTER []

Using the numeric keypad, enter the 4-digit relay password.

- b. If you have already used this feature, the display shows:

RELAY PASSWORD [XXXX]

where XXXX is the last password you used.

If the password is correct, go to step 4.

If you want to use a different password, press the No ► key. Then use the numeric keypad to enter the password for the relay key station you want to use.

- 4 Press the Yes ◀ key.
 - a. The first time you use this feature, the display reads:

REMOTE LIST NO. []
ENTER 01-99

Using the numerical keypad, enter the 2-digit relay group number for the group you want to fax to.

- b. If you have already used this feature, the display shows:

REMOTE LIST NO. [XX]

where XX is the last list number you entered.

If the list number is correct, go to step 5.

If you want to fax to a different list, press the No © key.

Then use the numeric keypad to enter the number of the list you want to use.

5 Press the Yes ◀ key. The display shows

SELECT LOCATION.

6 Select the location of the relay key station.

Refer to the instructions below.

To select a One Touch key, press the One Touch key (lift the main One Touch keypad to access One Touch keys 16–30).

To select an Auto Dial number, press the Auto Dial key, then enter the two-digit Auto Dial number on the numeric keypad.

To select a number dialed on the numeric keypad, dial as you would on a normal telephone.

7 Press the Start key. Your fax machine begins to connect to the relay key station and transmit the fax to be relayed to the selected group.

Advanced Operations

Sending a Fax at a Later Date and Time

You can program your fax machine up to three days in advance to send documents at a specified date and time.

You can send one delayed fax at a time either from the document feeder or from memory. Refer to the information below to decide which method you want to use.

Features and Limitations

Sending a Delayed Fax from the Document Feeder

- You can send the fax to one location.
- You may have one delayed fax loaded into your fax machine.
- The fax machine cannot be used for other transmissions while a delayed fax is waiting to be sent.
- To change the default setting, you must adjust the settings for User Function 18, Mem./Feeder SW. Refer to the “Setting Basic Functions, User Function Settings” of this handbook.

Sending a Delayed Fax from Memory

! *This is the fax unit's default.*

- You can send the fax to multiple locations.
- You may have twenty delayed faxes loaded into your fax machine.
- The fax machine can be used for other transmissions while a delayed fax is waiting to be sent.
- To change the default setting, you must adjust the settings for User Function 18, Mem./Feeder SW. Refer to the “Setting Basic Functions, User Function Settings” section of this handbook.

Sending a Delayed Fax from the Document Feeder

- 1 Load your documents.
- 2 Press the Select Function key.
- 3 Press the 1/Delayed TX One Touch key. The display shows

DELAYED TX
[today's date]

- 4 If the transmission is to occur on the same day, skip to step 6. Otherwise, press the No ► key. The display shows

PRG. START DATE 0-9.

- 5 Using the numeric keypad, enter the date you wish the transmission to begin. Your entry may be up to three days in advance.
- 6 Press the Yes ◀ key. The display shows

PRG. START TIME 0-9.

- 7 Using the numeric keypad, enter the time you wish the transmission to begin, in 24-hour format. Examples: 8:00 am is 08:00; 8:00 pm is 20:00.
- 8 Press the Yes ◀ key. The display shows

BROADCAST/MEMORY TX (OKIFAX 5400).

- 9 Press the No ► key.
The display shows

FEEDER TX.

Press the Yes ◀ key.

- 10 Select a location. Refer to the following instructions.
- To select a One Touch key, press the One Touch key (lift the main One Touch keypad to access One Touch keys 16–30).
 - To select an Auto Dial number, press the Auto Dial key, then enter the two-digit Auto Dial number on the numeric keypad.
 - To select a number dialed on the numeric keypad, dial as you would on a normal telephone.
- 11 Press the Start key. Your fax machine begins waiting for the time and date you have set before feeding the document and sending the fax.

Sending a Delayed Fax from Memory

- 1 Load your documents.
- 2 Press the Select Function key.
- 3 Press the 1/Delayed TX One Touch key. The display shows

DELAYED TX
[today's date]

- 4 If the transmission is to occur on the same day, skip to step 6. Otherwise, press the No ► key. The display shows

PRG. START DATE 0-9.

- 5 Using the numeric keypad, enter the date you wish the transmission to begin. Your entry may be up to three days in advance.
- 6 Press the Yes ◀ key. The display shows

PRG. START TIME 0-9.

- 7 Using the numeric keypad, enter the time you wish the transmission to begin, in 24-hour format. Examples: 8:00 am is 08:00; 8:00 pm is 20:00.

8 Press the Yes ◀ key. The display shows

BROADCAST/MEMORY TX

9 Press the Yes ◀ key.

The display shows

BROADCAST/MEMORY TX.

Press the Yes ◀ key.

10 Select a location. Refer to the instructions below.

- To select a One Touch key, press the One Touch key (lift the main One Touch keypad to access One Touch keys 16–30).
- To select an Auto Dial number, press the Auto Dial key, then enter the two-digit Auto Dial number on the numeric keypad.
- To select a number dialed on the numeric keypad, dial as you would on a normal telephone.
- To select a group, use the numeric keypad and press the # key. Then, enter the number of the group you want to use.

11 Press the Yes ◀ key to confirm your selection. The display shows

SELECT LOCATION(S).

12 To continue selecting locations, repeat Steps 11 and 12 as often as necessary.

13 When you are finished selecting locations, press the No ▶ key [when the **SELECT LOCATION(S)** message is displayed].

14 If you have selected multiple locations, the unit will ask you if you want to confirm your selections with a printed report before proceeding.

- If you do, press the Yes ◀ key. After the report is printed, the display shows **BEGIN SCANNING?**
- If you want to make corrections, press the No ▶ key and go back to Step 9.
- To remove a location, select the location in the same way, but press the No ▶ key to delete it from your transmission.

- 15 When all of your selections are correct, press the Start key. The fax machine scans the documents into memory and waits until the time and date you have set before sending the fax. When scanning is completed, the unit is available for other transmission operations.

Canceling a Delayed Transmission

- 1 Press the Stop key. The display shows

COMMUNICATION CANCEL.

- 2 Press the Yes ◀ key. The display shows the Location ID of the delayed transmission currently loaded in the fax machine.
- 3 Press the Yes ◀ key.
- 4 If the delayed transmission was a feeder transmission, press the Stop key again to remove the document from the document feeder.

Confidential Faxes (Security Feature)

Fax machines are often placed in public places where everyone can look through the received faxes. If you are communicating with another Oki fax-capable unit, you can use the confidential fax feature. The receiving machine will store the message in a personal (confidential) mailbox (in its memory) and will not print it until a password is entered. This is an exclusive Okidata feature; you cannot use it with another manufacturer's fax machines.

- ! *To send a confidential fax, you must know in advance the mailbox the message should be sent to. Ask the person who will receive the fax to tell you their mailbox number.*

Creating a Personal (Confidential) Mailbox

The OKIFAX 5400 has 16 personal (confidential) mailboxes.

- 1 Press the Select Function key.
- 2 Press the 9/User Program One Touch key. The display shows

1: FUNC. PROGRAMMING.

- 3 Press 5 on the numeric keypad. The display shows
5:PERSONAL BOX PRG.
- 4 Press the Yes ◀ key. The display shows
PERSONAL BOX NO. [].
- 5 Using the numeric keypad, enter the number of the mailbox (01–16) you want to use. The mailbox must be entered as a 2-digit number, e.g., 01.
- 6 The display asks you to confirm the box number. Press the Yes ◀ key if the number is correct.
- 7 The display shows

PERSONAL BOX [CLOSE].

Press the No ▶ key until CONF appears in the brackets.

- ! *If [CONF] or [POLL] appears, then the box number is already in use as a confidential or bulletin poll mailbox.*

- 8 Press the Yes ◀ key to continue.
- 9 Using the numeric keypad, enter the 4-digit password you want to use with your mailbox.
- 10 Press the Yes ◀ key to confirm your entry.
- 11 The fax machine then asks you to enter another mailbox number. To continue programming mailboxes, go back to step 5. When you are finished, press the Select Function key.

Changing Your Password

If you want to change the password of an existing mailbox, follow the instructions below.

- ! *A mailbox must be empty before you can modify or delete it.*

- 1 Press the Select Function key.
- 2 Press the 9/User Program One Touch key. The display shows

1:FUNC. PROGRAMMING.

3 Press 5 on the numeric keypad. The display shows

5:PERSONAL BOX PRG.

4 Press the Yes ◀ key. The display shows

PERSONAL BOX NO. [].

5 Using the numeric keypad, enter the number of the mailbox (01 – 16) you want to modify. The mailbox number must be entered as a 2-digit number; e.g., 01.

6 The display asks you to confirm the box number. Press the Yes ◀ key if the number is correct.

! *If **ILLEGAL OPERATION** displays, the box you have selected contains a message. You must print out any messages in the box before you change its password or delete it.*

7 The display shows

PERSONAL BOX [CONF].

8 Press the Yes ◀ key. The display shows

PRG. PASSWORD.

9 Using the numeric keypad, enter the 4-digit password currently used with that mailbox.

10 Press the No ▶ key. The display shows

PRG. PASSWORD

11 To create a new password, enter a new 4-digit number on the numeric keypad.

12 Press the Yes ◀ key to accept the new password.

13 Your fax machine will ask you to enter another mailbox number.

- To continue programming mailboxes, go back to Step 5.
- If you are finished programming, press the Select Function key.

Closing (Deleting) a Mailbox

If you want to delete an existing mailbox, follow the instructions below.

- ! *A mailbox must be empty before you can modify or delete it.*

- 1 Press the Select Function key.
- 2 Press the 9/User Program One Touch key. The display shows

1:FUNC. PROGRAMMING.
- 3 Press 5 on the numeric keypad. The display shows

5:PERSONAL BOX PRG.
- 4 Press the Yes ◀ key. The display shows

PERSONAL BOX NO. [].
- 5 Using the numeric keypad, enter the number of the mailbox (01 – 16) you want to delete. the mailbox number must be entered as a 2-digit number; e.g., 01.

- 6 The display asks you to confirm the box number. Press the Yes ◀ key if the number is correct.

- ! *If ILLEGAL OPERATION displays, the box you have selected contains a message. You must print out any messages in the box before you change its password or delete it.*

- 7 The display shows

PERSONAL BOX [CONF].

- 8 Press the No ▶ key until [CLOSE] appears. Then Press the Yes ◀ key. When the display shows

DELETE PERSONAL BOX

press the Yes ◀ key.

- 9 The fax machine will ask you to enter another mailbox number.
 - To continue programming mailboxes, go back to Step 5.
 - If you are finished programming, press the Select Function key.

Sending Confidential Faxes

- ! *To send a confidential fax, you must know in advance the mailbox the message should be sent to. Ask the person who will receive the fax to tell you their mailbox number.*

- 1 Load your documents.
- 2 Press the Select Function key.
- 3 Press the 3/Confidential TX One Touch key. The display prompts you to enter the number of a confidential mailbox on the receiving fax machine.
- 4 Using the numeric keypad, enter the number of the confidential mailbox you are transmitting to.
- 5 Press the Yes ◀ key to confirm your entry. The display shows

SELECT LOCATION.

- 6 Select a location. Refer to the instructions below.
 - To select a One Touch key, press the One Touch key (lift the main One Touch keypad to access One Touch keys 16 –30).
 - To select an Auto Dial number, press the Auto Dial key, then enter the two-digit Auto Dial number on the numeric keypad.
 - To select a number dialed on the numeric keypad, dial as you would on a normal telephone.
- 7 Press the Start key. Your fax machine begins sending the fax.

Receiving Confidential Faxes

If you need to receive a fax that should not be seen by anyone else, have the person send the message from another Oki fax-capable unit as a confidential fax.

In order to do this, you must first set up a confidential mailbox. Refer to the “Creating a Personal (Confidential) Mailbox” section of this handbook.

Then, give your mailbox number to the person sending the message.

An incoming confidential fax is stored in memory until you enter the password. It will not print until the password is provided.

Printing Confidential Messages

Each time your fax machine receives a confidential message, it automatically prints a confidential reception report that tells you which mailbox number received the message.

To print a received confidential fax:

- 1 Press the Select Function key.
- 2 Press the 10/Message Print from Memory One Touch key. The display shows

PRINT MEMORY MSG.?

- 3 Press the No ► key. The display shows

PRINT PERSONAL BOX.

- 4 Press the Yes ◀ key. The display shows

PERSONAL BOX NO. [].

- 5 Using the numeric keypad, enter the number of the mail box you want to print from. The display shows

PRG. PASSWORD [].

- ! *If no message is stored in that mail box, the display shows **NO DATA IN MEMORY.***

- 6 Using the numeric keypad, enter the 4-digit password for the mail box you want to print from.

- 7 Press the Yes ◀ key. The message prints.

- ! *If you want to clear the mailbox without waiting for printing, press the Stop key at this point. The display changes to **CANCEL.** Press the Yes ◀ key to clear the mail box.*

Personal Mailboxes (Security Feature)

A personal mailbox is a security feature of the fax unit. It allows you to send and receive password-protected, confidential faxes into secured memory. It also allows you to perform bulletin polling.

Personal mailboxes may also be referred to as confidential mailboxes.

Your fax unit has 16 personal (confidential) mailboxes.

Refer to the “Advanced Operations, Confidential Faxes (Security Feature)” and “Advanced Operations, Polling” sections of this document for more details.

Polling

There are two types of polling: standard and bulletin.

What is Standard Polling?

Normally, when you send faxes, you load documents, select a location, and then press the Start key to begin transmission.

Sometimes it is more useful to load your documents on your fax unit and set it to wait for the receiving fax machine to call and collect them. This is known as setting your unit to be polled, or setting it for polling transmission. Calling a remote fax machine to receive documents someone else has loaded is known as polling or polling reception.

- ! *Plan polling arrangements with the other party in advance, so that everyone is aware of when documents will be available.*

Keep in mind that documents waiting to be polled stay in the document feeder until they have been removed—you won't be able to use the document feeder for other purposes until polling is completed.

What is Bulletin Polling?

This feature is similar to standard polling. The main difference is that the document is stored in a personal mailbox instead of loaded into the document stacker. This means that the document can be polled by more than one remote fax machine. The document is not deleted after it is polled. You can also store different documents in different boxes, so that you can easily change the document available for polling.

Sending Documents Requested by Another Fax Machine (Polling Transmission)

- 1 Load your documents.
- 2 Press the Select Function key.
- 3 Press the 5/Polling One Touch Key. The display shows

BULLETIN POLL.

- 4 Press the No ► key. The display shows

WAITING TO BE POLLED.

To Cancel Polling

1 Press Stop. The display reads:

COMMUNICATION CANCEL

2 Press the Yes  key. The display reads:

CANCEL

then

MSG CONFIRMATION PRINTING

When the message confirmation report prints, the display reads

SELECT LOCATION.

Press Stop to remove documents.

Dialing Another Fax Machine to Request Documents (Polling Reception)

1 With no documents loaded, press the Select Function key.

2 Press the 5/Polling One Touch key. The display shows

NO.=<MAIL BOX NO.>.

3 Press the Start key. The display shows

POLLING RX, SELECT LOCATION.

 *If you want to save the polled fax to a personal box, wait 3 seconds, then enter the box number and press Start.*

4 Select a location. Refer to the instructions below.

- To select a One Touch key, press the One Touch key (lift the main One Touch keypad to access One Touch keys 16 – 30).
- To select an Auto Dial number, press the Auto Dial key, then enter the two-digit Auto Dial number on the numeric keypad.
- To select a number dialed on the numeric keypad, dial as you would on a normal telephone.

5 Press the Start key. Your fax machine begins polling the remote fax machine.

Fax on Demand (Bulletin Polling)

This feature is similar to standard polling. The main difference is that the document is stored in a personal mailbox instead of loaded into the document stacker. This means that the document can be polled by more than one remote fax machine—it is not deleted after it is polled. You can also store different documents in different boxes, so that you can easily change the document available for polling.

Opening a Personal Box for Polling

- 1 Press the Select Function key.
- 2 Press the 9/User Program One Touch key. The display shows

1: FUNC. PROGRAMMING.

- 3 Press 5 on the numeric keypad. The display shows

5:PERSONAL BOX PRG.

- 4 Press the Yes ◀ key. The display shows

PERSONAL BOX NO. [].

- 5 Using the numeric keypad, enter the number of the mailbox (01 – 16) you want to use. the mailbox number must be entered as a 2-digit number; e.g., 01.
- 6 The display asks you to confirm the box number. Press the Yes ◀ key if the number is correct.
- 7 The display shows

PERSONAL BOX [CLOSE].

Press the No ▶ key until POLL appears in the brackets.

- ! *If [CONF] or [POLL] appears, then the box number is already in use as a confidential or bulletin poll mailbox.*

- 8 Press the Yes ◀ key to continue.
- 9 Using the numeric keypad, enter the 4-digit password you want to use with your mailbox.
- 10 Press the Yes ◀ key to confirm your entry.
- 11 The fax machine then asks you to enter another mailbox number. To continue programming mailboxes, go back to step 5. When you are finished, press the Select Function key.

Loading a Document for Polling

- 1 Load the document into the stacker.
- 2 Press the Select Function key.
- 3 Press the 5/Polling One Touch key. The display shows

BULLTIN POLL.

- 4 Press the Yes ◀ key. The display shows

PERSONAL BOX NO. [].

- 5 Enter the number of the personal box where you want to store the document.
- 6 The display asks you to confirm the box number. If it is correct, press the Yes ◀ key.
- 7 The fax machine scans the document. When scanning is complete, the display shows

WAITING TO BE POLLED.

Transmit Preparation

What is it?

Transmit Preparation is a feature of the fax machine. Transmit preparation “interrupts” a fax transmission from memory to allow a document to be sent from the manual feeder. Once the manual transmission is complete, the memory transmission will resume.

Here is an example of transmit preparation. Your fax machine is performing a broadcast transmission. The broadcast is going to twelve different locations. It has completed the transmissions to the first three locations, and is just starting on the fourth. You need to fax a signed approval document immediately. You walk up to the fax machine, load the document into the feeder, select the location to send the fax to, and press the Start key (if necessary). The fax machine will complete the broadcast transmission to the fourth location, send your “walk-up” fax, and then resume the broadcast transmission with the fifth location.

Setting the Forwarding Number (Call Forwarding)

When your fax machine's answering mode is set to Fax Forwarding [FWD], it receives fax messages into memory and then automatically resends it to another location. This can be useful feature if you are travelling.

! *You must program a forwarding number before you can set the unit to Fax Forwarding mode.*

- 1 Press the Select Function key.
- 2 Press the 9/User Program One Touch key. The display shows

1:FUNC. PROGRAMMING.

- 3 Using the numeric keypad, press 6. The display shows

6:FORWARDING NO. PRG.

- 4 Press the Yes ◀ key. The display shows

☎NO=<FORWARDING NO.>.

- 5 After the display clears, enter the fax number you want your messages forwarded to.
 - To enter numbers, press the Numeric keypad (press once).
 - To enter spaces, press the pace One Touch key.
 - To enter hyphens, press the Hyphen key
 - To enter pauses (i.e., to wait for long distance or outside lines), press the Pause key.
 - To move the cursor to make corrections, press the Yes ◀ and No ▶ keys.
- 6 Press the Start key to save your entry.
- 7 Press the Select Function key to finish.

Working with Dual Access

Your fax machine's dual access feature allows you to load and prepare to transmit (send) a document while your fax machine is receiving or sending another fax from memory. This feature increases your productivity and reduces the time you spend waiting for operations to finish.

What You Can Do While Sending a Fax

After your fax machine has finished scanning a document into memory—and while it is transmitting from memory—you can:

- Load another document and prepare it for transmission. You can continue to load documents as long as memory is available in your fax machine. When the first transmission is complete, the next fax will automatically be sent.
- Make copies.

What You Can Do While Receiving a Fax

While your unit is receiving a fax, you can:

- Load another document and prepare it for transmission. You can continue to load documents as long as memory is available in your unit. When the fax has been received, the faxes you have loaded will automatically be sent.
- Continue to receive faxes while earlier received messages are printing, if your unit is set to receive faxes into memory.

What You Can Do While Making Copies

While your unit is making copies, you can:

- Continue to receive faxes while copies are printing, if your unit is set to receive faxes into memory.

Reports

Understanding Reports

Your fax machine provides a variety of useful reports. These help you understand the machine's current settings, programming and operations.

The reports are:

- Activity Report
- Broadcast Confirmation Report (MCF)
- Broadcast Entry Report
- Confidential Reception Report
- Configuration Report
- Message Confirmation Report
- Phone Directory
- Power Outage Report

Activity Report

What is it?

The activity report provides a record of your fax machine's communications.

What information does it provide?

- The total amount of time spent sending faxes ("Calling") and the total amount of time spent receiving faxes ("Called").
- The date, time and duration (S, R-TIME) of each transmission or reception.
- The name or telephone number of the fax machine you were communicating with (DISTANT STATION ID). If you were sending a fax, the telephone number or the Location ID is printed. If you were receiving a fax, the remote fax machine's Personal ID or its telephone number is printed.

- The communication mode used for each transmission or reception (Communication Codes).
- The number of pages sent or received.
- The result of each communication (Results Codes).
- Service codes. Be sure to report these diagnostic codes if you contact your Authorized OKIFAX Dealer about communication problems.

! *This report does not list messages that were received without errors.*

How to Print

- 1 Press the Select Function key.
- 2 Press the 6/Report Print One Touch key. The display shows

1:ACTIVITY REPORT.

- 3 Press the Yes ◀ key. The report prints.

How to Interpret

Refer to “What information does it provide?” for this report.

For information on Communication Codes and Result Codes, refer to “Codes Used in Reports.”

Your Authorized OKIFAX Dealer will work with you to interpret the service codes (if any) that appear on this report.

Broadcast Confirmation Report (MCF)

What is it?

Use this report to confirm the results of a multiple-location transmission (broadcast).

What information does it provide?

- The date and time at which the broadcast started.
- The total amount of time used to complete the broadcast.
- The Location ID, the number of pages sent, and the result of the communication (for each location)

How to Print

- 1 Press the Select Function key.
- 2 Press the 6/Report Print One Touch key. The display shows 1:ACTIVITY REPORT.
- 3 Using the numeric keypad, press 2.
The display shows 2:BROADCAST MCF.
or
Press the No ► key repeatedly until the report you want to print appears on the display.
- 4 Press the Yes ◀ key. The report prints.

How to Interpret

Refer to “What information does it provide?” for this report.

For information on Results Codes, refer to the “Reports, Codes Used in Reports” section of this handbook.

Broadcast Entry Report

What is it?

This report is a confirmation of the entries you have made while programming a multiple-location transmission (broadcast). Each time you program a multiple-location transmission (broadcast), your fax machine gives you the option of printing this report to confirm your entries.

What information does it provide?

- The Location ID of the One Touch keys and Auto Dial codes you have selected.
- Telephone numbers you have entered using the numeric keypad.

How to Print

Each time you program a multiple-location transmission (broadcast), your fax machine gives you the option of printing the Broadcast Entry Report to confirm your entries. Refer to Performing a Broadcast Operation for details.

How to Interpret

Refer to “What information does it provide?” for this report.

Confidential Reception Report

What is it?

This report is an automatically printed notice that your fax machine has received a confidential message into a mailbox.

What information does it provide?

- The date the message was received.
- The total amount of time spent Sending or Receiving (S, R-TIME).
- The Location ID or telephone number of the fax machine you were communicating with (DISTANT STATION ID).
- The number of the mailbox that received the message.
- The number of pages received.
- The result of the communication (Results Codes).
- Service codes. Be sure to report these diagnostic codes if you contact your Authorized OKIFAX Dealer about communication problems.

How to Print

This report prints automatically each time your fax machine receives a confidential message into a mailbox.

How to Interpret

Refer to “What information does it provide?” for this report. For Service Codes, refer to your Authorized OKIFAX Dealer. Your dealer will work with you to interpret the service codes (if any) that appear on this report.

Configuration Report

What is It?

The configuration report is a list of the current operational settings of your fax machine.

What Information Does it Provide?

- The current settings of all user functions (except for One Touch Parameter settings, which appear in the telephone directory).
- The Sender ID (ID=), TSI/CSI (TEL NO.), and call back number currently programmed into your fax machine.
- Current dial parameter settings.

How to Print

- 1 Press the Select Function key.
- 2 Press the 6/Report Print One Touch key.
The display shows 1:ACTIVITY REPORT.
- 3 Using the numeric keypad, press 4.
The display shows 4:CONFIGURATION.
Or
Press the No ► key repeatedly until the report you want to print appears on the display.
- 4 Press the Yes ◀ key. The report prints.

How to Interpret

The “What information does it provide?” section for this report explains the information provided in this report.

Here is a list of the User Functions. Refer to the “Setting Basic Features, User Function Settings” section of this handbook for further information.

User Function Settings List

- 01 MCF(SINGLE-LOC.)
- 02 MCF(MULTI-LOC.)
- 03 ERR REPORT (MCF)
- 04 IMAGE IN MCF
- 05 SENDER ID
- 06 MONITOR VOLUME
- 07 BUZZER VOLUME
- 08 CLOSED NETWORK
- 09 TX MODE DEFAULT
- 10 T/F TIMER PROG.
- 11 RING RESPONSE
- 12 DISTINCTIVE RING
- 13 1'ST PAPER SIZE
- 14 2'ND PAPER SIZE

- 15 USER LANGUAGE
- 16 INCOMING RING
- 17 REMOTE RECEIVE
- 18 MEM./FEEDER SW.
- 19 NOT USED
- 20 ECM FUNCTION
- 21 REMOTE DIAGNOSIS
- 22 PC/FAX SWITCH
- 23 ONE TOUCH PARAM

Message Confirmation Report (MCF)

What is it?

This report provides information about your last single-location fax transmission or polling transmission.

What information does it provide?

- The date of the communication.
- The total amount of time spent Sending or Receiving (S, R-TIME).
- The Location ID or telephone number of the fax machine you were communicating with (DISTANT STATION ID).
- The communication mode used (Communication Codes).
- The number of pages sent or received.
- The result of the communication (Results Codes)
- Service codes. Be sure to report these diagnostic codes if you contact your Authorized Service Dealer about communication problems.
- If the fax was transmitted from memory (not directly from the feeder), a portion of the first page prints after the report. If you do not want this portion of the first page to print, set User Function 04, Image in MCF, OFF. Refer to the “Setting Basic Features, User Function Settings” section of this handbook.

How to Print

You can set your fax machine to print a message confirmation report after every transmission (automatic) or you can print a report only when you want to (manual).

Automatic

Follow this procedure to set your fax machine to print a message confirmation report after every transmission.

- 1 Press the Select Function key.
- 2 Press the 9/User Program One Touch key.
The display shows

1:FUNC. PROGRAMMING.

- 3 Press the Yes ◀ key. The display shows

FUNCTION NO. [].

- 4 Using the numeric keypad, enter the 2-digit number of the function you want to change.

01 is for **MCF(SINGLE-LOC.)**

The report automatically prints after each single-location transmission or polling transmission.

02 is for **MCF(MULTI-LOC.)**

The report automatically prints after each multiple-location transmission.

The display shows the name of the selected function.

MCF(SINGLE-LOC.)

or

02 is for MCF(MULTI-LOC.)

- 5 Repeatedly press the No ▶ key until the setting you want (ON or OFF) appears in the display.
- 6 Press the Yes ◀ key to confirm your selection.
The name of the next function setting appears in the display.
- 7 Press the Select Function key to finish.

On Demand (Manual)

After transmission, press the Copy key once (with no documents loaded) to see a report confirming your transmission on the display.

To print the report, press the Copy key a second time.

How to Interpret

Refer to “What information does it provide?” for this report.

For information on Communication Codes and Results Codes, refer to the “Codes Used in Reports” section of this handbook.

For Service Codes, refer to your Authorized OKIFAX Dealer. Your dealer will work with you to interpret the service codes (if any) that appear on this report.

Phone Directory

What is it?

This report provides a complete listing of all of the telephone numbers programmed into your fax machine’s One Touch keys, Auto Dial codes and groups.

What information does it provide?

- The Location ID and main fax number for each One Touch key and Auto Dial code.
- The alternate number for each One Touch key.
- The One Touch Parameter settings for each One Touch key.
- A listing of all of the One Touch keys and Auto Dial codes included in each group.

How to Print

- 1 Press the Select Function key.
- 2 Press the 6/Report Print One Touch key.
The display shows **1:ACTIVITY REPORT**.
- 3 Using the numeric keypad, press 3.
The display shows **3:PHONE DIRECTORY**
or
Press the No ► key repeatedly until the report you want to print appears on the display.
- 4 Press the Yes ◀ key. The report prints.

How to Interpret

Refer to “What information does it provide?” for this report.

Power Outage Report

What is it?

This report automatically prints if power is interrupted. It lists all messages lost because of the power outage.

Certain information stored in your fax machine is lost if power is interrupted under these circumstances:

- If there is no optional memory expansion board installed.
- If there is optional memory installed, but power has been interrupted for more than one hour.

In these cases, any documents stored in the fax machine's memory are erased.

These items are usually faxes in personal boxes and faxes not printed because there was no paper in the machine.

The information in this report can help you identify and reconstruct any documents that were lost.

What information does it provide?

- All faxes received into memory but not printed,
- The date and time the faxes were received,
- The Sender ID for each fax.
- Faxes in memory waiting to be sent, when they were scheduled to be sent, and the intended recipient.

How to Print

This report automatically prints if power is interrupted.

How to Interpret

Refer to "What information does it provide?" for this report.

Printing Reports

Activity Report

Refer to the “Using 6/Report Print One Touch Key” section, below.

Broadcast Confirmation Report (MCF)

Refer to the “Using 6/Report Print One Touch Key” section, below.

Broadcast Entry Report

Each time you program a multiple-location transmission (broadcast), your fax machine gives you the option of printing the Broadcast Entry Report to confirm your entries.

Refer to the “Sending a Fax to Multiple Locations (Broadcasting)” section of this handbook.

Confidential Reception Report

This report prints automatically each time your fax machine receives a confidential message into a mailbox.

Configuration Report

Refer to the “Using 6/Report Print One Touch Key” section, below.

Message Confirmation Report

You can set your fax machine to print a message confirmation report after every transmission (automatic) or you can print a report only when you want to (on demand [manual]).

Automatic

Set User Functions 01 and 02 to on. Refer to the “Reports, Message Confirmation Report, How to Print” section of this handbook.

On Demand (Manual)

After transmission, press the Copy key once (with no documents loaded) to see a report confirming your transmission on the display.

To print the report, press the Copy key a second time.

Phone Directory

Refer to the “Using 6/Report Print One Touch Key” section, below.

Power Outage Report

This report automatically prints if power is interrupted.

Using 6/Report Print One Touch key

Using this key allows you to print four reports: Activity Report, Broadcast Confirmation Report, Configuration Report, and Phone Directory.

- 1 Press the Select Function key.
- 2 Press the 6/Report Print One Touch key. The display shows 1:ACTIVITY REPORT.
If you want to print an Activity Report, skip to step 4.
- 3 Press the No ► key repeatedly until the report you want to print appears on the display.

Or

Enter 2 for BROADCAST MCF (Broadcast Confirmation Report)

Enter 3 for PHONE DIRECTORY

Enter 4 for CONFIGURATION

- ! ***The PROTOCOL DUMP report contains information meaningful only to service technicians.***

- 4 Press the Yes ◀ key. The report prints.

Codes Used in Reports

Three types of codes are used in reports.

- Communication Codes
- Result Codes
- Service Codes

Communication Codes

Communication codes indicate the communication mode used for a communication.

B.C

Multiple-location transmission (broadcast).

BOX

Reception into a personal mail box.

CALLING

A communication initiated by your fax machine

CALLED

A communication initiated by a remote fax machine.

Result Codes

Result codes indicate the results of communications.

BUSY

The other machine's line was busy or there was no answer.

CANCL

A message was erased after being held in memory for 10 days.

COMP

A multiple-location transmission was completed.

COVER

The cover was opened during the communication.

NO

The transmission or reception failed.

OK

The communication was completed successfully.

PUNIT

This error code indicates a problem with the printing unit.

Contact service. Refer to the "Service and Support" section of this handbook.

R_JAM

A paper jam occurred in your fax machine while it was receiving a fax, and it was unable to receive the entire message in memory.

S_JAM

A document jam occurred.

STOP

The Stop key was pressed, ending the communication session.

Service Codes

For Service Codes, refer to your Authorized OKIFAX Dealer. Your dealer will work with you to interpret the service codes (if any) that appear on this report.

Problem Solving

Clearing a Document Jam

When a document jams while being faxed or scanned, your fax machine beeps, the red Alarm indicator lights, and **DOCUMENT JAM** appears in the display. If the jammed document looks as if it is positioned straight in your feeder, press the Stop key to try to feed the document the rest of the way through the feeder. If this fails, follow the instructions below.

- 1 Grasp the control panel. Pull it up until it releases. Swing the control panel up and out of the way.

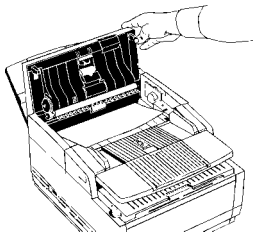

- 2 Pull out the jammed document.

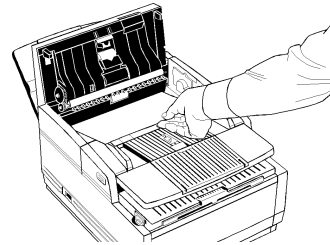

- 3 Push the control panel back down until it locks.

Clearing a Paper Jam

If the Alarm indicator lights and your fax machine displays PAPER JAM or NO PAPER when the paper tray still contains paper, there may be one or more sheets of paper jammed in the machine.

If you are out of paper, refer to the “Installation, Loading Paper” section of this handbook.

To clear a paper jam, follow the instructions below.

- ! *If you experience paper jams often, the type of paper you are using may be the problem. For best results, select paper developed specifically for photocopying or laser printing. Be sure to fan the paper before loading it into your paper tray.*

Make sure User Function 13, 1ST PAPER SIZE is set for the size paper you are using. Refer to the “Setting Basic Features, User Function Settings” section of this handbook.

- 1 Lift the document table and swing it out of the way.

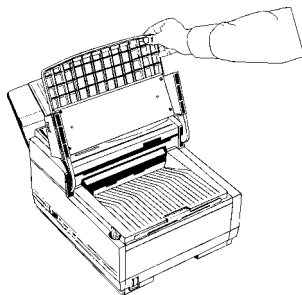

- 2 Push the buttons on the side of the copy stacker until you hear a click. Lift the copy stacker up.

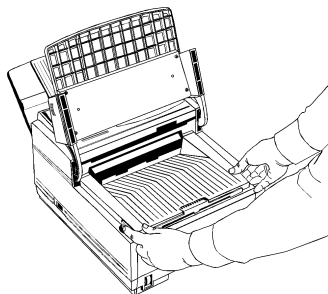

3 Lift the image drum cartridge out and set it aside.

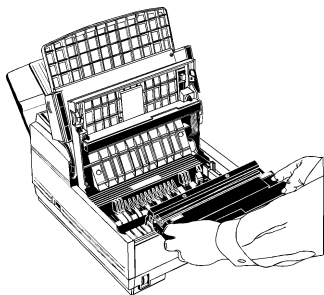

! **Warning:** *Never expose the image drum unit to light for more than five (5) minutes. Never expose the image drum unit to direct sunlight. Never touch the surface of the green drum inside the image drum unit.*

4 Pull out any paper you see jammed inside the machine.

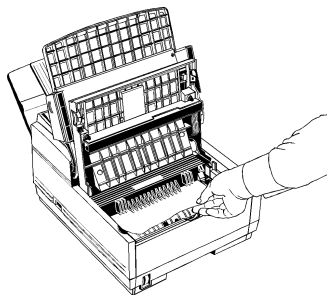

5 Pull out the paper tray. If any paper in the tray is damaged, remove and replace it.

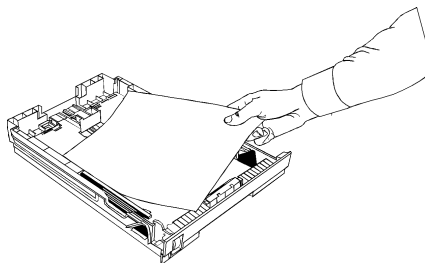

6 Push the paper down until it is under the plastic tabs.

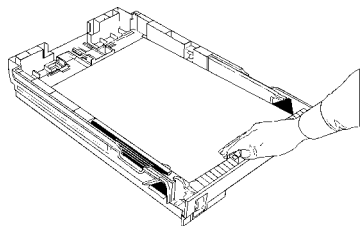

7 Make sure the paper stop in the tray is properly adjusted: not too loose, not too tight.

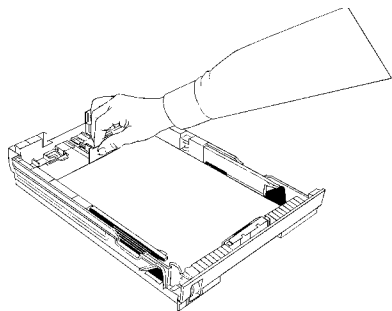

8 Slide the paper tray all the way back into the fax machine.

9 Place the image drum unit back into your fax machine. To make sure that the image drum is positioned correctly, press down firmly on both of the locations on the drum marked "PUSH."

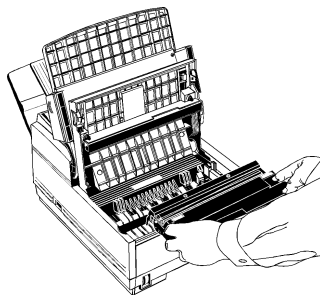

10 Close the copy stacker and push down until you hear a click. Be sure both sides are latched.

11 Close the document table.

- ! *If you cannot remove jammed paper using the procedure above and most of the jammed sheet has emerged from the machine, use the following method. You will probably need someone to help you. Open the document stacker and copy stacker (steps 1 and 2 above).*

Reach between the two stackers and push back the blue output guide while pulling the paper out. Do not force the paper: you could damage the mechanism or leave paper fragments in it.

Printing a Cleaning Page

If you notice repeating marks or imperfections on your printouts, try printing a cleaning page.

The cleaning page process

- Removes residual impurities from printing surfaces.
- Reduces problems such as repeating marks, blotching, and shading.

To print a cleaning page:

- 1 Make sure there are no messages in memory.
- 2 Press the Select Function key.
- 3 Press the 10/Message Print from Memory key.
- 4 Press the Yes ◀ key. The cleaning page prints.

Replacing the Toner Cartridge

The number of pages you can print with one toner cartridge varies depending on the type of documents you usually receive or copy. A toner cartridge will print about 2,000 letter-size pages at a typical print coverage of 4% (equivalent of CCITT No. 1 test chart).

- ! *The first toner cartridge in your new fax machine has to fill the drum reservoir and saturate the developing roller with toner. For this reason, it will need to be replaced sooner than subsequent cartridges—after about 1,000 pages.*

If your fax machine displays **TONER LOW** or **REPLACE TONER CART.**, replace the toner cartridge with a new one soon. If print density is high enough, you can continue to use the toner cartridge without replacing it until print quality becomes unacceptable. Keep in mind that if you don't replace the cartridge soon, there is a risk that a fax will be unreadable when it prints using an empty cartridge.

If the print density becomes low even before your fax machine displays **TONER LOW** or **REPLACE TONER CART.**,

gently wipe the lens surface of the LED array (refer to Step 8). If the print density does not improve, replace the toner cartridge.

- ! *Warning: Be careful when handling the toner cartridge.*
- *Do not let toner spill on your clothing or other porous materials. Use cold water to clean up spilled toner; hot water causes the stain to set.*

- 1 Lift the document table into an upright position.

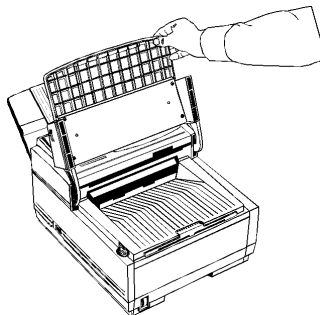

- 2 Push in the cover release buttons on the side of the copy stacker until you hear a click. Lift the copy stacker.

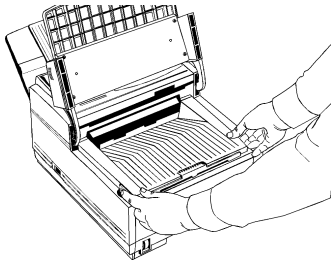

- 3 Pull the blue lever on the old toner cartridge all the way toward you. Carefully pull the old toner cartridge out of the image drum unit. Dispose of it in the plastic bag you received with your new cartridge.

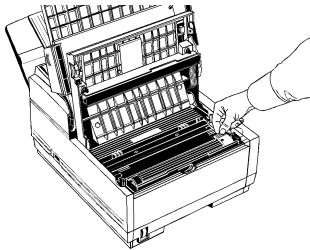

- 4 Remove the new toner cartridge from its package and gently shake it from side to side to distribute the toner. Then carefully peel the white plastic tape from the bottom of the toner cartridge.

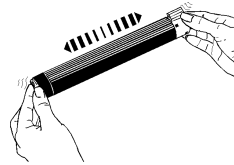

- 5 With the ridged side facing up and the lever on your right, insert the toner cartridge into the image drum unit. Slide the left end of the cartridge in first, then lower the right end into place.

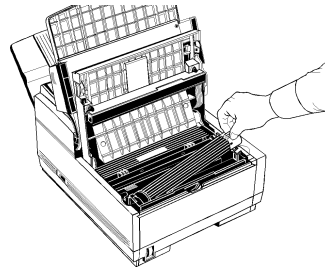

- 6** Once the toner cartridge is in place, push the lever all the way toward the back of the fax machine to secure it and release the toner.

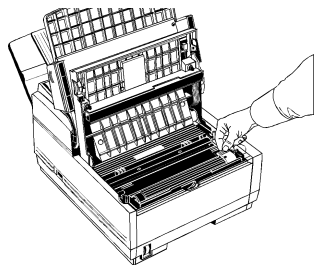

- 7** Using the cleaning wipe provided with your new toner cartridge, gently wipe back and forth across the full length of the LED array. Let the array dry completely.

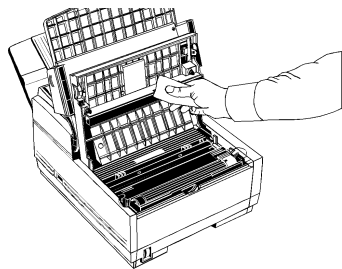

- 8** Close the copy stacker and push down until you hear the copy stacker click into place. Be sure that the cover latches on both sides.

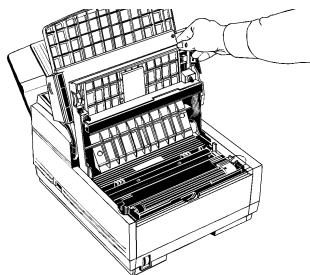

- 9** Close the document table.

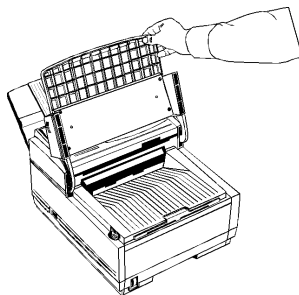

For Your Safety: Handling the Toner Cartridge

- Leave unused toner cartridges in their packages until needed.
- When replacing a toner cartridge, re-use the packaging to dispose of the old toner cartridge.
- Be careful when removing the toner cartridge. Do not let it touch your clothing or porous materials. The toner powder causes permanent stains.
- Small amounts of toner spilled on skin or clothing can be readily removed with soap and *cold* water. Using heated water will make removing the stain much more difficult.

Working with the Image Drum Cartridge

! *Cautions:*

Never expose the image drum unit to light for more than five (5) minutes.

Never expose the image drum unit to direct sunlight.

Never touch the surface of the green drum inside the image drum unit.

Be careful not to scratch the green surface when you put the drum down on a table or other surface.

For Your Safety: Handling the Image Drum

- Leave unused image drum units in their packages until needed.
- When replacing an image drum unit, re-use the packaging to dispose of the old image drum unit.
- Do not expose these components to light for more than five minutes.
- Never expose the green drum (inside the image drum unit) to direct sunlight.
- Always hold the image drum unit by the ends, never by the middle.
- Never touch the surface of the green drum inside the image drum unit.
- Small amounts of toner spilled on skin or clothing can be readily removed with soap and cold water. Using heated water will make removing the stain much more difficult.

The CHANGE DRUM SOON Message

The **CHANGE DRUM SOON** message is a warning that the image drum cartridge in your fax machine may be approaching the end of its usable life, which is approximately 20,000 pages, depending on the length and type of document you receive or copy. It appears when the drum has used up approximately 90% of its life, based on an internal calculation.

This message does not mean that you must replace the image drum immediately, nor does it cause your fax machine to stop working. In most cases, your image drum still has at least 10% of its productive life left. You can continue to use the image drum as long as print quality is acceptable. However, you should have a replacement image drum and toner cartridge handy. Replace the drum when print quality deteriorates below an acceptable level.

When to Replace the Image Drum Cartridge

You need a new image drum if the faxes you receive are light or have vertical streaks in them and you are not out of toner, or if your fax machine displays a **CHANGE DRUM** message. Contact your Authorized OKIFAX Dealer to order one.

- ! *You must replace the toner cartridge when you replace the image drum.*

The life of an image drum depends on a number of factors, including temperature and humidity, the type of paper you use, and the number of pages per job.

Replacing the Image Drum Cartridge

1 Lift the document table into an upright position.

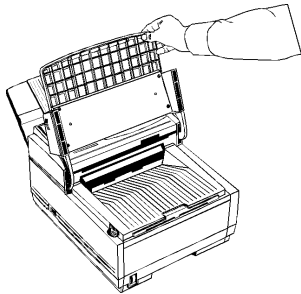

2 Push in the cover release buttons on the side of the copy stacker until you hear a click. Lift the copy stacker.

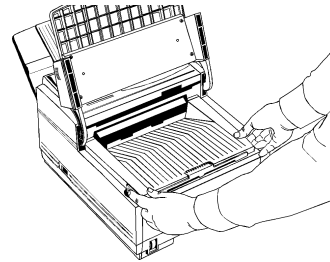

3 Remove the old image drum unit (with its toner cartridge), wrap it in the packaging materials from your new image drum unit, and discard it.

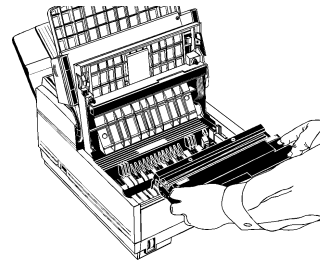

- 4 Remove the protective sheet from the new image drum unit.

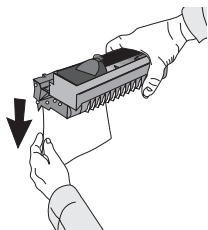

- 5 Insert the new image drum unit into your fax machine. To ensure that the image drum is positioned correctly, press down firmly on both of the locations on the image drum marked "PUSH."

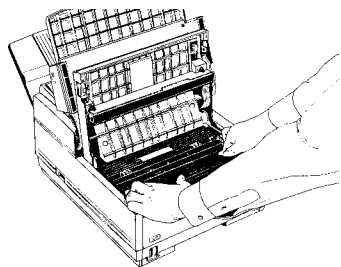

- 6 Install a new toner cartridge. Remove the new toner cartridge from its package and gently shake it from side to side to distribute the toner. Then carefully peel the white plastic tape from the bottom of the toner cartridge.

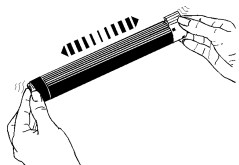

- 7 With the ridged side facing up and the lever on your right, insert the toner cartridge into the image drum unit. Slide the left end of the cartridge in first, then lower the right end into place.

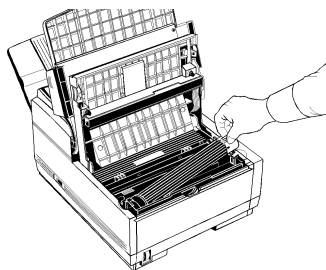

- 8** Once the toner cartridge is in place, push the lever all the way toward the back of the fax machine to secure it and release the toner.

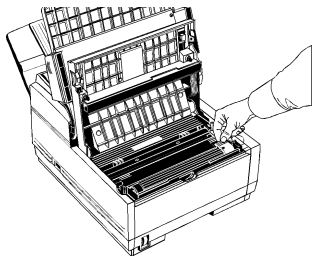

- 9** Using the cleaning wipe provided with your new toner cartridge, gently wipe back and forth across the full length of the LED array. Let the array dry completely.

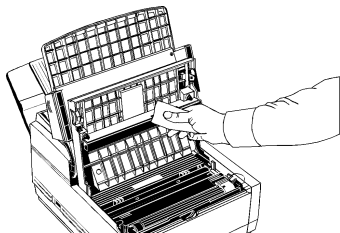

- 10** Close the copy stacker and push down until you hear the copy stacker click into place. Be sure that the cover latches on both sides.

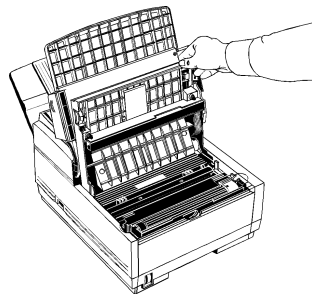

- 11** Close the document table.

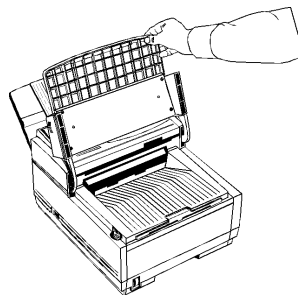

- 12 Follow the instructions in the “Resetting the Drum Counter” section of this handbook to reset the drum counter.

Resetting the Drum Counter

! *Important: Reset the drum counter only when you have finished installing a new image drum. You can only reset the counter when the Change Drum Soon message is on the display.*

- 1 Wait until the time, date, and answering mode appear on the display. Then press the Select Function key.
- 2 Press the 7/Counter Display One Touch key. The display shows **DRUM COUNT**.
- 3 Press the Yes ◀ key to clear the image drum unit counter.
- 4 Press the Select Function key to finish.

Display Panel Messages

This section lists the status and error messages that may appear on the fax machine's display panel, and explains what they mean and how to correct any problem they indicate.

- ! *The red Alarm indicator lights when there is an error condition.*

Normal Display

02:13 [nnn]

where nnn = FAX, TEL, PC, T/F, MEM, FWD, or TAD.

Under normal operating conditions, the top line of the display shows the time and the answering mode [nnn]

Error Messages

Messages are listed in alphabetical order by the first letter of the message.

CHANGE DRUM SOON

The image drum is nearing the end of its projected life. Make sure a new drum is available, and replace the drum when print quality begins to deteriorate.

COMMUN. ERROR

There is a problem communicating with a remote fax machine. Refer to the "Problem Solving, Problem Checklist" section of this handbook for possible causes and solutions.

CONFIRM PAPER SIZE

Appears only when the optional PC interface is installed. The paper loaded is not the size called for by your application software. Check your software printing settings and the paper in the paper tray.

COVER OPEN

The stacker cover is not closed. Press down firmly on the cover to make sure it is closed and latched on both sides.

DOCUMENT JAM [FAX] CONFIRM AND "STOP"

A document to be faxed or scanned has jammed in the scanner. Refer to the "Problem Solving, Clearing a Document Jam" section of this handbook.

DOCUMENT MIS-FEED[FAX] RELOAD DOCUMENT

A document to be faxed or scanned has not fed into the scanner properly. Remove the document and reload it into the document.

ERROR 77

There is no image drum in the fax machine. Turn the fax machine off, install an image drum and toner cartridge according to the instructions in this handbook, then turn it on again to clear the message.

PAPER JAM [FAX] CHECK PAPER OR PATH

Paper may be jammed inside the printing mechanism. Check the paper path and remove any jammed paper. Refer to the "Problem Solving, Clearing a Paper Jam" section of this handbook.

PAPER MIS-FEED [FAX] CHECK PAPER OR PATH

Paper is jammed feeding from the paper tray into the printer. Check the paper path and remove any jammed

paper. Refer to the “Problem Solving, Clearing a Paper Jam” section of this handbook.

**NO PAPER [FAX]
REPLACE PAPER**

The paper tray is out of paper. Add more paper. If there is paper in the tray, this message may indicate that paper has jammed while feeding into the printer. Check the paper path and remove any jammed paper. Refer to the “Problem Solving, Clearing a Paper Jam” section of this handbook.

If you run out of paper while printing a fax, the remainder of the fax is stored in memory, and a **MSG IN MEMORY** message appears. After you reload paper, stored faxes print automatically.

**PRINTER ALARM 2 [FAX]
PLEASE CONFIRM**

or

**PRINTER ALARM 4 [FAX]
PLEASE CONFIRM**

Open and close the cover. If this does not clear these messages, turn off your fax machine and contact your Authorized OKIFAX Dealer for service. Refer to the “Service and Support” section of this handbook.

REPLACE TONER CART.

Toner is running low in the toner cartridge. Replace the cartridge as soon as possible. When you close the cover after replacing the toner cartridge, the message clears.

Reading the Print Counters

The print counters count the number of pages your fax machine has printed or scanned in its lifetime. If you are experiencing a problem, a service person may ask you to check these counters.

- ! *If your fax machine's image drum unit has reached the end of its life, you will also use this function to reset the drum counter (you can do this only if the CHANGE DRUM SOON message is on the display. Refer to the "Problem Solving, Working with the Image Drum Cartridge" section of this handbook.*

- 1 Press the Select Function key.
- 2 Press the 7/Counter Display One Touch key.
The display shows your print unit counter.
- 3 Press the No ► key. The display shows the scanning unit counter.
- 4 Press the Select Function key to finish.

Problem Checklist

Your fax machine is a complex machine with many features and functions. Many problems you experience may be due to improper programming. If you are experiencing a problem, read through the following list of problems and solutions before calling your Authorized OKIFAX Dealer for service.

The display is blank.

- Make sure your fax machine is turned on. Check the power cord to make sure that it is securely plugged into the fax machine and into the wall outlet. Check your wall outlet to make sure that it has power.

Nothing happens when you press the control panel keys.

- Open and close the upper cover.
- If that does not solve the problem, turn the fax machine off, wait ten seconds, then turn it on again.

The display tells you to replace paper even though there is paper in the paper tray.

- Make sure that the paper is properly stacked in the tray, then check for a paper jam in the paper feed path.

Your documents jam in the scanner.

- Check the document for wrinkles, tears or other damage. If it is damaged, try making a copy of the document on a photocopier and faxing or scanning the copy.
- Make sure there are no staples or paper clips and that the paper is clean and dry.
- Make sure the document is not wider than your fax machine can load.

Your fax machine won't dial.

- Check the power cord and wall outlet.
- Make sure that your telephone line (not your external telephone or handset) is connected to the LINE outlet on the back of your fax machine. Refer to the “Installation, Connecting the Telephone Line” section of this handbook.
- If you have an external telephone connected, lift the handset and check for a dial tone. If you do not hear one, there may be a problem with your telephone line. If you do hear a dial tone, your fax machine may be using the wrong dialing method (pulse or tone) for your area. If you hear changing tones instead of dialing pulses and you know that your area uses pulse dialing, you should adjust the setting for Dial Parameter MF(TONE)/DP(PULSE). Refer to the “Setting Basic Features, Dial Parameter Settings” section of this handbook.

The display shows a communication error.

- A COMMUN. ERROR message indicates any of a number of problems.
- You may be trying to communicate with an incompatible fax machine (your fax machine can only communicate with ITU-T Group 3 fax machines).
- The remote machine may not be able to perform the function that you want, such as polling or confidential messages.
- The remote machine may be out of paper or experiencing a paper jam.
- Bad telephone line conditions can cause communication errors. Try sending the fax again and check to make sure you are dialing the correct telephone number.
- If you have to dial a prefix number to get an outside line, or if you are dialing internationally, you may need to enter a pause (using the Pause One Touch key) after the dial prefix or international dialing code to tell your machine to wait for a dial tone.
- If you have frequent problems communicating with a particular remote fax machine, try programming the number into one of your One Touch keys and then

changing the One Touch Parameters for that One Touch key. Refer to the “Programming Your Speed Dial Directory, One Touch Faxing” section of this handbook.

- Lastly, either your fax machine or the remote fax machine may need servicing. Try sending a fax to another location to check your machine.

You sent a fax but the image the remote fax machine received was very poor.

- If your document had a lot of small type, complex illustrations, photos, or was very light or very dark, try changing your resolution and contrast settings. Refer to the “Basic Faxing Operations, Preparing Documents for Faxing, Loading Documents” section of this handbook.
- Copy the document on your fax machine to preview how it will transmit. The problem may be caused by telephone line interference.
- Try sending the document again later.

You sent a fax but it was received completely blank.

- Make sure that you have loaded your document face *down*.

You keep getting reports you do not want.

- Message Confirmation Reports can be set to print automatically after each single or multiple-location transmission; Error Reports can be set to print after each failed transmission or reception. Check your user function settings and turn off the reports you do not want. Refer to the “Reports” section of this handbook.

The image received on your fax machine was very poor.

- Contact the person sending you the fax and ask them to change their resolution and contrast settings. Ask the person to make a copy of the document on their fax machine to make sure it is working properly. Then ask them to send the fax again.
- If you still have a problem, try making a copy of a document on your machine to make sure it is working properly. If blotches or recurring marks appear, print a cleaning page.

You tried dialing with a One Touch key or an Auto Dial code but nothing happened.

- Make sure that something is programmed into the One Touch key or Auto Dial code you are using.
- Check the fax number to make sure it was entered correctly. Refer to the “Programming Your Speed Dial Directory” section of this handbook.
- When you are dialing with an Auto Dial code, be sure to press the Auto Dial key before you enter the code.
- If your fax machine has the Dial Parameter, Auto Start feature turned off, you will have to press the Start key before dialing will begin. Refer to the “Setting Basic Features, Dial Parameters Settings” section of this handbook.

Your fax machine does not answer the phone or receive faxes.

- First make sure that your fax machine is turned on and the power cord is connected to the AC outlet.
- If you have a handset connected to your fax machine, check that there is a dial tone on the phone line.
- Check the reception mode you are using. Your fax machine will not automatically receive faxes in manual answering mode [TEL]. In TAD mode, the answering machine answers the call first. Refer to the “Setting Basic Features, Answering Mode” section of this handbook.

Your received documents are light or have vertical streaks on them and you are not out of toner.

- First, print a cleaning page. Press the Select Function key, then press the 10/Msg. Print from Memory key, then press the Yes ◀ key.
- If that doesn't help, gently wipe the lens surface of the LED array with a soft pad moistened with rubbing alcohol, and then see if the machine works properly. Refer to the “Problem Solving, Replacing the Toner Cartridge” section of this handbook.

- If your fax machine still does not work properly, remove the image drum unit. Refer to the “Problem Solving, Working with the Image Drum Cartridge” section of this handbook. Tap the toner cartridge and replace the assembly.
- If this does not work, you may need to replace your image drum cartridge.

You set your fax machine for delayed transmission but it did not send.

- Check the display to make sure that you have set the clock to the correct time. Refer to the “Setting Basic Features, Changing the Date and Time” section of this handbook.

Your fax machine disconnected before you could answer a voice request.

- You must answer a voice request while the warbling tone is sounding. When you hear the warbling tone, press the Voice Request key after picking up your handset.

Your fax machine will not poll a remote fax machine.

- Call the person at the remote fax machine and make sure that they have loaded documents and set their fax machine in polling transmission mode.

Someone tried to send you a confidential fax but nothing happened.

- You must set up a personal (confidential) mailbox before anyone can send you a confidential fax. Refer to the “Advanced Operations, Confidential Faxes (Security Feature)” section of this handbook.
- Make sure the person sending you the fax knows the correct mail box number.

Your fax machine is connected to a PBX and you cannot dial out.

- You must enter your access digit to reach an outside line before the telephone number for each number that you dial or program into your machine. Also, your fax machine must be programmed for PBX operation before it will work. Refer to the “Setting Basic Features, Connecting to a PBX” section of this handbook.

You want to answer an external telephone but your fax machine always answers first.

- If you are using an external telephone, change your fax machine’s incoming ring response setting (User Function 11). Refer to the “Setting Basic Features, User Function Settings” section of this handbook.

Your received faxes sometimes look distorted.

- If the document received is wider or longer than the paper you have loaded into your paper tray, your fax machine automatically reduces the length of the document to fit on your paper.
- This type of problem could also be communication related.

You are constantly receiving unsolicited advertising on your fax machine.

- Try using User Function 08, Closed Network Function. Refer to the “Setting Basic Features, User Function Settings” section of this handbook.

Your fax machine does not immediately switch to TEL mode when you make or receive a voice call.

- Try pressing the Stop key. Your fax machine will return to standby mode so that you can converse.
- This condition may happen infrequently due to telephone line conditions, or the type of external telephone used. Check the physical line connections (wall outlet and cord). If this problem happens often, call your Authorized OKIFAX Dealer for service.

You are experiencing problems communicating with a remote location in a very noisy telephone area.

- Set up a One Touch key for that location and try turning Echo Protection on for that One Touch key. This helps the machine overcome noise and echo problems on the phone line.

To do this;

- 1 Press the Select Function key.
- 2 Press the 9/User Program One Touch key.
The display shows
1:FUNC. PROGRAMMING.
- 3 Press the Yes ◀ key.

The display shows
FUNCTION NO. [].

- 4 Using the numeric keypad, enter 23.
The display shows

23:ONE TOUCH PARAM
YES [OT] NO[▶].

- 5 Press the One Touch key for the location whose settings you want to change.
The display shows

ECHO PROTECTION, [OFF].

- 6 Press the No ▶ key to switch Echo Protection on.
- 7 Press the Yes ◀ key to confirm your selection.
The display shows

23:ONE TOUCH PARAM. [].

- 8 Press the Select Function key to finish.

- *Change the Echo Protection setting to off if you change the location the One Touch key is used for.*

Firmware

Firmware is a category of memory chips that hold their content without electrical power and include ROM, PROM, EPROM and EEPROM technologies. Firmware becomes “hard software” when holding program code.

This “hard software” is kept in semi-permanent memory. It will not be forgotten when the power is shut off. Firmware programs can be altered, and are frequently revised.

An EPROM is typically erased by using intense ultraviolet light.

Identifying Your Current Firmware Version

You may be asked for the firmware version number if you call for service. Your Authorized OKIDATA Service Dealer will work with you to identify the firmware version of your fax machine.

Upgrading Your Firmware

Consult the store location where you purchased your fax machine, or call 1-800-654-3282 (1-800-OKIDATA) for the location of the nearest Authorized OKIDATA Service Dealer.

Serial Number of Your Fax Machine

The serial number of your fax machine is on a label on the side or back of your fax machine.

The label will say “S/N”.

An example serial number is: 401A0154693.

Security

Confidential Faxes

Fax machines are often placed in public places where everyone can look through the received faxes. If you are communicating with another Oki fax-capable unit, you can use the confidential fax feature. The receiving machine will store the message in a personal (confidential) mailbox (in the machine's memory) and will not print it until a password is entered. This is an exclusive Okidata feature; you cannot use it with another manufacturer's fax machines.

- ! *To send a confidential fax, you must know in advance the mailbox the message should be sent to. Ask the person who will receive the fax to tell you their mailbox number.*

For more information on working with Confidential Faxes, refer to the "Advanced Operations, Confidential Faxes" section of this handbook.

Rejecting Unsolicited (Junk) Fax Messages

Closed Network Option

The closed network option lets you set your fax machine to only transmit faxes to or receive faxes from locations programmed into One Touch keys or Auto Dial numbers. You can also set it to receive faxes only from those programmed locations. This is one way of reducing the number of unsolicited faxes you receive, such as advertisements.

To use the closed network function, follow the instructions below.

- 1 Press the Select Function key.
- 2 Press the 9/User Program One Touch key. The display shows

1:FUNC. PROGRAMMING.

- 3 Press the Yes ◀ key. The display shows

FUNCTION NO. [].

- 4 Using the numeric keypad, enter 08. The display shows

08:CLOSED NETWORK nnn

Where nnn is the current setting of this function.

The settings are: RX, T/R, or OFF

- 5 Press the No ▶ key until the setting you want appears in the display.
RX: limits reception only.
T/R: limits both transmission and reception.
OFF: no limits on transmission or reception.
- 6 Press the Yes ◀ key to confirm the new setting.
- 7 Press the Select Function key to finish.

Safety

Installation Hints

- Install your fax machine in a dust-free location away from direct sunlight.
- Do not plug your fax machine into a power source shared by equipment that produces electrical noise (i.e., air conditioners, etc.).
- Leave electronic adjustments to authorized service personnel.
- The LINE terminal connects your fax machine to a standard telephone line. To avoid damage to your telephone system or to the fax machine, do not plug your fax machine into anything other than a standard RJ-11C jack.
- Your fax machine is designed to be grounded electrically and is equipped with a three-wire grounded power cord. For your safety, do not attempt to defeat your power cord's grounding plug.
- The power outlet should be located near the equipment and should be easily accessible.
- The TEL port on the back of the unit is only suitable for two-wire devices. Not all standard telephones will respond to incoming ringing when connected to an extension socket.
- This equipment may not necessarily provide for the effective hand-over of a call from a telephone connected to the same line.

Operation and Maintenance

- Use a dry cloth to clean the control panel and the main body of the unit.
- Aside from replacing the toner and image drum cartridge, do not disassemble or attempt to service this unit yourself. Refer to a qualified technician for service.
- Pull out the AC plug before trying to remove any objects that may have fallen into the machine.
- If the unit becomes physically damaged, disconnect the power cord immediately and arrange for its repair or disposal.
- When relocating your OKIFAX, always disconnect the telephone line before disconnecting the power cord, then reconnect the power cord first.
- This unit is not designed to be used in parallel with any other telephone devices.

Handling the Consumables

Toner Cartridge

- Leave unused toner cartridges in their packages until needed.
- When replacing a toner cartridge, re-use the packaging to dispose of the old toner.
- Be careful when removing the toner cartridge. Do not let it touch your clothing or porous materials. The toner powder causes permanent stains.
- Small amounts of toner spilled on skin or clothing can be readily removed with soap and cold water. Using heated water will make removing the stain much more difficult.

Image Drum Cartridge

- Leave unused image drum units in their packages until needed.
- When replacing an image drum unit, re-use the packaging to dispose of the old image drum unit.
- Do not expose these components to light for more than five minutes.
- Never expose the green drum (inside the image drum unit) to direct sunlight.
- Always hold the image drum unit by the ends, never by the middle.
- Never touch the surface of the green drum inside the image drum unit.
- Small amounts of toner spilled on skin or clothing can be readily removed with soap and cold water. Using heated water will make removing the stain much more difficult.

Emergency First Aid

If toner is swallowed

Dilute by giving two glasses of water and induce vomiting by administering Syrup of Ipecac (follow the manufacturer's instructions). Seek medical attention. Never attempt to induce vomiting or give anything by mouth to a person who is unconscious.

If toner is inhaled

Take person to an open area for fresh air. Seek medical attention.

If toner gets in the eyes

Flush eyes with large quantities of cool water for 15 minutes, keeping eyelids open with fingers. Seek medical attention.

For more information

Refer to the Material Safety Data Sheet in the "Warranty, Regulatory Information, and Specifications" booklet

Service and Support

Much of this information is valid for the United States and Canada only.

Okidata is firmly committed to the satisfaction of our customers. If you have a problem that your customer documentation cannot solve, contact these sources for service or support:

Your Dealer

Consult the store location where you purchased your fax machine, or call 1-800-654-3282 (1-800-OKIDATA) for the location of the nearest Authorized OKIDATA Service Dealer.

- Prices and minimum charges may vary.
- Proof of purchase is required for warranty work. Be sure to retain your purchase documents.

Okidata on the Internet

For the latest product information answers to common questions, and other support, visit Okidata's Web site:

<http://www.okidata.com>

Contacting Okidata Customer Support

For quick answers to commonly asked questions, call 1-800-654-3282 (1-800-OKIDATA), United States and Canada only. Please be sure that you are calling from a telephone close to your fax machine, so you can describe your problem accurately.

Okidata Customer Support is available 24 hours a day, 7 days a week (United States and Canada only). The system can provide immediate assistance with:

- Basic Operating Procedures
- Sales and Service Referrals
- Parts and Consumable Referrals
- Product Information

! *Customer Service Representatives are not trained to provide assistance with the use of commercial software packages. Please consult your application's manual for availability of their support.*

Purchasing Supplies and Options

Before you order, have the correct part number and description of the item.

- Consult the Authorized OKIFAX Dealer where you purchased your fax machine.
- Call 1-800-654-3282 (1-800-OKIDATA) for the nearest Authorized Sales and Service location.
- Check office supply catalogs or your local stationery store. Most carry Okidata brand supplies.

Supplies

- Toner Cartridge: Order Number 52106701.
- Image Drum: Order Number 56116901.

Options

- 1 MB Non-battery backup memory expansion card: Order Number 70029101.
- 2 MB Non-battery backup memory expansion card: Order Number 70029201.
- 1.5 MB Battery backup memory expansion card: Order Number 70031501.
- 2.5 MB Battery backup memory expansion card: Order Number 70031601.
- 4 MB Battery backup memory expansion card: Order Number 40231622.
- Second Paper Tray, model UST-550, with 500-page additional capacity: Order Number 70029401.
- Telephone Handset: Order Number 70031801.
- 33.6 K BPS Modem Upgrade: Order Number 40838501
- MFP Option Kit: Order Number 70035201

User Function Settings

User function settings allow you to customize the general operation of your fax machine. Refer to the following User Function Settings List to determine which settings you may need to change, then refer to the “Changing Your User Function Settings” part of this section to make the change.

User Function Settings List

01 MCF(SINGLE-LOC.)

This function automatically prints a Message Confirmation Report after each single-location transmission or polling transmission. The report provides information about the transmission. Refer to the “Reports, Message Confirmation Report” section of this handbook.

Available settings are ON and OFF (default).

02 MCF(MULTI-LOC.)

This function automatically prints a Message Confirmation Report after each multiple-location transmission. The report provides information about the transmission. Refer to the “Reports, Message Confirmation Report” section of this handbook.

Available settings are ON (default) and OFF.

03 ERR REPORT (MCF)

This function automatically prints a Message Confirmation Report every time an error occurs during a transmission or polling transmission operation. The report provides information about the transmission. Refer to the “Reports, Message Confirmation Report” section of this handbook.

Available settings are ON (default) and OFF.

04 IMAGE IN MCF

When a message confirmation of a memory transmission is printed, this function adds a portion of the first page of the document that was sent. This feature makes it easier to identify a fax, but it may present security problems if you are sending sensitive documents.

Available settings are ON (default) and OFF.

05 SENDER ID

This function controls the printing of your fax machine's Sender ID on the faxes you send. Refer to the "Programming Required Information, Fax Identification" section of this handbook for details. When turned on, the Sender ID will be printed on each page slightly outside the image area of your document.

The default setting is ON.

- ! *In order to meet FCC requirements, you must have this feature set to ON and have a valid Sender ID programmed in your fax machine.*

06 MONITOR VOLUME

This function sets the volume for telephone line monitoring during dialing.

Available settings are LOW (default), HIGH, and OFF.

07 BUZZER VOLUME

This function sets the volume of the various tones your fax machine emits during operation. Available settings are LOW, MIDDLE (default), and HIGH.

08 CLOSED NETWORK

This function allows you to program your fax machine to refuse to communicate with locations whose telephone numbers have not been programmed into your One Touch keys or Auto Dial locations. Using this function, you can set up a closed network of fax machines. Refer to the "Security, Rejecting Unsolicited (Junk) Fax Messages" section of this handbook. If you do not want your fax machine to transmit faxes to or receive faxes from locations outside your network, select T/R. If you only want your fax machine to refuse to receive faxes from outside your network, select RX.

Available settings are OFF (default), T/R, and RX.

09 TX MODE DEFAULT

Your fax machine is set for the STD (standard) resolution setting and the NORMAL contrast setting. If you consistently send faxes that require some other combination of transmission modes, use this function setting to change the default modes. While you are programming, the new default combinations appear on the lights above the Yes ◀ and the No ▶ keys. The default is STD/NORMAL.

10 T/F TIMER PROG.

When set to the telephone/fax answering mode, your fax machine automatically distinguishes between incoming voice and fax calls. If the incoming call is a voice call, fax machine rings to tell you to pick up the handset. If you do not answer, fax machine automatically switches back to fax mode to allow the calling party to send a fax. The T/F TIMER function controls how long it waits before switching back to fax mode.

Available settings are 20 SECONDS or 35 SECONDS (default).

11 RING RESPONSE

This function controls how long your fax machine waits before answering an incoming telephone call. The available settings are 1 RING (default), 5 SECONDS, 10 SECONDS, 15 SECONDS, or 20 SECONDS.

- ! *At the default 1-ring setting, your fax machine answers calls immediately, and you will not hear any ring. If you need to hear the ring, change to one of the other settings.*

12 DISTINCTIVE RING

Some telephone carriers offer a service called Distinctive Ring. Distinctive Ring lets you have different numbers on one line, each with its own distinctive ring. You can then use one number exclusively as a fax number without the expense of a second line. (Your local telephone carrier can provide you with more information about this service, which usually has an additional charge.)

Available settings are OFF (default) and ON.

- ! ***You must have your local telephone carrier's Distinctive Ring service. Your fax machine must be in FAX or PC answer mode, and the PBX dial parameter must be set to OFF. Other modes—TEL, TEL/FAX, or TAD—will override Distinctive Ring. This feature may not work properly if you have a telephone other than a genuine Oki optional handset connected to your fax machine.***

13 1'ST PAPER SIZE

This function allows you to specify the size of paper you are using in the paper tray.

Available settings are letter (default), A4, legal 13, legal 14, and OTHER.

14 2'ND PAPER SIZE

This function allows you to specify the size of the paper you are using in the optional second paper tray, and only appears if that option is installed. Refer to User Function Setting 13, 1'st Paper Size for details.

15 USER LANGUAGE

This function allows you to switch between the two languages programmed into your fax machine. Available settings are ENG. (English, the default) and SPA. (Spanish), FRE. (French), or POR. (Portuguese), depending on what fax machine language configuration you purchased.

16 INCOMING RING

This function controls the telephone ringing sound your fax machine makes when a call comes in. When set to off, it does not ring during incoming calls. The available settings are:

ON (default): Only rings when set to Manual Receive [TEL] mode or when the RING RESPONSE function is set to 5, 10, or 20 seconds.

OFF: Does not ring when a call comes in.

DRC (distinctive ring cancel): Rings for each incoming call with the same tone, even if you have set function setting 12, DISCTINCTIVE RING to on.

17 REMOTE RECEIVE

This function lets you use an attached phone to tell your fax machine to switch from telephone to fax mode so it can receive an incoming fax. Use the keypad of an external telephone to enter the remote receive number you have programmed into your fax machine.

In addition, if your fax machine is in TAD mode, a caller can enter the programmed remote receive number after leaving a voice message; this enables the fax machine to receive a fax from the caller.

Refer to the “Answering Mode, Using Your Fax with an Answering Machine [TAD]” section of this handbook. Available settings are OFF (default), 00, 11, 22, 33, 44, 55, 66, 77, 88, 99, **, and ##.

18 MEM./FEEDER SW.

The fax unit is set to scan documents in and transmit them from memory. This function controls how manual feed transmissions are performed. Available settings are FEEDER (the default setting) and MEMORY.

19 NOT USED

20 ECMFUNCTION

The error correction mode function may help your fax machine improve communication in areas where telephone line conditions are marginal. Refer to the “Problem Solving” section of this handbook for other suggestions if you have communication problems. Available settings are ON (default) and OFF.

21 REMOTE DIAGNOSIS

The remote diagnostics feature allows a service person remotely to dial and service your fax machine. Available settings are ON and OFF (default).

22 PC/FAX SWITCH

This function is active only when the optional PC interface is installed and your fax machine is set to the PC Fax answering mode. In that case, incoming faxes are saved directly to the PC's disk without being printed. If the PC is turned off or not functioning, the fax machine acts as a stand-alone fax machine and prints incoming faxes when this PC/FAX SWITCH function is set to ON (default). If this function is set to OFF, the fax machine will not accept incoming faxes when the PC is turned off or not functioning.

23 ONE TOUCH PARAM

This function allows you to activate the Echo Protection feature for a specific One Touch key, without changing the normal settings. Echo Protection can improve communication with a location in a noisy telephone area. For instructions on changing One Touch Parameters settings for a One Touch key, refer to the "Programming Your Speed Dial directory, One Touch Faxing" section of this handbook.

Changing Your User Function Settings

- 1 Press the Select Function key.
- 2 Press the 9/User Program One Touch key.
The display shows

1:FUNC. PROGRAMMING.
- 3 Press the Yes ◀ key. The display shows

FUNCTION NO. [].
- 4 Using the numeric keypad, enter the 2-digit number of the function you want to change. The display shows the name of the selected function.
- 5 Repeatedly press the No ▶ key until the setting you want appears in the display.

! *If you are changing the TX MODE DEFAULT settings, the new settings appear on the lights above the Yes ◀ and the No ▶ keys*
- 6 Press the Yes ◀ key to confirm your selection. The name of the next function setting appears in the display.
- 7 Press the Select Function key to finish.

Dial Parameter Settings

Dial Parameter Settings

These functions allow you to control the way your fax machine dials telephone numbers. Refer to the Dial Parameter Settings List below to determine which settings you may need to change, then refer to “Changing Your Dial Parameter Settings” part of this section to make the change.

Dial Parameter Settings List

1 REDIAL TRIES:

This function controls how many times your fax machine automatically redials a number that is busy or does not answer.

Available settings are from 0 to 10 tries.

Default: 3 tries.

2 REDIAL INTERVAL

This function controls how long your fax machine waits between each automatic redial attempt.

Available settings are from 1 to 6 minutes.

Default: 3 minutes.

3 DIAL TONE DETECT

This function allows your fax machine to wait for and detect a dial tone before proceeding with dialing.

Available settings are ON and OFF.

Default: OFF.

4 BUSY TONE DETECT

This function allows your fax machine to detect a busy tone when sending a fax.

Available settings are ON and OFF.

Default: ON.

5 MF(TONE)/DP (PULSE)

This function sets the dialing method. Use the MF setting for Touch-Tone dialing, or the DP setting for pulse dialing. Default: MF (TONE).

6 PBX LINE

Turn this function on if your fax machine is connected to a PBX (Private Branch Exchange—a phone system used to route internal calls). Once this function has been turned on and the access digit function has been programmed using the Dial Prefix parameter (below), your fax machine recognizes the access digit you use in your PBX to get an outside line. Refer to Dial Parameter 8, Dial Prefix function for more information.

Refer to the “Setting Basic Features, Connecting to a PBX” section of this handbook for instructions on changing this setting.

Available settings are ON and OFF.

Default: OFF.

7 AUTO START

When this function is turned on, your fax machine automatically dials as soon as you press a One Touch key or enter an Auto Dial code—you do not have to press Start.

Available settings are ON and OFF.

Default: ON.

8 DIAL PREFIX

If your fax machine is connected to a PBX, use this function to specify the access digit used to obtain an outside line from your PBX. You can enter a number with up to four digits. When this parameter is programmed, the fax machine recognizes the access digit when you enter a number and automatically pauses for an outside line before dialing the rest of the number.

Refer to the “Setting Basic Features, Connecting to a PBX” section of this handbook for instructions on changing this setting.

Available settings are ON and OFF.

Default: OFF.

Changing Your Dial Parameter Settings

- 1 Press the Select Function key.
- 2 Press the 9/User Program One Touch key.
- 3 On the numeric keypad, press 2. The display shows
2:DIAL PARAMETER.
- 4 Press the Yes ◀ key until the display shows the dial parameter you want to change.
- 5 Repeatedly press the No ▶ key until the setting you want appears in the display.
- 6 Press the Yes ◀ key to confirm your selection. The name of the next dial parameter setting appears in the display.
- 7 Press the Select Function key to finish.

Service Function Settings

In many cases, service function settings greatly change the way your fax machine operates. To change any of these settings, contact your Authorized OKIFAX Dealer.

Service Function Settings List

1 LONG DOC. SCAN

Normally fax machine does not scan documents longer than 14 inches (360 mm). When this function is on, your fax machine can scan and transmit documents of any length for up to one hour.

2 MDY/DMY

This function specifies how fax machine displays and prints the date: month/day/year or day/month/year.

3 TIME/DATE PRINT

This function specifies how the time and date are printed on the fax messages you transmit. Available settings are: do not print date and time, print date and time at the top of the first page only, and print date and time at the top of every page.

4 TSI PRINT

When this function is on, the phone number of the sending fax machine prints at the top of each page of the message.

5 NO TONER MEM.RX

When this function is on, your fax machine automatically receives messages in memory when it is low on toner.

Glossary

This glossary contains terms and words you may encounter when discussing or reading about fax machines and fax communications. Please use these definitions for reference only.

A4, B4, A3. Standard stationery sizes defined by the International Standards Organization, an agency of the United Nations. See also Paper sizes.

Auto Dial. Enables user to store preprogrammed telephone numbers in the unit's memory. Storage capability varies from unit to unit.

Automatic fallback. The ability of a fax machine, when communicating with another fax which is communicating at a slower rate, to slow down ("fall back") to the other unit's speed.

Automatic reduction. Many fax machines will automatically reduce documents being transmitted to accommodate the effective printing width of the receiving unit. This allows, for example, a fax machine with a 10" scanning width to send an image 10" wide to a unit with an 8.5" print width; the receiving fax machine will receive a reduced-size printout of the complete image.

Bits per second. See bps.

Black density. Also called black coverage. The amount of nonwhite area on a page. For example, most regular office correspondence has a black density well under 10%, due to the presence of margins, spaces between words, spaces between lines and paragraphs and even spaces within letters (such as e and o). However, drawings and photographs have a much higher black density, sometimes approaching 100%. The higher a page's black density, the more slowly a fax machine can send it.

bps. Bits per second. Used to express the speed of transmission of data. Because fax transmission treats a document as a graphic image rather than as a series of alphabetic and numeric characters, bps does not correspond to the number of characters transmitted per second.

Broadcasting. Sending one document to many different locations at the same time.

Byte. A group of digital elements, usually sent as eight bits to the byte.

Call reserve. Also called call request. An ITU-T standard fax feature, which allows a user to request voice communication prior to, during, or after transmission.

Call-waiting service. An optional telephone company service that identifies when another party is calling while one is already on the phone. Call-waiting signals often cause interruption of fax transmission or reception.

CCITT. See ITU-T.

CCD, CIS. Charged coupled device. The scanning mechanism used in some fax machines. The CCD “reads” fluorescent light bouncing off a document.

Compatibility. The term “compatible” describes the ability of separate things to function together. Your fax machine features ITU-T Group 3 compatibility, the modern standard for worldwide communication.

Confidential transmission. See Secure Mail.

Confirmation report. See RCR and TCR.

Continuous polling. See Polling.

Copy mode. Lets one use a fax machine as a convenience copier.

Cover page (automatic). A small, user-created message; can be the first page of every transmission.

Database polling. See Polling.

Data compression. Used in digital fax machines to speed transmission. See also Digital fax, MH and MSE, SMSE.

Delayed command. Transmission or polling operation set by the user to occur later, automatically, at a predetermined time. Great for reducing costs by making fax calls during times, such as late at night or on weekends, when telephone costs are lowest.

Digital. Using the binary system—i. e., either 0 or 1—to describe everything, so that 0 means off and 1 means on. Digital fax machines convert the graphic image of your document into a series of zeros and ones by using the binary system of transmission to encode black and white occurrences. This increases transmission speed by passing over white spaces. See also **White-line skip**.

Dual Access. Allows you to load and prepare to transmit (send) a document while your fax machine is receiving or sending another fax from memory.

Effective printing width. The widest image that can be printed on a fax.

Effective scan width. The maximum width the scanner in a fax can scan during transmission.

Fax (or fax). A form of communication involving the scanning and decoding of a document into electrical signals and transmitting of the document, over telephone lines to another device which then reconstructs the signals to produce an exact duplicate of the document. Also, a machine that performs such communication.

Fallback. Group 3 fax machines operate at the highest transmission speed possible on a given telephone line. Your fax machine features automatic fallback; if line quality drops during transmission, the fax machine will reduce speed to the fastest possible level.

Fine resolution. 203H x 196V lpi. Also shown as G3F (“Group 3 fine”) on some fax units.

Firmware. (1) A category of memory chips that hold their content without electrical power and include ROM, PROM, EPROM and EEPROM technologies. Firmware becomes “hard software” when holding program code.

(2) Software kept in semi-permanent memory. Firmware is used in conjunction with hardware and software. It also shares the characteristics of both. Firmware is usually stored on PROMS (Programmable Read Only Memory) or EPROMs (Electrical PROMS). Firmware contains software which is so constantly called upon by a computer or phone system that it is “burned” into a chip, thereby becoming firmware. The computer program is written into the PROM electrically at higher than usual voltage,

causing the bits to “retain” the pattern as it is “burned in.” Firmware is nonvolatile. It will not be “forgotten” when the power is shut off. Handheld calculators contain firmware with the instructions for doing their various mathematical operations. Firmware programs can be altered. An EPROM is typically erased by using intense ultraviolet light.

Grayscale. Not a level of resolution, but a method of scanning and transmitting halftone images. Fax machines with grayscale abilities interpret photographs in levels of gray between white and black. The transmitting fax machine must have grayscale ability to send a photographic image accurately, but the receiving machine does not need it to print the image.

Group 3. Refers to fax machines that use digital encoding. These units transmit one page in less than one minute and produce resolution of 203 x 98, 203 x 196, or 203 x 392 lpi.

Group Dial. Sending one fax to multiple locations. Document is scanned once, then transmitted to multiple locations using a combined list (group) of programmed numbers. Different from relay broadcasting, where one fax is sent to a remote machine. The remote machine then relays the fax to a group of fax numbers.

Halftone. See Grayscale.

Handshaking. A data interchange between telecommunications and/or computer equipment that “introduces” two systems to each other. For example, faxes use a handshaking protocol to identify the ITU-T group of each unit and to begin fax communication.

Hub. See Relay broadcasting.

Hz (or Hertz). A measure of frequency equal to one cycle per second. Used in the specifications for a fax machine, it identifies the AC power the unit requires.

ITU-T. International Telecommunications Union — Telecommunications Sector. (Formerly known as CCITT, for Consultative Committee for International Telegraph and Telephone.) A telecommunications forum for member countries of the United Nations; its Study Group XIV established the primary groups for fax equipment, covering communication protocol and transmission.

ITU-T Test Document 1. Also called the Slerexe (“Slehr-rehks”) letter; sometimes erroneously called ITU-T Test Chart 1. An ITU-T standard document with a known black density which fax makers often use in testing, and subsequently publicizing, the transmission speeds of their fax machines.

ITU-T V.29 and V.27 ter. A standard set of communication procedures allowing fax machines to talk to all other units adhering to those standards.

LCD. Liquid crystal display. Used on your fax machine to display information.

Leased line. See Private line.

Load number. A number assigned to telecommunications equipment used in Canada; designed to help prevent overloading on a telephone circuit. See also Ringer equivalence number.

Location ID. See Station ID.

lpi. Lines per inch. The way fax image resolution is measured. (For example, see Normal resolution.)

Mailbox. A password protected (secure) area of memory setup by a user for sending and receiving confidential faxes. Also referred to as confidential mailbox and personal mailbox.

MH. Modified Huffman, the standard ITU-T Group 3 data compression method. A one-dimensional coding scheme that compresses data in a horizontal direction only. A feature of your fax machine, MH assures transmissions faster than one page per minute when communicating with other Group 3 units, regardless of manufacturer. See also MSE, SMSE.

Modem. Modulator-demodulator. A device that converts digital data, like information from a fax machine, into an analog signal for transmission over ordinary (analog) telephone lines. A modem is included in a fax machine and allows it to be connected directly to a PSTN telephone line.

Monitor. A speaker in your fax machine that allows you to hear the dialing process. This is not a speakerphone, because it has no microphone for speaking to the person being called; for regular two-way voice communication, one must use the handset. See also On-hook dialing.

MSE, SMSE. Proprietary data compression methods, which allow your fax machine to transmit more quickly when communicating with another fax machine. See also MH.

Multifunction Printer (MFP). Device that takes on two or more functions generally associated with individual peripherals and combines these into one product or in a linked series of modules. A multifunction printer might combine a fax machine with a copier with a computer printer.

Multifunction Printer Option. Also known as the PC Interface Option. Connects a fax machine to a computer, allowing the user to work with both machines. Examples of use: saving incoming faxes to the computer's hard drive, using the fax machine as a backup printer.

Normal resolution. Shown as "norm"; 203H x 98V lpi. The default resolution mode for your fax machine.

One-touch dialing. Allows the fax user to store frequently used fax numbers for dialing with the touch of one key. See also Autodialing and Speed-dialing.

On-hook dialing. Dialing numbers by using the keypad on the fax unit without lifting a handset. On your fax machine, one can do this either silently or by using the monitor. See also Monitor.

Original document size. The largest (or smallest) document that can be fed safely through a fax machine.

Paper sizes. All are width x length

Letter-sized = 8.5" x 11.0" (216 mm x 279 mm)

Legal-sized = 8.5" x 14.0" (216 mm x 356 mm)

A5 = 5.8" x 8.3" (147 mm x 211 mm)

A4 = 8.3" x 11.7" (211 mm x 297mm)

A3 = 11.7" x 16.5" (297 mm x 419)

B5 = 7.2" x 10.1" (183 mm x 257 mm)

B4 = 10.1" x 17.0" (257 mm x 432 mm)

B3 = 14.3" x 20.3" (363 mm x 516 mm)

Passcode. A four-digit code-number. On your fax machine, the protection passcode lets the user limit access to fax operations in general, as well as certain settings and even documents readied for polling (in the latter case, only calling machines whose users enter the proper passcode will be able to poll the document.)

PBX (or PABX). Private branch exchange; privately-owned telephone equipment serving a particular building, business or area. Many PBX systems use digital transmission lines which, unlike more common PSTN lines, are not compatible with fax machine use. The user should not connect a fax unit to a PBX without first checking with the system manufacturer or service representative.

PC Interface. Also known as the Multifunction Printer Option (MFP). Allows you to connect a fax machine to a computer, and work between the two.

Polling. Automatic transmission to a calling remote fax, or reception of a document from a remote fax set for this operation. Polling is convenient whenever a central unit must receive information from one or several remote faxes. The caller bears all telephone charges and prevents several remote units from calling at the same time. In database or bulletin polling, a remote fax machine polls a document directly from the memory of another fax machine. (Regular polling requires the document to be physically in the polled fax's feeder.) See also Secure polling.

Private Line. Also known as a leased line. A service offered by many telephone systems; provides an exclusive phone circuit between two geographic points. Most fax machines do not require a private line. See also PSTN.

Proprietary. Non-standard. In fax, refers to a fax feature which works only in communications between same-branded fax machines.

PSTN. Public switched telephone network; the most common type of telephone lines and service in use, in contrast to private or leased lines. Most fax machines provide fast, reliable data transmission over a PSTN line, and do not need a special or dedicated telephone line. See also Private line.

RCR. Receive confirmation report. An RCR is your assurance that the document you transmitted was received. The RCR prints after your transmission, identifying the receiving unit and recording the date, time, transmission mode, number of pages sent and the result. The RCR is available only when your fax machine transmits to another fax machine of the same make and model. See also TCR.

Receiver ID. See Station ID.

Redialing. The dialing again, either manually or automatically controlled, of the most recently dialed fax or phone number. Automatic redialing follows an unsuccessful dialing attempt.

Relay broadcasting. Lets your fax machine store a document in internal memory, transmit the document to the memory of a remote fax machine, and then instruct that unit to relay (i. e., re-transmit) the document to each fax in a call group in the “hub” unit. This feature speeds extremely high-volume fax communication and allows a single command to initiate document transmission to hundreds of pre-programmed fax locations; also saves phone charges for the originating machine. Your machine can either serve as a “hub” unit or initiate a relay broadcast.

Remote fax machine. The machine on the other “end” of a fax communication.

REN. See Ringer equivalence number.

Resolution. The resolution of documents transmitted or copied by fax machines is measured by the number of horizontal (H) and vertical (V) lines per inch (lpi) the unit can print.

Your fax machine offers these resolution levels:

Normal 203H x 98V lpi

Fine 203H x 196V lpi

Superfine 203H x 392V lpi

Your fax machine also offers grayscale transmission (see also Grayscale) for accurate reproduction of photographs and other shaded originals.

Ringer equivalence number. Also called REN. A number assigned to telecommunications equipment used in the United States; designed to prevent overloading on a telephone circuit. See also Load number.

Scanning width. See Effective scanning width.

Secure Mail. Allows a fax user to send a document (usually something confidential) to, or receive one into, an “electronic mail box.” The transmission is protected at the receiving fax machine by an access code. The receiving fax prints the document only when an authorized user enters the code.

Secure Polling. Polling in which preset passcodes are checked between two machines before polling is allowed to take place.

Speed-dialing. Allows the fax user to store frequently used fax numbers for dialing with the touch of three keys—an identifier key (either * or #) and then a two-digit code—for each number. See also Autodialing and One-touch dialing.

Station ID. Also called Location ID or Receiver ID.

An autodialer feature which lets the fax user enter a descriptive name to correspond with the number in an autodialer entry. For example, rather than entering only 1-215-555-3465, one can enter that number and a name, such as Philly Branch Office.

Subscriber ID. A fax machine's telephone number, as identified by a user setting. See TTI.

Superfine resolution. 203H x 392V lpi. Your fax machine's superfine transmission mode is Group-3-compatible, not the more limited proprietary version.

TCR. Transmit confirmation report; this provides proof that your fax machine did send the document you set for transmission. Printed after transmission, the TCR also identifies the telephone number to which the fax sent the document, plus the actual time of transmission and how many pages the unit transmitted. See also RCR.

Thermal (paper) Printing. A thermal head heats chemically treated, thermally sensitive paper in patterns conforming to the image the machine has scanned, creating a printed image. Thermal paper's tendency to discolor and fade, in addition to its curliness and the usual difficulty in writing on it, have made this method considerably less popular than plain-paper fax printing—particularly as plain-paper fax machines have dropped sharply in price.

TTI. Transmit terminal identifier. A user-programmable line of information sent automatically with every page a fax machine sends; it appears at the top of each page printed by the receiving unit.

Transmission Speed. How fast a fax machine is sending a fax document. This speed depends upon the modem speed of each unit, the resolution setting, the content of the document, the encoding technique and the condition of the phone line (clean, noisy, etc.) Any change in any one of these five conditions will affect the speed, perhaps significantly.

White-line Skip. A technique used to speed up fax transmission by bypassing redundant areas, such as white space.

Index

Symbols

- 1'st paper size setting, 47
- 2'nd paper size setting, 48

A

- Activity report, 111–112
- Add to a group, 88
- Alarm indicator, 36
- Answering machine, use with, 56
- Answering mode, 54–56
 - changing, 54
 - options, 55–57
 - setting, 54
- Auto dial faxing, 79–80
- Auto dial key, 34
- Auto rec key, 33
- Auto receive mode, 55
- Auto start, 52

B

- Broadcast confirmation report, 112–113
- Broadcast entry report, 113
- Broadcast feeder key, 37
- Broadcasting, 85–86
 - performing a broadcast operation, 85–86
- Bulletin polling, 104
- Busy tone detect, 51
- Buzzer volume, 45, 59

C

- Call back number, 26
- Call forwarding, 108
- Call parameters, 57–59
- Canceling messages in memory, 70
- Chain dialing, 78–79
- Change drum soon message, 132
- Cleaning page, 127
- Closed network, 45
- Closed network option, 70–72, 148–149

- Codes
 - communication, 121
 - result, 122
- Communication codes, 121
- Computer connections, 41
- Confidential faxes, 98–103, 148
 - printing, 103
 - receiving, 102
 - sending, 102
- Confidential reception report, 114
- Confidential TX key, 38
- Configuration report, 114–116
- Configuration report, 43
- Confirming results, 66
- Connecting to PBX, 60–62
- Connections
 - answering machine, 22
 - computer, 41
 - external handset option, 23
 - external telephone, 22
 - power, 24–25
 - telephone line, 22
- Control panel, 32–36, 42–43
- Copy
 - number of copies, 81
 - resolution, 81

- Copy key, 33
- Copying, 81–84
- Counter display key, 38
- Counters, print, 139

D

- Date display setting, 53
- Date, entering, 26
- Date/time print setting, 53
- Delayed transmission faxes, 94–98
 - canceling, 98
- Delayed TX key, 37
- Delete a group, 89
- Dial parameter settings, 51–54, 161–163
 - changing, 52
- Dial prefix, 52
- Dial tone detect, 51
- Dialing
 - chain, 78–79
 - real-time, 66
 - redialing, 66
 - search key, 66
- Distinctive ring, 57
 - setting, 57
- Distinctive ring setting, 46
- Document guides, 30
- Document jams, clearing, 123

- Document size, 62
- Document stacker, 15, 30
- Document table, 29
- Documents
 - loading, 63–65
 - multiple page, 63
 - preparing for faxing, 62–64
- Drum counter, resetting, 136
- Dual access, 40, 109–110

E

- Emergency first aid, 19
- End of session tone, 39
- ERR report, 44
- Error correction mode setting, 49
- Error messages, 137–147
- Error tones, 39

F

- Fax forwarding mode, 56
- Fax ID, 27
- Fax identification, 26
- Fax on demand, 106
- Fax/telephone auto switch mode, 55
- Faxes
 - confidential, 98–103, 148
 - delayed transmission, 94–98

- Faxing, auto dial, 79–80
- FCC telephone consumer protection act, 25
- Features, 10, 11
- Firmware, 147
- First paper size, 60
- Function settings
 - changing, 50–51
- Function settings, 155–160

G

- Glossary, 165–174
- Group faxing, 87–89
- Groups
 - sending to, 89
- Guides, document, 30

H

- Handset option, 11
- Hook/V. Request key, 34
- Hyphen key, 33

I

- Image drum cartridge, 31
 - handling, 132, 152
 - order number, 154
 - replacement, 133–136
 - working with, 131

IMAGE IN MCF, 44
Incoming call parameters, 57–59
Incoming ring, 57
Incoming ring setting, 48
Installation, 13–28

J

Jacks, 30
Jams, document, 123
Jams, paper, 124–127
Junk faxes, rejecting, 70–72

K

Keypad, 30, 35

L

Labels, one touch, 34
Language
 changing, 54
Language setting, 48
LED printhead, 31
LEDs, alarm, 36
Loading documents, 63–65
Loading paper, 20–21
Location program key, 38
Long document scan setting, 53

M

Mailboxes
 creating, 98–99
 deleting, 101
 personal, 103
Maintenance, 151
Manual paper feeder, 82–84
Manual receive mode, 55
MCF settings, 44
Memory expansion options, 11
Memory messages
 cancelling, 70
Memory reception mode, 56, 69
Memory/Feeder setting, 49
Message confirmation report, 116–118
Message print from memory key, 39
Messages, error, 137–147
MFP option, 12
Modem upgrade, 12
Monitor volume, 45, 59
Multifunction printer option, 41
Multiple page documents, 63

N

No key, 35
No paper reception, 69
No toner memory receipt setting, 53

O

- Off hook alarm tone, 39
- Okidata customer support, 153–154
- One touch
 - keypad, 29, 34, 37–39
 - keys, programming, 37
 - labels, 34
 - parameters, setting, 50
- One touch keys
 - programming, 73–76
 - using, 76
- Options, 11, 154
- OTHER setting, 60

P

- Paper
 - full mark, 21
 - jams, clearing, 124–127
 - loading, 20–21
 - manual feeder, 82–84
 - path icon, 29
 - tray, 30
- Paper size settings, 60
- Parameters
 - incoming call, 57–59
- Password, changing, 99–100
- Pause key, 36
- PBX line, 52
- PC mode, 56
- PC/fax switch, 59
- PC/FAX switch setting, 50
- Personal mailboxes, 98–99, 103
- Phone directory, 118
- Plus key, 36
- Polling, 104–107
 - bulletin, 104
 - cancelling, 105
 - opening a personal box, 106
 - reception, 105
 - standard, 104
- Polling key, 38
- Polling transmission, 104
- Power failures, 71
- Power outage report, 119
- Power switch, 30
- Preparation
 - transmit, 107
- Preparing documents for faxing, 62–64
- Print counters, 139
- Printhead. LED, 31
- Printing
 - cleaning page, 127
- Private Branch Exchange. *See* PBX

- Problem checklist, 140–146
- Problem solving, 123–147
- Programming, 43
 - date and time, 26
 - fax ID, 27
 - groups, 88–89
 - one touch keys, 73–76
- Programming shortcuts, 67–68
- Pulse/Tone selection, 51

R

- Real-time dialing, 66
- Receiving faxes, 68–71
 - in memory, 69
 - manually, 68–69
- Reception
 - no paper, 69
- Redial interval, 51
- Redial key, 34
- Redial tries, 51
- Redialing, 66
- Relay
 - broadcast, initiating, 92–93
 - broadcast report, 91
 - initiating station, 91
 - key station, 91

- Relay faxing, 90–93
- Relay initiate TX key, 38
- Remote diagnosis setting, 50
- Remote receive, 59
- Remote receive setting, 48
- Report print key, 38
- Reports, 111–122
 - activity, 111–112
 - broadcast confirmation, 112–113
 - broadcast entry, 113
 - codes, 121–122
 - confidential reception, 114
 - configuration, 114–116
 - message confirmation, 116–118
 - phone directory, 118
 - power outage, 119
 - printing, 120–121
- Resetting drum counter, 136
- Result codes, 122
- Results confirmation, 66
- Ring, incoming, 57
- Ring response, 57
- Ring response setting, 46

S

- Safety, 150–152
- Safety information, 13
- Search, 88
- Search key, 33
- Search key dialing, 66
- Second paper size, 60
- Security, 148–149
- Select function key, 33
- Sender ID, 26, 44
- Sending a fax
 - single location, 64–68
- Serial number, 31, 147
- Service and support, 153–154
- Service function settings, 53–54, 164
 - changing, 53
- Signal tones, 39
- Single location faxes, 64–68
- Space key, 36
- Speed dial keypad, 37–39
- Stacker, document, 15, 30
- Standard polling, 104
- Start key, 36
- Stop key, 36
- Stopping a transmission, 67

T

- Telephone/fax auto switch mode, 55
- Telephone/fax timer program, 45
- Time, entering, 26
- Time/Date print setting, 53
- Tone key, 35
- Tone/Pulse selection, 51
- Toner cartridge, 31
 - handling, 19, 131, 151
 - installation, 17–19
 - order number, 154
 - replacement, 128–131
- Tones, signal, 39
- Transmissions, stopping, 67
- Transmit mode default, 45
- Transmit preparation, 107
- Transmit resolution key, 35
- TSI print setting, 53
- Type of original key, 35

U

- Unique key, 35
- Unpacking, 14–15
- Unsolicited faxes, 70–72

User function settings, 43, 44, 155–160
 changing, 50–51
User language
 changing, 54
User language setting, 48
User program key, 38

V

Voice request, 72
 answering, 72
 initiating, 72
Voice request key, 34
Voice request tone, 39

Y

Year 2000, 10
Yes key, 35

Free Manuals Download Website

<http://myh66.com>

<http://usermanuals.us>

<http://www.somanuals.com>

<http://www.4manuals.cc>

<http://www.manual-lib.com>

<http://www.404manual.com>

<http://www.luxmanual.com>

<http://aubethermostatmanual.com>

Golf course search by state

<http://golfingnear.com>

Email search by domain

<http://emailbydomain.com>

Auto manuals search

<http://auto.somanuals.com>

TV manuals search

<http://tv.somanuals.com>