

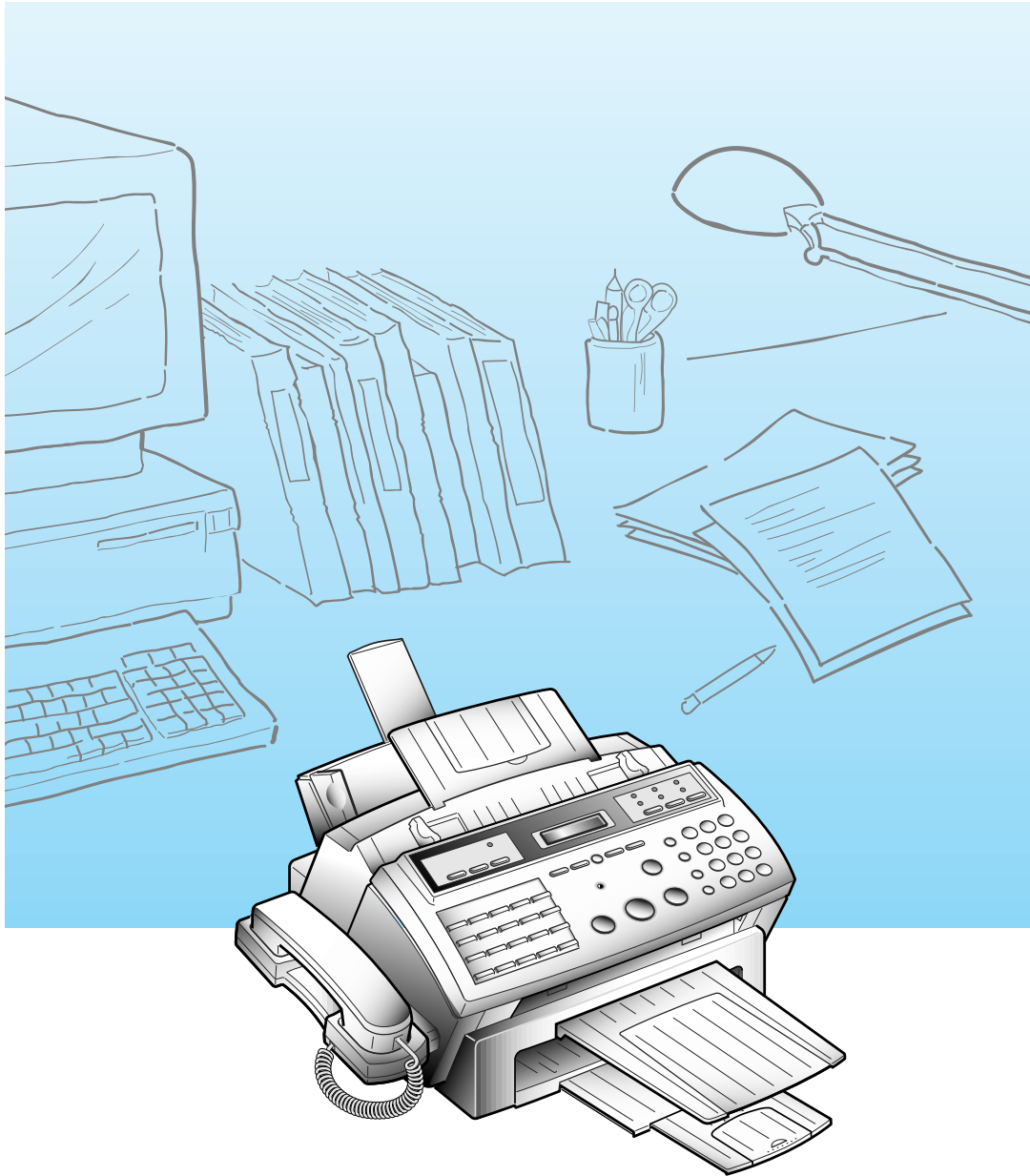

Operator's Guide
SAMSUNG FACSIMILE
SF4000/SF4100/SF4200

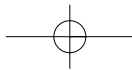

Please read this guide before you use this equipment.



Thank You for Choosing Samsung

Thank you for choosing Samsung! Your new machine represents the very latest technology. It is a full-featured, high-performance machine built to strict quality standards set by Samsung—the highest in the industry. We're proud to offer you a product that will provide convenient, dependable service for years to come.

Important Safety Information



Always be careful when using the machine. To reduce the risk of fire, electrical shock, and other injuries, keep these safety considerations in mind when installing, using, and maintaining your machine:

- **Stability.** Place the machine on a secure, stable surface. The machine can cause serious damage if it falls.
- **Power Supply.** Provide the correct power to the machine, as listed on its back. If you aren't sure of the type of power that's supplied to your home or office, call your electric company.
- **Grounding.** If the plug has three prongs, it must be plugged into a grounded (threehole) outlet. Grounded plugs and outlets are designed for your safety—don't try to make a three-prong plug fit into a two-prong outlet by modifying the plug or outlet in any way. If you can't insert the plug into your wall outlet easily, the outlet should be inspected by a qualified electrician.
- **Overload.** Don't plug too many electrical devices into a wall outlet or extension cord. An overloaded outlet is a fire and electrical shock hazard.
- **Cleaning.** Before cleaning the machine, unplug it from both the power outlet and the telephone jack. Clean exposed parts with a soft cloth slightly dampened with water. Don't use aerosol cleaners.
- **Thunderstorms.** Unplug electrical appliances during thunderstorms. Avoid using any telephone (except a cordless model) during a thunderstorm, since there's a small chance you could get an electrical shock from lightning.
- **Gas Leaks.** Never use any telephone close to a gas leak. If you think gas is leaking, call the gas company immediately, but use a telephone far away from the leak area. A small electrical spark in the telephone could cause a fire.

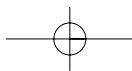
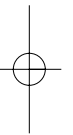
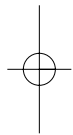

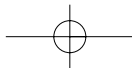

CONTENTS

► **Chapter 1 Your New Machine**

- List of Features 1.1
- Parts 1.2
 - Common Parts 1.2
- Familiarizing Yourself with Your New Machine 1.4
 - Front View 1.4
 - Rear View 1.5
 - Control Panel 1.6
- Fax Theory 1.8
 - Multi-function machine 1.9

► **Chapter 2 Installation and Setup**

- Choosing a Location 2.1
- Connections 2.1
 - Connection Diagram 2.1
 - Handset and Handset Cradle 2.2
 - Document Tray 2.3
 - Document Exit Tray 2.4
 - Printer Exit Tray 2.4
 - Telephone Line 2.5
 - Extension Phone (Optional) 2.5
 - AC Power Cord 2.5
- Loading Paper 2.6
 - Paper Type and Sizes 2.7
- Installing Print Cartridge 2.7
 - Print Cartridge Storage Unit (SF4100, SF4200) 2.10
 - Storing a Print Cartridge in the Storage Unit 2.10
- Running Self-Test 2.11
- Connecting to Your PC (SF4100, SF4200) 2.13
 - Connecting SF4200 to Your PC 2.13
 - Connecting SF4100 to Your PC 2.14
- Setting Up Printer (SF4100, SF4200) 2.15
 - Installing the Windows Printer Driver Software 2.15
 - Running Windows Printer Software 2.17
 - Installing the DOS Printer Software 2.19
 - Using the DOS Printer Software 2.20
- Making a Copy 2.21
- Setting the Date and Time 2.23
- Setting the Terminal ID (Your Name and Number) 2.25
 - Using the Keypad to Enter Letters 2.27
 - Keypad Character Assignments 2.28
 - Adjusting Ringer Volume 2.28
 - Selecting Tone or Pulse Service 2.28

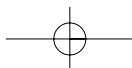

CONTENTS

► Chapter 3 Automatic Dialling

One-Touch Dialling	3.1
Storing a Number for One-Touch Dialling	3.1
Dialling One-Touch Number	3.3
Speed Dialling	3.4
Storing a Number for Speed Dialling	3.4
Dialling a Speed Number	3.6
Group Dialling	3.7
Storing One-touch or Speed Dial Numbers for Group Dialling	3.7
Using Group Dialling (Multi-address transmission)	3.9
Searching for a Number in Memory (Directory Dialling)	3.10
Searching Sequentially through Memory	3.10
Searching for a Particular First Letter	3.11

► Chapter 4 The Fax Machine

Sending a Fax	4.1
Acceptable Documents	4.1
Setting Document Resolution and Contrast	4.2
Loading Document	4.3
Using Quick Scan	4.4
Sending a Fax Automatically	4.4
Sending a Fax After Talking	4.5
Confirming Transmission	4.6
Cancelling Transmission	4.6
Automatic Redial	4.6
Receiving a Fax	4.7
Reception Modes	4.7
Receiving in FAX Mode	4.8
Receiving in TEL/FAX Mode	4.8
Receiving in ANS/FAX Mode	4.9
Receiving Manually (in TEL Mode)	4.9
Cancelling Reception	4.10
Using an Extension Telephone	4.11
Recording Area	4.11
Voice Request	4.12
Sending a Voice Request	4.12
Answering a Voice Request	4.13

► Chapter 5 Advanced Operations

Memory Transmission (Broadcasting)	5.1
Delayed Transmission	5.3
Polling	5.6
Being Polled By a Remote Machine	5.6
Polling a Remote Machine	5.8
Adding Documents To a Standby Operation	5.9
Confirming the Operation Number	5.9
Adding Document To a Standby Operation in Memory	5.10
Cancelling a Standby Operation	5.12

CONTENTS

▶ **Chapter 6 Special Features**

- Using REDIAL/PAUSE 6.1
- Using TONE (Switching from Pulse to Tone) 6.2
- Using FLASH (on a PABX system) 6.3
- Chain Dialling a Memory Number 6.4
- Help List 6.5
- Dual Access 6.5
- User Reports 6.6
 - Selectable Reports 6.6
 - Printing Reports 6.6
- User Options 6.8
 - Setting an Option 6.8
 - Selectable Options 6.9
- Clearing Memory 6.11

▶ **Chapter 7 Care and Maintenance**

- Cleaning the Document Scanner 7.1
- Printer Cartridge Maintenance 7.3
- Check Ink Level 7.3
- Run Nozzle Test 7.5
 - To run the nozzle test 7.5
- Wiping the Print Nozzles and Contacts 7.7
 - Cleaning the Cartridge Carrier Contacts and Deflector 7.8
- Replacing the Print Cartridge 7.10

▶ **Chapter 8 Troubleshooting**

- Clearing Jams 8.1
 - Document Jams During Transmission 8.1
 - When to Replace Parts for Automatic Document Feeding 8.1
 - Paper Jams During Printing 8.2
- LCD Error Messages 8.4
- Fixing Problems 8.7
 - Fax Problems 8.7
 - Print Quality Problems 8.9
 - Printing Problems 8.10
 - Paper Feeding Problems 8.11
- Specifications 8.12
 - General 8.12
 - Fax 8.12
 - Printer 8.13

Chapter One

YOUR NEW MACHINE

Chapter One

YOUR NEW MACHINE

This chapter will familiarize you with your new MultiJet machine.

► List of Features

Samsung's MultiJet machines were designed using the latest technology. The machines are full-featured, high-performance machines that not only meet, but exceed, industry standards. The following is a list of their many exciting features:

- Stand-alone, full-function plain-paper fax machine
- Convenient copier
- Single/multi-page copy up to 99 pages
- Multi-tasking capability
- 20 One-Touch and 50 Speed-Dialling locations
- Group Dialling
- Ring volume adjustment
- Choice of tone or pulse dialling
- Choice of four reception modes
- Transmission confirmation
- Memory/Delayed Transmission, Voice Request, and Polling features
- Extension telephone jack and external answering machine interface
- Special Help features
- Single/multi-redial features
- Printed reports and lists
- Quick Scanning
- High speed PC-printer features (for SF4100, SF4200)
- Windows driver supplied (for SF4100, SF4200)
- Printing support for DOS applications (for SF4100, SF4200)
- Powerful print quality enhancement technology (for SF4100, SF4200)
- True color printing (for SF4100, SF4200)
- TWAIN standard compatible PC-scanning feature (for SF4200)
- PC-faxing by class 1 interface (for SF4200)
- The bundled PC application package supplied (for SF4200)

YOUR NEW MACHINE

Parts

Once you have unpacked your MultiJet machine, check to make sure that you have all the parts shown here. If any piece is missing or broken, call your dealer.

Common Parts

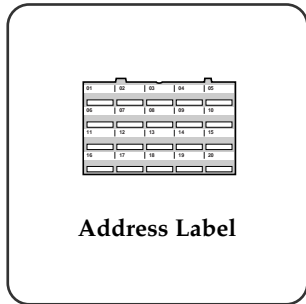
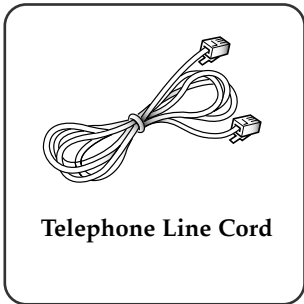
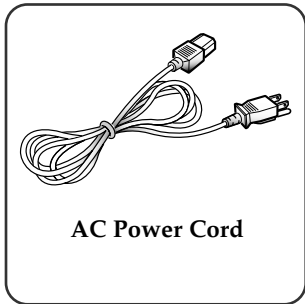
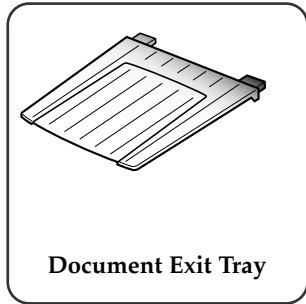
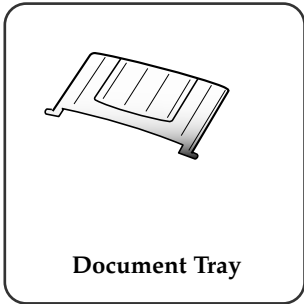
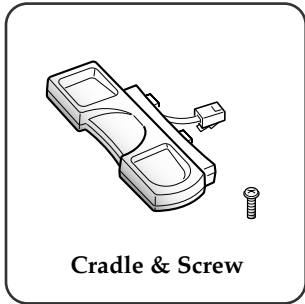
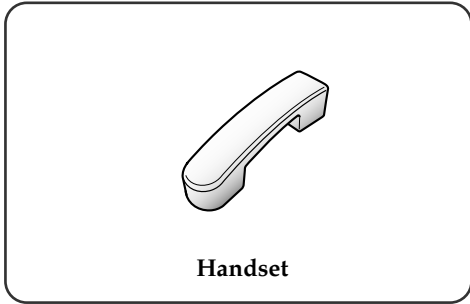
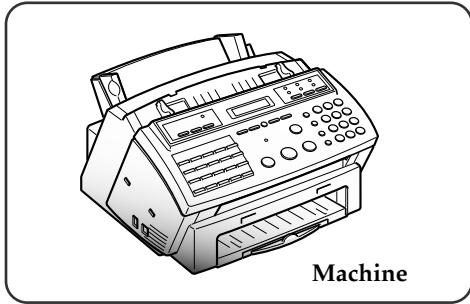

◀ The shape of power and telephone line cord plugs may differ, depending on your country.

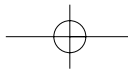

YOUR NEW MACHINE

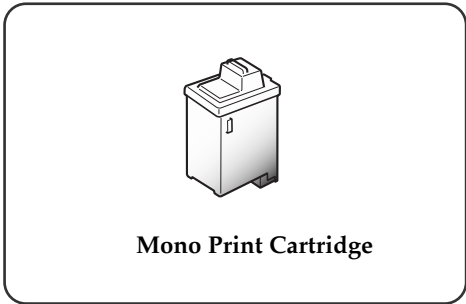
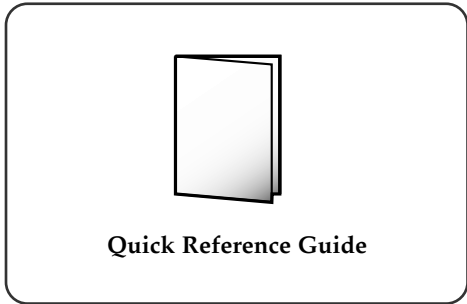
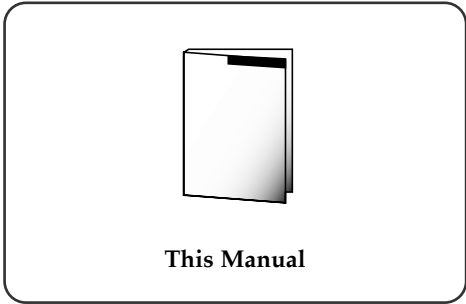
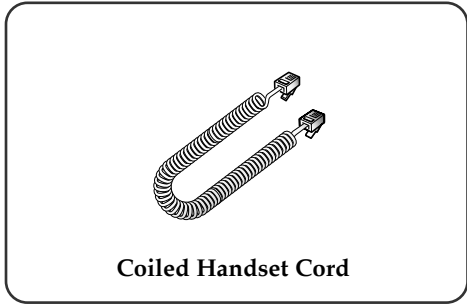

Others

- Color Print Cartridge (supplied for SF4200, option for SF4100)
- Printer Setup Diskette (supplied for SF4100, SF4200 only)
- Print Cartridge Storage Unit (supplied for SF4100, SF4200 only)
- WinFaxLITE Setup Diskettes (supplied for SF4200 only)
- Manual for WinFaxLITE (supplied for SF4200 only)
- Parallel Printer Cable (supplied for SF4100, SF4200 only)
- RS-232C Serial Cable (supplied for SF4200 only)

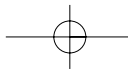

YOUR NEW MACHINE

Familiarizing Yourself with Your New Machine

Take a moment to familiarize yourself with your new machine by looking at the pictures on the next few pages.

Front View

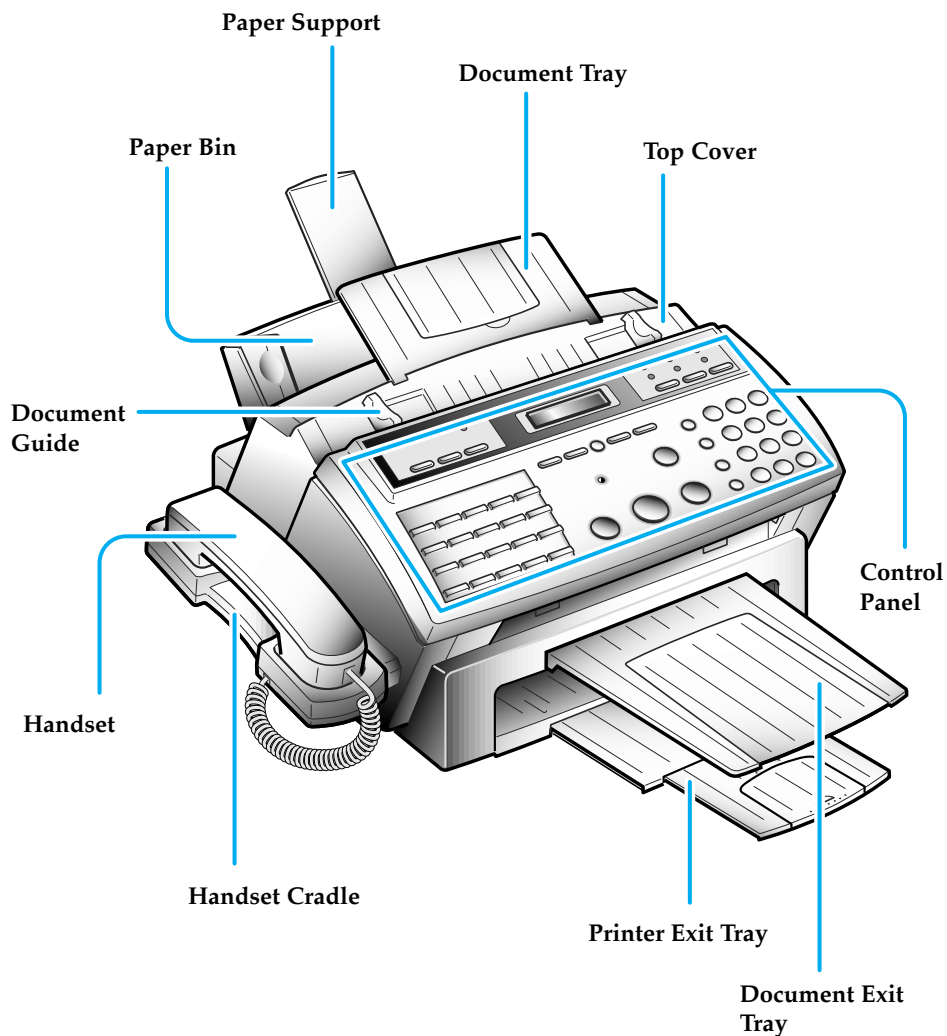

YOUR NEW MACHINE

Rear View

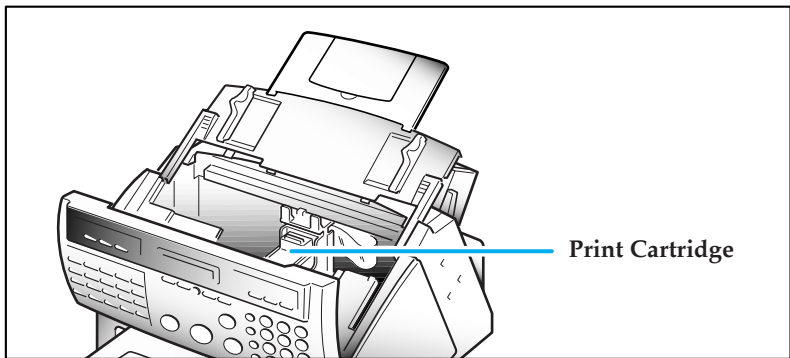
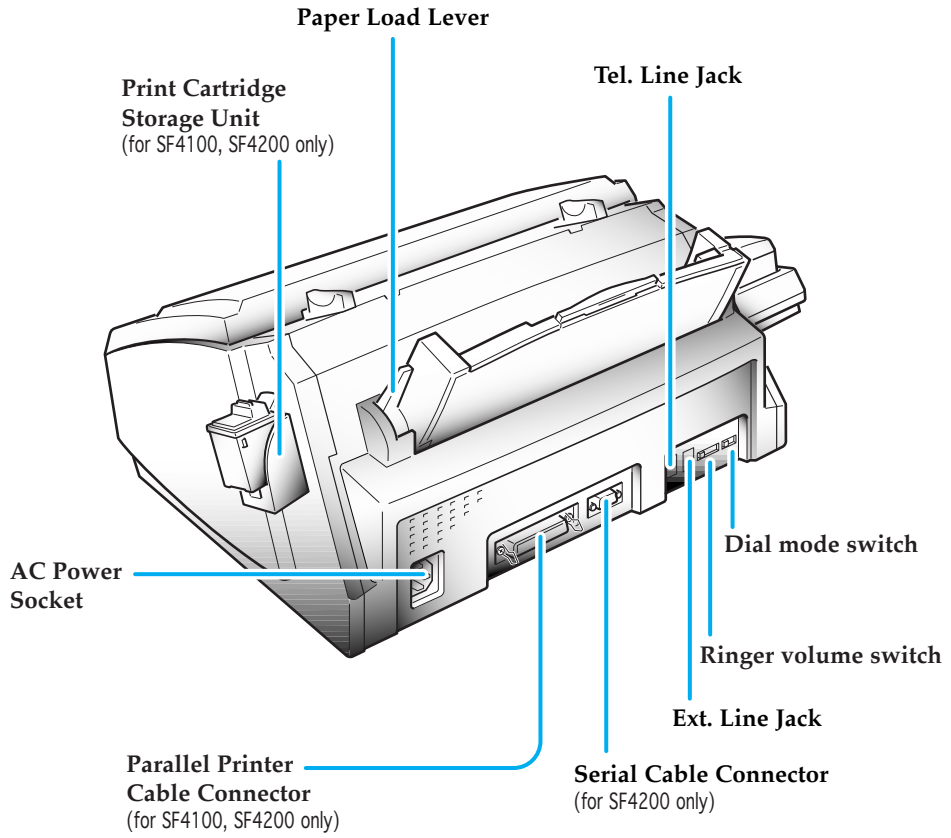

YOUR NEW MACHINE

Control Panel

BUSY Lamp*(for SF4100, SF4200 only)*

Lights while printing a PC file.

PRINTER RESET Button*(for SF4100, SF4200 only)*

Use to reset the machine from paper jam and catastrophic printer error.

CARTRIDGE Button

Use when replacing the print cartridge. This button permits you to position the print cartridge carrier so that you may easily remove or replace the print cartridge.

FORM FEED Button*(for SF4100, SF4200 only)*

Use to eject paper from the printer if the paper is not fed out after printing is completed. Also, use to load paper in place when the paper has run out while PC printing.

One-Touch Dial and special function Buttons

Use to call most frequently used numbers with one button. Also, use these buttons with MENU button to set special functions or print lists.

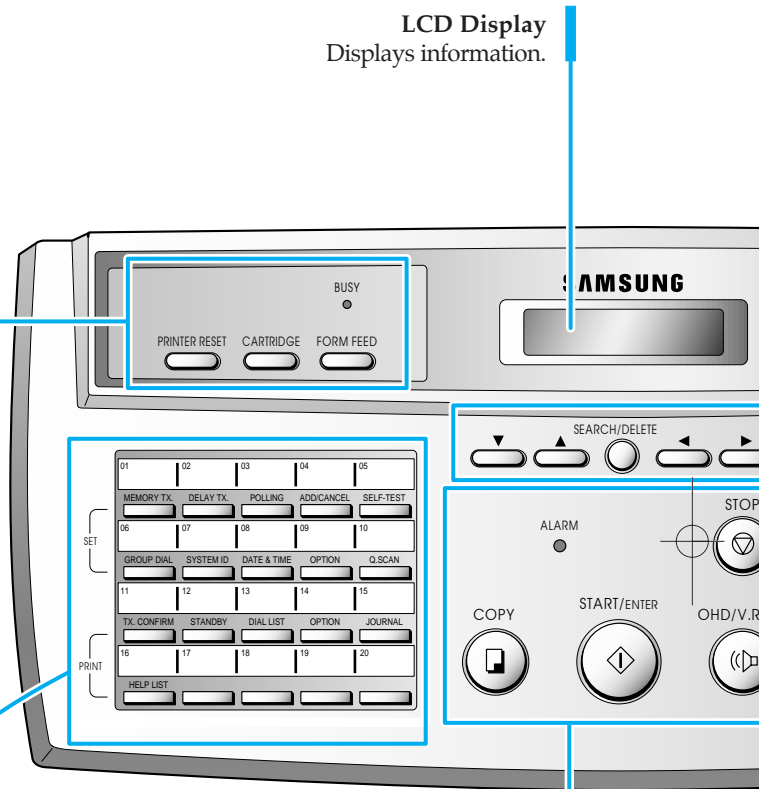
LCD Display
Displays information.**COPY Button**

Use to copy a document.

START and ENTER Button

Use to start a job. Also use to confirm the selection made in the display.

OHD (On-Hook Dial) and V.REQ (Voice Request) Button

Use to dial numbers without picking up the handset. Also use it to make a voice call after sending and receiving documents.

STOP Button

Use to stop an operation at any time.

ALARM Lamp

Lights when something is wrong during fax communication. It flickers when a printer error occurs.

YOUR NEW MACHINE

▼ and ▲ (down/up) Buttons

Use to display or the next or last menu item.

SEARCH/DELETE Button

Use to search for a number in memory.
Or use to delete digits in the edit mode.

◀ and ▶ (left/right) Buttons

Use to move cursor right or left through the display.

RCV.MODE (Receive Mode) Button

Use to choose which receive mode you want to use. The lamps will light up to show you which setting you have chosen. When both lamps light up, you are in ANS/FAX mode. When no lights are showing, you are in TEL mode.

RESOLUTION Button and Lamps

Use to choose the resolution. The lamps will light up to show you which setting you have chosen. When no lights are showing, you are in STANDARD mode.

CONTRAST Button and Lamps

Use to choose the contrast of copied or transmitted documents. The lamps will light up to show you which setting you have chosen. When both lamps light up, you are in PHOTO mode.

Number Keypad

Use to dial numbers manually.

* Button

Press to temporarily switch from pulse to tone dialling.

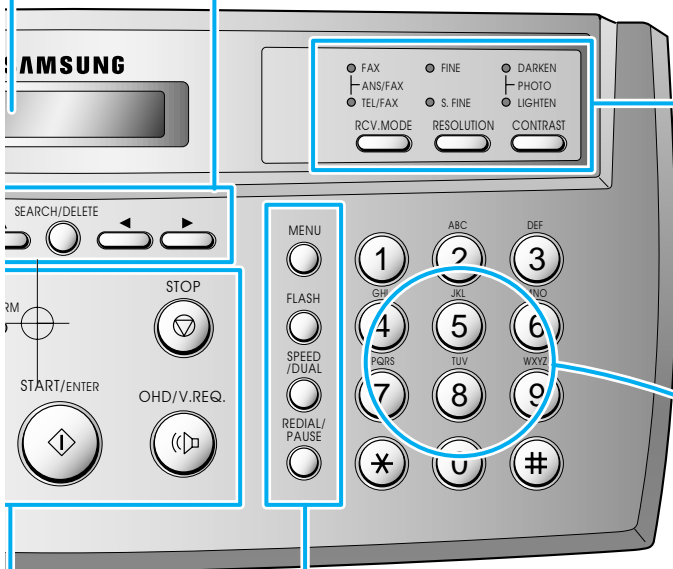

MENU Button

Use to choose special functions.

FLASH Button

Use this to transfer a call in a PABX (Private Automatic Branch Exchange).

SPEED/DUAL Button

Use to make calls and send documents by entering a 2-digit number. Also use it to confirm dual operation.

REDIAL/PAUSE Button

Use this to redial the last phone number you called. You can also use it to add a pause when you store a number in memory.

YOUR NEW MACHINE

Fax Theory

Thank you for your purchase of this SAMSUNG multi-function fax machine. We want you to get maximum use from your new equipment, therefore we would like to explain a little bit about FAX machines and how they work. This will help when reading the rest of this manual and becoming acquainted with FAX machines in general, plus all the features available with your new machine.

Most people don't realize it, but the fax machine has been around in various forms since the time of the invention of the telegraph in the mid-nineteenth century. Early fax machines were large, slow, and difficult to operate. Equipment and techniques for sending copies of documents across long distances have improved over the years, and today's fax machine is small, fast, and easy to operate.

A fax machine may appear complex, but in reality, modern fax machines are merely a combination of several very familiar machines.

First of all, faxing makes use of processes very much like an office copier. When you send a fax document to someone, the machine makes an internal copy of it (a *facsimile*, hence the term "fax"), and converts that copy to electronic signals which we call "data". The data is then sent out over the telephone line as a series of audible tones. When you receive a fax from someone else, the copy process simply converts these tones from the telephone line back to data, and then to printed output.

Fax machines depend very much on telephone technology, since they must dial telephone numbers, answer calls, and exchange fax data (their version of "speech") over the phone line with other fax machines.

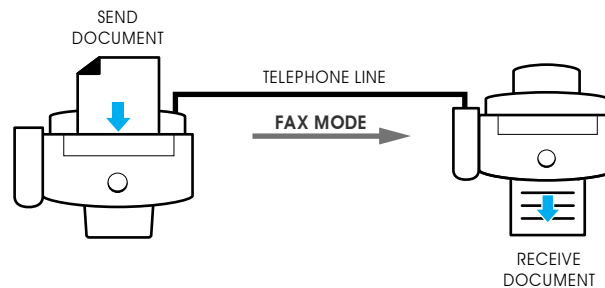

Basic FAX Operation

To send a fax document, you tell the fax machine the telephone number to call by entering the number on a Touch-Tone keypad, just like a telephone. You may also store frequently-called numbers in the machine's various memory locations. This makes dialling faster, more accurate, and allows your machine to "remember" telephone numbers for performing many automatic functions.

After dialling the number, the fax machine you are calling answers the call and, just as people do, the machines introduce themselves and make sure they have compatible features and speak the same "language" (fax engineers call this process "handshaking"). The machines also determine the quality of the sound over the telephone line and decide whether they should continue, or perhaps "talk" slower in the case of noise or low volume. They may even refuse to speak to each other and will hang up, rather than waste time when it is not possible to have a "conversation" (just like people!). In this case, they often try the call again later, when the telephone connection may be better.

YOUR NEW MACHINE

After a few seconds exchanging pleasantries (handshaking), the machines decide to get down to the business of the call: sending and receiving a fax document.

A fax document is one or more sheets of paper which have been placed in the transmitting (sending or TX) machine. As soon as the machines have finished with their "introductions", the document begins to move through the transmitting machine where it is read and converted to a data signal, exactly as in a copier. The difference here is that the print mechanism of the copying process is not located in the same machine as the reading mechanism. It is several miles, or even several thousand miles, away, and prints the data signals which arrive over the telephone line in the form of tones.

As far as it goes, this description of the fax process is accurate, and should be kept in mind whenever using any fax machine.

Multi-function machine

But...your new SAMSUNG multi-function machine provides features far beyond those of the basic fax. The multi-function fax machine package, consisting of the SF4100 or SF4200 series fax machine and the software for your PC, are designed to work together to effectively combine the utility of the fax machine with the power of the Personal Computer, thus providing a spectrum of useful features not possible with either unit alone.

Your PC utilizes the SAMSUNG multi-function machine as an input and output device, very much like any other attachment you may currently have connected to your computer. This package will enable you to scan text and graphic documents and store or edit them in your PC. You may also print any document contained in your PC, in color, on your multi-function machine.

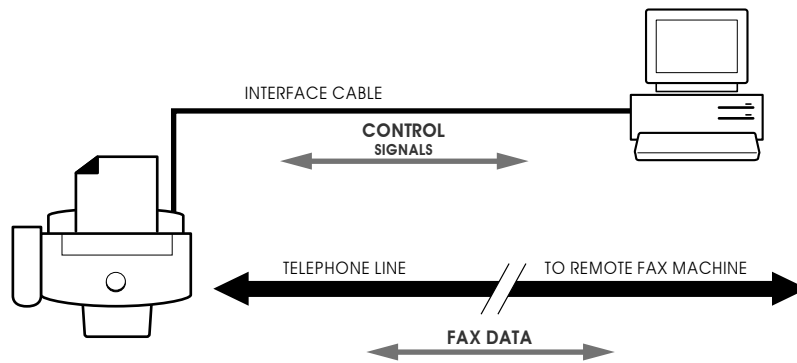

Multi-function machine operation

Additionally, your PC serves as a versatile control unit for your multi-function machine. You will see how to receive faxes directly into your PC, send documents directly from word processing or graphics applications, even control your multi-function machine remotely, a very useful feature when traveling out of the office to other locations.

The remainder of this manual will show you how to use each of these features to save time and money.

Chapter Two

INSTALLATION AND SETUP

Chapter Two

INSTALLATION AND SETUP

Please review the safety informations at the front of this manual, then follow the directions in this chapter to connect your machine and set it up for use.

► Choosing a Location

To help guarantee trouble-free operation of your machine, place it in a spot where:

- It is not in direct sunlight or in excessive humidity.
- It is not too close to heating or air conditioning vents.
- Its ventilation openings aren't blocked.
- It is at least 4 inches away from other objects.
- Its cords won't get in the way.
- It can't be easily knocked off a table or dropped.

► Connections

Connection Diagram

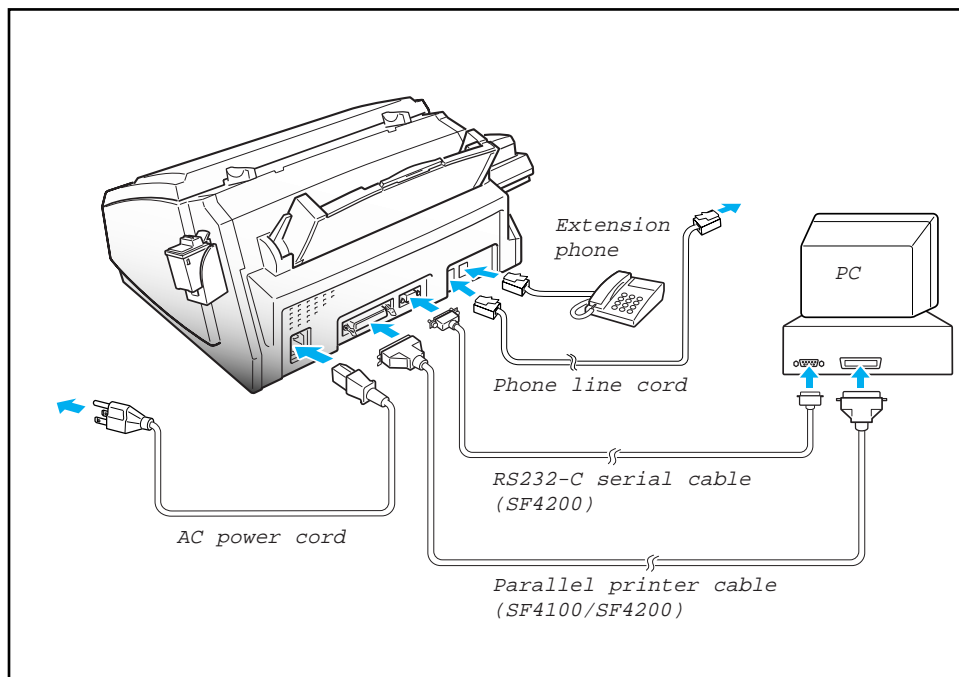

INSTALLATION AND SETUP

Handset and Handset Cradle

1. Plug one end of the coiled cord into the jack on the handset. Then plug the other end into the modular jack on the bottom of the handset cradle.

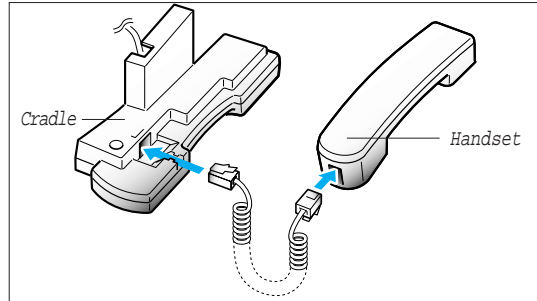

2. Plug the cradle's modular cord(s) into the modular jack(s) on the left side of your machine.
(The number of modular cord may differ, depending on your country.)

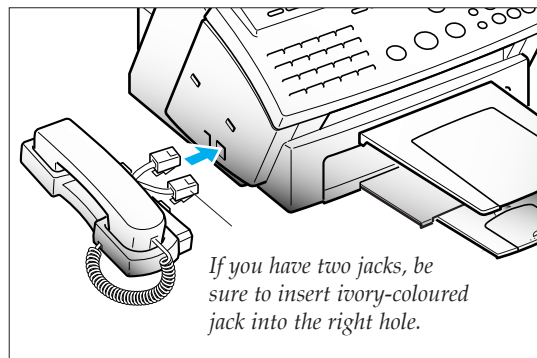

3. Attach the handset cradle to the main body. Insert two tabs of the cradle into the slots on the left side of the main body as shown, and push them down.

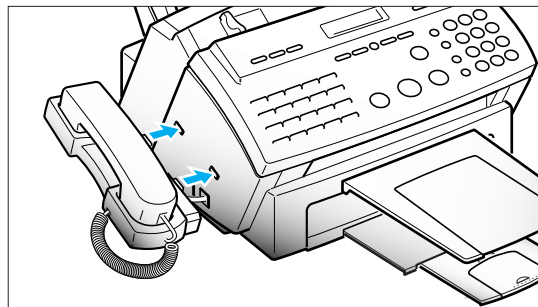

4. Secure the cradle using the supplied screw.

Place the handset in the cradle.

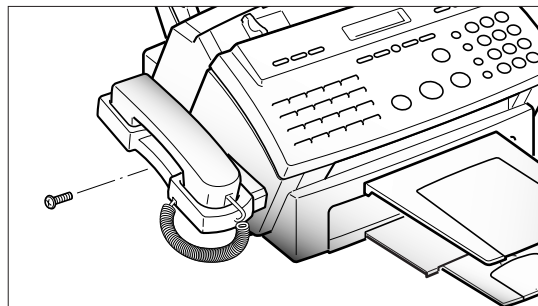

INSTALLATION AND SETUP

Document Tray

1. Hold the document tray with both hands and insert one end of the tray into the corresponding slot as shown.

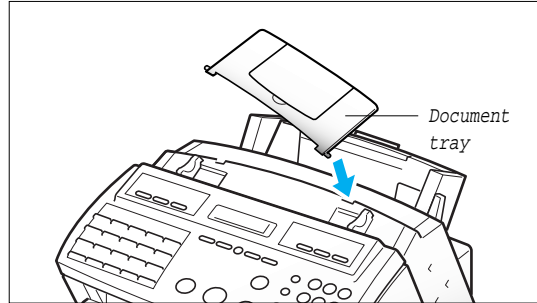

2. Gently flex the tray in the middle, until the other end of tray clears the corresponding slot on the machine.

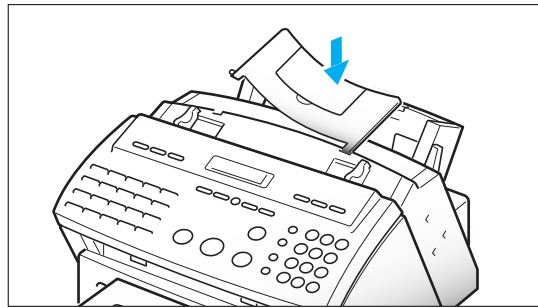

3. Insert the other end of the tray into the corresponding slot as shown.

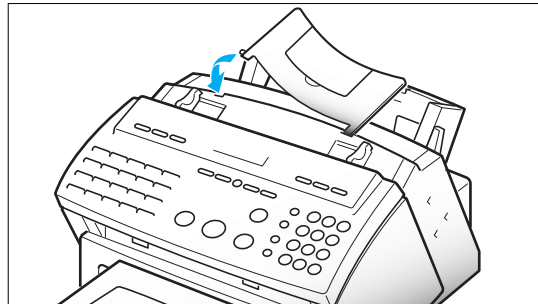

4. Fold out the extender on the document tray, if necessary.

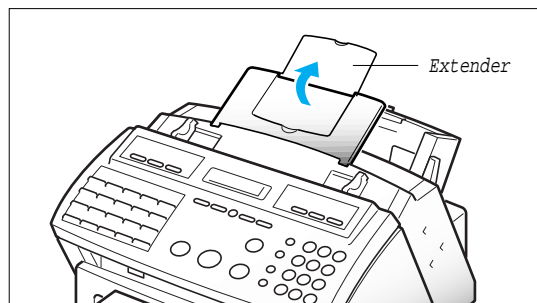

INSTALLATION AND SETUP

Document Exit Tray

The document exit tray catches documents fed through the machine from the document feeder.

1. Insert two tabs on the document exit tray into the slots on the front of your machine.

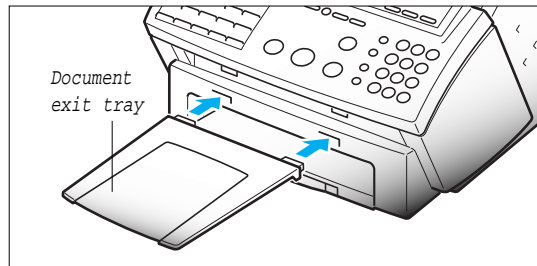

2. Fold out the extender, if necessary.

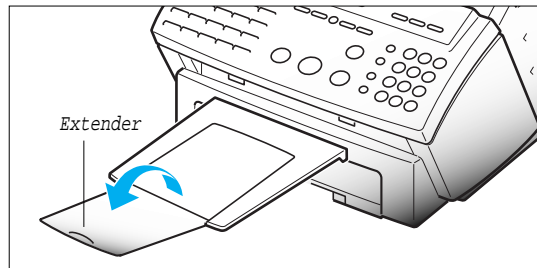

Printer Exit Tray

The printer exit tray is built in the bottom cover of the machine and catches paper fed through the machine from the printer automatic sheet feed. To extend the printer exit tray:

1. Gently pull the printer exit tray toward you to the desired paper length.

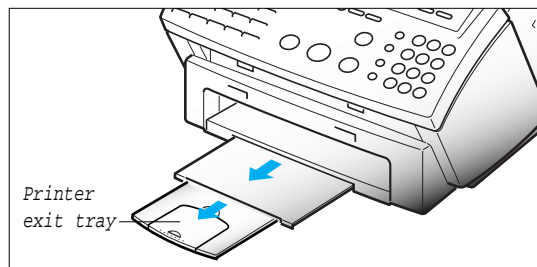

2. Fold out the extender, if necessary.

Remove any obstacles in front of the paper exit to prevent paper jams.

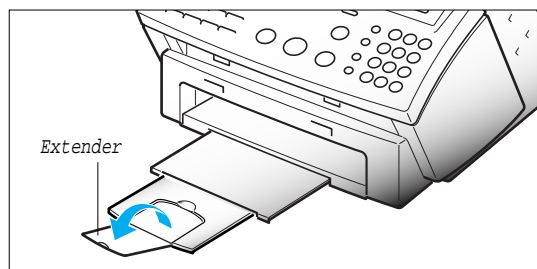

INSTALLATION AND SETUP

Telephone Line

Plug one end of the telephone line cord into the TEL LINE jack and the other end into a standard phone wall jack.

To select your dialling type, see page 2.28.

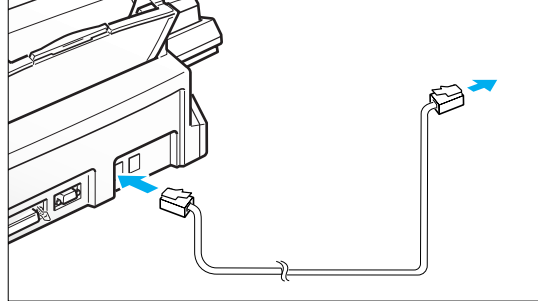

Extension Phone (Optional)

Plug one end of the modular cord into the EXT. LINE jack on the back of your machine.

Plug the other end of the cord into a modular jack on a telephone answering device or a regular telephone to use as an extension.

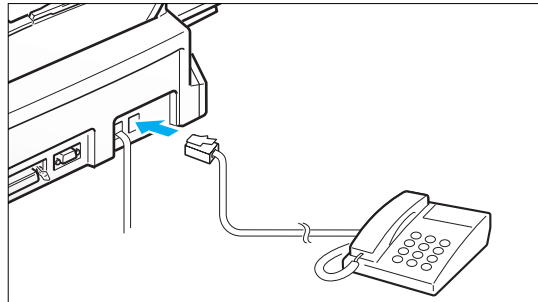

AC Power Cord

Plug one end of the cord into the back of the machine and the other end into a standard AC power outlet.

The machine turns on. All lamps on the control panel light up and the LCD displays 'SYSTEM INITIAL' then 'PAPER OUT.' Load the paper as described on page 2.6

If you want to turn off, unplug the power cord.

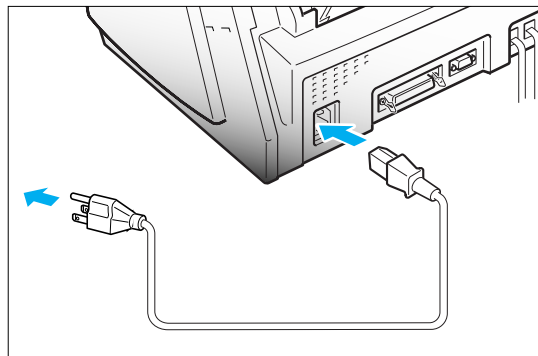

Note : If there are documents lost from memory due to a power failure, the machine automatically prints out a report after power is supplied.

INSTALLATION AND SETUP

► **Loading Paper**

The LCD displays 'PAPER OUT' when no paper is loaded. You can load approximately 100 sheets of paper.

1. Pull the paper support on the paper bin all the way up.

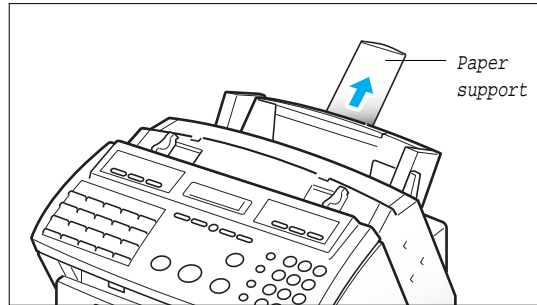

2. Push the paper load lever away from you to open the sheet feeder.

Warning beeps sound for about 30 seconds and the LCD displays 'CHECK LOAD LEVER' and the paper size selected through user options on page 6.8. If you want to install a different-sized paper, change the option after loading paper.

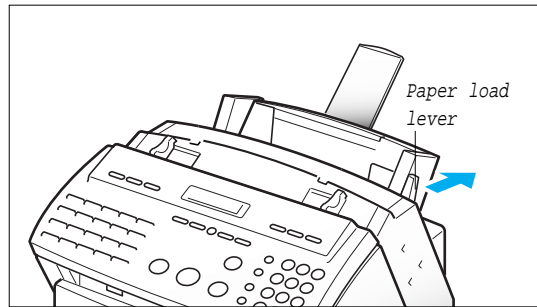

3. Fan the paper and insert the paper with the print side facing you.



Hold the left paper guide and move it to the right to match the width of the paper.

Note: If you don't either fan the paper or adjust the paper guide, it may cause multi-paper feeding.

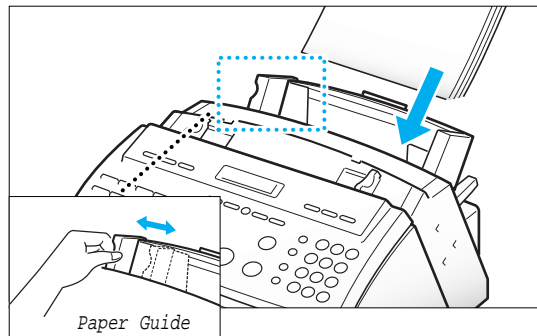

4. Pull the paper load lever toward you to close the sheet feeder.



INSTALLATION AND SETUP

Paper Type and Sizes

Because all paper varies in physical characteristics, you can receive mixed results from different packages of paper even though the packages contain the same type of paper. If you encounter undesirable results, try the other side of the paper, a different type, or another package of the same kind of paper.

Do not use the following types of paper with the printer:

- Continuous form feed paper
- Synthetic paper
- Thermal paper
- Multi-sheet forms and documents
- Chemically treated paper (carbonless paper)
- Papers with raised, embossed lettering

To load paper with a preferred print side:

- If you're using xerographic paper, load the paper with the preferred print side facing down.
- If you're using letterhead or bond paper, load the paper with the preferred side facing up.

The following paper sizes can be used in your machine for fax:

Paper size	mm	inches
Letter	216 X 279	8.5 X 11.0
Legal	216 X 356	8.5 X 14.0
A4	210 X 297	8.3 X 11.7

Note : To print on card stock, load the stock with the envelope guide in an upright position.

Use paper that meets these specifications:

Length	127 to 364 mm	(5.0 to 14.33 in)
--------	---------------	-------------------

► Installing Print Cartridge

When you install a new print cartridge, perform all of the following steps:

1. Press the CARTRIDGE button on the control panel. The LCD displays 'CHECK CARTRIDGE ! PLEASE INSTALL', and the print cartridge moves to the load position.

If you install a color cartridge, use 'Install Cartridge' tab in the SAMSUNG MFP4100/4200 Control Program on your PC.

2. Lift the control panel with your hand and slide the top cover up, by pushing on position A, until it clicks and the ink cartridge is in full view.

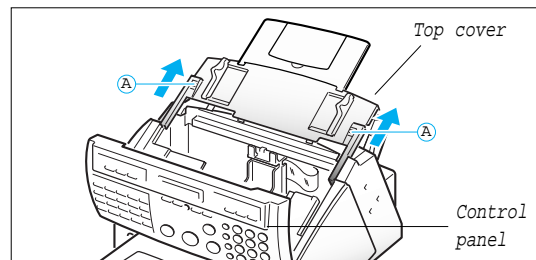

INSTALLATION AND SETUP

3. Remove the print cartridge from its packaging. Hold the print cartridge by the black areas or colored top only.

Do not touch the copper area.

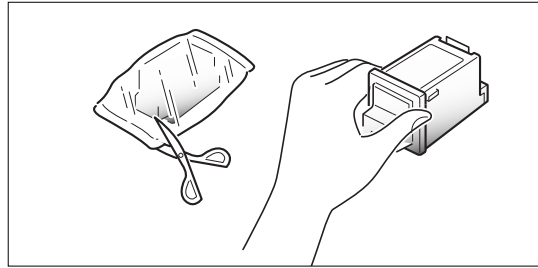

4. Carefully remove the tape covering the printhead. Be sure to remove all the tape.

Do not touch the copper area.

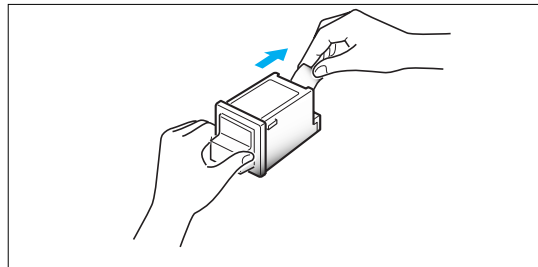

5. Insert the print cartridge in the carrier.

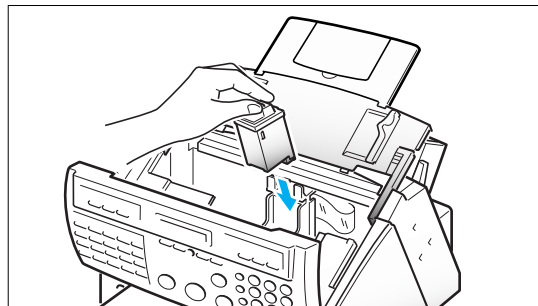

6. Push the cartridge firmly in the direction of the arrow until it clicks into place.

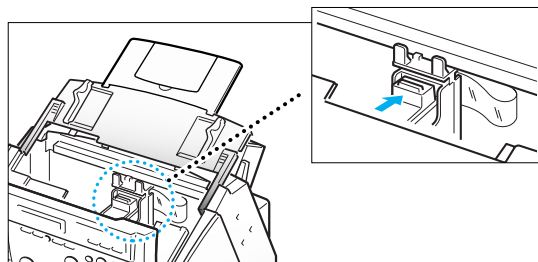

7. After installing the print cartridge, replace the top cover and the control panel to their normal positions.

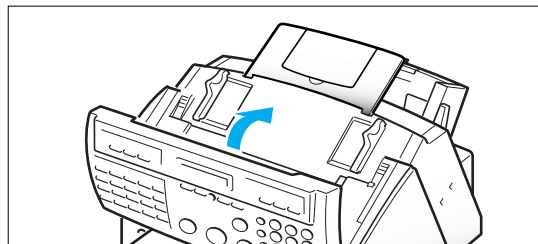

INSTALLATION AND SETUP

8. Press the CARTRIDGE or ENTER button.

Use 'Install Cartridge' tab on your PC for a color cartridge.

The LCD displays 'CARTRIDGE IS 1:NEW 2:USED.'

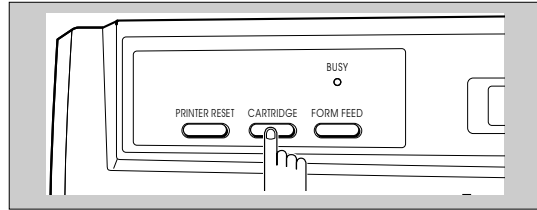

9. Choose '1:NEW' by using the ◀ or ▶ button, or by pressing the 1 button.

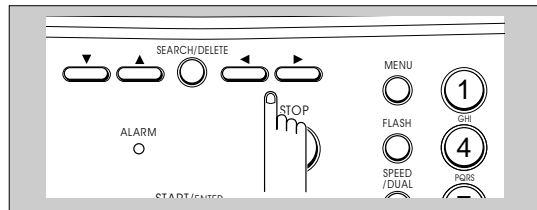

10. Press the ENTER or CARTRIDGE button. The LCD displays briefly 'MONO INSTALLED' (or 'COLOR INSTALLED' for color print cartridge).

Use 'Install Cartridge' tab on your PC for a color cartridge.

If the cartridge is not installed properly, the LCD displays 'CHECK CARTRIDGE! PLEASE INSTALL.' Remove the cartridge and retry to insert it.

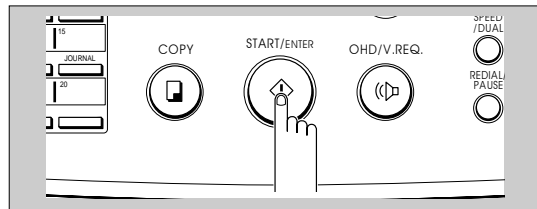

Notes:

- If you received fax with the color cartridge installed, you cannot get the fax printed until replacing it with mono cartridge.
- When you install a new cartridge, you must choose '1:NEW.' When you install a used cartridge, select '2:USED', which helps you check the amount of ink remaining. If you mix up several used cartridges, it will be difficult to check the amount of ink remaining. Once a new print cartridge is installed, use it until it has completely run out of ink.
- If the new cartridge does not give excellent printing quality, consult the 'Printer Cartridge Maintenance' section.
- If you want to install a color cartridge to print a file on your PC, you should use 'Install Cartridge' tab in the SAMSUNG MFP4100/4200 Control Program on your PC. If you use the CARTRIDGE button on this machine, the machine beeps a warning tone and briefly displays 'RE-INSTALL COLOR USING PC-DRIVER.' Press 'Install Cartridge' tab on your PC, or the file may print using composite black.

INSTALLATION AND SETUP

Print Cartridge Storage Unit (SF4100, SF4200)

The print cartridge storage unit provides a convenient place to store an extra black or color print cartridge, and prevents an opened cartridge from drying out.

Attach the storage unit by inserting its three tabs into the slots on right side of the main body and lowering it until it clicks into place.

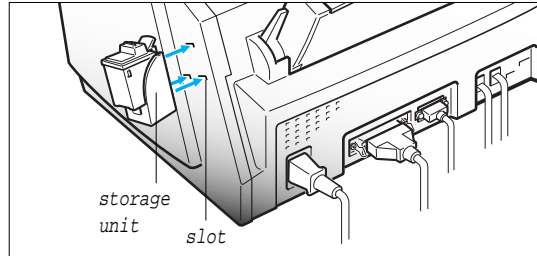

Storing a Print Cartridge in the Storage Unit (SF4100, SF4200)

When switching between the color and black print cartridges, keep the unused one in the print cartridge storage unit. The storage unit prevents the print cartridge from drying out while providing easy access to it.

TO STORE A PRINT CARTRIDGE IN THE STORAGE UNIT

1. Holding the print cartridge, insert it into the storage unit.

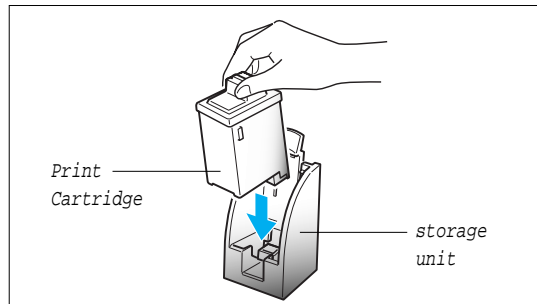

2. Push firmly in the direction of arrow until it clicks into place.

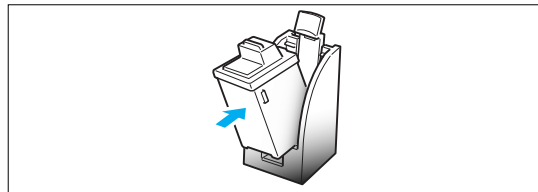

TO REMOVE A PRINT CARTRIDGE FROM THE STORAGE UNIT

Hold the print cartridge and pull it firmly in the direction of arrow.

Push down the cartridge and pull it toward you.

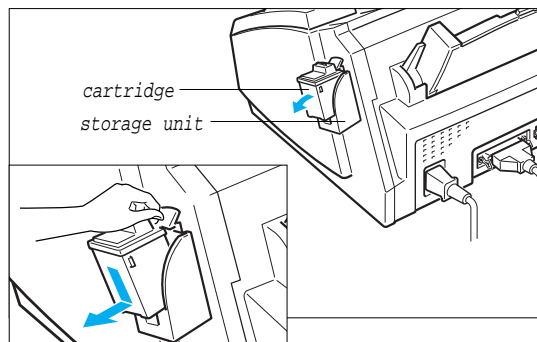

INSTALLATION AND SETUP

▶ Running Self-Test

Each time you install a new print cartridge, run Self-Test to check if the printer mechanism is functioning properly.

1
Press MENU.

The LCD asks you to press the desired function button.

▶ One-touch buttons 01-16 perform specific functions when used with the MENU button. Each button provides access to a selected function.

2
Press 05, SELF-TEST, on the one-touch keypad.

The LCD asks if you want to perform the printer test.

▶ If you choose ▼, you can choose another menu item. Pressing STOP returns you to Standby mode.

3
Press ENTER to perform the printer test.

The LCD asks if you want to run Self-Test.

▶ If you press ▼, you can choose another menu item.

4
Press ENTER to run the printer Self-Test.

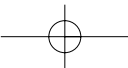

2

INSTALLATION AND SETUP

The machine prints out a test pattern to show the status of the printer mechanism.

5
Press STOP twice to return to Standby mode.

6
Examine the test pattern and look for a break in the diagonal line. A broken line shows any clogged nozzles. Run the nozzle test. See page 7.5.

If the diagonal lines are not broken and the black (or color) bars are clear, the printer mechanism is functioning properly. See the pattern sample below.

<Sample of test pattern>

V1.0 04/13/96

Quality : LQ Bidi Print : OFF Paper : A4
 Top Margin : 0.55" Ink Saver : No
 Transpar. : NO Pitch : 10 CPI Font : Courier
 Orient : Portrait Autowrap : OFF CR Def. : CR=CR
 Lines : 64 Character : PC-8

Name	Pitch	Sample Char.
Courier	5	ABCDEFGHIJKLM
Courier	10	ABCDEFGHIJKLMOPQRSTUVWXYZ
Courier	16.67	ABCDEFGHIJKLMOPQRSTUVWXYZ
Courier	20	ABCDEFGHIJKLMOPQRSTUVWXYZ
LT Gothic	6	ABCDEFGHIJKLMN
LT Gothic	12	ABCDEFGHIJKLMOPQRSTUVWXYZ
LT Gothic	24	ABCDEFGHIJKLMOPQRSTUVWXYZ
CG Times	Prop.	ABCDEFGHIJKLMOPQRSTUVWXYZ

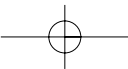

INSTALLATION AND SETUP

▶ Connecting to Your PC (SF4100, SF4200)

Connecting SF4200 to Your PC

Use the serial cable and the parallel print cable that supports bidirectional communications to connect your machine and the computer.

CONNECTING THE PRINTER CABLE

Note : Make sure you turn the power off by plugging out the power cord before connecting the machine to your PC. When the connection is completed, turn the power on.

1. Connect the parallel printer cable to the 36 pin printer jack on your machine.

You must use a parallel cable that supports IEEE-P1284 bidirectional communications.

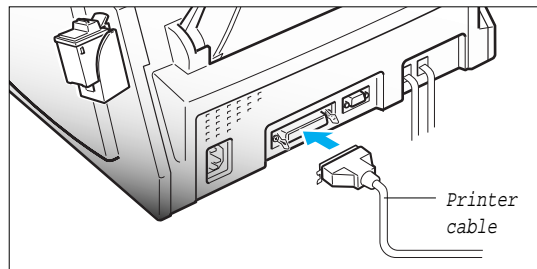

2. Fasten the metal clips to the parallel cable.

3. Connect the other end of the parallel cable to your computer.

Refer to the instruction manual that came with your computer to connect the other end of the printer cable to your computer.

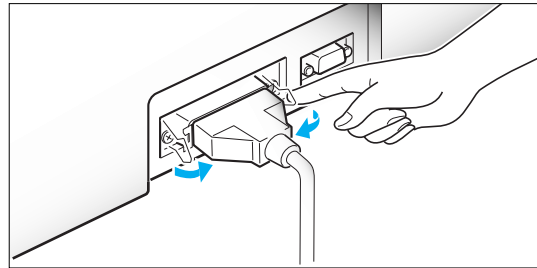

CONNECTING THE SERIAL CABLE

4. Connect the supplied RS232-C serial cable to the computer.

Fix the serial cable with screws.

Connect the other end of the serial cable to your computer.

Refer to the instruction manual that came with your computer to connect the other end of the serial cable to your computer.

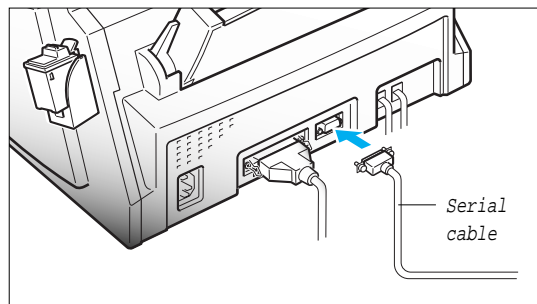

INSTALLATION AND SETUP

Connecting SF4100 to Your PC

Use the printer cable that supports bidirectional communications to connect your machine and the computer.

Note : Make sure you turn the power off by plugging out the power cord before connecting the machine to your PC. When the connection is completed, turn the power on.

1. Connect the parallel printer cable to the 36 pin printer jack on your machine.

You must use a parallel cable that supports IEEE-P1284 bidirectional communications.

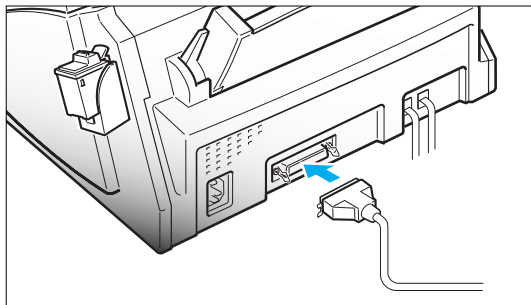

2. Fasten the metal clips to the parallel cable.

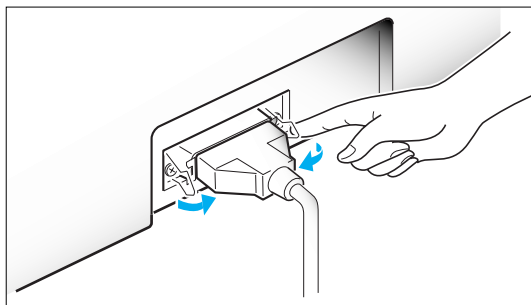

3. Connect the other end of the parallel cable to your computer.

Refer to the instruction manual that came with your computer to connect the other end of the printer cable to your computer.

INSTALLATION AND SETUP

▶ Setting Up Printer (SF4100, SF4200)

Installing the Windows Printer Driver Software

If your computer operates with Windows 3.1 or Windows for Workgroups, follow the instructions below to install the printer software.

If your computer operates with Windows 95, see page 2.16.

WITH WINDOWS 3.1

1. Start Windows.
2. Insert the setup diskette into drive A (or B).
3. In Windows Program Manager, click on 'File', then choose 'Run'.

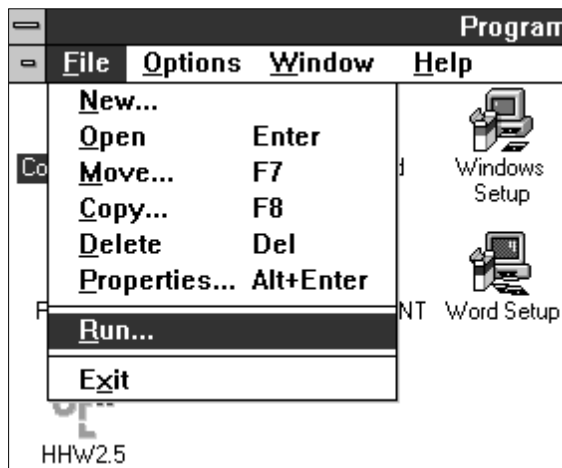

4. In the command line dialog box, type a:setup (or b:setup), then click 'OK'.
5. Follow the instructions on the installation screens.

For the latest information on installing and using the printer with Windows applications, consult the Read Me and Online Help files in the Samsung MFP4100/4200 program group window.

INSTALLATION AND SETUP

WITH WINDOWS 95

To install the printer software with Windows 95:

1. Start Windows.
2. Insert the setup diskette into drive A (or B).
3. Click 'Start' on the desktop, and then choose 'Run'.

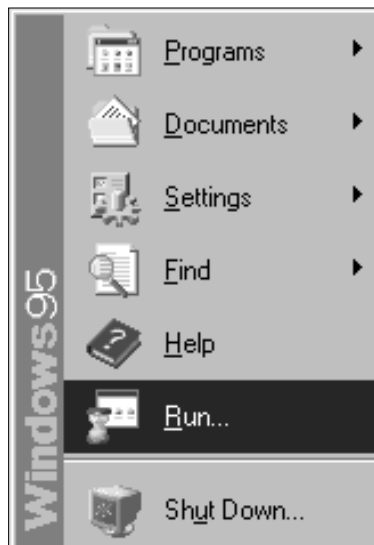

4. In the Run dialog box, type 'a:setup (or b:setup)', then click 'OK'.
5. Follow the instructions on the installation screens.

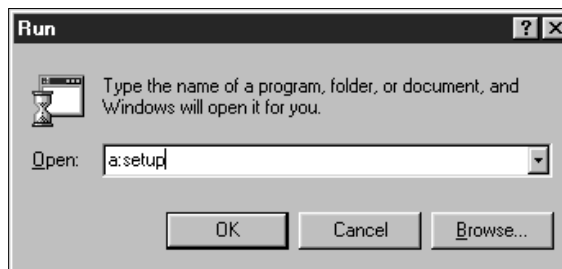

Note (SF4100/SF4200):

After rebooting the PC following installation of the printer software, you will be asked to re-install it due to the PnP (Plug & Play) feature of Windows95.

It is recommended to click Cancel, and terminate the installation at this point.

INSTALLATION AND SETUP

Running Windows Printer Software

The Samsung MFP 4100/4200 Control program lets you:

- Monitor your print jobs.
- Watch a print job progress.
- Monitor print cartridge ink level.
- Install or replace a print cartridge.
- Perform print cartridge maintenance.
- Access the Windows Printing dialog boxes to change printer settings.
- Print from Windows-based applications.
- Test your printer.
- Change the print queue parameters.

STARTING THE SOFTWARE FROM WINDOWS

1. To start the Printer Control Program, double-click the Samsung Control Program icon.



2. Click the Windows Printing tab, then the Windows Driver Setup button in the Samsung Control Program to browse through the available options.



INSTALLATION AND SETUP

BEFORE YOU PRINT

Make sure Samsung MFP 4100/4200 is listed as your default printer in the Windows Control Panel (the Setup Program does this automatically during installation).

Print as you normally would—for example, by choosing Print from your application's File menu.

CHANGING PRINTER SETTINGS

Before printing, you may want to change some printer settings. The Samsung MFP 4100/4200 dialog box lets you make changes to options such as paper size, image settings, print quality, and halftoning.



You can open the Samsung MFP 4100/4200 dialog box from:

- a Windows-based application — If you open the Samsung dialog box from an application's Print command, your choices apply only to that print job. The next time you print, you have to choose the print settings again. If you open the Samsung dialog box from an application's Print Setup command, the application stores the settings with your document. The document prints with the settings until you change them.
- the Windows Control Panel — These settings will apply to all print jobs and applications until you change the settings.
- the Samsung MFP 4100/4200 Control Program — These settings will apply to all print jobs and applications until you change the settings.

INSTALLATION AND SETUP

CHOOSING PRINT OPTIONS FROM WINDOWS-BASED APPLICATIONS

The following steps are general instructions. Your Windows-based application may require a slight variation from this procedure. For example, in step 3, your application may have a Printer button in the Print Setup dialog box instead of an Options button.

1. Open the application's File menu.
2. Choose Print (or Printer) Setup.
3. In the Print Setup dialog box, choose Options to open the Samsung MFP 4100/4200 dialog box.
4. Use the tabs to browse through the available options.

After choosing print options, you are ready to print.

CHOOSING PRINT OPTIONS FROM WINDOWS CONTROL PANEL

1. In the Windows Main group window, double-click the Control Panel icon.
2. From the Control Panel, double-click the Printers icon to open the Printers dialog box.
3. From the list of installed printers, select the Samsung MFP 4100/4200.
4. Click the Setup button to open the Samsung MFP 4100/4200 dialog box.

After choosing options, you are ready to print.

CHOOSING PRINT OPTIONS FROM THE CONTROL PROGRAM

1. Double-click the Samsung MFP 4100/4200 Control Program icon to open the Samsung MFP 4100/4200 Control Program.
2. Choose the Windows Printing tab.
3. Choose the Windows Driver Setup button.
4. Use the tabs in the dialog box to browse through the options.

After choosing options, you are ready to print.

Online Help

The MFP 4100/4200 software has extensive online Help with detailed information about your machine. You can access online Help from any dialog box. Just choose the Help button or press the F1 key.

Within online Help, you will find underlined words or "hot text." Click the hot text to instantly view more information on a related topic.

Installing the DOS Printer Software

If you will be printing from DOS applications, follow the steps below:

1. Insert the Setup diskette in drive A.
2. From the DOS prompt, type a:install.
3. Follow the instructions on the screen.
4. When the installation is complete, remove the diskette from the drive.

INSTALLATION AND SETUP

Using the DOS Printer Software

PRINTING FROM DOS APPLICATIONS

When you print from a DOS (not Window based) application, your printer uses PCL 3 emulation. You must install a printer driver for PCL 3 emulation printing in each DOS application.

1. Start your DOS application.
2. Install the HP Deskjet 500C as the current printer in the DOS application from which you are printing.

Some applications offer a color or black (mono) version of the HP Deskjet 500C driver. Choose the color version if you are printing color documents. Choose the black version if you are printing black and white documents.

If your application does not offer the HP Deskjet 500C printer driver, install the HP Deskjet 500C printer driver. You will not be able to print in color with the Deskjet 500 driver.

For help installing a printer driver, see your application user's documentation.

CHOOSING PRINT OPTIONS FROM DOS

The MJPANEL.EXE program lets you choose print options for your DOS applications.

You must start the MJPANEL.EXE program from your DOS prompt.

To choose print options for DOS applications:

1. From your application, go to the DOS prompt.
2. From the DOS prompt, type MJPANEL and press ENTER.
3. From the Remote Control Panel, use the arrow keys to select an Options button. Press ENTER.
This highlights a setting in the right-hand (Settings) column.
4. Use the arrow key to select a setting from the Settings column of the Remote Control Panel. Press ENTER to choose the setting.
5. Press the Tab key to return to the Options buttons.
6. Choose the Exit button to return to your application.

Notes:

- After you install the Printer Driver Software with Windows 3.1 or DOS, if the printer does not work properly, check your PC configuration (CONFIG. SYS).
- If you want to use another printer and it does not work properly, make sure that you deactivate the MFP4100/4200 Drive and reboot your PC.
- When you works in DOS Type Writer mode or Landscape mode, fax machine might not work properly.

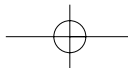

INSTALLATION AND SETUP

▶ Making a Copy

Try copying a document to make sure that the machine is working properly.

1
Choose a page to copy.



▶ For information on preparing a document, see page 4.1.

2
Turn the page face down and insert it into the document feeder.

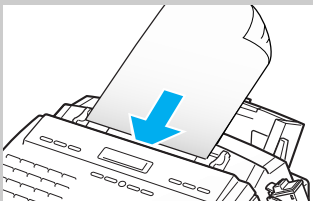

3
Adjust the document guide to match the width of the document.

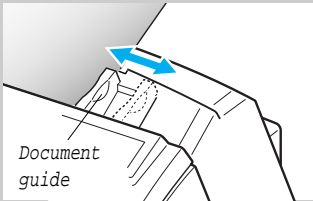

Document guide

4
Feed the document into the machine.

The machine beeps, and the automatic document feeder seizes and pulls in the page.

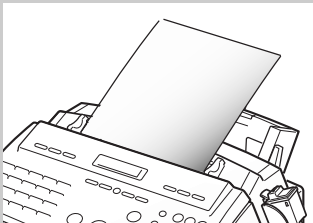

▶ The LCD displays 'DOCUMENT LOADING' then 'DOCUMENT READY' when the sheet is gripped by the machine.

5
Choose the proper contrast, if necessary.



▶ The print resolution is automatically set to FINE when you are making a copy. Press CONTRAST if the page you are copying contains faint markings, dark image, photographs, or other halftone images. For more information on resolution and contrast, see page 4.2.

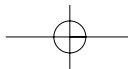

INSTALLATION AND SETUP

6
Press COPY.

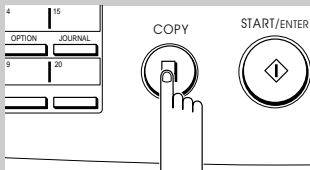

The LCD asks you to enter the number of copies from 1 to 99.

ENTER NUMBER OF
COPIES [1-99] > 1

7
If you need two or more copies, enter the desired number of copies using the dial keypad.



or
If you want only one copy of the document, do not enter any number.

8
Press COPY or START when the number appears correctly in the display.

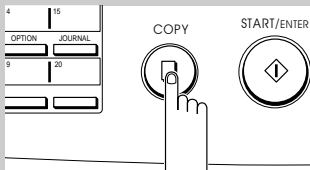

The LCD displays the number of copies requested on the upper line, and the number of the page that is currently printing on the bottom line along with the memory remaining.

COPY 1 / 10
81% PAGE 1

or
In case of single copy, the LCD displays the page number that is being printed.

COPY
PAGE 1

▶ Where 1/10, '1' is the number of copies that has been made and '10' is the total number of copies requested. 81% is the amount of memory remaining from the scanned image that is stored while the copies are being made.

INSTALLATION AND SETUP

▶ Setting the Date and Time

The current date and time are shown in the LCD when the machine is on and ready for use (Standby Mode). The date and time are printed on all faxes you send.

1
Press MENU.

The LCD asks you to press the desired function button.

2
Press 08, DATE & TIME, on the one-touch keypad.

▶ One-touch buttons 01-16 perform specific functions when used with the MENU button. Each button provides access to a selected function.

The LCD prompts you to select a date format.

3
Select the format you want the date to appear in by pressing 1 to select USA, or 2 for EUROPE.
or
You can select by pressing ◀ or ▶ then ENTER.

▶ If you select USA, the date format will be displayed as MMDDYY. EUROPE will be displayed as DDMMYY.

The LCD displays the currently set date and time.

INSTALLATION AND SETUP

4

Adjust the date and time by pressing ◀ or ▶ to move the blinking cursor under the number you want to change.

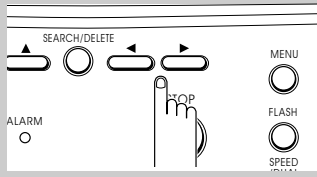

- ▶ MM (Month) = 01~12
- DD (Day) = 01~31
- YY (Year) = Last two digits of the year
- HH (Hour) = 01~12 (or 00~23)
- MM (Minute) = 00~59

5

Enter the correct number by using the number keypad.

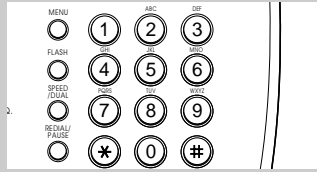

6

When the date and time are correct, press ENTER.

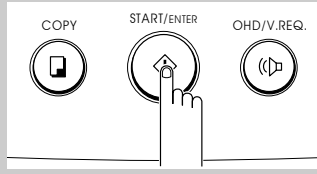

▶ If you enter an invalid number, the machine beeps and doesn't proceed to the next step. If this happens, just reenter the correct number.

The LCD asks you to select AM or PM.

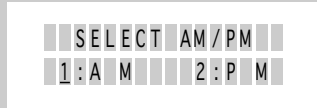

7

Select AM or PM by pressing 1 or 2.

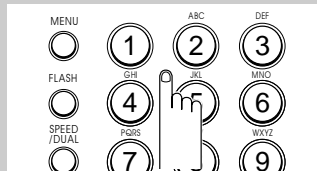

You can select by pressing ◀ or ▶ then ENTER.

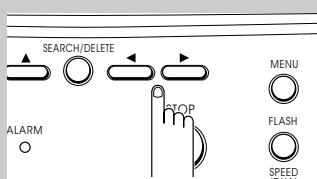

▶ If you have entered the time in 24-hour format, you don't have to select AM or PM. The machine returns to Standby mode.

The LCD displays the date and time, then returns to Standby mode.

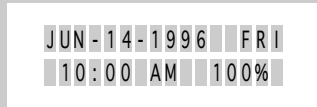

INSTALLATION AND SETUP

▶ Setting the Terminal ID (Your Name and Number)

The terminal ID will be printed at the top of each page sent from your machine.

1
Press MENU.

The LCD asks you to press a function button.

2
Press 07, SYSTEM ID, on the one-touch keypad.

The LCD asks you to enter the telephone number.

3
Enter the telephone number to which your machine is connected.

You can edit the number by moving the cursor with ◀ or ▶ button and entering the correct number.

▶ One-touch buttons 01-16 perform specific functions when used with the MENU button. Each button provides access to a selected function.

▶ You can enter up to 20 digits. You may include special characters (space, hyphen, or plus sign) in the number to help improve readability. To enter a space, press REDIAL/PAUSE. To enter a hyphen (-), press # . To enter a plus symbol (+), press * .

If you enter a wrong number or character, simply press DELETE. To delete all digits, move the cursor to the first digit, and press and hold DELETE.

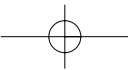

INSTALLATION AND SETUP

4
Press ENTER when the number in the display is correct.

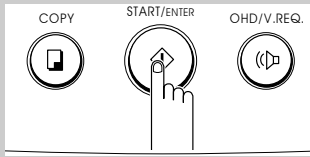

The LCD asks you to enter ID name.



▶ If there is an ID already set, that ID name appears in the display. To change the ID, press ▶ or ◀ to move the cursor under the character you want to change and enter a new character.

5
Enter ID name (up to 40 characters) by using the numeric keypad.

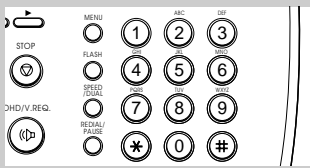

▶ For information on using the numeric keypad to enter letters, see page 2.27.

6
Press ENTER when the name in the display is correct.

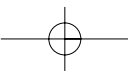
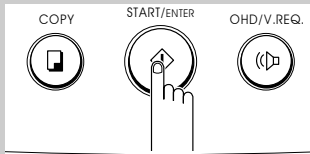

INSTALLATION AND SETUP

Using the Keypad to Enter Letters

These instructions assume that the LCD is asking you to enter a name.

1
Press the number button labeled with the letter you want—press the button repeatedly until the letter appears in the display.

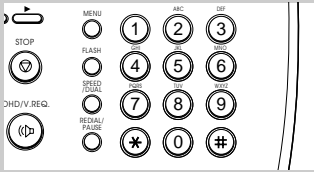

The keypad diagram shows a 12-button numeric keypad. The letters M, N, and O are positioned above the number 6 button. Other buttons are labeled: MENU, STOP, OHD/V.REQ., FLASH, SPEED/TOTAL, REDIAL/PAGE, *, 0, #, 1-9, and ANC.

▶ For example, if you want to enter an O, press 6 (labeled MNO). Each time you press 6 the LCD displays a different letter—first M, then N, and O, and finally 6.

For a list of letters and corresponding buttons, see the table on the following page.

The letter appears in the display.



The LCD display shows the text 'TERMINAL ID: 0' in a monospaced font. The '0' is in the last position of a 10-character field.

2
When the letter you want appears in the display, press another number key labeled with the next letter you want.

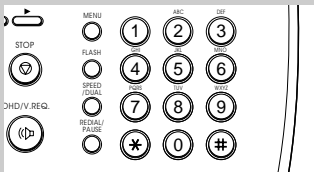

The keypad diagram is identical to the one in step 1, showing letters M, N, and O on button 6.

▶ If the next letter is printed in the same number button, move the cursor by pressing ▶ then press the number button.

The blinking cursor moves right and the next letter appears in the display.



The LCD display shows the text 'TERMINAL ID: OP'. The cursor is now at the end of the second 'P', and the '0' has been replaced by 'P'.

3
Select additional letters in the same way.

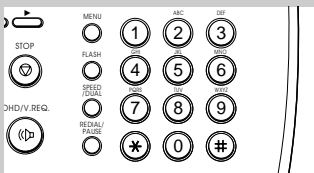

The keypad diagram is identical to the one in step 1, showing letters M, N, and O on button 6.

4
When you're finished entering letters, press ENTER.

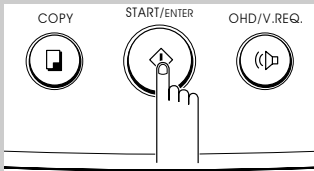

The keypad diagram shows a close-up of the 'START/ENTER' button, which is a circular button with an upward-pointing arrow. A hand is shown pressing the button. Other buttons shown are COPY and OHD/V.REQ.

INSTALLATION AND SETUP

Keypad Character Assignments

Key	Assigned numbers, letters, or characters
1	SPACE 1
2	A B C 2
3	D E F 3
4	G H I 4
5	J K L 5
6	M N O 6
7	P Q R S 7
8	T U V 8
9	W X Y Z 9
0	+ - , . ' / * # & 0

Adjusting Ringer Volume

Set the machine's ringer volume by using the RINGER VOLUME switch on the back of machine.

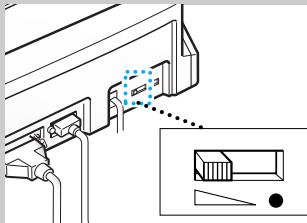



▶ The fax machine will work normally even if the switch is set to OFF (●).

Selecting Tone or Pulse Service

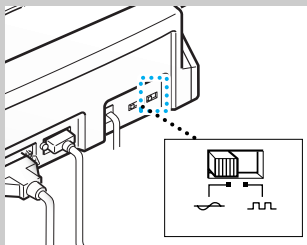
Set the DIAL MODE switch on the back of machine to match the type of service you have.



▶ If you have touch-tone service, set the switch to TONE (). If you have pulse service, set the switch to PULSE ().

If you aren't sure what kind of service you have, move the DIAL MODE switch to the TONE. Lift the handset and press any number (except *, #, or 0) on the keypad. If the dial tone stops, you have tone service. If the dial tone continues, you have pulse service.

Chapter Three

AUTOMATIC DIALING

Chapter Three

AUTOMATIC DIALLING

▶ One-Touch Dialling

One-Touch Dialling lets you touch any one of the 20 One-Touch buttons located on the left of the machine's control panel to automatically dial a telephone or fax number.

Storing a Number for One-Touch Dialling

1

Press and hold the one-touch button (01 through 20) that you want to assign.

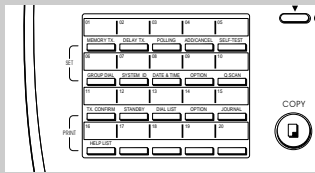

The LCD asks you to enter a telephone number.

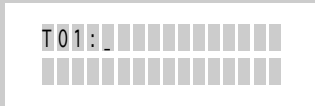

▶ If a number is already assigned to the one-touch button you chose, the LCD displays the number.

If the one-touch button is already assigned for Group dial, 'G01 USED (GROUP) 1:RENEW 2:OTHER' appears in the display. Press 1 to replace that number and continue, or 2 to start over with another one-touch button.

2

Enter the number you want to store by using the number keypad (up to 34 digits).



▶ To insert a pause between numbers, press PAUSE; a 'P' appears in the display.

If you make a mistake while entering a number, press ◀ or ▶ to move the cursor to the digit and enter a correct number.

3

When the number appears correctly in the display, press ENTER.

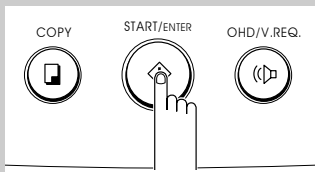

▶ If you have the number stored in another one-touch button or speed location number, the LCD displays 'DUPLICATED', and the other location number.

The LCD asks you to enter a name.

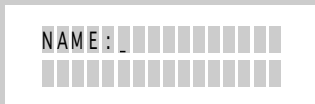

AUTOMATIC DIALLING

4

If you want to assign a name to the number, enter the name (up to 20 digits).

or

If you don't want to assign a name, press ENTER without entering a name.

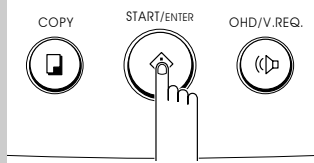
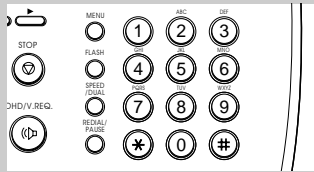

▶ If you assign a name to the number, you can take advantage of the Directory Dialling feature of your machine. For information about Directory Dialling, see page 3.10.

For more information on how to enter letters using the number keypad, see page 2.27.

5

Press ENTER when the name appears correctly in the display.

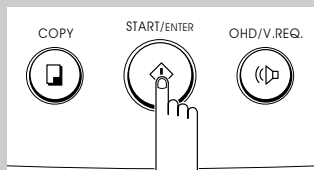

The LCD asks you to set another one-touch number.

PRESS ANOTHER
ONE-TOUCH NO.

6

If you want to set another one-touch number, press the desired one-touch button and repeat steps above.

or

To return to Standby mode, press STOP.

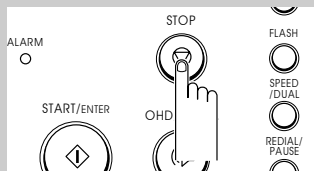
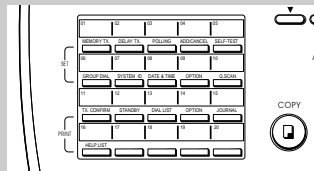

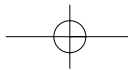

AUTOMATIC DIALLING

Dialling One-Touch Number

1
Press a one-touch button (01 through 20).

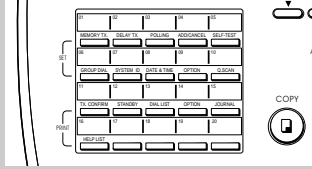

The LCD displays the name, then the number stored in the selected one-touch button. The number will be automatically dialled. You hear the dialling process on the speaker.

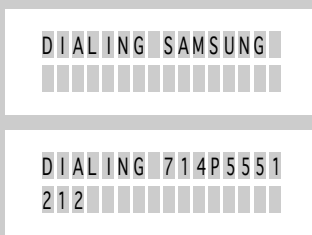

◀ If there is no number stored, 'NO. NOT ASSIGNED' appears.

After a number is dialled, if you want to adjust speaker volume, press ▼ or ▲ while you hear tones from the speaker, and select the desired loudness.

To stop One-Touch Dialling, press STOP.

2
If you are making a phone call, pick up the handset when the other party answers.

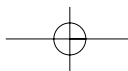
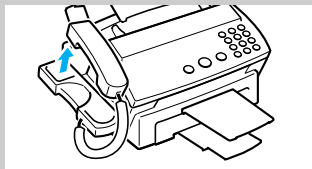

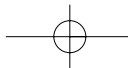

3

AUTOMATIC DIALLING

► **Speed Dialling**

You can store up to 50 telephone or fax numbers into 2-digit speed dial locations.

Storing a Number for Speed Dialling

1
Press and hold SPEED.

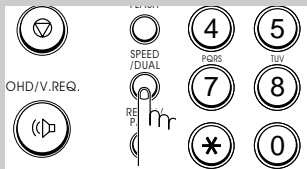

The LCD asks you to enter the location number you wish to assign.



2
Enter a 2-digit location number (01 through 50) to which you want to assign the telephone or fax number.



The LCD displays the selected location number.



◀ If a number is already assigned to the location you chose, the LCD displays the number.

3
Enter the number you want to store (up to 34 digits).

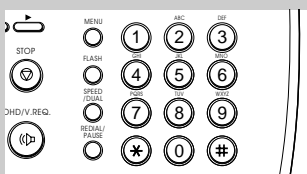

◀ To insert a pause between numbers, press PAUSE; a 'P' appears in the display.

If you make a mistake while entering a number, press DELETE to erase it.

If you want to erase all digits, move the cursor to the first digit then press and hold DELETE.

4
When the number appears correctly in the display, press ENTER.

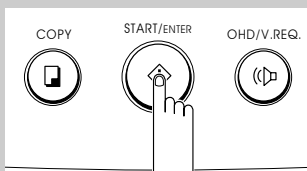

◀ If you have the number stored in another speed location or one-touch button, the LCD displays 'DUPLICATED', and the other location number.

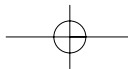

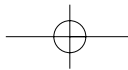

AUTOMATIC DIALLING

The LCD asks you to enter a name (up to 20 digits).

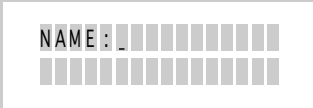

5
If you want to assign a name to the number, enter the name.
or
If you don't want to assign a name, press ENTER.

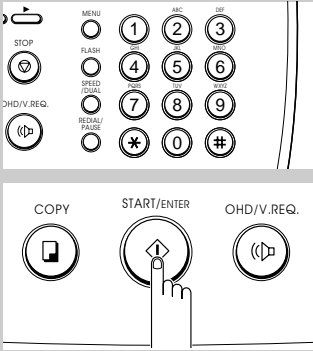

▶ If you assign a name to the number, you can take advantage of the Directory Dialling feature of your machine. For information about Directory Dialling, see page 3.10.

For information on how to enter letters using the number keypad, see page 2.27.

6
Press ENTER when the name appears correctly in the display.

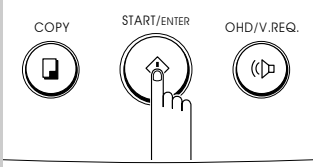

The LCD asks you to enter another location number.



7
If you want to store more telephone numbers, repeat steps 2-6.
or
If you want to return to Standby mode, press STOP.

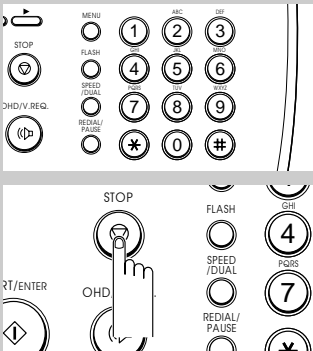
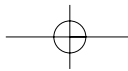

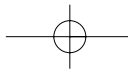



AUTOMATIC DIALLING

Dialling a Speed Number

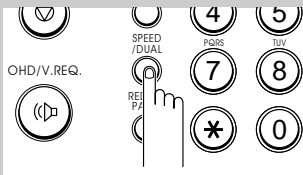
1
Press SPEED.



The LCD asks you to enter the location number.

ENTER LOCATION
NO. [01-50] > | |

2
Enter a 2-digit speed dial number.

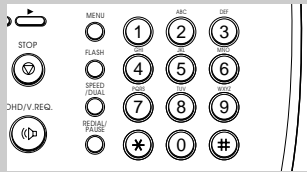

▶ If a document is loaded in the document tray, the machine dials and automatically begins to transmit when the remote fax machine answers the phone.

The LCD displays the name, then the number stored in the selected location.

DIALING SAMSUNG
| | | | | | | |

The number will be automatically dialled. You hear the dialling process on the speaker.

DIALING 714P555
1212 | | | | | | | |

▶ If there is no number stored, 'NO. NOT ASSIGNED' appears.

After a number is dialled, if you want to adjust speaker volume, press ▼ or ▲ while you hear tones from the speaker, and select the desired loudness.

To stop the dialling, press STOP.

3
If you are making a phone call, pick up the handset when the other party answers.

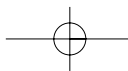
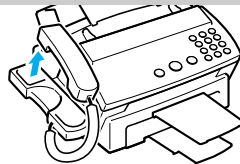

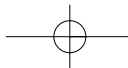

AUTOMATIC DIALLING

Group Dialling

You can send a document to multiple parties in a single operation. Before you can use this feature, you must coordinate and store the group numbers desired.

Storing One-touch or Speed Dial Numbers for Group Dialling

1
Press MENU.

2
Press 06, GROUP DIAL, on the one-touch keypad.

▶ One-touch buttons 01-16 perform specific functions when used with the MENU button. Each button provides access to a selected function.

The LCD asks you to select the one-touch button to which you want to assign the group number.

3
Press the one-touch button you want to use for Group Dial.

The LCD asks you to confirm the selected one-touch button.

▶ If the one-touch button is already used, 'T01 USED (ONE-T) 1:RENEW 2:OTHER' appears in the display. Press 1 to edit the contents, or 2 to select another one-touch button.

4
Press ENTER if you want to use the one-touch button for Group Dial.

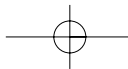

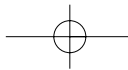

3

AUTOMATIC DIALLING

The LCD asks you to enter a one-touch button or speed dial number you wish to include in the group.

ENTER ONE-TOUCH
or SPEED DIAL NO

5
Press a one-touch button.

or

Press a 2-digit speed dial number.

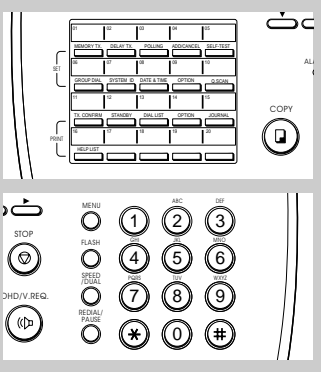

▶ The LCD displays the name and number stored in the selected one-touch button or 2-digit speed number.

For details on how to store fax numbers in one-touch buttons or 2-digit speed numbers, see page 3.1 or 3.4.

If the selected one-touch button has already been used for another group, a beep sounds and the LCD displays 'GROUP DIAL.' You cannot select that one-touch button.

6
Press ENTER.

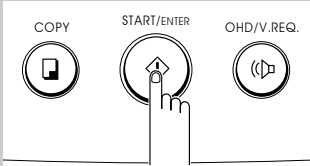

The LCD asks you to enter the next one-touch button or speed dial number.

ENTER ONE-TOUCH
or SPEED DIAL NO

7
Repeat steps 5-6 to enter more destination numbers into the selected group.

8
Press STOP when you have entered all the desired destinations.

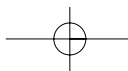
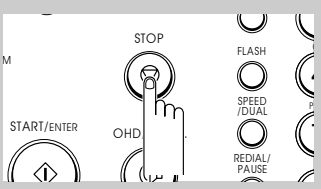

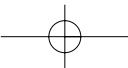

AUTOMATIC DIALLING

The LCD display asks you to enter a group name.

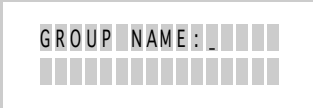

9
If you want to assign a name to the group, enter the name up to 20 digits. If not, skip this step.

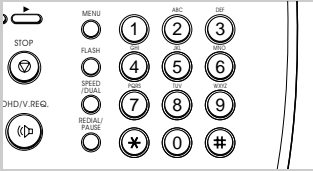

▶ For details on how to enter letters using the number keypad, see page 2.27.

10
Press ENTER when the name appears correctly.
The machine returns to Standby mode.

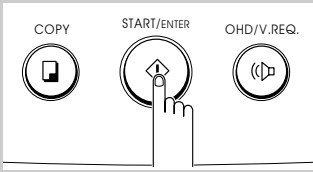

Using Group Dialling (Multi-address transmission)

You can use a group dial number for Memory Transmission or Delayed Transmission.

Follow the procedure of the desired operation (Memory Transmission — p. 5.1, Delayed Transmission — p. 5.3). When you come to a step that requests the remote fax number, press the one-touch button under which you stored the Group Dial. Then continue the procedure to complete the desired operation.

Your machine automatically reads the document into memory, and the machine will dial each of the numbers included in the group.

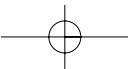

AUTOMATIC DIALLING

➤ **Searching for a Number in Memory (Directory Dialling)**

There are two ways to search for a number in memory. You can either scan from A to Z sequentially, or you can search using the first letter of the name associated with the number.

Searching Sequentially through Memory

1
Press SEARCH.

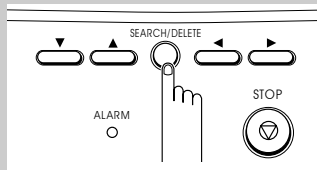

The LCD asks you to press ▲ or ▼, or to choose a letter by pressing a number button.



2
Press ▲ or ▼ to move upward or downward through the directory until you find the number you want.

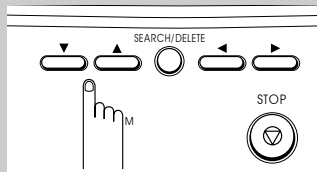

Each time you press ▼ or ▲, the LCD displays the number stored in the next memory.

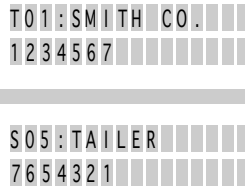

3
When the number you want appears in the display, press START to dial.

If there is a document loaded, the machine will send out the document.

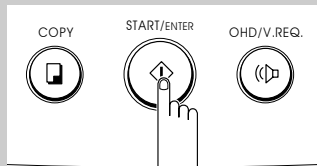

▶ Pressing ▼ allows you to search downward through the entire memory in alphabetical order (from A to Z), and ▲ allows you to search upward in reverse alphabetical order (from Z to A). Scanning is looped – when you search past the last number in memory, you'll start over again at the beginning.

▶ While searching through the machine's memory, you'll see that each entry is preceded by one of three letters: 'T' for One-Touch Dial, 'S' for Speed, or 'G' for Group Dial number. These letters tell you how the number is stored. For information on Group Dial, see page 3.7.

▶ If you press START while a group number is on the display, an error beep sounds and the machine returns to Standby mode.

AUTOMATIC DIALLING

Searching for a Particular First Letter

1
Press SEARCH.

The LCD asks you to press ▲ or ▼, or to choose a letter by pressing a number button.

2
Press the button labeled with the letter you want to search for.

▶ For example, if you want to find the name 'New York,' press the '6' button, which is labeled with 'MNO.'

A name beginning with the letter appears in the display.

▶ Each entry is preceded by one of three letters: 'T' for one-touch, 'S' for speed, 'G' for group. These letters tell you how the number is stored.

If the machine cannot find a name that begins with the letter you selected, the machine beeps and shows the message 'NOT FOUND.'

3
If the name appearing in the display is not the name you want, press ▼ to display the next name in the list, or ▲ to display the previous name.

▶ Pressing ▼ searches downward in alphabetic order. To search upward, press ▲.

4
When the name and number you want appear correctly in the display, press START to dial.

Chapter Four

THE FAX MACHINE

Chapter Four

THE FAX MACHINE

In this chapter, you will learn how to send and receive fax documents, and how to use the four fax reception modes and the Voice Request feature.

➤ Sending a Fax

Acceptable Documents

		Single Sheet	2 or More Sheets
Document Size	Max	216 mm (W) X 356 mm (L)	216 mm (W) X 297 mm (L)
	Min	148 mm (W) X 148 mm (L)	
Effective Scanning Width		210 mm	
Automatic Document Feeder capacity		—	If you use 0.1 mm (20 lbs) thick paper, you can load 30 pages at a time.
Thickness of document		0.07 to 0.15 mm	If you use paper between 0.085 - 0.13 mm thick, you can load 20 pages at a time.
Quality of document paper		Uncoated on both sides	

NOTE : For multiple sheets, the document must be the same size and paper type.

Do not try to send documents that are :

- wet
- covered with wet ink or paste
- wrinkled, curled, or folded
- too thin (less than 0.07 mm thick-onionskin, airmail paper, etc.)
- too thick (more than 0.15 mm thick)
- chemically processed (pressure-sensitive paper, carbon-coated paper, etc.)
- coated (glossy paper, etc)
- too small or short (such as a label, voucher, etc.)
- made of cloth or metal

To send these documents, use an office copier to make a photocopy first, and then send the copy.

THE FAX MACHINE

Setting Document Resolution and Contrast

We recommend sending documents printed using a typewriter, felt tip pen, black ink, or laserwriter. The paper should be white or very light, and of normal weight—not cardboard. Blue lines on a ruled pad don't fax well.

If you send documents with unusual contrast characteristics, including photographs, you can adjust the resolution and contrast to send a high-quality transmission of the documents.

- Press **RESOLUTION** to increase sharpness and clarity. By pressing **RESOLUTION** repeatedly, you can choose **FINE**, **SUPER FINE**, or **STANDARD** mode.

STANDARD works well for normal handwritten typed, or printed documents. When **STANDARD** is selected, all lamps about the **RESOLUTION** button are off.

FINE is good for documents containing a lot of detail. When **FINE** is selected, the **FINE** lamp lights.

SUPER FINE works well for documents containing extremely fine detail. When **SUPER FINE** is selected, **SUPER FINE** lamp lights. **SUPER FINE** works only if the remote machine also has the **SUPER FINE** feature.

You can not use **SUPER FINE** mode for memory transmission.

- Press **CONTRAST** to compensate for the brightness or darkness of your faxed document. By pressing **CONTRAST** repeatedly, you can choose between **DARKEN**, **LIGHTEN**, **PHOTO**, or **NORMAL**.

DARKEN works with light print or faint pencil markings. When **DARKEN** is selected, the **DARKEN** lamp lights.

LIGHTEN works with dark print. When **LIGHTEN** is selected, the **LIGHTEN** lamp lights.

PHOTO is used when faxing photographs or other documents containing color or shades of grey. Although your machine won't transmit color, it will print and send up to 32 shades of grey. When **PHOTO** is selected, both **LIGHTEN** and **DARKEN** lamps light.

NORMAL works well with standard typed or printed documents. When **NORMAL** is selected, both **LIGHTEN** and **DARKEN** lamps are off.

THE FAX MACHINE

Loading Document

1

Turn the page face down.

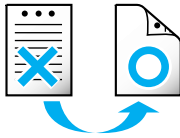

▶ Be sure that your document is free of staples, paper clips, and other foreign objects.

2

Adjust the document guides to match the width of the document.

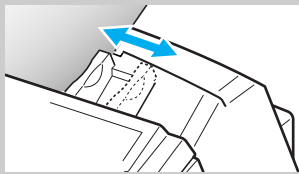

▶ You can insert up to 30 sheets at a time. If you insert more than one sheet, make sure the bottom sheet enters first. Stagger the leading edge of the sheets slightly, and insert the sheets with a slight push to ensure smooth feeding.

3

Slide the sheet down into the document tray until it's gripped by the machine.

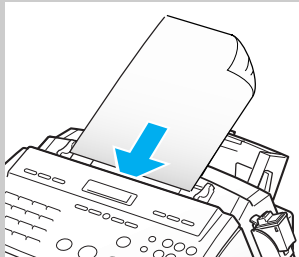

The machine beeps, and the automatic document feeder seizes and pulls in the page.

If you want to add pages while the fax is sending, insert them into the loading slot on top of the already loaded sheets.

Do not place more than 30 sheets in the feeder at a time.

If you're loading pages that are unusually thick or thin, feed one sheet at a time.

The LCD displays 'DOCUMENT LOADING' then 'DOCUMENT READY.'

MAY-10-1996 FRI
DOCUMENT READY

If the document doesn't feed correctly, open the control panel and remove the document and try loading it again.

You can choose the proper document resolution and contrast, if necessary.

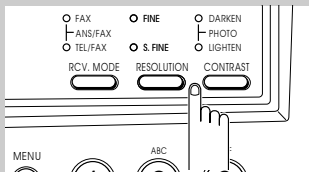

Now, you can dial the desired number. See page 4.4.

▶ For more information about document resolution and contrast, see page 4.2.

THE FAX MACHINE

Using Quick Scan

You can send a fax using Quick Scan feature. The machine will quickly scan the document.

To enable this feature, press MENU and Q.SCAN on the one-touch keypad before dialling the other machine. The LCD displays 'QUICK SCAN IS ENABLED' for 2 seconds.

Notes :

- To cancel this feature, press MENU and Q.SCAN again before you send a fax. The LCD displays 'QUICK SCAN IS DISABLED.'
- After sending a document, Quick Scan feature is terminated automatically.
- If Quick Scan is enabled, the scanning quality may not be good.
- Quick Scan feature is only available with STANDARD resolution.

Sending a Fax Automatically

1

Using the number keypad, enter the number of the remote fax machine.

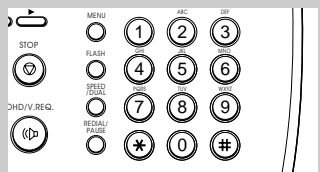

▶ You can store One-Touch or Speed Dial numbers so that you can dial your most frequently used numbers with a touch of a button or 2-digit Speed Dial number. For more information, see page 3.1 or 3.4.

The LCD displays the number.

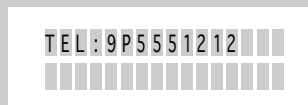

▶ If you make a mistake while entering a number, move the cursor under the wrong digit by using ◀ or ▶, and correct the number.

To insert a pause when dialling, press PAUSE anywhere within the telephone number. A pause will be displayed as a 'P'.

2

Press START when the number appears correctly in the display.

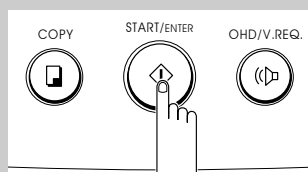

▶ You can cancel the transmission of a document at any time by pressing STOP.

The machine automatically dials the number and begins to transmit when the remote fax machine answers the phone.

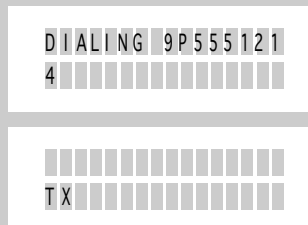

▶ You can send or receive a voice request when you send a fax. For more information about the Voice Request feature, see page 4.12.

THE FAX MACHINE

Sending a Fax After Talking

1
Pick up the handset.

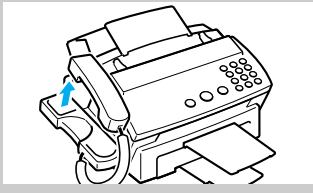

▶ For hands-off operation, you can press OHD. To adjust speaker volume, press ▼ or ▲ while you hear tones from the speaker, and select the desired loudness.

The LCD displays 'PHONE.'



2
Using the number keypad, enter the number of the remote fax machine.

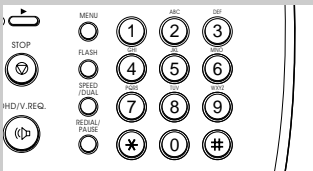

▶ You can store One-Touch or Speed Dial numbers so that you can dial your most frequently used numbers with a touch of a button or 2-digit Speed Dial number. For more information, see page 3.1 or 3.4.

The LCD displays the number you are dialing.

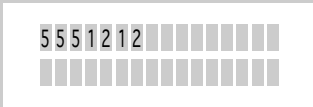

▶ If a person answers the telephone, ask him or her to press START so that you can send the document.

3
Press START when you hear the fax tone.

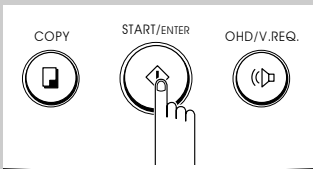

▶ You can cancel the transmission of a document at any time by pressing STOP.

The LCD displays the message 'TX' and the document begins to feed through the machine.

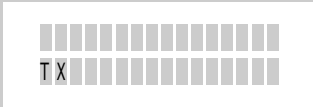

4
Replace the handset.

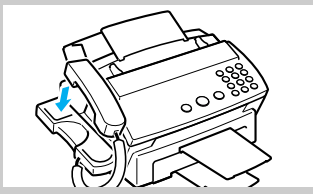

▶ You can send or receive a Voice Request when you send a fax. For more information about the Voice Request feature, see page 4.12.

THE FAX MACHINE

Confirming Transmission

When the last page of your document has been sent successfully, the machine beeps and returns to Standby mode.

JUN-14 1996 FRI
10:30 AM 100%

▶ If something went wrong during your fax transmission, an error message appears in the display. For a listing of LCD error messages and their meanings, see page 8.4.

If you receive an error message, press STOP to clear the message and try to send the document again.

You can set your machine to print out a confirmation report automatically. For more information, see page 6.9.

Cancelling Transmission

1

Press STOP at any time to cancel transmission.

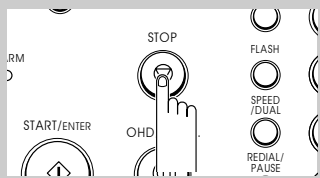

The machine continues to send the fax and the LCD displays a message warning you that the machine is in use.

IN USE! PRESS
[STOP] TO CANCEL

2

Press STOP again before the warning message disappears and the transmission will stop.

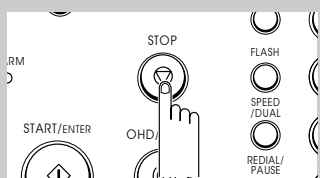

Automatic Redial

When you send a fax, if the number you have dialled is busy or there is no answer, the machine will automatically redial the number every three minutes up to three times. (Automatic Redialling varies by country, i.e., it might occur twice at two-minute intervals.)

While the machine is redialling, the display will show 'BUSY! RETRY?.' To immediately redial the number, press START. To stop redialling, press STOP.

THE FAX MACHINE

▶ Receiving a Fax

Reception Modes

Your multi-function machine has four reception modes:

- In TEL mode, automatic fax reception is turned off. You can receive a fax only by manually pressing START.
- In FAX mode, the machine answers an incoming call and immediately goes into receive mode, waiting for a fax to be sent.
- In TEL/FAX mode, the machine answers an incoming call expecting to receive a fax. If the machine does not sense a fax signal, it will sound another ringing tone to tell you it is a phone call. If you do not lift the handset during the secondary ringing, the machine will switch to automatic fax reception mode.
- In ANS/FAX mode, the answering machine answers an incoming call, and the caller can leave a message on the answering machine. If the fax machine senses a fax tone on the line, the call automatically switches over to the fax machine. To use the ANS/FAX mode, you have to attach an answering machine to the EXT. LINE socket on your fax machine (see page 2.5).

The lamps located above the RCV.MODE button indicate the selected reception mode.

If you seldom use the fax line for voice conversations, set the fax machine to receive a fax automatically by selecting either FAX mode or TEL/FAX mode.

Notes :

- The receiving speed varies according to the memory capacity used.
- While you print a PC file with this machine (for SF4100, SF4200 only), an incoming fax will be received in memory. If you have a lot of pages to print, we recommend to stop PC printing to prevent memory from being full.

THE FAX MACHINE

Receiving in FAX Mode

- 1**
Press RCV.MODE repeatedly until the FAX lamp lights.

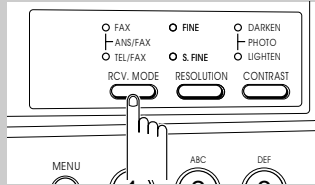

- 2**
When you get a call, the machine answers the call on the second ring and receives a fax automatically.

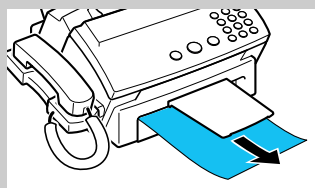

▶ You can change the number of rings. For more information, see page 6.9.

To adjust ringer volume, see page 2.28.

When reception is complete, the machine returns to Standby mode.

Receiving in TEL/FAX Mode

- 1**
Press RCV.MODE until the TEL/FAX lamp lights.

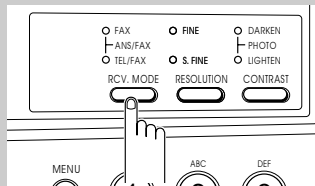

- 2**
When you get a call, the machine answers the call on the second ring and receives a fax automatically.

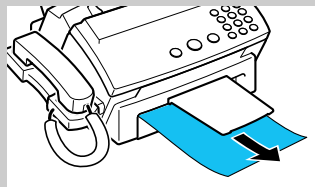

▶ You can change the number of rings. For more information, see page 6.10.

To adjust ringer volume, see page 2.28.

When reception is complete, the machine returns to Standby mode.

- 3**
If the machine does not sense a fax signal, your machine will give another ringing tone to tell you it is a phone call.

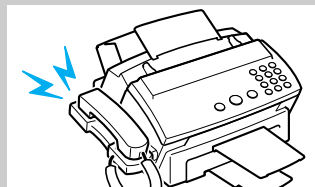

▶ Lift the handset to answer the call. If you do not pick up the handset within about 25 seconds, the machine will switch to automatic reception mode.

THE FAX MACHINE

Receiving in ANS/FAX Mode

1

Press RCV.MODE until both FAX and TEL/FAX lamps light.

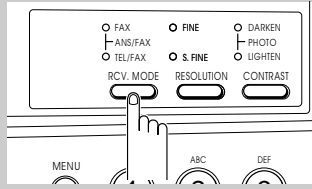

▶ To use this mode, you have to attach an answering machine to your fax machine (see page 2.5).

2

When you get a call, the answering machine answers it. If the caller leaves a message, the answering machine stores the message.

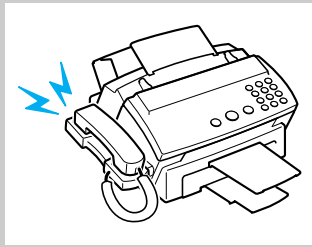

▶ If you have set your machine to ANS/FAX and your answering machine is switched off, or the answering machine is not connected to your fax machine, the fax machine will automatically go into receive mode after several rings.

If your machine hears a fax tone on the line, it starts to receive a fax.

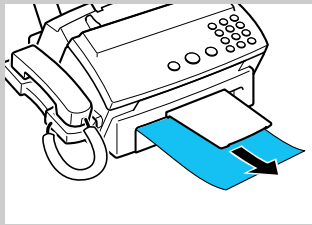

If you are in TEL mode (manual reception) when the answering machine is connected to your fax machine, you must switch off the answering machine, or the outgoing message from the answering machine will interrupt your phone conversation.

Receiving Manually (in TEL Mode)

1

Press RCV.MODE until both FAX and TEL/FAX lamps are off.

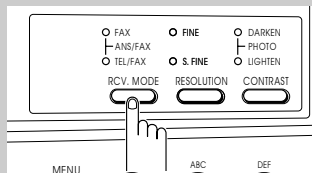

2

When the telephone rings, pick up the handset and answer it.

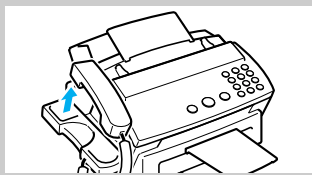

▶ To adjust ringer volume, see page 2.28.

3

If you hear a fax tone, or if the person on the other end asks you to receive a document, press START.

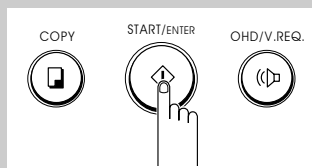



4

THE FAX MACHINE

4

Replace the handset.

The machine begins receiving and returns to standby mode when the reception is complete.

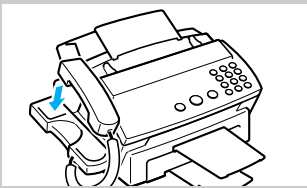

Cancelling Reception

1

Press STOP to cancel reception at any time.

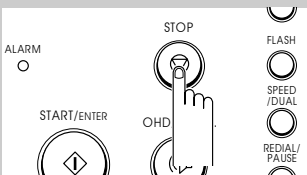

The machine continues to receive the fax and the LCD displays a message warning you that the machine is in use.

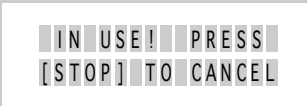

2

Press STOP again before the LCD message disappears.

The fax reception is cancelled and the machine returns to standby mode.

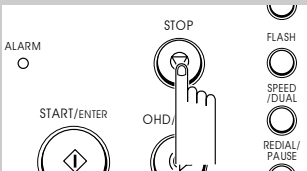

THE FAX MACHINE

Using an Extension Telephone

You can receive a fax from someone you are talking to on the extension telephone without having to go to the fax machine.

1

When you receive a call on the extension phone and hear fax tones, press the buttons '* 9 *' (star nine star) on the extension telephone.

The machine receives the document.

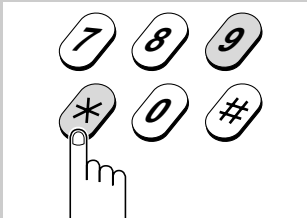

▶ Press the buttons slowly in sequence. If you still hear the fax tone from the remote machine, try pressing '* 9 *' once again.

'* 9 *' is the remote receive start code preset at the factory. The first and the last asterisks are fixed, but you can change the middle character to whatever you choose. For more information, see page 6.9.

2

When you are finished speaking and the machine begins receiving documents, replace the handset of the extension telephone.



This feature is available only when you use an extension telephone connected to the EXT.LINE jack on the back of the machine.

Recording Area

The effective recording area is inside the shaded area as follows for all acceptable recording paper. Portions outside the shaded area may not be recorded.

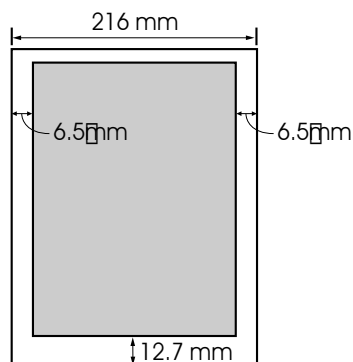

▶ If there is image at this bottom area, the machine may reduce the page to fit in the effective recording area according to the option you have chosen. See page 6.9.

THE FAX MACHINE

▶ **Voice Request**

If you're sending or receiving a document and need to speak to the other person during the same phone call, use Voice Request to alert the person at the remote site. You can also respond to a Voice Request made by the person at the remote end.

Sending a Voice Request

- 1**
Press V.REQ while a document is being sent or received.

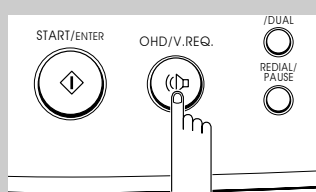

▶ You can't talk with the other person and send a fax at the exact same time.

After the fax has finished, you or the person at the remote end has 15 seconds to pick up the handset. If no one answers, your machine returns to Standby mode.

Voice Request signal is sent to the remote fax machine after the document has been sent or received.

```
VOICE REQUEST
TX G3 9.6 P: 1
```

If you can't seem to alert the other person, it may be because the remote fax machine doesn't have the Voice Request feature.

- 2**
When the phone rings, pick up the handset and answer it.

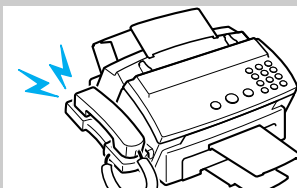

- 3**
When you are finished, replace the handset.

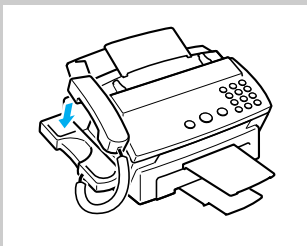

▶ When you've finished talking, if you have another document to send, load the document and tell the other person to press START. When you hear the fax tones, press START.

You can cancel a Voice Request by pressing V.REQ. again.

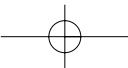

THE FAX MACHINE

Answering a Voice Request

1

When the phone rings, pick up the handset and answer it.

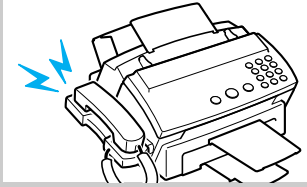

▶ If you don't answer the Voice Request within 15 seconds, the machine prints out the number that made the Voice Request, and the time and date the request was made. See 'Call Back Message' below.

2

When you are finished, replace the handset.

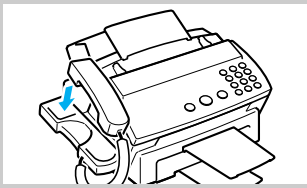

▶ If the Voice Request occurred while receiving, you can resume receiving on the same line after talking with the other end by pressing START.

<Call Back Message>

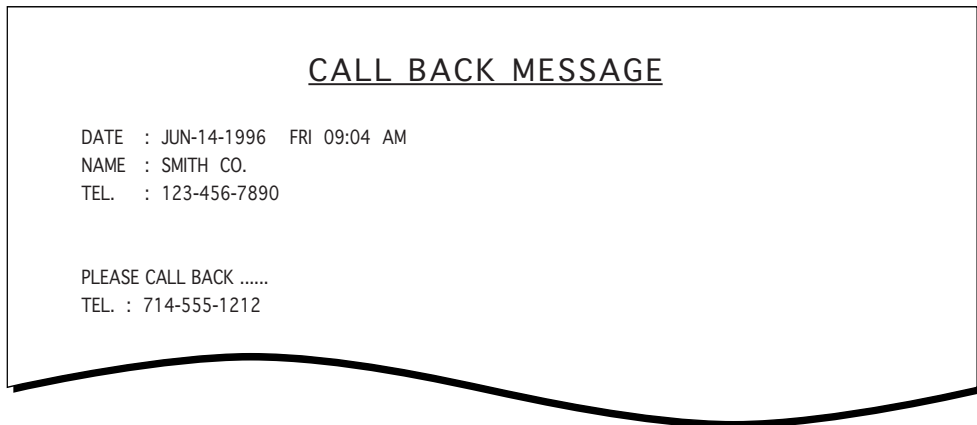

▶ If a terminal ID is not programmed in the other machine when it is sending you a fax, a phone number will not appear on the call back message list.

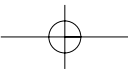

Chapter Five

ADVANCED OPERATIONS

Chapter Five

ADVANCED OPERATIONS

In this chapter, you will learn other ways to send and receive faxes to save transmission costs by sending at preset times, to maintain the privacy of sensitive documents, and to save time by sending the same documents to many different locations.

Note : You can store a maximum of 20 different sending or polling jobs in memory.

➤ Memory Transmission (Broadcasting)

With Memory Transmission, documents are automatically stored in memory and sent to a remote station. You can use this feature to send your documents to multiple locations. After sending, the documents are automatically erased from memory.

1
Load the document.

Choose the resolution and contrast, if necessary.

The diagram shows a document being inserted into the top of a fax machine. Below, the control panel features several settings: FAX, ANS/FAX, TEL/FAX, RCV. MODE, RESOLUTION (with options FINE and S. FINE), and CONTRAST (with options DARKEN, PHOTO, and LIGHTEN). A hand is shown pressing the '1' button on the numeric keypad.

➤ For details on how to load a document, see page 4.3.

For details on setting resolution and contrast, see page 4.2. SUPER FINE mode is not available in Memory Transmission.

2
Press MENU.

The diagram shows the control panel with a hand pressing the 'MENU' button, which is located between the 'STOP' and 'FAX' buttons.

3
Press 01, MEMORY TX., on the one-touch keypad.

The diagram shows a one-touch keypad with 16 buttons labeled 01 through 16. The '01' button is highlighted with a hand icon. The buttons are arranged in a grid: 01-05 in the first row, 06-10 in the second, 11-15 in the third, and 16 in the fourth.

The LCD asks you to enter the number of the remote machine.

The diagram shows the LCD screen with the text 'TEL:' followed by a series of 10 empty rectangular boxes for entering a telephone number.

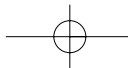

ADVANCED OPERATIONS

4
Enter the number of the remote machine (up to 34 digits).

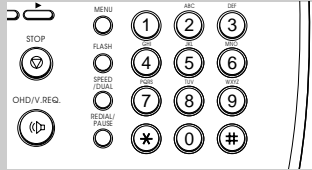

▶ You can press a one-touch button, a 2-digit Speed Dial number, or a one-touch Group Dial button. The stored number and name appear in the display.

5
Press ENTER when the number appears correctly in the display.

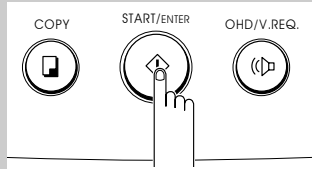

The LCD asks if you want to enter another fax number to send the same document to another location.



▶ The machine shows the 'ANOTHER FAX NUMBER?' message repeatedly up to 10 times each time you enter another fax number using manual dialling, One-Touch, or 2-digit Speed Dialling (you can not use a Group number for another fax number).

6
If you want to send to more than one location, press ENTER and repeat steps 4-5.

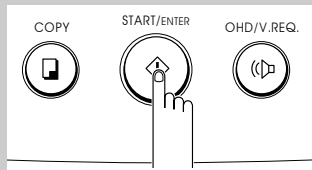

or
If you want to send to one location or when you complete the another fax number setting, press STOP or ▼.

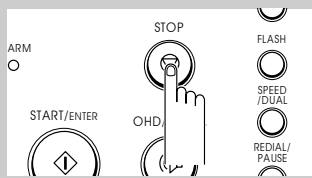

But if you have used this multi-address transmission feature in other operation(s) currently registered in memory, the maximum attempt number of '10' will be reduced.

If you enter another fax number already in the another fax number memory (for example, included in a group number), the LCD displays 'ALREADY SET.'

The machine stores the document automatically in memory. The LCD counts the number of pages stored in memory and the memory capacity remaining.

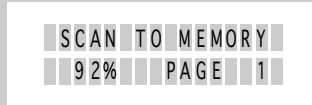

▶ If you can't fit all the pages in memory, the LCD displays 'MEMORY FULL 1:CANCEL 2:DONE'. Select '1' to cancel the job, or '2' to store the pages already in memory, and send the remaining pages manually.

The LCD displays the number being dialled.

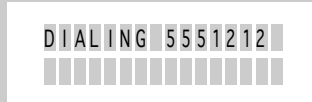

Then the machine begins sending the document.

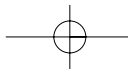
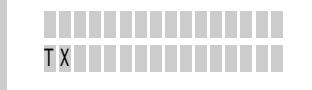

ADVANCED OPERATIONS

Delayed Transmission

You can set up your machine to send a fax at a later time when you will not be present.

1
Load the document.

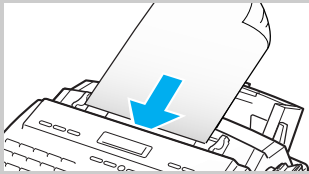

Choose the resolution and contrast, if necessary.

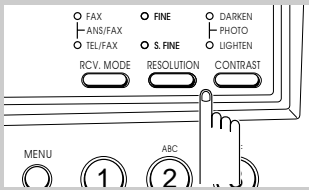

For details on how to load a document, see page 4.3.

For details on the resolution and contrast, see page 4.2. SUPER FINE resolution is not available in Delayed Transmission.

2
Press MENU.

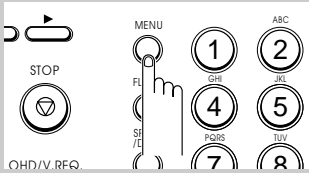

The LCD asks you to press the desired function button.



One-touch buttons 01-16 perform specific functions when used with the MENU button. Each button provides access to a selected function.

3
Press 02, DELAY TX., on the one-touch keypad.

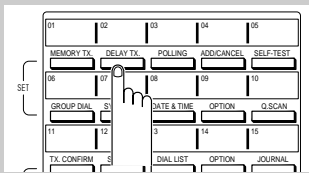

The LCD asks you to enter the number of the remote machine.

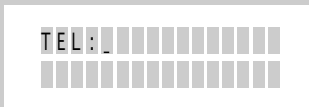

4
Enter the number of the remote machine (up to 34 digits).

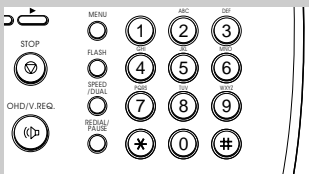

You can press a one-touch button, a 2-digit Speed Dial number, or a one-touch Group Dial button. The stored number and name appear in the display.

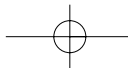

5

ADVANCED OPERATIONS

5

Press ENTER when the number appears correctly in the display.

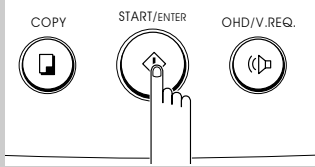

The LCD asks you if you want to enter another fax number to send the same document to another location.

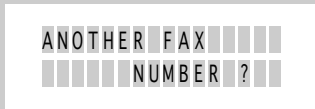

▶ The machine displays the 'ANOTHER FAX NUMBER?' message repeatedly up to 10 times each time you enter another fax number using manual dialling, One-Touch, or 2-digit Speed Dialling (you can not use Group number for another fax number).

6

If you want to send to more than one location, press ENTER and repeat steps 4-6.

or

If you want to send to one location or when you complete the another fax number setting, press STOP or ▼.

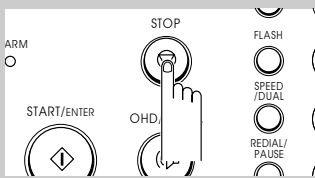
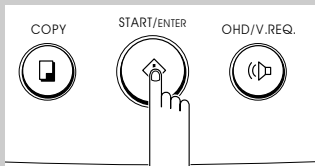

But if you have used this multi-address transmission feature in other operation(s) currently registered in memory, the maximum attempt number of '10' will be reduced.

If you enter another fax number already in the another fax number memory (for example, included in a Group number), the LCD displays 'ALREADY SET.'

The LCD asks you to enter a name.

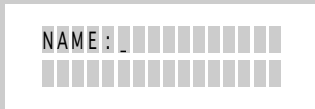

7

If you want to assign a name to the transmission, enter the name. If not, skip this step.

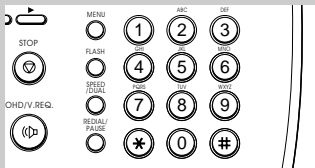

▶ For details on how to enter letters using the number keypad, see page 2.27.

8

Press ENTER when the name appears correctly.

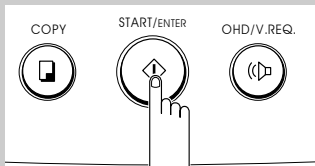

▶ You can press ▼ to confirm the number and proceed to the next.

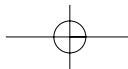

ADVANCED OPERATIONS

The LCD displays the current time on the upper line and asks you to enter the start time when the fax is to be sent.



The LCD display shows two lines of text: 'CURRENT' followed by a series of vertical bars and the time '13:30'. Below it, 'START' is followed by another series of vertical bars and the format 'HH:MM'.

9 Enter the time by using the number keypad.



The image shows a control panel with several buttons: STOP, MENU, FLASH, SPEED/DUAL, OHD/V.REQ., REDIAL/PAUSE, and a numeric keypad (0-9, *, #).

Enter the time in 24-hour format. For example, enter 2230 for 10:30 P.M.

If you set a time earlier then the current time, the document will be sent at that time on the following day.

10 Press ENTER when the time appears correctly in the LCD display.

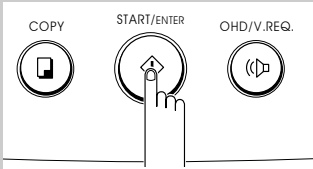

The image shows the control panel with a hand pointing to the START/ENTER button. Other buttons visible are COPY and OHD/V.REQ.

The LCD asks if you want to store the document in memory until it needs to be sent.



The LCD display shows 'TO MEMORY?' on the top line and '(REMAINED: 75%)' on the bottom line.

The LCD displays the remaining memory.

If you have entered several fax numbers in step 8, the message shown at left does not appear, and the documents will be stored in memory automatically.

11 If you want to store the document in memory, press ENTER. or Press STOP and the LCD returns to Standby mode.

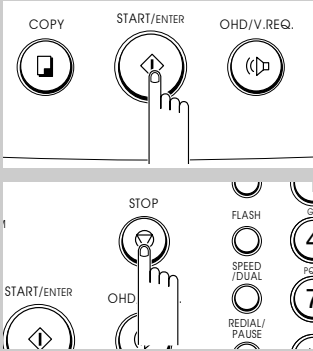

The image shows two parts of the control panel. The top part shows a hand pressing the START/ENTER button. The bottom part shows a hand pressing the STOP button.

If you can't fit all the pages in memory, the LCD displays 'MEMORY FULL 1:CANCEL 2:DONE'. Select '1' to cancel the job or '2' to store the pages already in memory, and send the remaining pages manually.

The machine returns to Standby mode and the LCD displays a reminder that a Delayed Transmission is set.

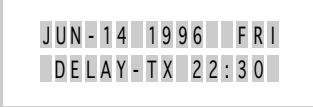

The LCD display shows two lines of text: 'JUN-14 1996 FRI' and 'DELAY-TX 22:30'.

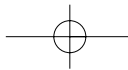

ADVANCED OPERATIONS

▶ **Polling**

Polling is when one fax machine requests another to send a document. This is useful when the person with the original document to be sent is not in the office. The person who wants to receive the document calls the machine holding the original and requests that the document be sent. In other words, it “polls” the machine holding the original.

Being Polled By a Remote Machine

You can program your fax machine to send documents in your absence when polled by a remote fax machine. It is possible to use a Poll code to prevent unauthorized Polling of your fax machine. When you secure your machine in this manner, only those who know the Poll code can poll your machine.

Note : Once you have set up a Polling Transmission, another Polling Transmission is not possible until the transmission is completed.

1
Load a document.

Choose the resolution and contrast, if necessary.

▶ For information on loading a document, see page 4.3.

2
Press MENU.

The LCD asks you to press the desired function button.

For details on setting resolution and contrast, see page 4.2. SUPER FINE resolution will automatically switch to FINE to store the Polling job in memory.

▶ One-touch buttons 01-16 perform specific functions when used with the MENU button. Each button provides access to a selected function.

3
Press 03, POLLING, on the one-touch keypad.

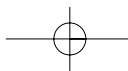

ADVANCED OPERATIONS

The LCD asks if you want to enter a Poll code.

4
 If you want to use a Poll code, select '1:ON' by pressing 1 or by using ◀ or ▶ button and entering a 4-digit Poll code (except for 0000).
 or
 If you do not want to secure the transmission with a Poll code, select '2:OFF' by pressing 2 or by moving the cursor using ◀ or ▶ button.

▶ The LCD shows the last used Poll code.

The Poll code is preset to 0000 at the factory which represents no Poll code.

5
 Press ENTER when the code appears correctly in the display.

The machine stores the document in memory. The LCD counts the number of pages being stored in memory and the memory capacity remaining.

▶ If you can't fit all the pages in memory, the LCD displays 'MEMORY FULL 1:CANCEL 2:DONE'. Select '1' to cancel the job, or '2' to store the pages already in memory and cancel the remaining pages.

If memory is not enough, set Polling again when memory becomes available.

The machine returns to Standby mode and the LCD displays a reminder that a Polling Transmission is set.

▶ The machine automatically switches to FAX mode (automatic receiving) when set to be polled.

ADVANCED OPERATIONS

Polling a Remote Machine

1
Lift the handset or press OHD, and enter the number of the remote machine.

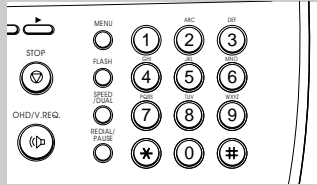

▶ The remote machine must be ready for your call.

2
When you hear a fax tone from the remote machine, press MENU.

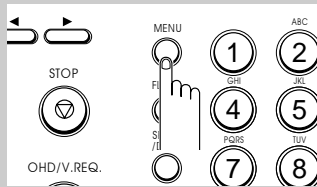

3
Press 03, POLLING, on the one-touch keypad.

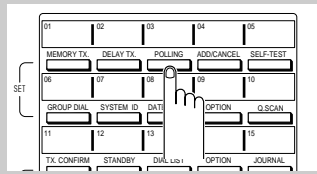

▶ One-touch buttons 01-16 perform specific functions when used with the MENU button. Each button provides access to a selected function.

The LCD asks if you want to enter a Poll code.

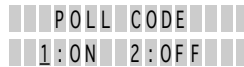

4
If the remote machine is secured with a Poll code, you must enter the proper code. Select '1:ON' by pressing 1, or by using ◀ or ▶ and pressing ENTER. Then, enter a 4-digit code.

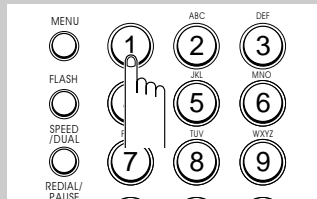

or
If the remote machine is not secured with a Poll code, select '2:OFF' by pressing 2, or by using ◀ or ▶ and pressing ENTER.

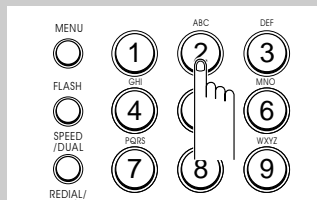

▶ If the remote machine is not secured with a Poll code, your machine starts to receive the document from the remote machine after you select '2:OFF.'

5
Press ENTER.

Your machine starts to receive the document from the remote machine.

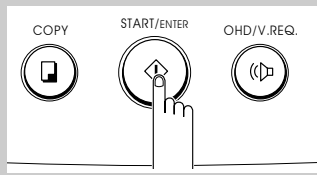

ADVANCED OPERATIONS

Adding Documents To a Standby Operation

You can add documents to a Delayed or Polling Transmission previously reserved in your machine's memory. Prior to performing this procedure, make a printout of the Standby Job list and confirm the particular operation to which your document will be added.

Confirming the Operation Number

1
Press MENU.

2
Press 12, STANDBY, on the one-touch keypad.

The Standby Job List prints.

3
Confirm the operation number in the Standby Job List.

STANDBY JOB LIST

DATE : APR-09-1996 TUE 08:30 AM
 NAME : HEADQUARTERS
 TEL. : 714-555-1212

NO	TIME	POLLCODE	TELEPHONE NUMBER	NAME	PAGE	MODE
01	10:35		2264523218	HELEN	02	DELAY TX
02	22:15		ONE-TOUCH[01] SPEED[01] 7142262880	VACATION SCHEDULE	01	BROADCAST
03		2580			01	POLL-TX

operation number ———

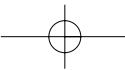

ADVANCED OPERATIONS

Adding Documents To a Standby Operation in Memory

1
Load a document.



Choose the resolution and contrast, if necessary.

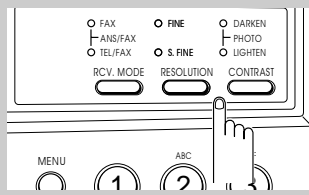

For details on how to load a document, see page 4.3.

For details on setting resolution and contrast, see page 4.2. SUPER FINE resolution is not available.

2
Press MENU.

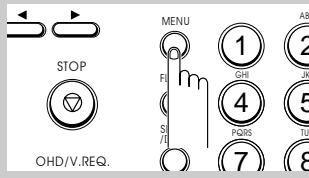

3
Press 04, ADD/CANCEL, on the one-touch keypad.

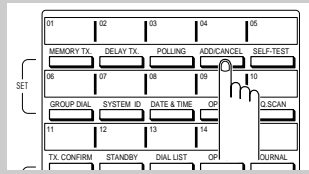

The LCD asks you to choose between 'ADD' and 'CANCEL'.



4
Move the cursor under 'ADD' by using ◀ or ▶, or by pressing 1.

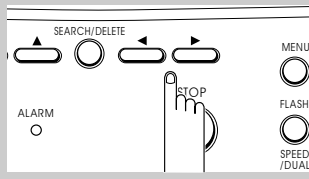

5
Press ENTER.

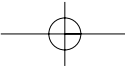
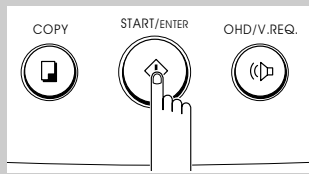

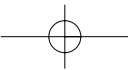

ADVANCED OPERATIONS

The LCD asks you to enter a 2-digit operation number.

6
Enter the 2-digit operation number to which you want to add document.

7
Press ENTER.

The LCD asks you to confirm the operation number.

8
Press ENTER if the number is correct.

The machine automatically stores the documents in memory, then returns to Standby mode.

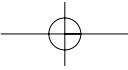

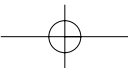

ADVANCED OPERATIONS

► **Cancelling a Standby Operation**

You can cancel a previously set Delayed or Polling transmission. Prior to performing this procedure, make a printout of the Standby Job list and confirm the operation number you want to cancel. For details on confirming the operation number, see page 5.9.

1
Press MENU.

2
Press 04, ADD/CANCEL, on the one-touch keypad.

The LCD asks you to choose between 'ADD' and 'CANCEL'.

3
Move the cursor under 'CANCEL' by pressing 2, or by using ◀ or ▶ and pressing ENTER.

The LCD asks you to enter a 2-digit operation number.

4
Enter the 2-digit operation number you want to cancel.

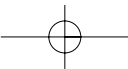

ADVANCED OPERATIONS

5
Press ENTER.

The LCD asks you to confirm the operation number.

6
Press ENTER if the number is correct.

The LCD asks you to enter another operation number, if you need.

7
Repeat steps 4-6 to cancel another standby operation.
To return to Standby mode, press STOP.

▶ When all Standby operations have been CANCELED, 'THERE IS NO ENTRY' will be displayed and the machine will return to Standby mode.

Chapter Six

SPECIAL FEATURES

Chapter Six

SPECIAL FEATURES

➤ Using REDIAL/PAUSE

The REDIAL/PAUSE button has two functions. It can be used to redial the number you last called or it can be used to insert a pause in a number when you are setting up a One-Touch or Speed Dial number. The redial memory in your machine can hold the last 5 numbers called. If you have dialed the same number as one of the 5 last-dialed numbers, the machine does not count that number as a redial number.

To redial the number you last called

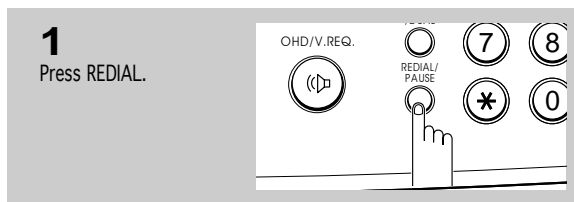

▶ If you are making a phone call, pick up the handset when the other person answers.

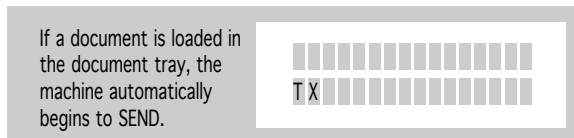

Searching through redial memory

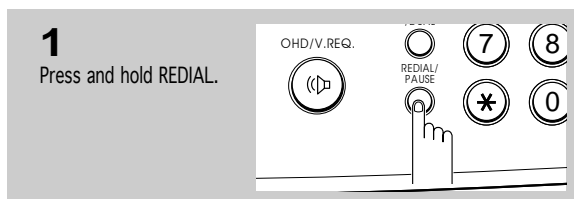

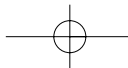

6

SPECIAL FEATURES

2

Press ▼ or ▲ to move downward or upward through memory until you find the number you want.

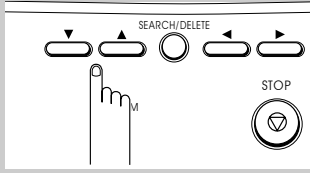

Each time you press the button, another one of the 5 last-called numbers appears in the display.

3

When the number you want appears in the LCD display, press START to dial.

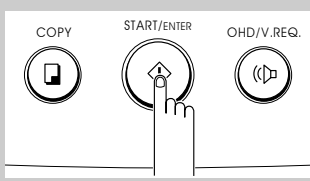

To stop redialling, press STOP. The machine returns to Standby mode.

If you press DELETE when you find a number, that number will be deleted.

If a document is loaded in the document tray, the machine automatically begins to SEND.

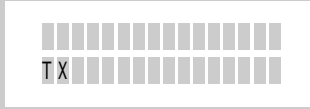

With some private telephone systems, you must dial an access code (9, for example) and listen for a second dial tone before dialling an outside number. In such cases, you must insert a pause in the number.

To insert a pause

1

While entering the number, press PAUSE.

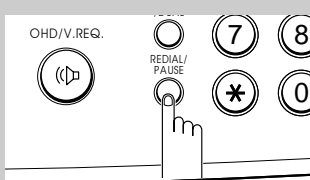

When you dial a number, the unit pauses for about 3 seconds at the point where you pressed PAUSE.

If you require a longer pause time, press PAUSE twice.

➤ Using TONE (Switching from Pulse to Tone)

You may often need to use Touch Tone dial signals to perform special operations by phone. Bank-by-phone and voice mail are two examples of systems that require these tone signals. If you have pulse service, you can still send Touch Tone signals by following these steps.

1

Dial the number using pulse dialling.

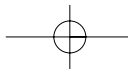
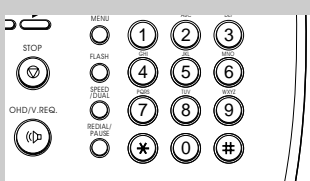

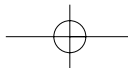

SPECIAL FEATURES

2
When the remote phone answers, press * .

Any numbers you now press will be sent as Touch Tones for the remainder of the call.

3
Dial the remaining numbers required by the service.

▶ The machine returns to the pulse mode after you finish the call.

▶ **Using FLASH (on a PABX system)**

When a call comes in and you want to connect the caller to another party, you can transfer the call by pressing FLASH and dialling the number of the other party. This is a timed-break recall facility only, and may not be compatible with some phone system. Contact your telephone supplier.

1
When you are on the telephone and want the caller to be connected to another party, press FLASH.

▶ If you are not subscribed to a special service that uses the switch-hook signal, don't press FLASH during a call—you could disconnect the line.

2
Enter the number of the other party.

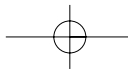

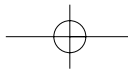

SPECIAL FEATURES

► **Chain Dialling a Memory Number**

When using special computer services, such as alternate long distance carriers, credit card calls, or bank-by-phone, you must dial the telephone number of the service and wait for the computer to answer before continuing. The length of time before the computer answers can vary, so using a pre-programmed pause after a service number is not advised.

However, you can store your ID number, for example, in one memory location and the rest of the information, such as your card number, in another memory location.

1
Lift the handset or press OHD.

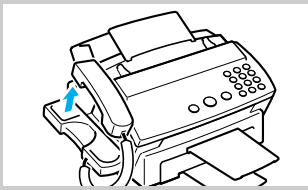

2
Dial the service number using the dial keypad.

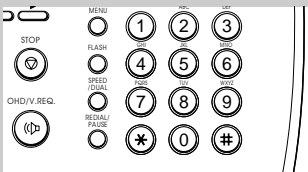

3
When the computer answers, dial the other information by pressing a one-touch button or by entering a speed dial number.

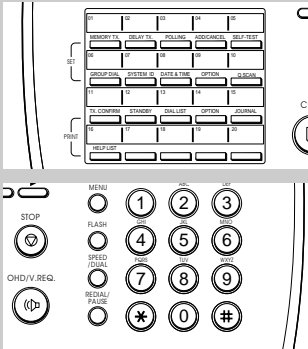

◀ Group number can not be used for chain dial.

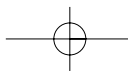

SPECIAL FEATURES

► Help List

You can print a Help list of the machine's basic functions and commands to use as a quick reference guide.

1
Press MENU.

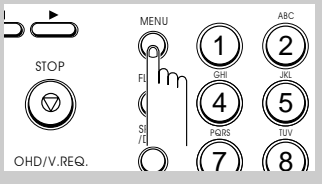

2
Press 16, HELP LIST, on the one-touch keypad.

The machine prints the Help list.

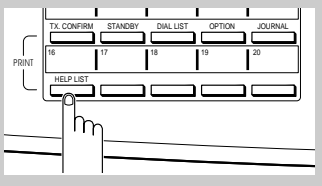

► Dual Access

The dual access feature of your machine can save both time and money, and enhance fax productivity.

When the machine is transmitting a document from memory, other operations can be reserved. When the current operation concludes, the reserved operation will automatically begin.

To reserve a transmission while the fax machine is receiving a document in memory or transmitting a document from memory, place the new document in the feeder. Perform the procedure as described in 'Memory Transmission.' If Memory Transmission is enabled, the document will be scanned into memory, and transmitted when the current operation concludes.

The dual access feature also allows user-selectable functions such as storing numbers in memory while performing memory operations. The user-selectable operation can be entered by pressing MENU and the required function buttons on the one-touch keypad.

1
Perform another operation while the machine is in use.



2
To toggle between the current operation and the new operation, press DUAL.

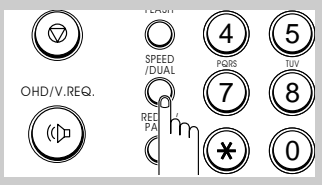

▶ For example, set the machine to perform a Delayed Transmission (see page 5.3) while the machine is receiving a fax in memory.

▶ The LCD displays alternately the current operation and the new operation each time you press DUAL.

SPECIAL FEATURES

► **User Reports**

Your fax machine can print reports containing useful information - standby job, option setting, etc. The following reports are available:

Selectable Reports

- **Confirmation Report** - This report can be printed on command or, by selecting the appropriate user option, automatically after each document you send.
- **Standby Job List** - This list shows the currently stored documents for delayed or polling transmission. The list shows the operation number, starting time, type of operation, etc.
- **Telephone Number List** - This list shows all of the numbers currently stored in the fax machine's memory as One-Touch Dial numbers, Speed Dial numbers, and Group Dial numbers.
- **Option List** - This list shows the status of the user-selectable options. After you change the settings, print this list to confirm your changes.
- **Tx/Rx Journal List** - This list shows the most recent transmission and reception activities.
- **Help List** - This list shows the machine's basic functions and commands to use as a quick reference guide. You can also use the function menu to remind you how to set a particular function and which buttons to press.
- **Multi-Communication Report** - This report is printed out automatically after sending your document to more than one location.
- **Call Back Message** - This report is printed out automatically when you do not respond to a remote operator's Voice Request.
- **Power Failure Report** - This report is printed out automatically when power is resupplied after a sudden power failure. This report shows erased data (if any) by the power failure.

Printing Reports

1
Press MENU.

The LCD asks you to press the desired function button.

■■■■■ PRESS ■■■■■
FUNCTION BUTTON

◀ One-touch buttons 11-16 are assigned to 'PRINT LIST' functions.

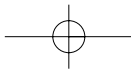

SPECIAL FEATURES

2

Press the function button (one-touch button 11 through 16) that corresponds to the list you want to print.

The selected list is printed.

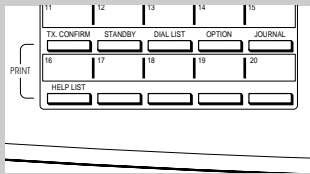

- 11 : TX. CONFIRMATION REPORT
- 12 : STANDBY JOB LIST
- 13 : DIAL NO. (telephone numbers) LIST
- 14 : OPTION LIST
- 15 : TX/RX JOURNAL
- 16 : HELP LIST

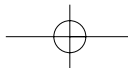

6

SPECIAL FEATURES

► **User Options**

Your fax machine has various user-selectable features. These options are preset at the factory, but you may need to change them. To find out how the options are currently set, print an Option report. For more information on printing a report, see page 6.6.

Setting an Option

1
Press MENU.

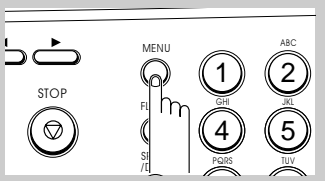

The LCD asks you to press the desired function buttons.



2
Press 09, OPTION, on the one-touch keypad.

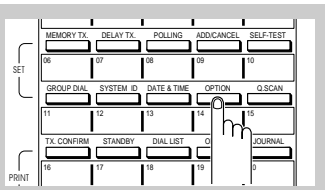

The LCD displays the options you may select.



▶ The blinking digit indicates the currently selected level.

3
Scroll to the option you want to set by pressing ▲ or ▼ repeatedly until you find the one you want.

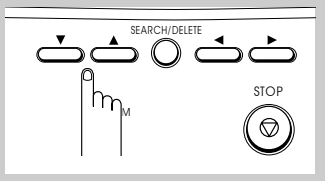

▶ For more information about each option, see 'Selectable Options' on page 6.9.

4
When the option you want appears in the display, enter the number for that option.

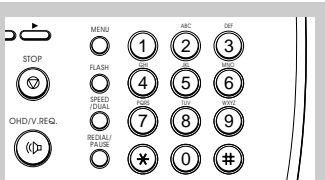

▶ You can exit from Setup mode at any time by pressing STOP. When you press STOP, the machine stores the options you've already changed and returns to Standby mode.

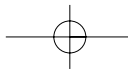

SPECIAL FEATURES

Selectable Options

These instructions assume you've followed the steps above under 'Setting an Option' and the machine is asking if you want to change one of the options listed here.

- **Contrast Level**—Select the expected normal contrast level. DARKEN and LIGHTEN will be based on this normal setting.

Enter a number from 1 through 7 on the number keypad. The higher number entered, the darker normal contrast selected. To adjust the contrast level for PHOTO, you can enter 1, 4, or 7.

- **Paper Size**—Select the paper size you will use for the recording paper.

Press 1 to use letter (LTR) size, 2 to use A4 size, 3 to use legal (LEG) size paper.

- **Reduction Rate (ADJUST REDUCTION)**—When receiving or copying a document as long as or longer than the paper installed in your machine, the machine can reduce the data of the document to fit on your recording paper size. You can select the reduction rate as shown below. The machine will reduce the data in vertical according to the selected reduction rate.

Enter the number of selection you desire.

- 1 : LTR → LTR (4% ~ 10%)
- 2 : LTR → A4 (0% ~ 3%)
- 3 : A4 → LTR (9% ~ 14%)
- 4 : A4 → A4 (3% ~ 8%)
- 5 : LEG → LTR (25% ~ 28%)
- 6 : LEG → A4 (20% ~ 23%)
- 7 : LEG → LEG (4% ~ 8%)
- 8 : 85%
- 9 : 80%
- 0 : 75%

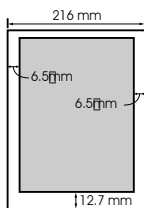

- **Printing Bottom Area (PRINT BTM. AREA)**—If there is image within 12.7mm from the bottom margin, you can select the machine to print the image at the bottom area as much as possible, or to reduce the page to fit in the effective recording area.

Press 1 to print the image at the bottom area. The image quality might be poor.
Press 2 to reduce the page to fit in the effective recording area.

- **Rings to Answer (RING COUNT)**—You can select the number of times your machine rings before answering an incoming call. If you are using your machine as both a telephone and a fax machine, we suggest you set the ring count to at least 4 to give you time to answer.

Enter a number using the number keypad.

- **Remote Receive Code (REMOTE RCV. CODE)**—The remote receive code allows you to initiate fax receive from an extension phone plugged into the EXT.LINE jack. If you pick up the extension phone and hear fax tones, enter the remote receive code and the fax will start receiving. The password is preset to * 9 * at factory.

Enter the desired code 0 to 9 on the number keypad.

- **Confirmation Report (MESSAGE CONFIRM)**—A confirmation report shows whether the transmission was successful or not, how many pages were sent, etc.

Press 1 to print out a confirmation report automatically each time you send a fax.
Press 2 to print out a confirmation report automatically only when an error occurs.
Press 3 to turn off this feature.

SPECIAL FEATURES

- **ECM Communication (ECM COMM.)**—This mode compensates for poor line quality and ensures accurate, error-free transmission with any other ECM-equipped facsimile machine. If the line quality is poor, transmission time may be increased when ECM is enabled.

Press 1 to turn on the error correction feature.
Press 2 to turn off the error correction feature.

- **Fax Print Quality (PRINT QUALITY)**—When you select LQ, the machine prints in low speed with high quality. When you select DRAFT, the machine prints in high speed with low quality.

Press 1 to select LQ.
Press 2 to select DRAFT.

- **Fax Ink Saver (INK SAVE MODE)**—You can save ink when making a photo copy with this feature.

Press 1 to turn off this feature.
Press 2 to use 25% less ink.
Press 3 to use 50% less ink.

SPECIAL FEATURES

➔ **Clearing Memory**

You can selectively clear information registered in your machine's memory.

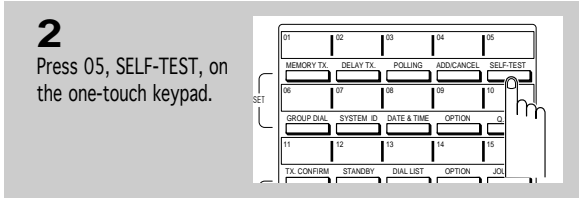

▶ One-touch buttons 01-16 perform specific functions when used with the MENU button. Each button provides access to a selected function.

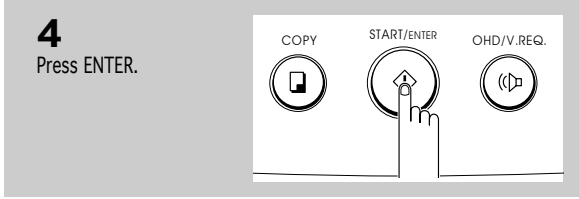
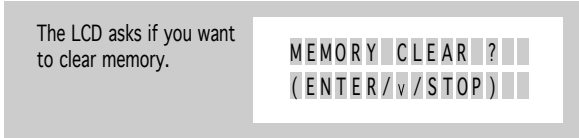

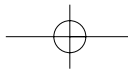

6

SPECIAL FEATURES

5

Scroll to the options by pressing ▲ or ▼ repeatedly until you find the one you want to clear.

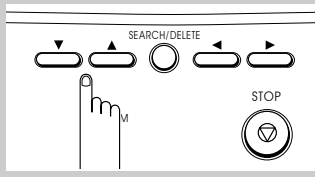

6

When memory you want appears in the display, press the number of memory you selected.

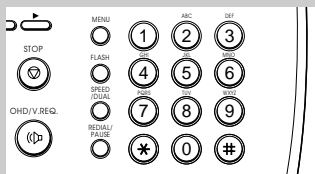

The LCD asks if you are sure of the number.

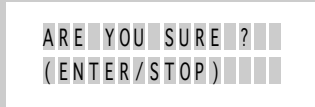

7

Press ENTER to confirm it.

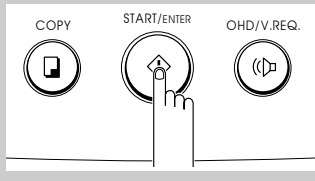

The selected memory is cleared.



8

You can continue to select another memory to clear.

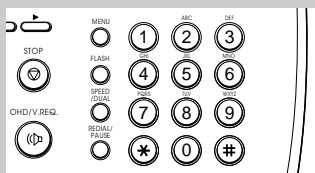

To return to Standby mode, press STOP twice.

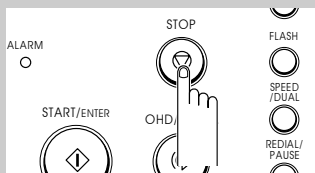

- 1 : JOURNAL : clears all records of transmissions & receptions.
- 2 : TERMINAL ID : clears your terminal identification information. Your terminal ID number, name are erased from the machine's memory.
- 3 : OPTIONS : restores user-selectable options to the default value.
- 4 : DIAL&DELAY : clears the autodial memory and the delayed dial operations. All the numbers currently registered to One-Touch Dial, Speed Dial and Group Dial numbers will be erased from the machine's memory. In addition, all the delayed time operations you have reserved are also cancelled.

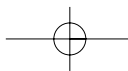

Chapter Seven

CARE AND MAINTENANCE

Chapter Seven

CARE AND MAINTENANCE

▶ Cleaning the Document Scanner

To keep your machine working properly, occasionally clean the white roller, ADF rubber, and the scanning glass. If they are dirty, documents sent to another fax machine won't be clear.

Note : Do not turn the power off to clean the scanner, as documents stored in memory will be lost.

1. Open the control panel.

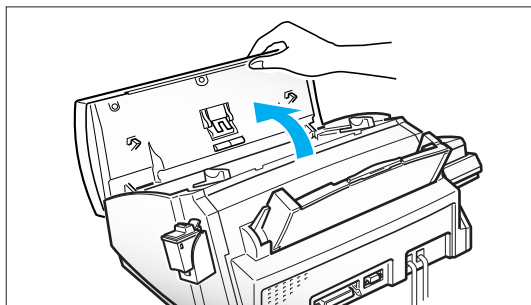

2. Disassemble the white roller as follows:

Both ends of the white roller have bushings that are snapped shut with small tabs, as shown. Push each tab slightly inward (A) then rotate the roller (B) until it reaches the slot. Then pull the roller upward.

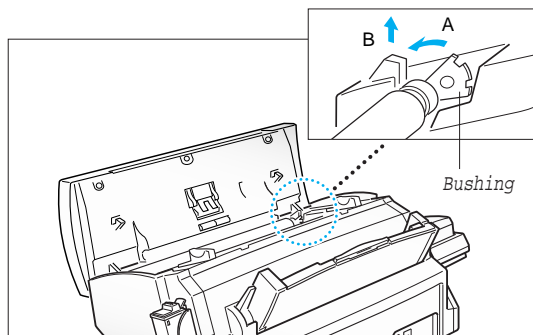

3. Wipe the roller surface with a soft cloth dampened with water.

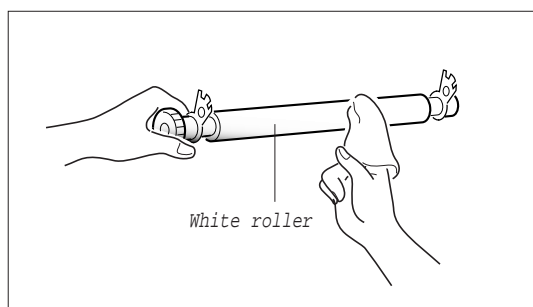

CARE AND MAINTENANCE

4. Clean the ADF rubber piece also.

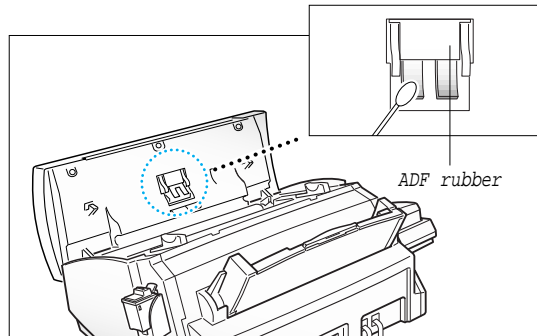

5. Carefully wipe the scanning glass with a soft, dry cloth.

If the glass is very dirty, first wipe it with a slightly dampened cloth, then with a dry cloth. Be very careful not to scratch the glass surface.

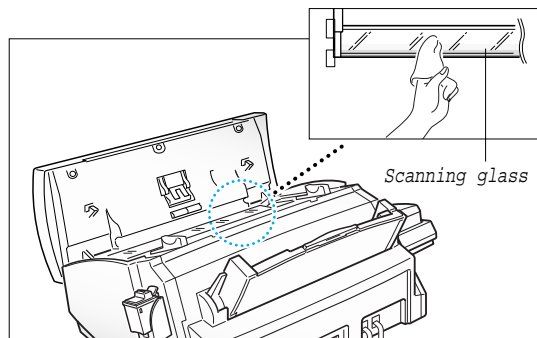

6. Replace the roller in reverse order, and then close the control panel firmly until it clicks into place.

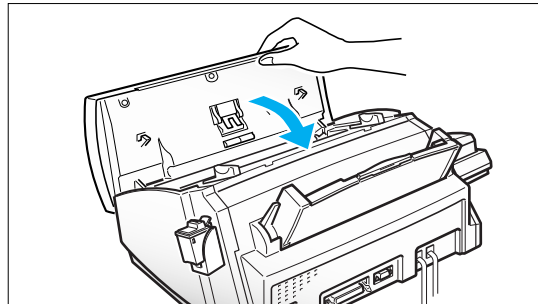

CARE AND MAINTENANCE

► Printer Cartridge Maintenance

To get the maximum benefit from your print cartridges:

- Do not remove a print cartridge from its packaging until you are ready to install it.
- Do not refill print cartridge. The warranty will not cover damage caused by using refilled cartridges.
- Store the print cartridge in the same environment as the printer.
- Do not remove a print cartridge from the printer except to replace it, clean it, or switch between color and black. Immediately replace the print cartridge or store it in the storage unit. The print cartridge will not print correctly if removed from the machine and left exposed for an extended period.
- When switching between color and black print cartridge, store the unused cartridge in the print cartridge storage unit.
- If you have an opened print cartridge you are not currently using and do not have an available print cartridge storage unit, store it in an airtight plastic bag. Do not leave it exposed for an extended period.

► Check Ink Level

Your machine allows you to check the amount of ink remaining. The machine displays the amount of ink remaining as a series of blocks in the LCD—the more blocks, the more ink remains.

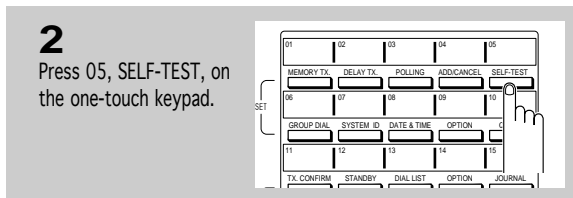
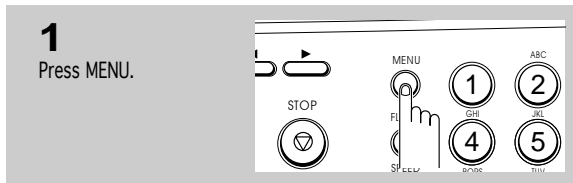

▶ One-touch buttons 01-16 perform specific functions when used with the MENU button. Each button provides access to a selected function.

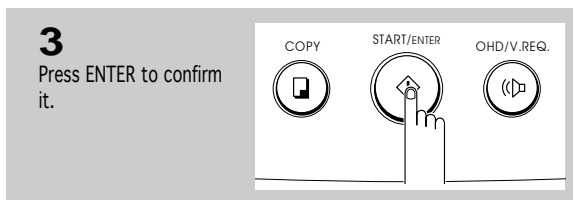
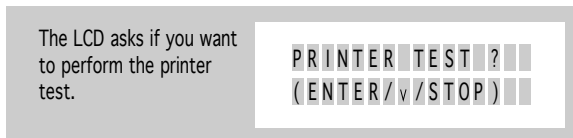

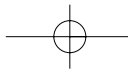

CARE AND MAINTENANCE

The LCD asks if you want to run the self-test.



4
Press ▼, to choose the next menu.

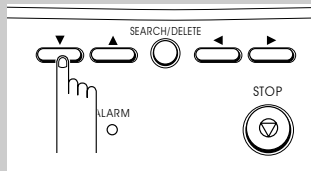

The LCD asks if you want to check ink level.



5
Press ENTER to confirm it.

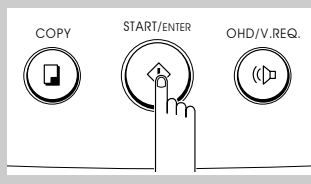

The LCD displays the type of ink cartridge in the upper line and the blocks in the lower line. The number of block indicates the ink level.



6
Press STOP three times to return to Standby mode.

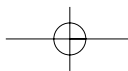
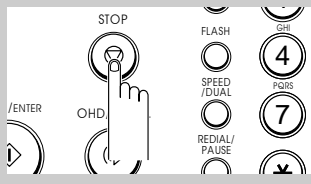

CARE AND MAINTENANCE

Run Nozzle Test

The print cartridge nozzle test helps you pinpoint any clogged nozzles. The nozzle test also cleans the print cartridge by cleaning (purging) the nozzles. A test line prints so you can see if the cleaning (purging) process was successful. Use the nozzle test :

- When you suspect the nozzles are clogged
- When characters are not printing completely

To run the nozzle test

1
Press MENU.

The LCD asks you to press the desired function button.

▶ One-touch buttons 01-16 perform specific functions when used with the MENU button. Each button provides access to a selected function.

2
Press 05, SELF-TEST, on the one-touch keypad.

The LCD asks if you want to perform the printer test.

3
Press ENTER then press ▼ twice.

The LCD prompts you to press ENTER to clean nozzle.

4
Press ENTER to confirm it.

CARE AND MAINTENANCE

The machine prints out the nozzle test pattern.



5
Examine the test pattern.

This example shows a test pattern of all nozzles functioning correctly on the black print cartridge.

This example shows a test pattern of all nozzles functioning correctly on the color print cartridge.

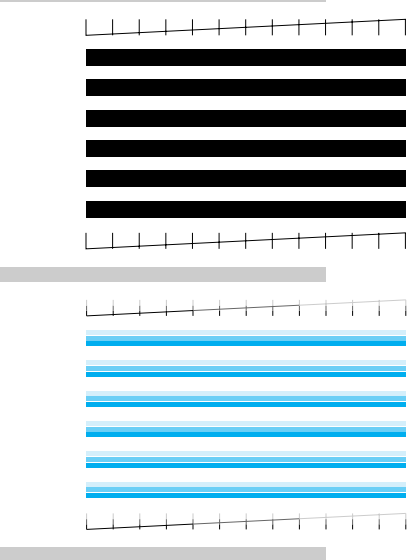

◀ : yellow
 : red
 : blue
 (appears in SF4100/4200 only)

6
Compare the diagonal line at the top and bottom of the test pattern. Look for a break in the diagonal line. A broken line shows any clogged nozzles.

If the bottom line shows improvement, rerun this test. If improvement continues, rerun the test again. If all nozzles are not printing after running the test three times, continue with the next step.

7
If print quality does not improve, remove and reinstall the print cartridge. See 'Replacing the Print Cartridge' on page 7.10 for complete instructions on removing and reinstalling a print cartridge.

8
Repeat the nozzle test.

9
If the line is still broken, wipe the nozzles and contacts. For help, see 'Wiping the Print Nozzles and Contacts' on page 7.10.

CARE AND MAINTENANCE

► Wiping the Print Nozzles and Contacts

When the print is not clear or dots are missing, the problem may be caused by dried ink on the:

- Print cartridge nozzles
- Print cartridge contacts
- Print cartridge carrier contacts and deflector

1. Remove the print cartridge. See 'Replacing the Print Cartridge' on page 7.10.

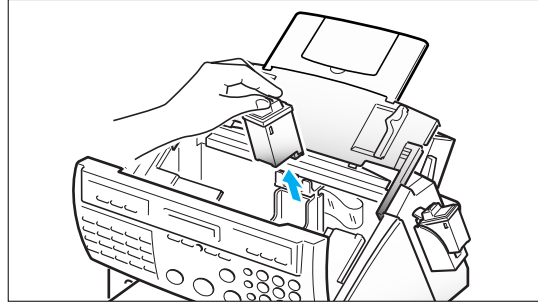

2. Use a clean cloth, dampened with water only, to gently clean the entire copper-colored area, including the nozzles and contacts.

To dissolve any dried ink, hold the damp cloth against the nozzles for about three seconds. Gently blot and wipe dry.

If you are cleaning a color print cartridge, be especially careful to wipe the nozzles in only one direction so the colors do not mix.

Allow the copper-colored area to dry.

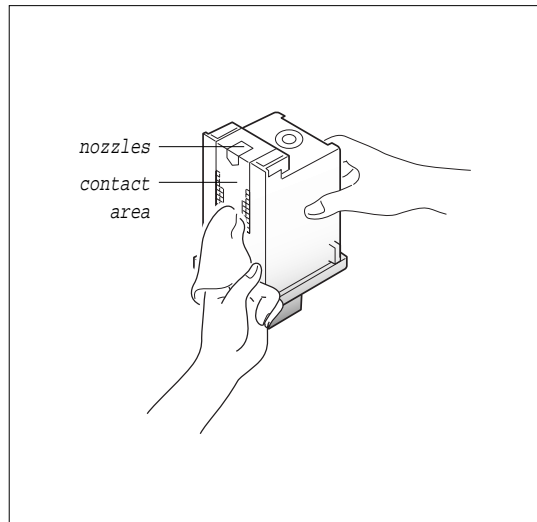

3. Reinstall the print cartridge.

If the line is still broken, clean the print cartridge carrier contacts. See the following steps.

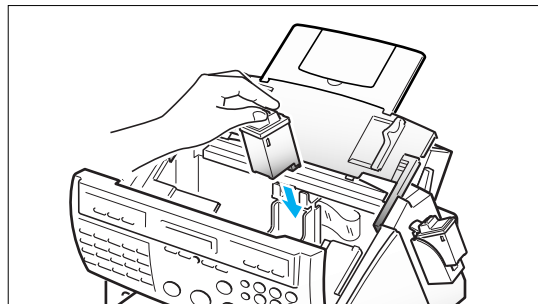

CARE AND MAINTENANCE

Cleaning the Cartridge Carrier Contacts and Deflector

1. Press the CARTRIDGE button to move the print cartridge carrier to the load position.

Warning: All documents stored in memory will be lost when the power is turned off in step 2.

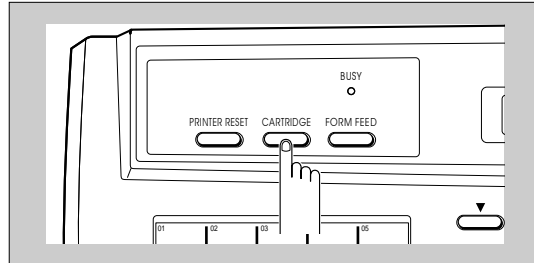

2. Unplug the power cord from the electrical outlet or the rear of the machine.

This forces the print cartridge carrier to remain in the load position.

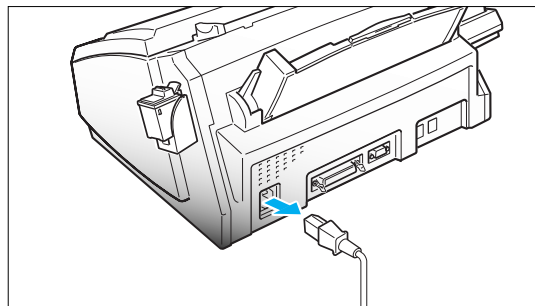

3. Lift the control panel and slide up the top cover until it clicks. Then, remove the print cartridge.

See 'Replacing the print cartridge' on page 7.10.

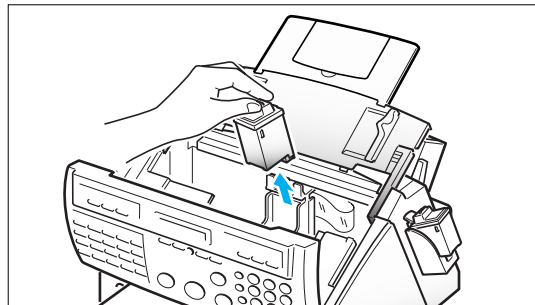

4. Use a CLEAN, DRY CLOTH to clean the print cartridge carrier contacts inside the printer.

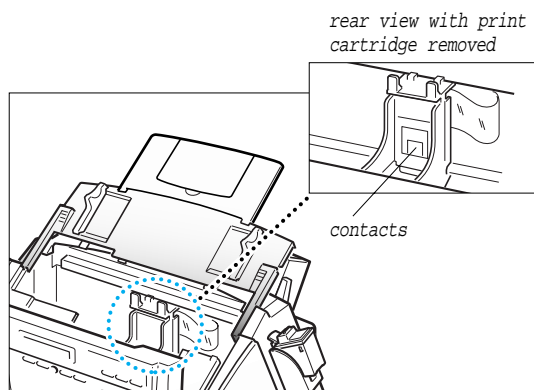

CARE AND MAINTENANCE

5. Use a CLEAN, DRY CLOTH to clean the carrier deflector inside the printer.

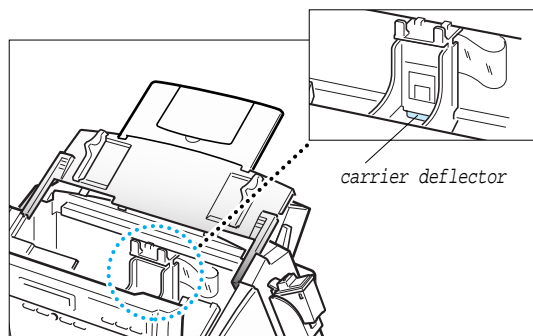

6. Plug the power cord in.

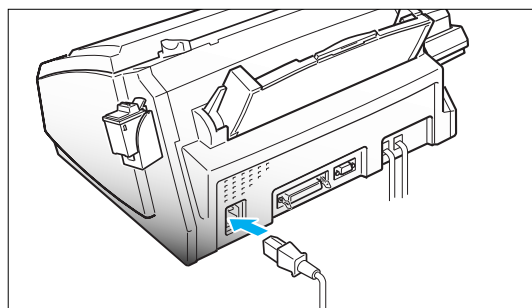

7. Press the CARTRIDGE button.

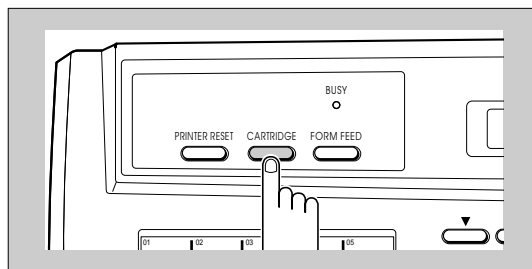

8. Install the print cartridge. See 'Replacing the print cartridge' on page 7.10.

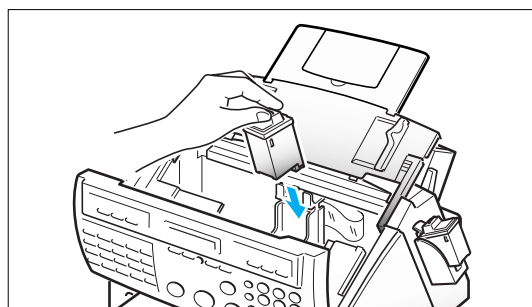

Notes :

- If print quality does not improve after this cleaning process, release the cartridge from the holder as described in step 3 under 'Replacing the print cartridge' on page 7.10, and push it firmly until it clicks into place, then repeat this procedure 3-4 times.
- If print quality still does not improve, replace your print cartridge.

▶ Replacing the Print Cartridge

The print cartridge includes the ink supply and the printhead. Each time you replace the print cartridge, you are replacing the printhead as well.

When you notice that the print becomes light or 'INK OUT' appears in the display, replace your cartridge.

- Your machine knows which print cartridge is installed and keeps separate ink low counts for the color and black print cartridges.
- When you install a new print cartridge, you must select '1:NEW' in the display to reset the Ink Low counter.
- If you are switching between color and black print cartridges, be sure to store the unused print cartridge in the print cartridge storage unit. A color cartridge is not available for SF4000.
- If you change a cartridge from color to mono before a file on PC is not completely printed, the remaining page on the file may not print.
- If you are interrupted and leave the print carrier in the load position for more than 3 minutes, the print cartridge carrier moves to the standby position.
- When 'INK OUT' appears during PC printing, the machine continues printing. After PC printing is completed, replace the print cartridge.
- You cannot replace the print cartridge while the printer is in use.

To replace the print cartridge, perform the following steps.

1. Press the CARTRIDGE button on the control panel. The LCD displays 'CHANGE CARTRIDGE' and the print cartridge moves to the load position.

If you install a color cartridge, use 'Install Cartridge' tab in the SAMSUNG MFP4100/4200 Control Program on your PC.

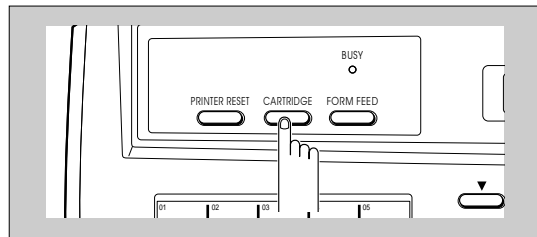

2. Open the control panel and slide up the top cover until it clicks and the ink cartridge is in full view.

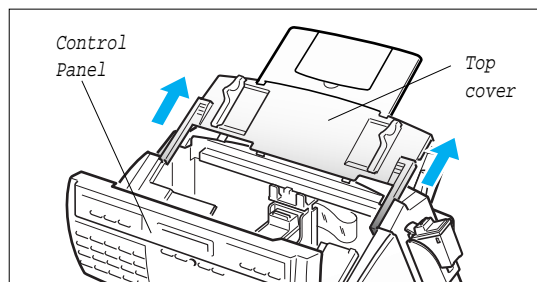

CARE AND MAINTENANCE

3. While pushing the cartridge holder away from you, pull the print cartridge handle toward you, until it clicks.

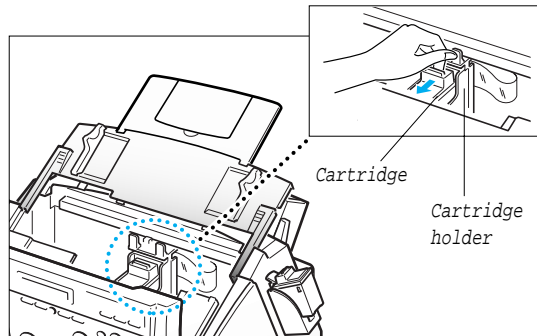

4. Remove the print cartridge.

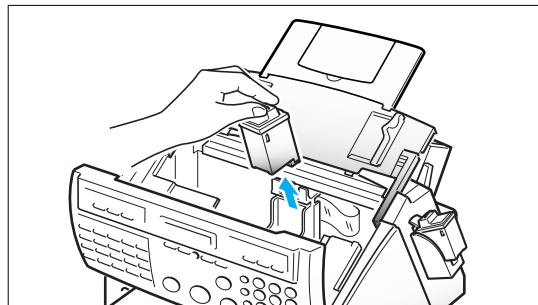

5. Remove a new print cartridge from its packaging and carefully remove the tape covering the print head.

Hold the print cartridge by the colored top or black areas only.

Do not touch the copper area.

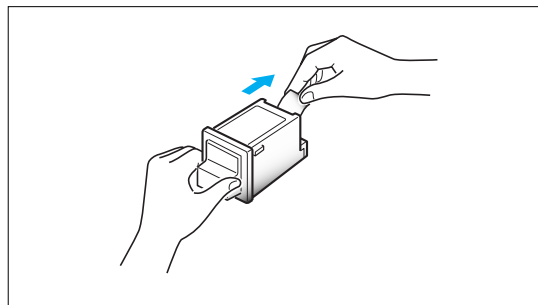

6. Insert the print cartridge in the cartridge holder, then push the print cartridge firmly away from you until it clicks into place.

If the print cartridge moves loosely in the carrier, it has not clicked into place. Repeat this step.

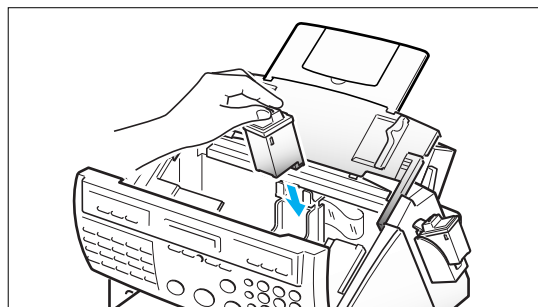

CARE AND MAINTENANCE

7. Replace the top cover and the control panel.

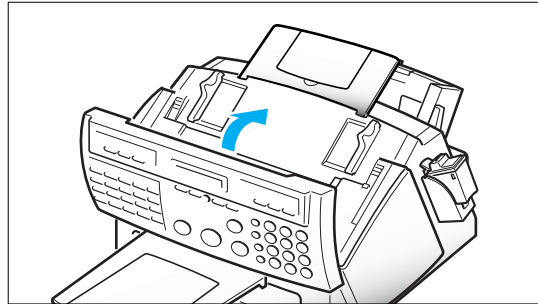

8. Press the CARTRIDGE button.

Use 'Install Cartridge' tab on your PC for a color cartridge.

The print cartridge moves to the far right.

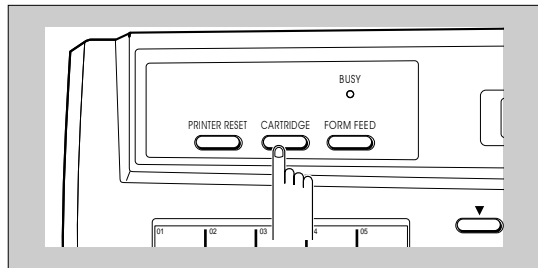

LCD displays 'CARTRIDGE IS 1:NEW 2:USED.'

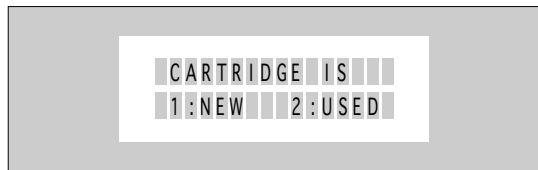

9. Select '1:NEW' by using ◀ or ▶, or by pressing the 1 button, then press START.

The LCD briefly displays 'MONO INSTALLED' or 'COLOR INSTALLED' according to the type of ink cartridge, then the machine returns to Standby mode.

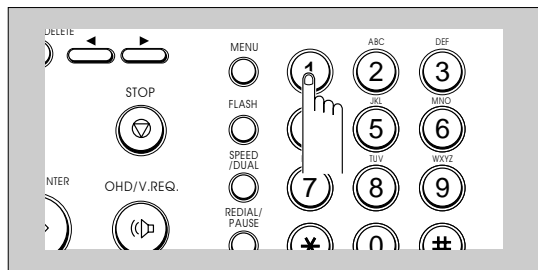

CARE AND MAINTENANCE

Notes :

- If you received fax with the color cartridge installed, you cannot get the fax printed until replacing it with mono cartridge.
- When you install a new cartridge, you must select '1:NEW.' When you install a used cartridge, select '2:USED', which helps you monitor the amount of ink remaining. If you mix up several used cartridges, it will be difficult to check the amount of ink remaining. Once a new print cartridge is installed, use it until it has run out completely.
- If the new cartridge does not give excellent printing quality, run 'Printer Self-Test' and 'Nozzle Test' on page 2.11 and 7.5, respectively.
- If you want to install a color cartridge to print a file on your PC, you should use 'Install Cartridge' tab in the SAMSUNG MFP 4100/4200 Control Program on your PC. If you use the CARTRIDGE button on this machine, the machine beeps a warning tone and briefly displays 'RE-INSTALL COLOR USING PC-DRIVER.' Press 'Install Cartridge' tab on your PC, or the file may print using composite black.

Chapter Eight

TROUBLESHOOTING

Chapter Eight

TROUBLESHOOTING

In this chapter you will learn how to clear document jams, what the various error messages mean, how to fix problems.

► Clearing Jams

Document Jams During Transmission

If a document jams during transmission, 'DOCUMENT JAM' appears in the LCD display. DO NOT pull the document out of the slot. Doing so could harm your machine.

1. Open the control panel.

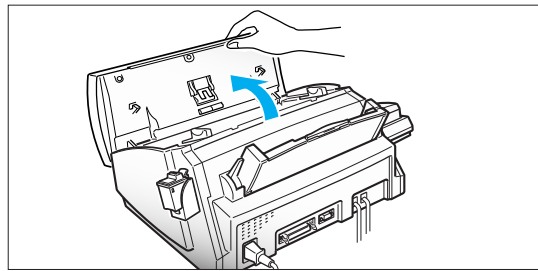

2. Carefully remove the jammed document.

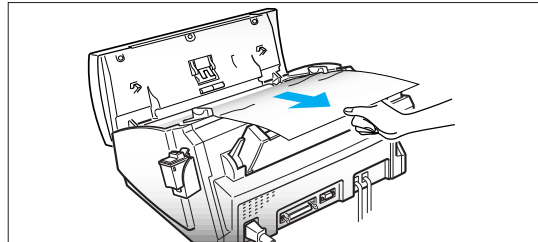

3. Close the control panel firmly until it clicks into place.

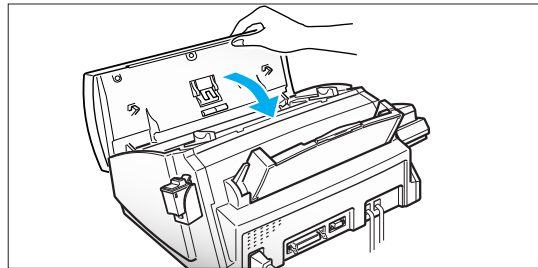

When to Replace Parts for Automatic Document Feeding

If you have a problem with automatic document feeding, some parts may be worn. To maintain ADF function (Automatic Document Feeding), have related parts (ADF Rubber, ADF Roller) replaced by qualified service personnel before they exceed their service lifetimes.

Service lifetimes:

ADF Rubber - After 1 year past or 10,000 pages, whichever occurs first.

ADF Roller - After 2 years past or 20,000 pages, whichever occurs first.

TROUBLESHOOTING

Paper Jams During Printing

If the fax paper jams while you are receiving, 'PAPER JAM' appears in the LCD display. DO NOT pull it out. Doing so could harm the fax machine.

IF THE PAPER IS JAMMED IN THE RECEIVED PAPER OUTPUT AREA

Remove the jammed paper by hand as shown.

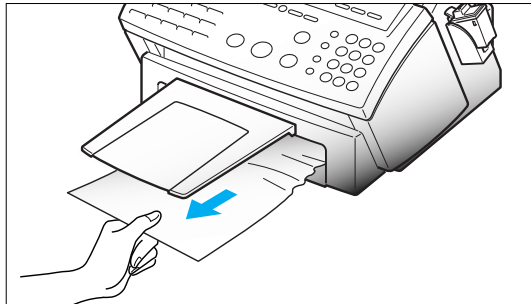
**IF THE PAPER IS JAMMED IN THE PAPER FEED AREA**

1. Push the paper load lever away from you to open the sheet feeder.

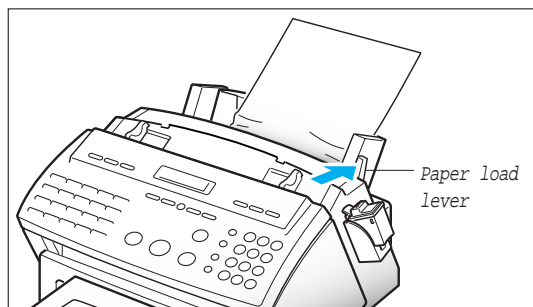

2. Remove the jammed paper as shown in the figure.

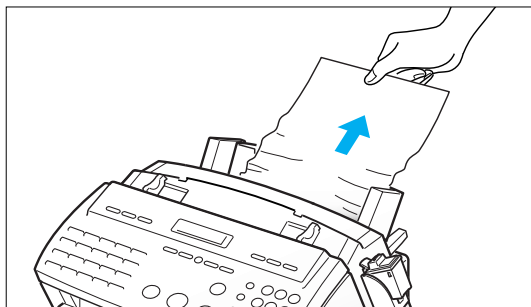

TROUBLESHOOTING

3. After removing the jammed paper, load paper with the print side facing you.

Hold the left paper guide and move it to the right to match the width of the paper.

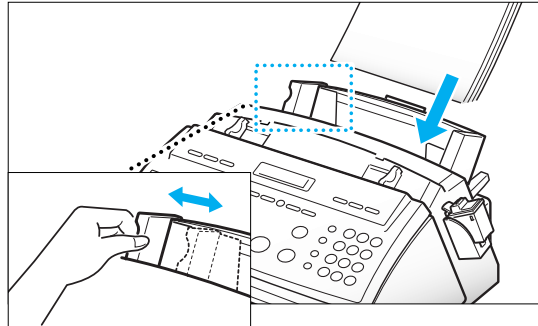

4. Pull the paper load lever toward you to close the sheet feeder.



5. Press the PRINTER RESET button.
(if your machine is SF4100 or SF4200)

For SF4000, press the STOP button.

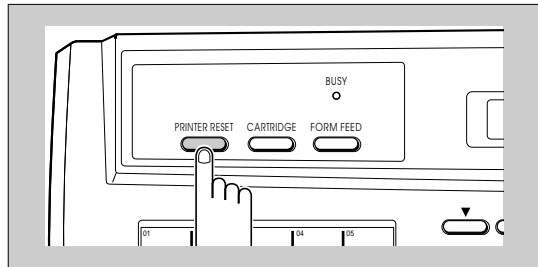

LCD Error Messages

Display	Meaning
ALREADY SET	The number you chose is already set for another fax number you are setting up now. This message also appears when you try to setup another polling transmission when one polling is already setup.
ALREADY SET IN GROUP	The one-touch button or 2-digit speed number you chose is already set in the group you are storing now.
BUSY! RETRY?	The machine is waiting to automatically redial another fax number that was busy.
CANCEL! PC PRINT FOR FAX PRINTING (SF4100/SF4200)	Incoming fax is receiving in memory while you print a PC file. It is recommended to stop PC printing and print the incoming fax.
CHECK CARTRIDGE FOR FAX PRINTING (SF4100/SF4200)	A color print cartridge is installed in your machine when the machine prints a fax, makes a copy, or prints a user list.
CHECK CARTRIDGE PLEASE INSTALL	Print cartridge is not installed properly or no cartridge is installed in the machine.
CHECK LOAD LEVER	The paper load lever is in the open position.
COLOR INSTALLED (SF4100/SF4200)	The print cartridge installed in your machine is a color cartridge.
DOCUMENT JAM	The document you are sending has jammed in the feeder. Clear the document jam. See page 8.1.
DUPLICATED	The number you chose is already stored in another one-touch or speed dial memory.
INK OUT	The print cartridge has completely run out of ink. Install a new print cartridge.

TROUBLESHOOTING

Display	Meaning
IN USE EXT.PHONE PRESS [START]	The extension phone is in use now. If you press START, you can speak with the other party in the MultiJet machine.
IT IS GROUP NO. ITSELF	The one-touch button you chose is the group button you are storing now.
IT IS USING IN MEMORY JOB	The number you tried to delete or change is currently used for the memory job being waited to send or poll at a specified time. Error beeps sound when this message appears.
LOAD DOCUMENT	You have tried to send a fax and there is no document loaded into the machine.
MEMORY FULL	Memory has become full. Either delete unnecessary documents stored in memory, or send when memory becomes available, or split the document into smaller parts.
MEMORY JOB FULL	20 memory jobs are currently stored and no more memory is available.
MONO INSTALLED	The print cartridge installed in your machine is a mono cartridge.
NO ANSWER	The other machine has not answered after all your attempts to redial. Or, the other machine does not press START when you are waiting to receive a fax.
NO. NOT ASSIGNED	There is no number assigned for the one-touch button or 2-digit speed number you chose.
NOT FOUND	The name you want to search for is not stored in memory.
TOO MUCH PAGES FOR ONE JOB	You have tried to store more than 99 pages. One memory job can store up to 99 pages.
PAPER JAM	A recording paper is jammed during printing. Clear the paper jam (see page 8.2) and press the STOP button. In case of SF4100/SF4200 models, press the PRINTER RESET button according to the instruction on the Window driver.

TROUBLESHOOTING

Display	Meaning
PAPER OUT	Printer is out of paper. If paper is run out while printing a fax, the machine restarts fax printing when paper is loaded. If paper is run out while printing a PC file, you have to press the FORM FEED button after paper loading according to the instruction on the Window driver. PAPER OUT is also displayed when you load smaller-sized paper than A4, legal, letter sized paper to print PC file, however you can print PC file, regardless of the error message.
PLEASE HOOK-OFF TEL/FAX MODE	In TEL/FAX mode, it indicates that a voice call is coming. To answer, lift the handset.
PLEASE HOOK-ON	The handset is not in its cradle. Place the handset in its cradle.
POLLING ERROR	The machine you want to poll is not ready to answer your poll. The person you are polling should have loaded their fax machine with a document. Also, this message appears when you setup to poll another fax machine with an incorrect poll code.
PRINTER ERROR	A printer error occurs while the machine prints a PC file. The error type is displayed in detail on the PC driver window. Check if a mono cartridge is installed to print color data. If so, change the cartridge. In this case, the LCD does not display the cartridge type.
PRINTER INITIAL PLEASE WAIT	The printer is initializing now. Please wait a moment.
RECEIVE ERROR	A fax has not been received successfully. Ask the sender to try again.
RESET PRINTER	This message appears when a paper is jammed or printer error occurs. After solving the problem, press the PRINTER RESET button.
SEND ERROR	Your fax has not gone through successfully. Try again.
SERVICE CALL	A printer problem the user cannot solve occurs. Turn power off then on and repeat it 2 or 3 times. If the message still remains on the LCD display, call service.
THERE IS NO ENTRY!	There is no number stored in one-touch or speed dial memory when you press the SEARCH button.

8.6 CHAPTER EIGHT : TROUBLESHOOTING

TROUBLESHOOTING

→ **Fixing Problems**

Your problem may be listed on page 8.4 in the 'LCD Error Messages' section. Below are other problems you can solve yourself. If not, call the service company shown on the "Warranty Information."

Fax Problems

Problem	Solution
The machine is not working, there is no display and the buttons are not working.	Unplug the machine and plug it in again. Check your socket is live.
No dial tone.	Check the phone is connected properly. Check the phone socket in the wall by plugging in another phone.
The numbers stored in memory do not dial correctly.	Make sure the numbers are programmed in correctly. Print a Telephone Number List (see page 6.6).
The document does not feed into the machine.	Be sure the document is not wrinkled and you are putting it in correctly. Check the document is the right size, not too thick or thin.
You cannot receive faxes automatically.	The RCV. MODE lamp should be on. Be sure the handset is on properly. Is there paper in the machine? Check if the LCD displays 'MEMORY FULL.'
The machine cannot receive faxes manually.	Did you hang up the handset before you pressed START ?
The machine will not send anything.	Check that the document is loaded face down. 'TX' should show up in the display. You may have hung up the handset before you pressed START . Check the other machine you are sending to can receive your fax.
You cannot poll another machine.	The fax you are polling may be using a poll code.

TROUBLESHOOTING

Problem	Solution
The fax you receive has got blank bits on it.	The machine sending you the fax may be faulty. A noisy phone line can cause line errors. Check your machine by making a copy.
Spots on or lines missing from the fax you receive.	Check if your phone line is noisy. Check if the print head is clean by making a copy.
You are receiving poor quality copies.	The fax machine sending you a fax may have a dirty scan glass. Check for a noisy phone line.
Are some of the words on the fax you receive stretched?	The machine sending you the fax had a temporary document jam.
Your machine won't make copies.	Make sure your document is loaded face down.
There are lines on copies or documents you send.	Check your scan glass for marks, and clean it.
The machine dials a number, but fails to make a connection with a remote fax machine.	The remote fax machine may be turned off, out of recording paper, or unable to answer incoming calls. Speak with the remote operator and ask for the problem to be rectified.
You cannot store a document in memory.	There may not be enough available memory to hold the document you want to store. If the LCD displays a 'MEMORY FULL' or 'MEMORY JOB FULL' message, delete from memory any documents you no longer need, then restore the document.
Blank areas appear at the bottom of each page or on continuation pages, with only a small strip of material printed at the top.	You may have selected the wrong paper settings in the User Options setup. See page 6.8 to select the proper paper size.

TROUBLESHOOTING

Print Quality Problems

Problem	Solution
Light or blurred characters.	<p>Make sure the DRAFT mode is not selected.</p> <p>Check 'Ink Level' to see the amount of ink remaining. See page 7.3. If the print cartridge has completely run out, 'INK OUT' is displayed in the LCD. Install a new print cartridge. See 'Replacing the Print Cartridge' on page 7.10.</p> <p>Make sure you are using the correct type of paper. See 'Paper Type and Sizes' on page 2.7 for more information.</p> <p>Make sure Ink Saver feature is Off in the User Options.</p> <p>Make sure the print cartridge is installed correctly.</p> <p>Clean the print cartridge. See 'Run Nozzle Test' on page 7.5.</p>
Smudged or dark characters.	<p>Make sure you are using the correct type of paper. See 'Paper Type and Sizes' on page 2.7.</p> <p>If you are in a Windows-based environment, select Medium or Maximum Ink Saver Mode in the User Options.</p> <p>Make sure the paper is straight and unwrinkled.</p> <p>Let ink dry before handling the paper.</p> <p>Change print quality to the DRAFT mode.</p> <p>Clean the print cartridge. See 'Run Nozzle Test' on page 7.5.</p>
Characters with white lines.	<p>If 'INK OUT' is displayed, install a new print cartridge. See 'Replacing the Print Cartridge' on page 7.10.</p> <p>Remove and reinstall the print cartridge.</p> <p>Clean the print cartridge. See 'Run Nozzle Test' on page 7.5.</p> <p>If printing transparencies, try changing the fill pattern in your application software.</p>
Improperly formed or misaligned characters.	<p>Clean the print cartridge. See 'Run Nozzle Test' on page 7.5.</p>
Solid black areas on transparencies contain white streaks.	<p>Try changing the fill pattern in your application software.</p>

Printing Problems

Problem	Solution
Printer has missing or damaged parts.	Call Samsung Technical Support or contact your point of purchase.
Printer seems to be printing, but no characters are printing.	Make sure a print cartridge has been installed. Make sure the tape was removed from the print cartridge. Make sure the printer has paper.
Power is on, but no action from the printer.	If 'INK OUT' is displayed, install a new print cartridge. See 'Replacing the Print Cartridge' on page 7.10. Make sure the paper load lever is in the closed position. Make sure the printer interface cable is firmly inserted into the interface connector at the back of your machine.
Unexpected characters are printed or characters are missing.	Make sure the correct printer driver is installed in Windows or in your DOS application. Change the parallel interface cable.
Printer prints very slowly.	Change print quality from LQ (Letter Quality) to DRAFT. Graphics print more slowly than text. Color prints more slowly than black.
Fonts selected using data stream commands do not print.	Make sure a black print cartridge is installed. Make sure the font is valid for the mode selected. Make sure you have not exceeded 32 fonts for the page. You cannot specify more than 32 fonts per page.
Page does not print.	Some extremely complicated page formats may not be printable on the printer. If you are using more than 32 fonts or if you are printing complex graphics, you can experience this problem. Simplify your page or choose less fonts.

TROUBLESHOOTING

Paper Feeding Problems

Problem	Solution
Paper is jammed during printing.	Clear paper jam. See page 8.2.
Paper sticks together.	<p>Make sure there is not too much paper in the automatic sheet feed. The automatic sheet feed can hold up to 100 sheets of paper.</p> <p>Make sure you are using the correct type of paper. See 'Paper Type and Sizes' on page 2.7.</p> <p>Remove paper from the automatic sheet feed and flex or fan the paper.</p> <p>Humid conditions may cause some paper to stick together.</p>
Paper fails to feed.	<p>Make sure the paper load lever is closed.</p> <p>Remove any obstructions inside the printer.</p>
Multiple sheets of paper feed.	<p>Make sure the paper load lever is closed.</p> <p>When loading paper, do not force the paper down into the printer.</p> <p>If multiple sheets have caused a paper jam, clear the paper jam. See page 8.2.</p>
Paper skews or buckles in the automatic sheet feed.	<p>Make sure there is not too much paper in the automatic sheet feed. The automatic sheet feed can hold up to 100 sheets of paper.</p> <p>Make sure the paper guides do not cause the paper to bow in the automatic sheet feed.</p> <p>Make sure you are using the correct type of paper. See 'Paper Type and Sizes' on page 2.7.</p> <p>When loading paper, do not force the paper down into the printer.</p> <p>Make sure the envelope guides are not in the envelope position.</p>
Paper skews in the manual feed.	Continue to hold the paper in place until it begins to feed.

TROUBLESHOOTING

Problem	Solution
Envelopes skew or fail to feed correctly.	<p>Make sure the envelope guides have been turned to the envelope load position.</p> <p>Make sure envelopes are loaded behind the envelope guides.</p> <p>Make sure the paper guide do not cause envelopes to bow in the automatic sheet feed.</p> <p>Make sure the paper load lever is closed.</p>
Transparencies stick together in printer exit tray	<p>Use only recommended transparencies.</p> <p>Remove each transparency as it exits from the printer.</p>



Specifications

General

Machine Size (H X W X D)	10.4 X 12.7 X 17.9 Inch (263 X 323 X 454 mm)
Machine Weight	7.0 Kg
Power Requirement	See power rating attached on back of the paper bin
Power Consumption	12 W (Stand-by), 30.66 W (Maximum when in use)
Temperature Range	10 ~ 40 °C (Operation Range)
	16 ~ 32 °C (Optimum Operation Range)
Humidity Range	8 to 80 %RH (Non-Condensing)

Fax

Communication System	PSTN & PABX
Compatibility	ITU GROUP 3
Compression Scheme	MH/MR/MMR
Modem Speed	9600/7200/4800/2400 bps
Scanning Method	Sheet-feed scanning using CIS
Input Document Size	8.5 Inch (216 mm)
Scanning Resolution	200 dpi
ADF Capacity	30 Sheets (0.0039 in/0.1 mm) 20 Sheets (0.0033 ~ 0.0051 in/0.085 - 0.13 mm)

TROUBLESHOOTING

Printer

Printing Technology		Thermal Ink-Jet Printing
Print Speed	Mono	167 CPS (LQ Mode) → 2 PPM
		240 CPS (Draft Mode) → 3 PPM (SF4100/4200)
	Color (SF4100/4200)	1/4 PPM
Resolution		300 X 300 DPI, 600 X 300 DPI (Window only)
Recording Width		8 Inch (203 mm)
Paper Handling	Paper Size	Letter, Legal, A4
		A5, B5, EXEC (SF4100/4200)
	Paper Capacity	100 Sheets
	Paper Weight	70 ~ 90 g/m ²
Cartridge Life	Mono	about 1100 Sheets (4 % Print Duty On A4)
	Color (SF4100/4200)	about 200 Sheets (15 % Print Duty On A4)
Emulation (SF4100/4200)		Windows GDI/PCL3
Interface (SF4100/4200)		P1284 BI-Directional
Printer Drivers (SF4100/4200)		WIN 3.1/95

Free Manuals Download Website

<http://myh66.com>

<http://usermanuals.us>

<http://www.somanuals.com>

<http://www.4manuals.cc>

<http://www.manual-lib.com>

<http://www.404manual.com>

<http://www.luxmanual.com>

<http://aubethermostatmanual.com>

Golf course search by state

<http://golfingnear.com>

Email search by domain

<http://emailbydomain.com>

Auto manuals search

<http://auto.somanuals.com>

TV manuals search

<http://tv.somanuals.com>