

SyncMaster 400DX-2, 400DXN-2, 460DX-2, 460DXN-2

LCD Display

User Manual

The color and the appearance may differ depending on the product, and the specifications are subject to change without prior notice to improve the performance.

Safety Instructions

Notational



Note

These safety instructions must be followed to ensure your safety and prevent property damage.

Make sure to read the instructions carefully and use the product in the correct manner.

Warning / Caution



Failure to follow directions noted by this symbol could result in bodily harm or damage to the equipment.

Note



Prohibited



Important to read and understand at all times



Do not disassemble



Disconnect the plug from the outlet



Do not touch



Ground to prevent an electric shock

Power





When not used for extended period of time, set your computer to DPM.

If using a screen saver, set it to active screen mode.

The images here are for reference only, and are not applicable in all cases (or countries).

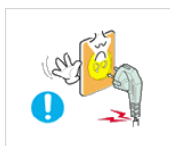
Shortcut to Anti-Afterimage Instructions



 Do not use a damaged power cord or plug or a damaged or loose power outlet.

- Otherwise, this may result in electric shock or fire.

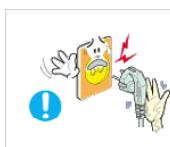

 Do not touch the power plug with wet hands when removing or plugging the plug into the outlet.

- Otherwise, this may result in electric shock.

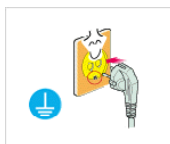

 Make sure to connect the power cord to a grounded power outlet.

- Otherwise, it may result in electric shock or personal injury.

Safety Instructions

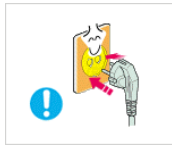

▶ Ensure that the power plug is plugged into the power outlet firmly and correctly.

- Otherwise, this may result in fire.

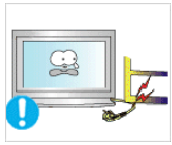

▶ Do not forcefully bend or pull the power plug and do not place any heavy material on it.

- Otherwise, this may result in fire.

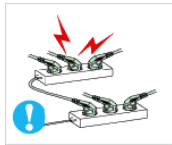

▶ Do not connect multiple appliances to the same power outlet.

- Otherwise, this may cause fire due to overheating.

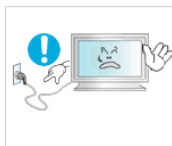

▶ Do not disconnect the power cord while using the product.

- Otherwise, this may result in damage to the product due to electric shock.



▶ To disconnect the apparatus from the mains, the plug must be pulled out from the mains socket, therefore the mains plug shall be readily operable.

- Otherwise, this may cause electric shock or fire.



▶ Use only the power cord provided by our company. Do not use the provided power cord of another product.

- Otherwise, this may result in fire or electric shock.

Installation



Be sure to contact an authorized Service Center when installing your monitor in a location with heavy dust, high or low temperatures, high humidity, and exposed to chemical substances and where it operates for 24 hours such as at airports, train stations etc.

Failure to do so may cause serious damage to your monitor.



▶ Ensure that at least two persons lift and move the product.

- Otherwise, it may be dropped and cause personal injury, and/or damage the product.

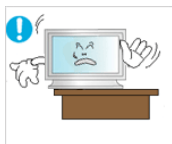

▶ When installing the product in a cabinet or rack, make sure that the front end of the bottom of the product does not project out.

- Otherwise, it may fall or cause personal injury.

• Use a cabinet or rack of a size appropriate to the product.

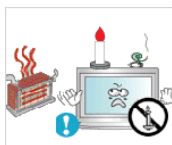

▶ DO NOT PLACE CANDLES, MOSQUITO REPELLANT, CIGARETTES AND ANY HEATING APPLIANCES NEAR THE PRODUCT.

- Otherwise, this may result in fire.

Safety Instructions

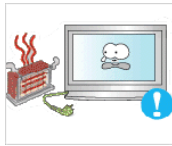

▶ Keep heating appliances as far away from the power cord or the product as possible.

- Otherwise, this may result in electric shock or fire.



▶ Do not install it in a badly ventilated location such as a bookcase or closet.

- Otherwise, this may result in fire due to an increase in the internal temperature.

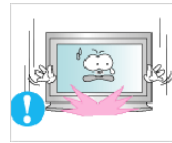

▶ When putting the product down, make sure to put it down softly.

- Otherwise, this may result in damage to the screen display.



▶ Do not place the front of the product on the floor.

- Otherwise, this may result in damage to the screen display.



▶ Ensure that an authorized installation company installs the wall mount.

- Otherwise, it may fall and cause personal injury.

- Make sure to install the specified wall mount.

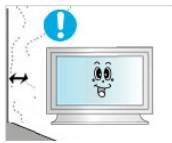

▶ Install your product in a well ventilated location. Ensure that there is a clearance of more than 4 inches (10 cm) from the wall.

- Otherwise, it may result in fire due to an increase in the internal temperature.

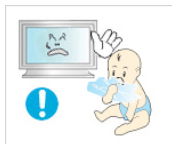

▶ Ensure that the packaging vinyl is kept away from children.

- Otherwise, it may result in serious harm (suffocation) if children play with it.

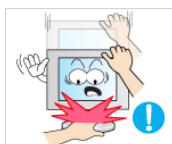

▶ If the height of your monitor is adjustable, do not place any object or part of your body on the stand when lowering it.

- This may cause damage to the product or the person carrying it.

Clean



When cleaning the monitor case or the surface of the TFT-LCD screen, wipe with a slightly moistened, soft cloth.



▶ Do not spray cleaner directly onto the surface of the product.

- Otherwise, this may result in the discoloration and distortion of the structure and the screen surface may peel off.



▶ When cleaning the power plug pins or dusting the power outlet, clean it with a dry cloth.

- Otherwise, it may result in fire.

Safety Instructions



▶ When cleaning the product, make sure to disconnect the power cord.

- Otherwise, it may result in electric shock or fire.



▶ When cleaning the product, disconnect the power cord and clean it with a soft, dry cloth.

- (Do not use chemicals such as wax, benzene, alcohol, thinner, mosquito repellent, lubricant, or cleaner.) These may change the appearance of the product surface and peel off the indication labels on the product.



▶ Since the product housing is easily scratched, make sure to use the specified cloth only.



▶ When cleaning the product, do not spray water directly onto the main body of the product.

- Ensure that water does not enter the product and that it is not wet.
- Otherwise, this may result in electric shock, fire or a malfunction.

Others



▶ The product is a high voltage product. Do not disassemble, repair or modify the product yourself.

- Otherwise, this may result in electric shock or fire. If the product needs to be repaired, contact a Service Center.

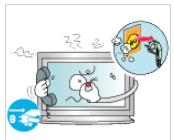

▶ If there is a strange smell or a strange sound or smoke is coming from the product, disconnect the power plug immediately and contact a Service Center.

- Otherwise, this may result in electric shock or fire.

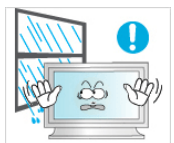

▶ Do not place this product in a location exposed to moisture, dust, smoke, water, or in a car.

- Otherwise, this may result in electric shock or fire.



▶ When you drop the product or the case is broken, turn the power off and disconnect the power cord. Contact a Service Center.

- Otherwise, this may result in electric shock or fire.



▶ If thunder or lightning is occurring, do not touch the power cord or antenna cable.

- Otherwise, this may result in electric shock or fire.

Safety Instructions



▶ Do not try to move the monitor by pulling only the wire or the signal cable.

- Otherwise, it may fall and result in electric shock, damage to the product or fire due to damage to the cable.

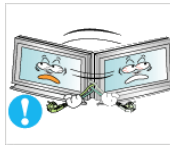

▶ Do not lift or move the product back and forwards or right and left while only holding the power cord or signal cables.

- Otherwise, it may fall and result in electric shock, damage to the product or fire due to damage to the cable.



▶ Make sure that the ventilating opening is not blocked by a table or curtain.

- Otherwise, it may result in fire due to an increase in the internal temperature.

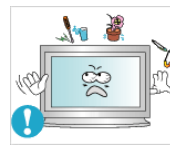

▶ Do not place any containers containing water, vases, flower-pots, medicines as well as any metal on the product.

- If water or a foreign material enters the product, disconnect the power cord and contact a Service Center.

• This may result in a product malfunction, electric shock, or fire.

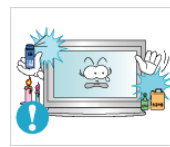

▶ Do not use or keep combustible spray or flammable material near the product.

- Otherwise, this may result in an explosion or fire.

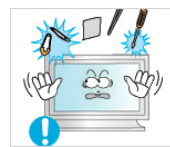

▶ Do not insert any metal, such as chopsticks, coins, pins and steel, or flammable objects, such as matches or paper, inside the product (through the ventilating openings, input and output terminals, etc).

- If water or foreign material enters the product, disconnect the power cord and contact a Service Center.

• Otherwise, this may result in electric shock or fire.



▶ When using a fixed screen for a long time, an afterimage or stain may occur.

- If you are not using your product for a long period of time, put it into sleep mode or use a moving screen saver.

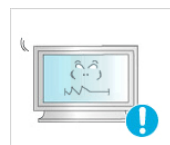

▶ Set a resolution and frequency appropriate to the product.

- Otherwise, your eyesight may be damaged.



▶ When using headphones or earphones, do not turn the volume too high.

- Having the sound too loud may damage your hearing.

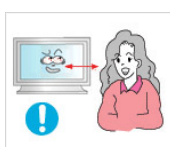

▶ To avoid eyestrain, do not sit too close to the product.

Safety Instructions



▶ Take a rest for at least five (5) minutes after using the monitor for one (1) hour.

This reduces eye fatigue.



▶ Do not install it in an unstable location such as an unstable rack or uneven surface or a location exposed to vibrations.

- Otherwise, it may fall and cause personal injury and/or damage the product.

- If you use the product in a location exposed to vibrations, it may damage the product and result in fire.



▶ When moving the product, turn the power off and disconnect the power plug, antenna cable, and all the cables connected to the product.

- Otherwise, it may result in electric shock or fire.

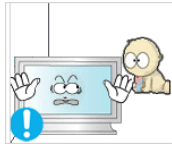

▶ Ensure that children do not hang onto the product or climb up onto the product.

- The product may fall and cause personal injury or death.



▶ If you do not use the product for a long period of time, disconnect the power cord from the power outlet.

- Otherwise, this may result in overheating or fire due to dust, and may result in fire due to electric shock or leakage.

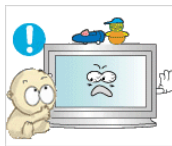

▶ Do not place any heavy items or toys or confectionery, such as cookies etc. that may attract the attention of children and to the product.

- Your children may hang onto the product causing it to fall and this may result in personal injury or death.



▶ Be careful that children do not place the battery in their mouths when removed from the remote control. Place the battery in a location that children or infants cannot reach.

- If children have had the battery in their mouths, consult your doctor immediately.

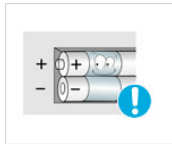

▶ When replacing the battery, insert it with the right polarity (+, -).

- Otherwise, the battery may become damaged or it may cause fire, personal injury or damage due to leakage of the internal liquid.



▶ Use only the specified standardized batteries, and do not use a new battery and a used battery at the same time.

- Otherwise, the batteries may be damaged or cause fire, personal injury or damage due to a leakage of the internal liquid.

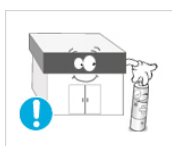

▶ The batteries (and rechargeable batteries) are not ordinary refuse and must be returned for recycling purposes. The customer is responsible for returning the used or rechargeable batteries for recycling.

Safety Instructions

- The customer can return used or rechargeable batteries to a nearby public recycling center or to a store selling the same type of the battery or rechargeable battery.



- ▶ Do not place the product in a location exposed to direct sunlight or near any heat such as a fire or heater.

- This may reduce the lifetime of the product, and may result in fire.



- ▶ Do not drop any objects onto the product or cause any impact to the product.

- Otherwise, this may result in electric shock or fire.



- ▶ Do not use a humidifier near the product.

- Otherwise, this may result in electric shock or fire.

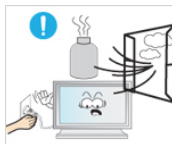

- ▶ When there is a gas leak, do not touch the product or the power plug; ventilate immediately.

- If a spark occurs, it may cause an explosion or fire.

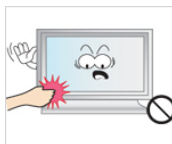

- ▶ If the product has been turned on for a long time, the display panel becomes hot. Do not touch it.



- ▶ Keep the small accessories in a location out of the reach of children.



- ▶ Be careful when adjusting the angle of the product or the height of the stand.

- This may result in personal injury as your hand or fingers may become caught.

- Also, if you tilt the product too far, it may fall and cause personal injury.

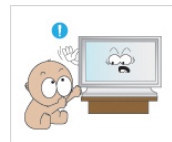

- ▶ Do not install the product in a location low enough for children to reach.

- Otherwise, it may fall and result in personal injury.

- Since the front part of the product is heavy, install the product on a level and stable surface.



- ▶ Do not put any heavy objects on the product.

- This may result in personal injury and/or damage to the product.

Introduction

Package Contents



Please make sure the following items are included with your LCD Display.

If any items are missing, contact your dealer.

Contact a local dealer to buy optional items.

Checking the Contents of the Package

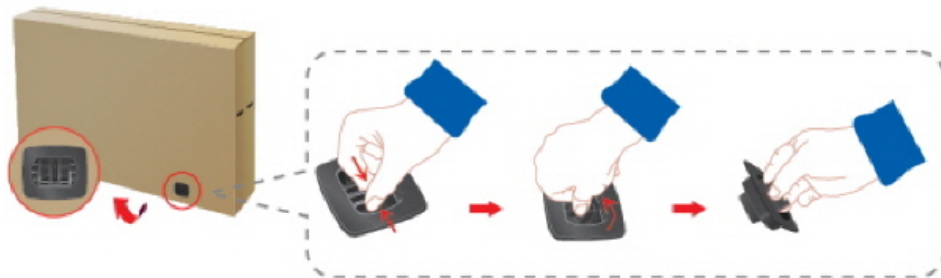

Remove the lock from the package box, as shown in the figure above.



Lift up the package box by holding the grooves on both sides of the package box.

Check the contents of the package.

Remove the Styrofoam and vinyl cover.



- After unpacking the package, make sure to check the contents of the package.
- Make sure to keep the package box for transporting the product in the future.

Unpacking



LCD Display

Manuals



Quick Setup Guide



Warranty Card

(Not available in all locations)



User's Guide



**MagicInfo Software CD,
MagicInfo Manual CD**

(Applicable to the DXN-2 model only)

Cables



Power Cord

Others



Remote Control
(BP59-00138A)



Batteries (AAA X 2)
(Not available in all locations)



BNC to RCA Adaptor Jack
(Applicable to the DXN-2 model only)

Sold separately



D-Sub Cable



DVI Cable



LAN Cable

(Used with DXN-2 model only)

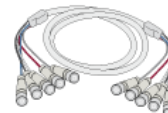
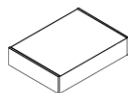

Sold separately

Wall Mount KIT

RGB to BNC Cable

BNC to BNC Cable

(Applicable to the DX-2 model only)



Semi Stand KIT

Your LCD Display

Front

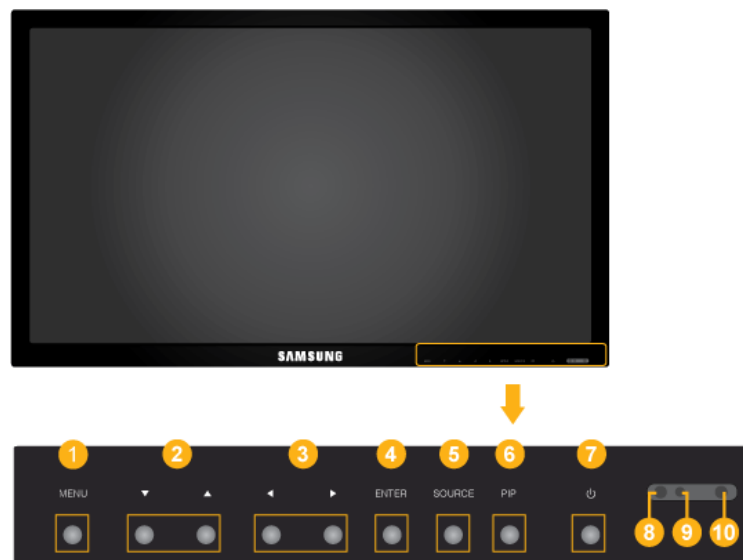

1 MENU button [MENU]

Opens the on-screen menu and exits from the menu. Also use to exit the OSD menu or return to the previous menu.

2 Navigate buttons (Up-Down buttons)

Moves from one menu item to another vertically or adjusts selected menu values.

3 Adjust buttons (Left-Right buttons) / Volume buttons

Moves from one menu item to another horizontally or adjusts selected menu values. When OSD is not on the screen, press the button to adjust volume.

4 ENTER button [ENTER]

Activates a highlighted menu item.

5 SOURCE button [SOURCE]

Switches from PC mode to Video mode. Selects the input source that an external device is connected to.

[PC] → [DVI] → [AV] → [Component] → [HDMI] → [MagicInfo]



Note

- The **BNC** mode will not be activated on the DXN-2 model.
- **MagicInfo** supports the DXN-2 model only.

6 *PIP button*

Push the PIP button to turn the PIP screen On / Off.

More than one PIP cannot overlap on screen as BNC and the component use the same terminal.

- **PC** : DVI / AV / HDMI
- **BNC** : DVI / AV / HDMI
- **DVI / AV** : PC / BNC
- **Component** : PC
- **HDMI** : PC / BNC

7 *Power button [⏻]*

Use this button for turning the LCD Display on and off.

8 *Brightness Sensor (Optional)*

Automatically detects the surrounding brightness.



Note

This function is activated only on the models equipped with an auto brightness sensor.

9 *Power indicator*

Shows PowerSaver mode by blinking green



Note

See PowerSaver described in the manual for further information regarding power saving functions. For energy conservation, turn your LCD Display OFF when it is not needed or when leaving it unattended for long periods.

10 *Remote Control Sensor*

Aim the remote control towards this spot on the LCD Display.

Rear



Note

For detailed information concerning cable connections, refer to Connecting Cables under Setup. The LCD Display 's configuration at the back may vary slightly depending on the model.



Note

E Applicable to the DX-2 model only.

F Applicable to the DXN-2 model only.

A

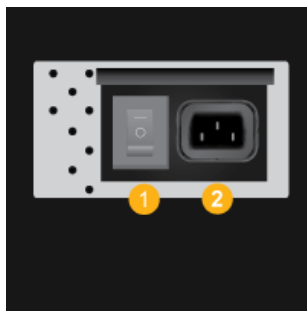

1 *POWER SW ON [/] / OFF [O]*

Switches the LCD Display On/Off.

2 *POWER*

The power cord plugs into the LCD Display and the wall outlet.

B

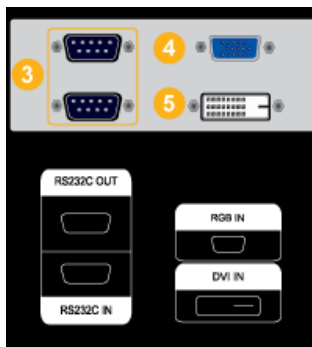

3 *RS232C OUT/IN (RS232C Serial PORT)*

MDC(Multiple Display Control) Program Port

4 *RGB IN (PC Connection Terminal (Input))*

- Use a D-Sub Cable (15 pin D-Sub) - PC mode (Analog PC)
- Connect the RGB IN port on the monitor to the BNC port on the PC using the RGB to BNC cable.

5 *DVI IN (PC Video Connection Terminal)*

Use a DVI Cable (DVI-D to DVI-D) - DVI mode (Digital PC)

C

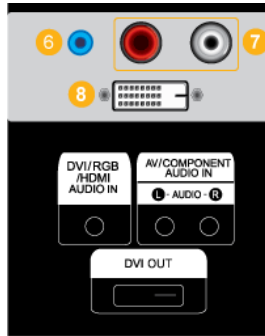

6 *DVI/RGB/HDMI AUDIO IN (PC/DVI/HDMI Audio Connection Terminal (Input))*

7 *AV/COMPONENT AUDIO IN [L-AUDIO-R]*

Connect the port of the DVD, VCR (DVD / DTV Set-Top Box) to the [L- AUDIO - R] port of the LCD Display.

8 *DVI OUT*

- Connect a monitor to another monitor through a DVI cable.
- Connect the DVI OUT port on the monitor to the HDMI IN port on the other monitor using the DVI to HDMI cable.
- DVI, HDMI and network signals sent via the DVI OUT port are displayed on the second display which has the DVI IN port.

 **Note**

Up to 6 Full HD or 10 HD monitors can be connected (May differ depending on the product).

D

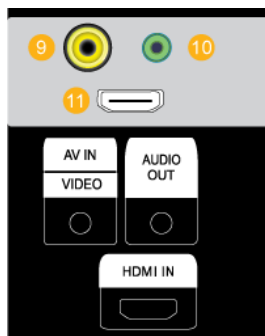

9 *AV IN [VIDEO]*

Connect the [VIDEO] terminal of your monitor to the video output terminal of the external device using a VIDEO cable.

10 *AUDIO OUT*

Headphone/External speaker output terminal.

11 *HDMI IN*

Connect the HDMI terminal at the back of your LCD Display to the HDMI terminal of your digital output device using a HDMI cable.

Up to HDMI cable 1.0 can be supported.

E

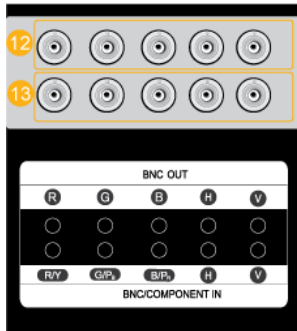

12 *BNC OUT [R, G, B, H, V] (BNC Terminal (Output))*

BNC (Analog PC) Connection: connecting the R, G, B, H, V ports.

The number of LCD Displays that can be connected to the loopout depends on the cables, signal source, etc. With cables or signal source where there is no degradation, up to 10 LCD Displays can be connected (May not be supported depending on the connected cable).

 **Note**

(Applicable to the DX-2 model only)

13 *BNC/COMPONENT IN [R/Y, G/P_B, B/P_R, H, V] (BNC/Component Connection Terminal (input))*

During component input, please check specifications for the input ports below.

[R/Y, G/P_B, B/P_R, H, V]

- [R/Y] --> Red port input
- [G/P_B] --> Green port input
- [B/P_R] --> Blue port input

 **Note**

Applicable to the DX-2 model only.

F

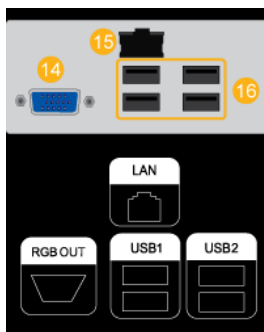

14 *RGB OUT*

 **Note**

Applicable to the DXN-2 model only.

15 *LAN (LAN Connection Terminal)*

 **Note**

Applicable to the DXN-2 model only.

16 *USB1, USB2 (USB Connection Terminal)*

Keyboard / Mouse, Mass Storage Device Compatible.

 **Note**

Applicable to the DXN-2 model only.

G

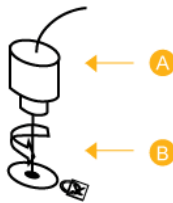

Kensington Lock

The Kensington Lock is a device used to physically fix the system when using it in a public place. The locking device has to be purchased separately. The appearance and locking method may differ from the illustration depending on the manufacturer. Refer to the manual provided with the Kensington Lock for proper use. The locking device has to be purchased separately.

Note

The location of the Kensington Lock may be different depending on the model.

Using the Anti-Theft Kensington Lock

1. Insert the locking device into the Kensington slot on the LCD Display **B** and turn it in the locking direction **A**.
2. Connect the Kensington Lock cable.
3. Fix the Kensington Lock to a desk or a heavy stationary object.

Note

See Connecting Cables for further information regarding cable connections.

Remote Control

Note

The performance of the remote control may be affected by a TV or other electronic device operating near the LCD Display , causing a malfunction due to interference with the frequency.

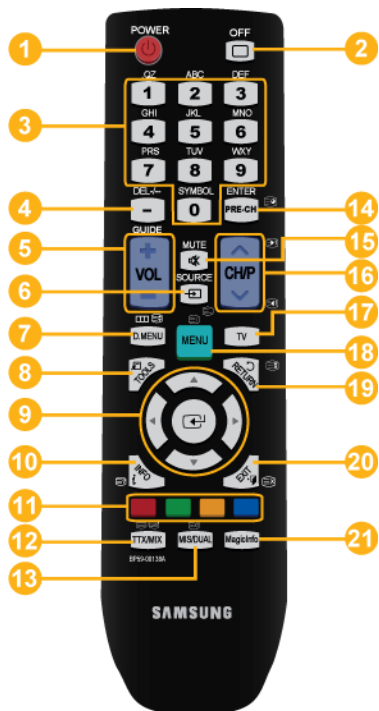



- 1 POWER
- 2 OFF
- 3 Number Buttons
- 4 DEL / GUIDE button
- 5 + VOL -
- 6 SOURCE
- 7 D.MENU
- 8 TOOLS
- 9 Up-Down Left-Right buttons
- 10 INFO
- 11 COLOR BUTTONS
- 12 TTX/MIX
- 13 MTS/DUAL
- 14 ENTER/PRE-CH
- 15 MUTE
- 16 CH/P
- 17 TV
- 18 MENU
- 19 RETURN
- 20 EXIT
- 21 MagicInfo

- 1. POWER Turns the product On.
- 2. OFF Turns the product Off.
- 3. Number Buttons Press to change the channel.
- 4. DEL / GUIDE button
The "-" button is used to select Digital channels.
Electronic Program Guide (EPG) display.
- This function does not work for this LCD Display.
- 5. + VOL - Adjusts the audio volume.
- 6. SOURCE Press the button to change the input signal SOURCE.

Changing the SOURCE is only allowed for external devices that are connected to the LCD Display at the time.
- 7. D.MENU DTV menu display

- This function does not work for this LCD Display.
- 8. TOOLS Use to quickly select frequently used functions.

- This function does not work for this LCD Display.
- 9. Up-Down Left-Right buttons
Moves from one menu item to another horizontally, vertically or adjusts selected menu values.
- 10.  INFO
Current picture information is displayed on the upper left corner of the screen.
- 11. COLOR BUTTONS
Press to add or delete channels and to store channels to the favorite channel list in the "Channel List" menu.
- This function does not work for this LCD Display.
- 12.  TTX/MIX
TV channels provide written information services via teletext.

- Teletext Buttons



- This function does not work for this LCD Display.
- 13. MTS/DUAL
- This function does not work for this LCD Display.





MTS-



You can select MTS (Multichannel Television Stereo) mode.

	Audio Type	MTS/S_Mode	Default
FM Stereo	Mono	Mono	Manual Change
	Stereo	Mono ↔ Stereo	
	SAP	Mono ↔ SAP	Mono

DUAL-

STEREO/MONO, DUAL I / DUAL II and MONO/NICAM MONO/NICAM STEREO can be operated depending on the broadcasting type by using the DUAL button on the remote control while watching TV.

- 14.  ENTER/PRE-CH
This button is used to return to the immediately previous channel.
- This function does not work for this LCD Display.
- 15.  MUTE
Pauses (mutes) the audio output temporarily. This is displayed on the lower left corner of the screen. The audio comes back on if MUTE or - VOL + is pressed in the Mute mode.
- 16.  CH/P 
In **TV** mode, selects TV channels.
- This function does not work for this LCD Display.
- 17. TV
Selects the TV mode directly.
- This function does not work for this LCD Display.
- 18.  MENU
Opens the on-screen menu and exits from the menu or closes the adjustment menu.

- 19.  RETURN Returns to the previous menu.
- 20.  EXIT Exits from the menu screen.
- 21. MagicInfo MagicInfo Quick Launch Button.

Connections

Connecting a Computer

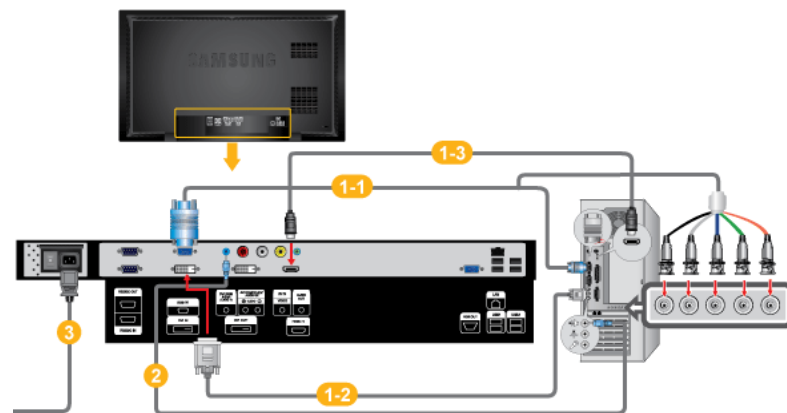

(400DXN-2,460DXN-2)

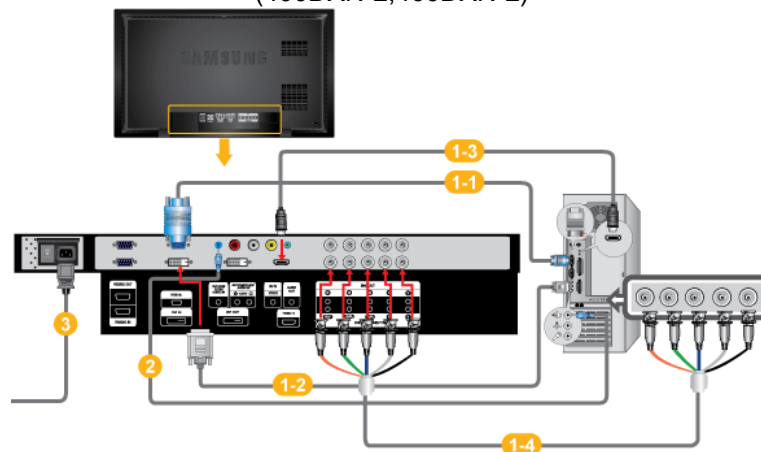

(400DX-2,460DX-2)

- 1 There are several ways to connect the computer to the monitor. Choose one from the following options.

1-1 Using the D-sub (Analog) connector on the video card.

- Connect the D-sub to the 15-pin, RGB port on the back of your LCD Display and the 15 pin D-sub Port on the computer.

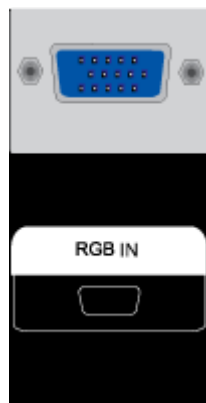

1-2 Using the DVI (Digital) connector on the video card.

- Connect the DVI Cable to the DVI port on the back of your LCD Display and the DVI port on the computer.

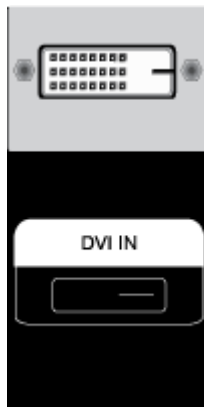

1-3 Using the HDMI (digital) output on the graphics card.

- Connect the HDMI IN port on the monitor to the HDMI port on the PC using the HDMI cable.

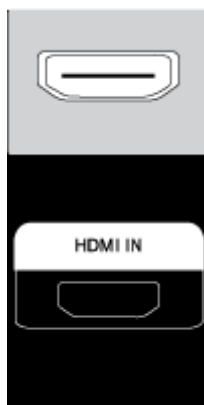

 **Note**

When the HDMI cable to the PC, ensure that you select **HDMI** from both the **Source List** and **Edit Name** before selecting **PC** or **DVI** device so that normal PC screen and sound can be outputted. Note that sound is only available when connected according to the option **2** that follows.

1-4 Using the BNC (Analog) connector on the video card. (Applicable to the DX-2 model only)

- Connect the BNC/COMPONENT IN port on the monitor to the BNC port on the PC using the BNC to BNC cable.

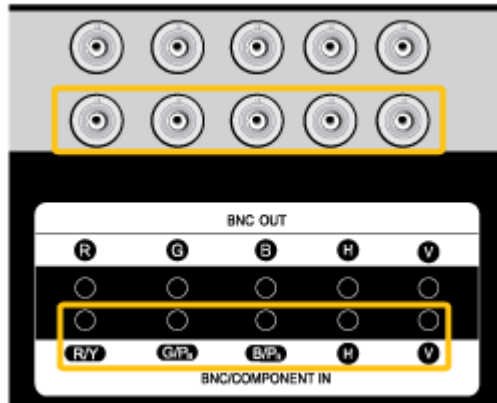

- 2 Connect the audio cable for your LCD Display to the audio port on the back of the LCD Display.
- 3 Connect the power cord for your LCD Display to the power port on the back of the LCD Display. Turn on the power switch.

 **Note**

- Turn on both your computer and the LCD Display.
- Contact a local SAMSUNG Electronics Service Center to buy optional items.

Connecting to Other devices

- AV input devices such as DVD players, VCRs or camcorders as well as your computer can be connected to the LCD Display. For detailed information on connecting AV input devices, refer to the contents under Adjusting Your LCD Display.
- The LCD Display 's configuration at the back may vary slightly depending on the LCD Display model.

Connecting AV Devices



1. Connect the Video and Audio [R-AUDIO-L] port of the DVD, VCR or DTV Set-Top Box to the Video and Audio [R-AUDIO-L] LCD Display.
2. Play the DVD, VCR or Camcorder with a DVD disc or tape inserted.
3. Select **AV** using the SOURCE button on the front of the LCD display or on the remote.

Connecting to a Camcorder

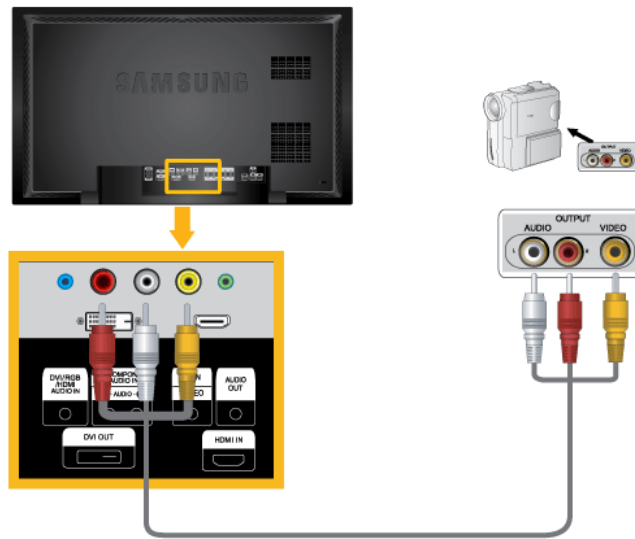

1. Locate the AV output jacks on the camcorder. They are usually found on the side or back of the camcorder. Connect a set of audio cables between the AUDIO OUTPUT jacks on the camcorder and the AV/COMPONENT AUDIO IN [L-AUDIO-R] on the LCD Display .
2. Connect a video cable between the VIDEO OUTPUT jack on the camcorder and the AV IN [VIDEO] on the LCD Display .
3. Select **AV** for the Camcorder connection using the Source button on the front of the LCD Display or on the remote control.
4. Then, start the Camcorder with a tape inserted.

 **Note**

The audio-video cables shown here are usually included with a Camcorder. (If not, check your local electronics store.) If your camcorder is stereo, you need to connect a set of two cables.

Connecting the BNC to BNC cable

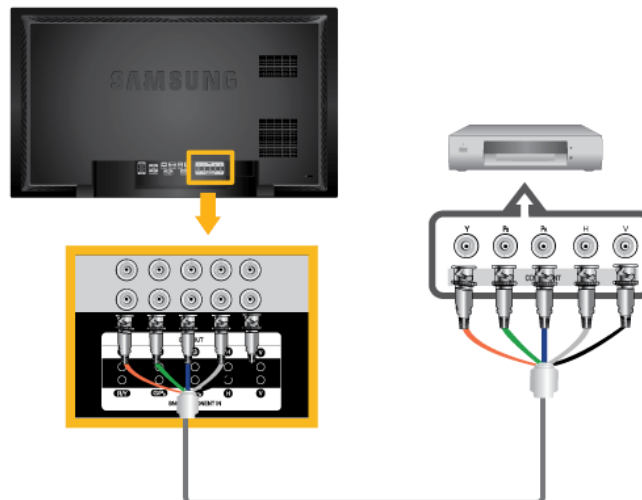

1. Connect the BNC/COMPONENT IN [R/Y, G/P_B, B/P_R] ports on the monitor to the BNC port on the external device using the BNC to BNC cable.

2. Select **BNC** for the Camcorder connection using the Source button on the front of the LCD Display or on the remote control.

 **Note**

Applicable to the DX-2 model only.

Connecting Using a DVI Cable

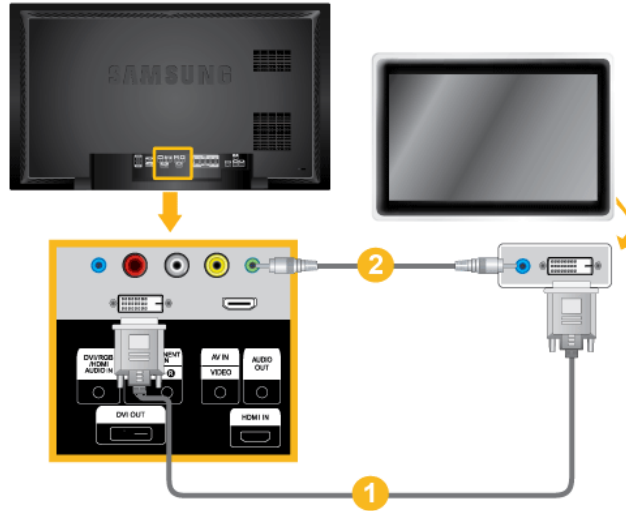

1. Connect between the DVI OUT port on the LCD Display and the input port on another monitor using a DVI cable.
2. Connect between the AUDIO OUT port on the LCD Display and the audio input port on another monitor using a stereo cable.
3. Select DVI using the SOURCE button on the front of the LCD Display or on the remote control.

 **Note**

DVI OUT does not support HDCP.

Connecting Using a HDMI Cable

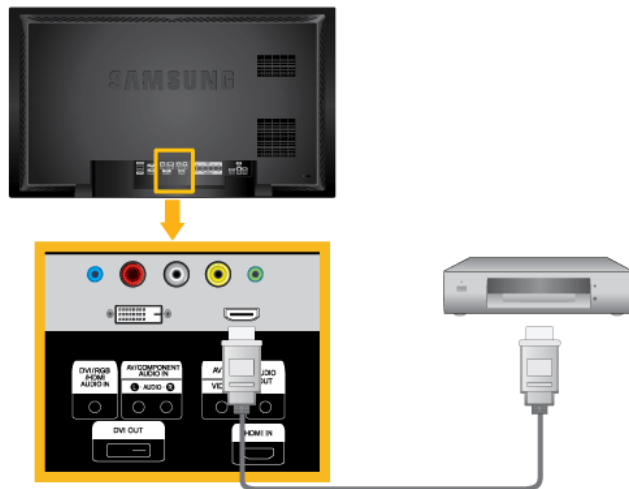

1. Connect input devices such as a Blu-Ray/DVD player to the HDMI IN terminal of the LCD Display using an HDMI cable.

2. Select HDMI using the SOURCE button on the front of the LCD Display or on the remote control.

 **Note**

In HDMI mode, only PCM format audio is supported.

Connecting Using a DVI to HDMI Cable

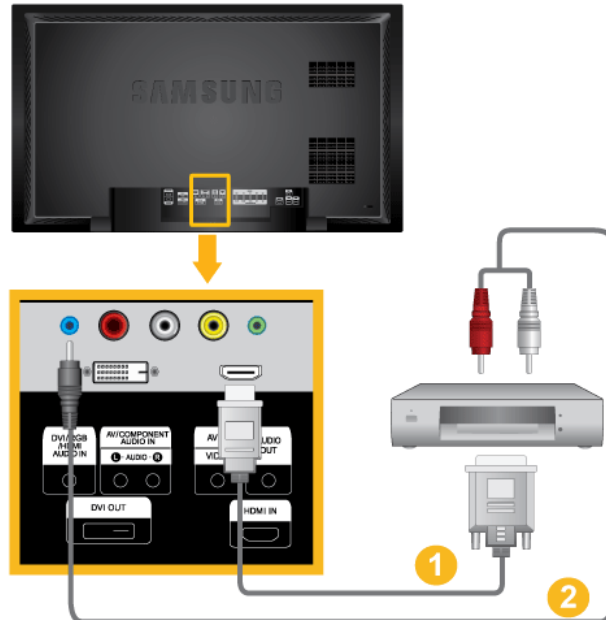

1. Connect the DVI output terminal of a digital output device to the HDMI IN terminal of the LCD Display using a DVI to HDMI cable.
2. Connect the red and white jacks of an RCA to stereo (for PC) cable to the same colored audio output terminals of the digital output device, and connect the opposite jack to the DVI / RGB / HDMI AUDIO IN terminal of the LCD Display.
3. Select HDMI using the SOURCE button on the front of the LCD Display or on the remote control.

Connecting a DVD Player - Applicable to the DX-2 model only.

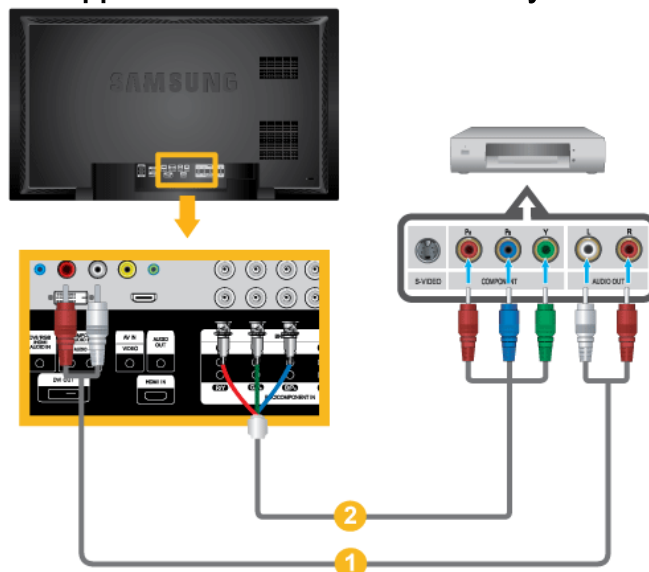

1. Connect a set of audio cables between the AV/COMPONENT AUDIO IN [L-AUDIO-R] on the LCD Display and the AUDIO OUT jacks on the DVD player.
2. Connect a Component cable between the BNC/COMPONENT IN [R/Y, G/P_B, B/P_R] port on the LCD Display and the P_R, Y, P_B jacks on the DVD player.

 **Note**

- Select **Component** for the connection to a DVD player using the SOURCE button on the front of the LCD Display or on the remote control.
- Then, start the DVD Player with a DVD disc inserted.
- A component cable is optional.
- For an explanation of Component video, consult your DVD manual.

Connecting a DTV Set Top (Cable/Satellite) Box - Applicable to the DX-2 model only.

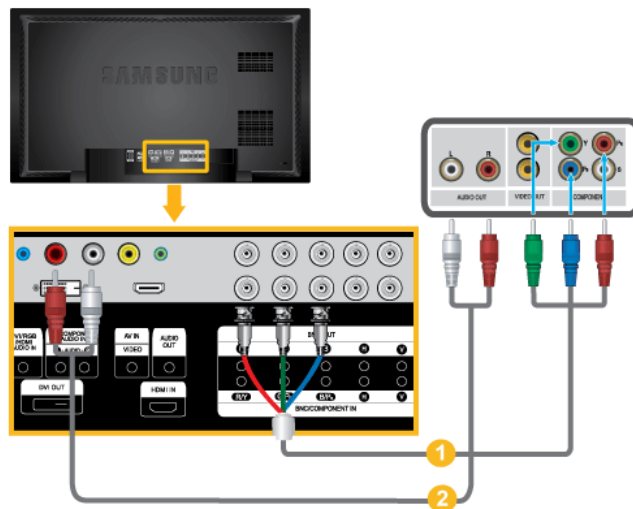

1. Connect a Component cable between the BNC/COMPONENT IN [R/Y, G/P_B, B/P_R] port on the LCD Display and the P_R, Y, P_B jacks on the Set Top Box.
2. Connect a set of audio cables between the AV COMPONENT AUDIO IN [L-AUDIO-R] on the LCD Display and the AUDIO OUT jacks on the Set Top Box.

 **Note**

- Select **Component** for the connection to a DTV Set Top Box using the SOURCE button on the front of the LCD Display or on the remote control.
- For an explanation of Component video, see your Set Top Box owner's manual.

Connecting to an Audio System

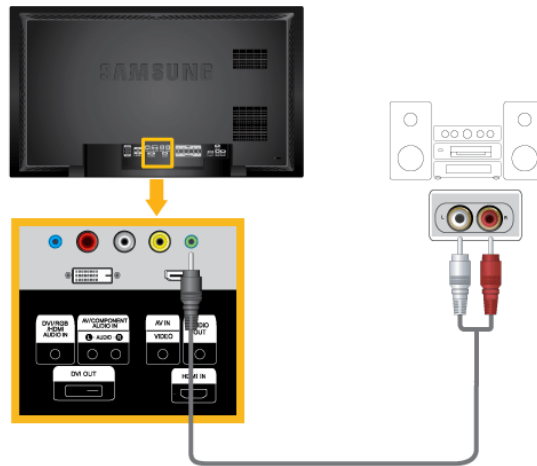

1. Connect a set of audio cables between the AUX L, R jacks on the AUDIO SYSTEM and AUDIO OUT on LCD Display.

Connecting a LAN Cable

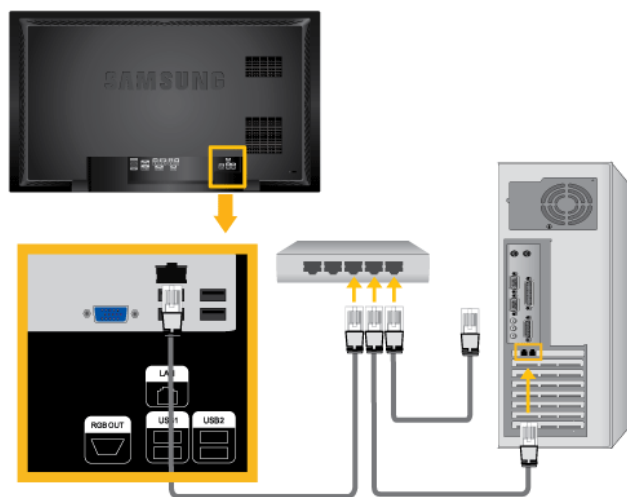

Connect the LAN cable.

(Applicable to the DXN-2 model only)

Connecting a USB device

You can connect USB devices such as a mouse or keyboard.

(Applicable to the DXN-2 model only)

Connections



Using the Software

Monitor Driver



Note

When prompted by the operating system for the monitor driver, insert the CD-ROM included with this monitor. Driver installation is slightly different from one operating system to another. Follow the directions appropriate for the operating system you have.

Prepare a blank disk and download the driver program file at the Internet web site shown here.

Internet web site :

<http://www.samsung.com/>

Installing the Monitor Driver (Automatic)

1. Insert CD into the CD-ROM drive.
2. Click "Windows".
3. Choose your monitor model in the model list, then click the "OK" button.

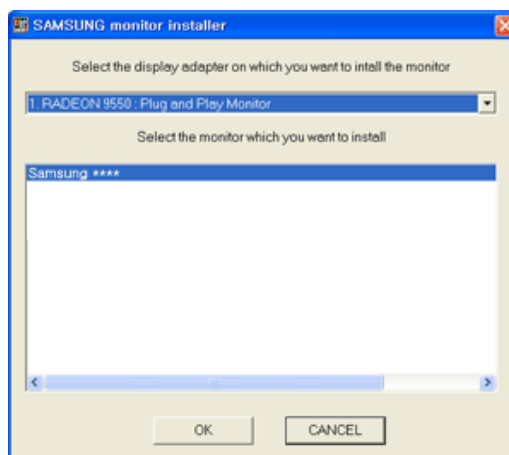

4. If you can see following message window, then click the "Continue Anyway" button. Then click "OK" button (Microsoft® Windows® XP/2000 Operating System).





Note

This monitor driver is certified by Microsoft, and installing it will not damage your system.

The certified driver will be posted on Samsung Monitor homepage.

<http://www.samsung.com/>

Installing the Monitor Driver (Manual)

Microsoft® Windows Vista™, Operating System

1. Insert your Manual CD into your CD-ROM drive.
2. Click  (Start) and "Control Panel". Then, double-click on "Appearance and Personalization".



3. Click "Personalization" and then "Display Settings".



4. Click "Advanced Settings...".



5. Click "Properties" in the "Monitor" tab. If the "Properties" button is deactivated, it means the configuration for your monitor is completed. The monitor can be used as is.

If the message "Windows needs..." is displayed, as shown in the figure below, click "Continue".



 **Note**

This monitor driver is under certifying MS logo, and this installation will not damage your system.

The certified driver will be posted on Samsung Monitor homepage.

6. Click "Update Driver..." in the "Driver" tab.

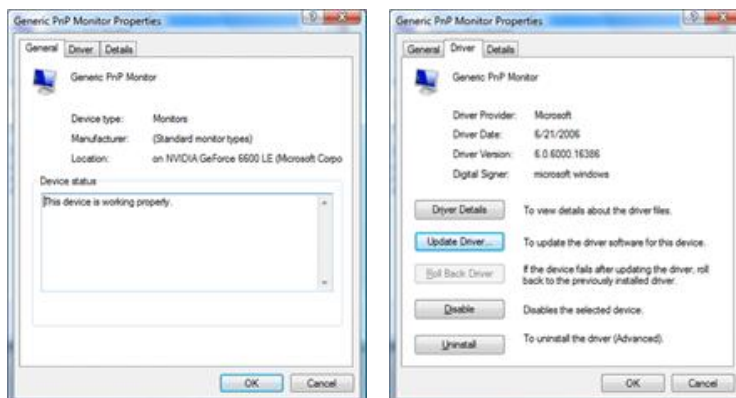

7. Check the "Browse my computer for driver software" checkbox and click "Let me pick from a list of device drivers on my computer".

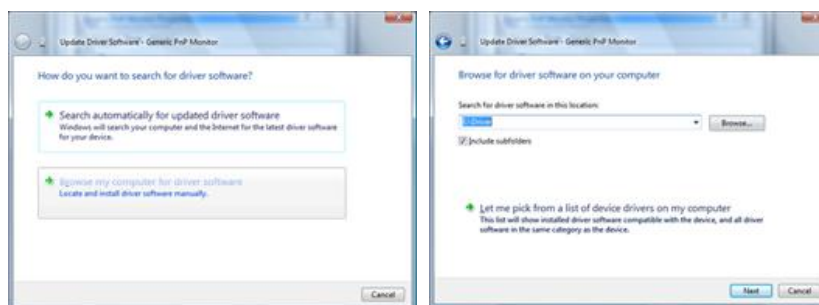

8. Click "Have Disk..." and select the folder (for example, D:\Drive) where the driver setup file is located, and click "OK".

Using the Software

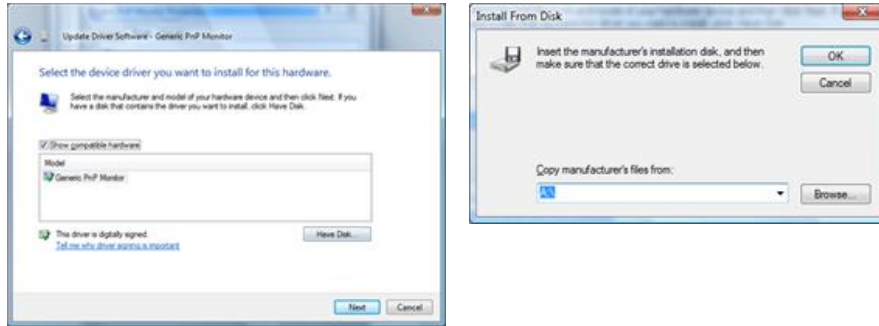

9. Select the model that matches your monitor from the list of monitor models on the screen, and click "Next".

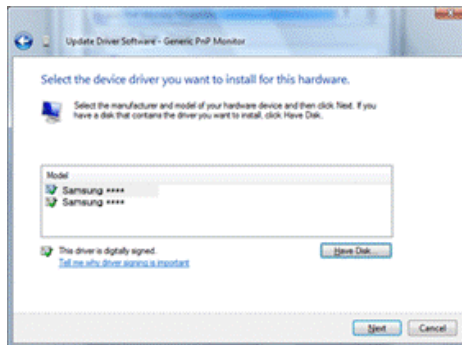

10. Click "Close" → "Close" → "OK" → "OK" on the following screens displayed in sequence.

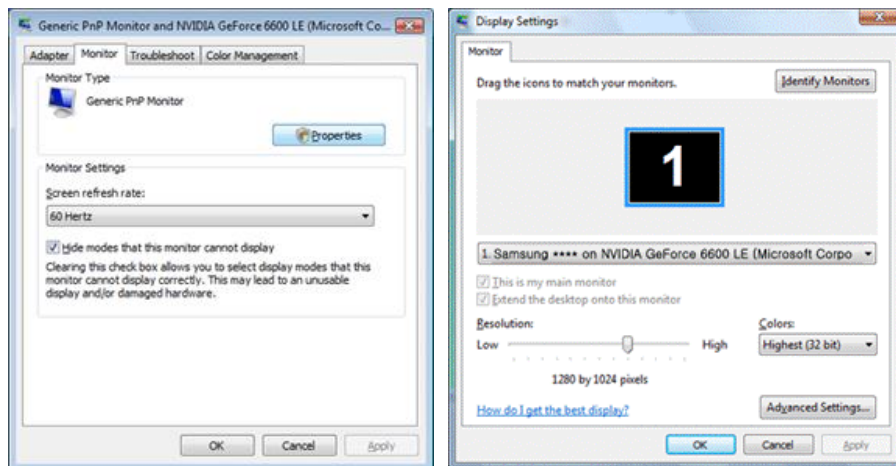
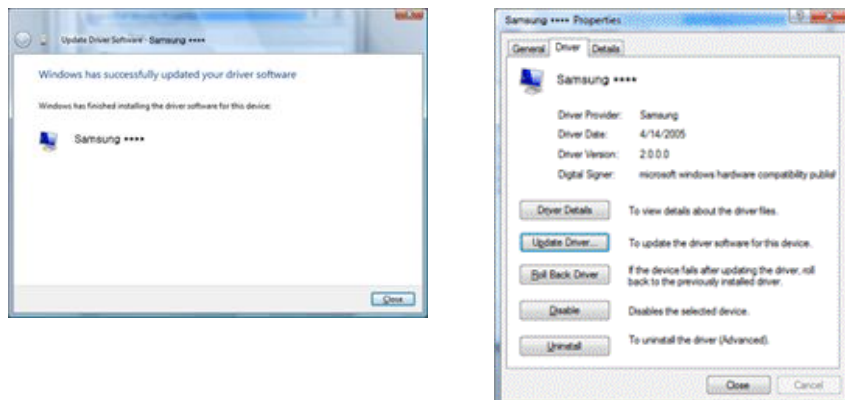

Microsoft® Windows® XP Operating System

Using the Software

1. Insert CD into the CD-ROM drive.
2. Click "Start" → "Control Panel", then click the "Appearance and Themes" icon.

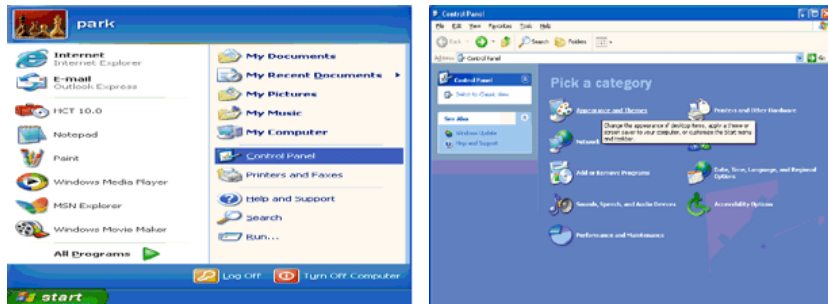

3. Click "Display" icon and choose the "Settings" tab then click "Advanced...".

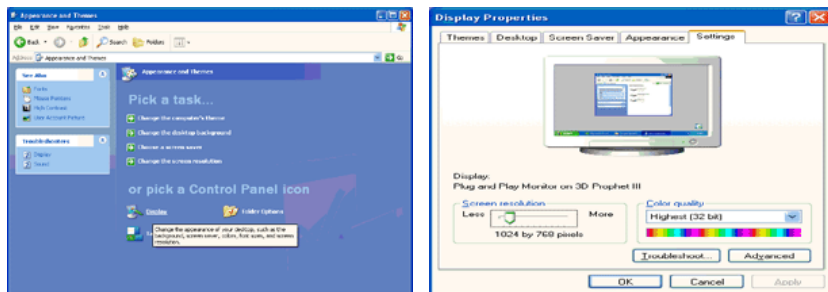

4. Click the "Properties" button on the "Monitor" tab and select "Driver" tab.

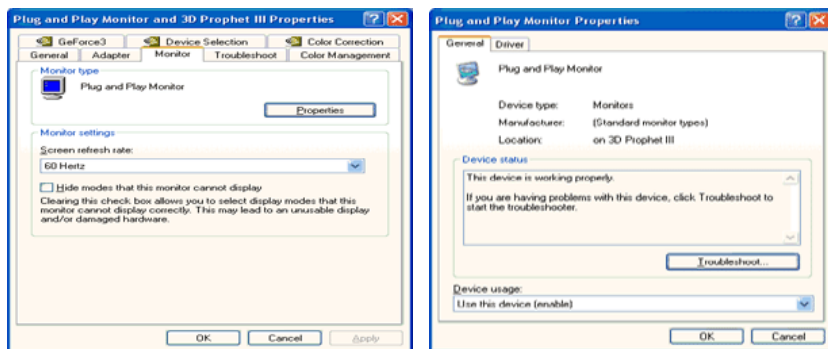

5. Click "Update Driver..." and select "Install from a list or..." then click "Next" button.

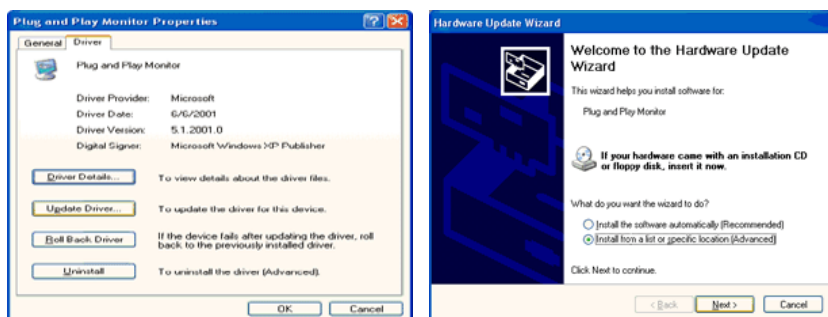

6. Select "Don't search, I will...", then click "Next" and then click "Have disk".

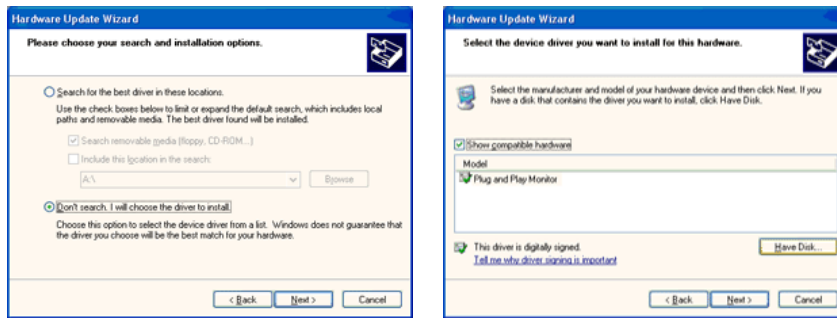

7. Click the "Browse" button then choose A:(D:\Driver) and choose your monitor model in the model list and click the "Next" button.

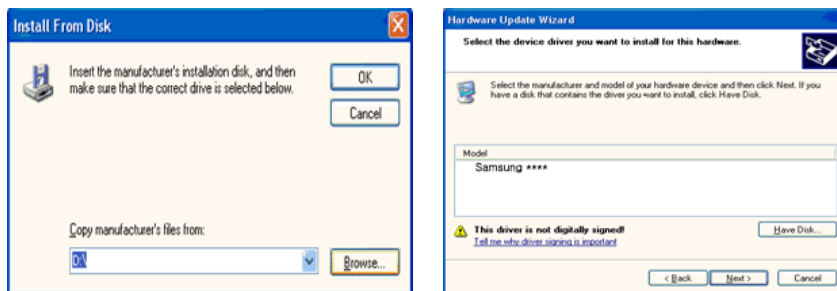

8. If you can see the following message window, then click the "Continue Anyway" button. Then click "OK" button.



 **Note**

This monitor driver is certified by Microsoft, and this installation will not damage your system.

The certified driver will be posted on Samsung Monitor homepage.

<http://www.samsung.com/>

9. Click the "Close" button, then click the "OK" button continually.

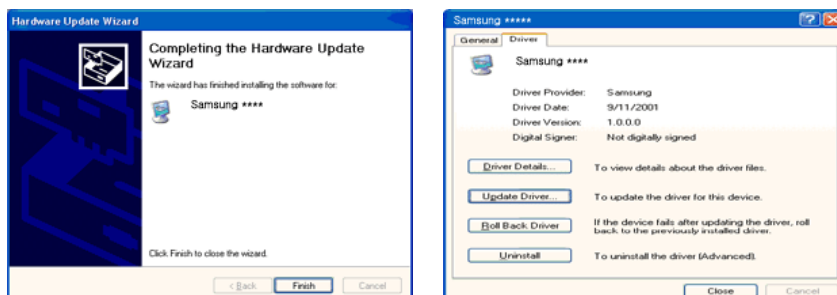

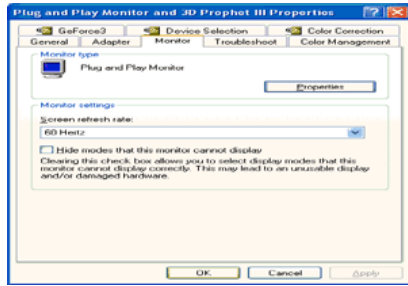

10. Monitor driver installation is completed.

Microsoft® Windows® 2000 Operating System

When you can see "Digital Signature Not Found" on your monitor, follow these steps.

1. Choose "OK" button on the "Insert disk" window.
2. Click the "Browse" button on the "File Needed" window.
3. Choose A:(D:\Driver), then click the "Open" button and then click "OK" button.

How to install

1. Click "Start", "Setting", "Control Panel".
2. Double click the "Display" icon.
3. Select the "Settings" tab and click "Advanced Properties" button.
4. Choose "Monitor".

Case1 : If the "Properties" button is inactive, it means your monitor is properly configured. Please stop installation

Case2 : If the "Properties" button is active, click the "Properties" button, then follow the next steps.

5. Click "Driver" and then click on "Update Driver...", then click on the "Next" button.
6. Choose "Display a list of the known drivers for this device so that I can choose a specific driver", then click "Next" and then click "Have disk".
7. Click the "Browse" button, then choose A:(D:\Driver).
8. Click the "Open" button, then click "OK" button.
9. Choose your monitor model and click the "Next" button. Then click "Next" button.
10. Click the "Finish" button, then the "Close" button.

If you can see the "Digital Signature Not Found" window, then click the "Yes" button. Then click the "Finish" button and the "Close" button.

Microsoft® Windows® Millennium Operating System

1. Click "Start", "Setting", "Control Panel".
2. Double click the "Display" icon.
3. Select the "Settings" tab and click "Advanced Properties" button.

4. Select the "Monitor" tab.
5. Click the "Change" button in the "Monitor Type" area.
6. Choose "Specify the location of the driver".
7. Choose "Display a list of all the driver in a specific location...", then click "Next" button.
8. Click the "Have Disk" button.
9. Specify A:\(D:\driver), then click "OK" button.
10. Select "Show all devices" and choose the monitor that corresponds to the one you connected to your computer and click "OK".
11. Continue choosing "Close" button and "OK" button until you close the Display Properties dialogue box.

Microsoft® Windows® NT Operating System

1. Click "Start", "Settings", "Control Panel", and then double-click "Display" icon.
2. In Display Registration Information window, click Settings Tab and then click "All Display Modes".
3. Select a mode that you wish to use (Resolution, Number of colors and Vertical frequency) and then click "OK".
4. Click "Apply" button if you see the screen working normally after clicking "Test". If the screen is not normal, change to a different mode (lower mode of resolution, colors or frequency).



Note

If there is no Mode at All Display Modes, select the level of resolution and vertical frequency by referring to the Preset Timing Modes in the user guide.

Linux Operating System

To execute X-Window, you need to make the X86Config file, which is a type of system setting file.

1. Press "Enter" at the first and the second screen after executing the X86Config file.
2. The third screen is for setting your mouse.
3. Set a mouse for your computer.
4. The next screen is for selecting a keyboard.
5. Set a Keyboard for your computer.
6. The next screen is for setting your monitor.
7. First of all, set a horizontal frequency for your monitor. (You can enter the frequency directly.)
8. Set a vertical frequency for your monitor. (You can enter the frequency directly.)
9. Enter the model name of your monitor. This information will not affect the actual execution of X-Window.

10. You have finished setting up your monitor. Execute X-Window after setting other requested hardware.

MDC (Multi-Display Channel)



Installation

1. Insert the installation CD into the CD-ROM drive.
2. Click the MDC installation file.
 **Note**
If the popup window to install the software for the main screen is not displayed, proceed with the installation using the MDC executable file on the CD.
3. When the Installation Shield Wizard window appears, click "Next".
4. Select "I agree to the terms of the license agreement" to accept the terms of use.
5. Click "Install".
6. The "Installation Status" window appears.
7. Click "Finish".
8. When the installation is complete, the MDC executable icon appears on your desktop. Double-click the icon to start the program.

MDC execution icon may not appear depending on specification of computer system or monitor. If that happens, press F5 Key.

Installation Problems

The installation of MDC can be affected by such factors as the video card, motherboard and the network environment.

Uninstall

The MDC program can be removed only by using the "Add or Remove Programs" option of the Windows® Control Panel.

Perform the following steps remove MDC.

Select "Setting/Control Panel" on the "Start" menu and then double-click "Add/Delete a program".

Select MDC from the list and then click the "Add/Delete" button.

■ Using MDC

Multiple Display Control *MDC System*

Introduction

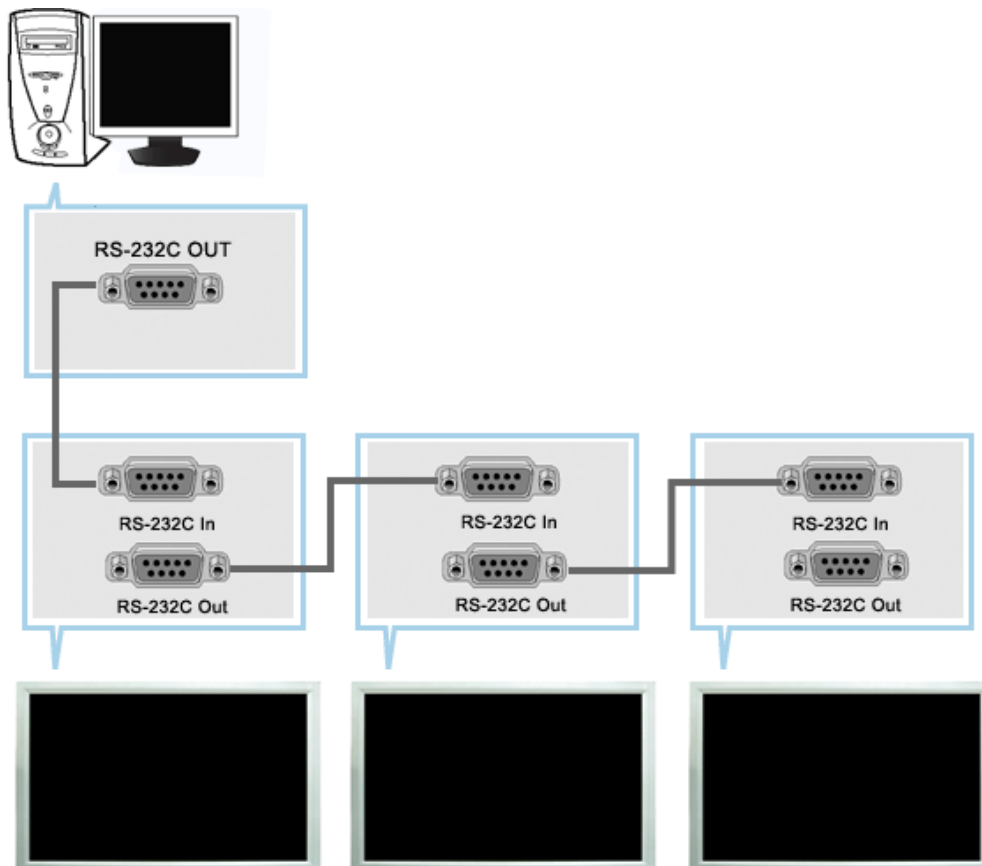

A Multiple Display Control (MDC) is an application allowing various displays to be easily and simultaneously operated on a PC. RS-232C, a standard of serial communication, is used for the communication between a PC and a display. Therefore, a serial cable should be connected between the serial port on a PC and the serial port on a display.

Main Screen

Click Start > Program > Samsung > MDC System to start the program.

Select a set to see the volume of the selected set within the slider.

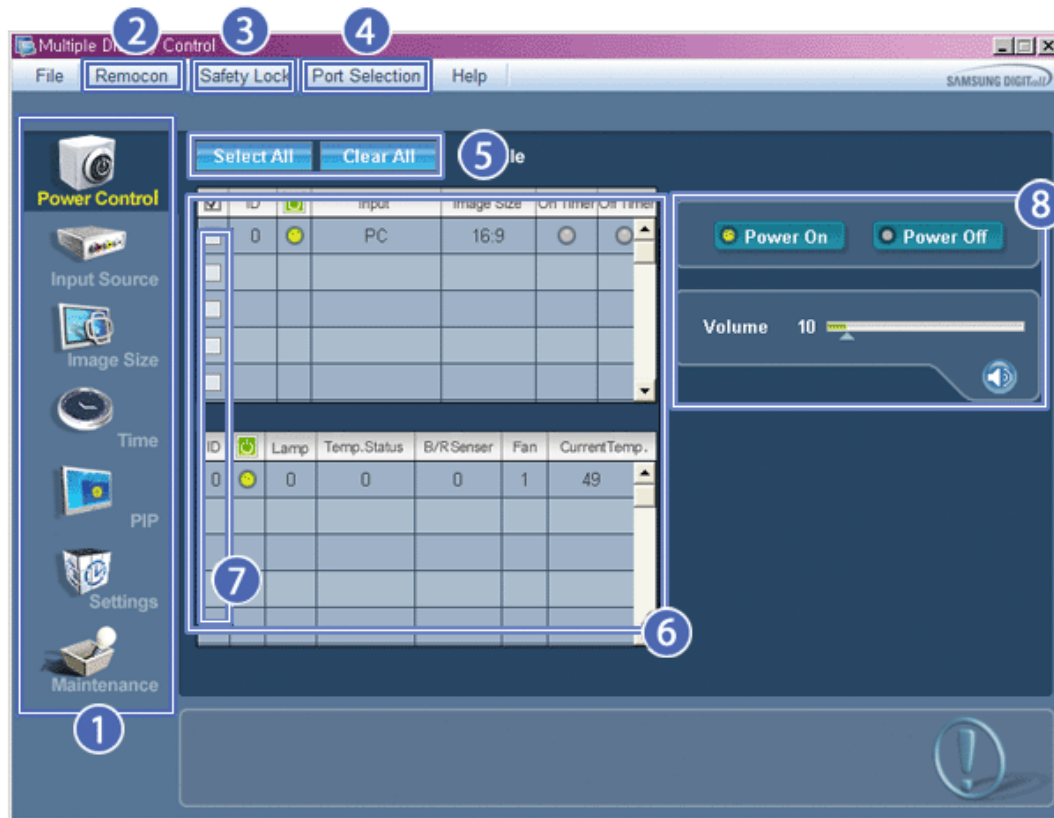

- 1 Main Icons
- 2 Remocon
- 3 Safety Lock
- 4 Port Selection
- 5 Select Button
- 6 Info Grid
- 7 Display Selection
- 8 Control Tools

1. Use the main icons to switch into each screen.
2. Allows you to enable or disable the remote control signal receiving function of the display unit.
3. Set the Safety Lock function.
When setting the Lock function, you can only operate power and lock buttons on the remote control and set.
4. The setting for the PC Serial Port can change. The original value is COM1.
5. Click Select all or Clear to select or clear all displays.
6. Use Grid to view brief information on selected display.
7. Select a display from Display Selection.
8. Use Control Tools to control displays.

<Note> The remote control Enable/Disable function operates whether or not the power is On/Off, and this applies to all displays connected to the MDC. However, regardless of the status at the time the MDC is shut down, the remote control signal receiving function of all displays is initialized to Enable when the MDC is closed.

Port Selection

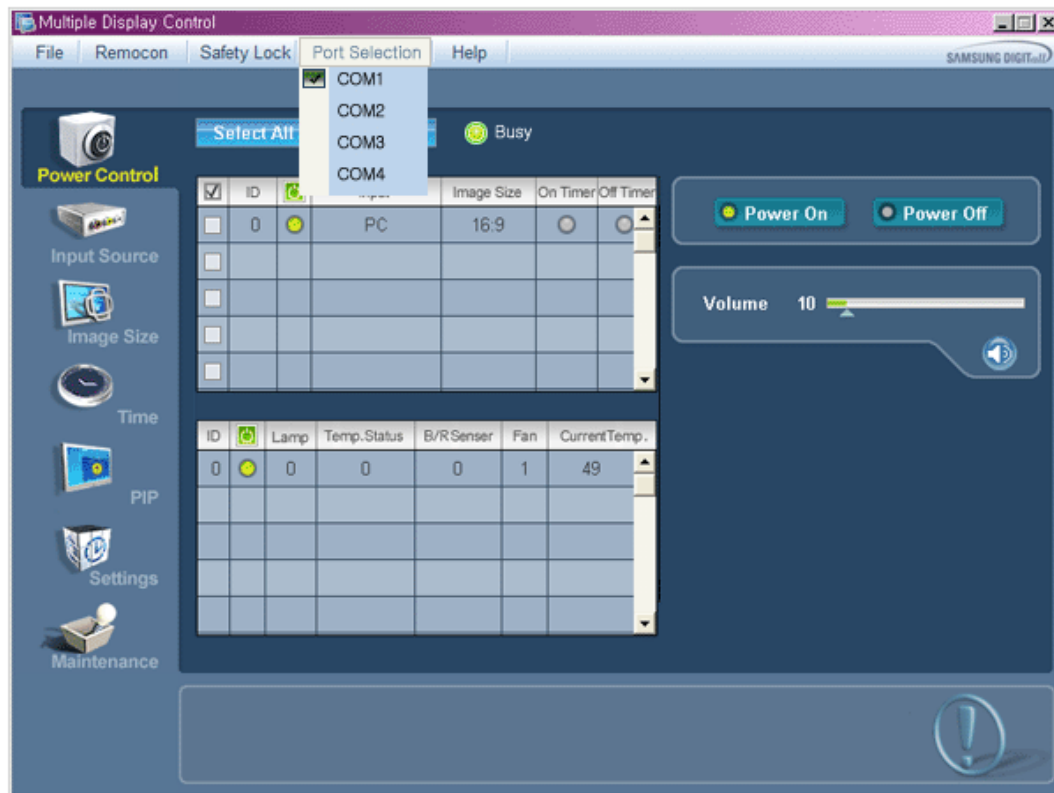

1. The Multiple Display Control is originally set to COM1.
2. If any port other than COM1 is used, COM1 through COM4 can be selected in the Port Selection Menu.
3. If the exact port name that is connected to the LCD Display using a serial cable is not selected, communication will be unavailable.
4. The selected port is stored in the program and used for the next program as well.



Power Control

1. Click Power Control of the main icons and the Power Control screen appears.

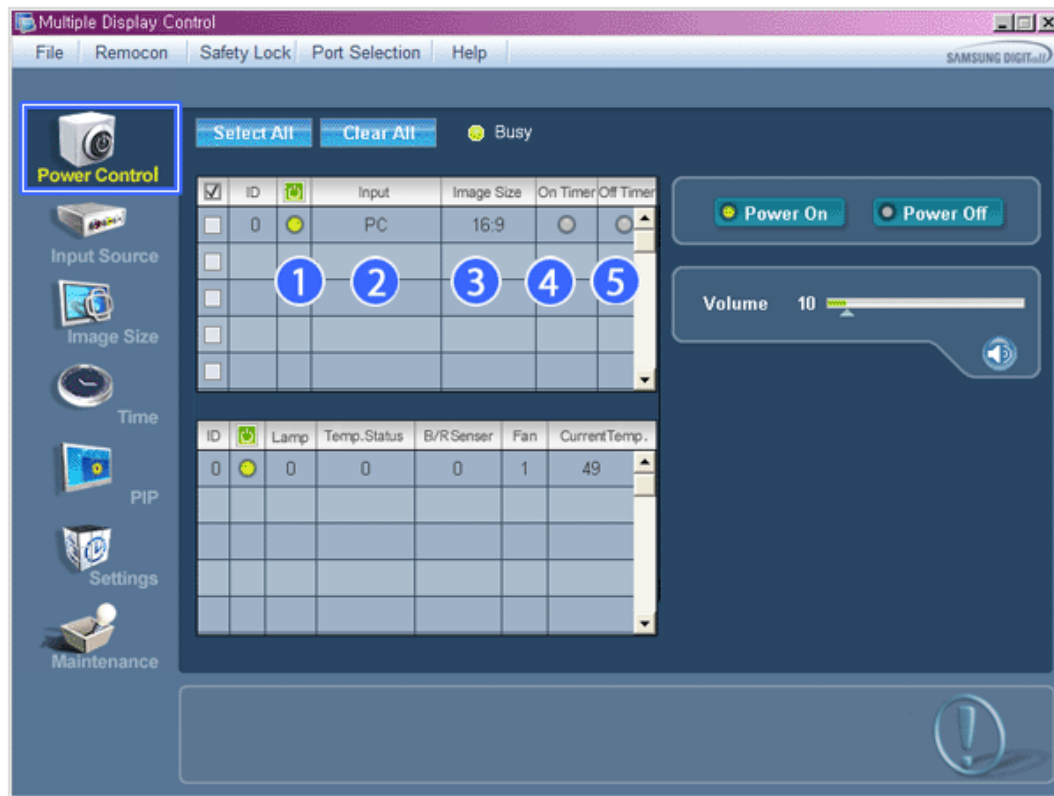

* Info Grid shows some basic information necessary to Power Control.

- 1)  (Power Status)
- 2) Input
- 3) Image Size
- 4) On Timer
- 5) Off Timer

2. Use the Select All button or Check Box to choose a display to control.

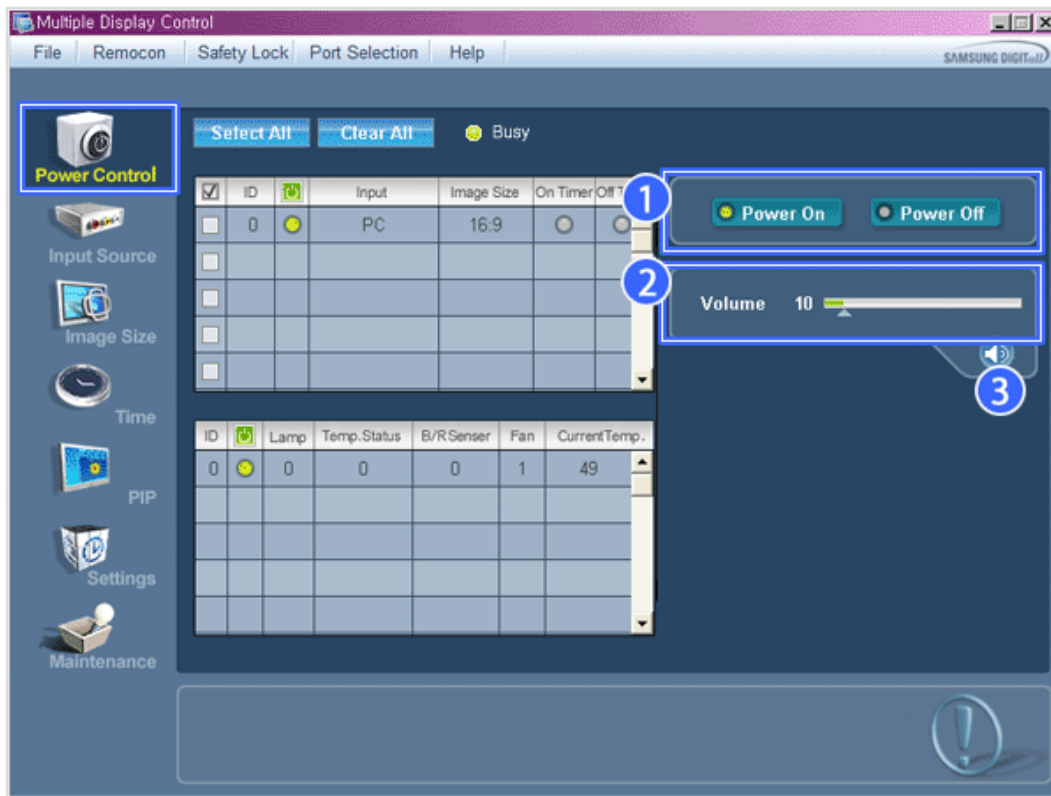

* Power Control allows controlling some of the functions of the selected display.

1) Power On/Off

- Turns the power of the selected display On/Off.

2) Volume

- Controls the volume level of the selected display.

It receives the volume value of the selected display from the sets and displays it in the slider.
(When you cancel the selection or choose Select All, the value returns to the default value 10)

3) (Mute On/Off)

- Turns on/off the Mute function of the selected display.

When selecting one set at a time, turn on the Mute function for the selected set.

The Mute function is disabled automatically when you adjust the volume level.

(The values return to the default settings when you undo the selections or choose "Select All".)

* **The Power Control feature is available for all displays.**

* **The Volume Control and Mute features are available only for the displays whose power status is ON.**



Input Source

1. Click Input Source of the main icons and the Input Source control screen appears.
Click Select All or use Check Box to select a display to control.

• TV Mode

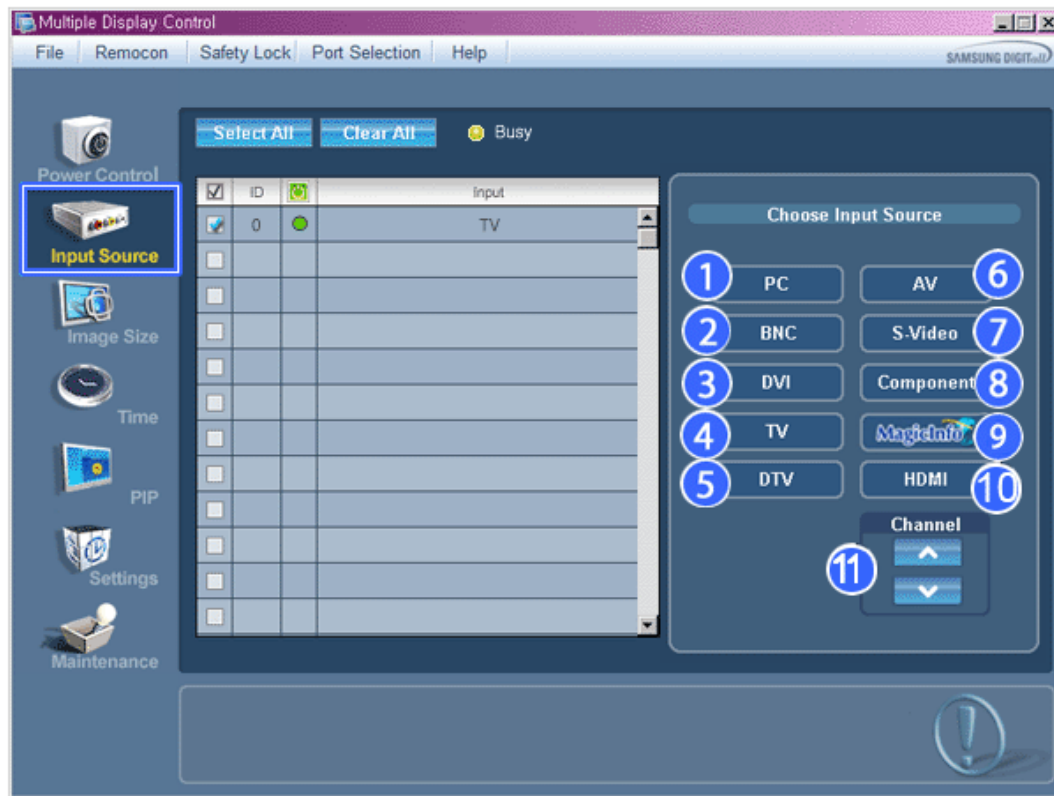

• PC Mode

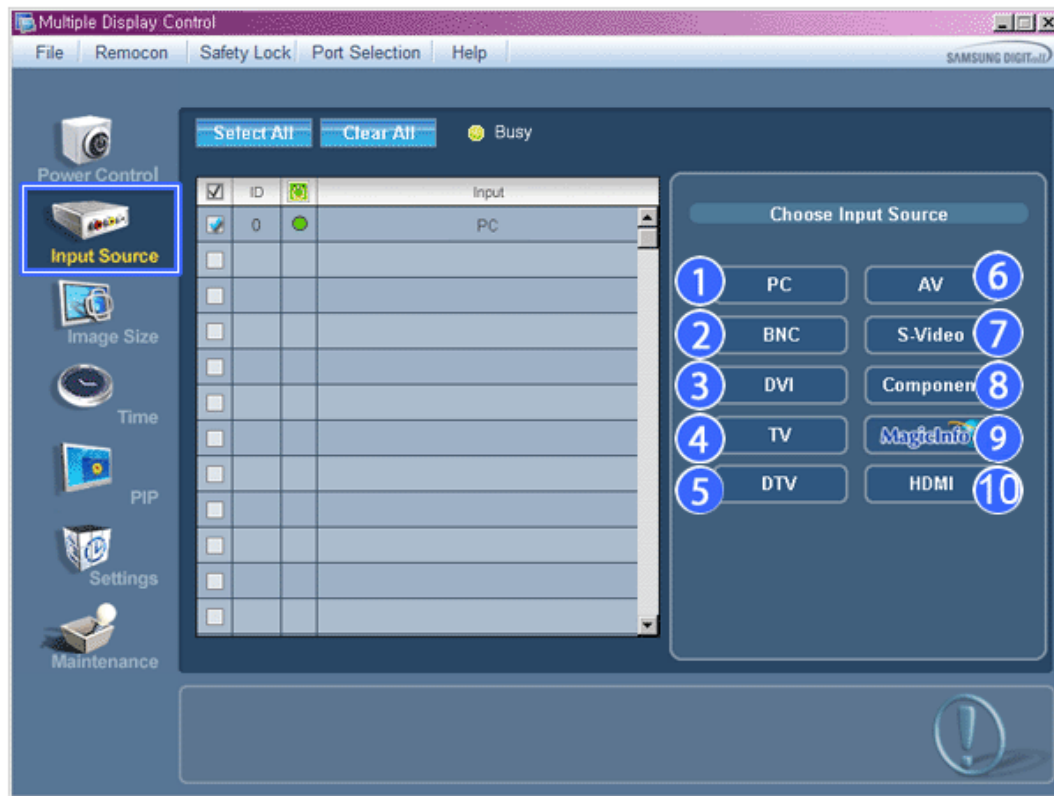

* Info Grid shows some basic information necessary to Input Source Control.

- 1) PC
- Changes the Input Source of the selected display to PC.
- 2) BNC
- Changes the Input Source of the selected display to BNC.
- 3) DVI
- Changes the Input Source of the selected display to DVI.
- 4) TV
- Changes the Input Source of the selected display to TV.
- 5) DTV
- Changes the Input Source of the selected display to DTV.
- 6) AV
- Changes the Input Source of the selected display to AV.
- 7) S-Video
- Changes the Input Source of the selected display to S-Video.
- 8) Component
- Changes the Input Source of the selected display to Component.
- 9) MagicInfo
- The Input source of MagicInfo works only on MagicInfo model.
- 10) HDMI
- Changes the Input Source of the selected display to HDMI.
- 11) Channel
- Channel arrow appears when the Input Source is TV.

* **TV Source can be selected only in products with TV and controlling channels is allowed only when Input Source is TV.**

* The Input Source Control feature is available only for the displays whose power status is ON.

Image Size

PC, BNC, DVI

1. Click Image Size of the main icons and the Image Size control screen appears.

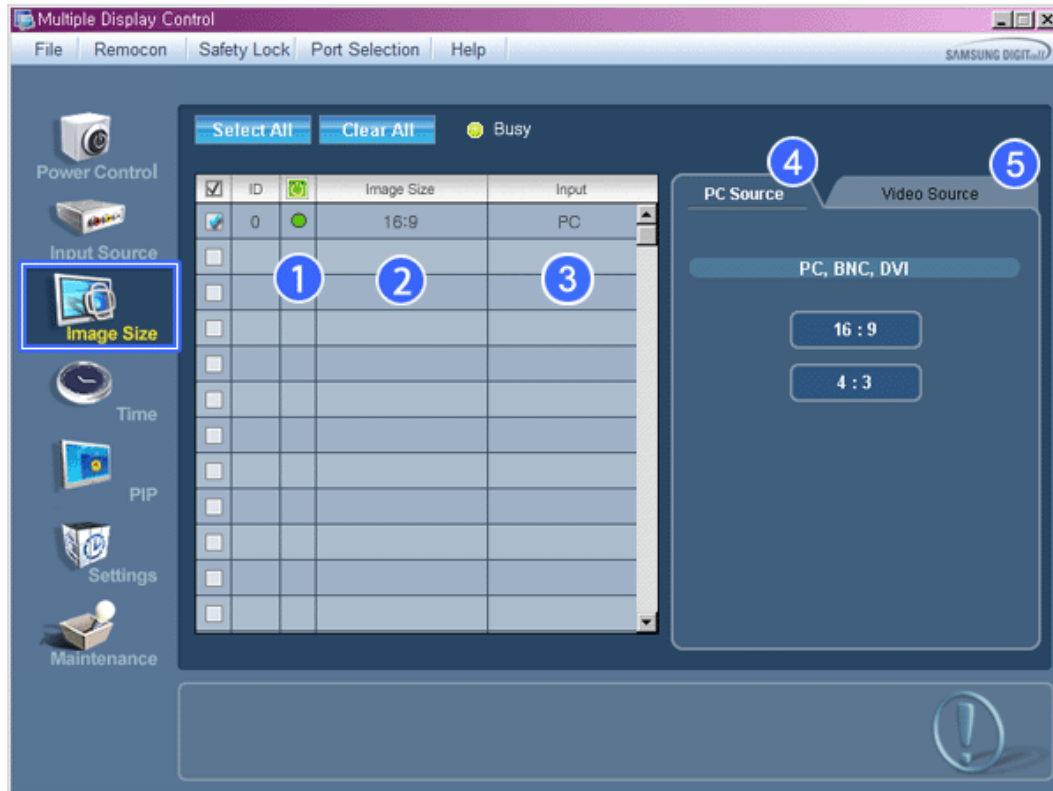

* Info Grid shows some basic information necessary to Image Size Control.

- 1)  (Power Status)
 - Shows the power status of the current display.
- 2) Image Size
 - Shows the current Image Size of the display in use.
- 3) Input
 - Info Grid displays only the displays whose Input Source is PC, BNC, DVI.
- 4) PC Source
 - When you click Image Size, the PC Source tab first appear.
 - The Image Size Control button controls Image Size available for PC, BNC, DVI.
- 5) Video Source
 - Click the Video Source tab to control Image Size for respective Input Source.

* The Input source of MagicInfo works only on MagicInfo model.

* The Input source of TV works only on TV model.

* Image Size Control is available only for the displays for which power status is ON.

Image Size

TV, AV, S-Video, Component, DVI(HDCP), HDMI, DTV

1. Click Image Size of the main icons and the Image Size control screen appears.

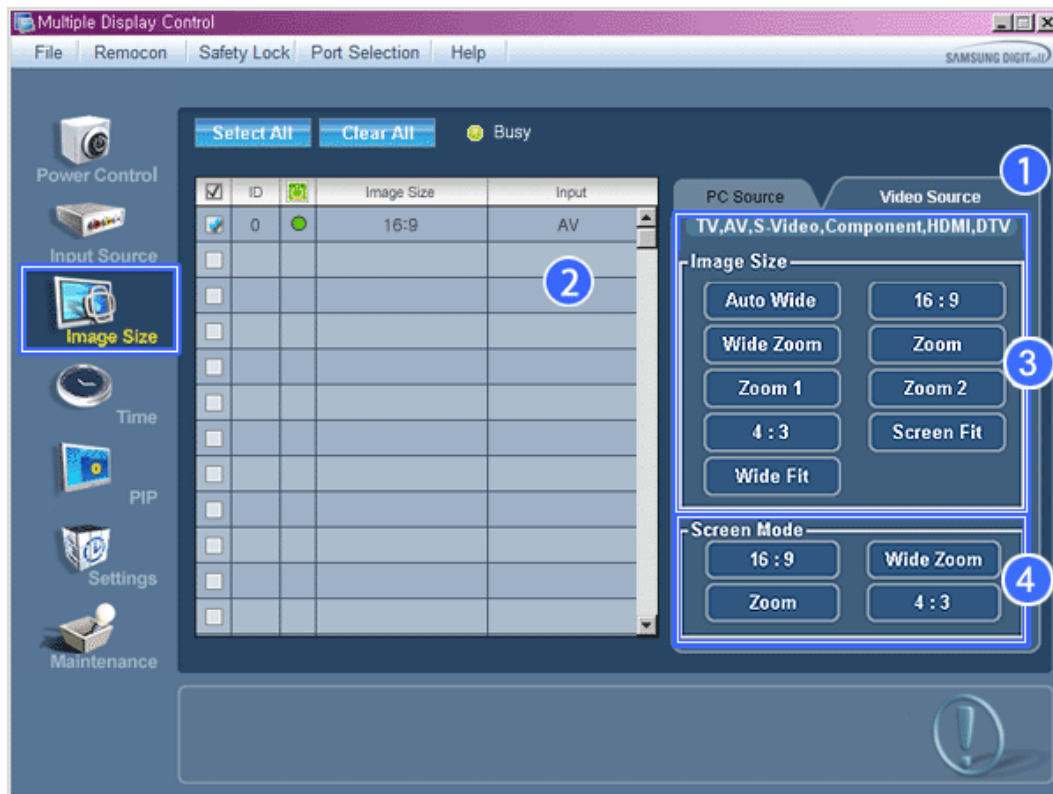

* Info Grid shows some basic information necessary to Image Size Control.

- 1) Click the Video Source tab to adjust Image Size for TV, AV, S-Video, Component, DVI(HDCP), HDMI, DTV. Click Select All or use Check Box to select a display to control.
- 2) Info Grid displays only the display having TV, AV, S-Video, Component or DVI(HDCP) as input source.
- 3) Switch Image Size of the selected display randomly.

Note: Auto Wide, Zoom1 and Zoom2 are not available for selection when the input signal type for Component and DVI (HDCP) is 720p or 1080i. (The Auto Wide mode is available only for TV, AV, and S-Video.)

- 4) The screen modes can only be adjusted when a TV (PAL only) is connected and the Image Size item is set to Auto Wide.

* The Input source of MagicInfo works only on MagicInfo model.

* The Input source of TV works only on TV model.

* The Image Size Control feature is available only for the displays whose power status is ON.

Time

1. Click Time of the main icons and the Time Control screen appears.

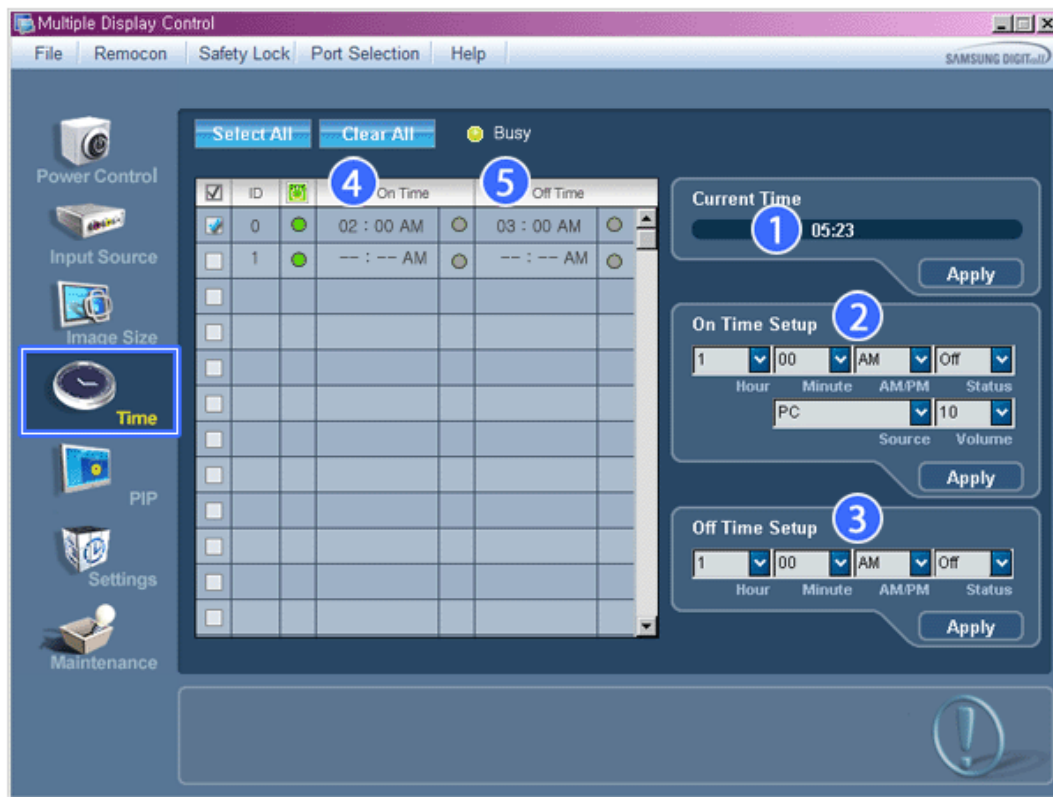

* Info Grid shows some basic information necessary to Time Control.

- 1) Current Time
 - Set the current time for the selected display (PC Time).
 - To change the current time, first change the PC Time.
- 2) On Time Setup
 - Set the Hour, Minute, AM/PM of On Time Setup, Status, Source, Volume of the selected display.
- 3) Off Time Setup
 - Set the Hour, Minute, and AM/PM, Status for Off Time Setup of the selected display.
- 4) Shows the On Time settings.
- 5) Shows the Off Time settings.

* **The Input source of MagicInfo works only on MagicInfo model.**

* **The Input source of TV works only on TV model.**

* **Time Control is available only for the displays for which the power status is ON.**

* **At On Time Setup, TV Source functions only for TV Model.**

* **At On Time Setup, MagicInfo Source functions only for MagicInfo Model.**



PIP

PIP Size

1. Click PIP of the main icons and the PIP control screen appears.
Click Select All or use Check Box to select a display to control.

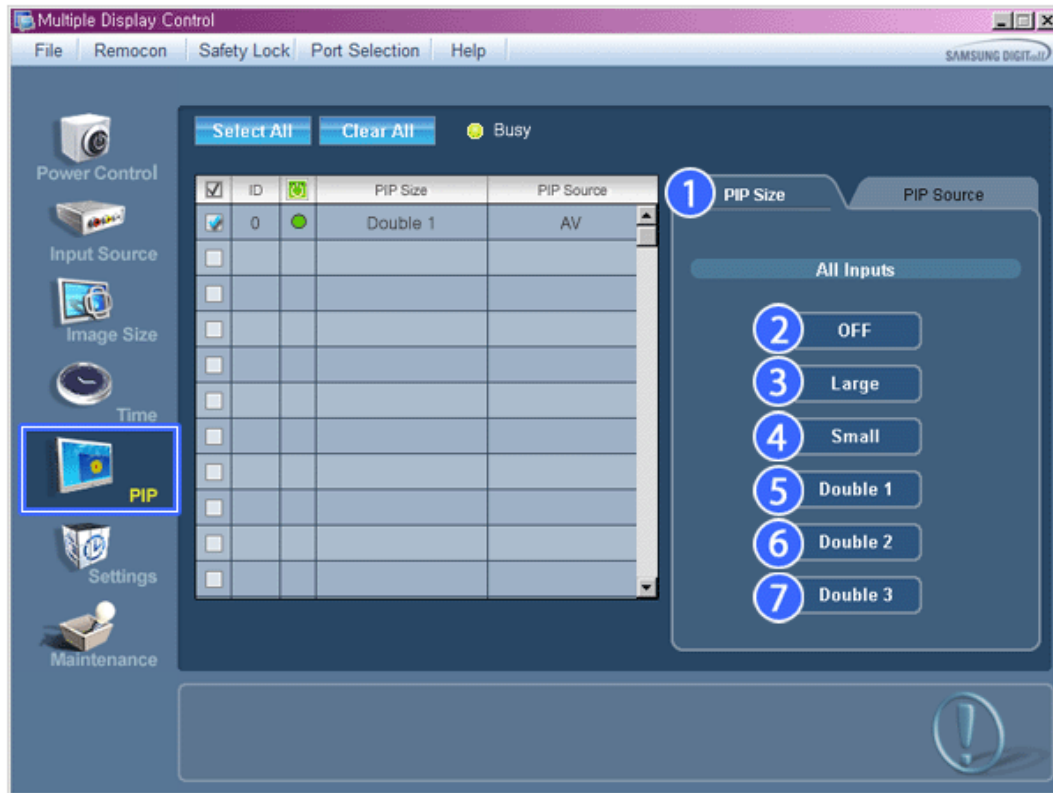

* Info Grid shows some basic information necessary to PIP Size Control.

- 1) PIP Size
- Shows the current PIP Size of the display in use.
- 2) OFF
- Turns off the PIP of the selected display.
- 3) Large
- Turns on the PIP of the selected display and changes the size to Large.
- 4) Small
- Turns on the PIP of the selected display and changes the size to Small.
- 5) Double 1
- Turns on the PIP of the selected display and changes the size to Double 1.
- 6) Double 2
- Turns on the PIP of the selected display and changes the size to Double 2.
- 7) Double 3 (Picture By Picture)
- Turns on the PBP of the selected display and changes the size to Double 3.

* **The Input source of MagicInfo works only on MagicInfo model.**

* **The Input source of TV works only on TV model.**

* **PIP Size can be controlled with turning on the LCD Display power.**



PIP

PIP Source

1. Click PIP of the main icons and the PIP control screen appears.

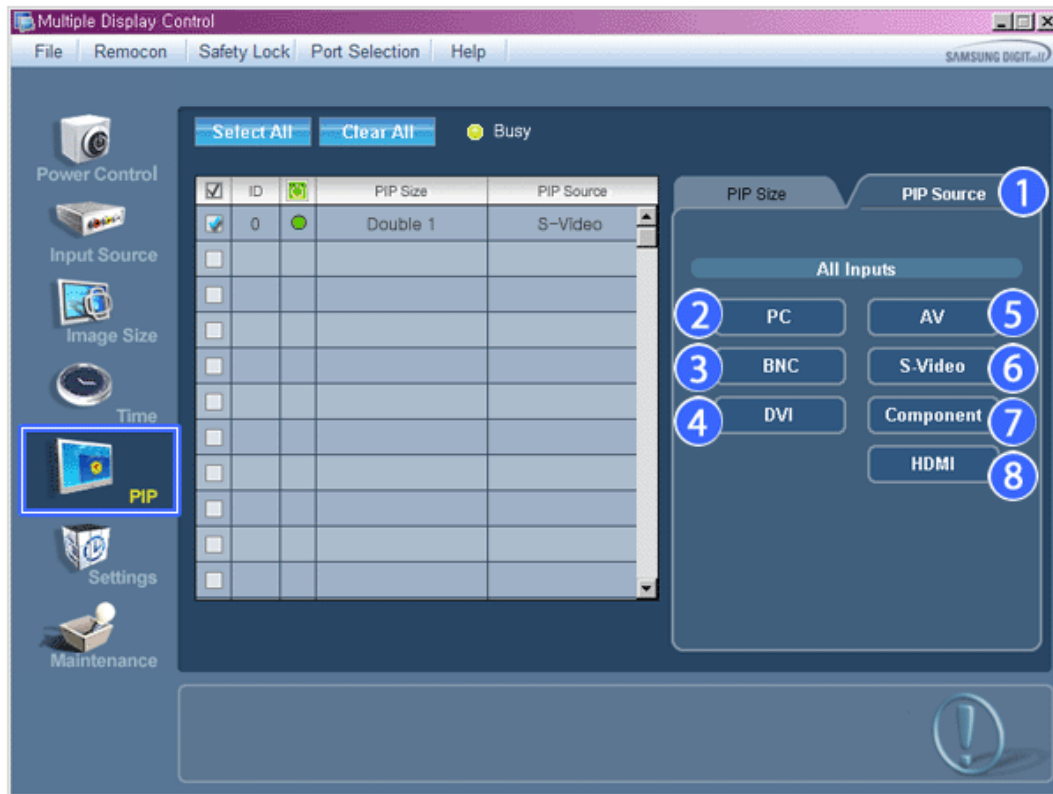

* Info Grid shows some basic information necessary to PIP Source Control.

- 1) PIP Source
 - PIP Source can be controlled with turning on the LCD Display power.
- 2) PC
 - Changes the source of the PIP of the selected display to PC.
- 3) BNC
 - Changes the source of the PIP of the selected display to BNC.
- 4) DVI
 - Changes the source of the PIP of the selected display to DVI.
- 5) AV
 - Changes the source of the PIP of the selected display to AV.
- 6) S-Video
 - Changes the source of the PIP of the selected display to S-Video.
- 7) Component
 - Changes the source of the PIP of the selected display to Component.
- 8) HDMI
 - Changes the source of the PIP of the selected display to HDMI.

Note: Some of the PIP Sources may not be available for selection, depending on the input source type of the Main Screen.

* The Input source of MagicInfo works only on MagicInfo model.

* The PIP Control feature is available only for the displays whose power status is ON and the PIP function is set to ON.



Settings

Picture

1. Click Settings of the main icons and the Settings Control screen appears.

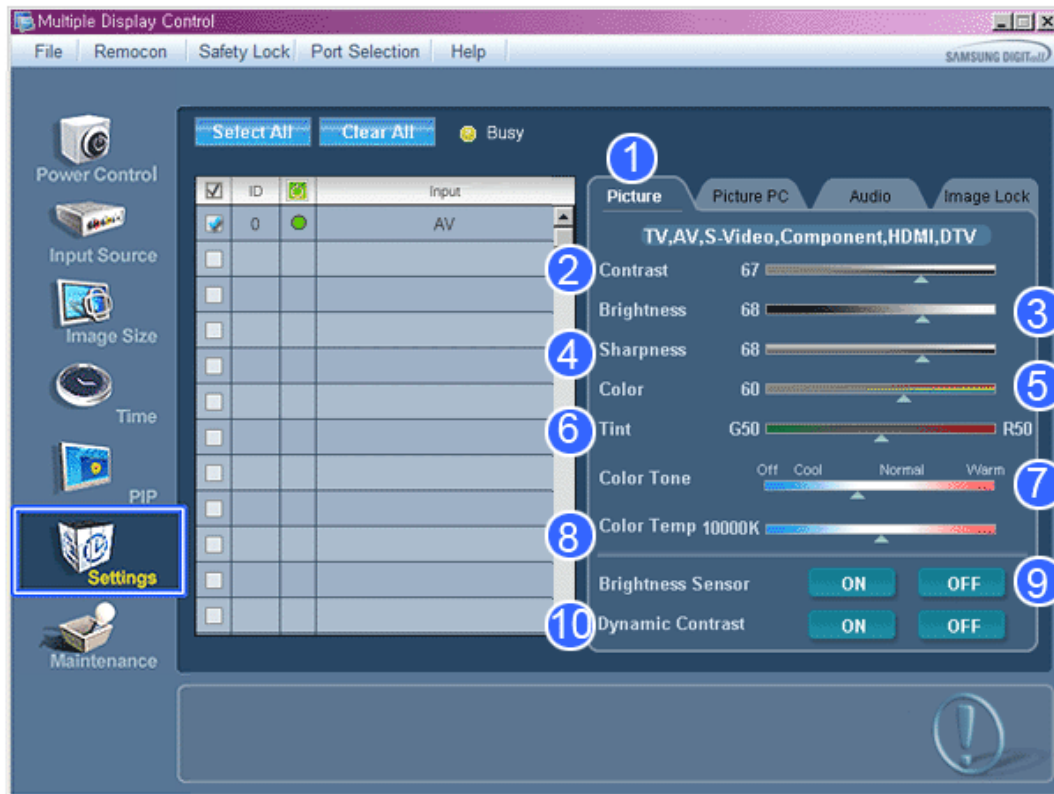

- * Info Grid shows some basic information necessary to Settings Control. When each function is selected, the set value of the selected function is displayed in the slide. When selected, each function fetches the value for the set and displays it on the slide bar. When "Select All" is chosen, the default value is displayed. Changing a value in this screen will automatically change the mode to "CUSTOM."

- 1) Picture
 - Available only for TV, AV, S-Video, Component, HDMI, DTV.
- 2) Contrast
 - Adjusts Contrast of the selected display.
- 3) Brightness
 - Adjusts Brightness of the selected display.
- 4) Sharpness
 - Adjusts Sharpness of the selected display.
- 5) Color
 - Adjusts Color of the selected display.
- 6) Tint
 - Adjusts Tint of the selected display.
 - Available only for NT.
- 7) Color Tone

- Adjusts the Color Tone for the selected display.
- 8) Color Temp
 - Adjusts the Color Temp for the selected display.
- 9) Brightness Sensor
 - Adjusts the Brightness Sensor for the selected display.
- 10) Dynamic Contrast
 - Adjusts the Dynamic Contrast for the selected display.

- * The Input source of MagicInfo works only on MagicInfo model.
- * Color Temp is only enabled if the Color Tone is set to Off.
- * The Input source of TV works only on TV model.
- * This feature is available only for the displays whose power status is ON and if no selection is made, the factory default is displayed.

Settings

Picture PC

1. Click Settings of the main icons and the Settings Control screen appears.



- * Info Grid shows some basic information necessary to Settings Control. When each function is selected, the set value of the selected function is displayed in the slide. When selected, each function fetches the value for the set and displays it on the slide bar. When "Select All" is chosen, the default value is displayed. Changing a value in this screen will automatically change the mode to "CUSTOM."

- 1) Picture PC
 - Available only for PC, BNC, DVI.

- 2) Contrast
 - Adjusts Contrast of the selected display.
- 3) Brightness
 - Adjusts Brightness for the selected display.
- 4) Red
 - Adjusts red Color of the selected display.
 - Available only for NT.
- 5) Green
 - Adjusts green Color of the selected display.
 - Available only for NT.
- 6) Blue
 - Adjusts blue Color of the selected display.
 - Available only for NT.
- 7) Color Tone
 - Adjusts the Color Tone for the selected display.
- 8) Color Temp
 - Adjusts the Color Temp for the selected display.
- 9) Brightness Sensor
 - Adjusts the Brightness Sensor for the selected display.
- 10) Dynamic Contrast
 - Adjusts the Dynamic Contrast for the selected display.

*** The Input source of MagicInfo works only on MagicInfo model.**

*** The Input source of TV works only on TV model.**

*** Color Temp is only enabled if the Color Tone is set to Off.**

*** This feature is available only for the displays whose power status is ON and if no selection is made, the factory default is displayed.**



Settings

Audio

1. Click Settings of the main icons and the Settings Control screen appears.

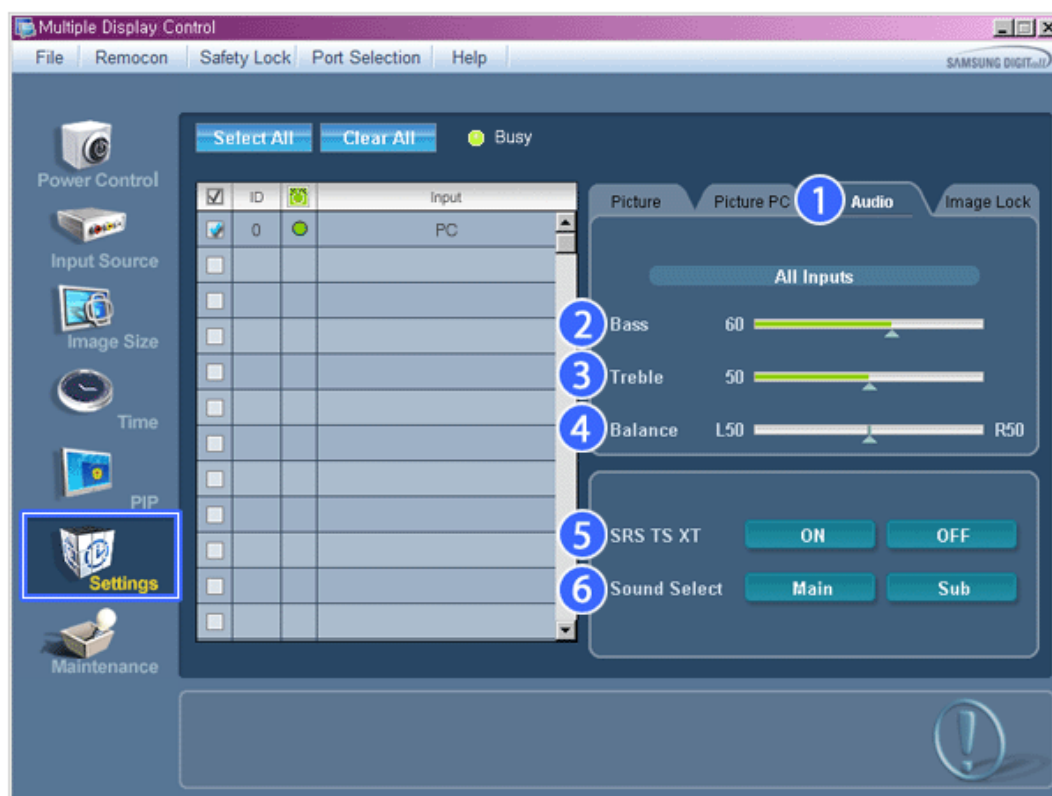

* Info Grid shows some basic information necessary to Settings Control. When each function is selected, the set value of the selected function is displayed in the slide. When selected, each function fetches the value for the set and displays it on the slide bar. When "Select All" is chosen, the default value is displayed. Changing a value in this screen will automatically change the mode to "CUSTOM."

- 1) Audio
 - Controls audio settings for all input sources.
- 2) Bass
 - Adjusts Bass of the selected display.
- 3) Treble
 - Adjusts Treble of the selected display.
- 4) Balance
 - Adjusts Balance of the selected display.
- 5) SRS TS XT
 - SRS TS XT Sound ON/OFF of the selected display.
- 6) Sound Select
 - Select either Main or Sub when PIP is On.

* **The Input source of MagicInfo works only on MagicInfo model.**

* **The Input source of TV works only on TV model.**

* **This feature is available only for the displays whose power status is ON and if no selection is made, the factory default is displayed.**



Settings

Image Lock

1. Click Settings of the main icons and the Settings Control screen appears.

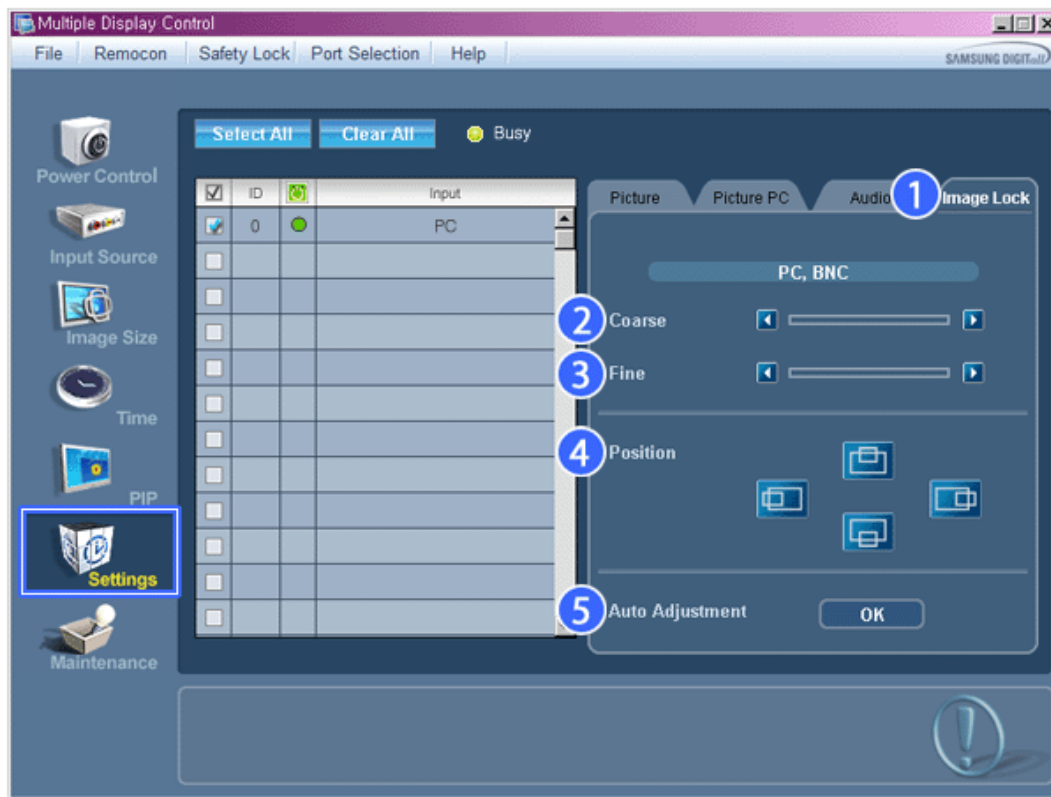

* Info Grid shows some basic information necessary to Settings Control.

- 1) Image Lock
 - Available only for PC, BNC.
- 2) Coarse
 - Adjusts Coarse of the selected display.
- 3) Fine
 - Adjusts Fine of the selected display.
- 4) Position
 - Adjusts Position of the selected display.
- 5) Auto Adjustment
 - Self-Adjust to the incoming PC signal.

* The Input source of MagicInfo works only on MagicInfo model.

* The Input source of TV works only on TV model.

* Settings Control is available only for the displays for which the power status is ON.



Maintenance

Lamp Control

1. Click on the "Maintenance" icon in the Main Icon column to display the Maintenance screen.

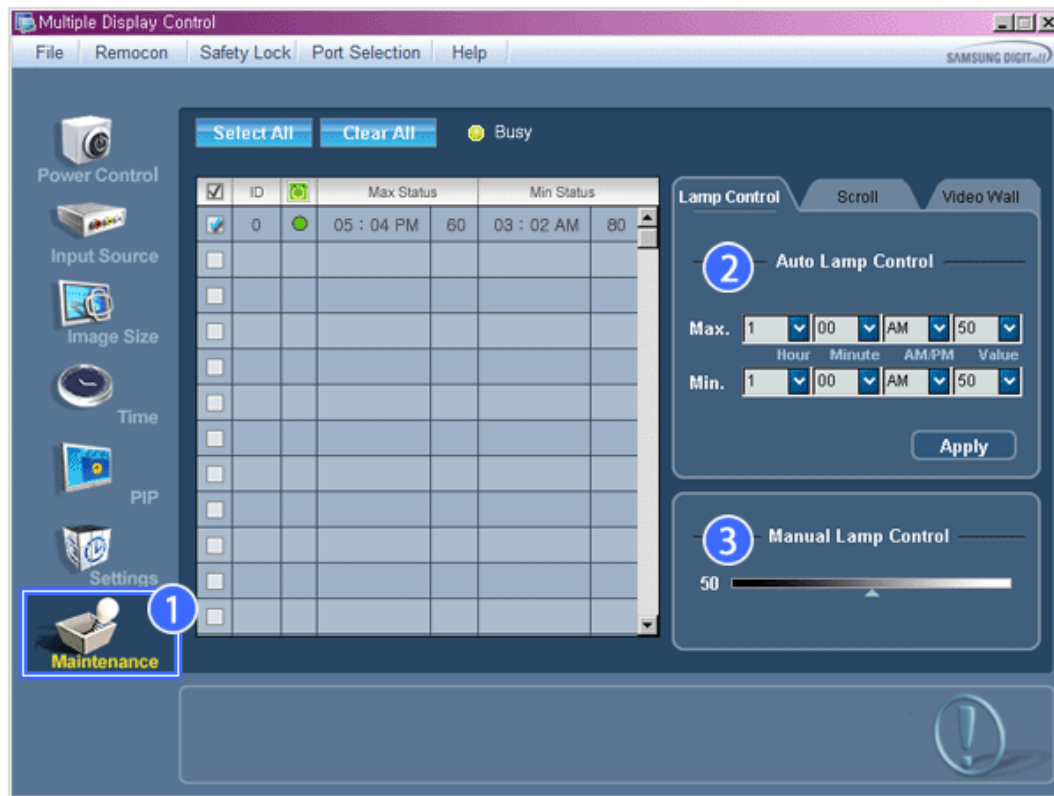

✦ An "Info Grid" showing several basic data items appears.

- 1) Maintenance
 - Allows the Maintenance Control function for all input sources.
- 2) Auto Lamp Control
 - Automatically adjusts the backlight of the selected display at a specified time.
 - The Manual Lamp Control automatically turns off if you adjust using the Auto Lamp Control.
- 3) Manual Lamp Control
 - Allows you to adjust the backlight of the selected display regardless of the time.
 - The Auto Lamp Control automatically turns off if you adjust using the Manual Lamp Control.

✦ **The Maintenance Control feature is available only for the displays whose power status is ON.**

✦ **The Input source of MagicInfo works only on MagicInfo model.**

✦ **The Input source of TV works only on TV model.**



Maintenance

Scroll

1. Click on the "Maintenance" icon in the Main Icon column to display the Maintenance screen.



- 1) Scroll
 - This function is used to remove the afterimages that occur when a still screen is displayed on the selected display for a long time.
 - 2) Pixel Shift
 - This allows the screen to be moved finely at the specified time interval.
 - 3) Safety Screen
 - The Safety Screen function is used to prevent afterimages from occurring when a still screen is displayed on the monitor for a long time. The Interval item is used to set the repetition cycle in hour units and the Time item is used to set the time when the Safety Screen function must be performed. The Type item can be set to Scroll, Pixel, Bar, Eraser, All White, or Pattern.
 - 4) Safety Screen2
 - This function is used to prevent afterimages from occurring. There are five (5) types that you can select and control with this function.
- * For the Scroll type, the Time item can be set to 1, 2, 3, 4 or 5. For the Bar and Eraser types, it can be set to 10, 20, 30, 40 or 50. For the All White and Pattern type, it can be set to 1, 5, 10, 20 or 30.
 - * The Input source of MagicInfo works only on MagicInfo model.
 - * The Input source of TV works only on TV model.
 - * The Maintenance Control feature is available only for the displays whose power status is ON.



Maintenance

Video Wall

1. Click on the "Maintenance" icon in the Main Icon column to display the Maintenance screen.

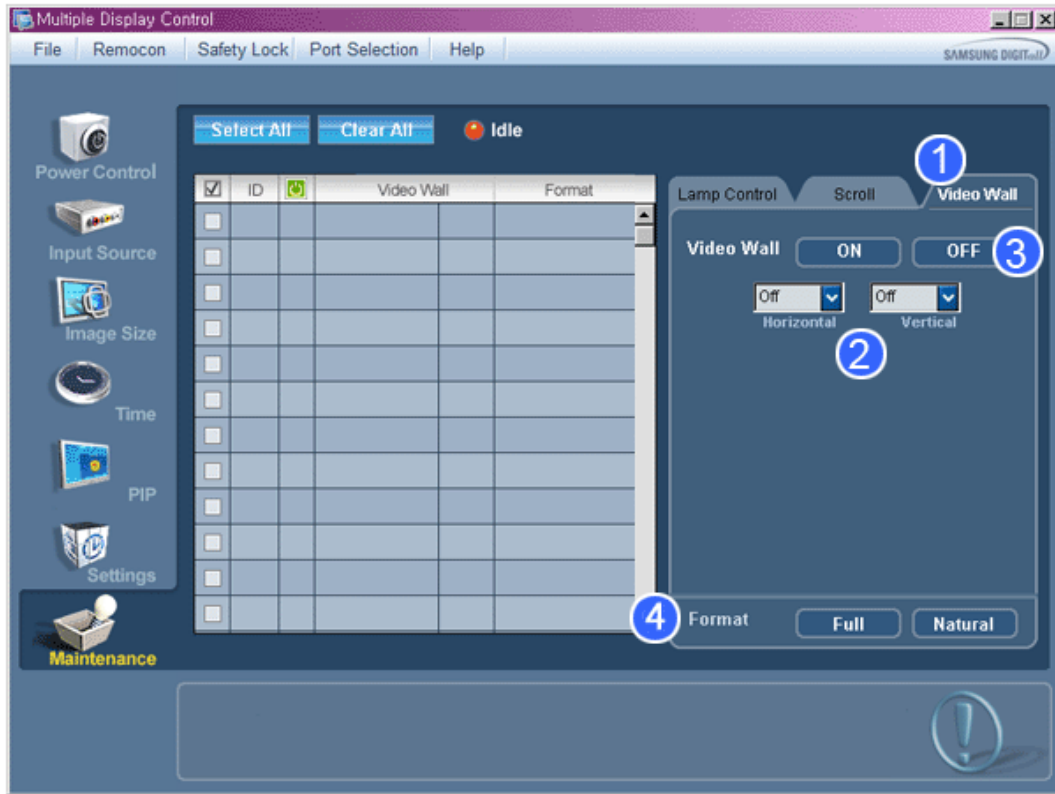

1) Video Wall

- A Video Wall is a set of video screens that are connected together, so that each screen shows a part of the whole picture or so that the same picture is repeated on each screen.

2) Video Wall (Screen divider)

- The screen can be divided into. You can select a number of screens with a different layout when dividing.
 - Select a mode from Screen divider.
 - Select a display from Display Selection.
 - The place will be set up by pressing a number in the selected mode.
 - The MDC program supplied by Samsung supports up to 5x5 LCD Displays.

3) On / Off

- Turns on/off the Video Wall function of the selected display.

4) Format

- The format can be selected to see a divided screen.

- Full

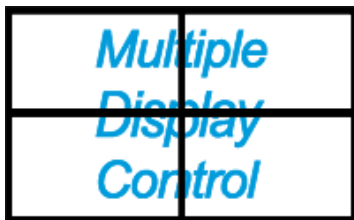

- Natural

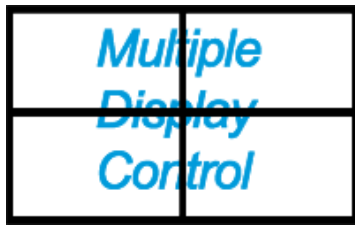

- * You may not operate this function in MagicInfo.
- * The Input source of TV works only on TV model.
- * The Maintenance Control function is available only for the displays where the power status is ON.

Troubleshooting

1. The display you wish to control does not appear on the Power Control Info Grid
 - Check the connection of RS232C. (Check if it is properly connected to the Com1 port)
 - Check the displays to see if any of the other displays connected have the same ID. If more than one displays have the same ID, those displays are not properly detected by the program due to data conflict.
 - Check if the Display Set ID is a number between 0 and **25**. (Adjust using the Display menu)

Note : A Display Set ID must be a value between 0 and **25** .

2. The display you wish to control does not appear on the other Control Info Grids
 - Check to see if the display power is ON. (You can check this in Power Control Info Grid)
 - Check if you can change the input source of the display.
3. The dialogue box appears repeatedly.
 - Check to see if the display you wish to control is selected.
4. Both On Timer and Off Timer have been set but different time is showing.
 - Apply current time to synchronize the display clocks.
5. The remote may not function properly when you turn off the remote Function, disconnect the RS-232C cable, or exit the program in an Irregular manner. Rerun the program and turn the remote function again to Restore normal functions.

<Note> This program may malfunction due to problems in communication circuits or interference from electronic appliances nearby.



Settings Value Display In Multiple Display Mode

* When there are more than one displays connected, the settings values are displayed as follows.

1. No selection: Displays the Factory Default Value.

2. Selected one display: Fetches and displays the settings value for the selected display.
3. Selected one display (ID1) and add another display (ID3): The program, which was displaying the settings value of ID 1, fetches and displays the value of ID3.
4. Selected all sets using Select All: Returns to the Factory Default Value.

Copyright© 2003-2009 Samsung Electronics Co. Ltd. All rights reserved.

Adjusting the LCD Display

Input

Available Modes

- **P** PC / DVI / BNC
- **A** AV
- **C** Component
- **H** HDMI
- **M** MagicInfo

Note

- The **BNC** mode will not be activated on the DXN-2 model.
- **MagicInfo** supports the DXN-2 model only.

Source List **PACHM**

MENU → ENTER → **[Input]** → ENTER → **[Source List]**



→ ▲, ▼ → ENTER

Use to select **PC**, **DVI** or other external input sources connected to the LCD Display. Use to select the screen of your choice.

1. **PC**
2. **DVI**
3. **AV**
4. **Component**
5. **HDMI**
6. **MagicInfo**

PIP **PACH**



Note

Available Modes: **PIP ON**

When external AV devices such as VCRs or DVDs are connected to the LCD Display , **PIP** allows you to watch video from those devices in a small window super-imposed on the PC Video signal. (**Off/On**)

MENU → ENTER → [Input] → ▼ → ENTER → []

 **Note**

- More than one **PIP** cannot be overlapped on screen as **BNC** and the **Component** use the same terminal.
- If you select  ,  ,  in **Size**, **Position** and **Transparency** will not be activated.

PIP

MENU → ENTER → [Input] → ▼ → ENTER → [] → ENTER → []



→ ▲, ▼ → ENTER

Turns the **PIP** Screen **Off/On**.

- **Off**
- **On**

Source

MENU → ENTER → [Input] → ▼ → ENTER → [] → ▼ → ENTER → []

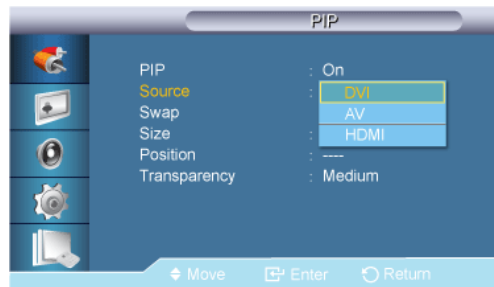

→ ▲, ▼ → ENTER

Selects the input source for the PIP.

- **PC : DVI / AV / HDMI**
- **BNC : DVI / AV / HDMI**
- **DVI / AV : PC / BNC**
- **Component : PC**
- **HDMI : PC / BNC**

Swap

MENU → ENTER → [Input] → ▼ → ENTER → [] → ▼ → ▼ → ENTER → []

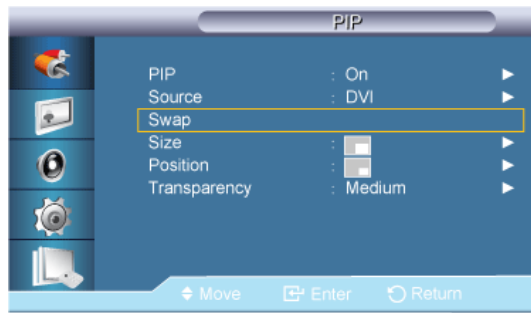

Swaps the contents of the PIP and main image.

The image in the PIP window will appear on the main screen, and the main screen image will appear in the PIP window.

Size

MENU → ENTER → [Input] → ▼ → ENTER → [] → ▼ → ▼ → ▼ → ENTER → []



→ ▲, ▼ → ENTER

Changes the Size of the PIP window.

Position

MENU → ENTER → [Input] → ▼ → ENTER → [] → ▼ → ▼ → ▼ → ▼ → ENTER → []

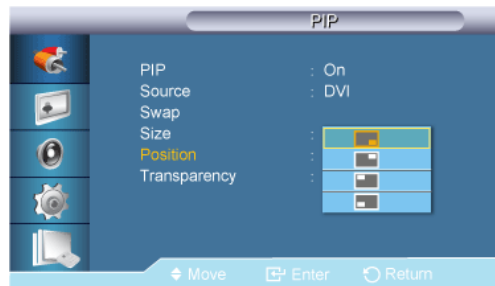

→ ▲, ▼ → ENTER

Changes the Position of the PIP window.

Transparency

MENU → ENTER → [Input] → ▼ → ENTER → [] → ▼ → ▼ → ▼ → ▼ → ▼ → ENTER → []

Adjusting the LCD Display

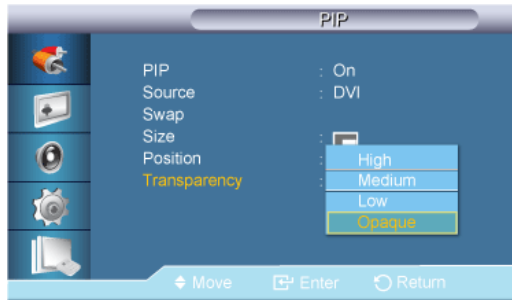

→ ▲, ▼ → ENTER

Adjusts the Transparency of PIP windows.

- High
- Medium
- Low
- Opaque

Note

- PIP turns off when the LCD Display is switched to an external source.
- For PC and DVI, this is deactivated if the cable is disconnected.

Edit Name **PACHM**

MENU → ENTER → [Input] → ENTER → ▼ → ▼ → [Edit Name]

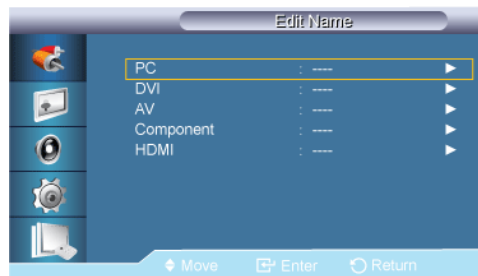

→ ▲, ▼ → ENTER

Name the input device connected to the input jacks to make your input source selection easier.

VCR / DVD / Cable STB / HD STB / Satellite STB / AV Receiver / DVD Receiver / Game / Camcorder / DVD Combo / DHR / PC / BNC / HDMI / Component / AV / DVI

Note

- The displayed devices differ depending on the external input mode.
- When connecting a PC to the HDMI or DVI terminal, set **Edit Name** to **PC**. In other cases, set **Edit Name** to **AV**. However, since 640x480, 720P (1280x720), and 1080p (1920x1080) are common signals for **AV** and **PC**, make sure to set the **Edit Name** in accordance with the input signal.
- The **Picture** menu changes depending on the input signal and **Edit Name**.

Picture [PC / DVI / BNC / MagicInfo Mode]

Available Modes

- **P** PC / DVI / BNC
- **A** AV
- **C** Component
- **H** HDMI
- **M** MagicInfo

Note

- The **BNC** mode will not be activated on the DXN-2 model.
- **MagicInfo** supports the DXN-2 model only.

MagicBright **PM**

MENU → ▼ → ENTER → [Picture] → ENTER → [MagicBright]



→ ▲, ▼ → ENTER

MagicBright is a feature providing the optimum viewing environment depending on the contents of the image you are watching. Currently four different modes are available: **Entertain**, **Internet**, **Text** and **Custom**. Each mode has its own pre-configured brightness value.

(Not available when **Dynamic Contrast** is set to **On**.)

1. **Entertain**

High brightness

For watching motion pictures such as from a DVD or VCR.

2. **Internet**

Medium brightness

For working with a mixture of images such as texts and graphics.

3. **Text**

Normal brightness

For documents or works involving heavy text.

4. **Custom**

Although the values are carefully chosen by our engineers, the pre-configured values may not be comfortable to your eyes depending on your taste.

If this is the case, adjust the brightness and contrast by using the OSD menu.

Custom **PM**

By using the on-screen menus, the contrast and brightness can be changed to your personal preference.

MENU → ▼ → ENTER → **[Picture]** → ▼ → ENTER → **[Custom]**

(Not available when **Dynamic Contrast** is set to On.)



By adjusting the picture using the **Custom** function, **MagicBright** will change to **Custom** mode.

Contrast

MENU → ▼ → ENTER → **[Picture]** → ▼ → ENTER → **[Custom]** → ENTER → **[Contrast]**



→ ◀, ▶ → ENTER

Adjusts the Contrast.

Brightness

MENU → ▼ → ENTER → **[Picture]** → ▼ → ENTER → **[Custom]** → ▼ → ENTER → **[Brightness]**



→ ◀, ▶ → ENTER

Adjusts the Brightness.

Sharpness

MENU → ▼ → ENTER → **[Picture]** → ▼ → ENTER → **[Custom]** → ▼ → ▼ → ENTER → **[Sharpness]**



→ ◀, ▶ → ENTER

Adjusts the Sharpness.

Color Tone **PM**

MENU → ▼ → ENTER → **[Picture]** → ▼ → ▼ → ENTER → **[Color Tone]**

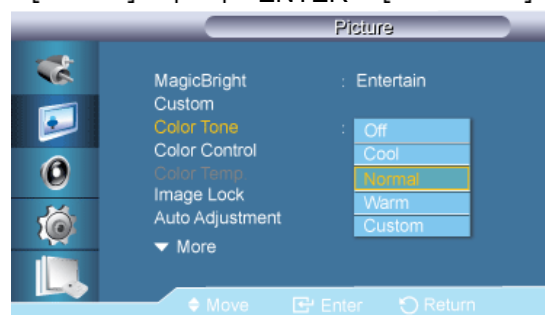

→ ▲, ▼ → ENTER

The color tones can be changed.

(Not available when **Dynamic Contrast** is set to **On**.)

1. **Off**
2. **Cool**
3. **Normal**
4. **Warm**
5. **Custom**

 **Note**

If you set the **Color Tone** to **Cool**, **Normal**, **Warm**, or **Custom**, the **Color Temp.** function is disabled.

If you set the **Color Tone** to **Off**, the **Color Control** function is disabled

Color Control **PM**

Adjusts individual Red, Green, Blue color balance.

MENU → ▼ → ENTER → **[Picture]** → ▼ → ▼ → ▼ → ENTER → **[Color Control]**

(Not available when **Dynamic Contrast** is set to **On**.)

 **Note**

If you adjust the picture by using the **Color Control** function, **Color Tone** will turn to the **Custom** mode.

Red

MENU → ▼ → ENTER → **[Picture]** → ▼ → ▼ → ▼ → ENTER → **[Color Control]** → ENTER → **[Red]**



→ ◀, ▶ → ENTER

Green

MENU → ▼ → ENTER → **[Picture]** → ▼ → ▼ → ▼ → ENTER → **[Color Control]** → ▼ → ENTER → **[Green]**



→ ◀, ▶ → ENTER

Blue

MENU → ▼ → ENTER → **[Picture]** → ▼ → ▼ → ▼ → ENTER → **[Color Control]** → ▼ → ▼ → ENTER → **[Blue]**



→ ◀ ▶ → ENTER

Color Temp. **PM**

MENU → ▼ → ENTER → [Picture] → ▼ → ▼ → ▼ → ▼ → ENTER → [Color Temp.]



→ ◀ ▶ → ENTER

Color Temp. is a measure of the 'warmth' of the image colors.

(Not available when **Dynamic Contrast** is set to **On**.)



This function is only enabled if the **Color Tone** is set to **Off**.

Image Lock **P**

Image Lock is used to fine-tune and get the best image by removing noise that creates unstable images with jitters and shakiness. If satisfactory results are not obtained using the Fine adjustment, use the Coarse adjustment and then use Fine again.

(Available in **PC** mode only)

MENU → ▼ → ENTER → [Picture] → ▼ → ▼ → ▼ → ▼ → ENTER → [Image Lock]

Coarse

MENU → ▼ → ENTER → [Picture] → ▼ → ▼ → ▼ → ▼ → ENTER → [Image Lock] → ENTER → [Coarse]



→ ◀ ▶ → ENTER

Removes noise such as vertical stripes. Coarse adjustment may move the screen image area. You may relocate it to the center using the horizontal control menu.

Fine

MENU → ▼ → ENTER → [Picture] → ▼ → ▼ → ▼ → ▼ → ENTER → [Image Lock] → ▼ → ENTER → [Fine]



→ ◀ ▶ → ENTER

Removes noise such as horizontal stripes. If the noise persists even after Fine tuning, repeat it after adjusting the frequency (clock speed).

Position

MENU → ▼ → ENTER → [Picture] → ▼ → ▼ → ▼ → ▼ → ENTER → [Image Lock] → ▼ → ▼ → ENTER → [Position]



→ ▲, ▼, ◀, ▶ → ENTER

Adjusts the screen location horizontally and vertically.

Auto Adjustment **P**

MENU → ▼ → ENTER → [Picture] → ▼ → ▼ → ▼ → ▼ → ▼ → ▼ → ENTER → [Auto Adjustment]

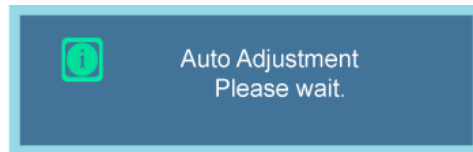

The values of **Fine**, **Coarse**, **Position** are adjusted automatically. By changing the resolution in the control panel, the auto function is performed.

(Available in **PC** mode only)

Signal Balance **P**

This is used to make up for the weak RGB signal transmitted by a long signal cable.

MENU → ▼ → ENTER → [Picture] → ▼ → ▼ → ▼ → ▼ → ▼ → ▼ → ENTER → [Signal Balance]

(Available in **PC** mode only)

Signal Balance

MENU → ▼ → ENTER → [Picture] → ▼ → ▼ → ▼ → ▼ → ▼ → ▼ → ENTER → [Signal Balance] → ENTER → [Signal Balance]

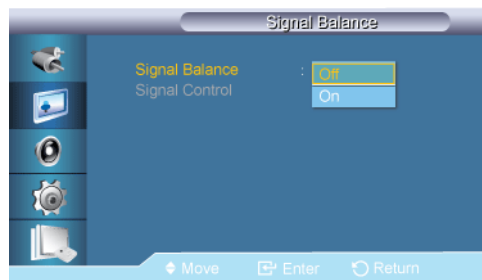

→ ▲, ▼ → ENTER

Selects either **On** or **Off** with the signal control.

Signal Control

MENU → ▼ → ENTER → [Picture] → ▼ → ▼ → ▼ → ▼ → ▼ → ▼ → ENTER → [Signal Balance] → ENTER → ▼ → [Signal Control]

1. **R-Gain**

MENU → ▼ → ENTER → [Picture] → ▼ → ▼ → ▼ → ▼ → ▼ → ▼ → ▼ → ENTER → [Signal Balance] → ENTER → ▼ → [Signal Control] → ENTER → [R-Gain]



→ ◀, ▶ → ENTER

2. G-Gain

MENU → ▼ → ENTER → [Picture] → ▼ → ▼ → ▼ → ▼ → ▼ → ▼ → ▼ → ENTER → [Signal Balance] → ENTER → ▼ → [Signal Control] → ▼ → ENTER → [G-Gain]



→ ◀, ▶ → ENTER

3. B-Gain

MENU → ▼ → ENTER → [Picture] → ▼ → ▼ → ▼ → ▼ → ▼ → ▼ → ▼ → ENTER → [Signal Balance] → ENTER → ▼ → [Signal Control] → ▼ → ▼ → ENTER → [B-Gain]



→ ◀, ▶ → ENTER

4. R-Offset

MENU → ▼ → ENTER → [Picture] → ▼ → ▼ → ▼ → ▼ → ▼ → ▼ → ▼ → ENTER → [Signal Balance] → ENTER → ▼ → [Signal Control] → ▼ → ▼ → ▼ → ENTER → [R-Offset]



→ ◀, ▶ → ENTER

5. G-Offset

MENU → ▼ → ENTER → [Picture] → ▼ → ▼ → ▼ → ▼ → ▼ → ▼ → ▼ → ENTER → [Signal Balance] → ENTER → ▼ → [Signal Control] → ▼ → ▼ → ▼ → ▼ → ENTER → [G-Offset]



→ ◀, ▶ → ENTER

6. B-Offset

MENU → ▼ → ENTER → [Picture] → ▼ → ▼ → ▼ → ▼ → ▼ → ▼ → ▼ → ENTER → [Signal Balance] → ENTER → ▼ → [Signal Control] → ▼ → ▼ → ▼ → ▼ → ENTER → [B-Offset]



→ ◀, ▶ → ENTER

Size **P**

MENU → ▼ → ENTER → [Picture] → ▼ → ▼ → ▼ → ▼ → ▼ → ▼ → ▼ → ENTER → ■■■■



→ ▲, ▼ → ENTER

The **Size** can be switched.

1. **16:9**
2. **4:3**

HDMI Black Level **P**

MENU → ▼ → ENTER → **[Picture]** → ▼ → ▼ → ▼ → ▼ → ▼ → ▼ → ENTER → **[HDMI Black Level]**

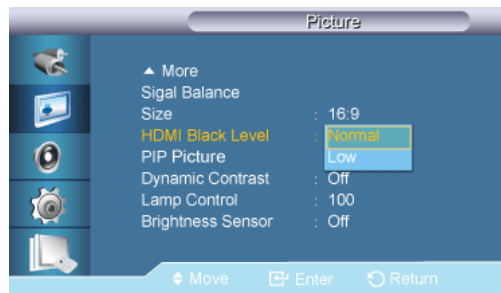

→ ▲, ▼ → ENTER

When watching with a DVD or set-top box connecting to the product via HDMI or DVI, image quality deterioration (black level, lower-quality contrast, lighter color tone, etc.) may occur depending on the connected external device.

1. **Normal**
2. **Low**

Note

- For Timing which can be used for both the PC and the DTV in **DVI, HDMI** mode, **HDMI Black Level** will be activated.

PIP Picture **P**

MENU → ▼ → ENTER → **[Picture]** → ▼ → ▼ → ▼ → ▼ → ▼ → ▼ → ▼ → ▼ → ▼ → ENTER → **[PIP Picture]**

→ ▲, ▼ → ENTER

Adjusts the PIP Screen Settings.

Note

- Available Modes: **PIP ON**
1. **Contrast**

MENU → ▼ → ENTER → [Picture] → ▼ → ▼ → ▼ → ▼ → ▼ → ▼ → ▼ → ▼ → ▼ → ENTER → [Contrast]



→ ◀, ▶ → ENTER

Adjusts the Contrast of the PIP window on the screen.

2. Brightness

MENU → ▼ → ENTER → [Picture] → ▼ → ▼ → ▼ → ▼ → ▼ → ▼ → ▼ → ▼ → ▼ → ENTER → [Brightness]



→ ◀, ▶ → ENTER

Adjusts the Brightness of the PIP window on the screen.

3. Sharpness

MENU → ▼ → ENTER → [Picture] → ▼ → ▼ → ▼ → ▼ → ▼ → ▼ → ▼ → ▼ → ▼ → ENTER → [Sharpness]



→ ◀, ▶ → ENTER

Adjusts the Sharpness of the PIP window on the screen.

4. Color

MENU → ▼ → ENTER → [Picture] → ▼ → ▼ → ▼ → ▼ → ▼ → ▼ → ▼ → ▼ → ▼ → ENTER → [Color]



→ ◀, ▶ → ENTER

Adjusts the Color of the PIP window on the screen.

Note

Enabled only when the **PIP** input is selected in **AV**, **HDMI** or **Component** mode.

5. Tint

MENU → ▼ → ENTER → [Picture] → ▼ → ▼ → ▼ → ▼ → ▼ → ▼ → ▼ → ▼ → ▼ → ENTER → [Tint]



→ ◀, ▶ → ENTER

Adds a natural tone to the PIP window.

 **Note**

Enabled only when the **PIP** input is selected in **AV**, **HDMI** or **Component** mode. Operates only if the video signal is NTSC.

Dynamic Contrast **PM**

MENU → ▼ → ENTER → [Picture] → ▼ → ▼ → ▼ → ▼ → ▼ → ▼ → ▼ → ▼ → ▼ → ▼ → ENTER →

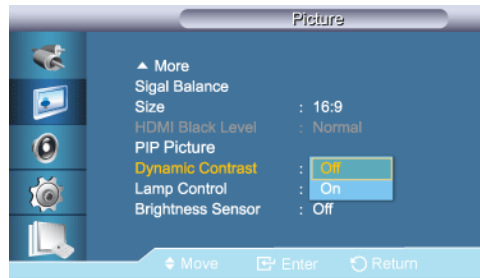

→ ▲, ▼ → ENTER

Dynamic Contrast automatically detects the distribution of the visual signal and adjusts to create an optimum contrast.

1. Off
2. On

Lamp Control **PACHM**

MENU → ▼ → ENTER → [Picture] → ▼ → ▼ → ▼ → ▼ → ▼ → ▼ → ▼ → ▼ → ▼ → ▼ → ▼ → ENTER → [Lamp Control]



→ ◀, ▶ → ENTER

Adjusts the inverter lamp in order to reduce energy consumption.

 **Note**

This function does not operate when **Dynamic Contrast** is set to **On** in **PC**, **DVI**, **AV**, **HDMI**, **Component** or **MagicInfo** modes. (**MagicInfo** : Applicable to the DXN-2 model only.)

Brightness Sensor **PM**

MENU → ▼ → ENTER → [Picture] → ▼ → ▼ → ▼ → ▼ → ▼ → ▼ → ▼ → ▼ → ▼ → ▼ → ▼ → ENTER →

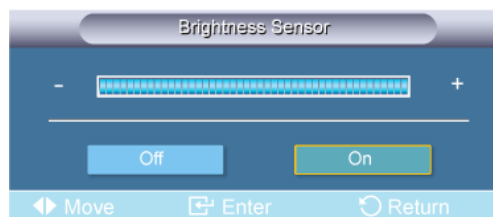

→ ▲, ▼ → ENTER

Brightness Sensor automatically detects distribution of the inputted visual signal and adjusts to create optimum brightness.

1. Off
2. On

Picture [AV / HDMI / Component Mode]

Available Modes

- **P** PC / DVI / BNC
- **A** AV
- **C** Component
- **H** HDMI
- **M** MagicInfo

Note

- The **BNC** mode will not be activated on the DXN-2 model.
- **MagicInfo** supports the DXN-2 model only.

Mode **AHC**

MENU → ▼ → ENTER → **[Picture]** → ENTER → **[Mode]**

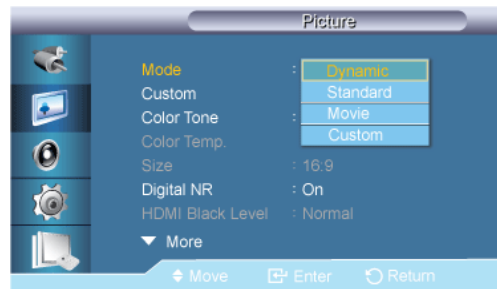

→ ▲, ▼ → ENTER

The LCD Display has four automatic picture settings ("**Dynamic**", "**Standard**", "**Movie**" and "**Custom**") that are preset at the factory.

Dynamic, **Standard**, **Movie**, or **Custom** can be activated.

(Not available when **Dynamic Contrast** is set to **On**.)

1. **Dynamic**
2. **Standard**
3. **Movie**
4. **Custom**

Custom **AHC**

By using the on-screen menus, the contrast and brightness can be changed to your personal preference.

MENU → ▼ → ENTER → **[Picture]** → ▼ → ENTER → **[Custom]**

(Not available when **Dynamic Contrast** is set to **On**.)

Contrast

MENU → ▼ → ENTER → [Picture] → ▼ → ENTER → [Custom] → ENTER → [Contrast]



→ ◀, ▶ → ENTER

Adjusts the Contrast.

Brightness

MENU → ▼ → ENTER → [Picture] → ▼ → ENTER → [Custom] → ▼ → ENTER → [Brightness]



→ ◀, ▶ → ENTER

Adjusts the Brightness.

Sharpness

MENU → ▼ → ENTER → [Picture] → ▼ → ENTER → [Custom] → ▼ → ▼ → ENTER → [Sharpness]



→ ◀, ▶ → ENTER

Adjusts the picture Sharpness.

Color

MENU → ▼ → ENTER → [Picture] → ▼ → ENTER → [Custom] → ▼ → ▼ → ▼ → ENTER → [Color]



→ ◀, ▶ → ENTER

Adjusts the picture Color.

Tint

MENU → ▼ → ENTER → [Picture] → ▼ → ENTER → [Custom] → ▼ → ▼ → ▼ → ▼ → ENTER → [Tint]



→ ◀, ▶ → ENTER

Adds a natural tone to the display.

Color Tone **AHC**

MENU → ▼ → ENTER → [Picture] → ▼ → ▼ → ENTER → [Color Tone]

Adjusting the LCD Display



→ ▲, ▼ → ENTER

The color tones can be changed. The individual Color components are also user adjustable.

(Not available when **Dynamic Contrast** is set to **On**.)

1. **Off**
2. **Cool2**
3. **Cool1**
4. **Normal**
5. **Warm1**
6. **Warm2**



Note

If you set the **Color Tone** to **Cool2**, **Cool1**, **Normal**, **Warm1**, or **Warm2**, the **Color Temp.** function is disabled.

Color Temp. **AHG**

MENU → ▼ → ENTER → **[Picture]** → ▼ → ▼ → ▼ → ENTER → **[Color Temp.]**



→ ◀, ▶ → ENTER

Color temp. is a measure of the 'warmth' of the image colors.

(Not available when **Dynamic Contrast** is set to **On**.)



Note

This function is only enabled if the **Color Tone** is set to **Off**.

Size **AH**

MENU → ▼ → ENTER → **[Picture]** → ▼ → ▼ → ▼ → ▼ → ENTER → **[Size]**

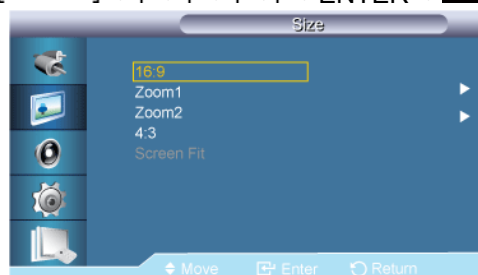

→ ▲, ▼ → ENTER

The **Size** can be switched.

1. **16:9**: Sets the picture to 16:9 wide mode.
2. **Zoom 1**: Magnifies the size of the picture on the screen.
3. **Zoom 2**: Magnifies the size of the picture more than **Zoom 1**.
4. **4:3**: Sets the picture to 4:3 normal mode.
5. **Screen Fit**: Displays the input scenes as they are without any cutoff when HDMI 720p, 1080i, 1080p signals are input.

(Not available when **Dynamic Contrast** is set to **On**.)

 **Note**

- Certain external devices may feed the display an out of spec signal that may cause cutoff even when using the **Screen Fit** feature.
- **Zoom 1**, **Zoom 2** are unavailable in **HDMI** mode.
- The **Position** and **Reset** functions are available in **Zoom 1** or **Zoom 2** modes.

Digital NR (Digital Noise Reduction)

MENU → ▼ → ENTER → **[Picture]** → ▼ → ▼ → ▼ → ▼ → ▼ → ENTER → **[Digital NR]**



→ ▲, ▼ → ENTER

Turns the Digital Noise Reduction feature **Off/On**. The Digital Noise Reduction feature allows you to enjoy clearer and crisper images.

1. **Off**
2. **On**

 **Note**

Digital NR function is not available for all resolutions.

HDMI Black Level

MENU → ▼ → ENTER → **[Picture]** → ▼ → ▼ → ▼ → ▼ → ▼ → ▼ → ENTER → **[HDMI Black Level]**



→ ▲, ▼ → ENTER

When a DVD or set-top box is connected to your TV via HDMI or DVI, it may cause a degradation in the screen quality, such as an increase in the black level, a low contrast, or discoloration, etc., depending on the external device connected. In this case, adjust the screen quality of your TV by configuring the **HDMI black level**.

1. **Normal**
2. **Low**



Note

For Timing which can be used for both the PC and the DTV in **DVI, HDMI mode, HDMI Black Level** will be activated.

Film Mode **AC**

MENU → ▼ → ENTER → **[Picture]** → ▼ → ▼ → ▼ → ▼ → ▼ → ▼ → ▼ → ENTER → **[Film Mode]**



→ ▲, ▼ → ENTER

The **Film Mode** feature offers you a theater-quality viewing experience.

In **HDMI** mode, this function is available when the input signal is interlaced scan; it is not available in progressive scan.

1. **Off**
2. **On**

PIP Picture **ACH**

MENU → ▼ → ENTER → **[Picture]** → ▼ → ▼ → ▼ → ▼ → ▼ → ▼ → ▼ → ▼ → ENTER → **[PIP Picture]**

→ ▲, ▼ → ENTER

Adjusts the PIP Screen Settings.

 **Note**

- Available Modes: **PIP ON**

1. **Contrast**

MENU → ▼ → ENTER → [Picture] → ▼ → ▼ → ▼ → ▼ → ▼ → ▼ → ▼ → ▼ → ENTER → 
→ ENTER → [Contrast]



→ ◀, ▶ → ENTER

Adjusts the Contrast of the PIP window on the screen.

2. **Brightness**

MENU → ▼ → ENTER → [Picture] → ▼ → ▼ → ▼ → ▼ → ▼ → ▼ → ▼ → ▼ → ENTER → 
→ ▼ → ENTER → [Brightness]



→ ◀, ▶ → ENTER

Adjusts the Brightness of the PIP window on the screen.

3. **Sharpness**

MENU → ▼ → ENTER → [Picture] → ▼ → ▼ → ▼ → ▼ → ▼ → ▼ → ▼ → ▼ → ENTER → 
→ ▼ → ▼ → ENTER → [Sharpness]



→ ◀, ▶ → ENTER

Adjusts the Sharpness of the PIP window on the screen.

4. **Color**

MENU → ▼ → ENTER → [Picture] → ▼ → ▼ → ▼ → ▼ → ▼ → ▼ → ▼ → ▼ → ENTER → 
→ ▼ → ▼ → ▼ → ENTER → [Color]



→ ◀, ▶ → ENTER

Adjusts the Color of the PIP window on the screen.

 **Note**

Enabled only when the **PIP** input is selected in **AV**, **HDMI** or **Component** mode.

5. **Tint**

MENU → ▼ → ENTER → [Picture] → ▼ → ▼ → ▼ → ▼ → ▼ → ▼ → ▼ → ▼ → ENTER → 
→ ▼ → ▼ → ▼ → ▼ → ENTER → [Tint]



→ ◀, ▶ → ENTER

Adds a natural tone to the PIP window.

 **Note**

Enabled only when the **PIP** input is selected in **AV**, **HDMI** or **Component** mode. Operates only if the video signal is NTSC.

Dynamic Contrast **AHC**

MENU → ▼ → ENTER → [Picture] → ▼ → ▼ → ▼ → ▼ → ▼ → ▼ → ▼ → ▼ → ▼ → ▼ → ENTER →



→ ▲, ▼ → ENTER

Dynamic Contrast automatically detects the distribution of the visual signal and adjusts to create an optimum contrast.

1. Off
2. On

Lamp Control **AHC**

MENU → ▼ → ENTER → [Picture] → ▼ → ▼ → ▼ → ▼ → ▼ → ▼ → ▼ → ▼ → ▼ → ▼ → ENTER → [Lamp Control]



→ ◀, ▶ → ENTER

Adjusts the inverter lamp in order to reduce energy consumption.

 **Note**

This function does not operate when **Dynamic Contrast** is set to **On** in **PC**, **DVI**, **AV**, **HDMI**, **Component** or **MagicInfo** modes. (**MagicInfo** : Applicable to the DXN-2 model only.)

Brightness Sensor **AHC**

MENU → ▼ → ENTER → [Picture] → ▼ → ▼ → ▼ → ▼ → ▼ → ▼ → ▼ → ▼ → ▼ → ▼ → ENTER →

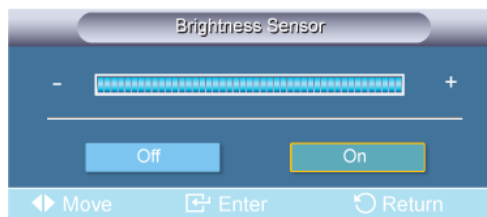

→ ▲, ▼ → ENTER

Brightness Sensor automatically detects distribution of the inputted visual signal and adjusts to create optimum brightness.

1. Off
2. On

Sound

Available Modes

- **P** PC / DVI / BNC
- **A** AV
- **C** Component
- **H** HDMI
- **M** MagicInfo



Note

- The **BNC** mode will not be activated on the DXN-2 model.
- **MagicInfo** supports the DXN-2 model only.

Mode **PACHM**

MENU → ▼ → ▼ → ENTER → [Sound] → ENTER → [Mode]

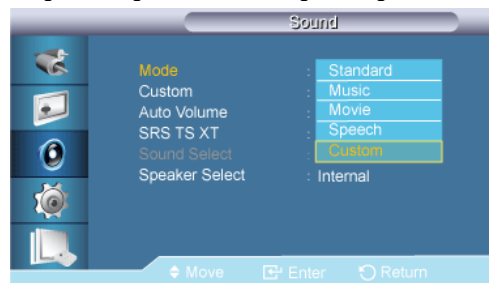

→ ▲, ▼ → ENTER

The LCD Display has a built-in high fidelity stereo amplifier.

1. **Standard**
Selects **Standard** for the standard factory settings.
2. **Music**
Selects **Music** when watching music videos or concerts.
3. **Movie**
Selects **Movie** when viewing movies.
4. **Speech**
Selects **Speech** when watching a show that is mostly dialog (i.e., news).

5. Custom

Selects **Custom** if you want to adjust the settings according to your personal preferences.

Custom **PACHM**

The sound settings can be adjusted to suit your personal preferences.

MENU → ▼ → ▼ → ENTER → [Sound] → ▼ → ENTER → [Custom]

 **Note**

- You can hear the sound even when sound value is set to 0.
- If you adjust sound using **Custom** function, **Mode** will turn to **Custom** mode.

Bass

MENU → ▼ → ▼ → ENTER → [Sound] → ▼ → ENTER → [Custom] → ENTER → [Bass]



→ ◀ ▶ → ENTER

Emphasizes low frequency audio.

Treble

MENU → ▼ → ▼ → ENTER → [Sound] → ▼ → ENTER → [Custom] → ▼ → ENTER → [Treble]



→ ◀ ▶ → ENTER

Emphasizes high frequency audio.

Balance

MENU → ▼ → ▼ → ENTER → [Sound] → ▼ → ENTER → [Custom] → ▼ → ▼ → ENTER → [Balance]



→ ◀ ▶ → ENTER

Allows you to Adjusts the sound balance between the left and right speakers.

Auto Volume **PACHM**

MENU → ▼ → ▼ → ENTER → [Sound] → ▼ → ▼ → ENTER → [Auto Volume]

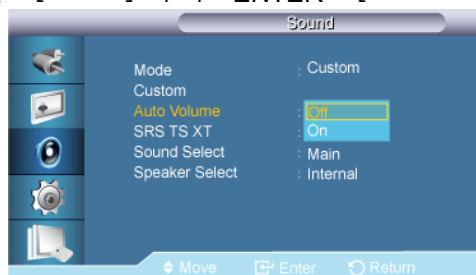

→ ▲, ▼ → ENTER

Reduces the difference in volume control between broadcasters.

1. Off
2. On

SRS TS XT **PACHM**

MENU → ▼ → ▼ → ENTER → [Sound] → ▼ → ▼ → ▼ → ENTER → [SRS TS XT]

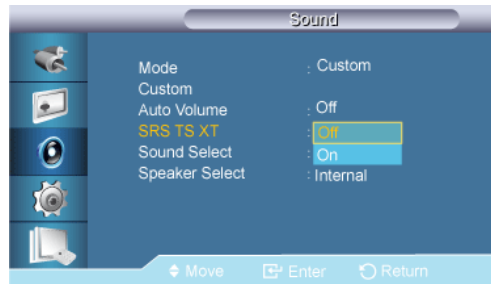

→ ▲, ▼ → ENTER

SRS TS XT is a patented SRS technology that solves the problem of playing 5.1 multichannel content over two speakers. TruSurround XT delivers a compelling, virtual surround sound experience through any two-speaker playback system, including internal television speakers. It is fully compatible with all multichannel formats.

1. Off
2. On

Sound Select **PACHM**

MENU → ▼ → ▼ → ENTER → [Sound] → ▼ → ▼ → ▼ → ▼ → ENTER → [■■■■■■■■■■]

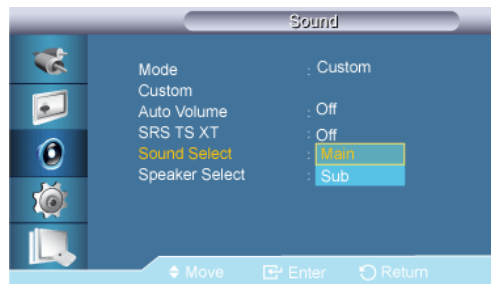

→ ▲, ▼ → ENTER

Selects either Main or Sub when **PIP** is On.

 **Note**

Available Modes: **PIP ON**

1. Main
2. Sub

Speaker Select **PACHM**

MENU → ▼ → ▼ → ENTER → [Sound] → ▼ → ▼ → ▼ → ▼ → ▼ → ENTER → [■■■■■■■■■■]



→ ▲, ▼ → ENTER

When you use the product with it connecting to a Home theater, turn the Internal speakers off so you can listen to sound from the Home theater's (external) speakers.

1. Internal

Sound is outputted both from the **Internal** speaker and the **External** speakers, but the volume control is only available from the **Internal** speaker.

2. External

When sound is only outputted from the **External** speakers, the volume control is also only available from the **External** speakers.

Setup

Available Modes

- **P** PC / DVI / BNC
- **A** AV
- **C** Component
- **H** HDMI
- **M** MagicInfo

Note

- The **BNC** mode will not be activated on the DXN-2 model.
- **MagicInfo** supports the DXN-2 model only.

Language **PACHM**

MENU → ▼ → ▼ → ▼ → ENTER → [Setup] → ENTER → [Language]

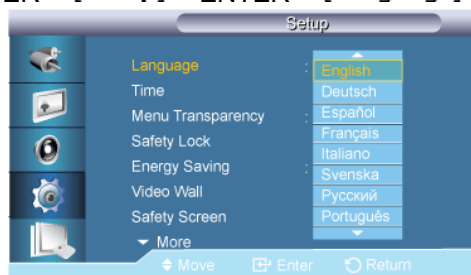

→ ▲, ▼ → ENTER

You can choose one of 13 languages.

English, Deutsch, Español, Français, Italiano, Svenska, Русский
Português, Türkçe, 简体中文, 繁體中文, 日本語, 한국어

 **Note**

The language chosen affects only the language of the OSD. It has no effect on any software running on the computer.

Time P A C H M

Selects from one of 4 time settings, **Clock Set**, **Sleep Timer**, **On Timer**, and **Off Timer**.

MENU → ▼ → ▼ → ▼ → ENTER → [Setup] → ▼ → ENTER → [Time]

Clock Set

MENU → ▼ → ▼ → ▼ → ENTER → [Setup] → ▼ → ENTER → [Time] → ENTER → [Clock Set]

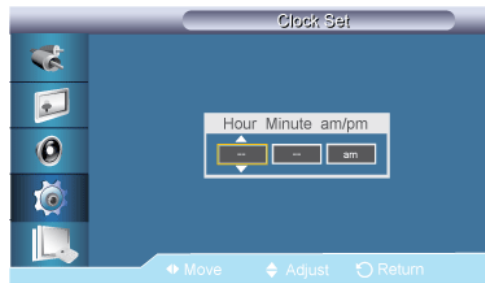

→ ▲, ▼ → ◀, ▶ → ENTER

Current Time Setting.

Sleep Timer

MENU → ▼ → ▼ → ▼ → ENTER → [Setup] → ▼ → ENTER → [Time] → ▼ → ENTER → [Sleep Timer]



→ ▲, ▼ → ENTER

Turns the LCD Display off automatically at certain times.

1. **Off**
2. **30**
3. **60**
4. **90**
5. **120**

6. 150

7. 180

On Timer

MENU → ▼ → ▼ → ▼ → ENTER → [Setup] → ▼ → ENTER → [Time] → ▼ → ▼ → ENTER → [On Timer]



→ ▲, ▼ / ◀, ▶ → ENTER

Turns the LCD Display on automatically at a preset time. Controls the mode and the volume level at the time the LCD Display turns on automatically.

Off Timer

MENU → ▼ → ▼ → ▼ → ENTER → [Setup] → ▼ → ENTER → [Time] → ▼ → ▼ → ▼ → ENTER → [Off Timer]

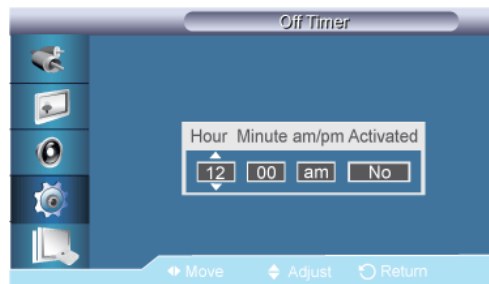

→ ▲, ▼ / ◀, ▶ → ENTER

Turns the LCD Display off automatically at a preset time.

Menu Transparency **PACHM**

MENU → ▼ → ▼ → ▼ → ENTER → [Setup] → ▼ → ▼ → ENTER → **Menu Transparency**

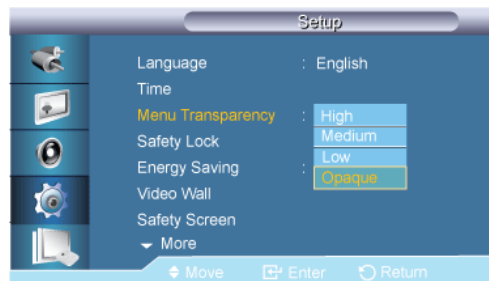

→ ▲, ▼ → ENTER

Change the transparency of the background of the OSD.

1. High

2. Medium
3. Low
4. Opaque

Safety Lock PACHM

Change PIN

MENU → ▼ → ▼ → ▼ → ENTER → [Setup] → ▼ → ▼ → ▼ → ENTER → [0000] → ENTER → [0000]

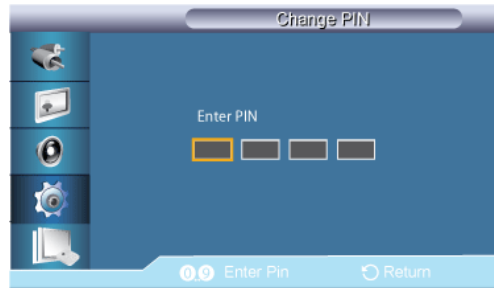

→ [0~9] → [0~9] → [0~9] → [0~9]

The password can be changed.

Note

The preset password for the LCD Display is "0000".

Lock On

MENU → ▼ → ▼ → ▼ → ENTER → [Setup] → ▼ → ▼ → ▼ → ENTER → [0000] → ▼ → ENTER → [0000]

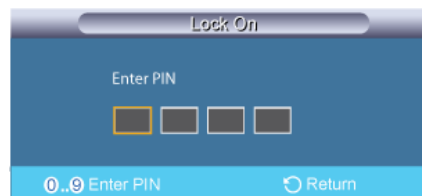

→ [0~9] → [0~9] → [0~9] → [0~9]

This is the function that locks the OSD in order to keep the current settings or to prevent others from adjusting the settings.

Energy Saving PACHM

MENU → ▼ → ▼ → ▼ → ENTER → [Setup] → ▼ → ▼ → ▼ → ▼ → ENTER → [Energy Saving]

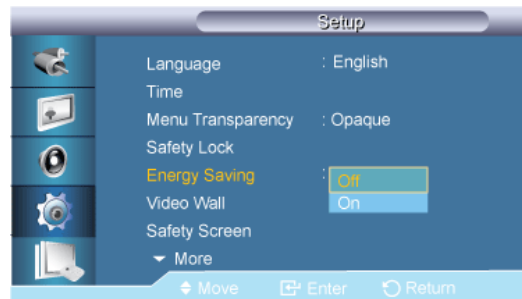

→ ▲, ▼ → ENTER

This feature adjusts the power consumption of the unit in order to save energy.

1. Off
2. On

Video Wall **PACHM**

A **Video Wall** is a set of video screens connected together, so that each screen shows a part of the whole picture or where the same picture is repeated on each screen.

When the **Video Wall** is on, you can adjust the **Video Wall** screen setting.

MENU → ▼ → ▼ → ▼ → ENTER → [Setup] → ▼ → ▼ → ▼ → ▼ → ▼ → ▼ → ENTER → [Video Wall]

 **Note**

When **Video Wall** is running, the **Auto Adjustment**, **Image Lock**, and **Size** functions are not available. **Video Wall** does not operate in **MagicInfo** mode.

Video Wall

MENU → ▼ → ▼ → ▼ → ENTER → [Setup] → ▼ → ▼ → ▼ → ▼ → ▼ → ▼ → ENTER → [Video Wall] → ENTER → [Video Wall]

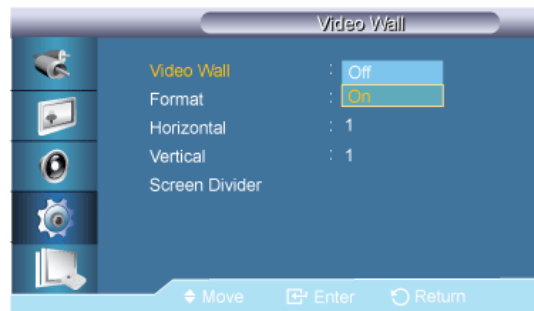

→ ▲, ▼ → ENTER

Turns Off/On the **Video Wall** function of the selected display Off/On.

1. Off
2. On

Format

MENU → ▼ → ▼ → ▼ → ENTER → [Setup] → ▼ → ▼ → ▼ → ▼ → ▼ → ▼ → ENTER → [Video Wall] → ▼ → ENTER → [Format]



→ ▲, ▼ → ENTER

The **Format** can be selected to see a divided screen.

1. **Full**

Provides a full screen without any margins.

2. **Natural**

Displays a natural image with the original aspect ratio intact.

Horizontal

MENU → ▼ → ▼ → ▼ → ENTER → [Setup] → ▼ → ▼ → ▼ → ▼ → ▼ → ▼ → ENTER → [Video Wall] → ▼ → ▼ → ENTER → [Horizontal]



→ ▲, ▼ → ENTER

Sets how many parts the screen should be divided horizontally.

Five adjustment levels: 1, 2, 3, 4, and 5.

Vertical

MENU → ▼ → ▼ → ▼ → ENTER → [Setup] → ▼ → ▼ → ▼ → ▼ → ▼ → ▼ → ENTER → [Video Wall] → ▼ → ▼ → ▼ → ENTER → [Vertical]



→ ▲, ▼ → ENTER

Sets how many parts the screen should be divided vertically.

Five adjustment levels: 1, 2, 3, 4, and 5.

Screen Divider

MENU → ▼ → ▼ → ▼ → ENTER → [Setup] → ▼ → ▼ → ▼ → ▼ → ▼ → ▼ → ENTER → [Video Wall] → ▼ → ▼ → ▼ → ENTER → [Screen Divider]

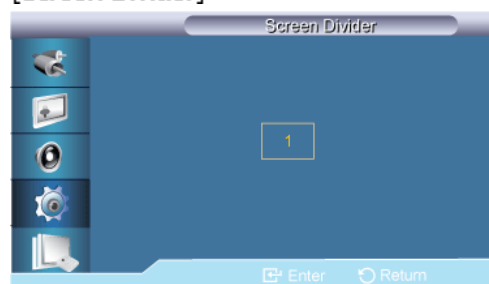

The screen can be divided into several images. A number of screens can be selected with a different layout when dividing.

- Select a mode in Screen Divider.
- Select a display in Display Selection.
- The selection will be set up by pressing a number in the selected mode.

Safety Screen **PACHM**

The **Safety Screen** function is used to prevent afterimages that may appear when a still picture is displayed on the screen over a long time.

- The **Safety Screen** function scrolls the screen for the specified period of time.
- This function is not available when the power is turned off.

MENU → ▼ → ▼ → ▼ → ENTER → [Setup] → ▼ → ▼ → ▼ → ▼ → ▼ → ▼ → ▼ → ENTER → [Safety Screen]

Pixel Shift

Pixel Shift

MENU → ▼ → ▼ → ▼ → ENTER → [Setup] → ▼ → ▼ → ▼ → ▼ → ▼ → ▼ → ▼ → ENTER → [Safety Screen] → ENTER → [Pixel Shift] → ENTER → [Pixel Shift] → ▲, ▼ → ENTER

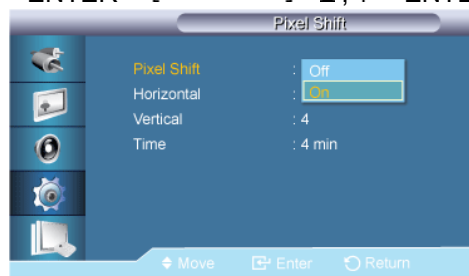

To prevent after-images on the screen, you can use this function to have pixels move on the LCD in the horizontal or vertical direction.

1. Off
2. On



Note

The **Pixel Shift** is not available when **Video Wall** is On.

Horizontal

MENU → ▼ → ▼ → ▼ → ENTER → [Setup] → ▼ → ▼ → ▼ → ▼ → ▼ → ▼ → ▼ → ENTER → [Safety Screen] → ENTER → [Pixel Shift] → ▼ → ENTER → [Horizontal] → ▲, ▼ → ENTER

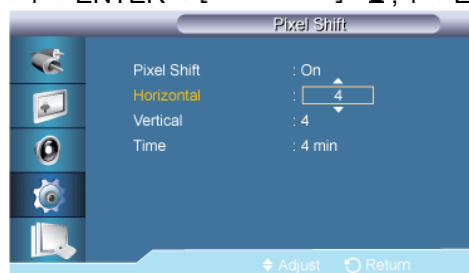

Sets how many pixels the screen moves horizontally.

Five adjustment levels: 0, 1, 2, 3, and 4.

Vertical

MENU → ▼ → ▼ → ▼ → ENTER → [Setup] → ▼ → ▼ → ▼ → ▼ → ▼ → ▼ → ▼ → ENTER → [Safety Screen] → ENTER → [Pixel Shift] → ▼ → ▼ → ENTER → [Vertical] → ▲, ▼ → ENTER



Sets how many pixels the screen moves vertically.

Five adjustment levels: 0, 1, 2, 3, and 4.

Time

MENU → ▼ → ▼ → ▼ → ENTER → [Setup] → ▼ → ▼ → ▼ → ▼ → ▼ → ▼ → ▼ → ENTER → [Safety Screen] → ENTER → [Pixel Shift] → ▼ → ▼ → ▼ → ENTER → [Time] → ▲, ▼ → ENTER

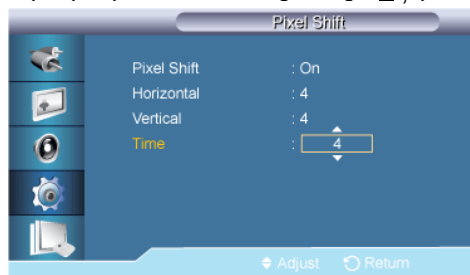

Set the time interval for performing the horizontal or vertical movement, respectively.

Timer

Timer

MENU → ▼ → ▼ → ▼ → ENTER → [Setup] → ▼ → ▼ → ▼ → ▼ → ▼ → ▼ → ▼ → ENTER → [Safety Screen] → ▼ → ENTER → [Timer] → ENTER → [Timer] → ▲, ▼ → ENTER

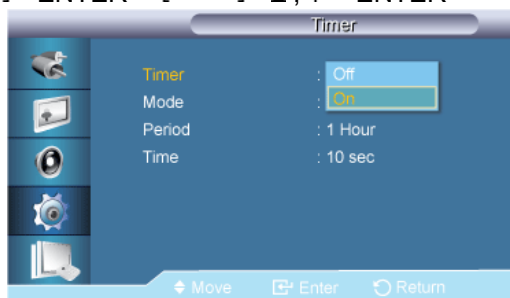

You can set the timer for Screen Burn Protection.

If you start the operation to erase any residual image, the operation will be performed for the set period of time and then automatically finish.

1. Off
2. On

Mode

MENU → ▼ → ▼ → ▼ → ENTER → [Setup] → ▼ → ▼ → ▼ → ▼ → ▼ → ▼ → ▼ → ENTER → [Safety Screen] → ▼ → ENTER → [Timer] → ▼ → ENTER → [Mode] → ▲, ▼ → ENTER



You can change the **Safety Screen** Type.

1. Scroll
2. Bar
3. Eraser

Period

MENU → ▼ → ▼ → ▼ → ENTER → [Setup] → ▼ → ▼ → ▼ → ▼ → ▼ → ▼ → ▼ → ENTER → [Safety Screen] → ▼ → ENTER → [Timer] → ▼ → ▼ → ENTER → [Period] → ▲, ▼ → ENTER



Use this function to set the execution period for each mode set in the timer.

Time

MENU → ▼ → ▼ → ▼ → ENTER → [Setup] → ▼ → ▼ → ▼ → ▼ → ▼ → ▼ → ▼ → ENTER → [Safety Screen] → ▼ → ENTER → [Timer] → ▼ → ▼ → ENTER → [Time] → ▲, ▼ → ENTER

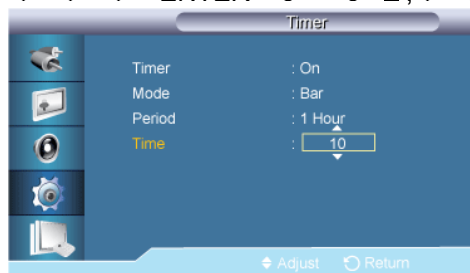

Within the set period of time specify a time for execution.

- **Mode-Scroll** : 1~5 sec

- **Mode-Bar, Eraser** : 10~50 sec

Scroll

MENU → ▼→▼→▼→ ENTER → [Setup] → ▼→▼→▼→▼→▼→▼→▼→ ENTER → [Safety Screen]
→ ▼→▼→ ENTER → [Scroll]



This function helps to remove after-images on the screen by moving all the pixels on the LCD according to a pattern.

Use this function when there are remaining after-images or symbols on the screen, especially when you displayed a still image on the screen for a long time.

Bar

MENU → ▼→▼→▼→ ENTER → [Setup] → ▼→▼→▼→▼→▼→▼→▼→ ENTER → [Safety Screen]
→ ▼→▼→▼→ ENTER → [Bar]



This function prevents after-images on the screen by moving long black and white vertical lines.

Eraser

MENU → ▼→▼→▼→ ENTER → [Setup] → ▼→▼→▼→▼→▼→▼→▼→ ENTER → [Safety Screen]
→ ▼→▼→▼→▼→ ENTER → [Eraser]



This function prevents after-images on the screen by moving a rectangular pattern.

Side Gray

MENU → ▼→▼→▼→ ENTER → [Setup] → ▼→▼→▼→▼→▼→▼→▼→ ENTER → [Safety Screen]
→ ▼→▼→▼→▼→ ENTER → [Side Gray]

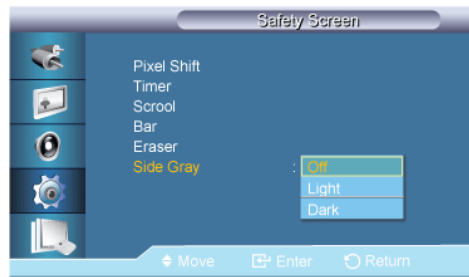

→ ▲, ▼ → ENTER

Select the brightness of the grey for the screen background.

1. Off
2. Light
3. Dark

Resolution Select **P**

MENU → ▼ → ▼ → ▼ → ENTER → [Setup] → ▼ → ▼ → ▼ → ▼ → ▼ → ▼ → ▼ → ▼ → ENTER →

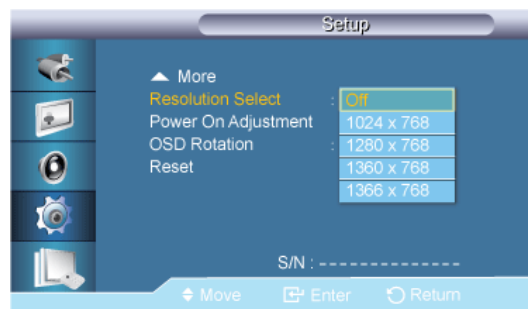

→ ▲, ▼ → ENTER

When the picture is not displayed properly on the screen when setting the graphics card resolution of the computer to 1024 x 768 @ 60Hz, 1280 x 768 @ 60Hz, 1360 x 768 @ 60Hz or 1366 x 768 @ 60Hz, by using this function(Resolution Select), you can have the picture displayed on the screen in the specified resolution.

 **Note**

Available in PC mode only

1. Off
2. 1024 X 768
3. 1280 X 768
4. 1360 x 768
5. 1366 X 768

 **Note**

Selecting the menu is only allowed when the graphics resolution is set to 1024 x 768 @ 60Hz, 1280 x 768 @ 60Hz, 1360 x 768 @ 60Hz or 1366 x 768 @ 60Hz.

Power On Adjustment **PACHM**

MENU → ▼ → ▼ → ▼ → ENTER → [Setup] → ▼ → ▼ → ▼ → ▼ → ▼ → ▼ → ▼ → ▼ → ▼ → ▼ → ENTER →

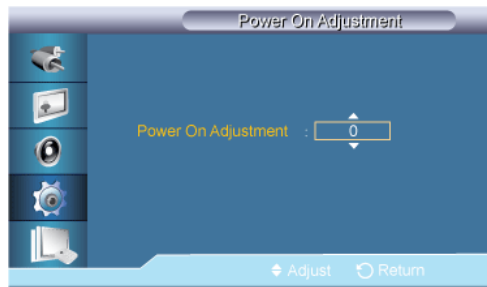

→ ▲, ▼ → ENTER

Adjusts the Power On time for the screen.

OSD Rotation **PACHM**

MENU → ▼ → ▼ → ▼ → ENTER → [Setup] → ▼ → ▼ → ▼ → ▼ → ▼ → ▼ → ▼ → ▼ → ▼ → ▼ → ▼ → ▼ → ENTER → [OSD Rotation]



→ ▲, ▼ → ENTER

OSD Rotate

1. Landscape
2. Portrait

Reset

Reverts the product settings to factory defaults. The Reset function is only available when PC / DVI is being used.

MENU → ▼ → ▼ → ▼ → ENTER → [Setup] → ▼ → ▼ → ▼ → ▼ → ▼ → ▼ → ▼ → ▼ → ▼ → ▼ → ENTER → [Reset]

Image Reset **P**

MENU → ▼ → ▼ → ▼ → ENTER → [Setup] → ▼ → ▼ → ▼ → ▼ → ▼ → ▼ → ▼ → ▼ → ▼ → ▼ → ENTER → [Reset] → ENTER → [Image Reset]

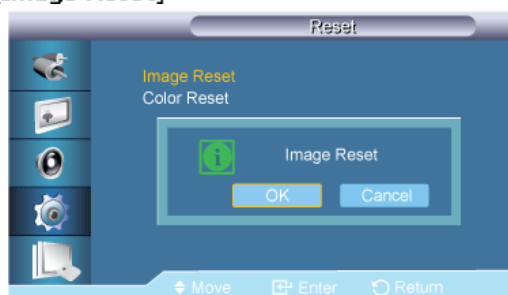

→ ▲, ▼ → [0~9]

- **ID Setup**

Assigns distinctive IDs to the SET.

- **ID Input**

Use to select the transmitter functions of the individual SET. Only a SET where the ID corresponds to the transmitter setting becomes activated.

MagicInfo

Available Modes

- **P** PC / DVI / BNC
- **A** AV
- **C** Component
- **H** HDMI
- **M** MagicInfo



Note

- The **BNC** mode will not be activated on the DXN-2 model.
- **MagicInfo** supports the DXN-2 model only.



Note

- The remote control can be used to select **MagicInfo**. However, it is recommended to use a separate USB keyboard to utilize **MagicInfo** fully.
- For **MagicInfo** in Device mode, moving external devices while booting may cause errors. Set up external devices only if the LCD Display turns on.
- Do not unplug the LAN cable used for the network (ex: video display). Otherwise, the program (MagicInfo) may stop. If you do unplug the cable, restart the system.
- Do not unplug the LAN cable used by an USB device (ex: video display). Otherwise, the program (MagicInfo) may stop.
- To access other sources, press the SOURCE button in **MagicInfo**.
- The preset password for the LCD Display is "000000".
- The server program's Power-On option works only if the LCD Display's power is completely shut off.

Please make sure not to use the Power-On option when the LCD Display is in the process of shutting down since this may cause system errors on the LCD Display.
- When using **MagicInfo** with the MagicInfo Server Program: perform Network mode.
- When using **MagicInfo** with the device directly connected to LCD Display : execute Device mode.

- Press ESC to directly go to the **MagicInfo** Window screen.
- To setup **MagicInfo** on a Windows screen, a keyboard and mouse are required.
- To setup **MagicInfo** on a Windows screen, refer to the MagicInfo Server Help.
It is highly recommended not to turn off the AC power during an operation.
- For pivoted LCD Displays, ticker transparency is not supported.
- For pivoted LCD Displays, a screen resolution of up to 720*480(SD) is supported for movies.
- For drive D:, **EFW** is not applied.
- To save Setup contents that have been changed when **EFW** is in the **Enable** state, you must **Commit** them.
- By selecting **Disable**, **Enable** or **Commit**, the system is restarted.

MagicInfo

1. Select Application - step 1

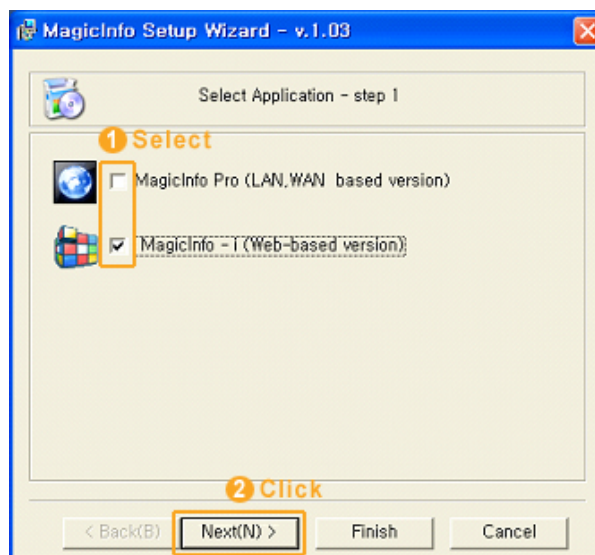

You can select an Application to be executed in your computer when Windows starts.

2. Select TCP/IP - step 2

Adjusting the LCD Display

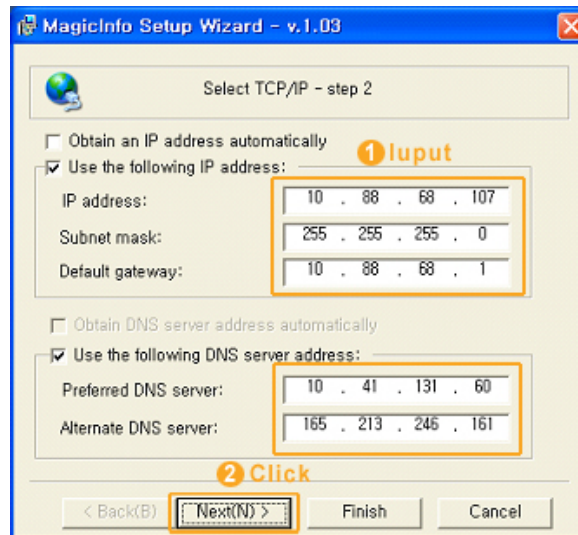

In step 2 of MagicInfo Setup Wizard, you don't have to go to Network Setting on the desktop to make your settings for TCP/IP. You just do that at step 2 of MagicInfo installation.

3. Select Language - step 3



When using multiple languages, you can choose and set a specific language among them.

4. Select Screen Type - step 4

Adjusting the LCD Display

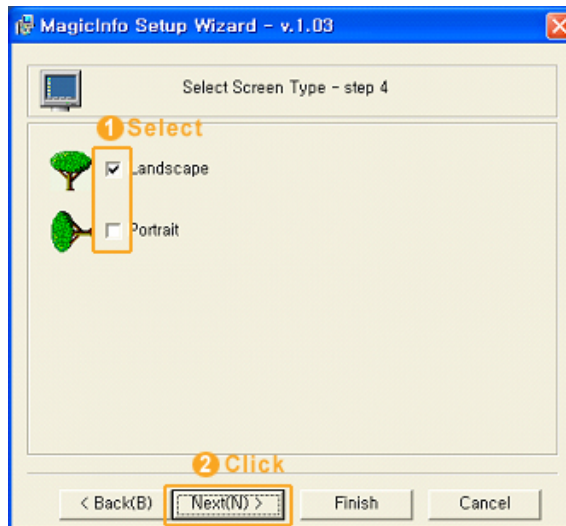

You can select which rotation type will be applied to your device.

5. Setup Information

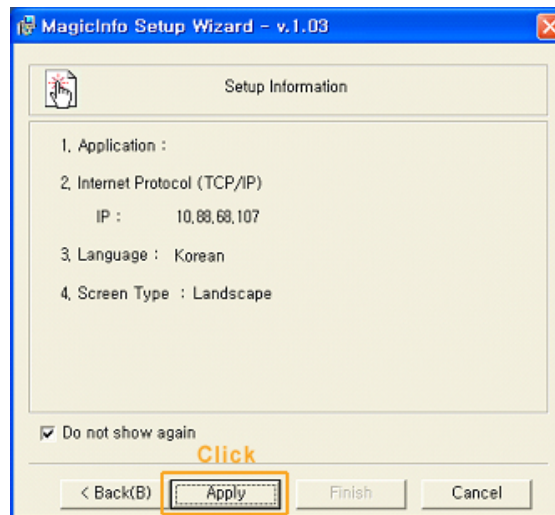

Shows the settings that have been selected by the user.

Note

If the **MagicInfo** icon is not displayed on the notification area, double click the **MagicInfo** icon on the window desktop. The icon will appear.

Troubleshooting

Self-Test Feature Check



Check the following items yourself before calling for assistance. Contact a Service Center for problems that you cannot solve by yourself.

Self-Test Feature Check

1. Turn off both your computer and the LCD Display.
2. Unplug the video cable from the back of the computer.
3. Turn on the LCD Display.

The figure shown below ("**Check Signal Cable**") appears on a black background when the LCD Display is working normally even though no video signal is detected: While in the Self-Test mode, the LED power indicator remains green and the figure moves around on the screen.



4. Turn off your LCD Display and reconnect the video cable; then turn on both your computer and the LCD Display

If your LCD Display screen remains blank after using the previous procedure, check your video controller and computer system; your LCD Display is functioning properly.

Warning Messages

You can even view the screen at a resolution of 1920 x 1080. However, you will receive the following message for a minute; You can choose to change the screen resolution or stay in the current mode during that time. If the resolution is more than 85Hz, you will see the black screen because the LCD Display does not support over 85Hz.

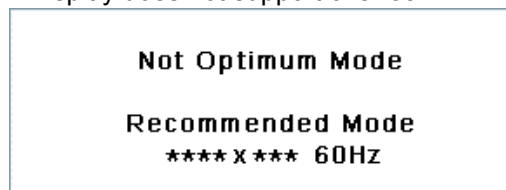

Refer to Specifications > Preset Timing Modes for the resolutions or frequencies supported by the LCD Display.

Maintenance and Cleaning

- 1) Maintaining the LCD Display Case.

Clean with a soft cloth after disconnecting the power cord.



- Do not use benzene, thinner or other flammable substances.

2) Maintaining the Flat Panel Display Screen.

Clean with a soft cloth (cotton flannel).



- Never use acetone, benzene or thinner.
(They may cause flaws or deformation of the screen surface.)
- The user is responsible for any damage caused by using these substances.

Symptoms and Recommended Actions



Note

A LCD Display recreates visual signals received from the computer. Therefore, if there is a problem with the computer or the video card, this can cause the LCD Display to become blank, have poor coloring, become noisy, etc. In this case, first check the source of the problem, and then contact a Service Center or your dealer.

1. Check if the power cord and the video cables are properly connected to the computer.
2. Check if the computer beeps more than 3 times when booting.
(If it does, request service.)
3. If you installed a new video card or if you assembled the PC, check if you installed the Adaptor(video).
4. Check if the scanning ratio of the video screen is set to between 50 Hz ~ 85 Hz.
(Do not exceed 60Hz when using the maximum resolution.)
5. If you have problems in installing the Adaptor (video) driver, boot the computer in Safe Mode, remove the Display Adaptor in the "Control Panel -> System -> Device Administrator" and then reboot the computer to reinstall the Adaptor (video) driver.

Check List



Note

- The following table lists possible problems and their solutions. Before calling for assistance, check the information in this section to see if you can remedy any problems for yourself. If you do need assistance, please call the phone number on the Information section or contact your dealer.
- For more network-related information, refer to the MagicInfo Troubleshooting section.

Problems related to the Installation (PC Mode)



Note

Problems related to the LCD Display installation and their solutions are listed.

Q: The LCD Display screen flickers.

A: Check if the signal cable between the computer and the LCD Display is securely connected.

(Refer to Connecting a Computer)

Problems related to the Screen



Problems related to the LCD Display screen and their solutions are listed.

Q: The screen is blank and the power indicator is off.

A: Ensure that the power cord is firmly connected and the LCD Display is on.

(Refer to the Connecting a Computer)

Q: "**Check Signal Cable**" message.

A: Ensure that the signal cable is firmly connected to the PC or video sources.

(Refer to the Connecting a Computer)

A: Ensure that the PC or video sources are turned on.

Q: "**Not Optimum Mode**" message.

A: Check the maximum resolution and the frequency of the video Adaptor.

A: Compare these values with the data in the Preset Timing Modes Chart.

Q: The picture rolls vertically.

A: Check if the signal cable is securely connected. Re-connect it, if necessary.

(Refer to Connecting a Computer)

Q: The image is not clear; picture is blurred.

A: Run Frequency **Coarse** and **Fine** tuning.

A: Turn on again after removing all accessories (video extension cable, etc.)

A: Set the resolution and frequency to the recommended ranges.

Q: The picture image is unstable and shakes.

A: Check if the resolution and frequency set for the computer video card falls in the range supported by the LCD Display. If not, reset them referring to the current Information under the LCD Display menu and Preset Timing Modes.

Q: Ghost images are shown in the picture.

A: Check if the resolution and frequency set for the computer video card falls in the range supported by the LCD Display. If not, reset them referring to the current Information under the LCD Display menu and Preset Timing Modes.

Q: The image is too light or too dark.

A: Adjust the **brightness** and **contrast**.

(Refer to the **Brightness, Contrast**)

- Q: The screen color is inconsistent.
- A: Adjust color using **Custom** under OSD Color Adjustment menu.
- Q: The color image is distorted by dark shadows.
- A: Adjust color using **Custom** under OSD Color Adjustment menu.
- Q: The color white is poor.
- A: Adjust color using **Custom** under OSD Color Adjustment menu.
- Q: The Power Indicator blinks.
- A: The LCD Display is currently saving the changes made in the settings to the OSD memory.
- Q: The screen is blank and the power indicator light blinks every 0.5 or 1 seconds.
- A: The LCD Display is using its power management system. Press any key on the keyboard.
- Q: The screen is blank and it is blinking.
- A: If you see the "**TEST GOOD**" message on the screen when you pressing the MENU button, check the cable connection between the LCD Display and the computer to ensure that the connector is properly connected.

Problems related to Audio



Problems related to audio signals and their solutions are listed below.

- Q: No sound.
- A: Ensure that the audio cable is firmly connected to both the audio-in port on your LCD Display and the audio-out port on your sound card.
- (Refer to the Connecting a Computer)
- A: Check the volume level.
- Q: The sound level is too low.
- A: Check the volume level.
- A: If the volume is still too low after turning the control to its maximum, check the volume control on the computer sound card or software program.
- Q: The sound is too high or too low.
- A: Adjusts the **Treble** and **Bass** to the appropriate levels.

Problems related to the Remote Control



Problems related to the remote control and their solutions are listed.

- Q: The remote control buttons do not respond.
- A: Check the polarities (+/-) of the batteries.

- A: Check if the batteries are empty.
- A: Check if the power is on.
- A: Check if the power cord is securely connected.
- A: Check if a special fluorescent or neon lamp is on in the vicinity.

Q & A

Q: How can I change the frequency?

A: The frequency can be changed by reconfiguring the video card.



Note

That video card support can vary, depending on the version of the driver used. (Refer to the computer or the video card manual for details.)

Q: How can I adjust the resolution?

A: Windows XP:

Set the resolution in the Control Panel → Appearance and Themes → Display → Settings.

A: Windows ME/2000:

Set the resolution in the Control Panel → Display → Settings.

* Contact the video card manufacturer for details.

Q: How can I set the Power Saving function?

A: Windows XP:

Set the resolution in the Control Panel → Appearance and Themes → Display → Screen Saver.

Set the function in the BIOS-SETUP of the computer. (Refer to the Windows / Computer Manual).

A: Windows ME/2000:

Set the resolution at the Control Panel → Display → Screen Saver.

Set the function in the BIOS-SETUP of the computer. (Refer to the Windows / Computer Manual).

Q: How can I clean the outer case/LCD Panel?

A: Disconnect the power cord and then clean the LCD Display with a soft cloth, using either a cleaning solution or plain water.

Do not leave any detergent or scratches on the case. Do not let any water enter the LCD Display.

Q: How can I play the video?

A: The video supports the MPEG1 and WMV codecs only. Install the corresponding codec to play the video. Note that some of the codecs can be incompatible.

 **Note**

Before calling for assistance, check the information in this section to see if you can remedy any problems yourself. If you do need assistance, please call the phone number on the Information section or contact your dealer.

Specifications

General

General		
Model Name	SyncMaster 400DX-2, 400DXN-2	
	SyncMaster 460DX-2, 460DXN-2	

LCD Panel		
Size	SyncMaster 400DX-2, 400DXN-2	40 " Diagonal (101 cm)
	SyncMaster 460DX-2, 460DXN-2	46 " Diagonal (116 cm)
Display area	SyncMaster 400DX-2, 400DXN-2	885.6 mm (H) x 498.15 mm (V)
	SyncMaster 460DX-2, 460DXN-2	1018.08 mm (H) x 572.67 mm (V)
Pixel Pitch	SyncMaster 400DX-2, 400DXN-2	0.46125 mm (H) x 0.46125 mm (V)
	SyncMaster 460DX-2, 460DXN-2	0.53025 mm (H) x 0.53025 mm (V)

Synchronization	
Horizontal	30 ~ 81 kHz
Vertical	56 ~ 85 Hz

Display Color
16.7 M

Resolution		
Optimum resolution	SyncMaster 400DX-2, 400DXN-2	1920 x 1080 @ 60 Hz
	SyncMaster 460DX-2, 460DXN-2	1920 x 1080 @ 60 Hz
Maximum resolution	SyncMaster 400DX-2, 400DXN-2	1920 x 1080 @ 60 Hz
	SyncMaster 460DX-2, 460DXN-2	1920 x 1080 @ 60 Hz

Input Signal, Terminated

RGB Analog, DVI(Digital Visual Interface) Compliant Digital RGB

0.7 Vp-p ±5 %

Separate H/V sync, Composite, SOG

TTL level (V high ≥ 2.0 V, V low ≤ 0.8 V)

Maximum Pixel Clock

148.5MHz (Analog,Digital)

Power Supply

This product supports 100 - 240 V.

Since the standard voltage may differ from country to country, please check the label on the back of the product.

Signal connectors

D-sub, DVI-D, AV(Composite,CVBS), HDMI, RS232C In/Out, PC Audio(Stereo) In, Audio Out , DVI OUT LAN, USB(3port), VGA OUT (With Network model), Component / BNC (Without Network model)

Dimensions (W x H x D) / Weight

SyncMaster 400DX-2, 400DXN-2	932.0 x 548.0 x 136.0 mm / 36.7 x 21.6 x 5.4 inches (Without Stand) / 23.0 kg / 50.7 lbs (DXn-2), 22.0 kg / 48.5 lbs (DX-2)
	932.0 x 604.0 x 311.0 mm / 36.7 x 23.8 x 12.2 inches (With Stand)

SyncMaster 460DX-2, 460DXN-2	1068.0 x 624.0 x 130.0 mm / 42.0 x 24.6 x 5.1 inches (Without Stand) / 28.0 kg / 61.7 lbs (DXn-2), 27.0 kg / 59.5 lbs (DX-2)
	1068.0 x 681.0 x 311.0 mm / 42.0 x 26.8 x 12.2 inches (With Stand)

VESA Mounting Interface

600 x 400 mm

Environmental considerations

SyncMas- ter 400DXN- 2,	Operating	Temperature : 50°F ~ 104°F (10°C ~ 40°C)
----------------------------------	-----------	--

460DXN- 2	Storage	Humidity : 10 % ~ 80 %, non-condensing
		Temperature : -4°F ~ 113°F (-20°C ~ 45°C)

		Humidity : 5 % ~ 95 %, non-condensing
--	--	---------------------------------------

SyncMas- ter 400DX-2,	Operating	Temperature : 32°F ~ 104°F (0°C ~ 40°C)
-----------------------------	-----------	---

460DX-2	Storage	Humidity : 10 % ~ 80 %, non-condensing
		Temperature : -4°F ~ 113°F (-20°C ~ 45°C)

		Humidity : 5 % ~ 95 %, non-condensing
--	--	---------------------------------------

Plug and Play Capability

This LCD Display can be installed on any Plug & Play compatible system. The interaction of the LCD Display and the computer systems will provide the best operating conditions and LCD Display settings. In most cases, the LCD Display installation will proceed automatically, unless the user wishes to select alternate settings.

Dot Acceptable

TFT-LCD panels manufactured by using advanced semiconductor technology with precision of 1ppm (one millionth) above are used for this product. But the pixels of RED, GREEN, BLUE and WHITE color appear to be bright sometimes or some black pixels may be seen. This is not from bad quality and you can use it without any problems.

For example, the number of TFT-LCD sub pixels contained in this product are 6,220,800.

 **Note**

Design and specifications are subject to change without prior notice.

 **Note**

- DX-2 - Class B Equipment (Information Communication equipment for residential use).
- DXN-2 - Class A Equipment.

PowerSaver

This LCD Display has a built-in power management system called PowerSaver. This system saves energy by switching your LCD Display to low-power mode when it has not been used for a certain amount of time. The LCD Display automatically returns to normal operation when you press a key on the keyboard. For energy conservation, turn your LCD Display OFF when it is not needed, or when leaving it unattended for long periods. The PowerSaver system operates with a VESA DPM compliant video card installed in your computer. Use the software utility installed on your computer to set up this feature.

PowerSaver (When used as a Network monitor)

	State	Normal Operation	Power saving mode	Power off (Power-switch)
	Power Indicator	On	Blinking	Off
Power Consumption	400DXN-2	190 watts	Less than 5 watts	Less than 5 watts
	460DXN-2	250 watts	Less than 5 watts	Less than 5 watts

PowerSaver (When used as a normal monitor)

	State	Normal Operation	Power saving mode	Power off (Power-switch)
	Power Indicator	On	Blinking	Off
Power Consumption	400DX-2	160 watts	Less than 2 watts	Less than 1 watts
	460DX-2	210 watts	Less than 2 watts	Less than 1 watts

Preset Timing Modes

If the signal transferred from the computer is the same as the following Preset Timing Modes, the screen will be adjusted automatically. However, if the signal differs, the screen may go

Specifications

blank while the power LED is on. Refer to the video card manual and adjusts the screen as follows.

Display Mode	Horizontal Frequency (kHz)	Vertical Frequency (Hz)	Pixel Clock (MHz)	Sync Polarity (H/V)
IBM, 640 x 350	31.469	70.086	25.175	+/-
IBM, 640 x 480	31.469	59.940	25.175	-/-
IBM, 720 x 400	31.469	70.087	28.322	-/+
MAC, 640 x 480	35.000	66.667	30.240	-/-
MAC, 832 x 624	49.726	74.551	57.284	-/-
MAC, 1152 x 870	68.681	75.062	100.000	-/-
VESA, 640 x 480	37.861	72.809	31.500	-/-
VESA, 640 x 480	37.500	75.000	31.500	-/-
VESA, 800 x 600	35.156	56.250	36.000	+/+
VESA, 800 x 600	37.879	60.317	40.000	+/+
VESA, 800 x 600	48.077	72.188	50.000	+/+
VESA, 800 x 600	46.875	75.000	49.500	+/+
VESA, 848 x 480	31.020	60.000	33.750	+/+
VESA, 1024 x 768	48.363	60.004	65.000	-/-
VESA, 1024 x 768	56.476	70.069	75.000	-/-
VESA, 1024 x 768	60.023	75.029	78.750	+/+
VESA, 1152 x 864	67.500	75.000	108.000	+/+
VESA, 1280 x 768	47.776	59.870	79.500	-/+
VESA, 1280 x 960	60.000	60.000	108.000	+/+
VESA, 1280 x 1024	63.981	60.020	108.000	+/+
VESA, 1280 x 1024	79.976	75.025	135.000	+/+
VESA, 1360 x 768	47.712	60.015	85.500	+/+
VESA, 1366 x 768	47.712	59.790	85.500	+/+
VESA, 1920 x 1080	66.587	59.934	138.500	+/-
VESA, 1920 x 1080	67.500	60.000	148.500	+/+

Horizontal Frequency

The time to scan one line connecting the right edge to the left edge of the screen horizontally is called the Horizontal Cycle and the inverse number of the Horizontal Cycle is called the Horizontal Frequency. Unit: kHz



Vertical Frequency

Like a fluorescent lamp, the screen has to repeat the same image many times per second to display an image to the user. The frequency of this repetition is called the Vertical Frequency or Refresh Rate. Unit: Hz

Information

For a Better Display

➤ Adjust the computer resolution and screen injection rate (refresh rate) on the computer as described below to enjoy the best picture quality. You can have an uneven picture quality on screen if the best picture quality is not provided for TFT-LCD.

- Resolution: 1920 x 1080
- Vertical frequency (refresh rate): 60 Hz

➤ TFT-LCD panels manufactured by using advanced semiconductor technology with a precision of 1ppm (one millionth) and above is used for this product. But the pixels of RED, GREEN, BLUE and WHITE color seem to be bright sometimes or some of black pixels could be seen. This is not from bad quality and you can use it without any problems.

- For example, the number of TFT-LCD sub pixels contained in this product are 6,220,800.

➤ When cleaning the monitor and the panel outside, please apply a small amount of water to a soft cloth. Rub softly when cleaning the LCD area. If excessive force is applied, you may stain it.

➤ If you are not satisfied with the picture quality, you can get better quality of picture by performing the "**Auto Adjustment** function" in display screen that is appeared as window termination button is pressed. If there's still noise after the automatic adjustment, use the **Fine/Coarse** adjustment function.

➤ When viewing a fixed screen for an extended period of time, a residual image or blurriness may appear. Change the mode to energy save or set a screensaver to move the picture when you need to be away from the monitor for an extended period of time.

PRODUCT INFORMATION (Image Retention Free)

➤ *What is Image Retention ?*

Image retention may not occur when a LCD panel is operated under normal conditions.

Normal conditions are defined as continuously changing video patterns. When the LCD panel is operated for a long time with a fixed pattern (over 12 hours), there may be slight difference in voltage between electrodes that work the liquid crystal (LC) in a pixel. The voltage difference between electrodes increases with time, forcing the liquid crystal to lean. When this occurs, the previous image may be seen when the pattern is changed. To prevent this, the accumulated voltage difference must be decreased.

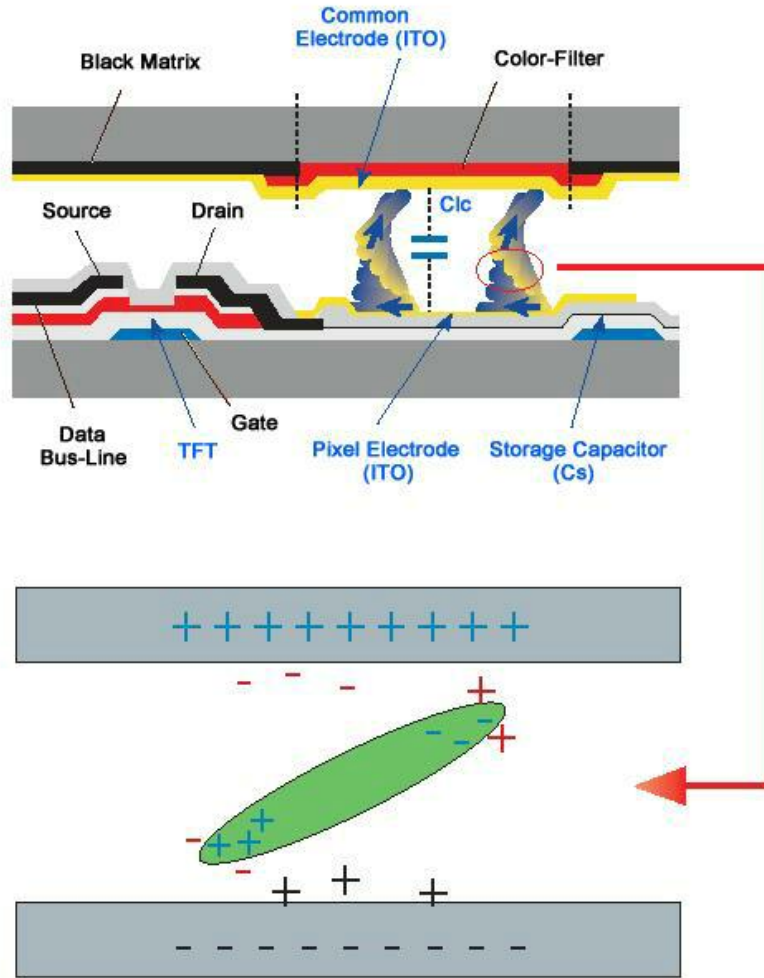

+ *Power Off, Screen Saver, or Power Save Mode*

- Turn the power off for 4 hours after 20 hours in use
- Turn the power off for 2 hours after 12 hours in use
- Set the Monitor to power off with the PC Display Properties Power Scheme.
- Use a Screen saver if possible - Screen saver in one color or a moving image is recommended.

+ *Change the Color Information periodically*

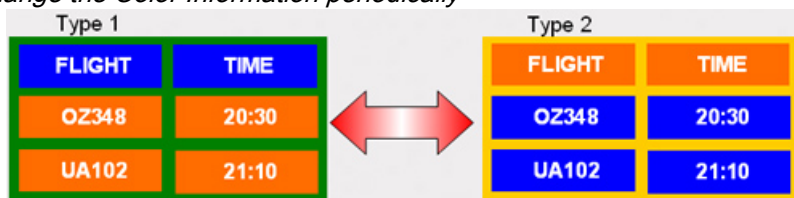

Note

Use Two different colors

Rotate the Color Information with 2 different colors every 30 minutes.

- Avoid using a combination of characters and background color with large difference in luminance.

Avoid using Grey colors, which can cause Image retention easily.

Avoid: Colors with big difference in luminance (Black & White, Grey)



➔ *Change the characters color periodically*

- Use Bright colors with little difference in luminance.
 - Cycle : Change the characters color and background color every 30 minutes



- Every 30 minutes, change the characters with movement.



- Have the images and logo cycle periodically.
 - Cycle: Display moving image together with Logo for 60 seconds after 4 hours in use.
- The best way to protect your monitor from Image retention is to turn the Power off, or set your PC or System to operate a Screen Saver program when you are not using it. If these guidelines are not followed, it may affect your warranty.

➔ *Apply the Screen Scroll function on Product*

- Apply the Screen Scroll function
 - Symptom: Horizontal Bar with Black Color move up and down.



- **Select method**

- Instruction Guide : OSD Menu -> Set Up -> Safety Screen -> Screen Scroll
- Time Interval : 1 ~ 10 hours (Recommend : 1)

- Time Period : 1 ~ 5 seconds (Recommend : 5)
- *Apply the Screen Pixel function on Product*
- Apply the Screen Pixel function
 - Symptom: Dot with Black Color move up and down.



- Select method

- Instruction Guide : OSD Menu -> Set Up -> Safety Screen -> Pixel
- Time Interval : 1 ~ 10 hours (Recommend : 1)
- Time Period : 10 ~ 50 seconds (Recommend : 50)
- Apply the Screen Bar function
 - Symptom: Horizontal / Vertical Bar with Black Color move up and down.



- Select method

- Instruction Guide : OSD Menu -> Set Up -> Safety Screen -> Bar
- Time Interval : 1 ~ 10 hours (Recommend : 1)
- Time Period : 10 ~ 50 seconds (Recommend : 50)
- *Apply the Screen Erasing function on Product*
- Apply the Screen Erasing function
 - Symptom: 2 Vertical blocks move while erasing the display

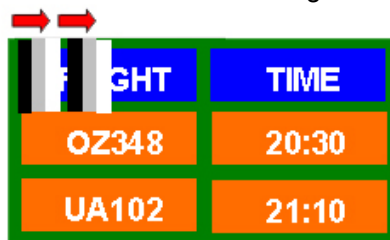

- Select method

- Instruction Guide : OSD Menu -> Set Up -> Safety Screen -> Eraser

Information

- Time Interval : 1 ~ 10 hours (Recommend : 1)
- Time Period : 10 ~ 50 seconds (Recommend : 50)

Appendix

Contact SAMSUNG WORLDWIDE



If you have any questions or comments relating to Samsung products, please contact the SAMSUNG customer care center.

North America

U.S.A	1-800-SAMSUNG(726-7864)	http://www.samsung.com/us
CANADA	1-800-SAMSUNG(726-7864)	http://www.samsung.com/ca
MEXICO	01-800-SAMSUNG (726-7864)	http://www.samsung.com/mx

Latin America

ARGENTINA	0800-333-3733	http://www.samsung.com/ar
BRAZIL	0800-124-421	http://www.samsung.com/br
	4004-0000	
CHILE	800-SAMSUNG(726-7864)	http://www.samsung.com/cl
COLOMBIA	01-8000112112	http://www.samsung.com/co
COSTA RICA	0-800-507-7267	http://www.samsung.com/latin
ECUADOR	1-800-10-7267	http://www.samsung.com/latin
EL SALVADOR	800-6225	http://www.samsung.com/latin
GUATEMALA	1-800-299-0013	http://www.samsung.com/latin
HONDURAS	800-7919267	http://www.samsung.com/latin
JAMAICA	1-800-234-7267	http://www.samsung.com/latin
NICARAGUA	00-1800-5077267	http://www.samsung.com/latin
PANAMA	800-7267	http://www.samsung.com/latin
PUERTO RICO	1-800-682-3180	http://www.samsung.com/latin
REP. DOMINICA	1-800-751-2676	http://www.samsung.com/latin
TRINIDAD & TOBAGO	1-800-SAMSUNG(726-7864)	http://www.samsung.com/latin
VENEZUELA	0-800-100-5303	http://www.samsung.com/latin

Europe

AUSTRIA	0810 - SAMSUNG (7267864, € 0.07/min)	http://www.samsung.com/at
---------	---	---

Appendix

Europe

BELGIUM	02 201 2418		http://www.samsung.com/be (Dutch)
			http://www.samsung.com/be_fr (French)
CZECH REPUBLIC	800 - (800-726786)	SAMSUNG	http://www.samsung.com/cz
	Distributor pro Českou republiku: Samsung Zrt, česká organizační složka, Oasis Florenc, Sokolovská394/17, 180 00, Praha 8		
DENMARK	8 - SAMSUNG (7267864)		http://www.samsung.com/dk
EIRE	0818 717 100		http://www.samsung.com/ie
FINLAND	30 - 6227 515		http://www.samsung.com/fi
FRANCE	01 4863 0000		http://www.samsung.com/fr
GERMANY	01805 - (7267864, € 0.14/Min)	SAMSUNG	http://www.samsung.de
HUNGARY	06-80-SAMSUNG (726-7864)		http://www.samsung.com/hu
ITALIA	800-SAMSUNG (726-7864)		http://www.samsung.com/it
LUXEMBURG	02 261 03 710		http://www.samsung.com/lu
NETHERLANDS	0900-SAMSUNG (0900-7267864) (€ 0,10/Min)		http://www.samsung.com/nl
NORWAY	3 - SAMSUNG (7267864)		http://www.samsung.com/no
POLAND	0 801 1SAMSUNG (172678)		http://www.samsung.com/pl
	022 - 607 - 93 - 33		
PORTUGAL	808 20 - (7267864)	SAMSUNG	http://www.samsung.com/pt
SLOVAKIA	0800-SAMSUNG (726-7864)		http://www.samsung.com/sk
SPAIN	902 - 1 - SAMSUNG(902 172 678)		http://www.samsung.com/es
SWEDEN	0771 726 7864 (SAMSUNG)		http://www.samsung.com/se
SWITZERLAND	0848 - SAMSUNG (7267864, CHF 0.08/min)		http://www.samsung.com/ch
U.K	0845 SAMSUNG (7267864)		http://www.samsung.com/uk

CIS

BELARUS	810-800-500-55-500		
ESTONIA	800-7267		http://www.samsung.com/ee
LATVIA	8000-7267		http://www.samsung.com/lv
LITHUANIA	8-800-77777		http://www.samsung.com/lt
MOLDOVA	00-800-500-55-500		
KAZAKHSTAN	8-10-800-500-55-500		http://www.samsung.com/kz_ru
KYRGYZSTAN	00-800-500-55-500		
RUSSIA	8-800-555-55-55		http://www.samsung.ru
TADJIKISTAN	8-10-800-500-55-500		
UKRAINE	8-800-502-0000		http://www.samsung.com/ua

CIS

		http://www.samsung.com/ua_ru
UZBEKISTAN	8-10-800-500-55-500	http://www.samsung.com/kz_ru

Asia Pacific

AUSTRALIA	1300 362 603	http://www.samsung.com/au
CHINA	400-810-5858	http://www.samsung.com/cn
	010-6475 1880	
HONG KONG	3698 - 4698	http://www.samsung.com/hk
		http://www.samsung.com/hk_en/
INDIA	3030 8282	http://www.samsung.com/in
	1-800-3000-8282	
	1800 110011	
INDONESIA	0800-112-8888	http://www.samsung.com/id
JAPAN	0120-327-527	http://www.samsung.com/jp
MALAYSIA	1800-88-9999	http://www.samsung.com/my
NEW ZEALAND	0800 SAMSUNG(0800 726 786)	http://www.samsung.com/nz
PHILIPPINES	1-800-10-SAMSUNG (726-7864)	http://www.samsung.com/ph
	1-800-3-SAMSUNG (726-7864)	
	1-800-8-SAMSUNG (726-7864)	
	02-5805777	
SINGAPORE	1800-SAMSUNG(726-7864)	http://www.samsung.com/sg
THAILAND	1800-29-3232, 02-689-3232	http://www.samsung.com/th
TAIWAN	0800-329-999	http://www.samsung.com/tw
VIETNAM	1 800 588 889	http://www.samsung.com/vn

Middle East & Africa

SOUTH AFRICA	0860-SAMSUNG(726-7864)	http://www.samsung.com/za
TURKEY	444 77 11	http://www.samsung.com/tr
U.A.E	800-SAMSUNG(726-7864)	http://www.samsung.com/ae
	8000-4726	

Terms

Dot Pitch	The image on a monitor is composed of red, green and blue dots. The closer the dots, the higher the resolution. The distance between two dots of the same color is called the 'Dot Pitch'. Unit: mm
-----------	---

Vertical Frequency	<p>The screen must be redrawn several times per second in order to create and display an image for the user. The frequency of this repetition per second is called the Vertical Frequency or Refresh Rate. Unit: Hz</p> <p>Example: If the same light repeats itself 60 times per second, this is regarded as 60 Hz.</p>
Horizontal Frequency	<p>The time to scan one line connecting the right edge to the left edge of the screen horizontally is called the Horizontal Cycle. The inverse number of the Horizontal Cycle is called Horizontal Frequency. Unit: kHz</p>
Interlace and Non-Interlace Methods	<p>Showing the horizontal lines of the screen from the top to the bottom sequentially is called the Non-Interlace method while showing odd lines and then even lines in turn is called the Interlace method. The Non-Interlace method is used for the majority of monitors to ensure a clear image. The Interlace method is the same as that used in TVs.</p>
Plug & Play	<p>This is a function that provides the best quality screen for the user by allowing the computer and the monitor to exchange information automatically. This monitor follows the international standard VESA DDC for the Plug & Play function.</p>
Resolution	<p>The number of horizontal and vertical dots used to compose the screen image is called the 'resolution'. This number shows the accuracy of the display. A high resolution is good for performing multiple tasks as more image information can be shown on the screen.</p> <p>Example: If the resolution is 1920 x 1080, this means the screen is composed of 1920 horizontal dots (horizontal resolution) and 1080 vertical lines (vertical resolution).</p>

Correct Disposal

Correct Disposal of This Product (Waste Electrical & Electronic Equipment) - Europe only



(Applicable in the European Union and other European countries with separate collection systems)

This marking on the product, accessories or literature indicates that the product and its electronic accessories (e.g. charger, headset, USB cable) should not be disposed of with other household waste at the end of their working life. To prevent possible harm to the environment or human health from uncontrolled waste disposal, please separate these items from other types of waste and recycle them responsibly to promote the sustainable reuse of material resources.

Household users should contact either the retailer where they purchased this product, or their local government office, for details of where and how they can take these items for environmentally safe recycling.

Business users should contact their supplier and check the terms and conditions of the purchase contract. This product and its electronic accessories should not be mixed with other commercial wastes for disposal.

Correct disposal of batteries in this product - Europe only



(Applicable in the European Union and other European countries with separate battery return systems.)

This marking on the battery, manual or packaging indicates that the batteries in this product should not be disposed of with other household waste at the end of their working life. Where marked, the chemical symbols Hg, Cd or Pb indicate that the battery contains mercury, cadmium or lead above the reference levels in EC Directive 2006/66. If batteries are not properly disposed of, these substances can cause harm to human health or the environment.

To protect natural resources and to promote material reuse, please separate batteries from other types of waste and recycle them through your local, free battery return system.



Note

The rechargeable battery incorporated in this product is not user replaceable. For information on its replacement, please contact your service provider.

Authority

Information in this document is subject to change without notice.

© 2009 Samsung Electronics Co., Ltd. All rights reserved.

Reproduction in any manner whatsoever without the written permission of Samsung Electronics Co., Ltd. is strictly forbidden.

Samsung Electronics Co., Ltd. shall not be liable for errors contained herein or for incidental or consequential damages in connection with the furnishing, performance, or use of this material.

Samsung is the registered trademark of Samsung Electronics Co., Ltd.; Microsoft, Windows and Windows NT are registered trademarks of Microsoft Corporation; VESA, DPM and DDC are registered trademarks of Video Electronics Standard Association; the ENERGY STAR® name and logo are registered trademarks of the U.S. Environmental Protection Agency (EPA). All other product names mentioned herein may be the trademarks or registered trademarks of their respective owners.



TruSurround XT, SRS and (●) Symbol are trademarks of SRS Labs, Inc.
TruSurround XT technology is incorporated under license from SRS Labs, Inc.

CALIFORNIA USA ONLY (Applicable for networking models only.)

This Perchlorate warning applies only to primary CR(Manganese Dioxide) Lithium coin cells in the product sold or distributed ONLY in California USA

*Perchlorate Material - special handling may apply,
See www.dtsc.ca.gov/hazardouswaste/perchlorate.*

Free Manuals Download Website

<http://myh66.com>

<http://usermanuals.us>

<http://www.somanuals.com>

<http://www.4manuals.cc>

<http://www.manual-lib.com>

<http://www.404manual.com>

<http://www.luxmanual.com>

<http://aubethermostatmanual.com>

Golf course search by state

<http://golfingnear.com>

Email search by domain

<http://emailbydomain.com>

Auto manuals search

<http://auto.somanuals.com>

TV manuals search

<http://tv.somanuals.com>