



PDP-TELEVISION (PLASMA DISPLAY PANEL)

Owner's Instructions

Before operating the unit,
please read this manual thoroughly,
and retain it for future reference.

ON-SCREEN MENUS
PICTURE IN PICTURE (PIP)
TELETEXT / TELEWEB (OPTION)



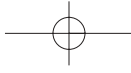

User Instructions

ENG

◆ **Screen Image retention**

Do not display a still image (such as on a video game or when hooking up a PC to this PDP) on the plasma monitor panel for more than 2 hours as it can cause screen image retention. This image retention is also known as "screen burn". To avoid such image retention, reduce the degree of brightness and contrast of this screen when displaying a still image.

◆ **Cell Defect**

The plasma display panel consists of fine cells. Although the panels are produced with more than 99.9 percent active cells, there may be some cells that do not produce light or remain lit.

◆ **Height**





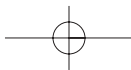

The PDP can normally operate only under 2000m in height. It might abnormally function at a place over 2000m in height and do not install and operate there.

◆ **Warranty**

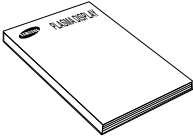
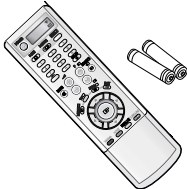
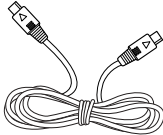
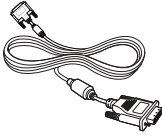
- Warranty does not cover any damage caused by image retention.
- Burn-in is not covered by the warranty.

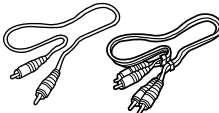
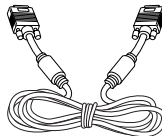

Checking Parts

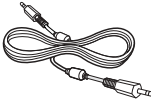
		Sold Separately	
Owner's Instructions	Remote Control/ AAA Batteries		
		S-VIDEO Cable	DVI Cable
			
Ferrite Core for Speaker Wire	Ferrite Core for Side AV Cable	Component Cables (RCA)	PC Cable
			
Power Cord	Antenna Cable	Scart Cable	PC Audio Cable

Ferrite Cores

The ferrite cores are used to attenuate undesired signals. When connecting cables, attach one of these ferrite cores to the cable near the connector.

When you connect Side AV cable to the S-VIDEO2/AV3, first bind Side AV Cable round the ferrite core to secure it.

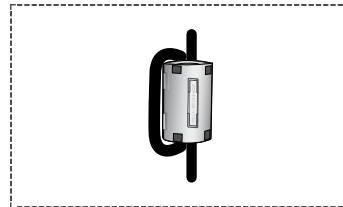

DNie™ (Digital Natural Image engine) DNie™

This feature bring you more detailed image with 3D noise reduction, detail enhancement, contrast enhancement and white enhancement. New image compensation Algorithm gives brighter, clearer, much detailed image to you. DNie™ technology will fit every signals into your eyes.

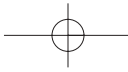

Contents

- ◆ **FOREWORD**
 - User Instructions..... 2
- ◆ **CONNECTING AND PREPARING YOUR DISPLAY**
 - Your New Plasma Display Panel..... 6
 - Infrared Remote Control..... 8
 - Inserting the Batteries in the Remote Control..... 9
 - Assembling the Stand-Base 9
 - Installing the Display on the Wall Attachment Panel 10
 - Connecting to an Aerial or Cable Television Network 12
 - Connecting a Satellite Receiver or Decoder..... 12
 - Switching On and Off..... 13
 - Placing in Standby Mode..... 13
 - Becoming Familiar with the Remote Control 14
 - Setting Up Your Remote Control..... 15
 - Plug & Play Feature..... 16
 - Choosing Your Language..... 17
- ◆ **SETTING THE CHANNELS**
 - Storing Channels Automatically..... 18
 - Storing Channels Manually..... 19
 - Skipping Unwanted Channels 21
 - Sorting the Stored Channels 22
 - Assigning Names to Channels 23
 - Using the LNA (Low Noise Amplifier) Feature..... 24
 - Activating the Child Lock 25
 - Displaying Information 26
- ◆ **USING YOUR DISPLAY (continued)**
 - Changing the Picture Standard 26
 - Adjusting the Picture Settings..... 27
 - Adjusting the Picture Settings (PC or DVI Mode) 28
 - Setting the Picture (PC Mode)..... 29
 - Using the Fine Tune 31
 - Viewing the Channel Scan Picture 32
 - Freezing the Current Picture 32
 - Selecting the Picture Size..... 33
 - Selecting the Film Mode..... 34
 - DNie™ (Digital Natural Image engine **DNie**) 34
 - Setting the Blue Screen..... 35
 - Setting the Melody Sound 35
 - Viewing the Picture In Picture (PIP) 36
 - Using the Digital NR (Digital Noise Reduction) Feature..... 38
 - Changing the Sound Standard 39

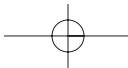

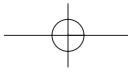

Contents (continued)

- ◆ **USING YOUR DISPLAY**
 - Adjusting the Sound Settings 40
 - Adjusting the Volume Automatically 40
 - Setting the TruSurround XT..... 41
 - Selecting the Internal mute..... 41
 - Selecting the Sound Mode (depending on the model) 42
 - Setting the Sleep Timer..... 43
 - Setting and Displaying the Current Time..... 44
 - Switching the Television On and Off Automatically 45
 - Viewing an External Signal Source 46
 - Redirecting an Input to the External Output 47

- ◆ **USING THE TELETEXT FEATURE**
 - Teletext Feature 48
 - Displaying the Teletext Information 49
 - Selecting Display Options..... 50
 - Selecting a Teletext Page..... 51

- ◆ **USING THE TELEWEB FEATURE (OPTION)**
 - TeleWeb Feature..... 52
 - Using the TeleWeb Menu after Displaying the TeleWeb..... 53
 - Easy Accessing the TeleWeb Service via the Remote Control..... 54

- ◆ **ADDITIONAL INFORMATION AND CONNECTIONS**
 - Connecting to the External Devices 55
 - Connecting to the S-Video Input..... 56
 - Connecting to the DVI Input 57
 - Connecting to the PC Input 57
 - Connecting to the Component Input..... 58
 - Connecting Additional Speakers 58
 - Connecting and Using the Home Theater System 59
 - Installing the Speakers 60
 - Setting up Your PC Software (Windows only)..... 62
 - Input Mode (PC/DVI) 63
 - Pin Configurations 64

- ◆ **RECOMMENDATIONS FOR USE**
 - Troubleshooting: Before Contacting Service Personnel..... 65
 - Programming the Remote Control for Other Components 66

Symbols



Press



Important



Note



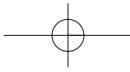

Your New Plasma Display Panel

ENG

➤ The actual configuration on your PDP may be different, depending on your model.

Front Panel

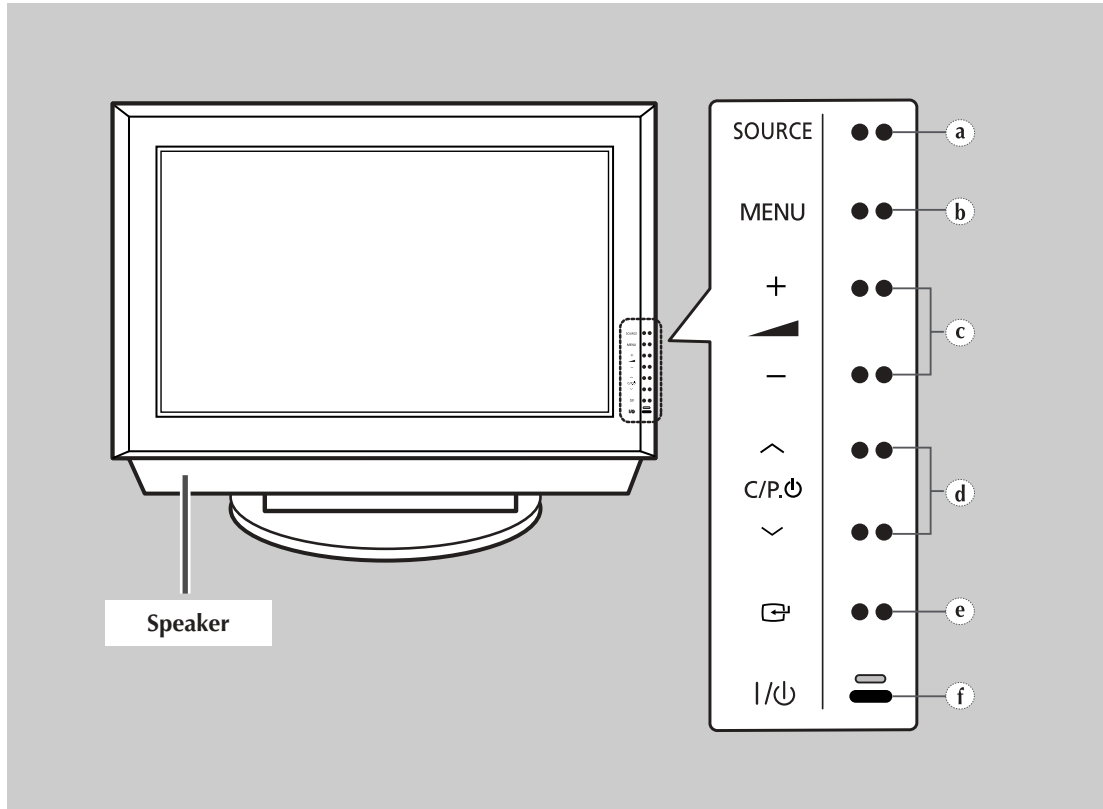

- a) **SOURCE**
External input selection.
- b) **MENU**
Menu display.
- c) **- ▲ +**
Volume adjustment.
- d) **▼ C/P. ⏻ ▲**
Channel selection. Auto power On.
- e) **📦**
Confirm your choice (Store or Enter)
- f) **I / ⏻**
Press to turn the PDP on and off.

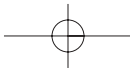

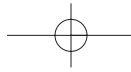

Your New Plasma Display Panel (continued)

- The actual configuration on your PDP may be different, depending on your model.

ENG

Side of the TV

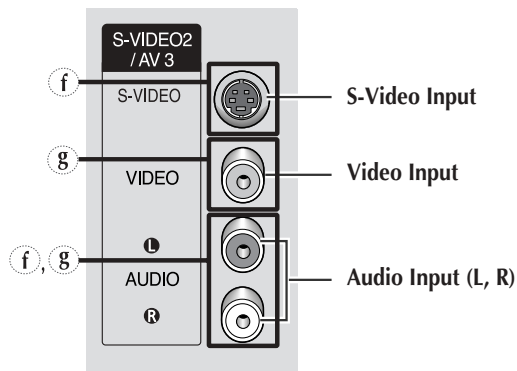

Rear Panel

- For further details about connection, refer to pages 55~59.

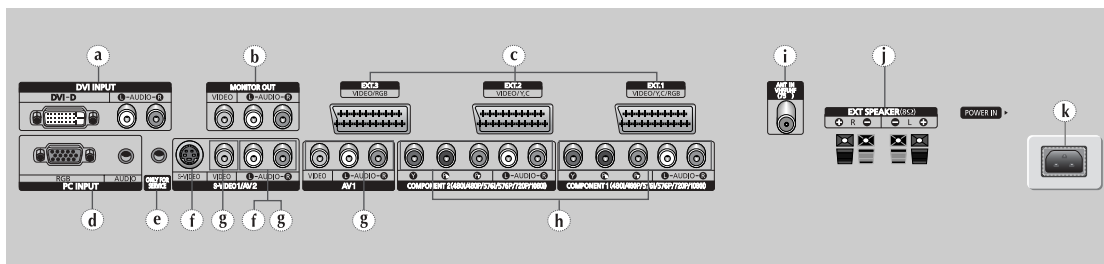

- a) **DVI INPUT (DVI-D / L-AUDIO-R)**
Connect to the digital video and audio output jack for device with DVI output.
- b) **MONITOR OUT (VIDEO / L-AUDIO-R)**
Outputs for external devices.
- c) **Ext.1, Ext.2, Ext.3**
Inputs or outputs for external devices, such as VCR, DVD, video game device or video disc players.
- d) **PC INPUT (RGB IN / AUDIO)**
Connect to the video and audio output jack on your PC.
- e) **ONLY FOR SERVICE**
Connector for service only.
- f) **AV2, AV3 (S-VIDEO1 or S-VIDEO2 / L-AUDIO-R)**
Video and audio inputs for external devices with an S-Video output, such as a camcorder or VCR.
- g) **AV1, AV2, AV3 (VIDEO / L-AUDIO-R)**
Video and audio inputs for external devices, such as a camcorder or VCR.
- h) **COMPONENT1, COMPONENT2**
Video (Y/Pb/Pr) and audio (L-AUDIO-R) inputs for Component.
- i) **ANT IN VHF/UHF (75Ω)**
75Ω Coaxial connector for Aerial/Cable Network.
- j) **EXT SPEAKER (8Ω)**
Connectors for external rear speakers.
- k) **POWER IN**
Connect the supplied power cord.



Infrared Remote Control

ENG

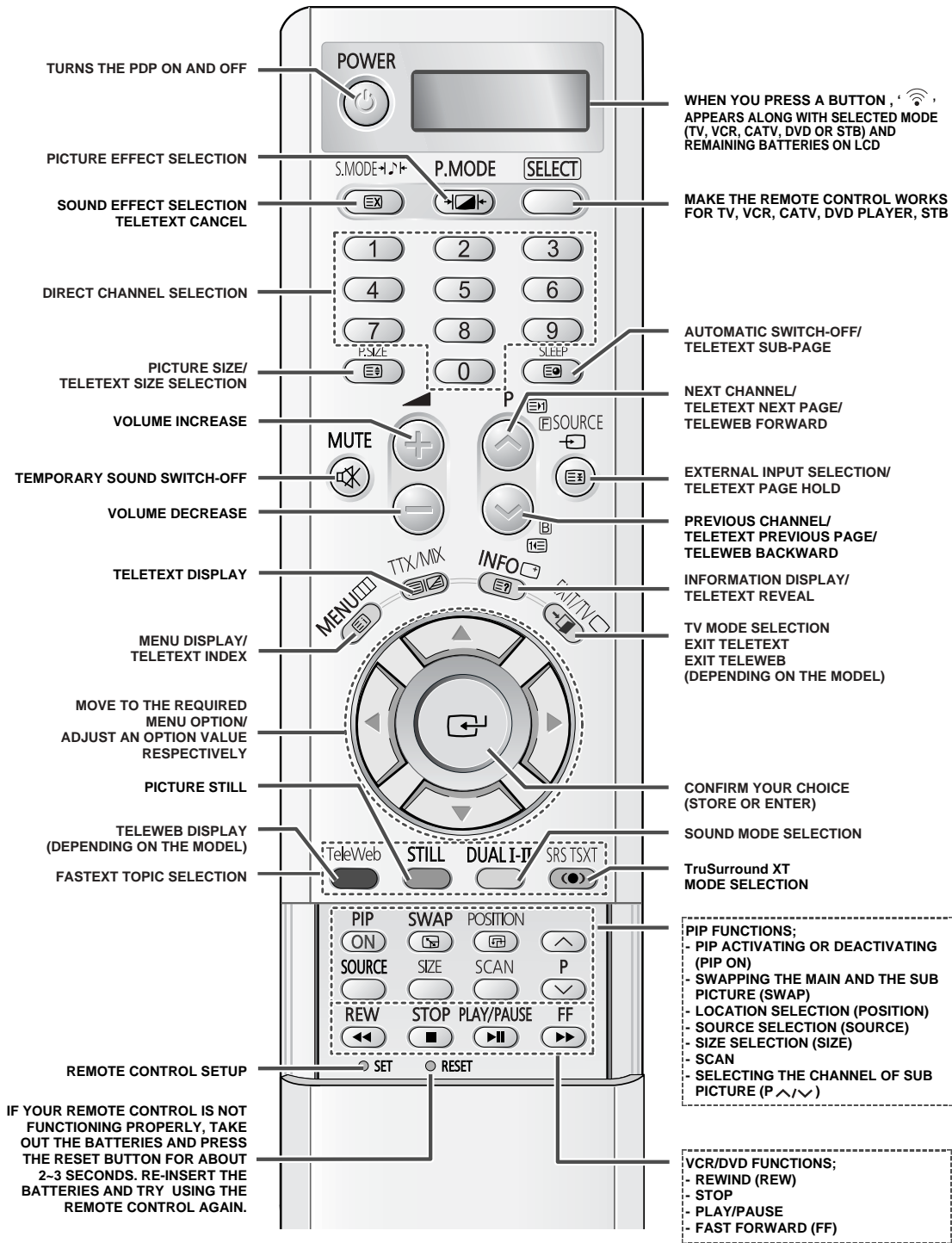

IF YOUR REMOTE CONTROL IS NOT FUNCTIONING PROPERLY, TAKE OUT THE BATTERIES AND PRESS THE RESET BUTTON FOR ABOUT 2-3 SECONDS. RE-INSERT THE BATTERIES AND TRY USING THE REMOTE CONTROL AGAIN.

➤ The performance of the remote control may be affected by bright light.

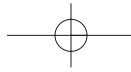

Inserting the Batteries in the Remote Control

You must insert or replace the batteries in the remote control when you:

- ◆ Purchase the PDP
- ◆ Find that the remote control is no longer operating correctly

- 1 Remove the cover on the rear of the remote control by pressing the symbol (▼) downwards and then pulling firmly to remove it.
- 2 Insert two R03, UM4, "AAA" 1.5V or equivalent batteries taking care to respect the polarities:
 - ◆ - on the battery against - on the remote control
 - ◆ + on the battery against + on the remote control
- 3 Replace the cover by aligning it with the base of the remote control and pressing it back into place.

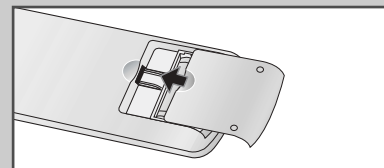
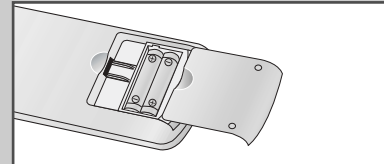
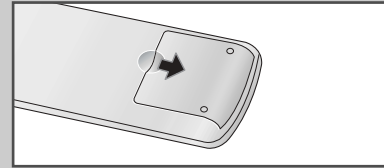

ENG

Assembling the Stand-Base

- 1 Assemble two support pins with the stand base and firmly secure both sides of the support pins using 8 screws provided.
- 2 Assemble the PDP with the stand and firmly secure the PDP using 4 screws provided.

- ◆ Two or more people should carry the PDP. Never lay the PDP on the floor because of possible damage to the screen. Always store the PDP upright.

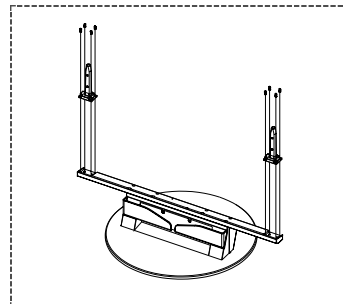

(depending on your model)

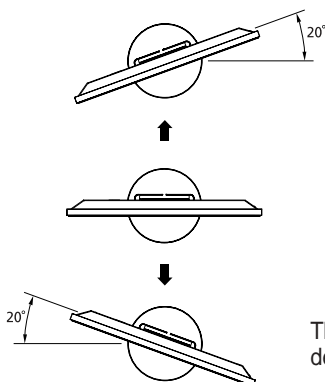

The angle of the PDP can be up to 20 degrees left/right.

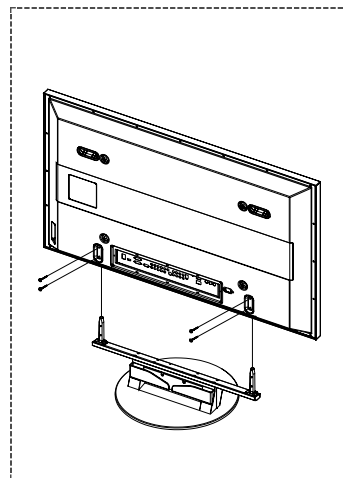

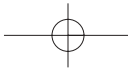



ENG

Installing the Display on the Wall Attachment Panel

Installation Notes

- ◆ Do not install the PDP on any place other than vertical walls.
- ◆ To protect the performance of the PDP and prevent troubles, avoid the followings:
 - Do not install next to smoke and fire detectors.
 - Do not install in an area subjected to vibration or high voltage.
 - Do not install near or around any heating apparatus.
- ◆ Use only recommended parts and components.

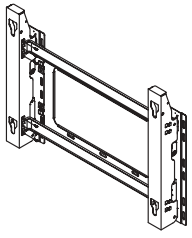
Mounting Kits

Wall Mount Bracket	Plastic Hanger	Screws
	 4 EA	 4 EA

How to Adjust Mounting Angle

(depending on your model)

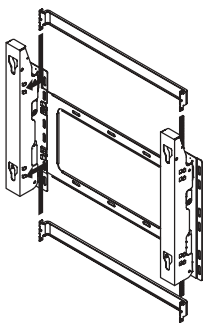

The wall mount bracket is delivered separately. Please tighten the captive screw in the direction of the arrow after assembling the bracket.

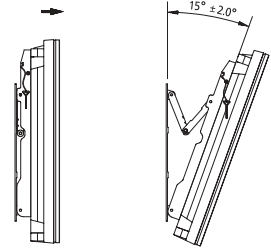

- 1 Secure the PDP to the wall mount bracket. (Please refer to the following instructions.)
- 2 Set the angle by pulling the upper end of the PDP attached to bracket in the direction of the arrow.
- 3 The angle can be adjusted from 0° to 15° by ±2°.

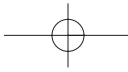

Installing the Display on the Wall Attachment Panel (continued)

ENG

➤ The exterior of the PDP may be different than the picture. (Assembly and installation of the plastic hanger is the same.)

- 1** Remove the screws from the back of the PDP. **2** Use the screws and assemble the plastic hanger.

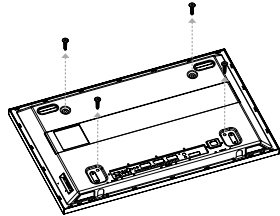

- ◆ Please ask the installers to install the wall mount bracket.
- ◆ Please be sure to check if the plastic hanger is completely secured on both the left and right side after hanging the PDP on the wall mount bracket.
- ◆ Please avoid catching your fingers while installing and adjusting the angle.
- ◆ Please tightly secure the wall mount bracket to the wall to avoid injury from a falling PDP.

- 3** Tighten the screws of the plastic hanger to the back side of the PDP.

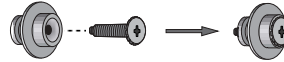
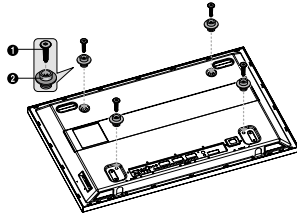

- 4** Put the 4 pegs on the PDP in the grooves of the wall mount bracket and pull down on the PDP (1) to secure it to the wall mount bracket (2). Tighten the screws as shown (3) so that the PDP cannot be separated from wall mount bracket.

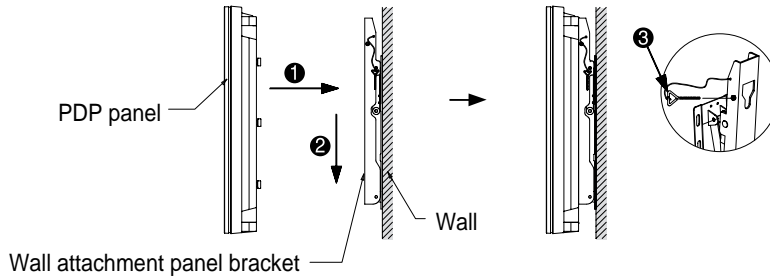

Connecting External Devices to the PDP

◆ To connect external devices such as a DVD or a Home Theater System to the PDP, please refer to following instructions:

- 1** Be sure to remove the safety pins underneath the PDP.
- ◆ If the safety pins are not removed, the angle cannot be adjusted. Any attempt to do so may cause damage to the PDP.
- 2** Pull out the bottom of the PDP (which has been attached to the Wall Mount Bracket) in the direction indicated by the arrows (refer to the illustration) until it clicks.
- ◆ Using the PDP After Connecting External Devices. Be sure to secure the PDP by inserting the 2 safety pins after readjusting the angle of the PDP to 0°.
 - ◆ For safety, be sure to secure the PDP using the safety pins. If the safety pins are not used, the PDP may fall, causing serious injury.

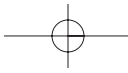
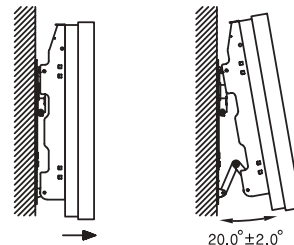

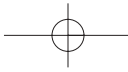

ENG

Connecting to an Aerial or Cable Television Network

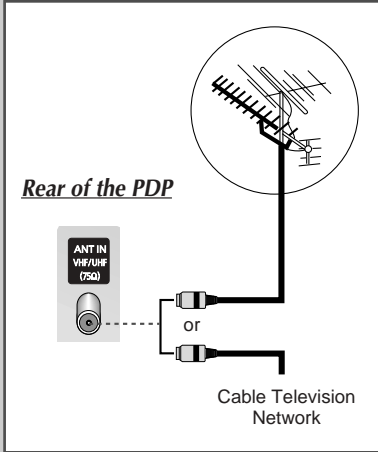

To view television channels correctly, a signal must be received by the set from one of the following sources:

- ◆ An outdoor aerial
- ◆ A cable television network
- ◆ A satellite network

- 1 In the first three cases, connect the aerial or network input cable to the 75Ω coaxial socket on the rear of the PDP.
- 2 If you are using an indoor aerial, you may need to turn it when tuning your PDP until you obtain a picture that is both sharp and clear.
For further details, refer to:
 - ◆ "Storing Channels Automatically" on page 18
 - ◆ "Storing Channels Manually" on page 19

➤ When installing or re-installing your PDP, be sure to use the supplied coaxial antenna cable. If you connect using a different coaxial cable, there is risk of noise or interference to the screen image. (You must not use another general purpose cable. Use the 3M/5M/7M cable supplied by Samsung.)

Connecting a Satellite Receiver or Decoder

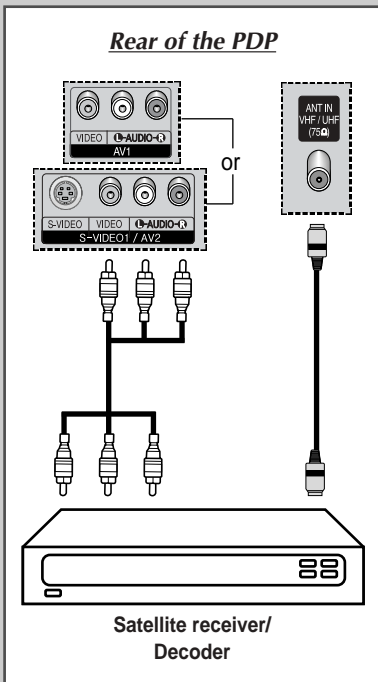

In order to watch television programmes broadcast via a satellite network, you must connect a satellite receiver to the rear of the PDP. Also, in order to descramble a coded transmission signal, you must connect a decoder to the rear of the PDP.

Using a Coaxial cable

- Connect a coaxial cable to the:
- ◆ Receiver (or Decoder) output socket.
 - ◆ Television aerial input socket.

➤ If you wish to connect both a satellite receiver (or decoder) and a VCR, you should connect the:

- ◆ Receiver (or Decoder) to the VCR
- ◆ VCR to the PDP

Otherwise, connect the receiver (or decoder) directly to the PDP.

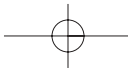

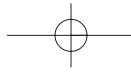

Switching On and Off

The mains lead is attached to the rear of your PDP.

- 1 Plug the mains lead into an appropriate socket.
Result: The Standby indicator on the front of the PDP lights up.
 ➤ The main voltage is indicated on the rear of the PDP and the frequency is 50 or 60Hz.
- 2 Press the “**I / ⏻**” button on the front of the PDP (or **POWER** (⏻) button on the remote control) to switch the PDP on.
Result: The programme that you were watching last is re-selected automatically.
 ➤ If you have not yet stored any channels, No clear picture appears. Refer to “Storing Channels Automatically” on page 18 or “Storing Channels Manually” on page 19.
- 3 To switch your PDP off, press the “**I / ⏻**” button again.

Front of the PDP

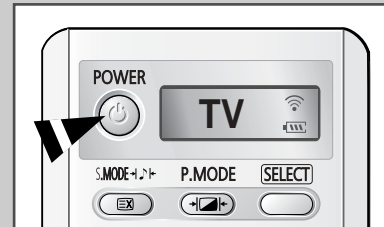
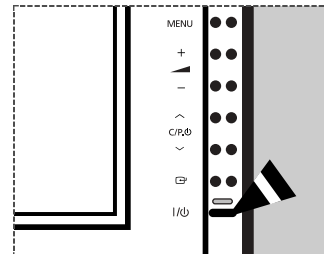

ENG

Placing in Standby Mode

Your PDP can be placed in Standby mode, in order to reduce the Power consumption.

The Standby mode can be useful when you wish to interrupt viewing temporarily (during a meal, for example).

- 1 Press the **POWER** (⏻) button on the remote control.
Result: The screen is turned off and the Standby indicator on the front of the PDP lights.
- 2 To switch the PDP back on, simply press the **POWER** (⏻) button again or a numeric button.
 ➤ You can also switch on by pressing the **P** (⏻) or (⏻) button.

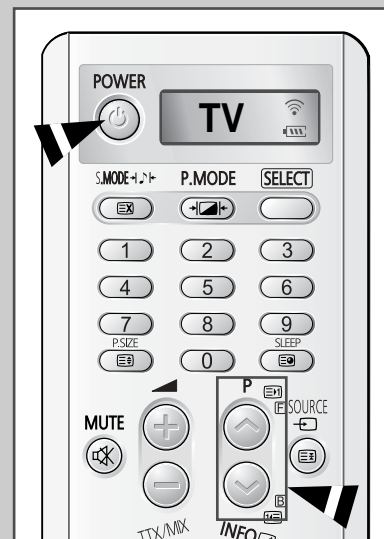

Becoming Familiar with the Remote Control

ENG

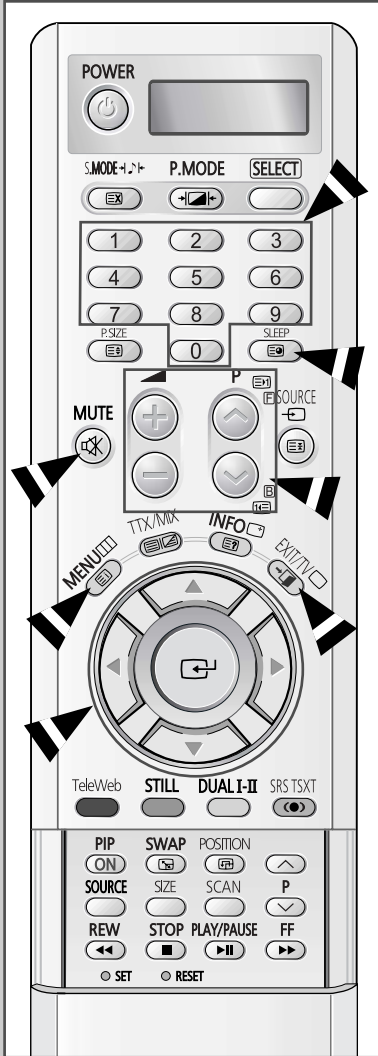

The remote control is used mainly to:

- ◆ Change channels and adjust the volume
- ◆ Display the on-screen menu system

The following table presents the most frequently used buttons and their functions.

Button	Viewing Function	Menu Function
	Used to display the next stored channel.	-
	Used to display the previous stored channel.	-
0 to 9	Used to display the corresponding channels. ➤ For double digit channels, the second digit must be pushed immediately after the first. Failure to do this will result in a single digit channel being displayed.	-
SLEEP 	Used to select a preset time interval (off - 30 - 60 - 90 - 120 - 150 - 180).	-
	Used to increase the volume.	-
	Used to decrease the volume.	-
MUTE 	Used to switch the sound off temporarily. ➤ To turn the sound back on, press this button again, or press the or button.	-
MENU 	Used to display the on-screen menu system.	Used to return to the previous menu or normal viewing.
	-	Used to: ◆ Display a submenu containing selections for the current menu option ◆ Increase/decrease a menu option value
	-	Used to confirm your choice.
EXIT/TV 	-	Used to exit from the menu system and return to normal viewing directly.

Setting Up Your Remote Control

This PDP's remote control can operate VCR, CATV, DVD, or Set-top box (STB), in addition to controlling the PDP.

➤ *The remote control is not compatible with the TV manufactured by another company.*

- 1 Turn off your VCR, Cable box, DVD or STB.
- 2 Press the **SELECT** button. Mode is changed whenever **SELECT** button is pressed.
- 3 Press the **POWER** (⏻) button on the remote control. The component you select should turn on. If it turns on, your remote control is now set correctly.
- 4 Once your remote control is set up, press the **SELECT** button any time you want to use the remote control to operate your VCR, Cable box, DVD or STB.

➤ When your remote control is in the **VCR, CATV, DVD** or **STB** mode, the volume buttons still control your television's volume.

- To program the cable receiver controls:
- ◆ Press the **SELECT** button to select **CATV**.
 - ◆ Point the remote control at the cable receiver and press the **SET** button. Then press the company code number(s) for the component in page 66.
Ex) If the component is manufactured by Oak, press 026.
- To program the **VCR** controls:
- ◆ Press the **SELECT** button to select **VCR**
 - ◆ Point the remote control at the **VCR** and press the **SET** button. Then press the company code number(s) for the component in page 67.
- To program the **DVD** controls:
- ◆ Press the **SELECT** button to select **DVD**
 - ◆ Point the remote control at the **DVD** and press the **SET** button. Then press the company code number(s) for the component in page 66.

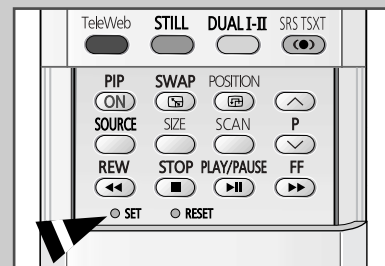
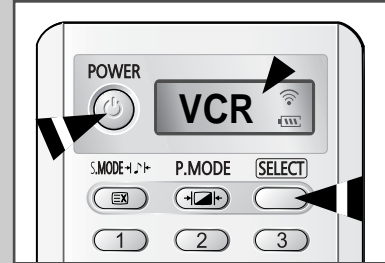

ENG

Plug & Play Feature

ENG

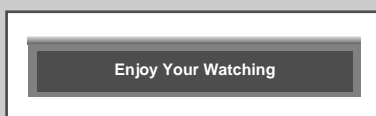
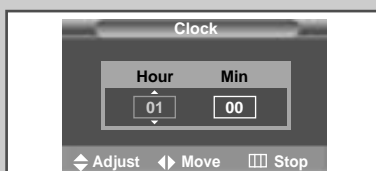
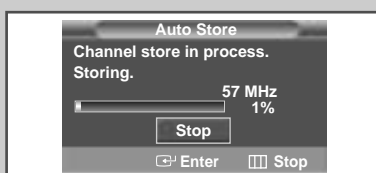
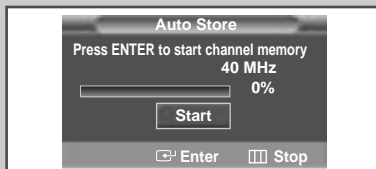
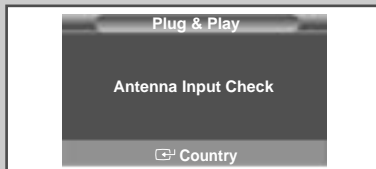

16

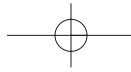

When the television is initially powered ON, several basic customer settings proceed automatically and subsequently. The following settings are available.

- 1 If the television is in Standby mode, press the **POWER** (⏻) button on the remote control.
Result: The message **Plug & Play** is displayed. It flickers for a little while, and then the **Language** menu is automatically displayed.
- 2 Select the appropriate language by pressing the **▼** or **▲** button.
- 3 Press the **ENTER** (↵) button to confirm your choice.
Result: The message **Antenna Input Check** is displayed.
- 4 Make sure that the antenna is connected to the TV, and then press the **ENTER** (↵) button.
Result: The **Country** menu is displayed.
- 5 Select your country by pressing the **▼** or **▲** button.
- 6 Press the **ENTER** (↵) button to confirm your choice.
Result: The **Auto Store** menu is displayed.
- 7 To start the search, press the **ENTER** (↵) button.
Result: The search will end automatically. Channels are sorted and stored in an order which reflects their position in the frequency range (with lowest first and highest last). When it has finished, the **Clock Set** menu is displayed.
 - To stop the search before it has finished or return to normal viewing, press the **MENU** (⏏) button.
 - Press the **ENTER** (↵) button to set the clock.
- 8 Press the **◀** or **▶** button to move to the hour or minute. Set the hour or minute by pressing the **▼** or **▲** button.
- 9 When it has finished, the message **Enjoy Your Watching** is displayed, and then the channel which has been stored will be activated.



Plug & Play Feature (continued)

If you want to reset this feature...



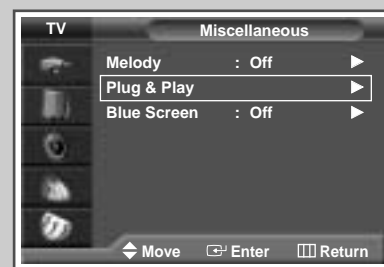
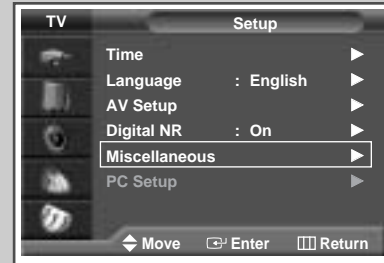

- 1 Press the **MENU** button.
Result: The main menu is displayed.
- 2 Press the **▼** or **▲** button to select **Setup**.
Result: The options available in the **Setup** group are displayed.
- 3 Press the **ENTER** () button.
- 4 Press the **▼** or **▲** button to select **Miscellaneous**. Press the **ENTER** () button.
Result: The options available in the **Miscellaneous** group are displayed.
- 5 Press the **▼** or **▲** button to select **Plug & Play**. Press the **ENTER** () button.
Result: The message **Plug & Play** is displayed.
- 6 For further details on how to set, refer to the opposite page.



ENG

Choosing Your Language

When you start using your television for the first time, you must select the language which will be used for displaying menus and indications.

- 1 Press the **MENU** button.
Result: The main menu is displayed.
- 2 Press the **▼** or **▲** button to select **Setup**.
Result: The options available in the **Setup** group are displayed.
- 3 Press the **ENTER** () button
- 4 Press the **▼** or **▲** button to select **Language**. Press the **ENTER** () button.
Result: The languages available are listed.
- 5 Select the appropriate language by pressing the **▼** or **▲** button.
- 6 Press the **ENTER** () button to confirm your choice.
- 7 When you are satisfied with your choice, press the **EXIT/TV** () button to return to normal viewing.

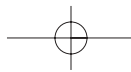
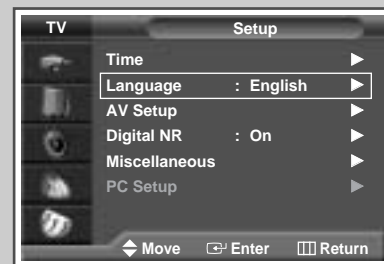

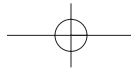

Storing Channels Automatically

ENG

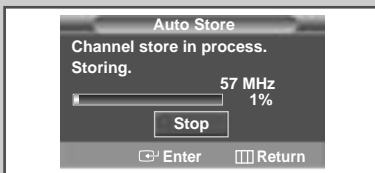

You can scan for the frequency ranges available to you, (availability depends on your country). Automatically allocated programme numbers may not correspond to actual or desired programme numbers. However you can sort numbers manually and clear any channels you do not wish to watch.

- 1 Press the **MENU** button.
Result: The main menu is displayed.
- 2 Press the **▼** or **▲** button to select **Channel1**.
Result: The options available in the **Channel1** group are displayed.
- 3 Press the **ENTER** (**↵**) button.
- 4 Press the **▼** or **▲** button to select **Country**. Press the **ENTER** (**↵**) button.
Result: The countries available are listed.
- 5 Select your country (or area) by pressing the **▼** or **▲** button.
 - If you have selected the **Others** option but do not wish to scan the PAL frequency range, store the channels manually (see page 19).
- 6 Press the **ENTER** (**↵**) button to confirm your choice
- 7 Press the **▼** or **▲** button to select **Auto store**. Press the **ENTER** (**↵**) button.
Result: The **Auto store** menu is displayed.
- 8 Press the **ENTER** (**↵**) button to start the search.
Result: The search will end automatically. Channels are sorted and stored in an order which reflects their position in the frequency range, (with lowest first and highest last). The programme originally selected is then displayed.
 - To stop the search before it has finished, press the **MENU** (**⏏**) button.
- 9 When the channels have been stored, you can:
 - ◆ Sort them in the order required (see page 22)
 - ◆ Clear a channel (see page 21)
 - ◆ Fine-tune channel reception if necessary (see page 31)
 - ◆ Assign a name to the stored channels (see page 23)
 - ◆ Activate/deactivate the Digital Noise Reduction feature (see page 38)



Storing Channels Manually

You can store up to 100 television channels, including those received via cable networks.

When storing channels manually, you can choose:

- ◆ Whether or not to store each of the channels found
- ◆ The programme number of each stored channel which you wish to identify

- 1 Press the **MENU** button.
Result: The main menu is displayed.
- 2 Press the ▼ or ▲ button to select **Channel1**.
Result: The options available in the **Channel1** group are displayed.
- 3 Press the **ENTER** (↵) button.
- 4 Press the ▼ or ▲ button to select **Manual Store**. Press the **ENTER** (↵) button.
Result: The **Manual store** menu is displayed.
- 5 If necessary, select the broadcasting standard required. Press the ◀ or ▶ button to select **Colour system** and press the ▼ or ▲ button. The colour standards are displayed in the following order. (depending on the model).
Auto - PAL - SECAM or
Auto - NT3.58 - NT4.43 - PAL60
- 6 Press the ◀ or ▶ button to select **sound system** and press the ▼ or ▲ button. The sound standards are displayed in the following order. (depending on the model).
BG - DK - I - L

ENG

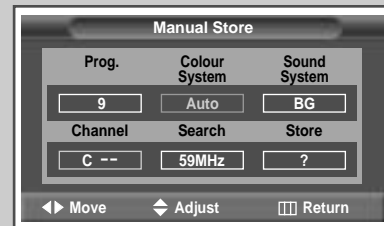
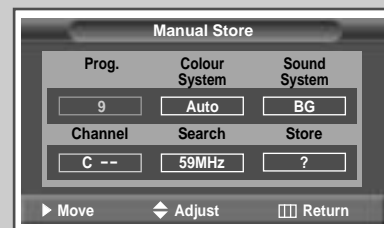

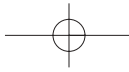

Storing Channels Manually (continued)

ENG

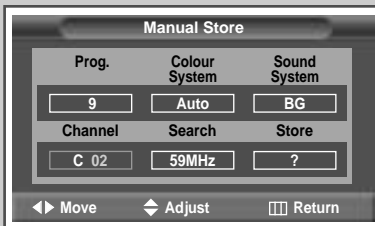
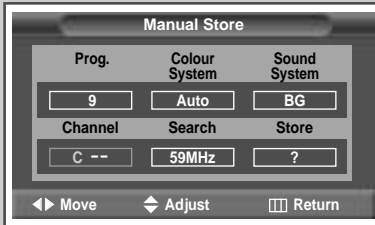

- 7 If you know the number of the channel to be stored, see the following steps.
 - ◆ Press the ◀ or ▶ button to select **Channel1**.
 - ◆ Press the ▼ or ▲ button to select **C** (Air channel) or **S** (Cable channel).
 - ◆ Press the ▶ button.
 - ◆ Press the numeric buttons (0-9) to select indicate the required number.

➤ If no sound or abnormal sound, re-select the sound standard required.
- 8 If you do not know the channel numbers, select the **Search** by pressing the ◀ or ▶ button. Press the ▼ or ▲ button to start the search.

Result: The tuner scans the frequency range until the first channel or the channel that you selected is received on your screen.
- 9 To assign a programme number to a channel, select the **Prog.** by pressing the ◀ or ▶ button. Press the ▼ or ▲ button until you find the correct number.
- 10 To store the channel and associated programme number, select the **Store** by pressing the ◀ or ▶ button. Press the **ENTER** (⏏) button.
- 11 Repeat Steps 7 to 10 for each channel to be stored.

Channel mode

- ◆ **C** (Real channel mode): You can select a channel by entering the assigned number to each air broadcasting station in this mode.
- ◆ **S** (Cable channel mode): You can select a channel by entering the assigned number for each cable channel in this mode.



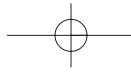

Skipping Unwanted Channels

◆ *Skipping unwanted channels*

You can exclude the channels of your choice from the channel scan operation. When you scan through the stored channels, those that you have chosen to skip are thus not displayed. All channels that you do not specifically choose to skip are displayed during scanning.

- 1 Press the **MENU** button.
Result: The main menu is displayed.
- 2 Press the **▼** or **▲** button to select **Channel1**.
Result: The options available in the **Channel1** group are displayed.
- 3 Press the **ENTER** (**↵**) button.
- 4 Press the **▼** or **▲** button to select **Edit**. Press the **ENTER** (**↵**) button.
Result: The **edit** menu is displayed.
- 5 Press the **▼** or **▲** button to select **Add/Delete**. Press the **ENTER** (**↵**) button.
Result: The **Add/Delete** menu is displayed with the current channel automatically is selected.
- 6 Press the **▼** or **▲** button to select the channel to be deleted.
- 7 To add or delete the channel, select **Added** or **Deleted** by pressing the **▼** or **▲** button. Press the **ENTER** (**↵**) button to confirm.



ENG



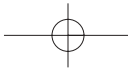

Sorting the Stored Channels

ENG

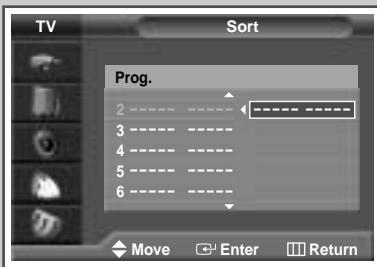
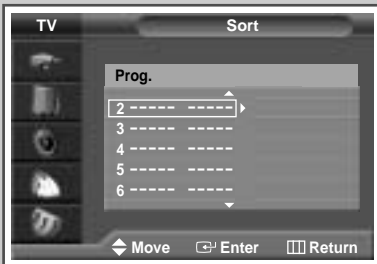
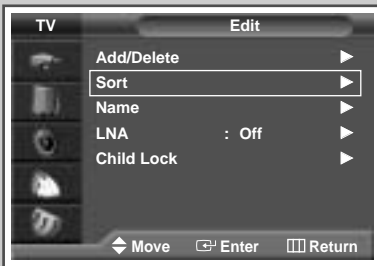

This operation allows you to change the programme numbers of stored channels. This operation may be necessary after using ATM. You can delete those channels you do not want to keep.

- 1** Press the **MENU** button.
Result: The main menu is displayed.
- 2** Press the **▼** or **▲** button to select **Channel1**.
Result: The options available in the **Channel** group are displayed.
- 3** Press the **ENTER** (**↵**) button.
- 4** Press the **▼** or **▲** button to select **edit**. Press the **ENTER** (**↵**) button.
Result: The **edit** menu is displayed.
- 5** Press the **▼** or **▲** button to select **sort**. Press the **ENTER** (**↵**) button.
Result: The **sort** menu is displayed.
- 6** Select the channel that you wish to move by pressing the **▼** or **▲** button. Press the **ENTER** (**↵**) button.
- 7** Select the number of the programme to which the channel is to be moved by pressing the **▼** or **▲** button. Press the **ENTER** (**↵**) button.
Result: The channel is moved to its new position and all other channels are shifted accordingly.
- 8** Repeat Steps **6** to **7** until you have moved all the channels to the required programme numbers.

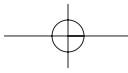

Assigning Names to Channels

Channel names will be assigned automatically when channel information is broadcast. These names can be changed, allowing you to assign new names.

- 1 Press the **MENU** button.
Result: The main menu is displayed.
- 2 Press the **▼** or **▲** button to select **Channel**.
Result: The options available in the **Channel** group are displayed.
- 3 Press the **ENTER** (**↵**) button.
- 4 Press the **▼** or **▲** button to select **Edit**. Press the **ENTER** (**↵**) button.
Result: The **Edit** menu is displayed.
- 5 Press the **▼** or **▲** button to select **Name**. Press the **ENTER** (**↵**) button.
Result: The **Name** menu is displayed with the current channel automatically is selected.
- 6 If necessary, select the channel to be assigned a new name by pressing the **▼** or **▲** button. Press the **ENTER** (**↵**) button.
Result: Arrow indications are displayed around the name box.
- 7 Press the **▼** or **▲** button to select a letter (A~Z), a number (0~9) or a symbol (-, space). Move on the previous or next letter by pressing the **◀** or **▶** button.
- 8 When you have finished entering the name, press the **ENTER** (**↵**) button to confirm the name.

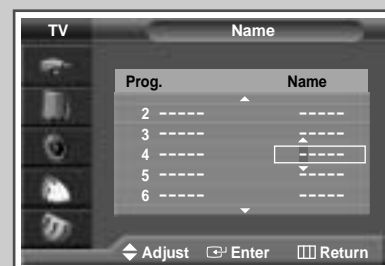

ENG

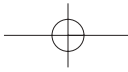

Using the LNA (Low Noise Amplifier) Feature

ENG

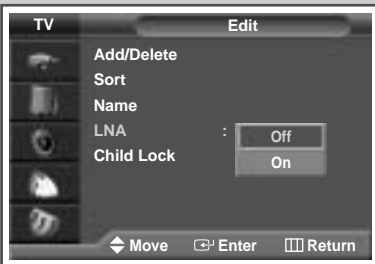
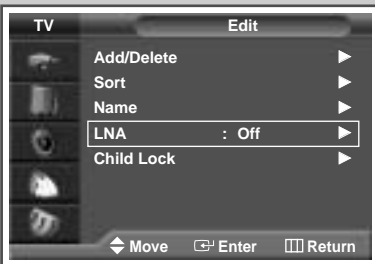

This function is very useful in the situation that the TV is used in weak signal. LNA amplifies the TV signal in the weak signal area, but not noise.

- 1** Press the **MENU** button.
Result: The main menu is displayed.
- 2** Press the **▼** or **▲** button to select **Channel**.
Result: The options available in the **Channel** group are displayed.
- 3** Press the **ENTER** () button.
- 4** Press the **▼** or **▲** button to select **edit**. Press the **ENTER** () button.
Result: The **edit** menu is displayed.
- 5** Press the **▼** or **▲** button to select **LNA**. Press the **ENTER** () button.
Result: The options available are listed.
- 6** Select **On** or **Off** by pressing the **▼** or **▲** button. Press the **ENTER** () button to confirm.

- ◆ If the picture is noisy with the **LNA** set to **On**, select **Off**.
- ◆ **LNA** setting is to be made for each channel.

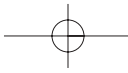

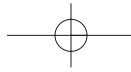

Activating the Child Lock

◆ Activating the child lock

This feature allows you to lock the television so that it cannot be switched on via the front panel. It can, however, still be switched on via the remote control. Thus, by keeping the remote control away from unauthorised users, such as children, you can prevent them from watching unsuitable programme.

- 1 Press the **MENU** button.
Result: The main menu is displayed.



- 2 Press the **▼** or **▲** button to select **Channel1**.
Result: The options available in the **Channel1** group are displayed.

- 3 Press the **ENTER** () button.

- 4 Press the **▼** or **▲** button to select **Edit**. Press the **ENTER** () button.
Result: The **edit** menu is displayed.

- 5 Press the **▼** or **▲** button to select **Child Lock**. Press the **ENTER** () button.
Result: The **Child Lock** menu is displayed with the current channel automatically is selected. Blue Screen is displayed when the **Child Lock** is activated.

- 6 Press the **▼** or **▲** button to select the channel to be locked.

- 7 Press the **ENTER** () button. To lock the channel, select **Locked** by pressing the **▼** or **▲** button (to unlock the channel, select **Unlocked**). Press the **ENTER** () button to confirm.

ENG



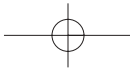

Displaying Information

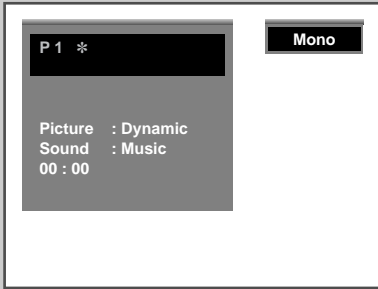

You can view the channel information and setting status you select by pressing the "INFO (INFO)" button on the remote control.

Changing the Picture Standard

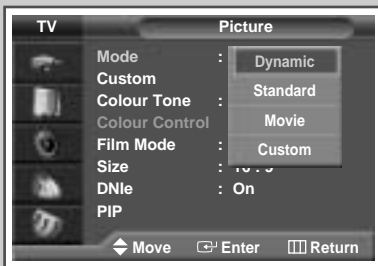
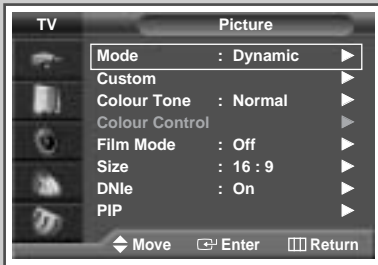

You can select the type of picture which best corresponds to your viewing requirements.

- 1 Press the **MENU** button.
Result: The main menu is displayed.

- 2 Press the **▼** or **▲** button to select **Picture**.
Result: The options available in the **Picture** group are displayed.

- 3 Press the **ENTER** (ENTER) button.
Result: The **Mode** is selected.

- 4 Press the **ENTER** (ENTER) button again.
Result: The options available are listed.

- 5 Select the option by pressing the **▼** or **▲** button.
Result: The following modes are available depending on the input source.
 - ◆ **Dynamic - Standard - Movie - Custom**
 - ◆ **High - Middle - Low - Custom** (PC or DVI Mode).

- 6 Press the **ENTER** (ENTER) button to confirm.

➤ You can also set these options simply by pressing the **P.MODE** (P.MODE: Picture Mode) button.

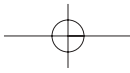

Adjusting the Picture Settings

Your television has several settings which allow you to control picture quality.

- 1 Press the **MENU** button.
Result: The main menu is displayed.
- 2 Press the **▼** or **▲** button to select **Picture**.
Result: The options available in the **Picture** group are displayed.
- 3 Press the **ENTER** (**↵**) button.
- 4 Select the required option (**Custom**, **Colour Tone**) pressing the **▼** or **▲** button.
- 5 Press the **▼** or **▲** button to select **Custom**. Press the **ENTER** (**↵**) button.
Result: The **Custom** menu is displayed.
- 6 Press the **ENTER** (**↵**) button to change the setting. The options are displayed in the following order.
 - ◆ **Custom** : **Contrast**, **Brightness**, **Sharpness**, **Colour**, **Tint** (NTSC ONLY)
 - **Custom** Options available in **PC**, **DVI** Mode: **Contrast**, **Brightness**, **Sharpness**.
 - The horizontal bar is displayed. Move the horizontal bar's cursor left or right by pressing the **◀** or **▶** button.
 - When the picture mode is set to **Custom**, the settings values may vary depending on the input source. (ex. RF, Video, Component, PC or DVI)
 - If you make any changes to these settings, the picture standard is automatically switched to the **Custom**.
 - ◆ **Colour Tone** : **Cool2**, **Cool1**, **Normal**, **Warm1**, **Warm2**
- 7 When you are satisfied with the settings, press the **EXIT/TV** (**→**) button to return to normal viewing.

- If you make any changes to these settings, the picture standard is automatically switched to the **Custom**.

ENG

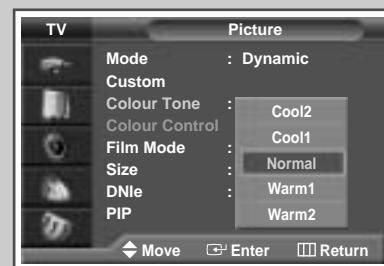
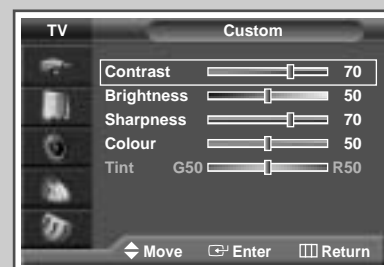
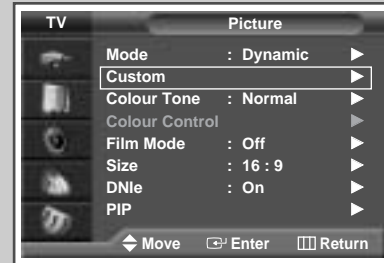





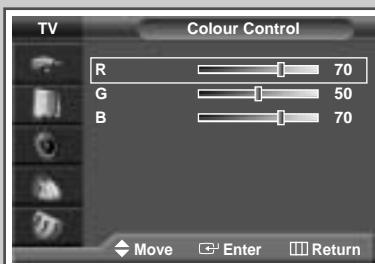
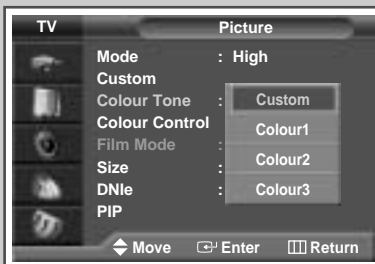
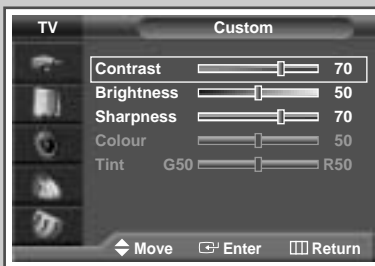
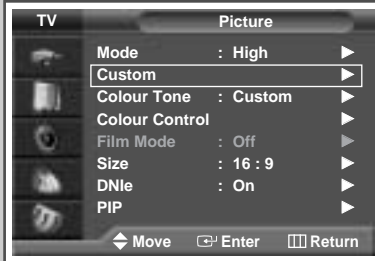

ENG

Adjusting the Picture Settings (PC or DVI Mode)



➤ Preset to the **PC** or **DVI** mode by using the **SOURCE** button.

- 1 Press the **MENU** button.
Result: The main menu is displayed.
- 2 Press the **▼** or **▲** button to select **Picture**.
Result: The options available in the **Picture** group are displayed.
- 3 Press the **ENTER** () button.
- 4 Press the **▼** or **▲** button to select **Custom**. Press the **ENTER** () button.
Result: The **Custom** menu is displayed.
- 5 Press the **▼** or **▲** button to select the option (**Contrast**, **Brightness**, **Sharpness**) to be adjusted. Press the **ENTER** () button.
Result: The horizontal bar is displayed. Move the horizontal bar's cursor left or right by pressing the **◀** or **▶** button.
- 6 Press the **MENU** button to confirm your choice.
- 7 Press the **MENU** button.
Result: The options available in the **Picture** group are displayed again.
- 8 Press the **▼** or **▲** button to select **Colour Tone**. Press the **ENTER** () button.
- 9 Select the option by pressing the **▼** or **▲** button. The colour tones are displayed in the following order.
Custom (PC mode only) - **Colour1** - **Colour2** - **Colour3**
- 10 Press the **MENU** button.
Result: The options available in the **Picture** group are displayed again.
- 11 Press the **▼** or **▲** button to select **Colour Control**. Press the **ENTER** () button.
Result: The **Colour Control** menu is displayed.
- 12 Press the **▼** or **▲** button to select the option (**R**, **G**, **B**) to be adjusted. Press the **ENTER** () button.
Result: The horizontal bar is displayed. Move the horizontal bar's cursor left or right by pressing the **◀** or **▶** button.

➤ The **Colour Control** is not available in the **DVI** Mode.

Setting the Picture (PC Mode)

➤ Preset to the **PC** mode by using the **SOURCE** button.

- 1 Press the **MENU** button.
Result: The main menu is displayed.
- 2 Press the **▼** or **▲** button to select **Setup**.
Result: The options available in the **Setup** group are displayed.
- 3 Press the **ENTER** (**↵**) button.
- 4 Press the **▼** or **▲** button to select **PC Setup**. Press the **ENTER** (**↵**) button.
Result: The options available in the **PC Setup** group are displayed.
- 5 Press the **▼** or **▲** button to select **Image Lock**. Press the **ENTER** (**↵**) button.
Result: The options available in the **Image Lock** group are displayed.
- 6 Press the **▼** or **▲** button to select the option (**Coarse**, **Fine**) to be adjusted. Press the **ENTER** (**↵**) button.
Result: The horizontal bar is displayed. Move the horizontal bar's cursor left or right by pressing the **◀** or **▶** button.
- 7 Press the **MENU** (**⏏**) button to confirm your choice
- 8 Press the **MENU** button.
Result: The options available in the **PC Setup** group are displayed again.
- 9 Press the **▼** or **▲** button to select **Position**. Press the **ENTER** (**↵**) button.
Result: The options available in the **Position** group are displayed.
- 10 Adjust the position by using the **▼**, **▲**, **◀**, or **▶** button.
- 11 Press the **MENU** (**⏏**) button to confirm your choice

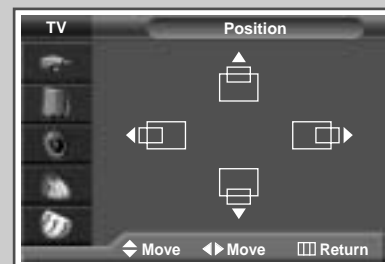
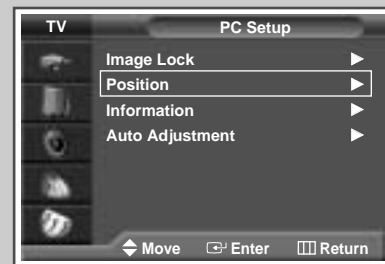
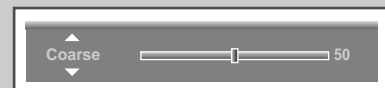
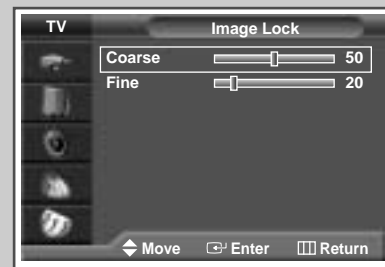
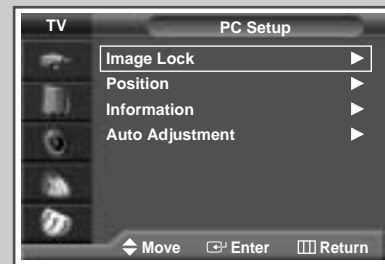

ENG

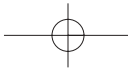

Setting the Picture (PC Mode) (continued)

ENG

➤ Preset to the **PC** mode by using the **SOURCE** button.

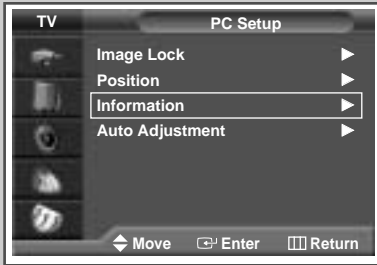

12 If you get the PC information, select the **Information** by pressing the ▼ or ▲ button. Press the **ENTER** (↵) button.

Result: The resolution, horizontal and vertical frequency are displayed.

13 Press the **MENU** button.

Result: The options available in the **PC Setup** group are displayed again.

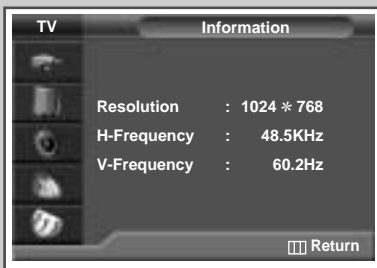

14 Press the ▼ or ▲ button to select **Auto Adjustment**. Press the **ENTER** (↵) button.

Result: The screen quality and position are automatically reset with the **Auto Adjusting** displayed.

15 When you are satisfied with the settings, press the **MENU** (⏏) button repeatedly to return to the normal viewing.

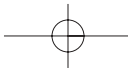
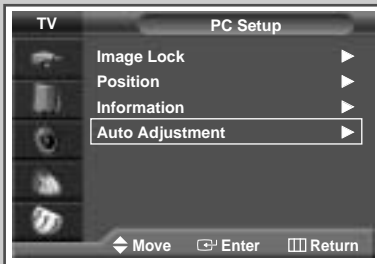

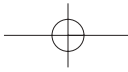

Using the Fine Tune



If reception is weak, you can fine tune a channel manually.

- 1 Press the **MENU** button.
Result: The main menu is displayed.

- 2 Press the **▼** or **▲** button to select **Channel1**.
Result: The options available in the **Channel1** group are displayed.

- 3 Press the **ENTER** () button.

- 4 Press the **▼** or **▲** button to select **Fine tune**. Press the **ENTER** () button.
Result: The horizontal bar is displayed. Move the horizontal bar's cursor left or right by pressing the **◀** or **▶** button to reach the required setting.

- 5 Press the **◀** or **▶** button until the picture and sound are both clear and sharp.

- If you are unable to fine tune a channel, check that the **Colour System** and **Sound System** settings are correct.
- Fine tune Store will change the colour of the Channel **OSD**(On Screen Display) from **White** to **Red**.

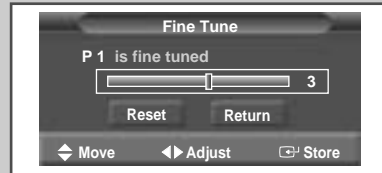
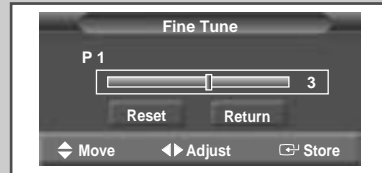
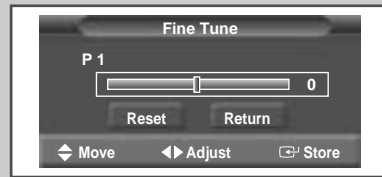

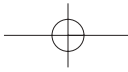

Viewing the Channel Scan Picture

ENG

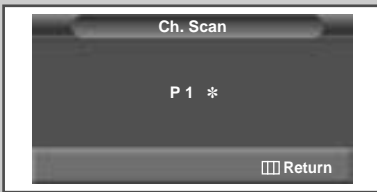

- 1 Press the **MENU** button.
Result: The main menu is displayed.

- 2 Press the **▼** or **▲** button to select **Channel1**.
Result: The options available in the **Channel1** group are displayed.

- 3 Press the **ENTER** () button.

- 4 Press the **▼** or **▲** button to select **Ch. scan**. Press the **ENTER** () button.
Result: You can view every memorized channel in order.

➤ When PIP ON is activated, the PIP will appear in Large mode and PIP channel will be scanned.

Freezing the Current Picture

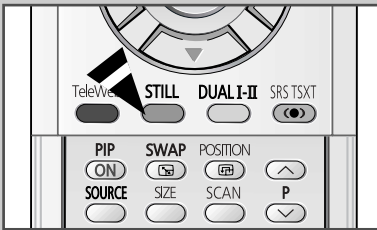

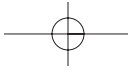

You can freeze the picture when watching a television programme simply by pressing the "STILL" button. To return to normal viewing, press it again.

➤ In the PIP mode, the main and sub pictures are stilled at the same time.





Selecting the Picture Size

You can select the picture size which best corresponds to your viewing requirements.

- 1 Press the **MENU** button.
Result: The main menu is displayed.
- 2 Press the **▼** or **▲** button to select **Picture**.
Result: The options available in the **Picture** group are displayed.
- 3 Press the **ENTER** () button.
- 4 Press the **▼** or **▲** button until the **size** is selected. Press the **ENTER** () button
- 5 Press the **▼** or **▲** button to change the setting.
 - ◆ **Auto Wide** : Expanding and pulling up the picture from 4:3 to 16:9 ratio.
 - ◆ **16:9** : Sets the picture to 16:9 wide mode.
 - ◆ **Panorama** : Use this mode for the wide aspect ratio of a panoramic picture.
 - ◆ **Zoom** : Magnify the size of the picture vertically on screen.
 - ◆ **14:9** : Magnify the size of the picture more than **4:3**.
 - ◆ **4:3** : Sets the picture to 4:3 normal mode.
- 6 Press the **ENTER** () button to confirm.

- ◆ You can select these options by simply pressing the **P.SIZE** button on the remote control.
- ◆ The picture size can not be changed in the PIP mode.
- ◆ Depending on the input source, the **P.SIZE** options may vary.

Positioning and Sizing the screen using Zoom

- ◆ Resizing the screen using the **Zoom** enables the positioning and sizing of the screen to up/down direction using the **▼** or **▲** button as well as the screen size.
 - ◆ Move the screen up/down using the **▼** or **▲** button after selecting the  by pressing the **▼** or **▲** button.
 - ◆ Resize the screen vertically using the **▼** or **▲** button after selecting the  by pressing the **▼** or **▲** button.
 - ◆ Screen enlargement operates only in TV/Video/S-Video/Component1,2 input modes.
 - ◆ PC/DVI modes prevents the screen enlargement function.

ENG

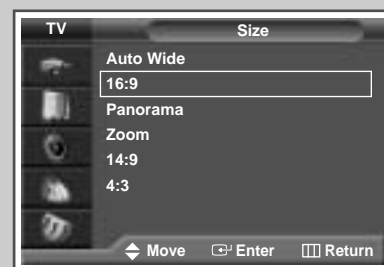
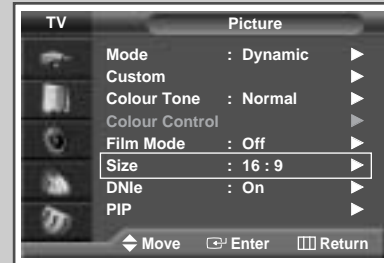

PC to DVI Mode



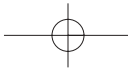

Selecting the Film Mode

ENG

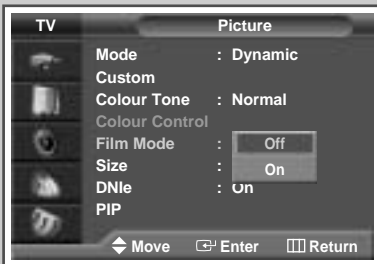
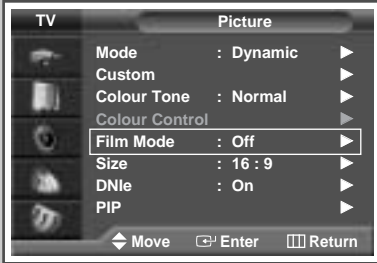

You can automatically sense and process film signals from some sources and adjust the picture for optimum quality.

- 1 Press the **MENU** button.
Result: The main menu is displayed.
- 2 Press the **▼** or **▲** button to select **Picture**.
Result: The options available in the **Picture** group are displayed.
- 3 Press the **ENTER** (**↵**) button.
- 4 Press the **▼** or **▲** button to select **Film Mode**. Press the **ENTER** (**↵**) button.
- 5 Press the **▼** or **▲** button to change the setting. (**Off** or **On**).
 - ◆ **On** : Automatically senses and processes film signals from some sources and adjusts the picture for optimum quality.
 - ◆ **Off** : Switches off the **Film Mode**.

- ◆ Not available in the PC, Component (480p, 576p, 720p, 1080i) or DVI modes.
- ◆ Mode discrepancies, such as turning off Film Mode while viewing a film source or turning on Film Mode while viewing non-film sources, may affect the picture quality.

DNle™ (Digital Natural Image engine) DNle™

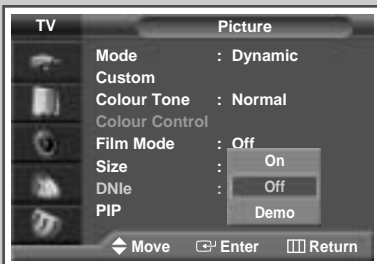
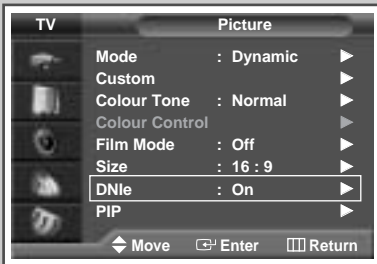

This feature bring you more detailed image with 3D noise reduction, detail enhancement, contrast enhancement and white enhancement. New image compensation Algorithm gives brighter, clearer, much detailed image to you. DNle™ technology will fit every signals into your eyes.

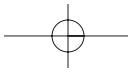

- 1 Press the **MENU** button.
Result: The main menu is displayed.
- 2 Press the **▼** or **▲** button until the **Picture** is selected.
Result: The options available in the **Picture** group are displayed.
- 3 Press the **ENTER** (**↵**) button.
- 4 Press the **▼** or **▲** button until the **DNle** is selected. Press the **ENTER** (**↵**) button.
- 5 Press the **▼** or **▲** button to change the setting.
 - ◆ **On**: Switches on the DNle mode.
 - ◆ **Off**: Switches off the DNle mode.
 - ◆ **Demo** (Option): The screen before applying DNle appears on the right and the screen after applying DNle appears on the left.

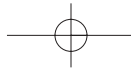



Setting the Blue Screen

If no signal is being received or the signal is very weak, a blue screen automatically replaces the noisy picture background. If you wish to continue viewing the poor picture, you must set the "Blue Screen" mode to "Off".

- 1 Press the **MENU** button.
Result: The main menu is displayed.
- 2 Press the **▼** or **▲** button to select **Setup**.
Result: The options available in the **Setup** group are displayed.
- 3 Press the **ENTER** () button.
- 4 Press the **▼** or **▲** button to select **Miscellaneous**. Press the **ENTER** () button.
Result: The options available in the **Miscellaneous** group are displayed.
- 5 Press the **▼** or **▲** button to select **Blue screen**. Press the **ENTER** () button.
- 6 Press the **▼** or **▲** button to change the setting. (**On** or **Off**).

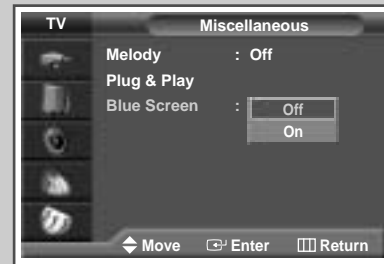
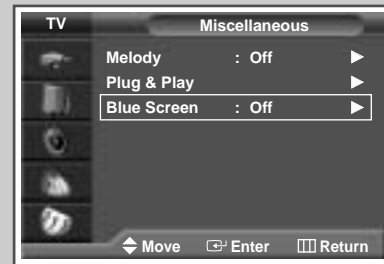
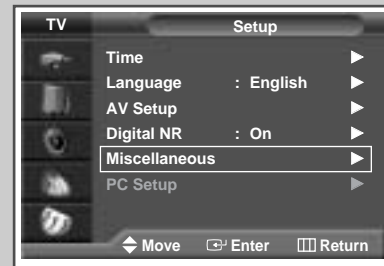

- ◆ **Blue Screen** is displayed while no signal from the external device in the External Mode, regardless of the Blue Screen Setting.



ENG

Setting the Melody Sound

You can hear clear melody sound when the television is powered on or off.

- 1 Press the **MENU** button.
Result: The main menu is displayed.
- 2 Press the **▼** or **▲** button to select **Setup**.
Result: The options available in the **Setup** group are displayed.
- 3 Press the **ENTER** () button.
- 4 Press the **▼** or **▲** button to select **Miscellaneous**. Press the **ENTER** () button.
Result: The options available in the **Miscellaneous** group are displayed.
- 5 Press the **▼** or **▲** button to select **Melody**. Press the **ENTER** () button.
- 6 Select the option (**Off** or **On**).

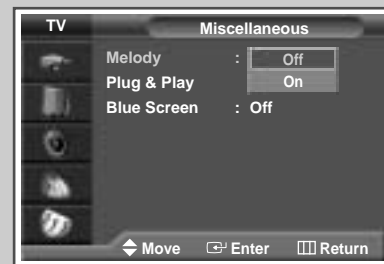
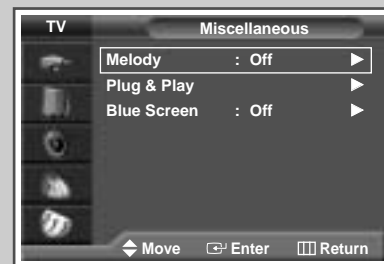

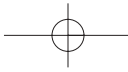

Viewing the Picture In Picture (PIP)

ENG

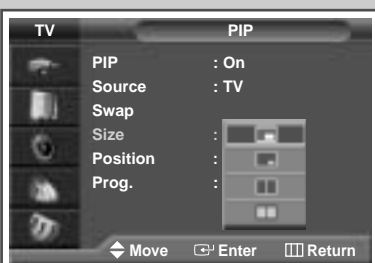
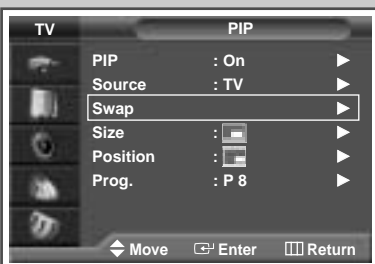
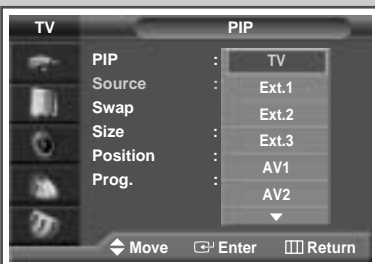
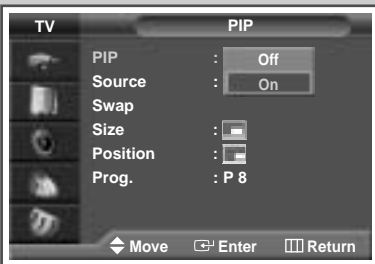
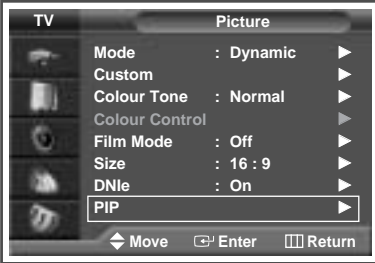

You can display a sub picture within the main picture of TV program or external A/V devices. In this way you can watch TV program or monitor the video input from any connected devices while watching TV or other video input.

- 1 Press the **MENU** button.
Result: The main menu is displayed.

- 2 Press the **▼** or **▲** button to select **Picture**.
Result: The options available in the **Picture** group are displayed.

- 3 Press the **ENTER** () button.

- 4 Press the **▼** or **▲** button to select **PIP**. Press the **ENTER** () button.
Result: The options available in the **PIP** group are displayed.

- 5 To activate, set the **PIP** to **on** by pressing the **▼** or **▲** button.

- 6 Press the **▼** or **▲** button to select **source**. Select a source of the sub picture by pressing the **ENTER** () button.
Result: The sources are displayed in the following order:
TV - Ext.1 - Ext.2 - Ext.3 - AV1 - AV2 - AV3 - S-Video1 - S-Video2 - Component1 - Component2 - PC - DVI
➤ ◆ The **PC** can not be selected in **DVI** mode.
◆ The **DVI** can not be selected in **PC** mode.

- 7 Press the **▼** or **▲** button to select **Swap**. Press the **ENTER** () button.
Result: The main picture and sub picture are interchanged.

- 8 Press the **▼** or **▲** button to select **size**. Select a size of the sub picture by pressing the **ENTER** () button.
Result: The sizes are displayed in the following order:

(Large) – (Small) – (Double1) – (Double2)
➤ The **Double1** or **Double2** mode can not be selected in **PC** or **DVI** mode.

Table of PIP Settings

	TV	Ext.1	Ext.2	Ext.3	AV1	AV2	AV3	S-Video1	S-Video2	COMP1	COMP2	PC	DVI
TV	0	0	0	0	0	0	0	0	0	0	0	0	0
Ext.1	0	X	0	0	0	0	0	0	0	0	0	0	0
Ext.2	0	0	X	0	0	0	0	0	0	0	0	0	0
Ext.3	0	0	0	X	0	0	0	0	0	0	0	0	0
AV1	0	0	0	0	X	0	0	0	0	0	0	0	0
AV2	0	0	0	0	0	X	0	0	0	0	0	0	0
AV3	0	0	0	0	0	0	X	0	0	0	0	0	0
S-Video1	0	0	0	0	0	0	0	X	0	0	0	0	0
S-Video2	0	0	0	0	0	0	0	0	X	0	0	0	0
COMP1	0	0	0	0	0	0	0	0	0	X	X	X	X
COMP2	0	0	0	0	0	0	0	0	0	X	X	X	X
PC	0	0	0	0	0	0	0	0	0	X	X	X	X
DVI	0	0	0	0	0	0	0	0	0	X	X	X	X

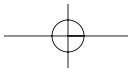

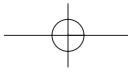

Viewing the Picture In Picture (PIP) (continued)



- 9 Press the ▼ or ▲ button to select **Position**. Press the **ENTER** (↵) button.

Result: The positions available are displayed.

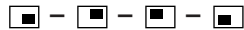

- 10 Press the ▼ or ▲ button to select **Prog.**. Select the channel that you want to view through sub picture by pressing the **ENTER** (↵) button.

➤ If the sub picture is no signal and the main picture is output from a Component, PC or DVI signal, the sub picture will be blue. If the main picture is output from a Video signal, the sub picture will be black.

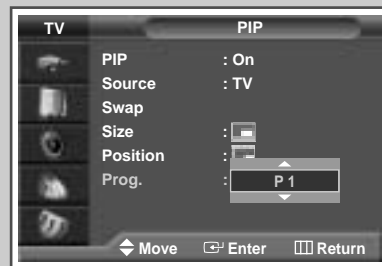
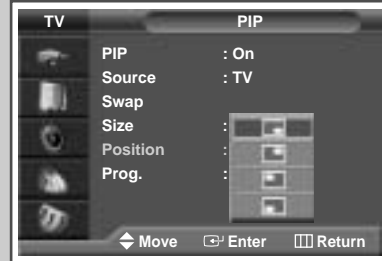

Easy functions of remote control.

Buttons	Feature
PIP ON	Used to activate or deactivate the PIP function directly.
SWAP	Used to interchange the main picture and the sub picture. ➤ When the main picture is in the Video mode and the sub picture is in the TV mode, you might not hear the sound of main picture when pressing the SWAP (↔) button after changing the sub picture channel. At this time, reselect the channel of main picture.
POSITION	Used to move the sub picture counterclockwise.
SOURCE	Used to assign a source of sub picture (TV, Ext.1, Ext.2, Ext.3, AV1, AV2, AV3, S-Video1, S-Video2, Component1, Component2, PC, DVI).
SIZE	Used to select a size of sub picture (Large, Small, Double1, Double2).
SCAN	Used to scan every memorized channel in order. To stop scanning, press it again.
P▲/▼	Used to select the channel of sub picture.

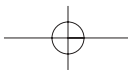
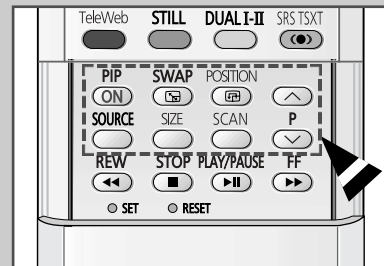

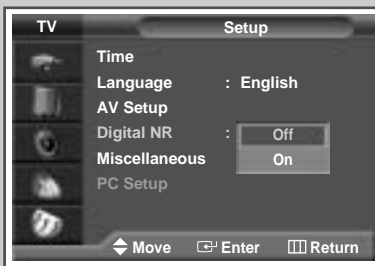

Using the Digital NR (Digital Noise Reduction) Feature

ENG



If the signal received by your television is weak, you can activate this feature to help reduce any static and ghosting that may appear on the screen.

- 1 Press the **MENU** button.
Result: The main menu is displayed.
- 2 Press the **▲** or **▼** button until the **Setup** is selected.
Result: The options available in the **Setup** group are displayed.
- 3 Press the **ENTER** () button.
- 4 Press the **▲** or **▼** button until the **Digital NR** is selected. Press the **ENTER** () button.
- 5 Select **Off** or **On** by pressing the **▲** or **▼** button. Press the **ENTER** () button to confirm.

Changing the Sound Standard

You can select the type of special sound effect to be used when watching a given broadcast.

- 1 Press the **MENU** button.
Result: The main menu is displayed.

- 2 Press the **▼** or **▲** button to select **sound**.
Result: The options available in the **sound** group are displayed.

- 3 Press the **ENTER** (**↵**) button.
Result: The **Mode** is selected.

- 4 Press the **ENTER** (**↵**) button again.

- 5 Select the option by pressing the **▼** or **▲** button. The sound effects are displayed in the following order.
standard - Music - Movie - Speech - Custom.

- 6 Press the **ENTER** (**↵**) button to confirm.

➤ You can also set these options simply by pressing the **S.MODE** (**↵**: Sound Mode) button.

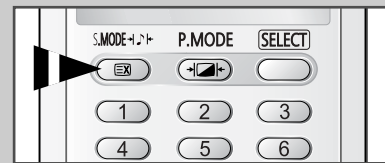
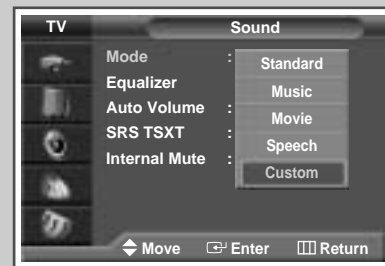
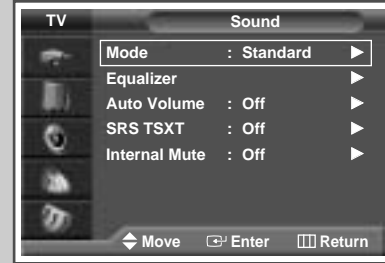

ENG

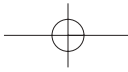

Adjusting the Sound Settings

ENG

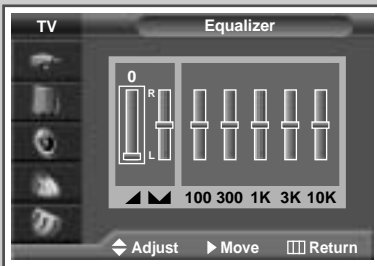
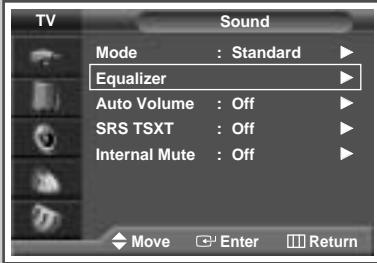

The sound settings can be adjusted to suit your personal preferences.

- 1** Press the **MENU** button.
Result: The main menu is displayed.
- 2** Press the **▼** or **▲** button to select **sound**.
Result: The options available in the **sound** group are displayed.
- 3** Press the **ENTER** () button.
- 4** Press the **▼** or **▲** button to select **Equalizer**. Press the **ENTER** () button.
Result: The **Equalizer** menu is displayed with the current option.
- 5** Select the option (volume, balance, equalizer) to be adjusted by pressing the **◀** or **▶** button. Press the **▼** or **▲** button to reach the required setting.
- 6** When you are satisfied with the settings, press the **MENU** () button to store them.

➤ If you make any changes to the equalizer settings, the sound standard is automatically switched to the **Custom**.

Adjusting the Volume Automatically

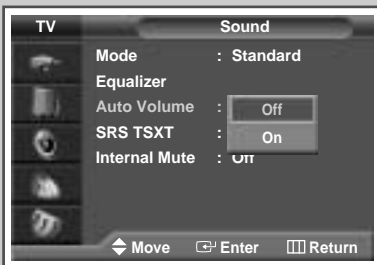
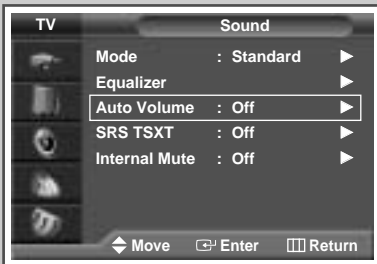

Each broadcasting station has its own signal conditions, and so it is not easy for you to adjust the volume every time the channel is changed. This feature lets you automatically adjust the volume of the desired channel by lowering the sound output when the modulation signal is high or by raising the sound output when the modulation signal is low.

- 1** Press the **MENU** button.
Result: The main menu is displayed.
- 2** Press the **▼** or **▲** button to select **sound**.
Result: The options available in the **sound** group are displayed.
- 3** Press the **ENTER** () button.
- 4** Press the **▼** or **▲** button to select **Auto Volume**. Press the **ENTER** () button.
- 5** Select the option (**Off** or **On**) by pressing the **▼** or **▲** button.

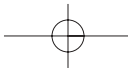

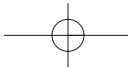

Setting the TruSurround XT

TruSurround XT is a patented SRS technology that solves the problem of playing 5.1 multichannel content over two speakers. TruSurround delivers a compelling, virtual surround sound experience through any two-speaker playback system, including internal television speakers. It is fully compatible with all multichannel formats.

- 1 Press the **MENU** button.
Result: The main menu is displayed.

- 2 Press the **▼** or **▲** button until the **sound** is selected.
Result: The options available in the **sound** group are displayed.

- 3 Press the **ENTER** (**↵**) button.

- 4 Press the **▼** or **▲** button until the **SRS TSXT** is selected. Press the **ENTER** (**↵**) button.

- 5 Press the **▼** or **▲** button to change the setting. (**Off**, **3D Mono** or **Stereo**).

➤ TruSurround XT, SRS and (●●) Symbol are trademarks of SRS Labs, Inc. TruSurround XT technology is incorporated under license from SRS Labs, Inc.



➤ You can also set these options simply by pressing the **SRS TSXT** (●●) button.

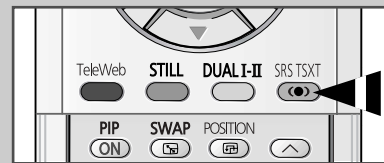
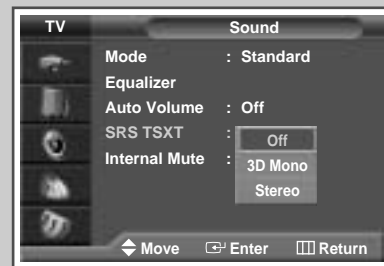
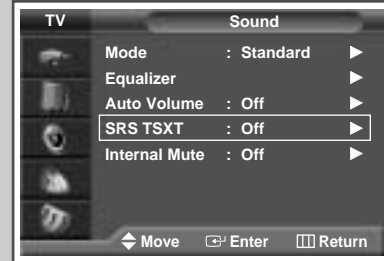

Selecting the Internal Mute

Since the speakers are built in the PDP, you can hear the sound without connecting separate speakers.

If you want to hear the sound through separate speakers, cancel the internal amplifier.

- 1 Press the **MENU** button.
Result: The main menu is displayed.

- 2 Press the **▼** or **▲** button to select **sound**.
Result: The options available in the **sound** group are displayed.

- 3 Press the **ENTER** (**↵**) button.

- 4 Press the **▼** or **▲** button to select **Internal Mute**. Press the **ENTER** (**↵**) button.

- 5 Press the **▼** or **▲** button to change the setting. (**On** or **Off**).

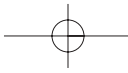
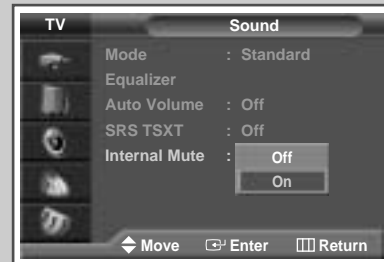
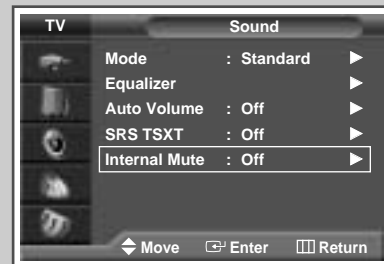

Selecting the Sound Mode (depending on the model)

ENG

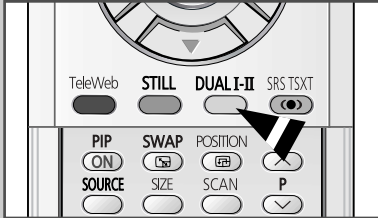

The "DUAL I-II" button displays/controls the processing and output of the audio signal. When power is switched on, the mode is automatically preset to either "DUAL-I" or "Stereo", depending on the current transmission.

	Type of broadcast	On-screen indication
NICAM Stereo	Regular broadcast (Standard audio)	Mono (Normal use)
	Regular + NICAM Mono	NICAM Mono ↔ Mono
	NICAM Stereo	NICAM Stereo ↔ Mono (Forced mono)
	NICAM DUAL-I/II	NICAM DUAL-I → NICAM DUAL-II → Mono
A2 Stereo	Regular broadcast (Standard audio)	Mono
	Bilingual or DUAL-I/II	DUAL-I ↔ DUAL-II
	Stereo	Stereo ↔ Mono (Forced mono)

- ◆ If the receiving conditions deteriorate, listening will be easier if the mode is set to the **Mono**.
- ◆ If the stereo signal is weak and an automatic switching occurs, then switch to the **Mono**.
- ◆ When receiving a mono sound in the AV mode, connect to the "AUDIO-L" input connector on the side of the television. If the mono sound comes out only from left speaker, press the **DUAL I-II** button.

Setting the Sleep Timer

You can select a time period of between 30 and 180 minutes after which the television automatically switches to Standby mode.

- 1 Press the **MENU** button.
Result: The main menu is displayed.
- 2 Press the **▼** or **▲** button to select **Setup**.
Result: The options available in the **Setup** group are displayed.
- 3 Press the **ENTER** (**↵**) button.
- 4 Press the **▼** or **▲** button to select **Time**. Press the **ENTER** (**↵**) button.
Result: The options available in the **Time** group are displayed.
- 5 Press the **▼** or **▲** button to select **Sleep Timer**. Press the **ENTER** (**↵**) button.
Result: The **Sleep Timer** menu is displayed with the **Min** selected.
- 6 Select the preset time intervals (**Off**, 30, 60, 90, 120, 150, 180) by pressing the **▼** or **▲** button.
- 7 When you are satisfied with the settings, select **Activation** to **Yes** or **No** by pressing the **▼** or **▲** button.
- 8 Press the **ENTER** (**↵**) button to confirm your selection.

- ◆ You can also set these options simply by pressing the **SLEEP** button.
- ◆ If the sleep timer is not yet set, **OFF** is displayed. If the sleep timer is already set, the remaining time before which the television switches to Standby mode is displayed.



ENG

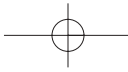

Setting and Displaying the Current Time

ENG





You can set the television's clock so that the current time is displayed by pressing the "INFO ()" button. You must also set the time if you wish to use the automatic on or off timers.

➤ When pressing the "I /  " button (On/Off) on the front of the television, the clock setting will be reset.

- 1 Press the **MENU** button.
Result: The main menu is displayed.

- 2 Press the **▼** or **▲** button to select **Setup**.
Result: The options available in the **Setup** group are displayed.

- 3 Press the **ENTER** () button.

- 4 Press the **▼** or **▲** button to select **Time**. Press the **ENTER** () button.
Result: The options available in the **Time** group are displayed with **CLock** is selected.

- 5 Press the **ENTER** () button.

- 6 Press the **◀** or **▶** button to move to the hour or minute. Set the hour or minute by pressing the **▼** or **▲** button.

- 7 When you have finished, press the **MENU** () button to exit.

- 8 Press the **INFO** () button to display the current time.

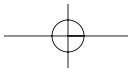

Switching the Television On and Off Automatically

You can set the television's clock and set the On or Off timers so that the television will:

- ◆ Switch on automatically and tune to the channel of your choice at the time you select
- ◆ Switch off automatically at the time you select

➤ The first step is to set the television's clock (refer to "Setting and Displaying the Current Time" on the previous page).

- 1 Press the **MENU** button.
Result: The main menu is displayed.
- 2 Press the ▼ or ▲ button to select **Setup**.
Result: The options available in the **Setup** group are displayed.
- 3 Press the **ENTER** (↵) button.
- 4 Press the ▼ or ▲ button to select **Time**. Press the **ENTER** (↵) button.
Result: The options available in the **Time** group are displayed.
- 5 Press the ▼ or ▲ button to select **On Timer**. Press the **ENTER** (↵) button.
Result: The options available in the **On Timer** group are displayed.
- 6 Select the **Hour**, **Min**, **Prog.**, **Volume** by pressing the ◀ or ▶ button.
Set these by pressing the ▼ or ▲ button.
- 7 When you are satisfied with the settings, select **Activation** to **Yes** or **No** by pressing the ▼ or ▲ button.
- 8 Press the **MENU** button.
Result: The options available in the **Time** group are displayed again.
- 9 Press the ▼ or ▲ button to select **Off Timer**. Press the **ENTER** (↵) button.
Result: The **Off Timer** menu is displayed.
- 10 Select the **Hour**, **Min** or **Activation** by pressing the ◀ or ▶ button.
Set these by pressing the ▼ or ▲ button.

➤ Absent Power Off

When you set the timer "On", your television will eventually be turned off, if you do not operate any controls during the 3 hours after the TV is turned on by timer. This function is available in only the timer "On" mode and will prevent a leakage accident or overheating, caused by your TV left on for a long time due to the timer "On" (when you are away on holiday, for example).

ENG

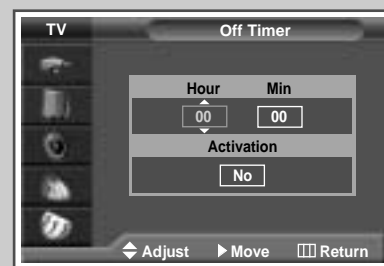
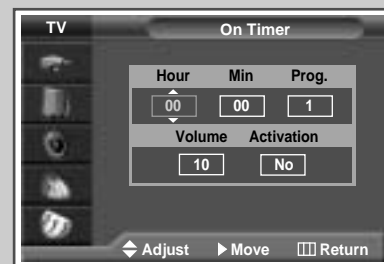
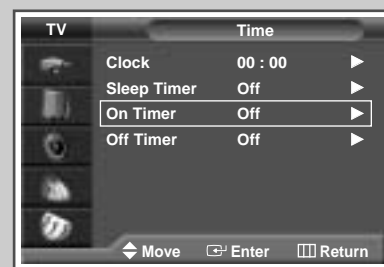

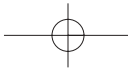

Viewing an External Signal Source

ENG

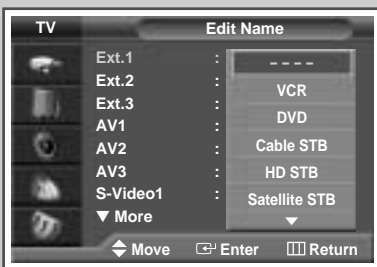
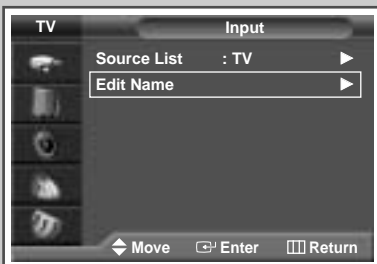

Use the remote control to switch between viewing signal from connected equipment, such as VCR, DVD, Set-Top-boxes and the TV source (broadcast or cable)

- 1 Press the **MENU** button.
Result: The main menu is displayed.

- 2 Press the **▼** or **▲** button to select **Input**.
Result: The options available in the **Input** group are displayed.

- 3 Press the **ENTER** () button.

- 4 Press the **▼** or **▲** button to select **Source List**. Press the **ENTER** () button.
Result: The options available in the **Source List** group are displayed.

- 5 Press the **▼** or **▲** button to select signal source, then press the **ENTER** () button.
 - When you connect equipment to the TV, you can choose between the following sets of jacks : **Ext.1, Ext.2, Ext.3, AV1, AV2, AV3, S-Video1, S-Video2, Component1, Component2, PC** or **DVI** on the TV's rear panel.

- 6 Press the **MENU** button and select **Input**.

- 7 Press the **▼** or **▲** button to select **Edit Name**. Press the **ENTER** () button.
Result: The options available in the **Edit Name** group are displayed.

- 8 Press the **▼** or **▲** button to select external device :
Ext.1 - Ext.2 - Ext.3 - AV1 - AV2 - AV3 - S-Video1 - S-Video2 - Component1 - Component2 - PC - DVI

- 9 Press the **ENTER** () button.
Result: The **Edit Name** available are listed.

- 10 Select the name by pressing the **▼** or **▲** button. Press the **ENTER** () button.

- 11 Set other signal sources (**VCR, DVD, Cable STB, HD STB, Satellite STB, AV Receiver, DVD Receiver, Game, Camcorder, DVD Combo, DHR** or **PC**) using the same method as listed above.

➤ You can also set these options simply by pressing the **SOURCE** () button. If you change the external source while viewing, pictures might take a short period of time to be switched.

➤ **DHR** : DVD HDD Recorder

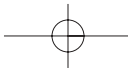

Redirecting an Input to the External Output

Your television enables you to choose which audio/video signals are output to the external connector.

- 1 Press the **MENU** button.
Result: The main menu is displayed.
- 2 Press the ▼ or ▲ button to select **Setup**.
Result: The options available in the **Setup** group are displayed.
- 3 Press the **ENTER** (↵) button.
- 4 Press the ▼ or ▲ button to select **AV Setup**. Press the **ENTER** (↵) button.
Result: The **AV Setup** menu is displayed.
- 5 Press the ▼ or ▲ button to select required input (**Ext. 2** or **Ext. 3**). Select the source to be directed to the output by pressing the ▼ or ▲ button.
- 6 Press the **ENTER** (↵) button to confirm the change.

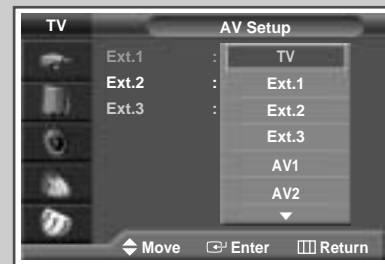
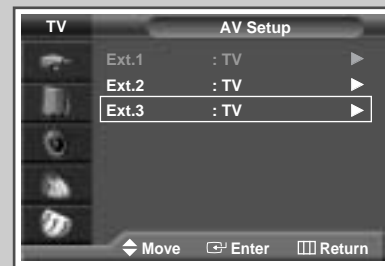

ENG

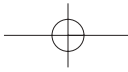

Teletext Feature

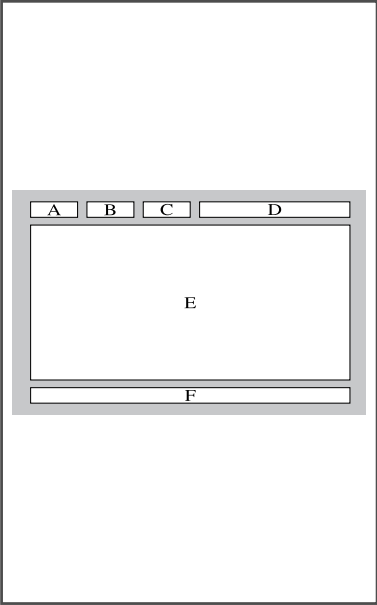

Most television channels provide written information services via teletext. Information provided includes:

- ◆ *Television programme times*
- ◆ *News bulletins and weather forecasts*
- ◆ *Sports results*
- ◆ *Travel information*

This information is divided into numbered pages (see diagram).

Part	Contents
A	Selected page number.
B	Broadcasting channel identity.
C	Current page number or search indications.
D	Date and time.
E	Text.
F	Status information. FASTEXT information.

- Teletext information is often divided between several pages displayed in sequence, which can be accessed by:
 - ◆ Entering the page number
 - ◆ Selecting a title in a list
 - ◆ Selecting a coloured heading (FASTEXT system)

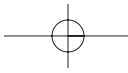
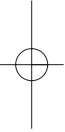



Displaying the Teletext Information

You can display Teletext information at any time on your television

- ✎ For Teletext information to be displayed correctly, channel reception must be stable; otherwise:
 - ◆ Information may be missing
 - ◆ Some pages may not be displayed

- 1 Select the channel providing the Teletext service by pressing the **P** or **SOURCE** button.

- 2 Press the **TTX/MIX** () button to activate the teletext mode.
Result: The contents page is displayed. It can be redisplayed at any time by pressing the **INDEX** () (index) button.

- 3 Press the **TTX/MIX** () button again.
Result: The screen will be split into two. This Double Teletext feature lets you view the actual broadcast and teletext information separately on the screen.

- 4 If you wish to display the actual broadcast and teletext information on a single screen, press the **TTX/MIX** () button again.

- 5 To exit from the teletext display, press the **EXIT/TV** () button.

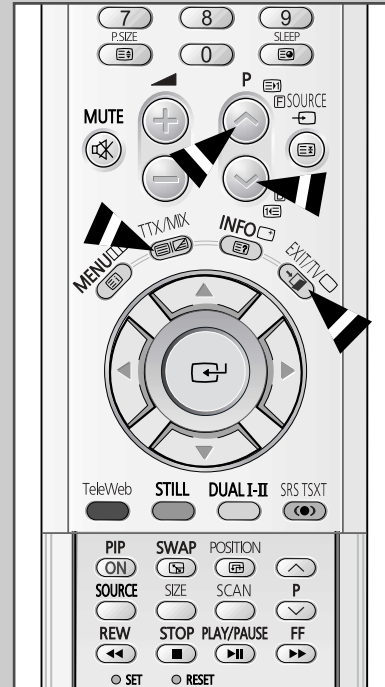

ENG

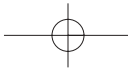

Selecting Display Options

ENG

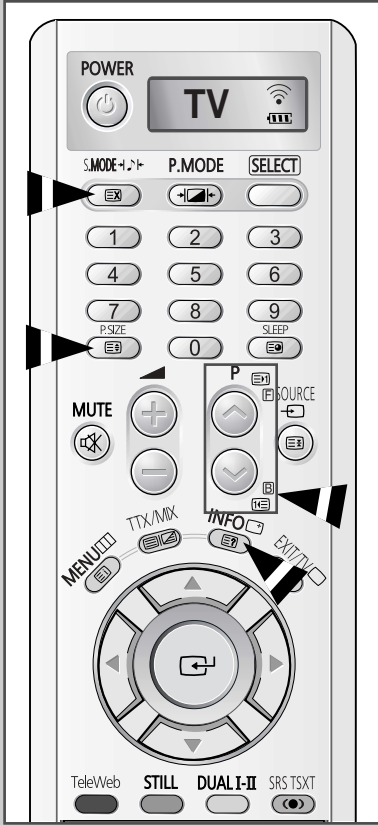

When you have displayed a Teletext page, you can select various options to suit your requirements.

To display...	Press the...
◆ Hidden text (answers to quiz games, for example)	[REVEAL] (reveal)
◆ The normal screen	[REVEAL] (reveal) again
◆ A secondary page by entering its number	[SUB-PAGE] (sub-page)
◆ The broadcast when searching for a page	[CANCEL] (cancel)
◆ The next page	[PAGE UP] (page up)
◆ The previous page	[PAGE DOWN] (page down)
◆ Double-size letters in the: <ul style="list-style-type: none"> • Upper half of the screen • Lower half of the screen 	[SIZE] (size) <ul style="list-style-type: none"> • Once • Twice
◆ The normal screen	• Three times

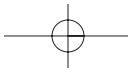

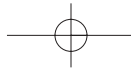

Selecting a Teletext Page



You can enter the page number directly by pressing the numeric buttons on the remote control.

- 1 Enter the three-digit page number given in the content by pressing the corresponding numeric buttons.

Result: The current page counter is incremented and the page is then displayed. If the selected page is linked with several secondary pages, the secondary pages are displayed in sequence.
- 2 If the FASTEXT system is used by the broadcasting company, the different topics covered on a Teletext page are colour-coded and can be selected by pressing the coloured buttons on the remote control.

Press the coloured button corresponding to the topic that you wish to select; the available topics are given on the status line.

Result: The page is displayed with other coloured information that can be selected in the same way.
- 3 To display the previous or next page, press the corresponding coloured button.
- 4 To display the subpage, see the following steps.
 - ◆ Press the  (sub-page) button.

Result: The available subpages appear.
 - ◆ Select the required sub-page. Sub-pages can be scrolled by pressing the  or  button.
- 5 When you have finished, press the **EXIT/TV** () button to return to your normal broadcast.

ENG

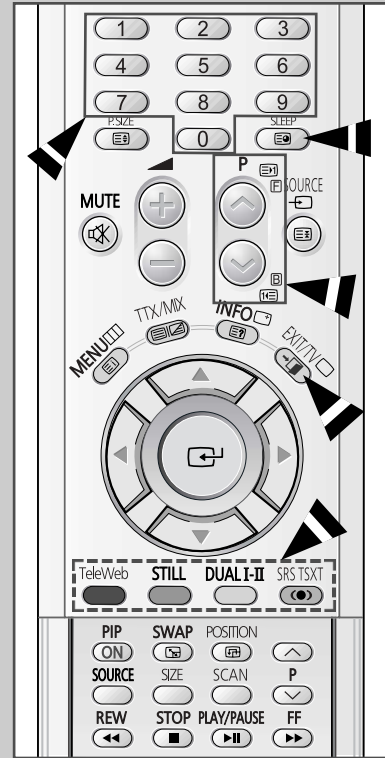

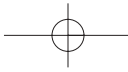

TeleWeb Feature (Option)

ENG

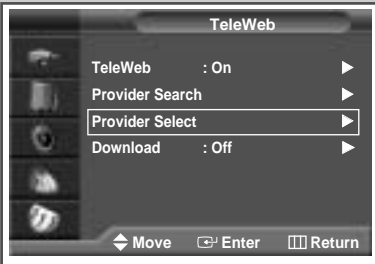
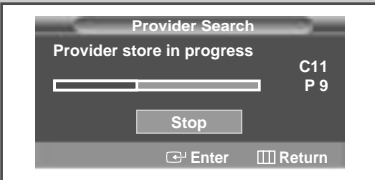

TeleWeb is the new television broadcasting standard for Teletext services. TeleWeb is similar to Teletext, just easy to use. TeleWeb can transmit the News, TV programme information, and advertising in excellent picture quality and directly access via the remote control.

- 1 Press the **MENU** button.
Result: The main menu is displayed.

- 2 Press the **▼** or **▲** button to select **Setup**.
Result: The options available in the **Setup** group are displayed.

- 3 Press the **ENTER** (**↵**) button.

- 4 Press the **▼** or **▲** button to select **TeleWeb**. Press the **ENTER** (**↵**) button.
Result: The **TeleWeb** menu is displayed.

- 5 To activate the TeleWeb feature, set the **TeleWeb** to **On** by pressing the **◀** or **▶** button.
 - ◆ If you set to **On**, 400 teletext pages can be stored.
 - ◆ If you set to **Off**, 2100 teletext pages can be stored.

- 6 Press the **▼** or **▲** button to select **Provider Search**. Start the provider search by pressing the **◀** or **▶** button.
Result: It will be search only the channels stored. If it find a provider, the Added is displayed and continue the search.
 - To stop the search before it has finished, press the **EXIT/TV** (**↵**) button.

- 7 When the search has been finished, press the **▼** or **▲** button to select **Provider Select**. Find the required provider by pressing the **◀** or **▶** button.
 - Select a provider and then the TeleWeb downloading will start.

- 8 Press the **TeleWeb** button to enter the TeleWeb mode.

- 9 If you want to download the TeleWeb information before switch the television off, select the **Download** by pressing the **▼** or **▲** button. Press the **◀** or **▶** button to set to **On**.
Result: Even though you turn off the TV on the channel no provider is selected, the channel will be automatically switched to the selected channel and TeleWeb downloading will start. During downloading, the picture will not be shown and only status bar will be displayed on the screen. (It takes 30 minutes to one hour depending on the program.)
 - ◆ When pressing the " **||** **⏻** " button (On/Off) on the panel of the television, the existing downloaded information will disappear.
 - ◆ If you enter the TeleWeb mode on the channel where no provider is selected, you can view only the information downloaded up to now.

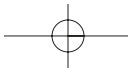

Using the TeleWeb Menu after Displaying the TeleWeb

ENG

Bookmarking the current page.

- 1 On the page you wish to add to the bookmark list press the **MENU** button.

Result: The **TeLeWeb** menu is displayed.

- 2 Press the **▼** or **▲** button to select **Add Bookmark**. Press the **ENTER** () button.

Result: The current page is added to the bookmark list.

- You can register up to six pages. If you add another URL when six bookmarks have been listed, the first URL will be deleted and the new URL will be listed as the sixth.

Entering the bookmarked URL.

- 1 Press the **MENU** button.

Result: The **TeLeWeb** menu is displayed with the **Bookmark List** selected.

- 2 Press the **ENTER** () button.

Result: The stored URLs are listed.

- 3 To erase a URL, select a required URL and press the **TeLeWeb** (red) button.

Result: The selected URL is erased and the listed URLs moves up one by one.

- 4 Select the URL you wish to enter by pressing the **▼** or **▲** button and press the **ENTER** () button.

Result: The current page moves to the selected URL and the menu is disappeared.

Opening the Home Page

- 1 Press the **MENU** button.

Result: The **TeLeWeb** menu is displayed.

- 2 Press the **▼** or **▲** button to select **Home Page**. Press the **ENTER** () button.



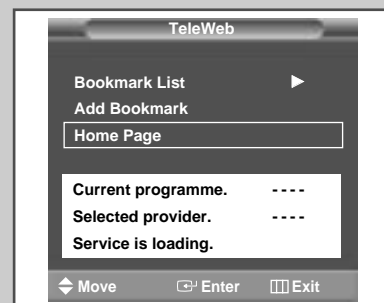
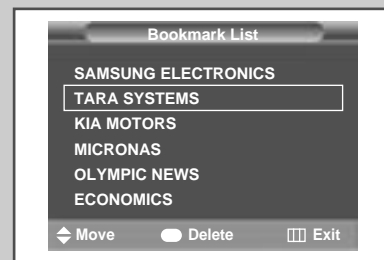
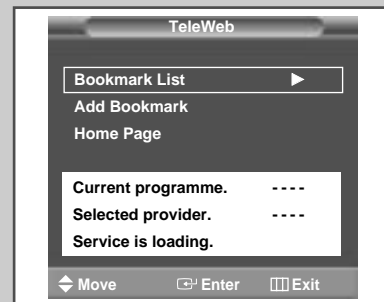
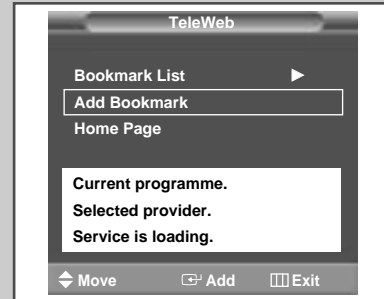

Result: It moves to a home page.

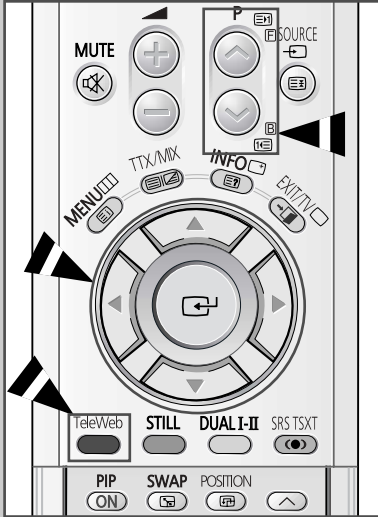

Easy Accessing the TeleWeb Service via the Remote Control

ENG



Button	Function
TeleWeb 	Activate or deactivate the TeleWeb feature directly.
	Display the forward page of the TeleWeb
	Display the backward page of the TeleWeb
	Select a option.
	Confirm your choice.

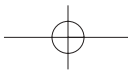

Connecting to the External Devices

ENG

“MONITOR OUT” are used for the equipment with an RGB output, such as video game devices or video disc players.

Rear of the TV (Input/Output)

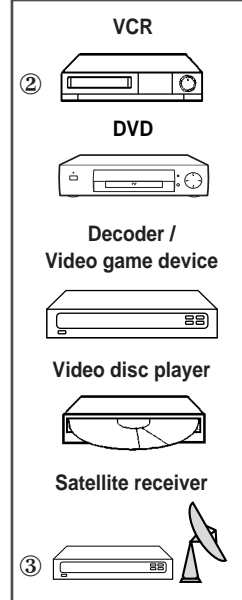
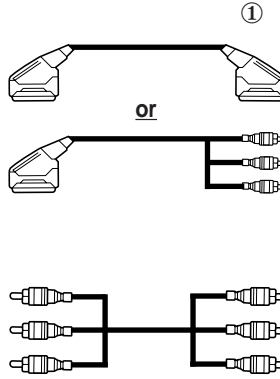
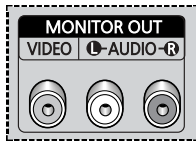
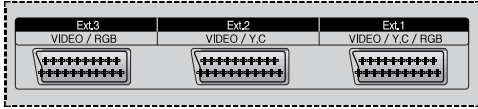

- ① This end can be fitted with:
 - ◆ A SCART connector
 - ◆ Three RCA connectors (VIDEO + AUDIO-L/R)
- ② If you have a second VCR and wish to copy cassettes tape, connect the source VCR to “AV 1” and the target VCR to “AV 2” so that you can redirect the signal from “AV 1” to “AV 2”.
- ③ When you wish to record a programme, connect the receiver to “AV 1” and the VCR to “AV 2 or AV 3” so that you can redirect the signal from “AV 1” to “AV 2 or AV 3”.

Input/Output Specification

Connector	Input				Output
	Video	Audio (L/R)	S-Video	RGB	Video + Audio (L/R)
Ext.1	✓	✓	✓	✓	Only TV output is available.
Ext.2	✓	✓	✓		Output you can choose.
Ext.3	✓	✓		✓	Output you can choose.

Rear of the TV (Input/Output)

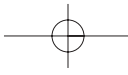
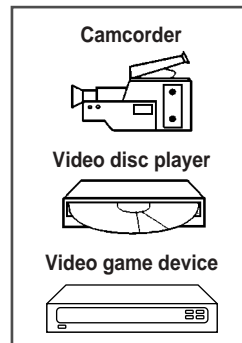
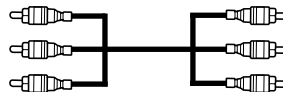
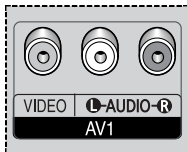
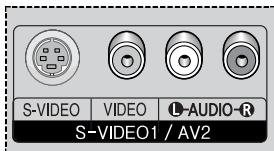

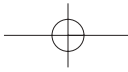

Connecting to the S-Video Input

ENG

The S-VIDEO1 and RCA (AUDIO-L/R) connectors are used for equipment with an S-Video output, such as a camcorder or VCR.

Rear of the TV

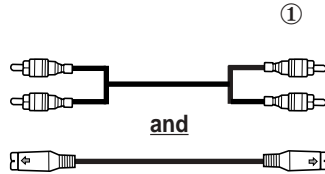

Side of the TV

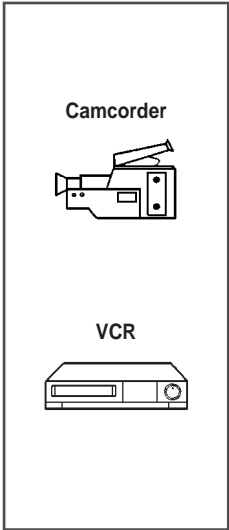
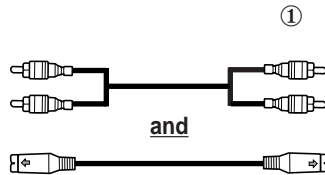
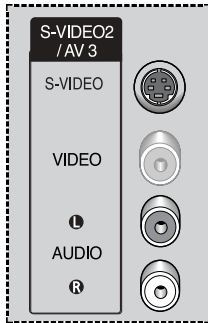

① To play picture and sound, both the S-VIDEO and RCA connectors must be used.



Whenever you connect an audio or video system to your television, ensure that all elements are switched off. Refer to the documentation supplied with your equipment for detailed connection instructions and associated safety precautions.

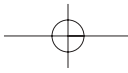

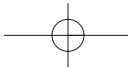

Connecting to the DVI Input

ENG

The "DVI" (video) and "L-AUDIO-R" connectors are used for equipment with a DVI output.

Rear of the TV

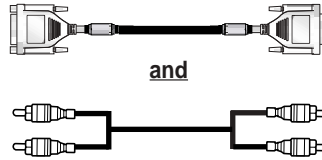
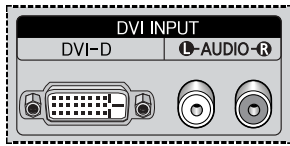

and

Personal Computer



Connecting to the PC Input

The "RGB" (video) and "AUDIO" connectors are used for interfacing with your PC.

Rear of the TV

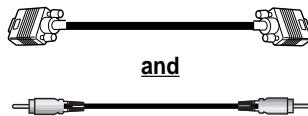
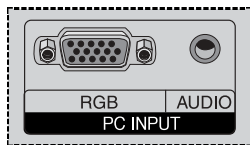

and

Personal Computer

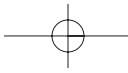

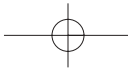

ENG

Connecting to the Component Input

Rear of the TV

① DVD

② DTV receiver

- ① The "COMPONENT 1" connectors are used for equipment with a DVD output. (480i/480p/576i/576p/720p/1080i)
- ② The "COMPONENT 2" connectors are used for DTV receiver. (480i/480p/576i/576p/720p/1080i)



Connecting Additional Speakers

Rear of the TV

EXT SPEAKER (8Ω)

+ R - - L +

To take advantage of the surround sound system, connect additional speakers.

The speaker terminals are located on the rear of the television:

- ◆ Two for the left-hand surround speaker (marked L)
- ◆ Two for the right-hand surround speaker (marked R)

➤ To improve the quality of the sound, connect the:

- ◆ Red wire to the red terminal
- ◆ Black wire to the black terminal

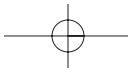

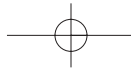

Connecting and Using the Home Theater System

ENG

Use the Monitor Out ports of the PDP for Home Theater System Connections.

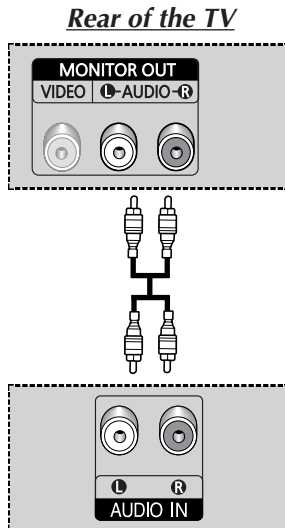

Connecting the Home Theater System

- ① Connect the monitoring audio out L, and R jacks of the MONITOR OUT on the rear-side connection panel of the PDP TV to the AUDIO IN jacks of the DVD Home Theater System (or AV Receiver) using the audio cable.
- ② Press the **SOURCE** button to select the desired external device connected to the PDP TV.
- ③ If you want to hear the sound through separate speakers, cancel the internal amplifier.

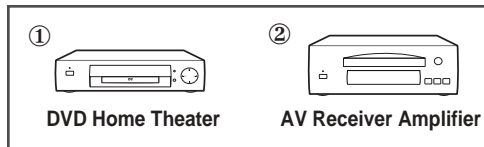

- ◆ Refer to corresponding user's manual from the manufacturer for wiring the speakers to the DVD Home Theater System (or AV Receiver).
- ◆ Disable the PDP TV internal speaker to enjoy the rich sound through the speakers of your Home Theater System.
- ◆ In this case, enjoy the sound from the Home Theater System while the PDP TV does not produce the audio.

To Display the DVD Home Theater

- ① Turn the PDP on and press the **SOURCE** button to select the **Ext.1** (or **Ext.2, Ext.3**).
- ② Be sure to connect the video cable properly if desired external input (**Ext.1, Ext.2, or Ext.3**) cannot be selected.
- ③ Play the DVD after activating the DVD Home Theater System.
- ④ Use the volume control of the Home Theater System while watching the PDP using the DVD Home Theater, where the PDP TV does not produce the audio.



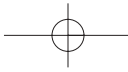

Installing the Speakers

ENG

➤ This speaker installation guide is for the 4240 Model.

Parts

The actual product may differ slightly from the illustration.

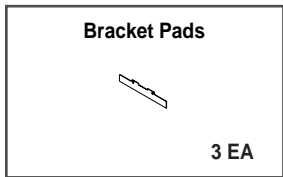
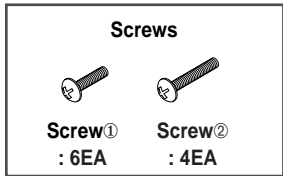
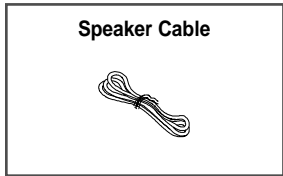
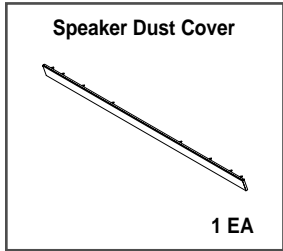
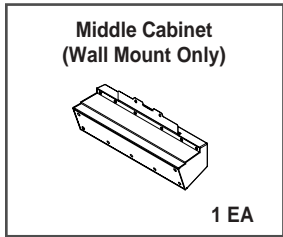
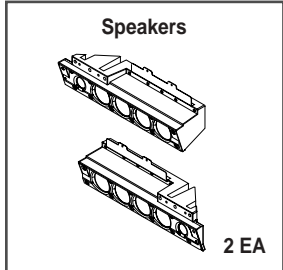

How to Assemble the Speakers (Standing)

① Remove the screws indicated on the rear of the PDP (6 screws on the left and right sides).

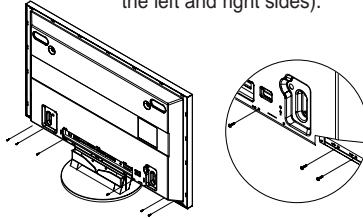

② Attach the Bracket Pads to the Speaker's Guide Bracket. Set the Speaker Guide Bracket into the square grooves located on either side of the PDP's bottom rear and secure it with the provided screws ①, ②. (Always use the proper screws, as indicated.)

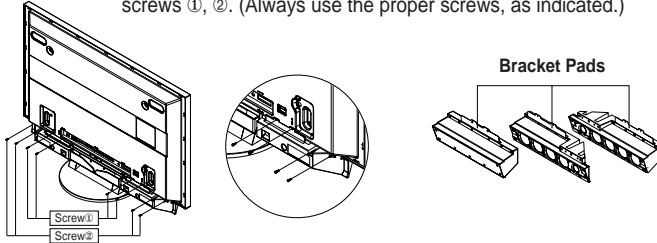

③ Secure the Speaker Dust Cover by setting it into the grooves located on the front side of the speakers.

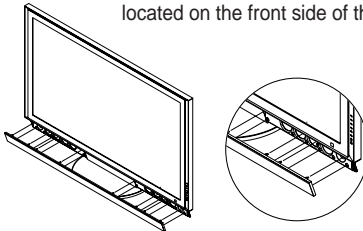

④ Connect the speakers to the PDP using the speaker cable. The connection terminals are on the rear side of both the PDP and the speakers. (Match the color coded terminals and cables.)

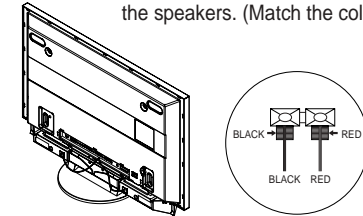

WARNING

1. When moving the PDP with the speakers attached, be sure to hold on to the PDP to prevent damage. (Damage may occur to the speaker connecting brackets or the speakers.)
2. Speakers of 8Ω Impedance, 15W Nom. Power, 30W Max. Power is recommended.

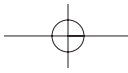

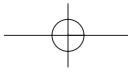

Installing the Speakers (continued)



Parts

The actual product may differ slightly from the illustration.

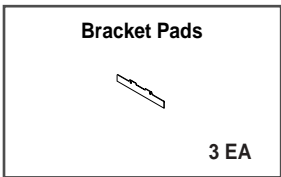
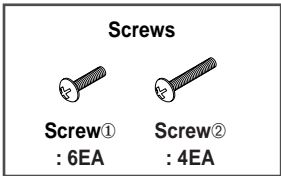
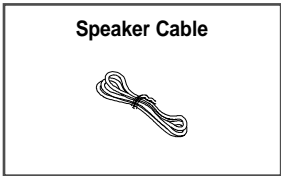
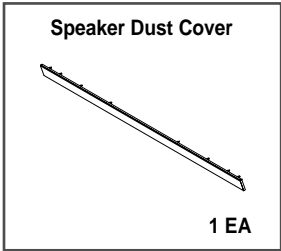
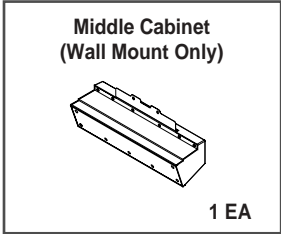
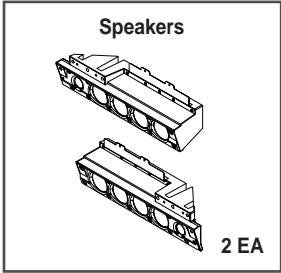

How to Assemble the Speakers (Wall Mount)

① Remove the screws indicated on the rear of the PDP (6 screws on the left and right sides, 2 screws on the center).

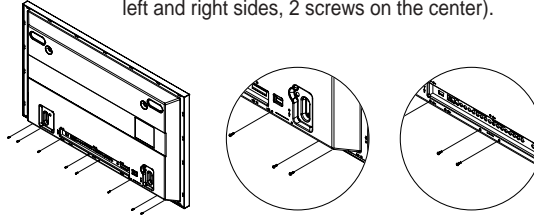

② Attach the Bracket Pads to the Speaker's Guide Bracket. Set the Speaker Guide Bracket into the square grooves located on either side of the PDP's bottom rear and secure it with the provided screws ①, ②. Secure the Middle Cabinet to the center of the PDP with a screw ①. (Always use the proper screws, as indicated.)

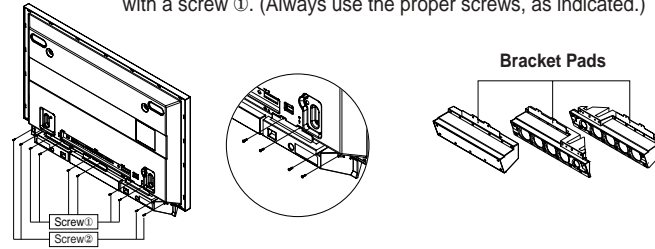

③ Secure the Speaker Dust Cover by setting it into the grooves located on the front side of the speakers.

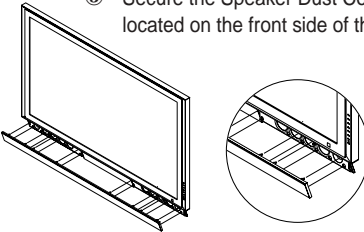

④ Connect the speakers to the PDP using the speaker cable. The connection terminals are on the rear side of both the PDP and the speakers. (Match the color coded terminals and cables.)

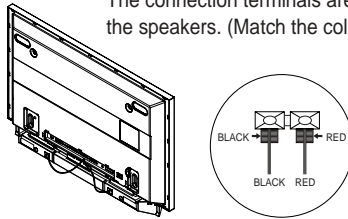

WARNING

1. When moving the PDP with the speakers attached, be sure to hold on to the PDP to prevent damage. (Damage may occur to the speaker connecting brackets or the speakers.)
2. Speakers of 8Ω Impedance, 15W Nom. Power, 30W Max. Power is recommended.

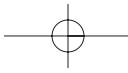

Setting up Your PC Software (Windows only)

ENG

The Windows display-settings for a typical computer are shown below. But the actual screens on your PC will probably be different, depending upon your particular version of Windows and your particular video card. But even if your actual screens look different, the same, basic set-up information will apply in almost all cases. (If not, contact your computer manufacturer or Samsung Dealer.)



On the windows screen, select in the following sequence: **Start → Settings → Control Panel.**



When the control panel screen appears, click on **Display** and a display dialog-box will appear.



Select the **Settings** tab in the display dialog-box.

The two key variables that apply the television-PC interface are "Resolution" and "Colours". The correct settings for these two variables are:

- ◆ Size (sometimes called "Resolution")
- **1024 x 768 pixels**

- ◆ Colour
32-bit colour
Shown at left is a typical screen for "Display" dialog box.

If a vertical-frequency option exists on your display settings dialog box, the correct value is **60 Hz**. Otherwise, just click **OK** and exit the dialog box.

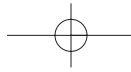

Input Mode (PC/DVI)

ENG

Both screen position and size will vary depending on the type of PC monitor and its resolution. The table below shows all of the display modes that are supported:

Video Signal	Dot x Line	Vertical frequency (Hz)	Horizontal frequency (kHz)	Vertical polarity	Horizontal polarity	
IBM PC / AT Compatible	640 x 350	70.086	31.469	N	P	
		85.080	37.861	N	P	
	640 x 400	85.080	37.861	P	N	
		720 x 400	70.087	31.469	P	N
			85.039	37.927	P	N
	640 x 480	800 x 600	59.940	31.469	N	N
			72.809	37.861	N	N
			75.000	37.500	N	N
			85.008	43.269	N	N
		56.250	35.156	N/P	N/P	
		60.317	37.879	P	P	
		72.188	48.077	P	P	
		75.000	46.875	P	P	
		85.061	53.674	P	P	
	848 x 480	1024 x 768	60.000	29.838	nVidia chipset	
			72.000	36.072		
			75.000	37.650		
		60.004	48.363	N	N	
		70.069	56.476	N	N	
		75.029	60.023	P	P	
	84.997	68.677	P	P		

(N: Negative / P: Positive)

- ◆ The interlace mode is not supported.
- ◆ The television might operate abnormally if a non-standard video format is selected.

Notes

- ◆ The PC text quality for **PS42P4A** is optimum in **XGA** mode (1024 x 768).
- ◆ When this television is used as a PC display, 32-bit colour is supported.
- ◆ Your PC display screen might appear different depending on the manufacturer (and your particular version of Windows). Check your PC instruction book for information about connecting your PC to a television.
- ◆ If a vertical and horizontal frequency-select mode exists, select 60Hz (vertical) and 48.3kHz (horizontal). In some cases, abnormal signals (such as stripes) might appear on the screen when the PC power is turned off (or if the PC is disconnected). If so, press the **SOURCE** button to enter the Video mode. Also, make sure that the PC is connected.
- ◆ When connecting a notebook PC to the television, make sure that the PC screen is displayed through only the television (Otherwise, random signals might appear).
- ◆ When horizontal synchronous signals seem irregular in PC mode, check PC power saving mode or cable connections.
- ◆ The Display Settings Table above complies to the IBM/VESA standards, and based on the analog input.
- ◆ The DVI support mode is regarded as same to the PC support mode.
- ◆ The best timing for the vertical frequency to each mode is 60Hz.



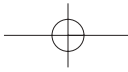

Pin Configurations



SCART Connector (AV1/AV2/AV3)

➤ Pins 5, 7, 9, 11, 13, 15 and 16 are used for RGB processing and are only wired on the **AV1** or **AV2** or **AV3** connector.



Pin	Signal	Pin	Signal
1	Audio output R	12	-
2	Audio input R	13	Video chassis return (RGB red)
3	Audio output L	14	-
4	Audio chassis return	15	RGB red input
5	Video chassis return (RGB blue)	16	Blanking signal (RGB switching)
6	Audio input L	17	Video chassis return
7	RGB blue input	18	Blanking signal ground
8	Switching voltage	19	Video output
9	Video chassis return (RGB green)	20	Video input
10	AV-Link (Ext 1)	21	Screening/chassis return
11	RGB green input		

PC Input Connector (15Pin)

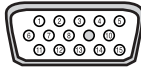

Pin	PC IN
1	Red (R)
2	Green (G)
3	Blue (B)
4	Grounding
5	Grounding (DDC)
6	Red (R) Grounding
7	Green (G) Grounding
8	Blue (B) Grounding
9	Reserved
10	Sync Grounding
11	Grounding
12	Data (DDC)
13	Horizontal sync.
14	Vertical sync.
15	Clock (DDC)

DVI Input Connector (24Pin)



Pin	Signal
1	T.M.D.S. Data2-
2	T.M.D.S. Data2+
3	T.M.D.S. Data2/4 Shield
4	T.M.D.S. Data4-
5	T.M.D.S. Data4+
6	Clock (DDC)
7	Data (DDC)
8	Not Connected
9	T.M.D.S. Data1-
10	T.M.D.S. Data1+
11	T.M.D.S. Data1/3 Shield
12	T.M.D.S. Data3-
13	T.M.D.S. Data3+
14	+5V Power
15	5V Grounding
16	Hot Plug Detect
17	T.M.D.S. Data0-
18	T.M.D.S. Data0+
19	T.M.D.S. Data0/5 Shield
20	T.M.D.S. Data5-
21	T.M.D.S. Data5+
22	T.M.D.S. Clock Shield
23	T.M.D.S. Clock+
24	T.M.D.S. Clock-

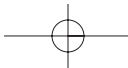

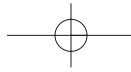

Troubleshooting: Before Contacting Service Personnel

ENG

Before contacting Samsung after-sales service, perform the following simple checks.

If you cannot solve the problem using the instructions below, note the model and serial number of the television and contact your local dealer.

No sound or picture	<ul style="list-style-type: none"> ◆ Check that the mains lead has been connected to a wall socket. ◆ Check that you have pressed the "I" button (On/Off) and the POWER (⏻) button. ◆ Check the picture contrast and brightness settings. ◆ Check the volume.
Normal picture but no sound	<ul style="list-style-type: none"> ◆ Check the volume. ◆ Check whether the volume MUTE (⏻) button on the remote control has been pressed.
No picture or black and white picture	<ul style="list-style-type: none"> ◆ Adjust the colour settings. ◆ Check that the broadcast system selected is correct.
Sound and picture interference	<ul style="list-style-type: none"> ◆ Try to identify the electrical appliance that is affecting the television, then move it further away. ◆ Plug your television into a different mains socket.
Blurred or snowy picture, distorted sound	<ul style="list-style-type: none"> ◆ Check the direction, location and connections of your aerial. This interference often occurs due to the use of an indoor aerial.
Remote control malfunctions	<ul style="list-style-type: none"> ◆ Replace the remote control batteries. ◆ Clean the upper edge of the remote control (transmission window). ◆ Check the battery terminals.

Programming the Remote Control for Other Components



CABLE CODE LIST

Anvision	017, 018
GI	041
Hamlin	003, 024, 031
Hitachi	025, 030
Jerrold	038, 039
Macom	025, 030
Magnavox	019, 023, 028
Oak	026
Panasonic	003, 022, 027, 037, 044
Philips	019, 021, 023, 028
Pioneer	018, 020, 004, 044
RCA	014, 022, 040
Regal	003
Regency	015, 023
SA	042, 043
Samsung	000, 001, 002, 003, 004, 005, 006, 007
Scientific Atlanta	042, 043
Sprucer	022
Stargate 2000	036
Sylvania	016
Texscan	016
Tocom	032
Universal	033, 034
Viewstar	019, 021, 023, 028
Wamer amex	046
Zenith	017, 029, 035, 037, 045

DVD CODE LIST

Samsung	000
Samsung	001
JVC	002
PROSCAN, RCA	003
Panasonic	005
LG(Goldstar)	006
Sony	007
Denon	008
Curtis Mathes	009

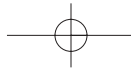

Programming the Remote Control for Other Components (continued)

ENG

VCR CODE LIST

Admiral	020	NEC	018, 007, 026, 037, 008, 062, 064
Aiwa	025	Optimus	020
Akai	027, 004, 032	Panasonic	021, 056, 071, 072
Audio Dynamics	007, 026	Pentax	019, 041
Bell&Howell	018	Pentax Research	008
Broksonic	022	Philco	021, 036, 056, 059
Candle	002, 006, 003, 015, 008, 055	Philips	021, 036
Canon	021, 056	Pioneer	019, 026, 039, 053
Citizen	002, 006, 003, 015, 008, 055	Portland	015, 049, 055
Colortyme	007	PROSCAN	017
Craig	002, 024	Quartz	018
Curtis Mathes	002, 017, 007, 008, 021, 025, 056, 064, 066	Quasar	021, 056
Daewoo	003, 015, 010, 011, 012, 013, 014, 016	Radio Shack/Realistic	006, 018, 020, 021, 024, 025, 029, 034, 048, 056
DBX	007, 026	RCA	017, 019, 002, 021, 035, 041, 043, 057, 068
Dimensia	017	Samsung	000, 001, 002, 003, 004, 005
Dynatech	034	Sansui	026
Emerson	001, 003, 006, 021, 022, 025, 030, 032, 034, 040, 047, 050, 052, 060, 063, 065, 066, 067, 069	Sanyo	018, 024
Fisher	018, 024, 028, 029, 048, 051, 061	Scott	003, 047, 052, 067
Funai	025	Sears	018, 019, 006, 024, 028, 029, 041, 048, 051
General Electric	017, 002, 021, 005, 056	Sharp	020, 034, 045, 015
Go Video	002	Shimom	027, 033, 038, 058
LG(Goldstar)	006, 007, 008, 009, 010	Signature	025
Harman Kardon	007	Sony	027, 033, 044
Hitachi	019, 025, 041, 042	Sylvania	021, 025, 036, 056, 059
Instant Replay	021	Symphonic	025
JC Penny	002, 007, 018, 019, 021, 026, 037, 041, 054, 056	Tandy	018, 025
JVC	007, 008, 018, 021, 026, 037	Tashika	006
Kenwood	007, 008, 018, 026, 037	Tatung	037
KLH	070	Teac	025, 037, 068
Lloyd	025	Technics	021
Logik	038	Teknika	021, 006, 025, 031
LXI	025	TMK	066
Magnavox	021, 036, 056, 059	Toshiba	003, 019, 029, 051, 052
Marantz	018, 021, 007, 026, 037, 008, 062, 036	Totevision	002, 006
Marta	006	Unitech	002
MEI	021	Vector Research	007, 026
Memorex	006, 021, 024, 025	Victor	026
MGA	034	Video Concepts	007, 026
Midland	005	Videosonic	002
Minolta	019, 041	Wards	002, 003, 006, 019, 020, 021, 024, 025, 034, 038, 041
Mitsubishi	019, 034, 041, 046	Yamaha	007, 008, 018, 026, 037
Montgomery Ward	020	Zenith	023, 027, 033, 073
MTC	002, 025		
Multitech	002, 025, 038, 005		



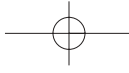

- AFTER SALES SERVICE

- Do not hesitate to contact your retailer or service agent if a change in the performance of your product indicates that a faulty condition may be present.

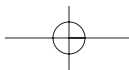

Free Manuals Download Website

<http://myh66.com>

<http://usermanuals.us>

<http://www.somanuals.com>

<http://www.4manuals.cc>

<http://www.manual-lib.com>

<http://www.404manual.com>

<http://www.luxmanual.com>

<http://aubethermostatmanual.com>

Golf course search by state

<http://golfingnear.com>

Email search by domain

<http://emailbydomain.com>

Auto manuals search

<http://auto.somanuals.com>

TV manuals search

<http://tv.somanuals.com>