



Contact SAMSUNG WORLDWIDE

If you have any questions or comments relating to Samsung products, please contact the SAMSUNG customer care centre.

Country	Customer Care Centre ☎	Web Site
AUSTRALIA	1300 362 603	www.samsung.com/au
CHINA	400-810-5858 010-6475 1880	www.samsung.com/cn
HONG KONG	3698 - 4698	www.samsung.com/hk www.samsung.com/hk_en/
INDIA	3030 8282 1-800-3000-8282 1800 110011	www.samsung.com/in
INDONESIA	0800-112-8888	www.samsung.com/id
JAPAN	0120-327-527	www.samsung.com/jp
MALAYSIA	1800-88-9999	www.samsung.com/my
NEW ZEALAND	0800 SAMSUNG (0800 726 786)	www.samsung.com/nz
PHILIPPINES	1-800-10-SAMSUNG(726-7864) 1-800-3-SAMSUNG(726-7864) 1-800-8-SAMSUNG(726-7864) 02-5805777	www.samsung.com/ph
SINGAPORE	1800-SAMSUNG(726-7864)	www.samsung.com/sg
THAILAND	1800-29-3232 02-689-3232	www.samsung.com/th
TAIWAN	0800-329-999	www.samsung.com/tw
VIETNAM	1 800 588 889	www.samsung.com/vn
SOUTH AFRICA	0860-SAMSUNG(726-7864)	www.samsung.com/za
U.A.E	800-SAMSUNG (726-7864) 8000-4726	www.samsung.com/ae

SERIES
4

LCD TV user manual

imagine the possibilities

Thank you for purchasing this Samsung product.
To receive more complete service, please register
your product at

www.samsung.com/register

Model _____ Serial No. _____



BN68-01928A-02

Figures and illustrations in this User Manual are provided for reference only and may differ from actual product appearance. Product design and specifications may be changed without notice.

□ License



TruSurround HD, SRS and  symbol are trademarks of SRS Labs, Inc. TruSurround HD technology is incorporated under license from SRS Labs, Inc.

□ Precautions When Displaying a Still Image

A still image may cause permanent damage to the TV screen

- Do not display still image and partially still on the LCD panel for more than 2 hours as it can cause screen image retention. This image retention is also known as screen burn. To avoid such image retention, reduce the degree of brightness and contrast of the screen when displaying a still image.
-  Watching the LCD TV in 4:3 format for a long period of time may leave traces of borders displayed on the left, right and centre of the screen caused by the difference of light emission on the screen. Playing a DVD or a game console may cause a similar effect to the screen. Damages caused by the above effect are not covered by the Warranty.
- Displaying still images from Video games and PC for longer than a certain period of time may produce partial after-images. To prevent this effect, reduce the 'brightness' and 'contrast' when displaying still images.

CONTENTS

SETTING UP YOUR TV

■ Viewing the Control Panel	2
■ Accessories	3
■ Viewing the Connection Panel	4
■ Viewing the Remote Control	6
■ Installing Batteries in the Remote Control	7

OPERATION

■ Viewing the menus	7
■ Placing Your Television in Standby Mode	8
■ Plug & Play Feature	8

CHANNEL

■ Channel Menu	9
----------------------	---

PICTURE

■ Configuring the Picture Menu	11
■ Viewing Picture-in-Picture	14
■ Using Your TV as a Computer (PC) Display	15
■ Setting up the TV with your PC	16

SOUND

■ Configuring the Sound Menu	16
■ Selecting the Sound Mode	17

SETUP

■ Configuring the Setup Menu	18
------------------------------------	----

INPUT

■ Input Menu	20
--------------------	----

RECOMMENDATIONS

■ Teletext Feature	21
■ Installing the Stand (LA32B450)	22
■ Installing the Stand (LA32B460)	23
■ Disconnecting the Stand	23
■ Installing the Wall Mount Kit	23
■ Assembling the Cables (LA32B460)	24
■ Anti-Theft Kensington Lock	24
■ Securing the Installation Space	24
■ Securing the TV to the Wall	25
■ Troubleshooting	26
■ Specifications	29

□ Symbol



Note



One-Touch Button



TOOLS Button







Press

SETTING UP YOUR TV

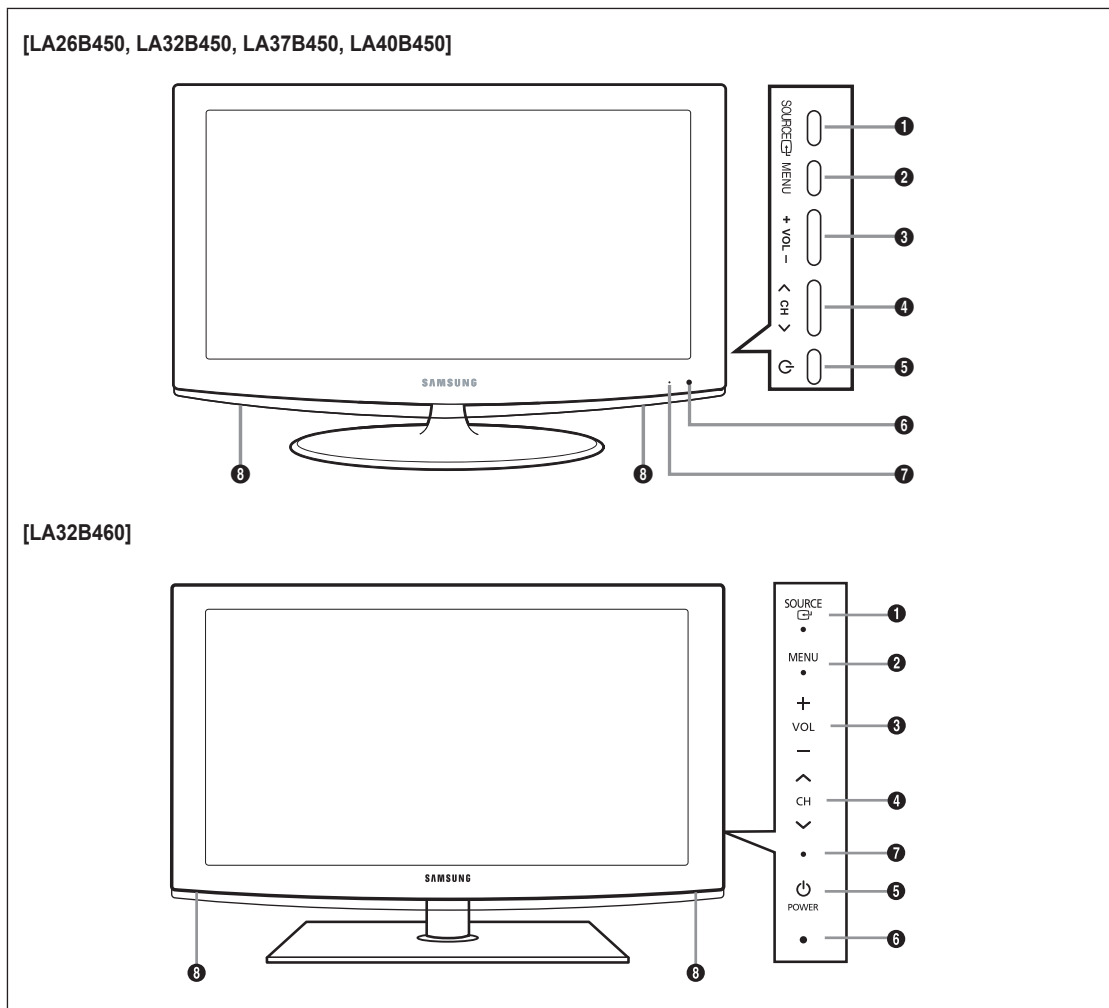
Viewing the Control Panel

- ☑ The product colour and shape may vary depending on the model.
- ☑ You can use a button by pressing the side panel buttons. (LA26B450, LA32B450, LA37B450, LA40B450)
- ☑ The front panel buttons can be activated by touching them with your finger. (LA32B460)



- 1 SOURCE** : Toggles between all the available input sources. In the on-screen menu, use this button as you would use the **ENTER**  button on the remote control.
- 2 MENU**: Press to see an on-screen menu of your TV's features.
- 3 -VOL+**: Press to increase or decrease the volume.
In the on-screen menu, use the **-VOL+** buttons as you would use the **<** and **>** buttons on the remote control.
- 4 <CH >**: Press to change channels. In the on-screen menu, use the **<CH >** buttons as you would use the **>** and **<** buttons on the remote control.
- 5**  (**POWER**): Press to turn the TV on and off.
- 6 REMOTE CONTROL SENSOR**: Aim the remote control towards this spot on the TV.
- 7 POWER INDICATOR**: Blinks and turns off when the power is on and lights up in stand-by mode.
- 8 SPEAKERS**

Accessories



Remote Control & Batteries (AAA x 2)



Power Cord



(M4 X L16)

Stand Screw X 4
(Depending on the model)

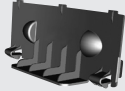

Cover-Bottom



Cleaning Cloth



(M4 X L14)

Stand Screw X 3
(Depending on the model)



Holder-Wire Cable
(Depending on the model)

• Owner's Instructions

• Warranty card

• Safety Guide

• Registration Cards

- Please make sure the following items are included with your LCD TV. If any items are missing, contact your dealer.
- Warranty card / Safety Guide / Registration Cards (Not available in all locations)
- The items colour and shape may vary depending on the model.

Viewing the Connection Panel

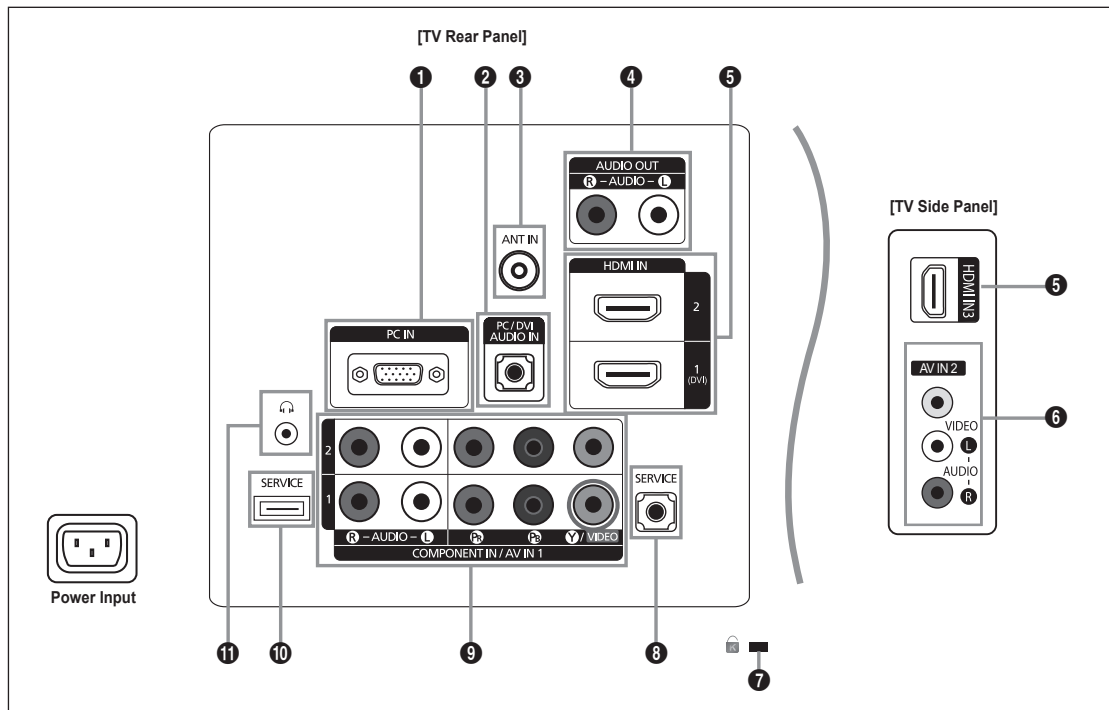

☑ The product colour and shape may vary depending on the model.

1 PC IN

– Connect to the video output jack on your PC.

☑ If your PC supports an HDMI connection, you can connect this to the **HDMI IN 1 (DVI)**, 2 or 3 terminal.

☑ If your PC supports a DVI connection, you can connect this to the **HDMI IN 1 (DVI)** / **PC/DVI AUDIO IN** terminal.

2 PC/DVI AUDIO IN

– Connect to the audio output jack on your PC.

– DVI audio outputs for external devices.

3 ANT IN

– Connects to an antenna or cable TV system.

4 AUDIO OUT [R-AUDIO-L]

– Connect RCA audio cables to **AUDIO OUT [R-AUDIO-L]** on the rear of your set and the other ends to corresponding audio in connectors on the Amplifier or DVD Home Theatre.

5 HDMI IN 1(DVI), 2, 3

Connects to the HDMI jack of a device with an HDMI output.

☑ No additional Audio connection is needed for an HDMI to HDMI connection.

☑ What is HDMI?

- HDMI(High-Definition Multimedia Interface), is an interface that enables the transmission of digital audio and video signals using a single cable.

- The difference between HDMI and DVI is that the HDMI device is smaller in size and has the HDCP (High Bandwidth Digital Copy Protection) coding feature installed.

☑ Use the **HDMI IN 1(DVI)** jack for DVI connection to an external device. Use a DVI to HDMI cable or DVI-HDMI adapter (DVI to HDMI) for video connection and the **PC/DVI AUDIO IN** jacks for audio. When using an HDMI / DVI cable connection, you must use the **HDMI IN 1(DVI)** jack.

6 AV IN 2 [VIDEO] / [R-AUDIO-L]

- Connect RCA cable to an appropriate external A/V device such as VCR, DVD or Camcorder.
- Connect RCA audio cables to **[R-AUDIO-L]** on your set and the other ends to corresponding audio out connectors on the A/V device.

7 KENSINGTON LOCK (depending on the model)

- The Kensington Lock (optional) is a device used to physically fix the system when used in a public place. If you want to use a locking device, contact the dealer where you purchased the TV.

 The location of the Kensington Lock may be different depending on its model.

8 SERVICE

- Connector for service only.

9 COMPONENT IN 1, 2 / AV IN 1

- Connect component video cables (optional) to component connector (P_R, P_B, Y) on the rear of your set and the other ends to corresponding component video out connectors on the DVD.
- If you wish to connect both the Set-Top Box and DVD, you should connect the Set-Top Box to the DVD and connect the DVD to component connector (P_R, P_B, Y) on your set.
- The P_R, P_B and Y connectors on your component devices DVD are sometimes labeled Y, B-Y and R-Y or Y, Cb and Cr.
- Connect RCA audio cables (optional) to **[R-AUDIO-L]** on the rear of your set and the other ends to corresponding audio out connectors on the DVD.
- The **COMPONENT IN 1** jack is also used as the **AV IN 1** jack.
- When connecting to **AV IN 1**, the colour of the **AV IN 1 [Y/VIDEO]** jack (Green) does not match the colour of the video cable (Yellow).

10 SERVICE

- Connector for service only.

11  (HEADPHONE)

- Headphone may be connected to the headphone output on your set. While the head phone is connected, the sound from the built-in speakers will be disabled.

 Using the sound function is restricted when connecting headphones to the TV.

 Prolonged use of headphones at a high volume may damage your hearing.

 You will not hear sound from the speakers when you connect headphones to the TV.

 The headphone volume and TV volume are adjusted separately.

Viewing the Remote Control

- ☑ You can use the remote control up to a distance of about 23 feet from the TV.
- ☑ The performance of the remote control may be affected by bright light.
- ☑ The product colour and shape may vary depending on the model.

- 1 POWER** : Turns the TV on and off.
- 2 NUMERIC BUTTONS** : Press to change the channel.
- 3** : Performs the same function as the **ENTER** button of the directional buttons. When switching channels with the numeric buttons, and you press the channel number and then the **ENTER** button, the channel is immediately switched.
- 4** : Press to increase or decrease the volume.
- 5 SOURCE** : Press to display and select the available video sources.
- 6 CH LIST** : Displays the Channel List on screen.
- 7 TOOLS** : Use to quickly select frequently used functions.
- 8 INFO** : Press to display information on the TV screen.
- 11 TV** : Selects the TV mode directly.
- 12 PRE-CH** : Enables you to return to the previous channel you were watching.
- 13 MUTE** : Press to temporarily cut off the sound.
- 14** : Press to change channels.

- 15 MENU** : Displays the main on-screen menu.
- 16 HDMI** : Selects the HDMI mode directly.
- 17 RETURN** : Returns to the previous menu
- 18 UP ▲ / DOWN ▼ / LEFT ◀ / RIGHT ▶ / ENTER** : Use to select on-screen menu items and change menu values.
- 19 EXIT** : Press to exit the menu.
- 20 P.SIZE** : Picture size selection
- 21 S.MODE** : Sound mode selection.

Teletext Functions

- 5** : Teletext mode selection (LIST / FLOF)
- 6** : Teletext store
- 7** : Teletext size selection
- 8** : Teletext reveal
- 9** Fastext topic selection
- 10** : Alternately select Teletext, Double, or Mix.
- 11** : Exit from the Teletext display
- 12** : Teletext sub page
- 14** : Teletext next page
 : Teletext previous page
- 15** : Teletext index
- 17** : Teletext hold
- 19** : Teletext cancel

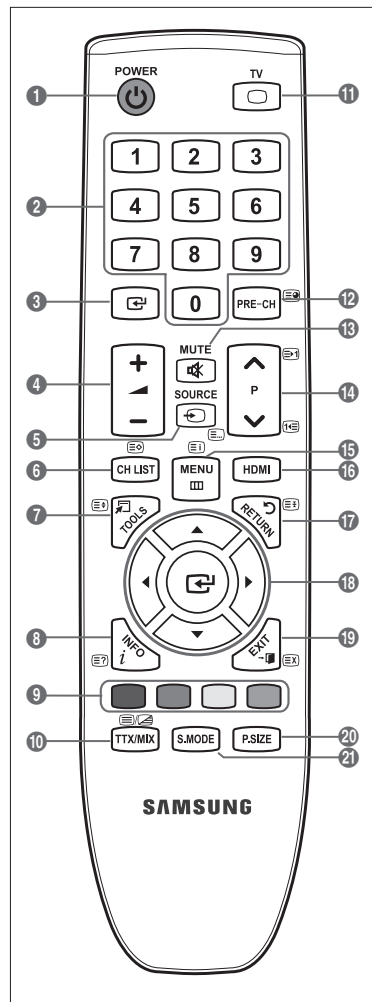

Installing Batteries in the Remote Control

- Lift the cover at the back of the remote control upward as shown in the figure.
- Install two AAA size batteries.
 - Make sure to match the '+' and '-' ends of the batteries with the diagram inside the compartment.
- Replace the cover.
 - Remove the batteries and store them in a cool, dry place if you won't be using the remote control for a long time.
- If the remote control doesn't work, check the following:
 - Is the TV power on?
 - Are the plus and minus ends of the batteries reversed?
 - Are the batteries drained?
 - Is there a power outage or is the power cord unplugged?
 - Is there a special fluorescent light or neon sign nearby?

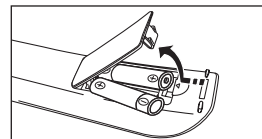

OPERATION

Viewing the menus

Before using the TV, follow the steps below to learn how to navigate the menu in order to select and adjust different functions.

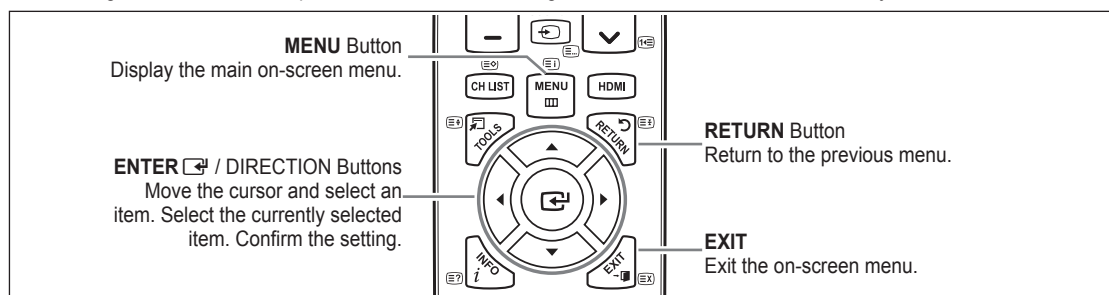

□ Operation the OSD (On Screen Display)

The access step may differ depending on the selected menu.



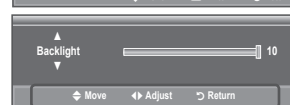
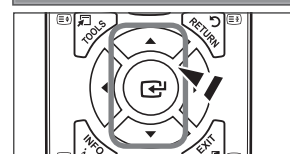

- Press the **MENU** button.
- The main menu appears on the screen. The menu's left side has icons : **Picture, Sound, Channel, Setup, Input**.
- Press the **▲** or **▼** button to select one of the icons.
- Then press the **ENTER** button to access the icon's sub-menu.
- Press the **▲** or **▼** button to select the icon's submenu.
- Press the **◀** or **▶** button to decrease or increase the value of a particular item. The adjustment OSD may differ depending on the selected menu.
- Press the **ENTER** button to complete the configuration. Press the **EXIT** button to exit.



Help icon























Placing Your Television in Standby Mode

Your set can be placed in standby mode in order to reduce the power consumption. The standby mode can be useful when you wish to interrupt viewing temporarily (during a meal, for example).



1. Press the **POWER**  button on the remote control.
 -  The screen is turned off and a standby indicator appears on your set.
2. To switch your set back on, simply press the **POWER**  button again.
 -  Do not leave your set in standby mode for long periods of time (when you are away on holiday, for example). It is best to unplug the set from the mains and aerial.

Plug & Play Feature

When the TV is initially powered on, basic settings proceed automatically and subsequently.

1. Press the **POWER**  button on the remote control.
 -  You can also use the **POWER**  button on the TV.
2. Press the **▲** or **▼** button to select the language, then press the **ENTER**  button.
3. Press the **◀** or **▶** button to select **Store Demo** or **Home Use**, then the **ENTER**  button.
 -  We recommend setting the TV to **Home Use** mode for the best picture in your home environment.
 -  **Store Demo** mode is only intended for use in retail environments.
 -  If the unit is accidentally set to **Store Demo** mode and you want to return to **Home Use** (Standard): Press the volume button on the TV. When the volume OSD is displayed, press and hold the **MENU** button on the TV for 5 seconds.
4. The message **Check antenna input.** is displayed with **OK** selected.
Press the **ENTER**  button.
 -  Please check that the antenna cable is connected correctly.
5. Select the appropriate area by pressing the **▲** or **▼** button.
Press the **ENTER**  button to confirm your choice.
6. The **Auto Store** menu is displayed with the **Start** selected. Press the **ENTER**  button.
 -  The channel search will start and end automatically.
 -  Press the **ENTER**  button at any time to interrupt the memorization process.
 -  After all the available channels are stored, the **Clock Set** menu appears.
7. Press the **ENTER**  button.
Select the **Month**, **Day**, **Year**, **Hour**, **Minute**, or **am/pm** by pressing the **◀** or **▶** button.
Set the **Month**, **Day**, **Year**, **Hour**, **Minute**, or **am/pm** by pressing the **▲** or **▼** button.
 -  You can also set the **Month**, **Day**, **Year**, **Hour** and **Minute** by pressing the number buttons on the remote control.
8. Press the **ENTER**  button to confirm your setting. The message **Enjoy your TV.** is displayed.
When you have finished, press the **ENTER**  button.
 -  Even if the **ENTER**  button is not pressed, the message will automatically disappear after several seconds.

If you want to reset this feature...

1. Press the **MENU** button to display the menu. Press the **▲** or **▼** button to select **Setup**, then press the **ENTER**  button.
2. Press the **ENTER**  button again to select **Plug & Play**.
 -  The **Plug & Play** feature is only available in the TV mode.

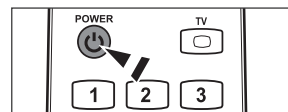

CHANNEL

Channel Menu

□ Area

You can change the area for channels.

□ Auto Store

You can scan for the frequency ranges available to you (and availability depends on your area). Automatically allocated programme numbers may not correspond to actual or desired programme numbers.

- ☑ Scans for all channels with active broadcast stations and stores them in the TV's memory.
- ☑ If you want to stop Auto Store, press the **ENTER**  button.



□ Manual Store



- ☑ Scans for a channel manually and stores it in the TV's memory.
- **Programme** (Programme number to be assigned to a channel): Sets the programme number using the **▲**, **▼** or number (0~9) buttons.
- **Colour System** → **Auto / PAL / SECAM / NTSC4.43 / NTSC 3.58**: Sets the colour system value using the **▲** or **▼** button.
- **Sound System** → **BG / DK / I / M**: Sets the sound system value using the **▲** or **▼** button.
- **Channel** (When you know the number of the channel to be stored): Press the **▲** or **▼** button to select **C** (Air channel) or **S** (Cable channel). Press the **▶** button, then press the **▲**, **▼** or number (0~9) buttons to select the required number.
 - ☑ You can also select the channel number directly by pressing the number (0~9) buttons.
 - ☑ If there is abnormal sound or no sound, reselect the sound standard required.
- **Search** (When you do not know the channel numbers): Press the **▲** or **▼** button to start the search. The tuner scans the frequency range until the first channel or the channel that you selected is received on the screen.
- **Store** (When you store the channel and associated programme number): Set to **OK** by pressing the **ENTER**  button.
 - ☑ **Channel mode**
 - **P** (Programme mode): When completing tuning, the broadcasting stations in your area have been assigned to position numbers from P00 to P99. You can select a channel by entering the position number in this mode.
 - **C** (Air channel mode): You can select a channel by entering the assigned number to each air broadcasting station in this mode.
 - **S** (Cable channel mode): You can select a channel by entering the assigned number for each cable channel in this mode.

□ Channel List

Using the **Channel List**, you can conveniently lock or add channels.





Adding channels

Using the Channel List, you can add channels.

- Move to the  field by pressing the **▲**, **▼**, **◀** or **▶** button, select a channel to be added, and press the **ENTER**  button to add the channel.
- If you press the **ENTER**  button again, the **✓** symbol next to the channel disappears and the channel is not added.

Locking channels

This feature allows you to prevent unauthorized users, such as children, from watching unsuitable programmes by muting out video and audio.

- ☑  is active when **Child Lock** is selected to **On**. (refer to page 18)
 - Move to the  field by pressing the **▲**, **▼**, **◀** or **▶** button, select a channel to be locked, and press the **ENTER**  button.
 - ☑ The PIN number input screen appears. Enter your 4 digit PIN number.
 - ☑ If you press the **ENTER**  button again, the **✓** symbol next to the channel disappears and the channel lock is cancelled.
 - ☑ A blue screen is displayed when **Child Lock** is activated.
 - ☑ Select **On** or **Off** in **Child Lock** to easily turn the channels which selected on  to be active or inactive.
- ☑ You can select these options by simply pressing the **CH LIST** button on the remote control.

Sort

This operation allows you to change the programme numbers of the stored channels.

This operation may be necessary after using the auto store.

The channel is moved to its new position and all other channels are shifted accordingly.

Name

Channel names will be assigned automatically when channel information is broadcast. These names can be changed, allowing you to assign new names.

The following characters are available: Letters of the alphabet (A~Z) / Numbers (0~9) / Special characters (+, -, *, /, space)

Fine Tune

If the reception is clear, you do not have to fine tune the channel, as this is done automatically during the search and store operation. If the signal is weak or distorted, you may have to fine tune the channel manually.

Fine tuned channels that have been saved are marked with an asterisk "*" on the right-hand side of the channel number in the channel banner.

To reset the fine-tuning, select **Reset** by pressing the ▲ or ▼ button and then press the **ENTER**  button.

Only TV channels can be fine tuned.

PICTURE

Configuring the Picture Menu

□ Mode

You can select the type of picture which best corresponds to your viewing requirements.

✎ Press the **TOOLS** button to display the **Tools** menu. You can also set the picture mode by selecting **Tools** → **Picture Mode**.

✎ The Picture mode must be adjusted separately for each input source.

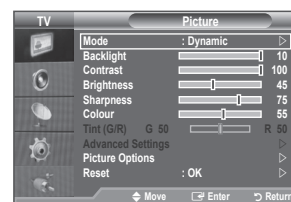

■ Dynamic

Selects the picture for increased definition in a bright room.

■ Standard

Selects the picture for the optimum display in a normal environment.

■ Movie

Selects the picture for viewing movies in a dark room.

□ Backlight / Contrast / Brightness / Sharpness / Colour / Tint (G/R)

Your television has several setting options that allow you to control the picture quality.

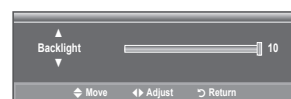

■ Backlight

Adjusts the brightness of LCD back light.

■ Contrast

Adjusts the contrast level of the picture.

■ Brightness

Adjusts the brightness level of the picture

■ Sharpness

Adjusts the edge definition of the picture.

■ Colour

Adjusts colour saturation of the picture.

■ Tint (G/R)

Adjusts the colour tint of the picture.

✎ In **TV, AV1, AV2** modes of the PAL system, you cannot use the **Tint (G/R)** Function.

✎ When you make changes to **Backlight, Contrast, Brightness, Sharpness, Colour** or **Tint (G/R)**, the OSD will be adjusted accordingly.

✎ In PC mode, you can only make changes to **Backlight, Contrast** and **Brightness**.

✎ Settings can be adjusted and stored for each external device you have connected to an input of the TV.

✎ The energy consumed during use can be significantly reduced if the brightness level of the picture is lowered, which will reduce the overall running cost.

❑ Advanced Settings

Samsung's new TVs allow you to make even more precise picture settings than previous models.

- 🔍 **Advanced Settings** is available in **Standard** or **Movie** mode.
- 🔍 In PC mode, you can only make changes to **Gamma** and **White Balance** from among the **Advanced Settings** items.

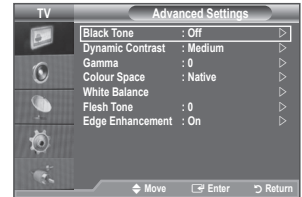

■ Black Tone → Off / Dark / Darker / Darkest

You can select the black level on the screen to adjust the screen depth.

■ Dynamic Contrast → Off / Low / Medium / High

You can adjust the screen contrast so that the optimal contrast is provided.

■ Gamma

You can adjust the primary colour (red, green, blue) Intensity.

■ Colour Space

Colour Space is a colour matrix composed of red, green and blue colours. Select your favourite colour space to experience the most natural colour.

- **Auto:** Auto Colour Space automatically adjusts to the most natural colour tone based on programme sources.
- **Native:** Native Colour Space offers deep and rich colour tone.

■ White Balance

You can adjust the colour temperature for more natural picture colours.

- **R-Offset:** Adjusts the red colour darkness.
- **G-Offset:** Adjusts the green colour darkness.
- **B-Offset:** Adjusts the blue colour darkness.
- **R-Gain:** Adjusts the red colour brightness.
- **G-Gain:** Adjusts the green colour brightness.
- **B-Gain:** Adjusts the blue colour brightness.
- **Reset:** The previously adjusted white balance will be reset to the factory defaults.

■ Flesh Tone

You can emphasize the pink 'flesh tone' in the picture.

- 🔍 Changing the adjustment value will refresh the adjusted screen.

■ Edge Enhancement → Off / On

You can emphasize object boundaries in the picture.

Picture Options

- In PC mode, you can only make changes to the **Colour Tone** and **Size** from among the items in **Picture Options**.

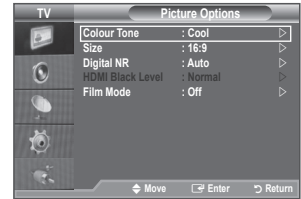







Colour Tone → Cool / Normal / Warm1 / Warm2

- Warm1** or **Warm2** is only activated when the picture mode is **Movie**.
- Settings can be adjusted and stored for each external device you have connected to an input of the TV.

Size

Occasionally, you may want to change the size of the image on your screen. Your TV comes with several screen size options, each designed to work best with specific types of video input. Your cable box/satellite receiver may have its own set of screen sizes as well. In general, though, you should view the TV in 16:9 mode as much as possible.

- Alternately, you can press the **P.SIZE** button on the remote control repeatedly to change the picture size.
 - 16:9**: Adjusts the picture size to 16:9 appropriate for DVDs or wide broadcasting.
 - Wide Zoom**: Magnify the size of the picture more than 4:3.
 - Zoom**: Magnifies the 16:9 wide picture (in the vertical direction) to fit the screen size.
 - 4:3**: This is the default setting for a video movie or normal broadcasting.
 - Screen Fit**: Use the function to see the full image without any cut-off when HDMI (720p / 1080i) or Component (1080i) signals are input.
 - Depending on the input source, the picture size options may vary.
 - The items available may differ depending on the selected mode.
 - In PC Mode, only **16:9** and **4:3** mode can be adjusted.
 - Settings can be adjusted and stored for each external device you have connected to an input of the TV.
 - Temporary image retention may occur when viewing a static image on the set for more than two hours.
 - Wide Zoom**: Move the screen up/down using the **▲** or **▼** button after selecting the  by pressing the **▶** or **ENTER** button.
 - Zoom**: Select  by pressing the **◀** or **▶** button. Use the **▲** or **▼** button to move the picture up and down. After selecting , use the **▲** or **▼** button to magnify or reduce the picture size in the vertical direction.
 - After selecting **Screen Fit** in HDMI (1080i) or Component (1080i) mode:
 - Select  by pressing the **◀** or **▶** button. Use the **▲**, **▼**, **◀** or **▶** button to move the picture.
 - Reset**: Press the **◀** or **▶** button to select **Reset**, then press the **ENTER** button.
 - You can initialize the setting.
 - If you use the **Screen Fit** function with HDMI 720p input, 1 line will be cut at the top, bottom, left and right as in the overscan function.
 - When Double (, ) mode has been set in PIP, the Picture Size cannot be set.

Digital NR → Off / Low / Medium / High / Auto

If the broadcast signal received by your TV is weak, you can activate the Digital Noise Reduction feature to help reduce any static and ghosting that may appear on the screen.

- When the signal is weak, select one of the other options until the best picture is displayed.

HDMI Black Level → Normal / Low

You can directly select the black level on the screen to adjust the screen depth.

- This function is active only when the external input connects to HDMI (RGB signals).

Film Mode → Off / Auto

The TV can be set to automatically sense and process film signals from all sources and adjust the picture for optimum quality.

- Film Mode** is supported in TV, AV, COMPONENT(480i / 1080i) and HDMI(480i / 1080i).

Picture Reset → OK / Cancel

Resets all picture settings to the default values.

Viewing Picture-in-Picture

You can use the PIP feature to simultaneously watch the TV tuner and one external video source. This product has one built-in tuner, which does not allow PIP to function in the same mode. Please see 'PIP Settings' below for details.

 Press the **TOOLS** button to display the **Tools** menu. You can also configure PIP related settings by selecting **Tools** → **PIP**.

 PIP Settings

Main picture	Sub picture
Component1, 2 HDMI1/DVI, HDMI2, HDMI3 PC	TV, AV1, AV2

 If you turn the TV off while watching in PIP mode and turn it on again, the PIP window will disappear.

 You may notice that the picture in the PIP window becomes slightly unnatural when you use the main screen to view a game or karaoke.

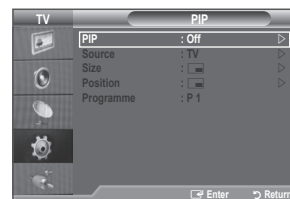

PIP → Off / On

You can activate or deactivate the PIP function.

 When watching at the 1080P resolution, setting **PIP** to **Off** is recommended for the best visual quality.

Source

You can select a source of the sub-picture.



Size → / /

You can select a size of the sub-picture.

 If main picture is in HDMI mode, **Size** is available.

Position → / / /

You can select a position of the sub-picture.

 In Double (, ) mode, **Position** cannot be selected.

Programme

You can select the channel for the sub-screen.

 **Programme** is available when the **Source** is set to **TV**.

Using Your TV as a Computer (PC) Display

Setting Up Your PC Software (Based on Windows XP)

The Windows display-settings for a typical computer are shown below. The actual screens on your PC will probably be different, depending upon your particular version of Windows and your particular video card. However, even if your actual screens look different, the same basic set-up information will apply in almost all cases. (If not, contact your computer manufacturer or Samsung Dealer.)

1. First, click on 'Control Panel' on the Windows start menu.
2. When the control panel window appears, click on 'Appearance and Themes' and a display dialog-box will appear.
3. When the control panel window appears, click on 'Display' and a display dialogbox will appear.
4. Navigate to the 'Settings' tab on the display dialog-box.
 - The correct size setting (resolution) - Optimum: 1360 X 768 pixels
 - If a vertical-frequency option exists on your display settings dialog box, the correct value is '60' or '60 Hz'. Otherwise, just click 'OK' and exit the dialog box.



Display Modes

Both screen position and size will vary depending on the type of PC monitor and its resolution. The resolutions in the table are recommended.

D-Sub and HDMI/DVI Input

Mode	Resolution	Horizontal Frequency (KHz)	Vertical Frequency (Hz)	Pixel Clock Frequency (MHz)	Sync Polarity (H / V)
IBM	640 x 350	31.469	70.086	25.175	+/-
	720 x 400	31.469	70.087	28.322	-/+
MAC	640 x 480	35.000	66.667	30.240	-/-
	832 x 624	49.726	74.551	57.284	-/-
VESA CVT	720 x 576	35.910	59.950	32.750	-/+
	1280 x 720	44.772	59.855	74.500	-/+
	1280 x 720	56.456	74.777	95.750	-/+
VESA DMT	640 x 480	31.469	59.940	25.175	-/-
	640 x 480	37.500	75.000	31.500	-/-
	640 x 480	37.861	72.809	31.500	-/-
	800 x 600	37.879	60.317	40.000	+/+
	800 x 600	46.875	75.000	49.500	+/+
	800 x 600	48.077	72.188	50.000	+/+
	1024 x 768	48.363	60.004	65.000	-/-
	1024 x 768	56.476	70.069	75.000	-/-
	1024 x 768	60.023	75.029	78.750	+/+
	1360 x 768	47.712	60.015	85.500	+/+
VESA GTF	1280 x 720	52.500	70.000	89.040	-/+

- When using an HDMI / DVI cable connection, you must use the **HDMI IN 1 (DVI)** jack.
- The interlace mode is not supported.
- The set might operate abnormally if a non-standard video format is selected.
- Separate and Composite modes are supported. SOG is not supported.

Setting up the TV with your PC

 **Preset:** Press the **SOURCE** button to select PC mode.

Auto Adjustment

Use the Auto Adjust function to have the TV automatically adjust the video signals it receives. The function also automatically fine-tunes the settings and adjusts the frequency values and positions.

 Press the **TOOLS** button to display the **Tools** menu. You can also set the Auto Adjustment by selecting **Tools** → **Auto Adjustment**.

 This function does not work in DVI-HDMI mode.

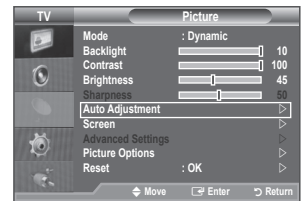

Screen

Coarse / Fine

The purpose of picture quality adjustment is to remove or reduce picture noise. If the noise is not removed by Fine-tuning alone, then adjust the frequency as best as possible (**Coarse**) and Fine-tune again. After the noise has been reduced, readjust the picture so that it is aligned on the centre of screen.

PC Position

Adjust the PC's screen positioning if it does not fit the TV screen.

Press the **▲** or **▼** button to adjusting the Vertical-Position. Press the **◀** or **▶** button to adjust the Horizontal-Position.

Image Reset

You can replace all image settings with the factory default values.

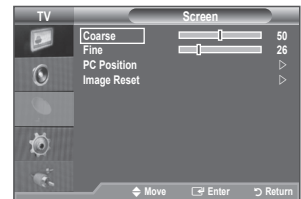

SOUND

Configuring the Sound Menu

Mode → Standard / Music / Movie / Clear Voice / Custom

 You can select these options by simply pressing the **S.MODE** button on the remote control.

- **Standard:** Selects the normal sound mode.
- **Music:** Emphasizes music over voices.
- **Movie:** Provides the best sound for movies.
- **Clear Voice:** Emphasizes voice over other sounds.
- **Custom:** Recalls your customized sound settings.

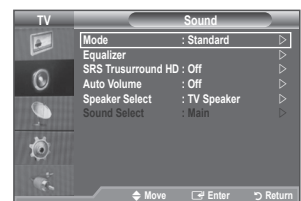

Equalizer

The sound settings can be adjusted to suit your personal preferences.

- **Balance L/R:** Adjusts the balance between the right and left speaker.
 - **100Hz / 300Hz / 1KHz / 3KHz / 10KHz (Bandwidth Adjustment):** To adjust the level of different bandwidth frequencies.
-  If you make any changes to these settings, the sound mode is automatically switched to **Custom**.

SRS TruSurround HD → Off / On

SRS TruSurround HD is a patented SRS technology that solves the problem of playing 5.1 multichannel content over two speakers. TruSurround delivers a compelling, virtual surround sound experience through any two-speaker playback system, including internal television speakers. It is fully compatible with all multichannel formats.

 Press the **TOOLS** button to display the **Tools** menu. You can also set the SRS TruSurround HD by selecting **Tools** → **SRS TruSurround HD**.

Auto Volume → Off / On

Each broadcasting station has its own signal conditions, and so it is not easy to adjust the volume every time the channel is changed. This feature lets you automatically adjust the volume of the desired channel by lowering the sound output when the modulation signal is high or by raising the sound output when the modulation signal is low.

Auto Volume is not available in Component and HDMI mode.

Speaker Select

When you watch TV with it connecting to a Home theatre, turn the TV speakers off so you can listen to sound from the Home theatre's (external) speakers.

- **External Speaker:** Used to listen to the sound of the External (Home Theatre) Speakers.
- **TV Speaker:** Used to listen to the sound of the TV Speakers.
 - The volume and **MUTE** buttons do not operate when the **Speaker Select** is set to **External Speaker**.
 - If you select **External Speaker** in the **Speaker Select** menu, the sound settings will be limited.

	TV's Internal Speakers	Audio Out (L/R Out) to Sound System
	RF / AV / Component / PC / HDMI	RF / AV / Component / PC / HDMI
TV Speaker	Sound Output	Sound Output
External Speaker	Mute	Sound Output
Video No Signal	Mute	Mute

Sound Select → Main / Sub

When the PIP feature is activated, you can listen to the sound of the sub (PIP) picture.

You can select this option when **PIP** is set to **On**.

Press the **TOOLS** button to display the **Tools** menu. You can also set the sound of the sub picture by selecting **Tools → PIP → Sound Select**.

Selecting the Sound Mode

You can set the sound mode in the **Tools** menu. When you set to **Dual I II**, the current sound mode is displayed on the screen.

	Audio Type	Dual 1 / 2	Default
A2 Stereo	Mono	MONO	Automatic change
	Stereo	STEREO ↔ MONO	
	Dual	DUAL 1 ↔ DUAL 2	DUAL 1
NICAM Stereo	Mono	MONO	Automatic change
	Stereo	MONO ↔ STEREO	
	Dual	<div style="display: flex; align-items: center; justify-content: center;"> ↔ MONO ↔ DUAL 1 ↔ </div> <div style="display: flex; align-items: center; justify-content: center;"> ↔ DUAL 2 ↔ </div>	DUAL 1

If the stereo signal is weak and an automatic switching occurs, then switch to the mono.

This function is only activated in stereo sound signal. It is deactivated in mono sound signal.

This function is only available in TV mode.

SETUP

Configuring the Setup Menu

□ Language

You can set the menu language.

□ Time

■ Clock

Setting the clock is necessary in order to use the various timer features of the TV.

The current time will appear every time you press the **INFO** button.

If you disconnect the power cord, you have to set the clock again.

You can set the day, month, year, hour and minute directly by pressing the number buttons on the remote control.

■ Sleep Timer

The sleep timer automatically shuts off the TV after a preset time (30, 60, 90, 120, 150 and 180 minutes).

Press the **TOOLS** button to display the Tools menu. You can also set the sleep timer by selecting **Tools** → **Sleep Timer**.

To cancel the **Sleep Timer** function, select **Off**.

■ Timer 1 / Timer 2 / Timer 3

Three different on / off timer settings can be made.

You must set the clock first.

● On Time

Set the hour, minute, am/pm and activate / inactivate.

(To activate timer with the setting you've chosen, set to **Activated**.)

● Off Time

Set the hour, minute, am/pm and activate / inactivate.

(To activate timer with the setting you've chosen, set to **Activated**.)

● Repeat

Select **Once, Everyday, Mon~Fri, Mon~Sat** or **Sat~Sun**.

● Volume

Select the desired turn on volume level.

● Programme

When the On Timer is active, you can turn on a specific channel.

You can set the hour, minute and channel by pressing the number buttons on the remote control.

Auto Power Off

When you set the timer On, the television will eventually turn off, if no controls are operated for 3 hours after the TV was turned on by the timer. This function is only available in timer On mode and prevents overheating, which may occur if a TV is on for too long time.

□ Child Lock → Off / On

This feature allows you to prevent unauthorized users, such as children, from watching unsuitable programme by muting out video and audio.

Before the setup screen appears, the PIN number input screen appears. Enter your 4 digit PIN number.

The default PIN number of a new TV set is 0-0-0-0. You can change the PIN by selecting **Change PIN** from the menu.

You can lock some channels in Channel List. (refer to page 9)

Child Lock is available only in TV mode.



❑ **Change PIN**

You can change your personal ID number that is required to set up the TV.

- ☑ Before the setup screen appears, the PIN number input screen appears. Enter your 4 digit PIN number.
- ☑ The default PIN number of a new TV set is 0-0-0-0.
- ☑ If you forget the PIN code, press the remote control buttons in the following sequence, which resets the PIN to 0-0-0-0:
POWER (Off) → MUTE → 8 → 2 → 4 → POWER (On).

❑ **Game Mode → Off / On**

When connecting to a game console such as PlayStation™ or Xbox™, you can enjoy a more realistic gaming experience by selecting game menu.

- ☑ Restrictions on game mode (Caution)
 - To disconnect the game console and connect another external device, set **Game Mode** to **Off** in the setup menu.
 - If you display the TV menu in **Game Mode**, the screen shakes slightly.
- ☑ If **Game Mode** is On:
 - Picture mode is automatically changed to **Standard** and cannot be changed.

❑ **Melody → Off / Low / Medium / High**

A melody sound can be set to come on when the TV is powered On or Off.

- ☑ The Melody does not play
 - When no sound is output from the TV because the **MUTE** button has been pressed.
 - When no sound is output from the TV because the volume has been reduced to minimum with the **VOL -** button.
 - When the TV is turned off by Sleep Timer function.

❑ **Energy Saving → Off / Low / Medium / High / Auto**

This feature adjusts the brightness of the TV in order to reduce power consumption. When watching TV at night, set the **Energy Saving** mode option to **High** to reduce eye fatigue as well as power consumption.

- ☑ Press the **TOOLS** button to display the **Tools** menu. You can also set the Energy Saving option by selecting **Tools → Energy Saving**.

❑ **PIP**

For detailed procedures on setting up options, refer to page 14.

INPUT

Input Menu

□ Source List

Use to select TV or other external input sources such as DVD / Blu-ray players / Cable Box / Satellite receivers (Set-Top Box) connected to the TV. Use to select the input source of your choice.

- Press the **SOURCE** button on the remote control to view an external signal source. TV mode can be selected by pressing the TV button.
- You can also watch HDMI mode simply by pressing the **HDMI** button on the remote control

■ TV / AV1 / AV2 / Component1 / Component2 / PC / HDMI1/DVI / HDMI2 / HDMI3

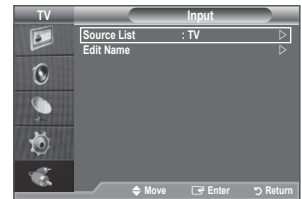

□ Edit Name

■ VCR / DVD / Cable STB / Satellite STB / PVR STB / AV Receiver / Game / Camcorder / PC / DVI / DVI PC / TV / IPTV / Blu-ray / HD DVD / DMA

Name the device connected to the input jacks to make your input source selection easier.













- When connecting an HDMI/DVI cable to the **HDMI IN 1(DVI)** port, you should set the **HDMI1/DVI** mode to **DVI** or **DVI PC** in the **Edit Name** of the **Input** mode. In this case, a separate sound connection is required.

RECOMMENDATIONS

Teletext Feature

Most television stations provide written information services via Teletext. The index page of the Teletext service gives you information on how to use the service. In addition, you can select various options to suit your requirements by using the remote control buttons.

☑ For Teletext information to be displayed correctly, channel reception must be stable. Otherwise, information may be missing or some pages may not be displayed.

- 1  (index)
Used to display the index (contents) page at any time while you are viewing Teletext.
- 2  (store)
Used to store the Teletext pages.
- 3  (size)
Press to display the double-size letters in the upper half of the screen. For lower half of the screen, press it again. To display normal screen, press it once again.
- 4  (reveal)
Used to display the hidden text (answers to quiz games, for example). To display normal screen, press it again.
- 5 Colour buttons (red/green/yellow/blue)
If the FASTEXT system is used by a broadcasting company, the different topics covered on a Teletext page are colour-coded and can be selected by pressing the coloured buttons. Press one of them corresponding to the required. The page is displayed with other coloured information that can be selected in the same way. To display the previous or next page, press the corresponding coloured button.
- 6  (Teletext on/mix)
Press to activate Teletext mode after selecting the channel providing the Teletext service. Press it twice to overlap the Teletext with the current broadcasting screen.
- 7  (exit)
Exit from the Teletext display.
- 8  (sub-page)
Used to display the available sub-page.
- 9  (page up)
Used to display the next Teletext page.
- 10  (mode)
Press to select the Teletext mode (LIST/ FLOF). If you press it in the LIST mode, it switches into the List save mode. In the List save mode, you can save Teletext page into list using the  (store) button.
- 11  (page down)
Used to display the previous Teletext page.
- 12  (hold)
Used to hold the display on a given page if the selected page is linked with several secondary pages which follow on automatically. To resume, press it again.
- 13  (cancel)
Used to display the broadcast when searching for a page.

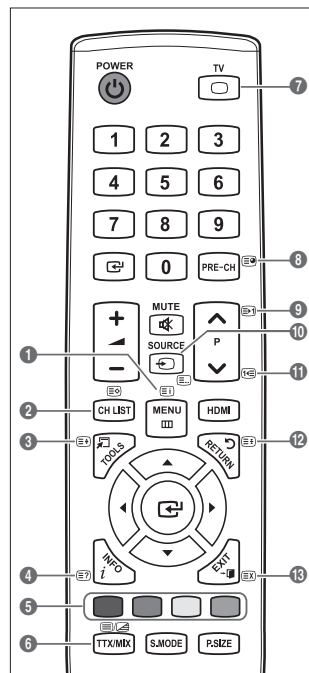

☑ You can change Teletext pages by pressing the numeric buttons on the remote control.

The Teletext pages are organized according to six categories:

Part	Contents
A	Selected page number.
B	Broadcasting channel identity.
C	Current page number or search indications.
D	Date and time.
E	Text.
F	Status information. FASTEXT information.

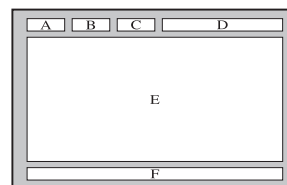

- ☑ Teletext information is often divided between several pages displayed in sequence, which can be accessed by:
 - Entering the page number
 - Selecting a title in a list
 - Selecting a coloured heading (FASTEXT system)
- ☑ Teletext level supported by the TV is version 2.5 which is capable of displaying additional graphics or text.
- ☑ Depending upon the transmission, blank side panels can occur when displaying Teletext.
- ☑ In these cases, additional graphics or text is not transmitted.
- ☑ Older TV's which do not support version 2.5 are not capable of displaying any additional graphics or text, regardless of the Teletext transmission.
- ☑ Press the **TV** button to exit from the Teletext display.

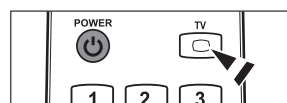

Installing the Stand (LA32B450)

- ☑ **Preset:** Place the Guide Stand and Cover Neck onto the stand and fasten it using the screws. Applicable to 32inch models only.

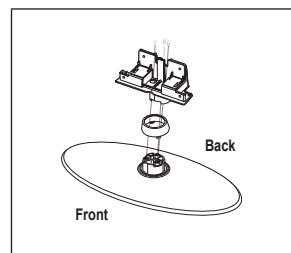

1. Attach your LCD TV to the stand.

- ☑ Two or more people should carry the TV.
- ☑ Make sure to distinguish between the front and back of the stand when assembling them.
- ☑ To make sure the TV is installed on the stand at a proper level, do not apply excess downward pressure to the upper left or right sides of the TV.

2. Fasten screws at position ① and then fasten screws at position ②.

- ☑ Stand the product up and fasten the screws. If you fasten the screws with the LCD TV placed down, it may lean to one side.
- ☑ The stand is installed for models with the screen size of 37 inch and above.

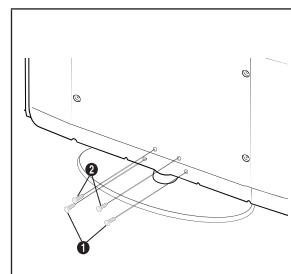

Installing the Stand (LA32B460)

- ☑ **Preset:** Place the Guide Stand and Cover Neck onto the stand and fasten it using the screws. Applicable to 32inch models only.

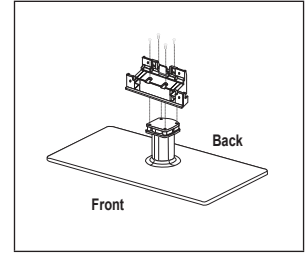

1. Attach your LCD TV to the stand.
 - ☑ Two or more people should carry the TV.
 - ☑ Make sure to distinguish between the front and back of the stand when assembling them.
 - ☑ To make sure the TV is installed on the stand at a proper level, do not apply excess downward pressure to the upper left or right sides of the TV.
2. Fasten screws at position ❶ and then fasten screws at position ❷.
 - ☑ Stand the product up and fasten the screws. If you fasten the screws with the LCD TV placed down, it may lean to one side.

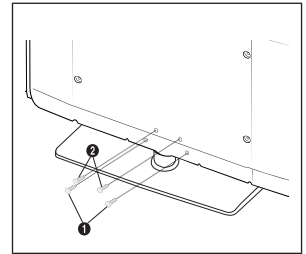

Disconnecting the Stand

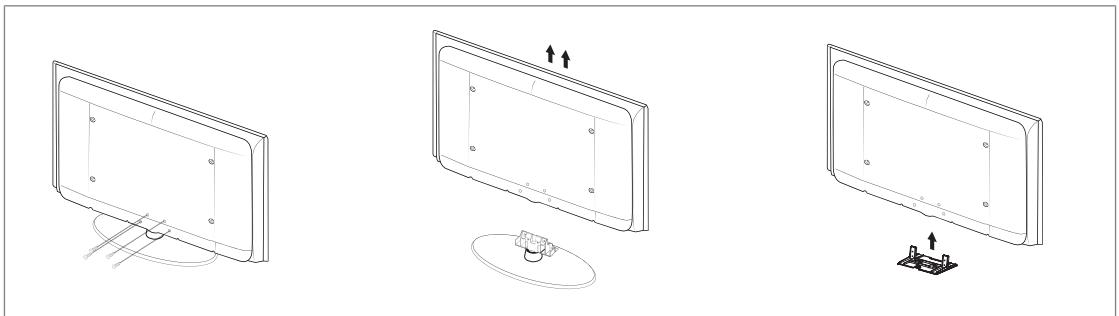

1. Remove four screws from the back of the TV.
2. Separate the stand from the TV.
 - ☑ Two or more people should carry the TV.
3. Cover the bottom hole with the cover.

Installing the Wall Mount Kit

Wall mount items (sold separately) allow you to mount the TV on the wall. For detailed information on installing the wall mount, see the instructions provided with the Wall Mount items. Contact a technician for assistance when installing the wall mounted bracket.

Samsung Electronics is not responsible for any damage to the product or injury to yourself or others if you elect to install the TV on your own.

- ⚠ Do not install your Wall Mount Kit while your TV is turned on. It may result in personal injury due to electric shock.
- ☑ Remove the stand and cover the bottom hole with a cap and fasten with two screws.

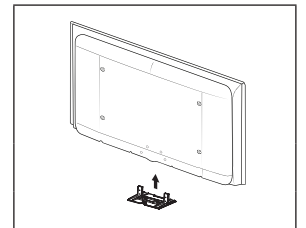

Assembling the Cables (LA32B460)

Enclose the cables in the Holder-Wire Cable so that the cables are not visible through the transparent stand.

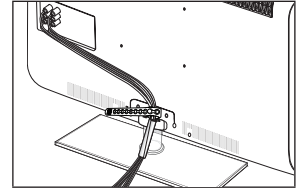

Anti-Theft Kensington Lock

The Kensington Lock is a device used to physically fix the system when using it in a public place. The appearance and locking method may differ from the illustration depending on the manufacturer.

Refer to the manual provided with the Kensington Lock for proper use.

- ☑ The locking device has to be purchased separately.
- ☑ The location of the Kensington Lock may be different depending on its model.

1. Insert the locking device into the Kensington slot on the LCD TV (❶) and turn it in the locking direction (❷).
2. Connect the Kensington Lock cable (❸).
3. Fix the Kensington Lock to a desk or a heavy stationary object.

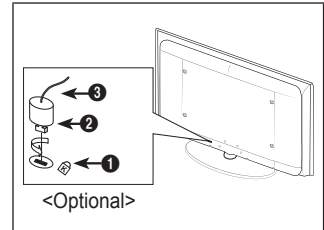

Securing the Installation Space

Keep the required distances between the product and other objects (e.g. walls) to ensure proper ventilation.

Failing to do so may result in fire or a problem with the product due to an increase in the internal temperature of the product.

Install the product so the required distances shown in the figure are kept.

- ☑ When using a stand or wall-mount, use parts provided by Samsung Electronics only.
 - If you use parts provided by another manufacturer, it may result in a problem with the product or an injury due to the product falling.
 - If you use parts provided by another manufacturer, it may result in a problem with the product or fire due to an increase in the internal temperature of the product due to poor ventilation.
- ☑ The appearance may differ depending on the product.

When installing the product with a stand

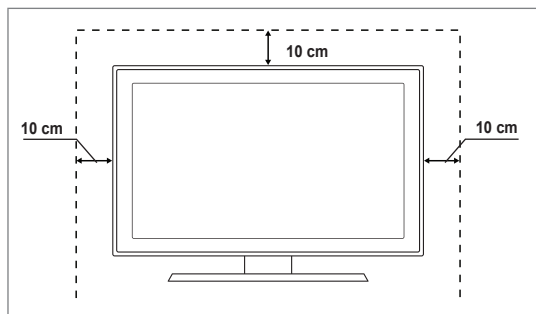

When installing the product with a wall-mount

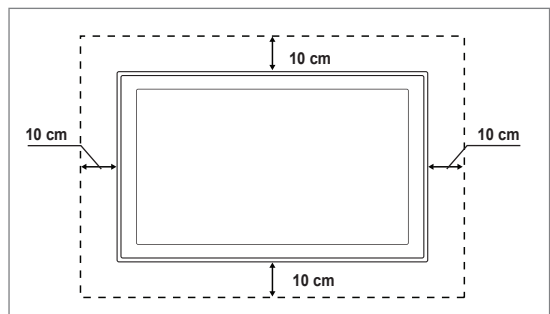

Securing the TV to the Wall



Caution: Pulling, pushing, or climbing on the TV may cause the TV to fall. In particular, ensure your children do not hang over or destabilize the TV; doing so may cause the TV to tip over, causing serious injuries or death. Follow all safety precautions provided on the included Safety Flyer. For added stability, install the anti-fall device for safety purposes, as follows.

■ To avoid the TV from falling:

1. Put the screws into the clamps and firmly fasten them onto the wall. Confirm that the screws have been firmly installed onto the wall.
 - ✎ You may need additional material such as an anchor depending on the type of wall.
 - ✎ Since the necessary clamps, screws, and string are not supplied, please purchase these additionally.
2. Remove the screws from the centre back of the TV, put the screws into the clamps, and then fasten the screws onto the TV again.
 - ✎ Screws may not be supplied with the product. In this case, please purchase the screws of the following specifications.
 - ✎ Screw Specifications
 - For a 17 ~ 29 Inch LCD TV: M4 X L15 / For a 32 ~ 40 Inch LCD TV: M6 X L15
3. Connect the clamps fixed onto the TV and the clamps fixed onto the wall with a strong string and then tie the string tightly.
 - ✎ Install the TV near to the wall so that it does not fall backwards.
 - ✎ It is safe to connect the string so that the clamps fixed on the wall are equal to or lower than the clamps fixed on the TV.
 - ✎ Untie the string before moving the TV.
4. Verify all connections are properly secured. Periodically check connections for any sign of fatigue for failure. If you have any doubt about the security of your connections, contact a professional installer.

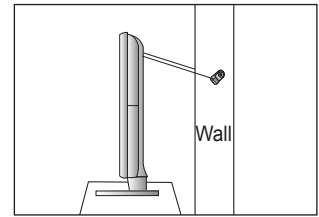
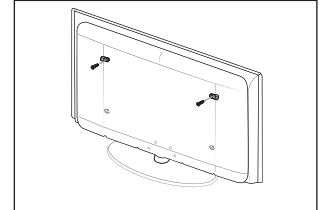
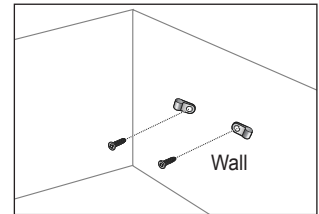

Troubleshooting

If the TV seems to have a problem, first try this list of possible problems and solutions. If none of these troubleshooting tips apply, visit samsung.com, then click on Support or call Samsung customer contact centre.

Issue	Solution
Picture Quality	
TV image does not look as good as it did in the store.	<ul style="list-style-type: none"> • If you have an analogue Cable/Set top box, upgrade to the box. Use HDMI or Component cables to deliver HD picture quality. (Not applied to HD Tuner Built-in models) • Cable/Satellite subscriber : Try HD(High Definition) stations from channel line up. • Antenna connection: Try HD stations after performing Auto programme. <input checked="" type="checkbox"/> Many HD channels are upscaled from SD(Standard Definition) contents. • Adjust Cable/Set top box video output resolution to 1080i or 720p. (Not applied to HD Tuner Built-in models)
Picture is distorted : macroblock, small block, dots, pixelization.	<ul style="list-style-type: none"> • Compression of video contents may cause picture distortion especially on fast moving pictures such as sports and action movies. • Low signal level can cause picture distortion. This is not a TV issue. Have the antenna accessed.
Wrong or missing color with Component connection.	<ul style="list-style-type: none"> • Make sure the Component cables are connected to the correct jacks. Incorrect or loose connections may cause color problems or the screen will be blank.
Poor color or brightness.	<ul style="list-style-type: none"> • Adjust Picture options in the TV menu (Picture mode, Colour, Brightness, Sharpness). • Adjust Energy Saving option in Setup menu. • Try picture reset to view the default picture setting (Go to MENU - Picture - Picture Reset).
Dotted line on the edge of screen.	<ul style="list-style-type: none"> • If picture size is set to Screen Fit, change to 16:9. • Change cable/set top box resolution.
Picture is black and white with AV (Composite) input only.	<ul style="list-style-type: none"> • Confirm Composite (yellow) cable is in yellow jack in source as well as TV.
Picture freezes or is distorted when changing channels or picture is delayed.	<ul style="list-style-type: none"> • If connected with Cable/ set top box, please try to reset the cable/set top box. (reconnect AC cord and wait until cable box reboots. It may take up to 20 minutes) • Set output resolution of the settop box to 1080i or 720p.
Sound Quality	
No sound or sound is too low at maximum volume.	<ul style="list-style-type: none"> • Please check the volume of external device connected to your TV. Then, adjust the TV volume accordingly.
Picture is good but no sound.	<ul style="list-style-type: none"> • Set the Speaker Select option to TV speaker in the sound menu. • Make sure audio cables from an external device are connected to correct audio input jacks on the TV. • Check connected device's audio output option. (ex: You may need to change your external device's audio option to HDMI when you have HDMI connected to your TV.) • If you are using a DVI to HDMI cable, a separate audio cable is required. • Remove plug from headphone jack (if available on your TV).
Noise from speaker.	<ul style="list-style-type: none"> • Check cable connections. Make sure a video cable is not connected to an audio input. • For Antenna/Cable connection, check signal strength. Low signal level may cause sound distortion.

Issue	Solution
No Picture, No Video	
TV won't turn on.	<ul style="list-style-type: none"> ● Make sure the AC power cord is plugged in securely to the wall outlet and the TV. ● Make sure the wall outlet is working. ● Try pressing the POWER button on the TV to make sure the remote is working properly. If the TV turns on, it may be caused by Remote Control. To fix the Remote problem, refer to 'Remote control does not work' below.
TV turns off automatically.	<ul style="list-style-type: none"> ● Check if the Sleep Timer is set to On in the Setup menu. ● If connected the TV to your PC, check your PC power settings. ● Make sure the AC power cord is plugged in securely to the wall outlet and the TV. ● If there is no signal for about 10 ~ 15 minutes with Antenna/Cable connection, the TV will turn off.
No picture/Video.	<ul style="list-style-type: none"> ● Check cable connections.(remove and reconnect all cables of TV and external devices) ● Set your external device's (Cable/Set top Box, DVD, Blu-ray etc) video output to match the connections to the TV input. For example, external device's output : HDMI , TV's input : HDMI. ● Make sure your connected device is powered on. ● Make sure to select the TV's correct source by pressing the SOURCE button on the TV remote.
RF(Cable/Antenna) Connection	
Cannot receive all channels.	<ul style="list-style-type: none"> ● Make sure Antenna cable is connected securely. ● Please try Plug & Play to add available channels to the channel list. Go to MENU - Setup - Plug & Play and wait for all available channels are stored. ● Verify Antenna is positioned correctly.
Picture is distorted : macroblock, small block, dots, pixelization.	<ul style="list-style-type: none"> ● Compression of video contents may cause picture distortion especially on fast moving pictures such as sports and action movies. ● Low signal level can cause picture distortion. This is not a TV issue. Have the antenna accessed.
PC Connection	
'Not Supported Mode' message.	<ul style="list-style-type: none"> ● Set your PC's output resolution so it matches the resolutions supported by the TV.
PC is always shown on source list even if not connected.	<ul style="list-style-type: none"> ● This is normal; PC is always shown on the source list even though a PC is not connected.
Video is OK but there is no audio with HDMI connection.	<ul style="list-style-type: none"> ● Check the audio output setting on your PC.

Issue	Solution
Others	
Remote control does not work.	<ul style="list-style-type: none"> ● Replace the remote control batteries with correct polarity (+ -). ● Clean the transmission window located on the top of the remote. ● Try pointing the remote directly at the TV from 5~6 feet away.
Can not control TV power or volume with Cable/Set top box remote control.	<ul style="list-style-type: none"> ● programme the Cable/Set top box remote control to operate the TV. Refer to Cable/Set top box user manual for SAMSUNG TV code.
'Not Supported Mode' message.	<ul style="list-style-type: none"> ● Check the supported resolution of the TV and adjust the external device's output resolution accordingly. Refer to resolution settings in this manual.
Plastic smell from TV.	<ul style="list-style-type: none"> ● This smell is normal and will dissipate over time.
TV is tilted to right or left side.	<ul style="list-style-type: none"> ● Remove the stand base from TV and reassemble.
Can not assemble stand base.	<ul style="list-style-type: none"> ● Make sure TV is placed on flat surface. If can not remove screws from TV, please use magnetized screw driver.
Channel menu is grey out (unavailable).	<ul style="list-style-type: none"> ● Channel menu is only available when TV source is selected.
Your settings are lost after 30 minutes or every time TV is turned off.	<ul style="list-style-type: none"> ● If TV is in the Store Demo mode, it will reset audio and picture settings every 30 minutes. Please change from Store Demo mode to Home Use mode in the Plug & Play procedure. Press the SOURCE button to select TV mode, go to MENU → Setup → Plug & Play → ENTER [↵].
Intermittent loss of audio or video.	<ul style="list-style-type: none"> ● Check cable connections and reconnect. ● Can be caused by using overly rigid or thick cables. Make sure the cables are flexible enough for long term use. If wall mounting, we recommend using cables with 90 degree connectors.
You may see small particles if you look closely at the edge of the bezel surrounding the TV screen.	<ul style="list-style-type: none"> ● This is part of the product's design and is not a defect.

☑ Some of above pictures and functions are available at specific models only.

Specifications

Model Name	LA26B450	LA32B450	LA32B460
Screen Size (Diagonal)	26 inch	32 inch	32 inch
PC Resolution (Optimum)	1360 x 768 @ 60Hz	1360 x 768 @ 60Hz	1360 x 768 @ 60Hz
Sound (Output)	5W X 2	10W X 2	10W X 2
Dimensions (WxDxH) Without Stand With stand	670 x 75 x 455 mm 670 x 216 x 495 mm	798 x 85 x 531 mm 798 x 252 x 577 mm	798 x 77 x 519 mm 798 x 240 x 579 mm
Weight With Stand	8 kg	12 kg	12 kg
Environmental Considerations Operating Temperature Operating Humidity Storage Temperature Storage Humidity	10°C to 40°C (50°F to 104°F) 10% to 80%, non-condensing -20°C to 45°C (-4°F to 113°F) 5% to 95%, non-condensing		
Stand Swivel (Left / Right)	0°	-10° ~ 10°	-20° ~ 20°

Model Name	LA37B450	LA40B450
Screen Size (Diagonal)	37 inch	40 inch
PC Resolution (Optimum)	1360 x 768 @ 60Hz	1360 x 768 @ 60Hz
Sound (Output)	10W X 2	10W X 2
Dimensions (WxDxH) Without Stand With stand	913 x 93 x 605 mm 913 x 300 x 656 mm	990 x 93 x 643 mm 990 x 300 x 692 mm
Weight With Stand	14 kg	18 kg
Environmental Considerations Operating Temperature Operating Humidity Storage Temperature Storage Humidity	10°C to 40°C (50°F to 104°F) 10% to 80%, non-condensing -20°C to 45°C (-4°F to 113°F) 5% to 95%, non-condensing	
Stand Swivel (Left / Right)	-20° ~ 20°	

- ☑ Design and specifications are subject to change without prior notice.
- ☑ This device is a Class B digital apparatus.
- ☑ For the power supply and Power Consumption, refer to the label attached to the product.

Free Manuals Download Website

<http://myh66.com>

<http://usermanuals.us>

<http://www.somanuals.com>

<http://www.4manuals.cc>

<http://www.manual-lib.com>

<http://www.404manual.com>

<http://www.luxmanual.com>

<http://aubethermostatmanual.com>

Golf course search by state

<http://golfingnear.com>

Email search by domain

<http://emailbydomain.com>

Auto manuals search

<http://auto.somanuals.com>

TV manuals search

<http://tv.somanuals.com>