



Contact SAMSUNG WORLDWIDE

If you have any questions or comments relating to Samsung products, please contact the SAMSUNG customer care center.

Comuníquese con SAMSUNG WORLDWIDE

Si desea formular alguna pregunta o comentario en relación con los productos de Samsung, comuníquese con el centro de atención al cliente de SAMSUNG.

Country	Customer Care Center ☎	Web Site	Address
CANADA	1-800-SAMSUNG(726-7864)	www.samsung.com	Samsung Electronics Canada Inc., Customer Service 55 Standish Court Mississauga, Ontario L5R 4B2 Canada
			Samsung Electronique Canada Inc., Service à la Clientèle 55 Standish Court Mississauga, Ontario L5R 4B2 Canada
U.S.A	1-800-SAMSUNG(726-7864)	www.samsung.com	Samsung Electronics America, Inc. 85 Challenger Road Ridgefield Park, NJ 07660-2112

SERIES **4**
450

LCD TV user manual

imagine the possibilities

Thank you for purchasing this Samsung product. To receive more complete service, please register your product at

www.samsung.com/register

Model _____ Serial No. _____



BN68-02663A-06

Figures and illustrations in this User Manual are provided for reference only and may differ from actual product appearance. Product design and specifications may be changed without notice.

Important Warranty Information Regarding Television Format Viewing

See the warranty card for more information on warranty terms.

Wide screen format LCD Displays (16:9, the aspect ratio of the screen width to height) are primarily designed to view wide screen format full-motion video. The images displayed on them should primarily be in the wide screen 16:9 ratio format, or expanded to fill the screen if your model offers this feature and the images are constantly moving. Displaying stationary graphics and images on screen, such as the dark sidebars on nonexpanded standard format television video and programming, should be limited to no more than 5% of the total television viewing per week. Additionally, viewing other stationary images and text such as stock market reports, video game displays, station logos, web sites or computer graphics and patterns, should be limited as described above for all televisions. Displaying stationary images that exceed the above guidelines can cause uneven aging of LCD Displays that leave subtle, but permanent burned-in ghost images in the LCD picture. To avoid this, vary the programming and images, and primarily display full screen moving images, not stationary patterns or dark bars. On LCD models that offer picture sizing features, use these controls to view different formats as a full screen picture. Be careful in the selection and duration of television formats used for viewing. Uneven LCD aging as a result of format selection and use, as well as burned-in images, are not covered by your Samsung limited warranty.

SAMSUNG ELECTRONICS NORTH AMERICAN LIMITED WARRANTY STATEMENT

Subject to the requirements, conditions, exclusions and limitations of the original Limited Warranty supplied with Samsung Electronics (SAMSUNG) products, and the requirements, conditions, exclusions and limitations contained herein, SAMSUNG will additionally provide Warranty Repair Service in the United States on SAMSUNG products purchased in Canada, and in Canada on SAMSUNG products purchased in the United States, for the warranty period originally specified, and to the Original Purchaser only.

The above described warranty repairs must be performed by a SAMSUNG Authorized Service Center. Along with this Statement, the Original Limited Warranty Statement and a dated Bill of Sale as Proof of Purchase must be presented to the Service Center. Transportation to and from the Service Center is the responsibility of the purchaser. Conditions covered are limited only to manufacturing defects in material or workmanship, and only those encountered in normal use of the product.

Excluded, but not limited to, are any originally specified provisions for, in-home or on-site services, minimum or maximum repair times, exchanges or replacements, accessories, options, upgrades, or consumables.

For the location of a SAMSUNG Authorized Service Center, please call toll-free:

- In the United States : 1-800-SAMSUNG (1-800-726-7864)
- In Canada : 1-800-SAMSUNG

Still image warning

Avoid displaying still images (such as jpeg picture files) or still image elements (such as TV channel logos, panorama or 4:3 image format, stock or news bars at screen bottom etc.) on the screen. Constant displaying of still pictures can cause ghosting of LCD screen, which will affect image quality. To reduce risk of this effect, please follow below recommendations:

- Avoid displaying the same TV channel for long periods.
- Always try to display any image on full screen, use TV set picture format menu for best possible match.
- Reduce brightness and contrast values to minimum required to achieve desired picture quality, exceeded values may speed up the burnout process.
- Frequently use all TV features designed to reduce image retention and screen burnout, refer to proper user manual section for details.

Securing the Installation Space

Keep the required distances between the product and other objects (e.g. walls) to ensure proper ventilation. Failing to do so may result in fire or a problem with the product due to an increase in the internal temperature of the product.

When using a stand or wall-mount, use parts provided by Samsung Electronics only.

- If you use parts provided by another manufacturer, it may result in a problem with the product or an injury due to the product falling.

The appearance may differ depending on the product.

Be careful when you contact the TV because some parts can be somewhat hot.

Installation with a stand.

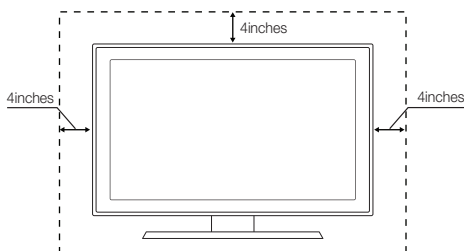

Installation with a wall-mount.

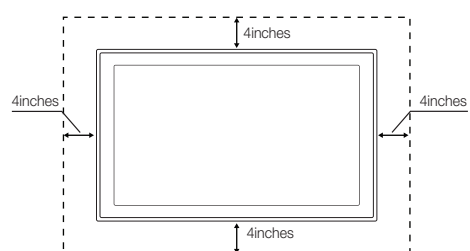

© 2010 Samsung Electronics Co., Ltd. All rights reserved.

Contents

Getting Started

- List of Features 4
- Accessories 4
- Installing the LCD TV Stand 4
- Viewing the Control Panel 5
- Viewing the Remote Control 6
- Connecting to an Antenna 7
- Plug & Play (Initial Setup) 7

Connections

- Connecting to an AV Device 8
- Connecting to an Audio Device 9
- Connecting to a PC 9
- Changing the Input source 10

Basic Features

- How to Navigate Menus 11
- Channel Menu 11
 - Seeing Channels 11
 - Using Favorite Channels 12
 - Memorizing channels 12
 - Editing channels 12
 - Other Features 12
- Picture Menu 13
 - Changing the Preset Picture Mode 13
 - Adjusting picture settings 13
 - Economical Solutions 14
 - Setting up the TV with your PC 14
 - Changing the Picture Options 14
- Sound Menu 16
 - Changing the Preset Sound Mode 16
 - Adjusting sound settings 16
 - Sound Settings 16
- Setup Menu 17
 - Setting the Time 17
 - Using the Sleep Timer 17
 - Setting the On/Off Time 17
 - Locking Programs 18
 - Other Features 19
 - Picture In Picture (PIP) 20
- Support Menu 21

Advanced Features

- Media Play 22
 - Connecting a USB Device 22
 - Screen Display 23
 - Playing Multiple Files 26
 - Media Play - Additional Functions 26
- Anynet+ 28
 - Setting Up Anynet+ 29
 - Switching between Anynet+ Devices 29
 - Recording 29
 - Listening through a Receiver 30
 - Troubleshooting for Anynet+ 30

Other Information

- Installing the Wall Mount 31
- Securing the TV to the Wall (LN32C450 Only) 32
- Securing the TV to the Wall 33
- Anti-theft Kensington Lock 33
- Troubleshooting 34
 - Storage and Maintenance 36
- Specifications 37
 - License 37
- Dimensions 38
- Index 39

Check the Symbol!



TOOLS

This function can be used by pressing the **TOOLS** button on the remote control.



Note :
Important information



Step by step guide :
Informs you how to access the menu.

Getting Started

List of Features

- Excellent Digital Interface & Networking: With a built-in HD digital tuner, nonsubscription HD broadcasts can be viewed without a cable box / STB (Set-Top-Box) satellite receiver.
- **Media Play:** Allows you to play music files, pictures, and movies saved on a USB device. (P. 22)
- **Self Diagnosis:** You can check picture and sound operation. (P. 21)

Accessories

- ✎ Please make sure the following items are included with your LCD TV. If any items are missing, contact your dealer.
- ✎ The items' colors and shapes may vary depending on the models.

- Remote Control (BN59-00997A) & Batteries (AAA x 2)
- Owner's Instructions
- Warranty Card / Safety Guide / Quick Setup Guide
- Cleaning Cloth (BN63-01798B)
- Power Cord

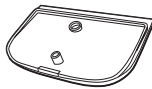

1 EA (M4 X L16)

- Blanking Bracket (BN63-07466A)
(LN26C450 Only)

Installing the LCD TV Stand

Components

When installing the stand, use the provided components and parts.

A

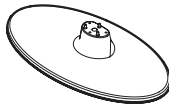

1 EA

B



3 EA (M4 X L16)

- Stand

- Screws

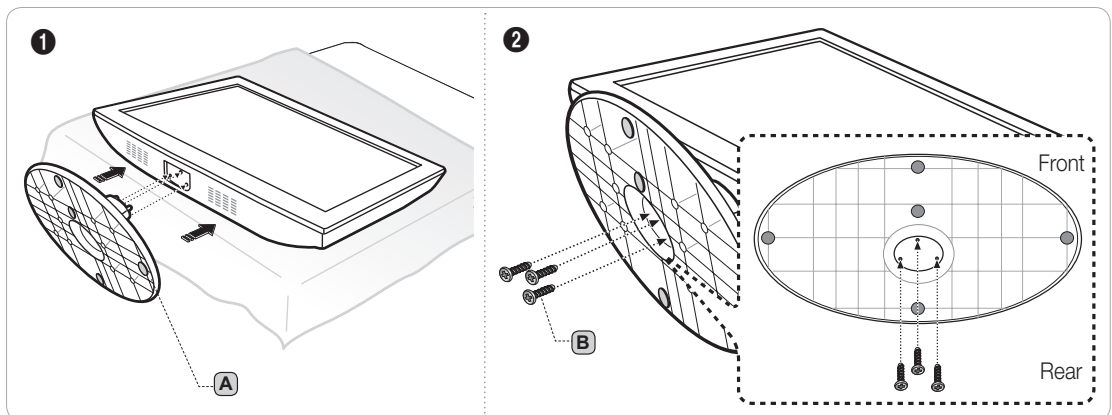



- ✎ Make sure to distinguish between the front and back of the Stand and Guide Stand when assembling them.
- ✎ Make sure that at least two persons lift and move the LCD TV.
- ✎ Lay the product down, with the screen facing up and fasten the screws.

Viewing the Control Panel

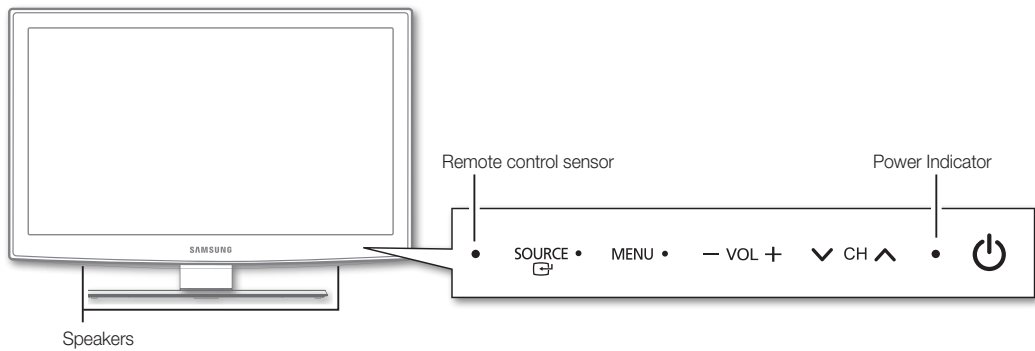
 The product color and shape may vary depending on the model.



 (Power)	Turns the TV on or off.
Remote control sensor	Aim the remote control towards this spot on the TV.
SOURCE 	Toggles between all the available input sources. In the on-screen menu, use this button as you would use the ENTER  button on the remote control.
MENU	Displays an on-screen menu, the OSD (on screen display), of your TV's features.
-VOL+	Adjusts the volume. In the OSD, use the -VOL+ buttons as you would use the ◀ and ▶ buttons on the remote control.
▼ CH ▲	Changes the channels. In the OSD, use the ▼ CH ▲ buttons as you would use the ▼ and ▲ buttons on the remote control.
Power Indicator	Blinks and turns off when the power is on and lights up in standby mode.

Standby mode

Do not leave your TV in standby mode for long periods of time (when you are away on a holiday, for example). A small amount of electric power is still consumed even when the power button is turned off. It is best to unplug the power cord.

Getting Started

Viewing the Remote Control

 This is a special remote control for the visually impaired persons and has Braille points on the Power, Channel, Volume buttons.

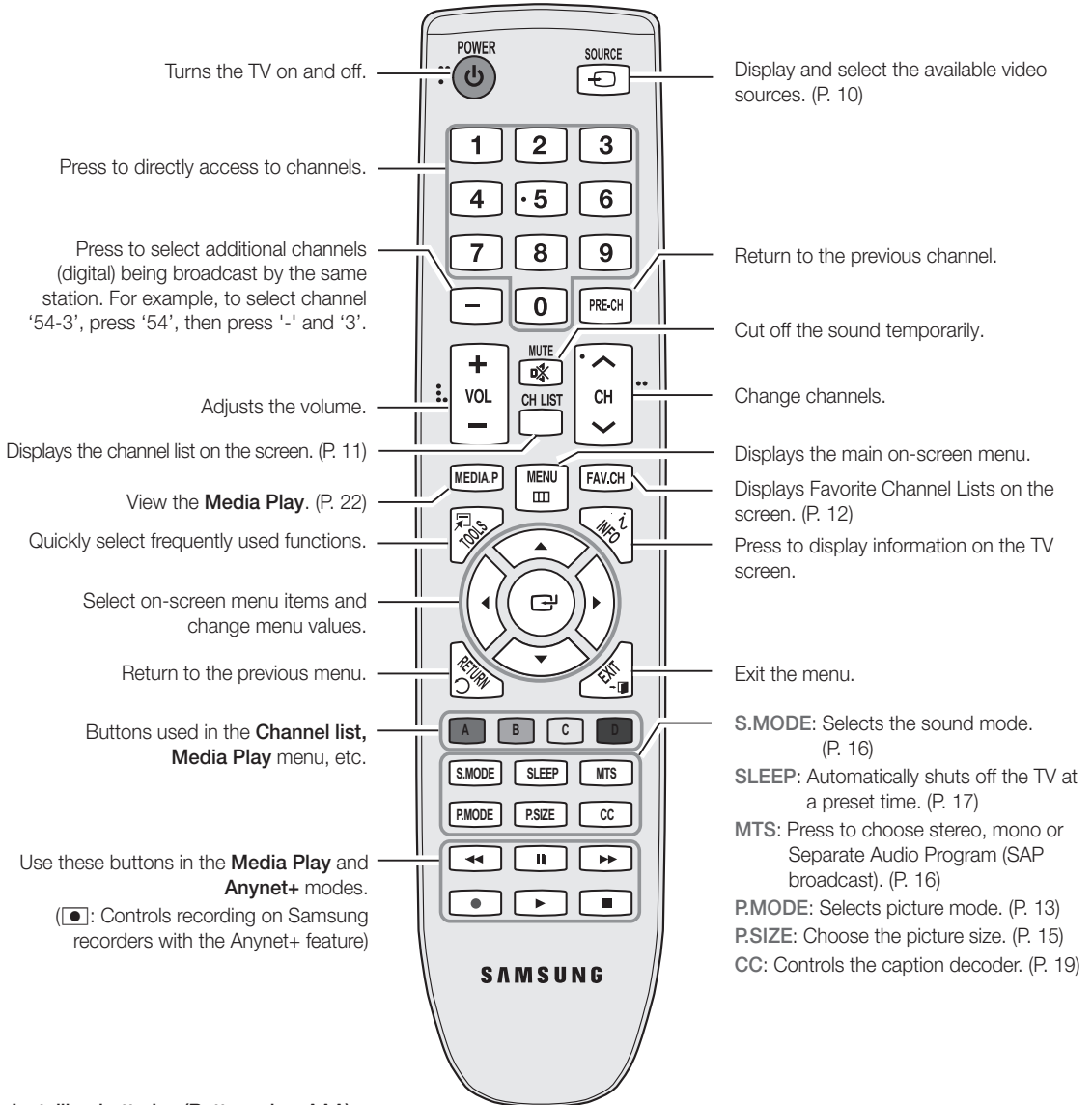

Installing batteries (Battery size: AAA)

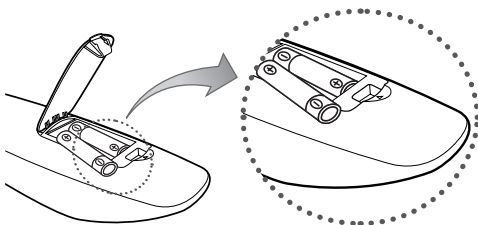

NOTE

- Use the remote control within 23 feet from the TV.
- Bright light may affect the performance of the remote control. Avoid use when nearby fluorescent lights or neon signs.
- The color and shape may vary depending on the model.

Connecting to an Antenna

When the TV is initially powered on, basic settings proceed automatically.



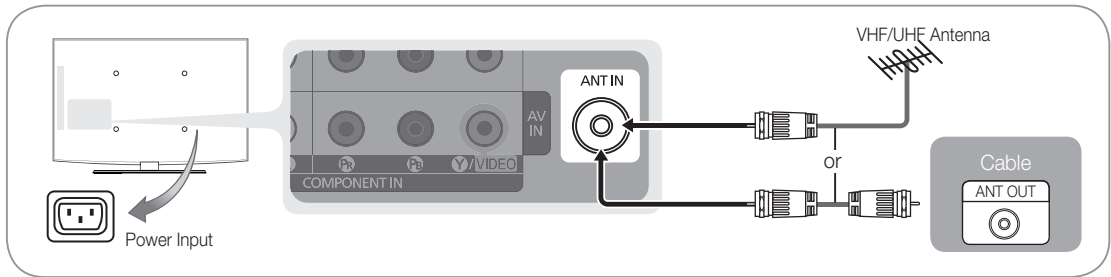

 Connecting the power cord and antenna.



Plug & Play (Initial Setup)

When the TV is initially powered on, a sequence of on-screen prompts will assist in configuring basic settings. Press the **POWER** button. **Plug & Play** is available only when the **Input** source is set to TV.

 To return to the previous step, press the red button.

1	Selecting a language	Press the ▲ or ▼ button, then press the ENTER button. Select the desired OSD (On Screen Display) language.	
2	Selecting Store Demo or Home Use	Press the ◀ or ▶ button, then press the ENTER button. <ul style="list-style-type: none"> Select the Home Use mode. Store Demo Mode is for retail environments. To return the unit's settings from Store Demo to Home Use (standard): Press the volume button on the TV. When you see the volume in the OSD, press and hold MENU for 5 sec. 	
3	Selecting an antenna	Press the ▲ or ▼ button, then press the ENTER button. Select Air , Cable or Auto . <p> In Cable mode, you can select the correct signal source among STD, HRC, and IRC by pressing the ▲, ▼, ◀ or ▶ button, then press the ENTER button.</p>	
4	Selecting a channel	The channel search will start automatically. For more information, refer to Channel → Auto Program . (P.12)  Press the ENTER button at any time to interrupt the memorization process.	
5	Setting the Clock Mode	Set the Clock Mode automatically or manually.  If you select the Auto , set the daylight saving time. Select the time zone where you live.	
6	Viewing the HD Connection Guide	The connection method for the best HD screen quality is displayed.	
7	Enjoy your TV.	Press the ENTER button.	

If You Want to Reset This Feature...

 **MENU** → **Setup** → **Plug & Play** → **ENTER**.

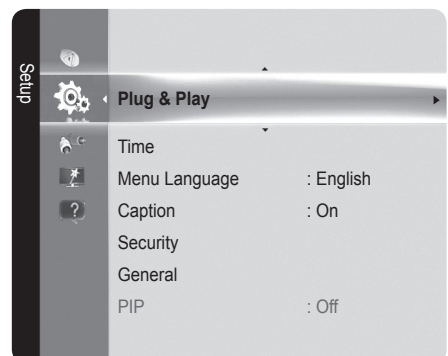

Connections

Connecting to an AV Device

Using an HDMI / DVI Cable: HD connection (up to 1080p)

We recommend using the HDMI connection for the best quality HD picture.

Available devices: DVD, Blu-ray player, HD cable box, HD satellite receiver (STB).

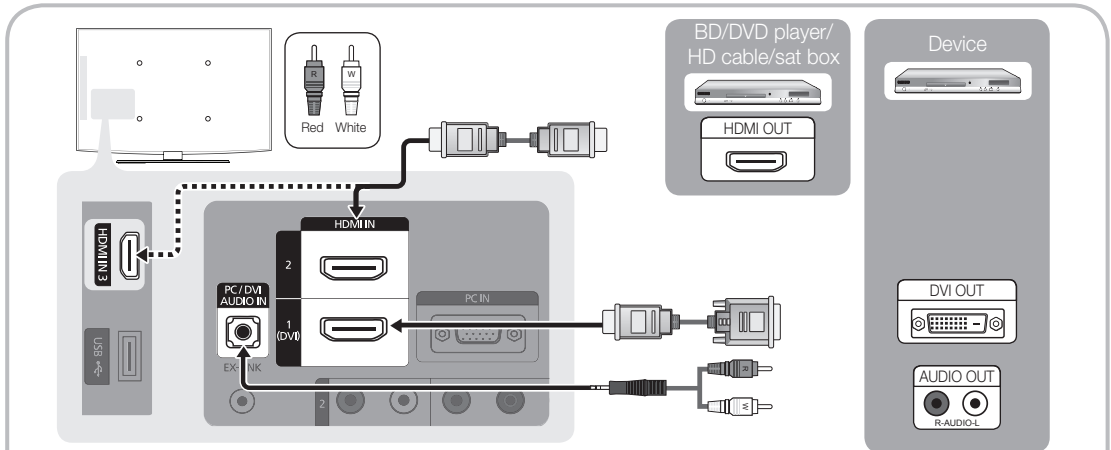

HDMI IN 1(DVI), 2, 3 / PC/DVI AUDIO IN

- When using an HDMI/DVI cable connection, you must use the **HDMI IN 1 (DVI)** jack for video. A DVD, Blu-ray player, HD cable box, HD STB satellite receiver, cable box, or STB satellite receiver may require a DVI-HDMI (DVI to HDMI) cable or DVI-HDMI (DVI to HDMI) adapter. The **PC/DVI AUDIO IN** jack is required for audio.
- The picture may not display normally (if at all) or the audio may not work if an external device that uses an older version of HDMI mode is connected to the TV. If such a problem occurs, ask the manufacturer of the external device about the HDMI version and, if out of date, request an upgrade.
- Be sure to purchase a certified HDMI cable. Otherwise, the picture may not display or a connection error may occur.

Using a Component Cable: (up to 1080p), Using an Audio/Video Cable: (480i only)

Available devices: DVD, Blu-ray player, cable box, STB satellite receiver, VCR

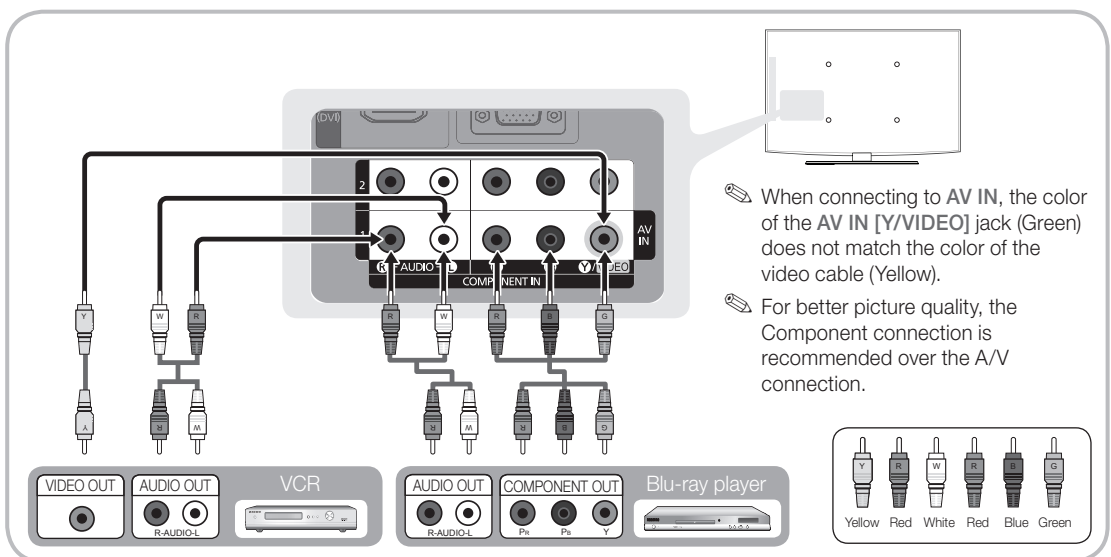

When connecting to **AV IN**, the color of the **AV IN [Y/VIDEO]** jack (Green) does not match the color of the video cable (Yellow).

For better picture quality, the Component connection is recommended over the A/V connection.

Connecting to an Audio Device

Using an Optical (Digital) or Audio (Analog) Cable Connection

Available devices: Digital Audio System, Amplifier, Home Theater

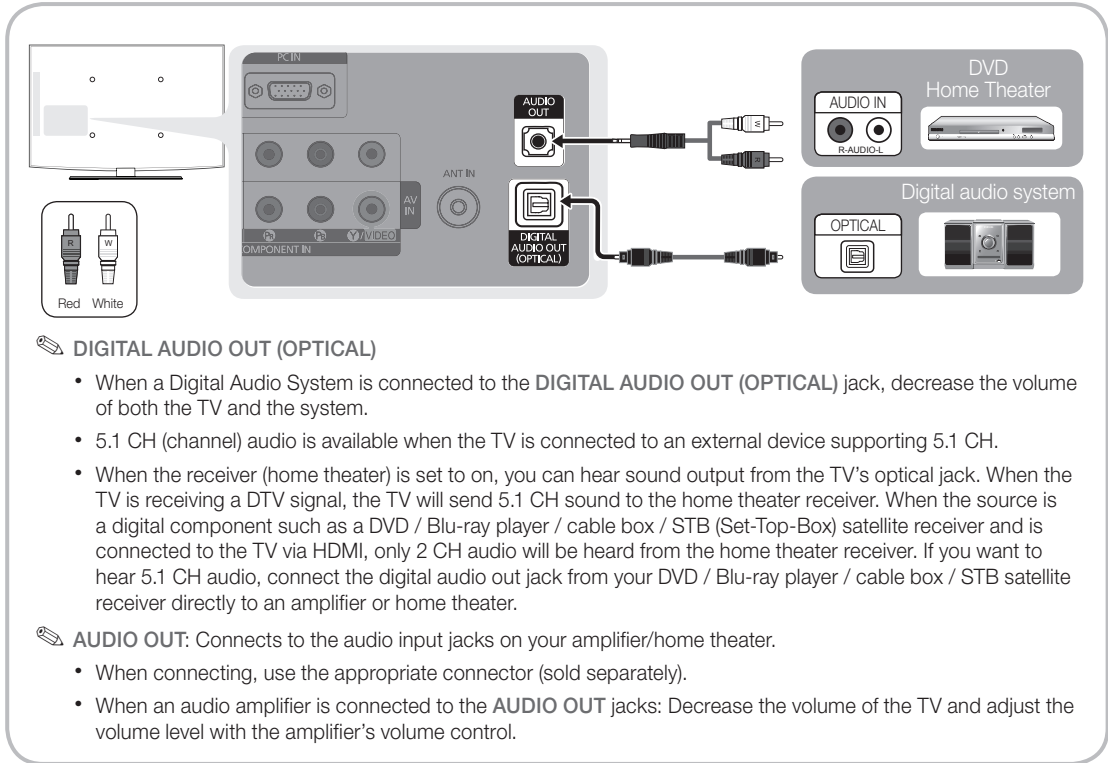

Connecting to a PC

Using an HDMI/DVI Cable / a D-sub Cable

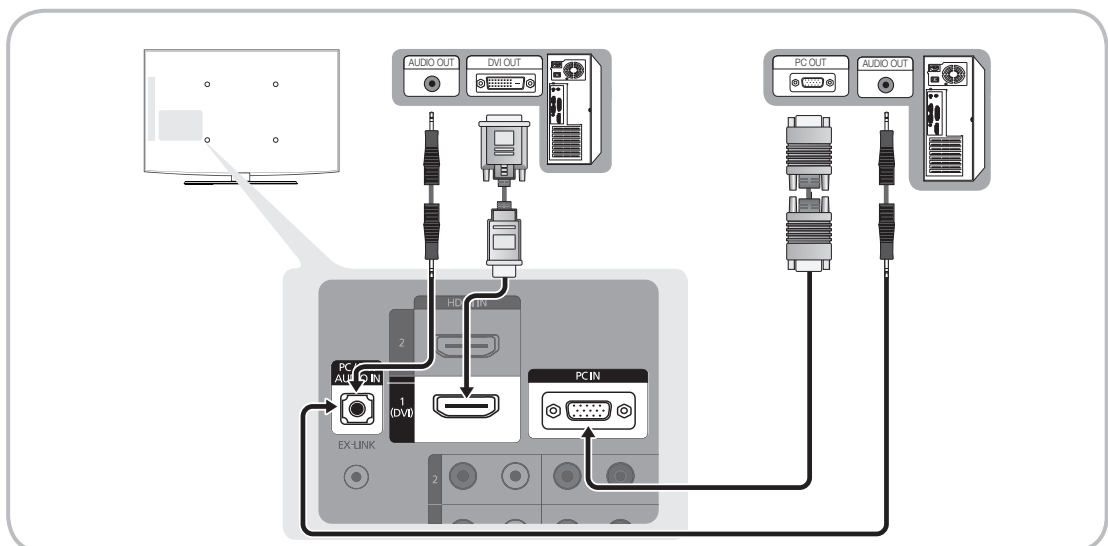

Connections

Display Modes (D-Sub and HDMI/DVI Input)

Optimal resolution is 1360x768@60Hz.

Mode	Resolution	Horizontal Frequency (kHz)	Vertical Frequency (Hz)	Pixel Clock Frequency (MHz)	Sync Polarity (H/V)
IBM	640 x 350	31.469	70.086	25.175	+ / -
	720 x 400	31.469	70.087	28.322	- / +
MAC	640 x 480	35.000	66.667	30.240	- / -
	832 x 624	49.726	74.551	57.284	- / -
VESA DMT	640 x 480	31.469	59.940	25.175	- / -
		37.861	72.809	31.500	- / -
		37.500	75.000	31.500	- / -
	800 x 600	37.879	60.317	40.000	+ / +
		48.077	72.188	50.000	+ / +
		46.875	75.000	49.500	+ / +
	1024 x 768	48.363	60.004	65.000	- / -
		56.476	70.069	75.000	- / -
		60.023	75.029	78.750	+ / +
	1280 x 720	45.000	60.000	74.250	+ / +
	1360 x 768	47.712	60.015	85.500	+ / +
	VESA CVT	720 x 576	35.910	59.950	32.750
	1280 x 720	56.456	74.777	95.750	- / +
VESA GTF	1280 x 720	52.500	70.000	89.040	- / +

NOTE

- For HDMI/DVI cable connection, you must use the **HDMI IN 1(DVI)** jack.
- The interlace mode is not supported.
- The set might operate abnormally if a non-standard video format is selected.
- Separate and Composite modes are supported. SOG(Sync On Green) is not supported.

EX-LINK

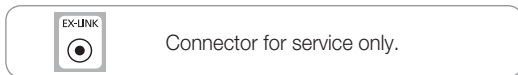

Input Cables (Sold Separately)

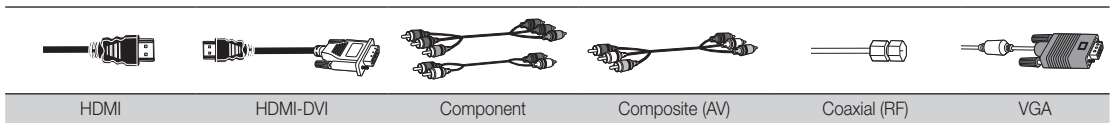

Changing the Input source

Source List

MENU → Input → Source List → ENTER

Use to select TV or an external input sources such as a DVD / Blu-ray player / cable box / STB satellite receiver.

- **TV / AV / Component1 / Component2 / PC / HDMI1/DVI / HDMI2 / HDMI3 / USB**

You can only choose external devices that are connected to the TV. In the **Source List**, connected inputs will be highlighted.

PC always stay activated.



Edit Name

MENU → Input → Edit Name → ENTER

- **VCR / DVD / Cable STB / Satellite STB / PVR STB / AV Receiver / Game / Camcorder / PC / DVI PC / DVI Devices / TV / IPTV / Blu-ray / HD DVD / DMA:** Name the device connected to the input jacks to make your input source selection easier.

When connecting an HDMI/DVI cable to the **HDMI IN 1(DVI)** port, you should set to **DVI PC** or **DVI Devices** mode under **Edit Name**.

Basic Features

How to Navigate Menus

Before using the TV, follow the steps below to learn how to navigate the menu in order to select and adjust different functions.

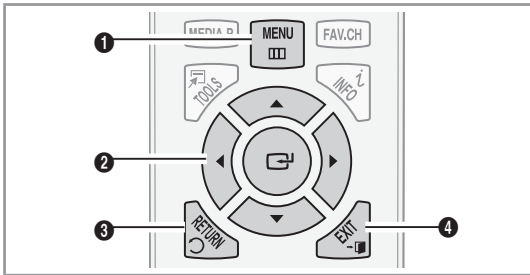

- 1 MENU button: Display the main on-screen menu.
- 2 ENTER / Direction button: Move the cursor and select an item. Confirm the setting.
- 3 RETURN button: Return to the previous menu.
- 4 EXIT button: Exit the on-screen menu.

How to operate the OSD (On Screen Display)

The access step may differ depending on the selected menu.

1	MENU	The main menu options appear the screen. Picture, Sound, Channel, Setup, Input, Application, Support.
2	▲ / ▼	Select an icon with the ▲ or ▼ button.
3	ENTER	Press ENTER to access the sub-menu.
4	▲ / ▼	Select the desired submenu with the ▲ or ▼ button.
5	◀ / ▶	Adjust the value of a particular item with the ◀ or ▶ button. The adjustment OSD may differ depending on the selected menu.
6	ENTER	Press ENTER to confirm the selection.
7	EXIT	Press EXIT to exit.

Channel Menu

Seeing Channels

Channel List

MENU → Channel → Channel List → ENTER

Add, delete or set Favorite channels and use the program guide for digital broadcasts. Select a channel in the **All Channels, Added Channels, Favorite** or **Programmed** screen by pressing the ▲ / ▼ buttons, and pressing the ENTER button. Then you can watch the selected channel.

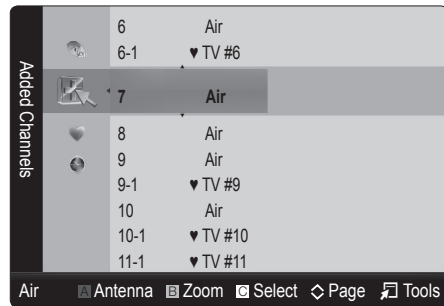



- All Channels: Shows all currently available channels.
 - Added Channels: Shows all added channels.
 - Favorite: Shows all favorite channels.
 - Programmed: Shows all currently reserved programs.
- Using the color buttons with the **Channel List**
- Red (Antenna): Switches to Air or Cable.
 - Green (Zoom): Enlarges or shrinks a channel number.
 - Yellow (Select): Selects multiple channel lists. Select desired channels and press the Yellow button to set all the selected channels at the same time. The ✓ mark appears to the left of the selected channels.
 - (Page): Move to next or previous page.
 - (Tools): Displays the **Channel List** option menu. (The Options menus may differ depending on the situation.)

Channel Status Display Icons

Icons	Operations
✓	A channel selected.
♥	A channel set as a Favorite.
🕒	A reserved Program.
📺	A program currently being broadcast.

Basic Features

Using Favorite Channels

 MENU  → Channel → Channel List → ENTER 

♥ Add to Favorite / Delete from Favorite

Set channels you watch frequently as Favorites.

1. Select a channel and press the **TOOLS** button.
2. Add or delete a channel using the **Add to Favorite** or **Delete from Favorite** menu respectively.



Memorizing channels

 MENU  → Channel → ENTER 

Antenna (Air / Cable)

Before your television can begin memorizing the available channels, you must specify the type of signal source that is connected to the TV (i.e. an Air or a Cable system).



Auto Program

- **Air:** Air antenna signal.
- **Cable:** Cable antenna signal.
- **Auto:** Air and Cable antenna.



NOTE

- When selecting the Cable TV system: Selects the cable system. **STD**, **HRC** and **IRC** identify various types of cable TV systems. Contact your local cable company to identify the type of cable system that exists in your particular area. At this point, the signal source has been selected.
- After all the available channels are stored, it starts to remove scrambled channels. The **Auto program** menu then reappears.

How to Stop Auto Programming

1. Press the **ENTER**  button.
2. A message will ask **Stop Auto Program?** Select **Yes** by pressing the **◀** or **▶** button.
3. Press the **ENTER**  button.

Editing channels

 MENU  → Channel → Channel List → ENTER 

Channel Name Edit

1. Select a channel and press the **TOOLS** button.
 2. Edit the channel name using the **Channel Name Edit** menu.
- **Channel Name Edit** (analog channels only): Assign your own channel name.



Other Features

 MENU  → Channel → ENTER 

Clear Scrambled Channel



This function is used to filter out scrambled channels after Auto Program is completed. This process may take up to 20~30 minutes.

How to Stop Searching Scrambled Channels

1. Press the **ENTER**  button to select **Stop**.
2. Press the **◀** button to select **Yes**.
3. Press the **ENTER**  button.

 This function is only available in **Cable** mode.

Channel List

 MENU  → Channel → Channel List → ENTER 

Channel List Option Menu

Set each channel using the Channel List menu options (**Add/Delete**, **Timer Viewing**, **Select All/ Deselect All**). Option menu items may differ depending on the channel status.

1. Select a channel and press the **TOOLS** button.
2. Select a function and change its settings.

- **Add / Delete:** Delete or add a channel to display the channels you want.

NOTE

- All deleted channels will be shown on the **All Channels** menu.
- A gray-colored channel indicates the channel has been deleted.
- The **Add** menu only appears for deleted channels.
- Delete a channel from the **Added Channels** or **Favorite** menu in the same manner.

- **Timer Viewing:** You can set a desired channel to be displayed automatically at the set time; even when you are watching another channel. Set the current time first to use this function. (P. 17)
 1. Press the ◀ / ▶ / ▲ / ▼ buttons to select the desired channel in **Channel List**.
 2. Press the **TOOLS** button, then select **Timer Viewing**.
 3. Scroll up or down to adjust the settings in the box, or use the numeric buttons on your remote for entering the date and time.
 - ✎ If you selected **Once**, **Every Week** or **Every Day** in **Repeat**, you can enter the date you want.
 4. Select **OK**, then press the **ENTER**  button when done.
 - ✎ **NOTE**
 - Only memorized channels can be reserved.
 - Reserved programs will be displayed in the **Programmed** menu.
 - When a digital channel is selected, press the ▶ button to view the digital program.
- **Select All:** Select all the channels in the channel list.
- **Deselect All:** Deselect all the selected channels.
 - ✎ You can only select **Deselect All** when one or more channels are selected.

Programmed

(in **Channel List**)

You can view, modify or delete a show you have reserved to watch.

1. Press the **ENTER**  button to select **Channel List**.
 2. Press the ◀ and ▼ button move to the **Programmed** menu.
- **Change Info:** Change a show you have reserved to watch.
 - **Cancel Schedules:** Cancel a show you have reserved to watch.
 - **Information:** Display a show you have reserved to watch. (You can also change the reservation Information.)
 - **Select All / Deselect All:** You can select or deselect all channels in the channel list.

Fine Tune

(analog channels only)

If the reception is clear, you do not have to fine tune the channel, as this is done automatically during the search and store operation. If the signal is weak or distorted, fine tune the channel manually.

- Select **Fine Tune** in the **Channel** menu.
- ✎ Fine tuned channels that have been saved are marked with an asterisk "*" on the right-hand side of the channel number in the channel banner.
- ✎ To reset the fine-tuning, select **Reset**.

Picture Menu

Changing the Preset Picture Mode

 **MENU**  → **Picture** → **Mode** → **ENTER** 



Mode

Select your preferred picture type by pressing the **P.MODE** button.



- **Dynamic:** Suitable for a bright room.
- **Standard:** Suitable for a normal environment.
- **Movie:** Suitable for watching movies in a dark room.

Adjusting picture settings

 **MENU**  → **Picture** → **Backlight** → **ENTER** 

Backlight / Contrast / Brightness / Sharpness / Color / Tint (G/R)

Your television has several setting options for picture quality control.



✎ **NOTE**

- When you make changes to **Backlight**, **Contrast**, **Brightness**, **Sharpness**, **Color** or **Tint (G/R)**, the OSD will be adjusted accordingly.
- In PC mode, you can only make changes to **Backlight**, **Contrast** and **Brightness**.
- Settings can be adjusted and stored for each external device connected to the TV.
- Lowering picture brightness reduces power consumption.

Basic Features

Economical Solutions

ECO Solution

 MENU  → Picture → ECO Solution → ENTER 

- **Energy Saving (Off / Low / Medium / High / Picture Off / Auto):** This adjust the brightness of the TV in order to reduce power consumption. If you select **Picture Off**, the screen is turned off, but the sound remains on. Press any button to turn on the screen again.
- **No Signal Power Off (Off / 15 min. / 30 min. / 60 min.):** Sets how quickly the TV switches to standby mode, if no picture is being received.
 Disabled when the PC is in power saving mode.

Setting up the TV with your PC

Set the input source to **PC**.

Auto Adjustment

 MENU  → Picture → Auto Adjustment → ENTER 

Adjust frequency values/positions and fine tune the settings automatically.

 Not available when connecting through HDMI/DVI cable.

Screen

- **Coarse / Fine:** Removes or reduces picture noise. If the noise is not removed by Fine-tuning alone, then adjust the frequency as best as possible (**Coarse**) and Fine-tune again. After the noise has been reduced, readjust the picture so that it is aligned to the center of screen.
- **Position:** Adjust the PC's screen positioning if it does not fit the TV screen. Press the ▲ or ▼ button to adjust the Vertical-Position. Press the ◀ or ▶ button to adjust the Horizontal-Position.
- **Image Reset:** Resets the image to default settings.

Using Your TV as a Computer (PC) Display

Setting Up Your PC Software (Based on Windows XP)

Depending on the version of Windows and the video card, the actual screens on your PC will probably look different, but the same basic set-up information will apply in most cases. (If not, contact your computer manufacturer or Samsung Dealer.)

1. Click on "Control Panel" on the Windows start menu.
2. Click on "Appearance and Themes" in the "Control Panel" window and a display dialog-box will appear.
3. Click on "Display" and a display dialog box will appear.
4. Navigate to the "Settings" tab on the display dialog-box.

14 English

- The correct size setting (resolution)
[Optimum: 1360x768 pixels]
- If a vertical-frequency option exists on your display settings dialog box, the correct value is '60' or '60 Hz'. Otherwise, just click 'OK' and exit the dialog box.

Changing the Picture Options

Advanced Settings

 MENU  → Picture → Advanced Settings → ENTER 

(available in **Standard / Movie** mode)

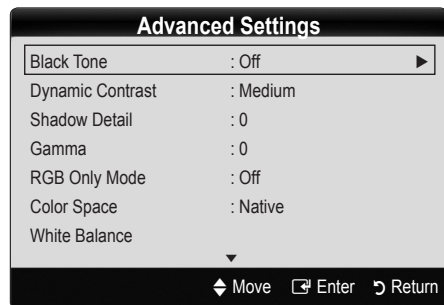

Compared to previous models, new Samsung TVs have a more precise picture.

 In **PC** mode, you can only make changes to **Dynamic Contrast, Gamma and White Balance**.



- **Black Tone (Off / Dark / Darker / Darkest):** Select the black level to adjust the screen depth.
- **Dynamic Contrast (Off / Low / Medium / High):** Adjust the screen contrast.
- **Shadow Detail:** Increase the brightness of dark images.
 Disabled under **PC** mode.
- **Gamma:** Adjust the primary color intensity.
- **RGB Only Mode (Off / Red / Green / Blue):** Displays the Red, Green and Blue color for making fine adjustments to the hue and saturation.
- **Color Space (Auto / Native):** Adjust the range of colors available to create the image.
- **White Balance:** Adjust the color temperature for a more natural picture.
R-Offset / G-Offset / B-Offset: Adjust each color's (red, green, blue) darkness.
R-Gain / G-Gain / B-Gain: Adjust each color's (red, green, blue) brightness.
Reset: Resets the **White Balance** to its default settings.
- **Flesh Tone:** Emphasize pink "flesh tone".
- **Edge Enhancement (Off / On):** Emphasize object boundaries.

Picture Options

 MENU  → Picture → Picture Options → ENTER 

 In **PC** mode, you can only make changes to the **Color Tone**, **Size** and **Auto Protection Time**.

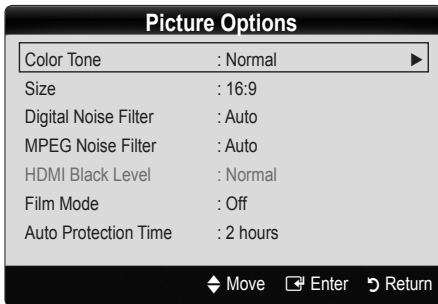

■ Color Tone (Cool / Normal / Warm1 / Warm2)

 **Warm1** or **Warm2** will be deactivated when the picture mode is **Dynamic**.

 Settings can be adjusted and stored for each external device connected to an input on the TV.

■ Size: Your cable box/satellite receiver may have its own set of screen sizes as well. However, we highly recommend you use 16:9 mode most of the time.

16:9: Sets the picture to 16:9 wide mode.

Zoom1: Use for moderate magnification.

Zoom2: Use for a stronger magnification.



Wide Fit: Enlarges the aspect ratio of the picture to fit the entire screen.

4:3: Sets the picture to basic (4:3) mode.



 Do not watch in 4:3 format for a long time. Traces of borders displayed on the left, right and center of the screen may cause image retention (screen burn) which are not covered by the warranty.

Screen Fit: Displays the full image without any cut-off when HDMI (720p / 1080i / 1080p) or Component (1080i / 1080p) signals are input.





NOTE

- After selecting **Zoom1**, **Zoom2** or **Wide Fit**:
 1. Press the **▶** button to select **Position**.
 2. Press the ENTER  button.
 3. Press the **▲** or **▼** button to move the picture up or down.
 4. Press the ENTER  button.
 5. Press the **▶** button to select **Reset**.
 6. Press the ENTER  button to reset the picture to its default position.



- After selecting **Screen Fit** in HDMI (1080i/1080p) or Component (1080i/1080p) mode, you may need to center the picture:
 1. Press the **◀** or **▶** button to select **Position**.
 2. Press the ENTER  button.
 3. Press the **▲**, **▼**, **◀** or **▶** button to move the picture.
 4. Press the ENTER  button.
 5. Press the **◀** or **▶** button to select **Reset**.
 6. Press the ENTER  button.
- HD (High Definition): 16:9 - 1080i/1080p (1920x1080), 720p (1280x720)
- Settings can be adjusted and stored for each external device you have connected to an input on the TV.

Input Source	Picture Size
ATV, AV, Component (480i, 480p)	16:9, Zoom1, Zoom2, 4:3
DTV(1080i), Component (1080i, 1080p), HDMI (720p, 1080i, 1080p)	16:9, 4:3, Wide Fit, Screen Fit
PC	16:9, 4:3

- **Digital Noise Filter (Off / Low / Medium / High / Auto / Auto Visualization):** If the broadcast signal received by your TV is weak, you can activate the **Digital Noise Filter** feature to reduce any static and ghosting that may appear on the screen.
 -  When the signal is weak, try other options until the best picture is displayed.
- Auto Visualization:** When changing analog channels, displays signal strength.
 -  Only available for analog channels.
 -  When bar is green, you are receiving the best possible signal.
- **MPEG Noise Filter (Off / Low / Medium / High / Auto):** Reduces MPEG noise to provide an improved picture quality.
 -  Disabled under **PC** mode.
- **HDMI Black Level (Normal / Low):** Selects the black level on the screen to adjust the screen depth.
 -  Available only in HDMI mode.

Basic Features



- **Film Mode (Off / Auto1 / Auto2):** Sets the TV to automatically sense and process film signals from all sources and adjusts the picture for optimum quality.
 Available in TV, AV, COMPONENT (480i / 1080i) and HDMI (480i / 1080i).
- **Auto Protection Time (2 hours / 4 hours / 8 hours / 10 hours / Off):** If the screen remains idle with a still image for a certain period of time defined by the user, the screen saver is activated to prevent the formation of ghost images on the screen.

Picture Reset (OK / Cancel)

Resets your current picture mode to its default settings.

Sound Menu

Changing the Preset Sound Mode



 MENU  → Sound → Mode → ENTER 

Mode

- **Standard:** Selects the normal sound mode.
- **Music:** Emphasizes music over voices.
- **Movie:** Provides the best sound for movies.
- **Clear Voice:** Emphasizes voices over other sounds.
- **Amplify:** Increase the intensity of high-frequency sound to allow a better listening experience for the hearing impaired.



Adjusting sound settings

 MENU  → Sound → Equalizer → ENTER 

Equalizer

Adjusts the sound mode.

- **Balance L/R:** Adjusts the balance between the right and left speaker.
- **100Hz / 300Hz / 1KHz / 3KHz / 10KHz (Bandwidth Adjustment):** Adjusts the level of specific bandwidth frequencies.
- **Reset:** Resets the equalizer to its default settings.

Sound Settings

Virtual Surround (Off / On)

(standard sound mode only)

This function provides a virtual 5.1 channel surround sound experience through a pair of speakers or headphones using HRTF (Head Related Transfer Function) technology.

Dialog Clarity (Off / On)

(standard sound mode only)

Dialog Clarity emphasizes voice while maintaining the background sound level.

Preferred Language

(digital channels only)

Digital-TV broadcasts are capable of simultaneous transmission of many audio tracks (for example, simultaneous translations of the program into foreign languages).

 You can only select a language among the ones being broadcasted.

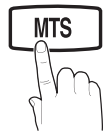

Multi-Track Sound (MTS)

(analog channels only)

- **Mono:** Choose for channels that are broadcasting in mono or if you are having difficulty receiving a stereo signal.
- **Stereo:** Choose for channels that are broadcasting in stereo.
- **SAP:** Choose to listen to the Separate Audio Program, which is usually a foreign-language translation.

 Depending on the particular program being broadcast, you can listen to **Mono**, **Stereo** or **SAP**.

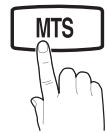

Auto Volume (Off / Normal / Night)

To equalize the volume level on each channel, set to **Normal**.

- **Night:** This mode provides an improved sound experience compared to **Normal** mode, making almost no noise. It is useful at night.

Speaker Select (External Speaker / TV Speaker)

A sound echo may occur due to a difference in decoding speed between the main speaker and the audio receiver. In this case, set the TV to **External Speaker**.

- ✎ When **Speaker Select** is set to **External Speaker**, the volume and **MUTE** buttons will not operate and the sound settings will be limited.
- ✎ When **Speaker Select** is set to **External Speaker**, you should use these settings.
 - **TV Speaker: Off, External Speaker: On**
- ✎ When **Speaker Select** is set to **TV Speaker**, you should use these settings.
 - **TV Speaker: On, External Speaker: On**
- ✎ If there is no video signal, both speakers will be mute.

SPDIF Output

SPDIF (Sony Philips Digital Interface) is used to provide digital sound, reducing interference going to speakers and various digital devices such as an A/V Receiver/Home theater.

- **Audio Format:** During the reception of a digital TV broadcast, you can select the Digital Audio output (SPDIF) format from the options **PCM** or **Dolby Digital**.
 - ✎ By connecting to 5.1ch speakers in a dolby digital setup, maximize your interactive 3D sound experience.
- **Audio Delay:** Correct audio-video sync problems, when watching TV or video, and when listening to digital audio output using an external device such as an AV receiver (0ms ~ 250ms).

Sound Reset

Reset all sound settings to the factory defaults.

Setup Menu

Setting the Time

MENU → Setup → Time → ENTER

Time

- ✎ The current time will appear every time you press the **INFO** button.
- **Clock:** Setting the clock is for using various timer features of the TV.
 - ✎ If you disconnect the power cord, you have to set the clock again.

Clock Mode: Set up the current time manually or automatically.

- **Auto:** Set the current time automatically using the time from a digital channel.

✎ The antenna must be connected in order to set the time automatically.

- **Manual:** Set the current time manually.

✎ Depending on the broadcast station and signal, the auto time set up may not be correct. In this case, set the time manually.

Clock Set: Set the **Month, Day, Year, Hour, Minute** and **am/pm**.

✎ Available only when **Clock Mode** is set to **Manual**.

✎ You can set the month, day, year, hour and minute directly by pressing the number buttons on the remote control.

DST (Off / On): Switches the DST(Daylight Saving Time) function on or off.

✎ This function is only available when the **Clock Mode** is set to **Auto**.

Time Zone: Select your time zone.

✎ This function is only available when the **Clock Mode** is set to **Auto**.

Using the Sleep Timer

MENU → Setup → Time → Sleep Timer → ENTER

- **Sleep Timer** : Automatically shuts off the TV after a preset period of time. (30, 60, 90, 120, 150 and 180 minutes).

✎ To cancel the **Sleep Timer**, select **Off**.



Setting the On/Off Time

MENU → Setup → Time → Timer 1 → ENTER

- **Timer 1 / Timer 2 / Timer 3:** Three different on / off timer settings can be made. You must set the clock first.

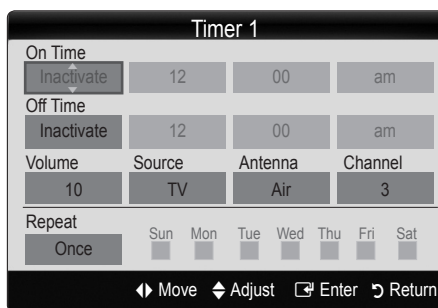

Basic Features

On Time / Off Time: Set the hour, minute, am/pm and activate / inactivate. (To activate the timer with the setting you have chosen, set to **Activate**.)

Volume: Set the desired volume level.

Source: Select **TV** or **USB** content to be played when the TV is turned on automatically. (**USB** can be selected only when a USB device is connected to the TV)

Antenna (when **Source** is set to **TV**): Select **Air** or **Cable**.

Channel (when the **Source** is set to **TV**): Select the desired channel.

Contents (when the **Source** is set to **USB**): Select a folder in the USB device containing music or photo files to be played when the TV is turned on automatically.

 If there is no music file on the USB device or the folder containing a music file is not selected, the Timer function does not operate correctly.

 When there is only one photo file in the USB, the Slide Show will not play.

 If a folder name is too long, the folder cannot be selected.



 Each USB you use is assigned its own folder. When using more than one of the same type of USB, make sure the folders assigned to each USB have different names.

Repeat: Select **Once**, **Everyday**, **Mon~Fri**, **Mon~Sat**, **Sat~Sun** or **Manual** to set at your convenience. If you select **Manual**, you can set up the day you want to activate the timer.

 The  mark indicates the day is selected.

 **Auto Power Off** (available only when the TV is turned on by the Timer): The TV will be automatically turned off after 3 hours of being left idle to prevent overheating.

Locking Programs

 MENU  → Setup → Security → ENTER 

Security

The PIN input screen appears, Enter your 4 digit PIN number.

■ **V-Chip:** The V-Chip feature automatically locks out programs that are deemed inappropriate for children. The user must enter a PIN (personal identification number) before any of the V-Chip restrictions are set up or changed.

NOTE

- **V-Chip** is not available in **HDMI**, **Component** or **PC** mode.
- The default PIN number of a new TV set is "0-0-0-0".
- **Allow all:** Press to unlock all TV ratings.
- **Block all:** Press to lock all TV ratings.

V-Chip Lock (Off / On): You can block rated TV Programs.

TV Parental Guidelines: You can block TV programs depending on their rating. This function allows you to control what your children are watching.

- **TV-Y:** Young children / **TV-Y7:** Children 7 and over / **TV-G:** General audience / **TV-PG:** Parental guidance / **TV-14:** Viewers 14 and over / **TV-MA:** Mature audience
- **ALL:** Lock all TV ratings. / **FV:** Fantasy violence / **V:** Violence / **S:** Sexual situation / **L:** Adult Language / **D:** Sexually Suggestive Dialog

 The V-Chip will automatically block certain categories dealing with more sensitive material. For example, if you block the **TV-Y** category, then **TV-Y7** will automatically be blocked. Similarly, if you block the **TV-G** category, then all the categories in the young adult group will be blocked (**TV-G**, **TV-PG**, **TV-14** and **TV-MA**). The sub-ratings (**D**, **L**, **S**, **V**) work similarly. So, if you block the **L** sub-rating in **TV-PG**, then the **L** sub-ratings in **TV-14** and **TV-MA** will automatically be blocked.

MPAA Rating: You can block movies depending on their MPAA rating. The Motion Picture Association of America(MPAA) has implemented a rating system that provides parents or guardians with advanced information on which films are appropriate for children.

- **G:** General audience (no restrictions). / **PG:** Parental guidance suggested. / **PG-13:** Parents strongly cautioned. / **R:** Restricted. Children under 17 should be accompanied by an adult. / **NC-17:** No children under age 17. / **X:** Adults only. / **NR:** Not rated.

 The **V-Chip** will automatically block any category that deals with more sensitive material. For example, if you block the **PG-13** category, then **R**, **NC-17** and **X** will automatically be blocked.

Canadian English: You can block TV programs depending on their Anglophone Canadian.

- **C:** Programming intended for children under age 8. / **C8+:** Programming generally considered acceptable for children 8 years and over to watch on their own. / **G:** General programming, suitable for all audiences. / **PG:** Parental Guidance. / **14+:** Programming contains themes or content which may not be suitable for viewers under the age of 14. / **18+:** Adult programming.

 The **V-Chip** will automatically block any category that deals with more sensitive material. For example, if you block the **G** category, then **PG**, **14+** and **18+** will automatically be blocked.

Canadian French: You can block TV programs depending on their French Canadian rating.

- **G:** General / **8 ans+:** Programming generally considered acceptable for children 8 years and over to watch on their own. / **13 ans+:** Programming may not be suitable for children under the age of 13. / **16 ans+:** Programming is not suitable for children under the age of 16. / **18 ans+:** Programming restricted to adults.

 The **V-Chip** will automatically block any category that deals with more sensitive material. For example, if you block the **8 ans+** category, then **13 ans+**, **16 ans+** and **18 ans+** will automatically be blocked also.

Downloadable U.S. Rating: Parental restriction information can be used while watching DTV channels.

 **NOTE**

- If information is not downloaded from the broadcasting station, the **Downloadable U.S. Rating** menu is deactivated.
- Parental restriction information is automatically downloaded while watching DTV channels. It may take several seconds.
- The **Downloadable U.S. Rating** menu is available for use after information is downloaded from the broadcasting station. However, depending on the information from the broadcasting station, it may not be available for use.
- Parental restriction levels differ depending on the broadcasting station. The default menu name and **Downloadable U.S. Rating** change depending on the downloaded information.
- Even if you set the on-screen display to another language, the **Downloadable U.S. Rating** menu will appear in English only.
- The rating will automatically block certain categories that deal with more sensitive material.
- The rating titles (For example: Humor Level..etc) and TV ratings (For example: DH, MH, H..etc) may differ depending on the broadcasting station.

- **Change PIN:** The Change PIN screen will appear. Choose any 4 digits for your PIN and enter them. As soon as the 4 digits are entered, the **Confirm New PIN** screen appears. Re-enter the same 4 digits. When the Confirm screen disappears, your PIN has been memorized.



How to watch a restricted channel

If the TV is tuned to a restricted channel, the V-Chip will block it. The screen will go blank and the following message will appear:

This channel is blocked by V-Chip. Please enter the PIN to unblock.



 If you forget the PIN, press the remote-control buttons in the following sequence, which resets the pin to "0-0-0-0": **POWER** (off) → **MUTE** → 8 → 2 → 4 → **POWER** (on).

Other Features

 **MENU**  → **Setup** → **ENTER** 

Menu Language

Set the menu language.

1. Select **Menu Language** and press the **ENTER**  button.
2. Choose desired language and press the **ENTER**  button.
 -  Choose between **English**, **Español** and **Français**.

Caption

(On-Screen Text Messages)

- **Caption (Off / On):** You can switch the caption function on or off. If captions are not available, they will not be displayed on the screen.

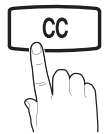

 The **Caption** feature does not work in Component, HDMI or PC modes.

- **Caption Mode:** You can select the desired caption mode.

 The availability of captions depends on the program being broadcasted.

Default / CC1~CC4 / Text1~Text4: (analog channels only) The Analog Caption function operates in either analog TV channel mode or when a signal is supplied from an external device to the TV. (Depending on the broadcasting signal, the Analog Caption function may or may not work with digital channels.)

Default / Service1~Service6 / CC1~CC4 /

Text1~Text4: (digital channels only) The Digital Captions function works with digital channels.

 **Service1~6** may not be available in digital caption mode depending on the broadcast.

Basic Features

■ Digital Caption Options: (digital channels only)

Size: Options include Default, Small, Standard and Large. The default is Standard.

Font Style: Options include Default and Styles 0 to 7. The default is Style 0.

Foreground Color: Options include Default, White, Black, Red, Green, Blue, Yellow, Magenta and Cyan. You can change the color of the letter. The default is White.

Background Color: Options include Default, White, Black, Red, Green, Blue, Yellow, Magenta and Cyan. You can change the background color of the caption. The default is Black.

Foreground Opacity: This adjusts the opacity of text. Options include Default, Transparent, Translucent, Solid and Flashing.

Background Opacity: This adjusts the opacity of the caption background. Options include Default, Transparent, Translucent, Solid and Flashing.

Return to Default: This option sets each Size, Font Style, Foreground Color, Background Color, Foreground Opacity and Background Opacity to its default.

NOTE

- **Digital Caption Options** are available only when **Default** and **Service1 ~ Service6** can be selected in Caption Mode.
- The availability of captions depends on the program being broadcasted.
- The **Default** setting follow the standards set by the broadcaster.
- The Foreground and Background cannot be set to have the same color.
- You cannot set both the **Foreground Opacity** and the **Background Opacity** to Transparent.

General

- **Game Mode (Off / On):** When connecting to a game console such as PlayStation™ or Xbox™, you can enjoy a more realistic gaming experience by selecting the game menu.

NOTE

- Precautions and limitations for game mode
 - To disconnect the game console and connect another external device, set **Game Mode** to **Off** in the setup menu.
 - If you display the TV menu in **Game Mode**, the screen shakes slightly.
- **Game Mode** is not available when the input source is set to **TV** or **PC**.
- After connecting the game console, set **Game Mode** to **On**. Unfortunately, you may notice reduced picture quality.
- If **Game Mode** is **On**:
 - **Picture** mode is set to **Standard** and **Sound** mode is set to **Movie**.
 - **Equalizer** is not available.

- **Menu Transparency (Bright / Dark):** Set the Transparency of the menu.

- **Melody (Off / Low / Medium / High):** Set so that a melody plays when the TV is turned on or off.

NOTE

- Only available when the Input source is set to TV. To turn the melody off, set **Melody** to **Off**.
- The **Melody** does not play.
 - When no sound is output from the TV because the **MUTE** button has been pressed.
 - When no sound is output from the TV because the volume has been reduced to minimum with the **VOL –** button.
 - When the TV is turned off by **Sleep Timer** function.

Picture In Picture (PIP)

PIP







 MENU  → Setup → PIP → ENTER 

You can watch the TV tuner and one external video source simultaneously. **PIP** (Picture-in-Picture) does not function in the same mode.



NOTE

- For PIP sound, refer to the Sound Select instructions.
- If you turn the TV off while watching in PIP mode, the PIP window will disappear.
- You may notice that the picture in the PIP window becomes slightly unnatural when you use the main screen to view a game or karaoke.
- While **V-Chip** operation, the **PIP** function cannot be used.
- PIP Settings

Main picture	Sub picture
Component1, Component2, HDMI1/DVI, HDMI2, HDMI3, PC	TV

- **PIP (Off / On):** Activate or deactivate the PIP function.
- **Air/Cable (Air / Cable):** Select either **Air** or **Cable** as the input source for the sub-screen.
- **Channel:** Select the channel for the sub-screen.
- **Size** ( / ): Select a size for the sub-picture.
- **Position** ( /  /  / ): Select a position for the sub-picture.
- **Sound Select (Main / Sub):** You can choose the desired sound (**Main** or **Sub**) in **PIP** mode.



Support Menu

 MENU  → Support → ENTER 

Self Diagnosis

- **Picture Test:** Use to check for picture problems. If the problem continues to occur, check the Color pattern.

Yes: If the test pattern does not appear or there is noise in the test pattern, select Yes. There may be a problem with the TV. Contact Samsung's Call Center for assistance (1-800-SAMSUNG).

No: If the test pattern is properly displayed, select No. There may be a problem with your external equipment. Please check your connections. If the problem persists, refer to the external device's user manual.
- **Sound Test:** Use the built-in melody sound to check for sound problems.
 -  If you hear no sound from the TV's speakers, before performing the sound test, make sure **Speaker Select** is set to **TV speaker** in the **Sound** menu.
 -  The melody will be heard during the test even if **Speaker Select** is set to **External Speaker** or the sound is muted by pressing the **MUTE** button.

Yes: If you can hear sound only from one speaker or not at all during the sound test, select Yes. There may be a problem with the TV. Contact Samsung's Call Center for assistance (1-800-SAMSUNG).

No: If you can hear sound from the speakers, select No. There may be a problem with your external equipment. Please check your connections. If the problem persists, refer to the external device's user manual.
- **Signal Information:** (Digital channels only) An HD channel's reception quality is either perfect or the channels are unavailable. Adjust your antenna to increase signal strength.
- **Troubleshooting:** If the TV seems to have a problem, refer to this description.
 -  If none of these troubleshooting tips apply, contact the Samsung customer service center.

Software Upgrade

Software Upgrade can be performed by downloading the latest firmware from samsung.com to a USB memory device.

Current Version - the software already installed in the TV.

 Software is represented as 'Year/Month/Day_Version'.

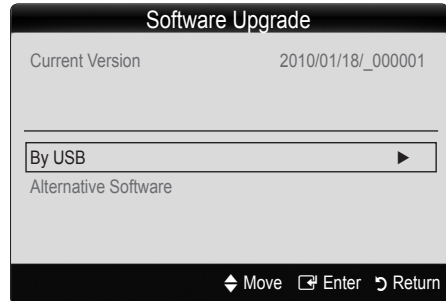

Installing the Latest Version

- **By USB:** Insert a USB drive containing the firmware upgrade file, downloaded from www.samsung.com, into the TV. Please be careful not to disconnect the power or remove the USB drive until upgrades are complete. The TV will be turned off and on automatically after completing the firmware upgrade. When software is upgraded, video and audio settings you have made will return to their default settings. We advise you to write down your settings so that you can easily reset them after the upgrade.
- **Alternative Software** (Not available)

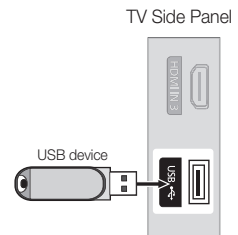

HD Connection Guide

Refer to this information when connecting external devices to the TV.

Contact Samsung

View this information when your TV does not work properly or when you want to upgrade the software. You can find information regarding our call centers and how to download products and software.



Advanced Features

Media Play



Enjoy photos, music and/or movie files saved on a USB Mass Storage Class (MSC) device and/or your PC.



MENU  → Application → Media Play
→ ENTER 





Connecting a USB Device

1. Turn on your TV.
2. Connect a USB device containing photo, music and/or movie files to the **USB** jack on the side of the TV.
3. When USB is connected to the TV, popup window appears. Then you can select **Media Play**.

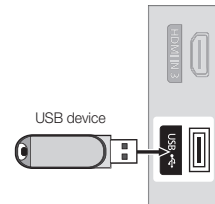
TV Side Panel





 It might not work properly with unlicensed multimedia files.

 Need-to-Know List before using **Media Play**

- MTP (Media Transfer Protocol) is not supported.
- The file system supports FAT16, FAT32 and NTFS.
- Certain types of USB Digital camera and audio devices may not be compatible with this TV.
- **Media Play** only supports USB Mass Storage Class (MSC) devices. MSC is a Mass Storage Class Bulk-Only Transport device. Examples of MSC are Thumb drives and Flash Card Readers. Devices should be connected directly to the TV's USB port. USB (HDD) is not supported.
- Before connecting your device to the TV, please back up your files to prevent them from damage or loss of data. SAMSUNG is not responsible for any data file damage or data loss.
- Do not disconnect the USB device while it is loading.
- The higher the resolution of the image, the longer it takes to display on the screen.
- The maximum supported JPEG resolution is 15360X8640 pixels.
- For unsupported or corrupted files, the "Not Supported File Format" message is displayed.
- If the files are sorted by Basic View, up to 1000 files can be displayed in each folder.
- MP3 files with DRM that have been downloaded from a non-free site cannot be played. Digital Rights Management (DRM) is a technology that supports the creation, distribution and management of the content in an integrated and comprehensive way, including the protection of the rights and interests of the content providers, the prevention of the illegal copying of contents, as well as managing billings and settlements.
- If more than 2 PTP devices are connected, you can only use one at a time.
- If more than two MSC devices are connected, some of them may not be recognized. A USB device that requires high power (more than 500mA or 5V) may not be supported.
- If an over-power warning message is displayed while you are connecting or using a USB device, the device may not be recognized or may malfunction.
- If the TV has been no input during time set in **Auto Protection Time**, the Screensaver will run.
- If a USB extension cable is used, the USB device may not be recognized or the files on the device may not be read.
- If a USB device connected to the TV is not recognized, the list of files on the device is corrupted or a file in the list is not played, connect the USB device to the PC, format the device and check the connection.
- If a file deleted from the PC is still found when Media Play is run, use the "Empty the Recycle Bin" function on the PC to permanently delete the file.

Screen Display

Move to the desired file using the up/down/right/left buttons and then press the ENTER  or  (Play) button. The file is played.

 Supports the **View Devices** and **Contents Mode in Media Play** homepage.

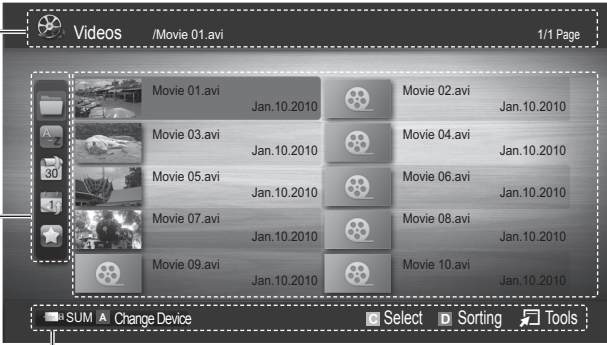





Information: You can ascertain the selected file name and the number of files and page.



Sort List Section: Displays the sorting standard.

The sorting standard is different depending on the contents.

File List Section: You can confirm the files and groups that are sorted by category.











Operation Buttons

-  **Red (Change Device):** Selects a connected device.
-  **Green (Preference):** Sets the file preference. (not supported in Basic view)
-  **Yellow (Select):** Selects multiple files from file list. Selected files are marked with a symbol.
-  **Blue (Sorting):** Selects the sort list.
-  **Tools:** Displays the option menu.

 Using the  or  button, file list can move to next or previous page.

Videos

Playing Video

1. Press the  or  button to select **Videos**, then press the ENTER  button in the **Media Play** menu.
2. Press the /// button to select the desired video in the file list.
3. Press the ENTER  button or  (Play) button.
 - The selected file is displayed on the top with its playing time.
 - If video time information is unknown, play time and progress bar are not displayed.
 - During video playback, you can search using  and  button.

 In this mode, you can enjoy movie clips contained on a Game, but you cannot play the Game itself.

- Supported Subtitle Formats

Name	File extension	Format
MPEG-4 time-based text	.txt	XML
SAMI	.smi	HTML
SubRip	.srt	string-based
SubViewer	.sub	string-based
Micro DVD	.sub or .txt	string-based

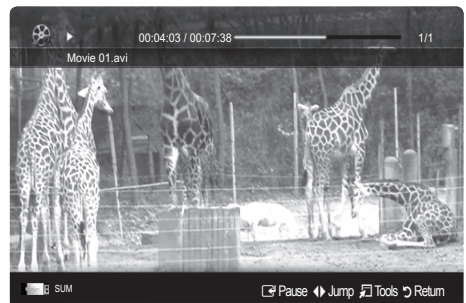

Advanced Features

- Supported Video Formats

File Extension	Container	Video Codec	Resolution	Frame rate (fps)	Bit rate (Mbps)	Audio Codec
*.avi *.mkv	AVI MKV	Divx 3.11 / 4.x / 5.1 / 6.0	1920x1080	6 - 30	8	MP3 / AC3 / LPCM / ADPCM / DTS Core
		XviD	1920x1080	6 - 30	8	
		H.264 BP / MP / HP	1920x1080	6 - 30	25	
		MPEG4 SP / ASP	1920x1080	6 - 30	8	
*.asf	ASF	Divx 3.11 / 4.x / 5.1 / 6.0	1920x1080	6 - 30	8	MP3 / AC3 / LPCM / ADPCM / WMA
		XviD	1920x1080	6 - 30	8	
		H.264 BP / MP / HP	1920x1080	6 - 30	25	
		MPEG4 SP / ASP	1920x1080	6 - 30	8	
*.wmv	ASF	Window Media Video v9	1920x1080	6 - 30	25	WMA
*.mp4	MP4	H.264 BP / MP / HP	1920x1080	6 - 30	25	MP3 / ADPCM / AAC
		MPEG4 SP / ASP	1920x1080	6 - 30	8	
		XVID	1920x1080	6 - 30	8	
*.3gp	3GPP	H.264 BP / MP / HP	1920x1080	6 - 30	25	ADPCM / AAC / HE-AAC
		MPEG4 SP / ASP	1920x1080	6 - 30	8	
*.vro *.vob	VRO VOB	MPEG1	1920x1080	24 / 25 / 30	30	AC3 / MPEG / LPCM
		MPEG2	1920x1080	24 / 25 / 30	30	
*.mpg *.mpeg	PS	MPEG1	1920x1080	24 / 25 / 30	30	AC3 / MPEG / LPCM / AAC
		MPEG2	1920x1080	24 / 25 / 30	30	
		H.264	1920x1080	6 - 30	25	
*.ts *.tp *.trp	TS	MPEG2	1920x1080	24 / 25 / 30	30	AC3 / AAC / MP3 / DD+ / HE-AAC
		H.264	1920x1080	6 - 30	25	
		VC1	1920x1080	6 - 30	25	

Other Restrictions

NOTE

- If there are problems with the contents of a codec, the codec will not be supported.
- If the information for a Container is incorrect and the file is in error, the Container will not be able to play correctly.
- Sound or video may not work if the contents have a standard bitrate/frame rate above the compatible Frame/sec listed in the table above.

Video Decoder	Audio Decoder
<ul style="list-style-type: none"> Supports up to H.264, Level 4.1 H.264 FMO / ASO / RS, VC1 SP / MP / AP L4 and AVCHD are not supported. H.263 is not supported. GMC 2 is not support. 	<ul style="list-style-type: none"> Supports up to WMA 7, 8, 9, STD WMA 9 PRO does not support 2 channel excess multi channel or lossless audio. WMA sampling rate 22050Hz mono is not supported.

Playing movie continuously (Resume Play)

If you exit the playing movie function, the movie can be played later from the point where it was stopped.

1. Select the movie file you want to play continuously by pressing the ◀ or ▶ button to select it from the file list section.
2. Press the ▶ (Play) / ENTER button.
3. Select **Play Continuously** (Resume Play) by pressing the Blue button. The Movie will begin to play from where it was stopped.
 - ✎ The Blue button is available when resuming play.
 - ✎ If the **Continuous Movie Play Help** function is set to **On** in the **Settings** menu, a pop-up message will appear when you resume play a movie file.

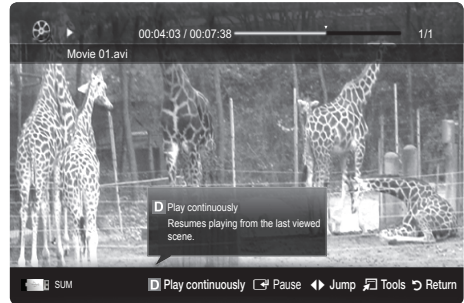

Music

Playing Music

1. Press the ◀ or ▶ button to select **Music**, then press the ENTER button in the **Media Play** menu.
 2. Press the ◀/▶/▲/▼ button to select the desired Music in the file list.
 3. Press the ENTER button or ▶ (Play) button.
 - During music playback, you can search using ◀ and ▶ button.
 - ◀◀ (REW) and ▶▶ (FF) buttons do not function during play.
- ✎ Only displays the files with MP3 and PCM file extension. Other file extensions are not displayed, even if they are saved on the same USB device.
- ✎ If the sound is abnormal when playing MP3 files, adjust the **Equalizer** in the **Sound** menu. (An over-modulated MP3 file may cause a sound problem.)

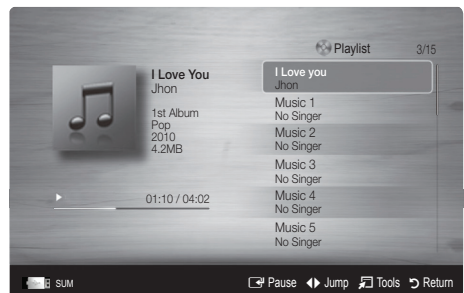

Photos

Viewing a Photo (or Slide Show)

1. Press the ◀ or ▶ button to select **Photos**, then press the ENTER button in the **Media Play** menu.
 2. Press the ◀/▶/▲/▼ button to select the desired photo in the file list.
 3. Press the ENTER button or ▶ (Play) button.
 - While a photo list is displayed, press the ▶ (Play) / ENTER button on the remote control to start the slide show.
 - All files in the file list section will be displayed in the slide show.
 - During the slide show, files are displayed in order.
- ✎ Music files can be automatically played during the Slide Show if the **Background Music** is set to **On**.
- ✎ The **BGM Mode** cannot be changed until the BGM has finished loading.



Advanced Features

Playing Multiple Files

Playing selected video/music/photo files

1. Press the Yellow button in the file list to select the desired file.
2. Repeat the above operation to select multiple files.

NOTE

- The ✓ mark appears to the left of the selected files.
 - To cancel a selection, press the Yellow button again.
 - To deselect all selected files, press the **TOOLS** button and select **Deselect All**.
3. Press the **TOOLS** button and select **Play Selected Contents**.



Playing the video/music/photo file group

1. While a file list is displayed, move to any file in desired group.
2. Press the **TOOLS** button and select **Play Current Group**.

Media Play - Additional Functions

Sorting the file list

Press the Blue button in the file list to sort the files.

Category	Operation	Videos	Music	Photos
Basic View	Displays the whole folder. You can view the photo by selecting the folder.	✓	✓	✓
Title	Sorts and displays the file title in Symbol/Number/Alphabet/Special order.	✓	✓	✓
Preference	Sorts and displays the file by preference. You can change the file preference in the file list section using the Green button.	✓	✓	✓
Latest Date	Sorts and shows files by the latest date.	✓		✓
Earliest Date	Sorts and shows files by the earliest date.	✓		✓
Artist	Sorts the music file by artist in alphabetical order.		✓	
Album	Sorts the music file by album in alphabetical order.		✓	
Genre	Sorts music files by the genre.		✓	
Mood	Sorts music files by the mood. You can change the music mood information.		✓	
Monthly	Sorts and shows photo files by month.			✓

Videos/Music/Photos Play Option menu

During playing a file, press the TOOLS button.

Category	Operation	Videos	Music	Photos
Title	You can move the other file directly.	✓		
Repeat Mode	You can play movie and music files repeatedly.	✓	✓	
Picture Size (Mode1 / Mode2 / Original)	You can adjust the picture size to your preference.	✓		
Picture Setting	You can adjust the picture setting. (p. 13, 14, 15)	✓		✓
Sound Setting	You can adjust the sound setting. (p. 16, 17)	✓	✓	✓
Subtitle Setting	You can play the video with Subtitles. This function only works if the subtitles are the same file name as the video.	✓		
Audio	You can enjoy video in one of supported languages as required. The function is only enabled when stream-type files which support multiple audio formats are played.	✓		
Stop Slide Show / Start Slide Show	You can start or stop a Slide Show.			✓
Slide Show Speed	You can select the slide show speed during the slide show.			✓
Background Music	You can set and select background music when watching a Slide Show.			✓
Zoom	You can zoom into images in full screen mode.			✓
Rotate	You can rotate images in full screen mode.			✓
Information	You can see detailed information about the played file.	✓	✓	✓

Settings

Using the Setup Menu

- **Continuous Movie Play Help (Resume Play) (On / Off):** Select to display the help pop-up message for continuous movie playback.
- **Get DivX® VOD registration code:** Shows the registration code authorized for the TV. If you connect to the DivX web site and register, you can download the VOD registration file. If you play the VOD registration using Media Play, the registration is completed.
 - ✎ For more information on DivX® VOD, visit “www.DivX.com.”
- **Get DivX® VOD deactivation code:** When DivX® VOD is not registered, the registration deactivation code is displayed. If you execute this function when DivX® VOD is registered, the current DivX® VOD registration is deactivated.
- **Information:** Select to view information about the connected device.

Advanced Features

Anynet+

What is Anynet+?

Anynet+ is a function that enables you to control all connected Samsung devices that support Anynet+ with your Samsung TV's remote. The Anynet+ system can be used only with Samsung devices that have the Anynet+ feature. To be sure your Samsung device has this feature, check if there is an Anynet+ logo on it.

To connect to a Samsung Home Theater

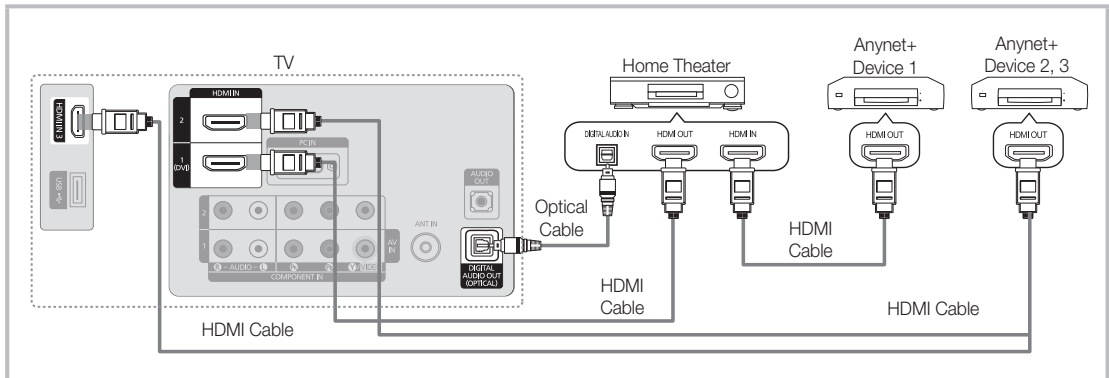

1. Connect the **HDMI IN (1 (DVI), 2 or 3)** jack on the TV and the **HDMI OUT** jack of the corresponding Anynet+ device using an HDMI cable.
2. Connect the **HDMI IN** jack of the home theater and the **HDMI OUT** jack of the corresponding Anynet+ device using an HDMI cable.

NOTE

- Connect the **Optical cable** between the **DIGITAL AUDIO OUT (OPTICAL)** jack on your TV and the **Digital Audio Input** on the Home Theater.
- When following the connection above, the **Optical jack** only outputs 2 channel audio. You will only hear sound from the Home Theater's Front Left and Right speakers and the subwoofer. If you want to hear 5.1 channel audio, connect the **DIGITAL AUDIO OUT (OPTICAL)** jack on the DVD / Satellite Box (i.e. Anynet Device 1 or 2) directly to the Amplifier or Home Theater, not the TV.
- Only one Home Theater can be connected.
- You can connect an Anynet+ device using the HDMI cable. Some HDMI cables may not support Anynet+ functions.
- Anynet+ works when the AV device supporting Anynet+ is in the standby or on status.
- Anynet+ supports up to 12 AV devices in total. Note that you can connect up to 3 devices of the same type.

Anynet+ Menu

The Anynet+ menu changes depending on the type and status of the Anynet+ devices connected to the TV.

Anynet+ Menu	Description
View TV	Changes Anynet+ mode to TV broadcast mode.
Device List	Shows the Anynet+ device list.
(device_name) MENU	Shows the connected device menus. E.g. If a DVD recorder is connected, the disc menu of the DVD recorder will appear.
(device_name) INFO	Shows the play menu of the connected device. E.g. If a DVD recorder is connected, the play menu of the DVD recorder will appear.
Recording: (*recorder)	Starts recording immediately using the recorder. (This is only available for devices that support the recording function.)
Stop Recording: (*recorder)	Stops recording.
Receiver	Sound is played through the receiver.

If more than one recording device is connected, they are displayed as (*recorder) and if only one recording device is connected, it will be represented as (*device_name).

Setting Up Anynet+

 MENU  → Application → Anynet+ (HDMI-CEC) → ENTER 

Setup

Anynet+ (HDMI-CEC) (Off / On): To use the Anynet+ Function, **Anynet+ (HDMI-CEC)** must be set to **On**.



 When the **Anynet+ (HDMI-CEC)** function is disabled, all the Anynet+ related operations are deactivated.

Auto Turn Off (No / Yes): Setting an Anynet+ Device to turn off automatically when the TV is turned off.

 If **Auto Turn Off** is set to **Yes**, running external devices will turn off at the same time as the TV powers off. However, a device may not turn off if recording is in progress.







 May not be enabled depending on the device.

Switching between Anynet+ Devices

- Anynet+ devices connected to the TV are listed.
 -  If you cannot find a device you want, press the red button to refresh the list.
- Select a device and press the ENTER  button. You can switch to the selected device.
 -  Only when you set **Anynet+ (HDMI-CEC)** to **On** in the **Application** menu, the **Device List** menu appears.
 - Switching to the selected device may take up to 2 minutes. You cannot cancel the operation during the switching operation.
 - If you have selected external input mode by pressing the **SOURCE** button, you cannot use the Anynet+ function. Make sure to switch to an Anynet+ device by using the **Device List**.

Recording

You can make a recording of a TV Program using a Samsung recorder.

- Select **Recording**.
 -  When there are more than two recording devices
 - When multiple recording devices are connected, the recording devices are listed. Select one recording device in the **Device List**.
 -  When the recording device is not displayed, select **Device List** and press the Red button to search devices.
- Press the EXIT button to exit.
 -  You can record the source streams by selecting **Recording:** (device_name).
 -  Pressing the  (REC) button will record whatever you are currently watching. If you are watching video from another device, the video from the device is recorded.
 -  Before recording, check whether the antenna jack is properly connected to the recording device. To properly connect an antenna to a recording device, refer to the recording device's users manual.

Advanced Features

Listening through a Receiver

You can listen to sound through a receiver (i.e Home Theater) instead of the TV speaker.

1. Select **Receiver** and set to **On**.
2. Press the **EXIT** button to exit.

 If your receiver supports audio only, it may not appear in the device list.

 The receiver will work when you have properly connected the optical in jack of the receiver to the **DIGITAL AUDIO OUT (OPTICAL)** jack of the TV.

 When the receiver (i.e Home Theater) is set to **On**, you can hear sound output from the TV's Optical jack. When the TV is displaying a DTV (air) signal, the TV will send out 5.1 channel sound to the receiver. When the source is a digital component such as a DVD and is connected to the TV via HDMI, only 2 channel sound will be heard from the receiver.

NOTE

- You can only control Anynet+ devices using the TV remote control, not the buttons on the TV.
- The TV remote control may not work under certain conditions. If this occurs, reselect the Anynet+ device.
- The Anynet+ functions do not operate with other manufacturers' products.

Troubleshooting for Anynet+

Problem	Possible Solution
Anynet+ does not work.	<ul style="list-style-type: none">• Check if the device is an Anynet+ device. The Anynet+ system supports Anynet+ devices only.• Only one receiver (home theater) can be connected.• Check if the Anynet+ device power cord is properly connected.• Check the Anynet+ device's Video/Audio/HDMI cable connections.• Check whether Anynet+ (HDMI-CEC) is set to On in the Anynet+ setup menu.• Check whether the TV remote control is in TV mode.• Check whether the remote control is Anynet+ compatible.• Anynet+ does not work in certain situations. (Searching channels, operating Media Play or Plug & Play (initial setup), etc.)• When connecting or removing the HDMI cable, please make sure to search devices again or turn your TV off and on again.• Check if the Anynet+ Function of Anynet+ device is set on.
I want to start Anynet+.	<ul style="list-style-type: none">• Check if the Anynet+ device is properly connected to the TV and check if the Anynet+ (HDMI-CEC) is set to On in the Anynet+ Setup menu.• Press the TOOLS button to display the Anynet+ menu and select a menu you want.
I want to exit Anynet+.	<ul style="list-style-type: none">• Select View TV in the Anynet+ menu.• Press the SOURCE button on the TV remote control and select a device other than Anynet+ devices.• Press ∨ CH ^, CH LIST, PRE-CH, and FAV.CH to change the TV mode. (Note that the channel button operates only when a tuner-embedded Anynet+ device is not connected.)
The message 'Connecting to Anynet+ device...' appears on the screen.	<ul style="list-style-type: none">• You cannot use the remote control when you are configuring Anynet+ or switching to a view mode.• Use the remote control when the Anynet+ setting or switching to view mode is complete.
The Anynet+ device does not play.	<ul style="list-style-type: none">• You cannot use the play function when Plug & Play (initial setup) is in progress.
The connected device is not displayed.	<ul style="list-style-type: none">• Check whether or not the device supports Anynet+ functions.• Check whether or not the HDMI cable is properly connected.• Check whether Anynet+ (HDMI-CEC) is set to On in the Anynet+ setup menu.• Search Anynet+ devices again.• You can connect an Anynet+ device using the HDMI cable only. Some HDMI cables may not support Anynet+ functions.• If it is terminated by an abnormal situation such as disconnecting the HDMI cable or power cord or a power failure, please repeat the device scan.
The TV Program cannot be recorded.	<ul style="list-style-type: none">• Check whether the antenna jack on the recording device is properly connected.
The TV sound is not output through the receiver.	<ul style="list-style-type: none">• Connect the optical cable between TV and the receiver.

Installing the Wall Mount



Wall or Ceiling Mounting

The product should be mounted to a wall or ceiling only as recommended by the manufacturer. Unless it is correctly mounted, the product may slide or fall, causing serious injury to a child or adult, and serious damage to the product.

Assembling the Blanking Bracket (26 inch TV)

When installing the TV onto a wall, attach the Blanking Bracket as shown.

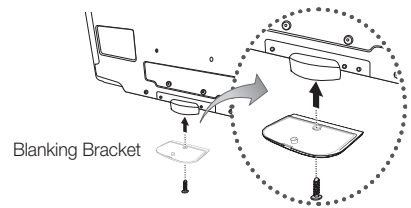

Installing the Wall Mount Kit

The wall mount kit (sold separately) allows you to mount the TV on the wall.

For detailed information on installing the wall mount, see the instructions provided with the wall mount items. Contact a technician for assistance when installing the wall mount bracket. Samsung Electronics is not responsible for any damage to the product or injury to yourself or others if you elect to install the TV on your own.

Wall Mount Kit Specifications (VESA)

The wall mount kit is not supplied, but sold separately.

Install your wall mount on a solid wall perpendicular to the floor. When attaching to other building materials, please contact your nearest dealer. If installed on a ceiling or slanted wall, it may fall and result in severe personal injury.

NOTE

- Standard dimensions for wall mount kits are shown in the table below.
- When purchasing our wall mount kit, a detailed installation manual and all parts necessary for assembly are provided.
- Do not use screws that do not comply with the VESA standard screw specifications.
- Do not use screws that are longer than the standard dimension or do not comply with the VESA standard screw specifications. Screws that are too long may cause damage to the inside of the TV set.
- For wall mounts that do not comply with the VESA standard screw specifications, the length of the screws may differ depending on the wall mount specifications.
- Do not fasten the screws too strongly; this may damage the product or cause the product to fall, leading to personal injury. Samsung is not liable for these kinds of accidents.
- Samsung is not liable for product damage or personal injury when a non-VESA or non-specified wall mount is used or the consumer fails to follow the product installation instructions.
- Do not mount the TV at more than a 15 degree tilt.
- Always use two people to mount the TV to a wall.

Product Family	inches	VESA Spec. (A * B)	Standard Screw	Quantity
LCD-TV	19~22	75 X 75	M4	4
	23~29	100 X 100		
	30~40	200 X 100	M6	
	46~55	200 X 200	M8	
	57~65	400 X 400		
	70~80	600 X 400		
	80~	800 X 400		
	80~	1400 X 800		

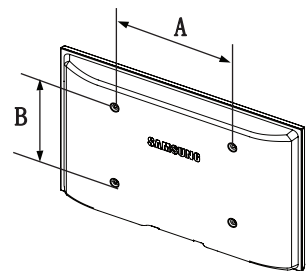

Do not install your Wall Mount Kit while your TV is turned on. It may result in personal injury due to electric shock.

Other Information

Securing the TV to the Wall (LN32C450 Only)



Caution: Pulling, pushing, or climbing on the TV may cause the TV to fall. In particular, ensure your children do not hang over or destabilize the TV. Doing so may cause the TV to tip over, causing serious injuries or death. Follow all safety precautions provided in the Safety Flyer included with your TV. For added stability and safety, you can purchase and install the anti-fall device as described below.

The TV-Holder Kit (Sold Separately)

The parts below are included in the TV Holder kit. In addition, you need to provide a wood screw, screw and molly, or other screw appropriate for the wall or cabinet you intend to secure the TV-Holder string to. We recommend a size M4xL20 wood screw.



TV-Holder (BN96-15753A)



(M6 X L16)





Screw ① (3/2 inches only)

Installing the TV-Holder

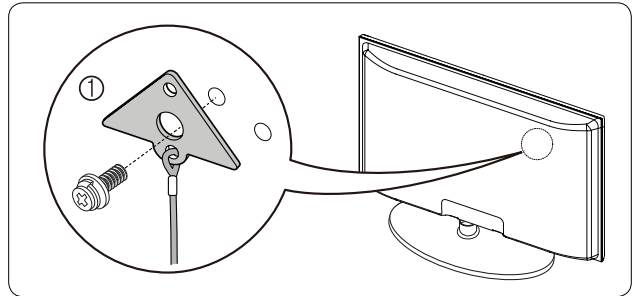
1. Remove the screw attached to the back of your TV, and then connect the TV-Holder to the TV with the screw included in the TV Holder Kit that is designated for your TV.

 Make sure to use only the appropriate supplied screw. If you use a different screw, you can damage your TV.



2. Firmly fasten the screw you provided (size M4xL20 or similar) to the wall or cabinet where the TV is to be installed.
 If you fasten the screw to the wall, we recommend you drive the screw into a stud. If that is not possible, use a molly to anchor the screw.
3. Tie the TV-Holder cord to the screw fastened to the wall or cabinet so that the TV is fixed. See the illustrations below.
 Install the TV close to the wall so that it does not fall.
 When attaching the TV Holder cord to the wall, tie the cord level with the ground or slanted downwards for safety purposes.
 Check the cord occasionally to make sure it is secure.
 Before moving the TV, separate the connected cord first.

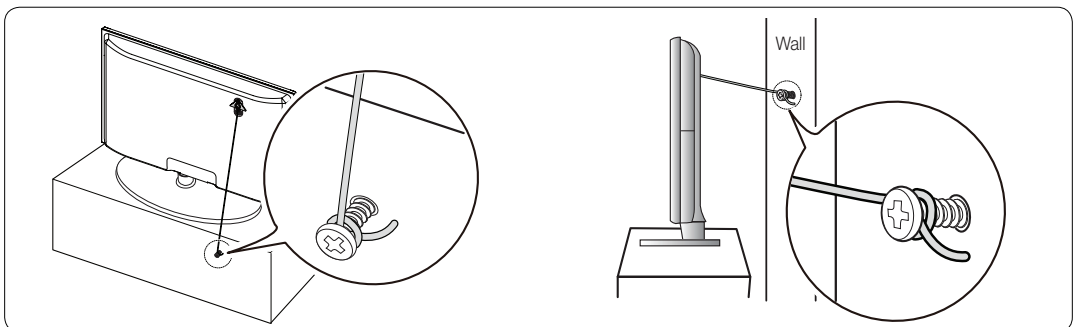

4. Verify all connections are properly secured. Periodically check the connections for any sign of fatigue or failure. If you have any doubt about the security of your connections, contact a professional installer.

To purchase the TV-Holder Kit, contact Samsung Customer Care

- In the United States: 1-800-Samsung (1-800-726-7864)
- In Canada: 1-800-Samsung (1-800-726-7864)

Securing the TV to the Wall



Caution: Pulling, pushing, or climbing onto the TV may cause the TV to fall. In particular, ensure that your children do not hang over or destabilize the TV; doing so may cause the TV to tip over, resulting in serious injuries or death. Follow all safety precautions provided on the included Safety Flyer. For added stability, install the anti-fall device for safety purposes, as follows.

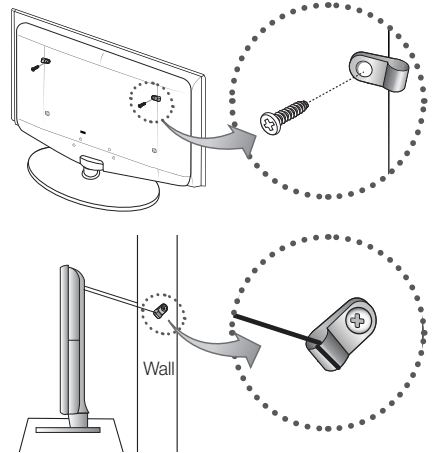

To prevent the TV from falling

- ✎ Since the necessary clamps, screws, and string are not supplied, please purchase these additionally.
- 1. Drive the screws into the clamps and firmly fasten them onto the wall. Make sure the screws are firmly fixed into the wall.
 - ✎ Screw Specifications
 - For a 17 ~ 29 Inches LCD TV: M4
 - For a 32 ~ 40 Inches LCD TV: M6
- 2. Remove the screws from the back center of the TV, put the screws into the clamps, and then fasten the screws onto the TV again.
- 3. Connect the clamps fixed onto the TV and the clamps fixed onto the wall with a strong cable and then tie the string tightly.
- ✎ Verify all connections are properly secured. Periodically check connections for any sign of fatigue for failure. If you have any doubt about the security of your connections, contact a professional installer.
- ✎ Install the TV near to the wall so that it does not fall backwards.
- ✎ It is safe to connect the string so that the clamps fixed on the wall are equal to or lower than the clamps fixed on the TV. Untie the string before moving the TV.



Anti-theft Kensington Lock

The Kensington Lock is not supplied by Samsung. It is a device used to physically fix the system when using it in a public place. The appearance and locking method may differ from the illustration depending on the manufacturer. Refer to the manual provided with the Kensington Lock for additional information on proper use.

- ✎ Please find a “” icon on the rear of the TV.
A kensington slot is beside the “” icon.

To lock the product, follow these steps:

1. Wrap the Kensington lock cable around a large, stationary object such as desk or chair.
2. Slide the end of the cable with the lock attached through the looped end of the Kensington lock cable.
3. Insert the locking device into the Kensington slot on the product (1).
4. Lock the lock.

- ✎ These are general instructions. For exact instructions, see the User manual supplied with the locking device.
- ✎ The locking device has to be purchased separately.
- ✎ The location of the Kensington slot may be different depending on the TV model.

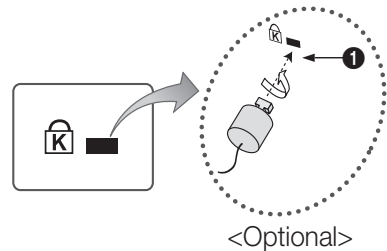

Other Information

Troubleshooting

If the TV seems to have a problem, first try this list of possible problems and solutions. If none of these troubleshooting tips apply, visit samsung.com, then click on Support, or call Samsung customer service at 1-800-SAMSUNG.

Issues	Solutions and Explanations
Poor picture	<p>First of all, please perform the Picture Test and confirm that your TV is properly displaying the test image.</p> <ul style="list-style-type: none"> go to MENU - Support - Self Diagnosis - Picture Test (P. 21) <p>If the test image is properly displayed, the poor picture may be caused by the source or signal.</p>
The TV image does not look as good as it did in the store.	<ul style="list-style-type: none"> If you have an analog cable/satellite box, upgrade to a digital set top box. Use HDMI or Component cables to deliver HD (high definition) picture quality. Cable/Satellite subscribers: Try HD stations from the channel line up. Air/Cable Antenna connection: Try HD stations after performing Auto program.  Many HD channels are upscaled from SD(Standard Definition) contents. Adjust the Cable/Sat box video output resolution to 1080i or 720p.
The picture is distorted: macroblock error, small block, dots, pixelization.	<ul style="list-style-type: none"> Compression of video contents may cause picture distortion, especially in fast moving pictures such as sports and action movies. Low signal level can cause picture distortion. This is not a TV problem. Mobile phones used close to the TV (up to 3.3ft) may cause noise in picture on analog and digital TV.
Color is wrong or missing.	<ul style="list-style-type: none"> If you're using Component connection, make sure the component cables are connected to the correct jacks. Incorrect or loose connections may cause color problems or a blank screen.
There is poor color or brightness.	<ul style="list-style-type: none"> Adjust the Picture options in the TV menu. (go to Picture mode / Color / Brightness / Sharpness) (P. 13) Adjust Energy Saving option in the Eco Solution menu. (P. 14) Try resetting the picture to view the default picture setting. (go to MENU - Picture - Picture Reset) (P. 16)
There is a dotted line on the edge of the screen.	<ul style="list-style-type: none"> If the picture size is set to Screen Fit, change it to 16:9. Change cable/satellite box resolution.
The picture is black and white.	<ul style="list-style-type: none"> If you are using an AV composite input, connect the video cable (yellow) to the Green jack of component input 1 on the TV.
When changing channels, the picture freezes or is distorted or delayed.	<ul style="list-style-type: none"> If connected to a cable box, please try to reset it. (reconnect the AC cord and wait until the cable box reboots. It may take up to 20 minutes) Set output resolution of the cable box to 1080i or 720p.
Sound Problem	<p>First of all, please perform the Sound Test to confirm that your TV audio is properly operating.</p> <ul style="list-style-type: none"> go to MENU - Support - Self Diagnosis - Sound Test (P. 21) <p>If the audio is OK, the sound problem may be caused by the source or signal.</p>
There is no sound or the sound is too low at maximum volume.	<ul style="list-style-type: none"> Please check the volume of the device (Cable/Sat Box, DVD, Blu-ray etc) connected to your TV.
The picture is good but there is no sound.	<ul style="list-style-type: none"> Set the Speaker Select option to TV speaker in the Sound menu. (P. 17) If you are using an external device, check the device's audio output option (ex. you may need to change your cable box's audio option to HDMI when you have a HDMI connected to your TV). If you are using a DVI to HDMI cable, a separate audio cable is required. Reboot the connected device by reconnecting the device's power cable.
The speakers are making an inappropriate noise.	<ul style="list-style-type: none"> Check the cable connections. Make sure a video cable is not connected to an audio input. For Antenna or Cable connections, check the signal information. Low signal level may cause sound distortion. Perform the Sound Test as explained above.

Issues	Solutions and Explanations
No Picture, No Video	
The TV will not turn on.	<ul style="list-style-type: none"> • Make sure the AC power cord is securely plugged in to the wall outlet and the TV. • Make sure the wall outlet is working. • Try pressing the POWER button on the TV to make sure the problem is not the remote. If the TV turns on, refer to 'Remote control does not work' below.
The TV turns off automatically.	<ul style="list-style-type: none"> • Ensure the Sleep Timer is set to Off in the Setup menu. (P. 17) • If your PC is connected to the TV, check your PC power settings. • Make sure the AC power cord is plugged in securely to the wall outlet and the TV. • When watching TV from an antenna or cable connection, the TV will turn off after 10 - 15 minutes if there is no signal.
There is no picture/video.	<ul style="list-style-type: none"> • Check cable connections. (remove and reconnect all cables connected to the TV and external devices). • Set your external device's (Cable/Sat Box, DVD, Blu-ray etc) video outputs to match the connections to the TV input. For example, if an external device's output is HDMI, it should be connected to an HDMI input on the TV. • Make sure your connected devices are powered on. • Be sure to select the TV's correct source by pressing the SOURCE button on the remote control. • Reboot the connected device by reconnecting the device's power cable.
RF(Cable/Antenna) Connection	
The TV is not receiving all channels.	<ul style="list-style-type: none"> • Make sure the coaxial cable is connected securely. • Please try Auto Program to add available channels to the channel list. go to MENU - Channel - Auto program then select Auto and make sure the correct Cable TV signal type is set in the menu. There are 3 options. (STD, HRC and IRC) (P. 12) • Verify the Antenna is positioned correctly.
No Caption on digital channels.	<ul style="list-style-type: none"> • Check Caption Setup menu. Try changing Caption Mode Service 1 to CC1. (P. 19) • Some channels may not have caption data.
The picture is distorted: macroblock, error, small block, dots, pixelization.	<ul style="list-style-type: none"> • Compression of video contents may cause picture distortion. especially on fast moving pictures such as sports and action movies. • A low signal can cause picture distortion. This is not a TV problem.
PC Connection	
A " Mode Not Supported " message appears.	<ul style="list-style-type: none"> • Set your PC's output resolution so it matches the resolutions supported by the TV.
"PC" is always shown on the source list, even if a PC is not connected.	<ul style="list-style-type: none"> • This is normal; "PC" is always shown on the source list, regardless of whether a PC is connected.
The video is OK but there is no audio.	<ul style="list-style-type: none"> • If you are using a HDMI connection, check the audio output setting on your PC.
Others	
Purple/green rolling horizontal bars and buzzing noise from the TV speakers with Component cable connection.	<ul style="list-style-type: none"> • Remove the left and right audio connections from the set-top-box. If the buzzing stops, this indicates that the set-top-box has a grounding issue. Replace the Component video cables with an HDMI connection.
The picture will not display in full screen.	<ul style="list-style-type: none"> • HD channels will have black bars on either side of the screen when displaying upscaled SD (4:3) contents. • Black bars on Top & Bottom will be shown on movies that have aspect ratios different from your TV. • Adjust picture size option on your external device or TV to full screen.
The remote control does not work.	<ul style="list-style-type: none"> • Replace the remote control batteries with correct polarity (+/-). • Clean the transmission window located on the top of the remote. • Try pointing the remote directly at the TV from 5-6 feet away.

Other Information

Issues	Solutions and Explanations
Others	
The cable/set top box remote control does not turn the TV on or off, or adjust the volume.	<ul style="list-style-type: none"> Program the Cable/Sat remote control to operate the TV. Refer to the Cable/Sat user manual for SAMSUNG TV code.
'Mode Not Supported' message.	<ul style="list-style-type: none"> Check the supported resolution of the TV and adjust the external device's output resolution accordingly. Refer to resolution settings in this manual.
Caption on TV menu is greyed out.	<ul style="list-style-type: none"> Caption can not be selected in the TV menu when connected via HDMI or Component. Caption must be activated on the external device.
There is a plastic smell from the TV.	<ul style="list-style-type: none"> This smell is normal and will dissipate over time.
TV Signal Information is unavailable in the Self Diagnosis Test menu.	<ul style="list-style-type: none"> This function is only available with digital channels with an Antenna (RF/Coax) connection (Air or Cable). (P. 21)
TV is tilted to the right or left side.	<ul style="list-style-type: none"> Remove the stand base from the TV and reassemble.
Channel menu is grey out (unavailable).	<ul style="list-style-type: none"> Channel menu is only available when the TV source is selected (Antenna or Cable).
Your settings are lost after 30 minutes or every time the TV is turned off.	<ul style="list-style-type: none"> If TV is in the Store Demo mode, it will reset audio and picture settings every 30 minutes. Please change from Store Demo mode to Home Use mode in the Plug & Play procedure. Press the SOURCE button to select TV mode, go to MENU → Setup → Plug & Play → ENTER .
You have intermittent loss of audio or video.	<ul style="list-style-type: none"> Check the cable connections and reconnect them. Loss of audio or video can be caused by using overly rigid or thick cables. Make sure the cables are flexible enough for long term use. mounting the TV to the wall, we recommend using cables with 90 degree connectors.
The PIP menu is not available.	<ul style="list-style-type: none"> PIP functionality is only available when you are using a HDMI, PC or components source.
You see small particles when you look closely at the edge of the frame of the TV.	<ul style="list-style-type: none"> This is part of the product's design and is not a defect.
POP (TV's internal banner ad) appears on the screen.	<ul style="list-style-type: none"> Select Home Use under Plug & Play mode. For details, refer to Plug & Play (Initial Setup). (P. 7)

 This TFT LCD panel uses a panel consisting of sub pixels which require sophisticated technology to produce. However, there may be a few bright or dark pixels on the screen. These pixels will have no impact on the performance of the product.

Storage and Maintenance

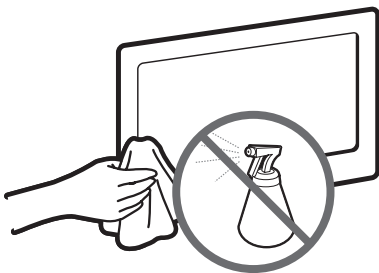

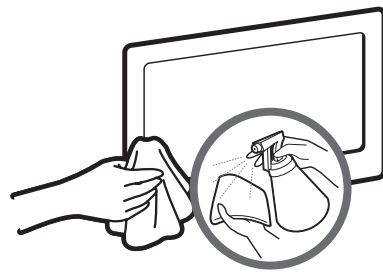

Do not spray water or a cleaning agent directly onto the product. Any liquid that goes into the product may cause a failure, fire, or electric shock.



Clean the product with a soft cloth dipped in a small amount of water.

Specifications

Display Resolution	1360 x 768	
Environmental Considerations		
Operating Temperature	50°F to 104°F (10°C to 40°C)	
Operating Humidity	10% to 80%, non-condensing	
Storage Temperature	-4°F to 113°F (-20°C to 45°C)	
Storage Humidity	5% to 95%, non-condensing	
Model Name	LN26C450	LN32C450
Screen Size (Diagonal)	26 inches (26.0 inches measured diagonally)	32 inches (31.5 inches measured diagonally)
Sound Output	5W X 2	10W X 2
Dimensions (WxDxH)		
Body	25.5 x 3 x 17 inches (646.5 x 77 x 432.3 (mm))	30.9 x 3 x 20.2 inches (784.4 x 76.2 x 514.2 (mm))
With stand	25.5 x 8.7 x 18.8 inches (646.5 x 222.2 x 477.3 (mm))	30.9 x 9.7 x 22 inches (784.4 x 247.2 x 560.0 (mm))
Weight		
Without Stand	13.8 lbs (6.2 kg)	20 lbs (9.1 kg)
With Stand	15 lbs (6.8 kg)	21.2 lbs (9.6 kg)

-  Design and specifications are subject to change without prior notice.
-  This device is a Class B digital apparatus.
-  For information about power supply, and more about power consumption, refer to the label attached to the product.

License



Manufactured under license from Dolby Laboratories. Dolby and the double-D symbol are trademarks of Dolby Laboratories.



DivX Certified to play DivX video up to HD 1080p, including premium content.

ABOUT DIVX VIDEO: DivX® is a digital video format created by DivX, Inc. This is an official DivX Certified device that plays DivX video. Visit www.divx.com for more information and software tools to convert your files into DivX video.
 ABOUT DIVX VIDEO-ON-DEMAND: This DivX Certified® device must be registered in order to play DivX Video-on-Demand (VOD) content. To generate the registration code, locate the DivX VOD section in the device setup menu. Go to vod.divx.com with this code to complete the registration process and learn more about DivX VOD.
 Pat. 7,295,673; 7,460,688; 7,519,274



Manufactured under license under U.S. Patent #'s: 5,451,942; 5,956,674; 5,974,380; 5,978,762; 6,487,535 & other U.S. and worldwide patents issued & pending. DTS and the Symbol are registered trademarks, & DTS 2.0+ Digital Out and the DTS logos are trademarks of DTS, Inc. Product includes software. © DTS, Inc. All Rights Reserved.

Open Source License Notice

In the case of using open source software, Open Source Licenses are available on the product menu.

Other Information

Dimensions

FRONT VIEW / SIDE VIEW

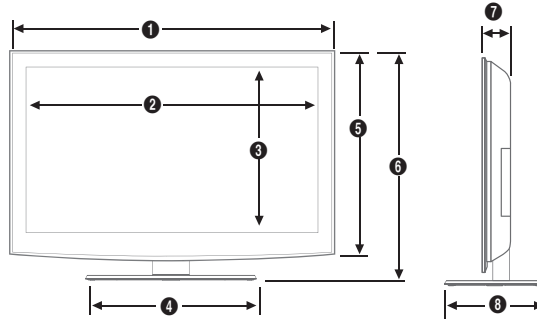

(Unit: inches)

Model name	1	2	3	4	5	6	7	8
LN26C450	25.5	22.7	12.8	17.2	17	18.8	3	8.7
LN32C450	30.9	27.5	15.6	18.4	20.2	22	3	9.7

JACK PANEL DETAIL / REAR VIEW

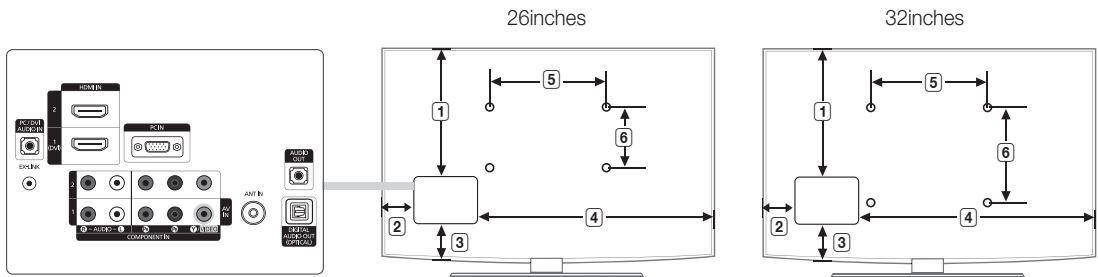

(Unit: inches)

Model name	1	2	3	4	5	6
LN26C450	7.2	2.1	3.8	12.4	7.9	4
LN32C450	10	2.5	4.2	21.6	7.9	7.9

NOTE: All drawings are not necessarily to scale. Some dimensions are subject to change without prior notice. Refer to the dimensions prior to performing installation of your TV. Not responsible for typographical or printed errors.

© 2010 Samsung Electronics America, Inc

Index

A		H		S	
Anynet+	28	HDMI	8, 28	Sleep Timer	17
AUDIO OUT	9	Home theater	9, 28	Slide Show	25
Auto Adjustment	14	L		Software Upgrade	21
B		License	37	Source List	10
Balance	16	M		Speaker Select	17
Blanking Bracket	31	Media Play	22	Standby mode	5
C		Melody	20	T	
Component	8	Menu Language	19	Timer	17
D		MP3 Play	25	V	
DIGITAL AUDIO OUT	9, 28	O		Video play	23
D-sub	9	Optimal resolution	10	Volume	5, 6, 18
DVD home theater	9	P		W	
E		Photo view	25	Wall Mount	31
Editing channels	12	PIN number	19		
Energy Saving	14	PIP	20		
Equalizer	16	Power Indicator	5		
F		R			
FAV.CH button	6, 12	Remote Control	6		
Favorite Channel	12	RGB	14		

Free Manuals Download Website

<http://myh66.com>

<http://usermanuals.us>

<http://www.somanuals.com>

<http://www.4manuals.cc>

<http://www.manual-lib.com>

<http://www.404manual.com>

<http://www.luxmanual.com>

<http://aubethermostatmanual.com>

Golf course search by state

<http://golfingnear.com>

Email search by domain

<http://emailbydomain.com>

Auto manuals search

<http://auto.somanuals.com>

TV manuals search

<http://tv.somanuals.com>