

Quick Setup Guide SERIES 7 750

Congratulations on the purchase of your new Samsung TV. Read this setup guide to get your TV up and running quickly.



1-800-SAMSUNG (1-800-726-7864)
Samsung Electronics America, Inc.
85 Challenger Road Ridgefield Park, NJ 07660-2112
Samsung Electronics Canada Inc.
55 Standish Court Mississauga, Ontario L5R 4B2
Call Center hours of operation: Mon-Sun, 9:00 AM -12 AM EST.
To register this product, visit:
www.samsung.com/register.

Getting Started

Step 1 : Install the Stand

Follow the steps below to connect the TV to the stand.

- Make sure to distinguish between the front and back of the Stand and Guide Stand when assembling them.
- Make sure that at least two people lift and move the LCD TV.
- Stand the product up and fasten the screws. If you fasten the screws with the LCD TV placed down, it may lean to one side.

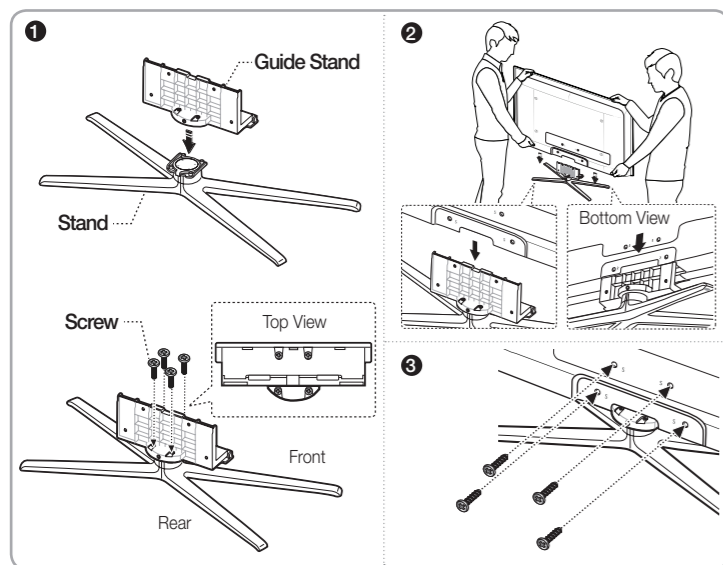

Step 2 : Install the Batteries into the Remote

To install batteries into your remote control, follow these steps:

- Lift the cover on the back of the remote upward as shown in the figure to the right.
- Install two AAA batteries.
 - Make sure to match the + and - ends of the batteries to the diagram in the battery compartment.
- Replace the cover.

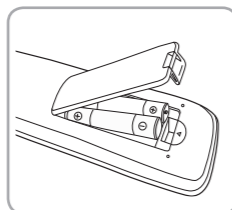

Step 3 : Connect Power and Antenna or Cable

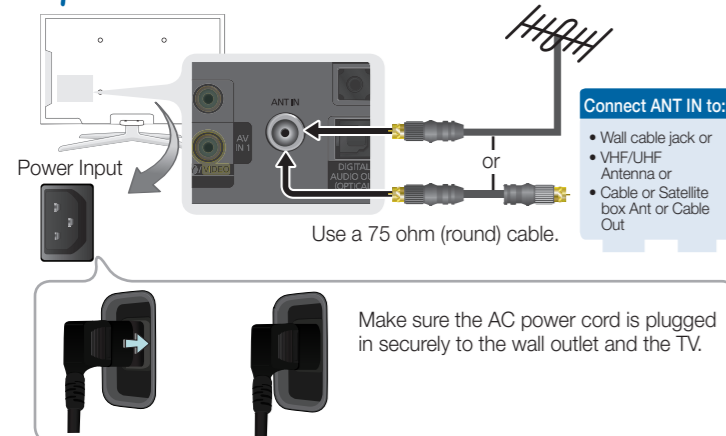

Step 4 : Connect External Devices

Connecting an AV device (Blu-ray player, cable/satellite box, etc.)

For the very best picture quality, select HD signal sources and use HDMI cables and connections. Note that many digital cable programs are not in HD. Check with your video provider to ensure you are receiving HD signals.

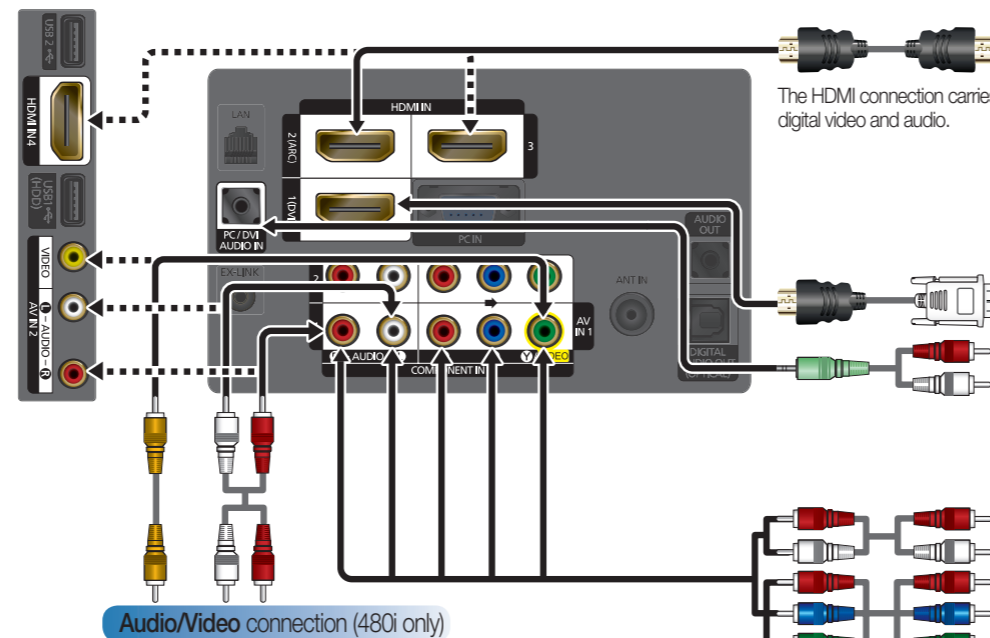

The HDMI connection carries digital video and audio.

★ HD connection (up to 1080p)

Using an HDMI Cable

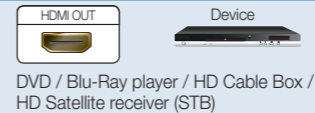

DVD / Blu-Ray player / HD Cable Box / HD Satellite receiver (STB)

Best Connection

★ HD connection (up to 1080p)

Using a DVI to HDMI Cable

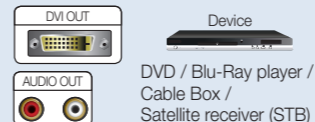

Very Good Connection

Component connection (up to 1080p)

Using a Component Cable

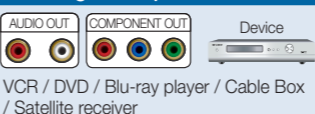

Good Connection

Audio/Video connection (480i only)

Using an Audio/Video Cable

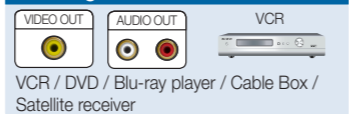

Lowest Quality Connection

When connecting to AV IN 1 on the back of your TV, attach the video cable (yellow) to the green jack next to the AV IN 1 label. The jack will not match the color of the video cable (yellow).

Step 5 : Run Plug & Play

When you turn on your TV for the first time, it automatically launches the **Plug & Play** function. With **Plug & Play**, you can select the On Screen Display language, set the clock mode, and launch the TV's channel memorizing process. It also displays connection instructions similar to those in this guide.

To navigate while **Plug & Play** is running, press the Up, Down, Left or Right arrow buttons on your remote. To make a selection, press the ENTER button. To skip a screen, press the MENU button.

To turn on your TV, press the POWER button on the remote or press the POWER button on the TV. To run **Plug & Play**, follow these steps:

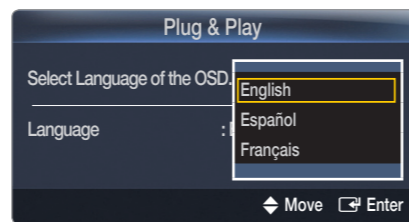

- On the Language screen, select the language for the On Screen Display (OSD) using your remote control, and then press ENTER button. The Home Use screen appears.
- Select **Home Use**, and then press ENTER button. If you select **Store Demo**, the TV will reset your picture and audio settings every 30 minutes. After you press ENTER button, the Antenna Source screen appears.
- If your TV is only attached to an antenna, select **Air**. If your TV is only attached to cable and you have no cable box, select **Cable**. If your TV is attached to an antenna and cable with no box, select **Auto**. When done, press ENTER button on your remote. The Select Cable System screen appears.

IMPORTANT: If your TV is attached to a cable or satellite box, skip Steps 3 through 5. After **Plug & Play** is complete, set your TV to Channel 3 or 4, according to the directions for your cable or satellite box.
- If your TV is attached to a cable system and you have no cable box, you must select your cable system type. If you have Digital cable, you must select the cable system type for both **Analog** and **Digital**.

After you have selected the cable system type, select Start, and then press the ENTER button on your remote.

- Most cable systems are Standard (STD) systems. If you are not sure about what kind of cable system you have, contact your cable company.
- The TV memorizes the available channels. This process can take up to 45 minutes. After the TV has memorized the channels, the **Clock Mode** screen appears.
 - Choose the **Clock Mode**. Select **Auto** if you have a digital channel in your area. Select **Manual** if you don't, or if you have a cable or satellite box. When done, press ENTER button. The Daylight Savings screen appears.
 - If you select **Manual**, the clock setting screen appears.
 - Select the Daylight Saving Time setting: **Off**, **On**, or **Auto**, and then press ENTER button.
 - After the time zone screen, The connection method for best HD screen quality is displayed. Press Right arrow button on your remote to view each screen in succession. Press the Blue button to skip this section.
 - The **Enjoy your TV** screen appears. and then press ENTER button.

Basic Functions

Changing the Screen Size

Your TV has several screen size options, each designed to work best with specific types of video input. If you have a cable box or satellite receiver, it may have its own set of screen sizes as well.

To change the screen size, press the P.SIZE button on your remote. The first time you press it, your TV displays the current setting. Thereafter, each time you press the P.SIZE button, you change the size of the picture on the screen.

Connecting an audio device

Connect your TV to your Home Theater or other audio device to enjoy enhanced sound quality.

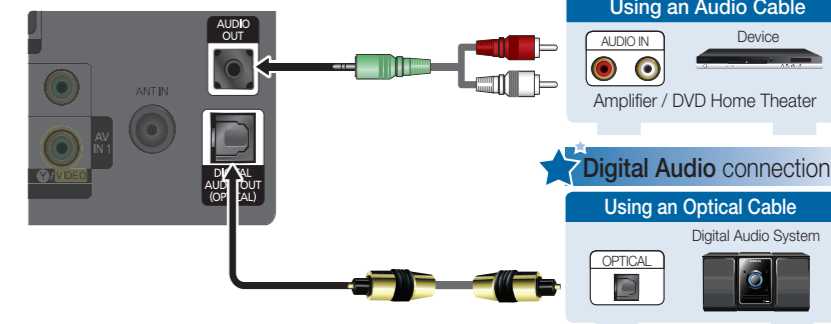

Analog Audio connection

Using an Audio Cable

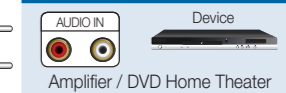

★ Digital Audio connection

Using an Optical Cable

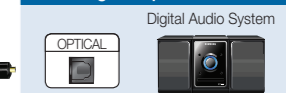

Connecting a PC

Connect your TV to a PC to use it as a Monitor.

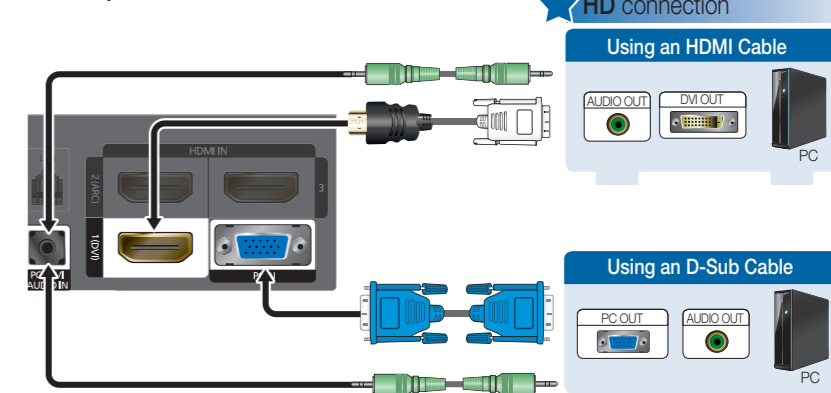

★ HD connection

Using an HDMI Cable

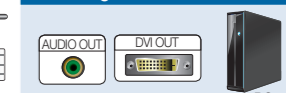

Using a D-Sub Cable

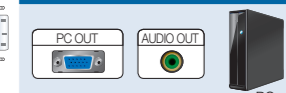

The following sizes are available:

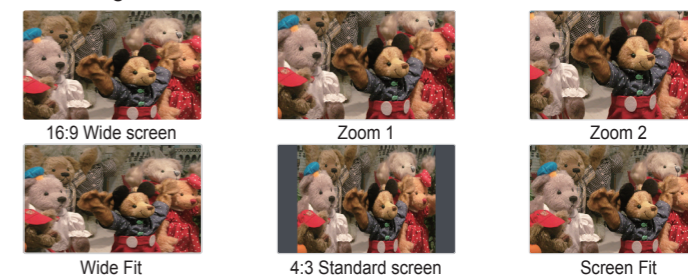

Screen Fit displays a full HD picture covering the entire screen with no cutoff on any side. It is only available when your TV inputs an HDMI (720p, 1080i, 1080p), Component (1080i, 1080p), or DTV (over-the-air 1080i) signal.

Changing the Picture Mode

Your TV has four preset Picture Modes with factory adjusted settings, each designed to give you an excellent picture under specific conditions.

The Picture Modes are listed and described in the table below:

Mode	Description
Dynamic	Brightens picture. For a vibrant, enhanced image in brightly lit or sunny room.
Standard	For a bright, detailed picture in a normally lit room.
Natural	For a comfortable, easy-on-the-eyes picture in a normally lit room.
Movie	For a studio quality cinema picture in a dimly lit or dark room.

To change the Picture Mode, follow these steps:

- With the TV on, press the TOOLS button on your remote. The **Tools** menu appears.
- Using the ▲ or ▼ on your remote, select **Picture mode**.
- On the **Picture Mode** menu, use the ◀ or ▶ on your remote to select the **Picture Mode** you want.
- Press the EXIT button to exit the menu.

Remote Control Buttons and Functions:

This is a special remote control for the visually impaired persons and has Braille points on the Power, Channel, Volume buttons.

Turns the TV on and off.

Turns the remote control light on and off. When on, the buttons become illuminated for a moment when pressed. (Using the remote control with this button set to off will reduce the battery usage time.)

Press to switch between the sources (Blu-ray player, cable box, DVD player, etc.) connected to your TV.

Press number buttons for direct access to channels.

Press to select additional digital channels broadcast by the same station. For example, to select channel 54-3, press 54, press -, and then press 3.

Return to the previous channel.

Cuts off the sound temporarily.

Adjusts the volume.

Change channels.

If your TV is attached to a cable or satellite box, you change the channel using the box's remote.

Displays the channel list on the screen.

Displays the main on-screen menu.

Displays the Content View, which includes **Channel List**, **Internet@TV**, **Media Play**, **AllShare** and **3D**.

Link to various internet services.

Quickly selects frequently used functions.

Press to display information on the TV screen.

Selects the on-screen menu items and changes the values seen on the menu.

Exits the menu.

Return to the previous menu.

Colored buttons for use in the **Channel List**, **Internet@TV**, **Media Play** menu, etc.

MEDIA.P: Views **Media Play**.

YAHOO!: Runs Yahoo widget!

3D(): Sets the **3D** mode.

FAV.CH: Displays Favorite Channel Lists on the screen.

P.SIZE: Choose the picture size.

CC: Controls the caption decoder.

Use these buttons in the **Media Play** and **Anynet+** modes.

(): Controls recording on Samsung recorders with the Anynet+ feature)

Selecting a Source

To watch a movie on your Blu-ray player or watch your favorite TV show, you must select the correct source. A source is a device, such as a Blu-ray/DVD player, a cable/satellite box, antenna or a cable TV input. Sources can be connected to your TV through the HDMI, DVI, Component, Composite, or D-sub connections, or through the Antenna or Cable In connections.

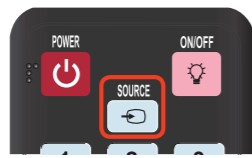

To view the signal from a source connected to the HDMI, DVI, Component, Composite, or D-sub jack, press the SOURCE button on your remote. Each time you press the SOURCE button, you change to a different source.

Viewing the On Screen Menus

To view the On Screen Menus, follow these steps:

- With the power on, press the MENU button on your remote. The main menu appears. The menu's left side has the following menu options: **Picture**, **Sound**, **Channel**, **Setup**, **Input**, **Application**, and **Support**.
- Press the ▲ or ▼ button on your remote to select a menu option, and then press the ENTER button.
- When done using the menu, press the EXIT button on your remote to exit.

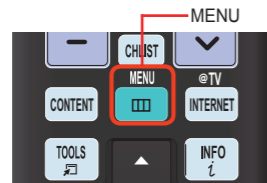

Changing Channels and Adjusting the Volume

You can change the channel and adjust the volume by using the CH and VOL buttons on the remote. You can also change the channels by pressing the CH buttons on the front panel of your TV and adjust the volume by pressing the VOL buttons.

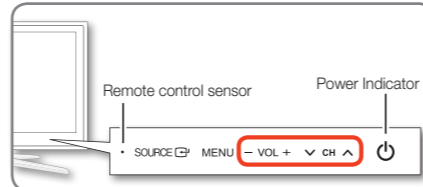

Setting the Clock

Before you can use your TV's On/Off Timer, you must set the clock. To set the clock, follow these steps:

- Turn on your TV.
- Using your remote, press the MENU button on your remote. Then, select **Setup** → **Time**.
- Select **Clock Mode**, and then press the ENTER button. Set Clock Mode to Manual.
 - Select Auto if you have a digital channel in your area and are not using a cable/sat box.
- Select **Clock Set**, and then press the ENTER button. The Clock Set screen appears.
- Using the number buttons on your remote, enter the **Month**, **Day**, **Year**, **Hour**, and **Minute**. Use the ◀ or ▶ button to move between entry fields.
- Press the RETURN button on your remote when done.

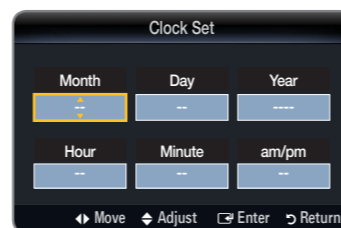

Connecting a USB Device for Media Play

You can enjoy photo, music, and movie files stored on a USB device by connecting it to the TV and using the Media Play feature. To connect a USB device for Media Play, follow these steps:

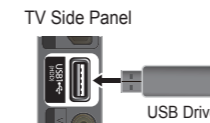

- Turn on your TV.
- Connect a USB device containing photo, music and/or movie files to the USB1 (HDD) or USB2 jack on the side of the TV.
- When the **Application selection** screen appears, press the ENTER button on your remote to select **Media Play** (USB).



Connecting to a Local Area Network

To enjoy watching streaming content from online providers such as YouTube and Blockbuster, you must follow the steps below to connect the TV to your network.

Network Connection - Wired

There are two main ways to connect your TV to your network using cable, depending on your network setup. They are illustrated below:

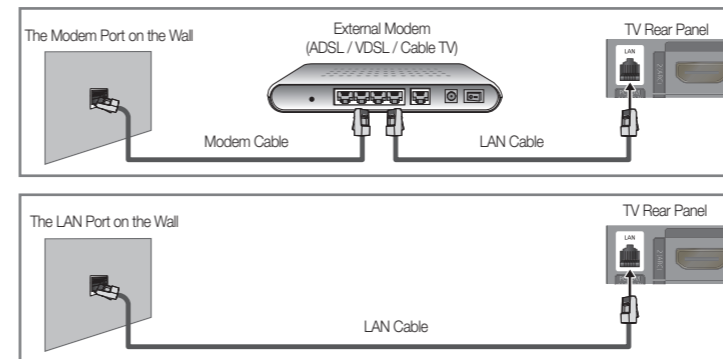

Configuring the Network Connection - Wired

Most home networks use the Dynamic Host Configuration Protocol (DHCP) to configure network connections. Home networks that support DHCP automatically provide the IP address, subnet mask, gateway, and DNS values your TV needs to access the Internet so you don't have to enter them manually.

To configure your network connection for a network that uses DHCP, follow these steps:

- Connect your TV to your network as shown in one of the illustrations above.
- Turn on your TV, press the MENU button on your remote, and then select **Setup** → **Network**.
- Set the **Network Type** to **Wired** if it is not already set to **Wired**.
- Select **Network Setup**. The **Network Setup** screen appears.
- On the **Network Setup** menu, set **Internet Protocol Setup** and **DNS** to **Auto**. Auto acquires and enters the necessary internet values automatically.
- Select **Network Test** to check Internet connectivity.
 - Some networks are Static IP networks. If your network is a Static IP network, you can not use DHCP to configure the network connection. Instead, you must enter the **IP Address**, **Subnet Mask**, **Gateway**, and **DNS Server** manually. For instructions explaining how to configure a Static IP network, see your user's manual.

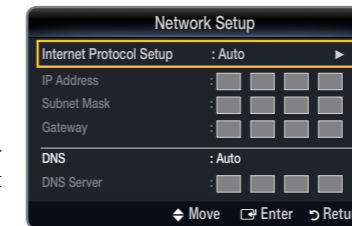

Network Connection - Wireless

You can connect your TV to your LAN through a standard wireless router or modem. To connect wirelessly, you must first attach a Samsung Wireless LAN Adapter (WIS09ABGN, WIS09ABGN2, WIS10ABGN - sold separately) to either the USB1 (HDD) or USB2 port on the back of your TV. See the illustration below.

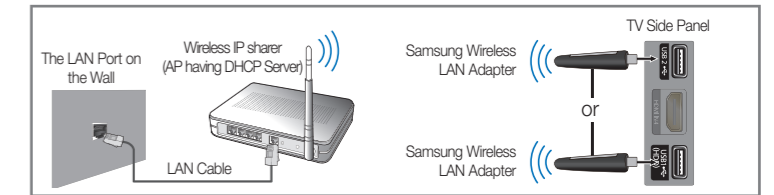

Samsung's Wireless LAN adapter supports the IEEE 802.11A, IEEE 802.11B, IEEE 802.11G, and IEEE 802.11N wireless communication protocols. For your TV to connect to your network, the wireless router or modem you use must also support one of these protocols. The fastest of these protocols is IEEE 802.11N.

Most wireless network systems incorporate a security system that requires devices that access the network through an access point or AP (typically a wireless modem or router) to transmit an encrypted security code called an access key.

For regular connections, your TV is compatible with the following security protocols:

- Authentication Mode: OPEN, SHARED, WPAPSK, WPA2PSK
- Encryption Type: WEP, TKIP, AES

Configuring the Network Connection - Wireless

The instructions below are for networks that use the Dynamic Host Configuration Protocol (DHCP) to configure network connections automatically. If you have a Static IP network, see your user's manual for configuration instructions.

To configure your network connection for a network that uses DHCP, follow these steps:

- Connect your TV to your network as shown in the illustrations above.
- Turn on your TV, press the MENU button on your remote, and the select **Setup** → **Network**.
- Set the **Network Type** to **Wireless** if it is not already set to **Wireless**.
- Select **Network Setup**. The **Network Setup** screen appears.
- On the **Network Setup** menu, select an AP (Access Point) and ad hoc network. If you have selected network with a security key, the **Security Key** screen appears.
- Enter the **Security Key** using the numbers on the remote, and then press the Blue button on your remote.
 - If your network uses WEP security encryption, 0-9 and A-F will be available on the **Security Key** screen. Use the Direction button on your remote to move to the characters and the enter key to select them.
- On the **Network Setup** menu, set **Internet Protocol Setup** and **DNS** to **Auto**. The **Auto** acquires and enters the necessary internet values automatically.
- Select **Network Test** to check internet connectivity.
 - For more information, see your user's manual.

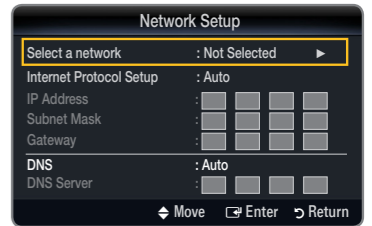

Starting Internet@TV

To view the On Screen Menus, follow these steps:

- Turn on your TV, press the MENU button on your remote, then select **Application** → **Content View**.
- Press the ◀ or ▶ button to select **Internet@TV**, and the ENTER button. The USER TERMS and PRIVACY POLICY windows appears, then select **Yes**.
- Follow the directions on your screen to set up **Internet@TV**. For detailed instructions, see your Owner's Manual.
 - For best **Internet@TV** results, your broadband company should provide sustained download speeds of 3.5 mb/sec or more.



BN68-02617A-02

Free Manuals Download Website

<http://myh66.com>

<http://usermanuals.us>

<http://www.somanuals.com>

<http://www.4manuals.cc>

<http://www.manual-lib.com>

<http://www.404manual.com>

<http://www.luxmanual.com>

<http://aubethermostatmanual.com>

Golf course search by state

<http://golfingnear.com>

Email search by domain

<http://emailbydomain.com>

Auto manuals search

<http://auto.somanuals.com>

TV manuals search

<http://tv.somanuals.com>