

About this manual

Before installing and using the camera, please read this manual carefully. Be sure to keep it handy for later reference.



SALES NETWORK

· SAMSUNG TECHWIN CO., LTD.

Optics & Digital Imaging Division 145-3, Sangdaewon 1-Dong,
Jungwon-Gu, Sungnam, Kyungki-Do, Korea 462-703

TEL: 82-31-740-8137-41 FAX: 82-31-740-8145

· SAMSUNG OPTO-ELECTRONICS UK LTD (SOUK)

Samsung House, 1000 Hillswood Drive Hillswood Business
Park Chertsey Surrey KT16 0PS

TEL: 44-(0)1932-45-5308 FAX: 44-(0)1932-45-5325

www.samsungtechwin.com
www.samsungcctv.com

· SAMSUNG OPTO-ELECTRONICS AMERICA, INC. (SOA)

Closed Circuit Division 40 Seaview Drive, Secaucus NJ 07094,
U.S.A

TEL: (201) 902-0347 FAX: (201) 902-0429

· TIANJIN SAMSUNG OPTO-ELECTRONICS CO., LTD (TSOE)

7 Pingchang Rd, Nankai Dist, Tianjin, P.R China
Post Code : 300190

TEL: 86-22-2761-9698 FAX: 86-22-2761-6514

P/No. : 6806-0458-01B

Ver. 04.10

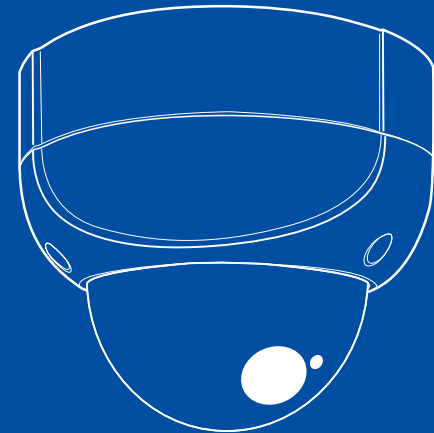

Thank you for purchasing a **SAMSUNG CCTV CAMERA**. Before operating the camera, confirm the camera model and proper input power voltage. In order that you can understand this manual thoroughly, we'll introduce our model description.

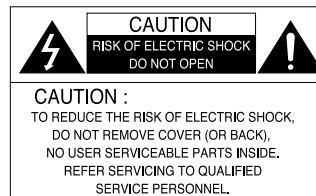

■ SVD-4120A Series (410,000 pixels)

- NTSC models
SVD-4120AN
SVD-4120AWN
- PAL models
SVD-4120AP
SVD-4120AWP

■ Model Description

SVD-4120A X X

Signal system
Lens Type

• Lens Type

- Blank → 2.5X, f=3.8~9.5 Vari-Focal Lens
- W → 2.4X, f=2.5~6.0 Vari-Focal Lens

• Signal System

- N → NTSC Model
- P → PAL Model



The lightning flash with an arrowhead symbol, within an equilateral triangle is intended to alert the user to the presence of uninsulated "dangerous voltage" within the product's enclosure that may be of sufficient magnitude to constitute a risk of electric shock to persons.



The exclamation point within an equilateral triangle is intended to alert the user to the presence of important operating and maintenance (servicing) instructions in the literature accompanying the appliance.

INFORMATION - This equipment has been tested and found to comply with limits for a Class A digital device, pursuant to part 15 of the FCC Rules. These limits are designed to provide reasonable protection against harmful interference when the equipment is operated in a commercial environment. This equipment generates, uses, and can radiate radio frequency energy and, if not installed and used in accordance with the instruction manual, may cause harmful interference to radio communications.

Operation of this equipment in a residential area is likely to cause harmful interference in which case the user will be required to correct the interference at his own expense.

WARNING - Changes or modifications not expressly approved by the manufacturer could void the user's authority to operate the equipment.

CAUTION : To prevent electric shock and risk of fire hazards:

- ◆ Do NOT use power sources other than that specified.
- ◆ Do NOT expose this appliance to rain or moisture.

This installation should be made by a qualified service person and should conform to all local codes.

Features

Fine Picture Condition Under Very Low Illumination (SENSE UP)

1/3 high density CCD and digital processor permit high quality pictures to be captured in very low light condition.

High Resolution

The horizontal resolution of 500TV lines can be achieved by using a high density CCD having Double Speed 410,000 pixels SONY CCD, which provides clean, noiseless and reliable pictures.

Auto Iris Vari-Focal Lens Built In

The focal length of lens is 3.8 to 9.5 mm, equivalent to 2.5x zoom.(2.5 to 6.0mm, equivalent to 2.4x zoom/SVD-4120AW) The built-in lens allows the camera to have a Wider Dynamic Range, therefore you can use in various applications.

Wide Range ATW

The White Balance can be automatically adjusted in response to light condition so that you can observe in an appropriate color balance.

IP66 Approved / Dust and Rain Resistant

With dust and rain resistant design, the camera can be installed outside under building eaves or places that are exposed to the dust and rain.

SSNR(Samsung Super Noise Reduction) CHIP

SVD-4120A/AW has an assistant DSP chip that can remove image noise efficiently and it shows clean and obvious image in low luminance

Electronic DAY/NIGHT

In normal or high luminance, camera maintains color mode. On the contrary, it get changed into B/W mode in low luminance.

Warning

The camera needs periodic inspection.

Contact an authorized technician for inspection.

Stop using your camera when you find a malfunction.

If you use your camera around smoke or unusual heat for a long time, a fire may be caused.

Do not install the camera on a surface that can not support it.

Unless the surface is suitable, it could cause falling or other hazards.

Do not hold plug with wet hands.

It could cause an electric shock.

Do not disassemble the camera.

It may result in fire, electric shock or other hazards.

Do not use the camera close to a gas or oil leak.

It may result in fire or other hazards.

Contents

Precautions	8	■ Setting Up The Menu	16
Composition	10	• CAMERA ID	17
Name and Function of Each Section	11	• BACKLIGHT	20
Connection	13	• WHITE BALANCE	21
■ Connecting to Monitor	13	• MOTION DETECTION	22
■ Connecting to Power	14	• IRIS LEVEL CONTROL	25
Operating Your Camera	15	• SHUTTER SPEED CONTROL	26
■ Configuration of The Menu	15	• SESE UP	27
		• GAIN	28
		• SSNR	28
		• SPECIAL	30
		Troubleshooting	32
		Dimention	34
		Specifications	35

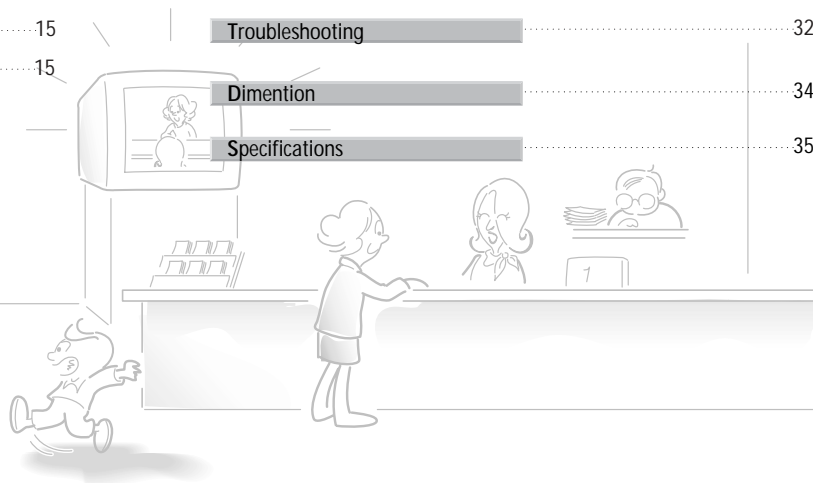

Precautions

Do not install the camera in extreme temperature conditions.



Only use the camera under conditions where temperatures are between -10°C and $+50^{\circ}\text{C}$. Be especially careful to provide ventilation when operating under high temperatures.

Do not install or use the camera in an environment where the humidity is high.



It can cause the image quality to be poor.

Do not drop the camera or subject them to physical shocks.



It can cause malfunctions to occur.

Never keep the camera face to strong light directly.



It can damage the CCD.

Do not install the camera under unstable lighting conditions.



Severe lighting change or flicker can cause the camera to work improperly.

Do not touch the front lens of the camera.



It is one of the most important parts of the camera. Be careful not to be stained by fingerprint.

Do not expose the camera to radioactivity.

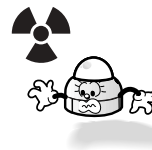

If it is exposed to radioactivity, For heated CCD, it will be out of order.



Notes

- If the camera is exposed to spotlight or object reflecting strong light, smear or blooming may occur.
- Please check that the power satisfies the normal specification before connecting the camera.

Composition

1. SVD-4120A/AW

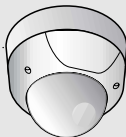

2. Instruction Manual



3. Quick Install Guide



4. Wrench



5. Ø5 Tapping Screws 4EA



6. Template



7. Video Output Cable for installer



Name and Function of Each Section

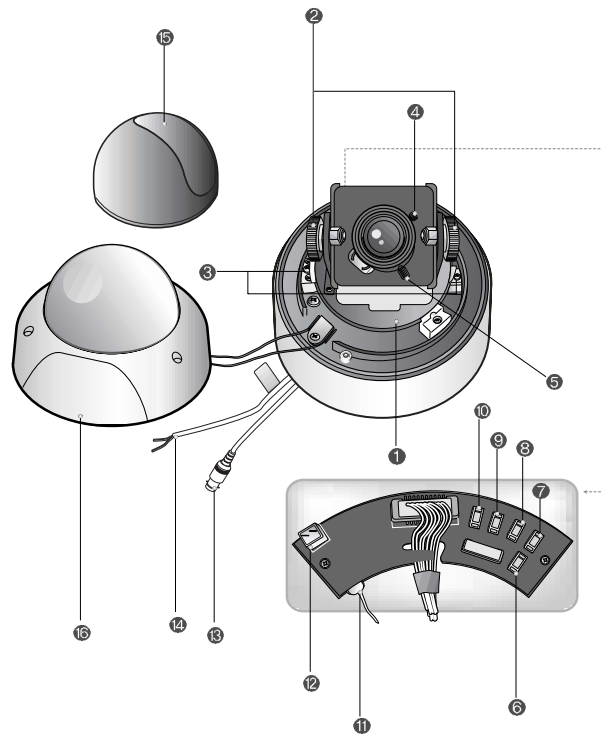

Name and Function of Each Section

- 1 **Pan Base**
control panning angle of camera
- 2 **Tilt Base Holding Screws**
fix tilted position.
- 3 **Pan Base Holding Screws** (Color : Silver)
fix panned position
- 4 **Zoom Handle**
adjust zoom between WIDE and TELE
- 5 **Focus Handle**
after adjusting zoom, adjust focus
- 6 **SET Button**
confirm the status of the selected feature
- 7 **RIGHT Button**
move cursor to the right, change the status of the selected feature
- 8 **DOWN Button**
move cursor to the down, select the desired feature item
- 9 **UP Button**
move cursor to the up, select the desired feature item
- 10 **LEFT Button**
move cursor to the left, change the status of the selected feature
- 11 **Video Output Terminal**
- 12 **Video Output Terminal to Monitor**
- 13 **Video Output Jack**
- 14 **Power Input Jack**
- 15 **Shield Case**
- 16 **Dome Cover**

Connection

■ Connecting to Monitor

Connect the VIDEO-OUT jack to the VIDEO-IN jack of monitor.

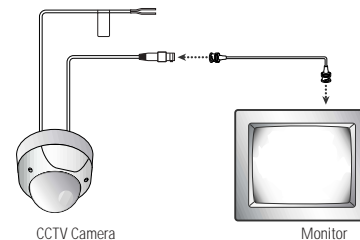

- As the connecting method varies with the instruments, refer to the manual supplied with the instrument.
- If necessary, you can connect the monitor to the REMOTE jack on the back of your camera.
- Only connect the cable when the power is turned off.
- Set the 75Ω / Hi-Z selection switch as shown below if you have an intermediate device.

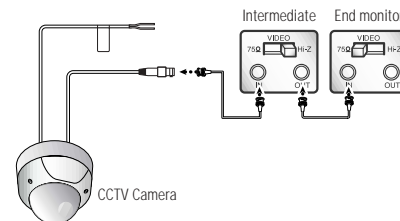

■ Connecting to Power

- Use AC 24V / 300mA or DC 12V / 500mA power source.

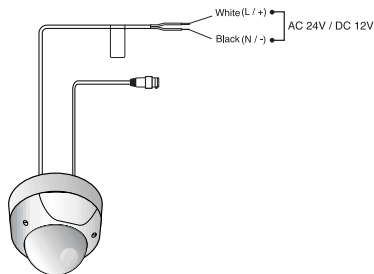

For DC Power Type

- For DC power as the voltage drop according to the length of the cable in the above table, a camera may malfunction if there is an excessively long cable run.

Resistance of copper wire [at 20°C (68°F)]

Copper wire size (AWG)	#24 (0.22mm ²)	#22 (0.33mm ²)	#20 (0.52mm ²)	#18 (0.83mm ²)
Resistance (Ω / m)	0.078	0.050	0.030	0.018
Voltage Drop (V/m)	0.028	0.018	0.011	0.006

* Voltage for camera operation: 12V DC ±10%

* Voltage drops in the above table are variable according to types of cable manufacturer.



Notes

- Be sure to connect power only after all the installation is complete.
- Note that AC or DC adaptor is not supplied with camera.
- Use the UL listed, class 2 power transformer of AC 24V adaptor.
- Ground should be connected to the GND terminal.

■ Configuration of The Menu

SETUP MENU	CAMERA ID (see page 17)
	• OFF • ON
	BACKLIGHT (see page 20)
	• WDR • BLC • OFF
	WHITE BAL. (see page 21)
	• W-ATW • S-ATW • AWC • MANUAL
	MOTION DET. (see page 22)
	• OFF • MD1 • MD2
	IRIS LEVEL CONTROL (see page 25)
	• LEVEL
	SHUTTER (see page 26)
	• OFF • 1/100 (1/120) • MANUAL
	SENSE UP (see page 27)
	• Auto • OFF
	GAIN (see page 28)
	• OFF • AGC-L • AGC-H
	SSNR (see page 28)
	• OFF • LOW • MIDDLE • HIGH
	SPECIAL (see page 30)
	• COLOR • SYNC • PRIVACY • RESET
	• END • EXIT
	EXIT

Operating Your Camera

■ Setting Up The Menu

Use the five SETUP MENU buttons on back of the camera.

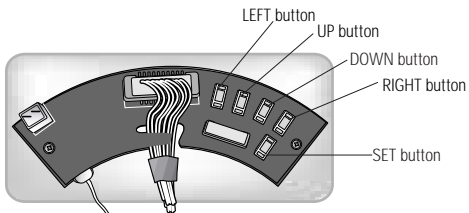

1. Press the SET button to access the SETUP mode.
 - SETUP menu is displayed on the monitor screen.

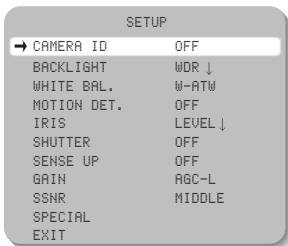

2. Select the desired feature using the UP or DOWN button.
 - Each time you press the UP or DOWN button, the arrow indicator moves up or down.
 - Move the arrow indicator to the desired feature item.

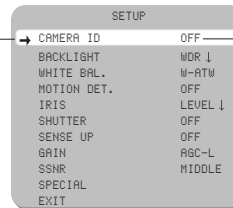

Select the function using the UP or DOWN button.

Change the status using the LEFT or RIGHT button.

3. Change the status of the selected feature using the LEFT or RIGHT button.
4. When completed, move the arrow indicator to 'EXIT' and press the SET button.



Notes

- For the mode with ↓ you can access submenu.
- You can access submenu using SET button.

CAMERA ID

If you enter a CAMERA ID, the name will be displayed in the screen monitor.

1. Press the SET button to display the SETUP menu and move the arrow indicator to 'CAMERA ID' using the UP or DOWN button.
2. Set 'CAMERA ID' to 'ON' using the LEFT or RIGHT button.



Notes

- If the CAMERA ID feature is set to 'OFF', the name will not be displayed in the monitor.

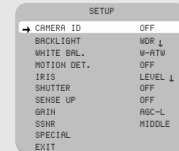

Operating Your Camera

3. Press SET button.

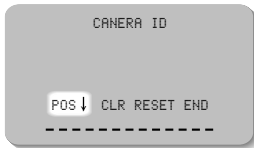

4. You can enter up to 16 characters.

- ① Move the cursor to character-enter location by using the LEFT or RIGHT button.
- ② Select the desired character by using UP or DOWN button.
 - The factory default characters are A, B, ..., a, b, ..., 0, 1..., 8, 9

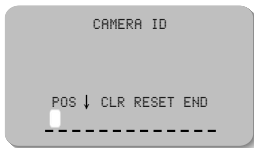

- ③ Press the SET button to confirm the blinking character. The first character is saved and the cursor in the bottom of the screen moves to the next position.
- ④ Repeats steps ①, ② and ③ until you create the full name you want.



Notes

• **If you make a mistake while entering name**

Move the cursor to 'CLR', press 'SET' button.

After erasing the character from right to left, correct the character again.

5. Select the position at which the CAMERA ID will be located on the screen.

- ① Move the cursor to 'POS' and press SET button.

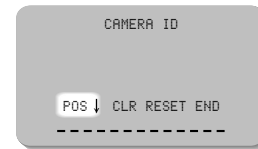

- ② The CAMERA ID is displayed on the bottom-left of the monitor screen. (Default position)

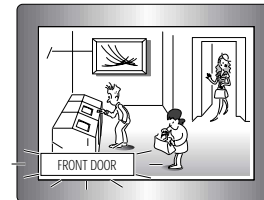

- ③ Select the position by using the 4-directional buttons, then press the SET button to confirm the position.



6. When completed, move the cursor to 'END' and press SET button.

Operating Your Camera

BACKLIGHT

SV-II DSP chip built-in provides intelligent light level control to overcome the severe Backlight conditions.

1. Press the SET button to display the SETUP menu and move the arrow indicator to 'BACKLIGHT' using the UP or DOWN button.

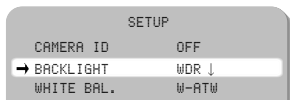

2. SET 'BACKLIGHT' to the desired mode using the LEFT or RIGHT button.

- WDR: In case that bright and dark parts exist on the screen at the same time, your camera allows you to see both parts clearly
- BLC: When the image is in front of strong background lighting, your camera allows you to get the clear image
- OFF: Deactivation

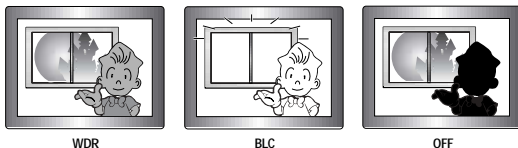

3. Press the 'SET' button.

- When 'WDR' is chosen, you can adjust the level.

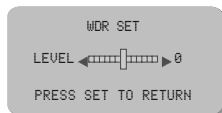

You can select the level from -4 to 4. WDR sensitivity is increased or decreased.

4. When completed, press the SET button.



Notes

- If you select WDR mode, the following phenomenon may appear by lighting condition. In these cases do not select WDR mode.
 - ① Unnatural color change or unnatural phenomenon on the screen
 - ② Noise of bright part on the screen
- According to the area of bright part on the screen there may be the difference of WDR performance so be sure to adjust the degrees of the visual angle when installing your camera.
- If you increase WDR level, unnatural phenomenon may appear.

WHITE BALANCE CONTROL

Your camera provides 4 'WHITE BAL.' control modes. You can select the most suitable one. You can adjust the white balance.

1. Press the SET button to display the SETUP menu and move the arrow indicator to 'WHITE BALANCE' using the UP or DOWN button.
2. Set 'WHITE BAL.' to the desired mode using LEFT or RIGHT button.

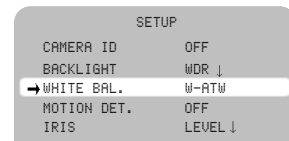

The six WHITE BALANCE control modes are as follows :

- W-ATW(Wide Auto Tracking White balance):
When color temperature is 2400~12000K, select this mode. (EX. a fluorescent lamp, outdoor)

Operating Your Camera

- ❶ **S-ATW(Special Auto Tracking White balance):** When color temperature is 1800–6000K, specially in sodium lamp, select this mode. (EX. sodium lamp, inside the tunnel)
- ❷ **AWC(Auto White balance Control):** The white balance is automatically adjusted in a specific environment. In order to obtain the best result, press the SET button while the camera focuses on white paper. If the environment including the light source is changed, you have to adjust the white balance again.
- ❸ **MANUAL :** To fine adjust, select the Manual mode. You can increase or decrease the red or blue factor while monitoring the difference on the screen. Set to 'MANUAL' mode and press the SET button. Increase or decrease the value for RED(R-Gain) and BLUE(B-Gain), watching the color of the picture, and press the SET button when you obtain the best color.

Notes

- Proper White Balance may not be obtained under the following conditions, in these cases select the AWC mode.
 - ❶ When the scene contains mostly high color temperature object, such as a blue sky or sunset.
 - ❷ When the scene is dim.
 - ❸ If your camera faces fluorescent lamp directly or is installed in the place of the changing illumination.

MOTION DETECTION

Whenever your camera detects motion of object displaying 'MOTION DETECTED' with the number counted up on the screen.

1. Press the SET button to display the SETUP menu and move the arrow indicator to 'MOTION DET.' using the UP or DOWN button.

2. Set 'MOTION DET.' to the desired mode using LEFT or RIGHT button.

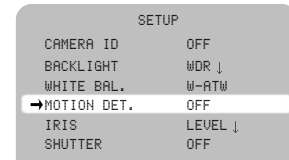

- ❶ **MD1:** Your camera detects the object's motion by outline or difference of a color tone, so this mode is very useful for the daytime or observing small moving object.

- ❶ Press SET button.



- ❷ Move the arrow indicator to 'AREA SET' using UP and DOWN button, and then press the SET button.
- ❸ Set the areas you want to observe.

- You can adjust the top, bottom, left and right base lines by 13 steps from top to bottom, 18 steps from left to right with an increment of 1.

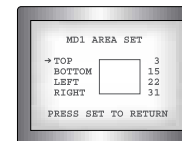

Operating Your Camera

- Move the arrow indicator to 'TOP' using the UP or DOWN button and increase or decrease the value using the LEFT or RIGHT button. Repeat the procedure for bottom, left and right.

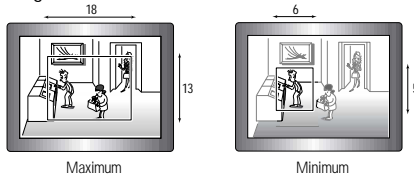

- When completed, press SET button.
 - ➊ MD2: Your camera detects object's motion by the variation of brightness, so this mode is very useful for night or observing large moving object. Also MD2 enables you to set separated areas.
 - ➀ Press SET button.
 - ➁ Move the arrow indicator to 'AREA SET' like MD1.
 - ➂ Set the areas you want to observe of the 48 areas.

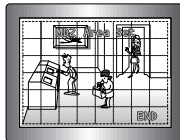

- Move the cursor to the area you want to observe, and then press the SET button.
- After setting, move the cursor to edge in any direction and then press the button just one more, let 'END' blink.
- Press the SET button.



Notes

- If you set some areas of 48 areas, your camera detects the object's motion within the areas you set.

Tips on Using the Motion Detection Feature

- As you increase or decrease MD LEVEL, the areas' sensitivity is increased or decreased for object.
- After selecting zone and sensitivity, perform a test operation to make sure it works properly.
- If the lighting flickers, the motion detection feature might not work properly.
- The object should occupy 10% or more of its zone. The bigger the object, the higher sensitivity.
- If the brightness of an object changes rapidly by sudden lighting change, the camera may detect it as a motion.
- Your camera can count up to 999. If you reset your camera with selecting 'RESET' in SPECIAL menu or turn it off and on, your camera'll count up from 0.
- When this feature is activated, another algorithm may take more time to be operated.
- This system does not guarantee prevention of fires or thefts. The manufacturer is not responsible for any accident or damage.

IRIS LEVEL CONTROL

You can control the brightness of the screen.

- Press the SET button to display the setup menu and move the arrow indicator to 'IRIS' using the UP or DOWN button and press SET button.
- Set 'LEVEL' to the desired brightness using LEFT or RIGHT button.

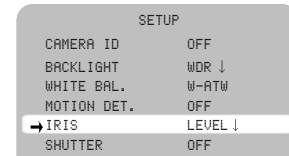

- When completed move the arrow indicator to 'END' and press the SET button.

Operating Your Camera

SHUTTER SPEED CONTROL

You can control brightness of the screen by the shutter speed.

1. Press the SET button to display the setup menu and move the arrow indicator to 'SHUTTER' using the UP or DOWN button.
2. Set 'SHUTTER' to the desired mode using the LEFT or RIGHT button.
 - ☉OFF: Deactivation
 - ☉1/100(1/120: PAL Models): Flickerless mode (When WDR is on, the image can flicker a little)
 - ☉MANUAL: When setting shutter speed manually

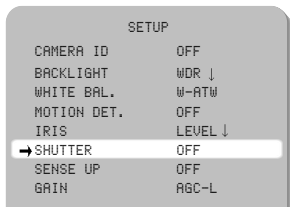

3. If you choose 'MANUAL', select the optimal shutter speed.
 - You can select speed from '1/60' to '1/200,000'sec (NTSC Models), '1/50' to '1/200,000'sec (PAL Models).
 - When the shutter speed is increased or decreased using the LEFT or RIGHT button, you can find the difference by monitoring the brightness of the screen.

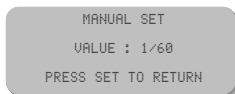

NTSC Models

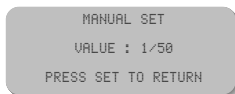

PAL Models

4. When completed, press the SET button.



Notes

- For effective 1/100(1/120) mode set WDR mode in BACKLIGHT menu to OFF. 1/100(1/120) mode is not effective with WDR mode.
- If you choose MANUAL mode, you can't use WDR mode in 'BACKLIGHT' menu.
- If you select MANUAL mode, SENSE UP is not operated.

SENSE UP

You can always get the clear image with this function under night or low-lighting level.

1. Press the SET button to display the setup menu and move the arrow indicator to 'SENSE UP' using the UP or DOWN button.
2. Set 'SENSE UP' to the desired mode using the LEFT or RIGHT button.
 - ☉AUTO: When your camera is under night or low-lighting level, select this mode.
 - ☉OFF: Deactivation

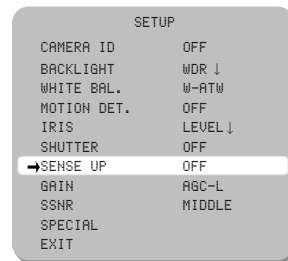

Operating Your Camera

GAIN

To get brighter picture.

1. Press the SET button to display the setup menu and move the arrow indicator to 'GAIN' using the UP or DOWN button.

2. Set 'gain' to desired mode using the LEFT or RIGHT mode.

- ☉ **AGC-H:** Gain is increased or decreased from 0 to 30dB automatically as following the illumination.
- ☉ **AGC-L:** Gain is increased or decreased from 0 to 27dB automatically as following the illumination.
- ☉ **OFF:** Deactivation

SETUP	
CAMERA ID	OFF
BACKLIGHT	WDR ↓
WHITE BAL.	W-RTW
MOTION DET.	OFF
IRIS	LEVEL ↓
SHUTTER	OFF
SENSE UP	OFF
→ GAIN	AGC-L
SSHR	MIDDLE
SPECIAL	
EXIT	

SETUP	
CAMERA ID	OFF
BACKLIGHT	WDR ↓
WHITE BAL.	W-RTW
MOTION DET.	OFF
IRIS	LEVEL ↓
SHUTTER	OFF
SENSE UP	OFF
GAIN	AGC-L
→ SSHR	MIDDLE
SPECIAL	
EXIT	



Notes

- If you change the 'GAIN' menu from AGC-L to AGC-H, sensitivity is increased as well as noise on the screen.
- Afterimage may appear with SSNR.

SSNR (Samsung Super Noise Reduction)

To reduce the noise on the screen.

1. Press the SET button to display the setup menu and move the arrow indicator to 'SSNR' using the UP or DOWN button.

2. Set 'SSNR' to desired mode using the LEFT or RIGHT mode.

- ☉ **LOW:** low reduction of the noise

Operating Your Camera

SPECIAL

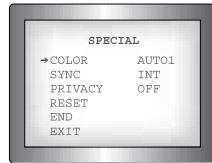

1. Press the SET button to display the setup menu and move the arrow indicator to 'SPECIAL' using the UP or DOWN button.

2. Press the SET button.

☉ **COLOR** : choose color or B/W mode

- ON : color mode
- OFF : B/W mode
- AUTO1 : generally color mode, B/W mode in low luminance.
- AUTO2 : AUTO2 is identical with AUTO1 under SENSE UP : AUTO condition.

☉ **SYNC** : Two SYNCHRONIZATION modes are available INTERNAL and EXTERNAL LINE-LOCK. In LINE-LOCK mode, it synchronizes the video signal between cameras without a synchronous generator. The line-lock synchronization is only used in the areas of 60Hz (NTSC Models) / 50Hz (PAL Models).

- INT : Internal synchronization
- OFF : External line-lock synchronization

- If you choose 'L/L', you can adjust the desired phase. Press the SET button.

- You can adjust the desired phase from 0 to 270.

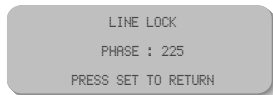

Notes

- When the power frequency is 50Hz, you can not use line-lock mode(NTSC Models).
- When the power frequency is 60Hz, you can not use the line-lock mode(PAL Models).
- 'Sync.' mode is fixed to 'INT' in DC 12V input power.

☉ **PRIVACY**: To mask area which you want to mask

- OFF: Deactivation
- ON: Privacy mode activated
- Press the SET button.



- Move the arrow indicator to area you want to mask.
- Set 'ON' using LEFT or RIGHT button.
- Press the SET button and then set the area's bounds with the method like MD1 Set. (see page 23)
- When completed, press the SET button.

☉ **RESET**: To reset your camera to factory default condition

☉ **END**: To move Top-menu

☉ **EXIT**: To finish setting menu

Troubleshooting

If you have trouble operating your camera, refer to the following table. If the guidelines do not enable you to solve the problem, contact an authorized technician.

Problem	Solution
Nothing appears on the screen.	<ul style="list-style-type: none"> • Check that the power cord and line connection between the camera and monitor are fixed properly. • Check that you have properly connected VIDEO cable to the camera VIDEO output jack.
The image on the screen is dim.	<ul style="list-style-type: none"> • Is lens stained with dirt? Clean your lens with soft, clean cloth. • Set the monitor to proper condition. • If the camera is exposed to too strong light, change the camera position. • Adjust the lens' focus properly.
The image on the screen is dark.	<ul style="list-style-type: none"> • Adjust the contrast feature of the monitor. • If you have an intermediate device, set the 75Ω / Hi-z properly. (refer to page 13)
The camera is not working properly, and the surface of the camera is hot.	<ul style="list-style-type: none"> • Check that you have properly connected the camera to an appropriate power source.
MOTION DETECTION function is not active.	<ul style="list-style-type: none"> • Have you set 'MOTION DET.' menu to OFF? • Have you set 'MD LEVEL' to too low? • Have you set 'MD AREA' properly?

Problem	Solution
The color of the picture is not matched.	<ul style="list-style-type: none"> • Check that you have properly set the 'WHITE BAL.' menu. (refer to page 21)
The image on the screen flickers.	<ul style="list-style-type: none"> • Is the camera facing to direct sunlight or fluorescent lighting? Change the camera position.
L/L mode isn't able to be selected.	<ul style="list-style-type: none"> • Have you connected your camera to DC power source? Connect it to AC power source.

Dimension

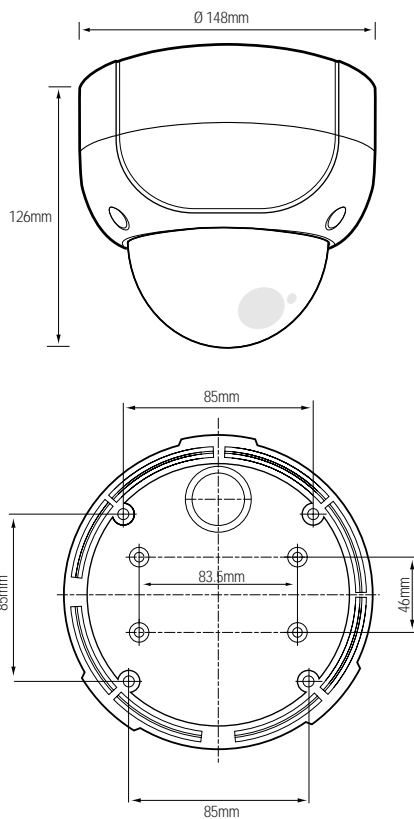

Specifications

Item	SVD-4120AN	SVD-4120AP	SVD-4120AWN	SVD-4120AWP
Power Source	DC 12V / AC 24V compatible			
Power Consumption	280m(DC) / 3.8W(AC)			
Image Sensor	1/3", Vertical double density interline CCD			
Total Pixels	811(H)x508(V), 1/3" CCD	759(H)x596(V), 1/3" CCD	811(H)x508(V), 1/3" CCD	759(H)x596(V), 1/3" CCD
Effective Pixels	768(H)x494(V), 1/3" CCD	752(H)x582(V), 1/3" CCD	768(H)x494(V), 1/3" CCD	752(H)x582(V), 1/3" CCD
LENS TYPE	2.5X Vari-Focal, f=3.8-9.5		2.4X Vari-Focal, f=2.5-6.0	
Maximum Aperture Ratio	1:1.3-2.0		1:1.3-1.9	
Angle of View	H: 74.2-30.0°, V: 54.0-22.4°, D: 96.8-37.4°		H: 108.2-47.6°, V: 80.4-35.6°, D: 136.6-59.4°	
Scanning System	2:1 Interlaced 525 Lines:60Fields/30Frames	2:1 Interlaced 625 Lines:50Fields/25Frames	2:1 Interlaced 525 Lines:60Fields/30Frames	2:1 Interlaced 625 Lines:50Fields/25Frames
Synchronization	Internal / Line Lock selectable			
Video Output	1.0V(p-p)NTSC composite, 75WBNC Connector	1.0V(p-p)PAL composite, 75WBNC Connector	1.0V(p-p)NTSC composite, 75WBNC Connector	1.0V(p-p)PAL composite, 75WBNC Connector
Resolution	500TV Lines			
Wide Dynamic Range	ON / OFF / AUTO			
Gain Control	AGC-L, AGC-H, OFF selectable			
Electric Shutter Speed	1/60-1/200,000sec	1/50-1/200,000sec	1/60-1/200,000sec	1/50-1/200,000sec
SENSE UP	Built-in(selectable limit-X128)			
IRIS MODE	DC Drive			
WHITE BALANCE	W-ATW / S-ATW / AWC / MANUAL			
Min. Illumination	0.003Lux(Sense Up) / 0.3Lux(F1.3)			
S/N(Y signal)	50dB (Weight ON)			
Motion Detection	MD1 / MD2 / OFF			
O.S.D	Built-in			
SSNR	LOW / MIDDLE / HIGH / OFF			
PRIVACY Function	ON / OFF(4 Programmable Zone)			
Operating Temperature	-10°C - +50°C (14F - 122F)			
Operating Humidity	30% - 90% RH			
Dimension(mm)	1150(W) x 130(H)			
Weight(W/O Lens & Power Cord)	1.4kg			
Angle	Panning : 340°, Tilt : 70°			

* Design and specifications are subject to change without notice

DECLARATION OF CONFORMITY

Application of Council Directive(s) 89 / 336 / EEC

Manufacturer's Name SAMSUNG TECHWIN CO., LTD

Manufacturer's Address SAMSUNG TECHWIN CO., LTD
42, SUNGJU-DONG CHANGWON-CITY,
KYUNGNAM, KOREA, 641-120

European Representative Name _____

European Representative Address _____

Equipment Type/Environment CCTV Camera

Model Name SVD-4120A/AW

Beginning Serial NO. S4100002

Year of Manufacture 2004. 1. 2

Conformance to EN 50081-1 : 1992
EMC-Directive 89/336 EEC and 92/31/EEC
EN 50130-4 : 1996

We, the undersigned, here by declare that the equipment specified above conforms to the above Directive(s).

Manufacturer	SAMSUNG TECHWIN CO., LTD	Legal Representative in Europe
Signature		Signature
Full Name	YOUNG TAEK SON	Full Name
Position	QUALITY CONTROL MANAGER	Position
Place	CHANGWON, KOREA	Place
Date	2004. 1. 2	Date

MEMO

MEMO

MEMO

Free Manuals Download Website

<http://myh66.com>

<http://usermanuals.us>

<http://www.somanuals.com>

<http://www.4manuals.cc>

<http://www.manual-lib.com>

<http://www.404manual.com>

<http://www.luxmanual.com>

<http://aubethermostatmanual.com>

Golf course search by state

<http://golfingnear.com>

Email search by domain

<http://emailbydomain.com>

Auto manuals search

<http://auto.somanuals.com>

TV manuals search

<http://tv.somanuals.com>