



DIGITAL HOME THEATER SYSTEM HT-SK6

SAMSUNG ELECTRONICS CANADA, INC.

HEADQUARTERS

7037 Financial Drive, Mississauga, Ontario, Canada L5N 6R3
TEL: 1-905-542-3535
www.samsung.ca

SERVICE DIVISION

7037 Financial Drive, Mississauga, Ontario, Canada L5N 6R3
1-800-SAMSUNG (1-800-726-7864)



Instruction Manual

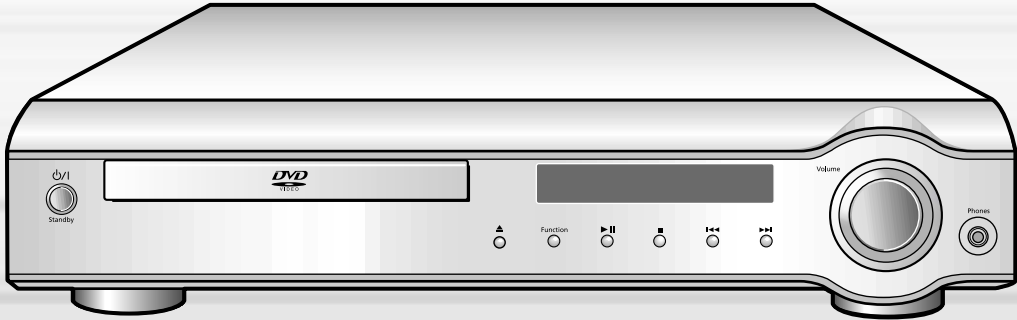

AH68-01241R



Safety Warnings

CLASS 1 LASER PRODUCT
 KLASSE 1 LASER PRODUKT
 LUOKAN 1 LASER LAITE
 KLAS 1 LASER APPARAT
 PRODUCTO LASER CLASE 1



CAUTION:
 TO REDUCE THE RISK OF ELECTRIC SHOCK, DO NOT REMOVE REAR COVER. NO USER SERVICEABLE PARTS INSIDE. REFER SERVICING TO QUALIFIED SERVICE PERSONNEL.

Note to CATV system installer :
 This reminder is provided to call the CATV system installer's attention to Section 820-40 of the NEC which provides guidelines for proper grounding and, in particular, specifies that the cable ground shall be connected to the grounding system of the building, as close to the point of cable entry as practical

CLASS 1 LASER PRODUCT

This Compact Disc player is classified as a CLASS 1 LASER product.

Use of controls, adjustments or performance of procedures other than those specified herein may result in hazardous radiation exposure.

CAUTION-INVISIBLE LASER RADIATION WHEN OPEN AND INTERLOCKS DEFEATED, AVOID EXPOSURE TO BEAM.

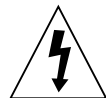

This symbol indicates that dangerous voltage which can cause electric shock is present inside this unit.



This symbol alerts you to important operating and maintenance instructions accompanying the unit.

WARNING: To reduce the risk of fire or electric shock, do not expose this appliance to rain or moisture.

CAUTION: TO PREVENT ELECTRIC SHOCK, MATCH WIDE BLADE OF PLUG TO WIDE SLOT, FULLY INSERT.

Precautions

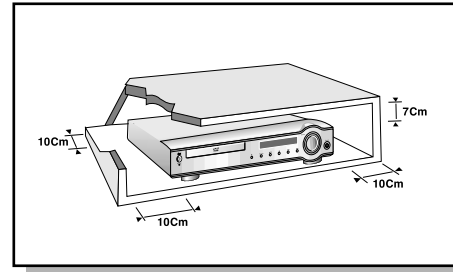

Ensure that the AC power supply in your house complies with the identification sticker located on the back of your player. Install your player horizontally, on a suitable base (furniture), with enough space around it for ventilation (3-4inches). Make sure the ventilation slots are not covered. Do not stack anything on top of the player. Do not place the player on amplifiers or other equipment which may become hot. Before moving the player, ensure the disc tray is empty. This player is designed for continuous use. Switching off the DVD player to the stand-by mode does not disconnect the electrical supply. In order to disconnect the player completely from the power supply, remove the main plug from the wall outlet, especially when left unused for a long period of time.

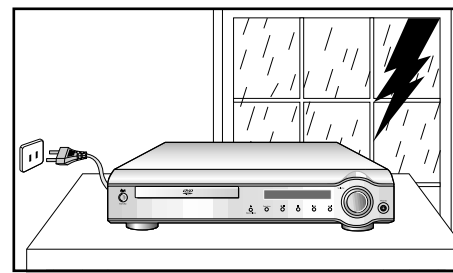
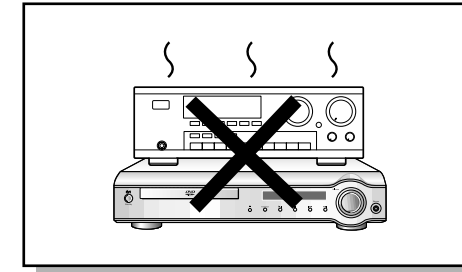

During thunderstorms, disconnect AC main plug from the wall outlet. Voltage peaks due to lightning could damage the unit.

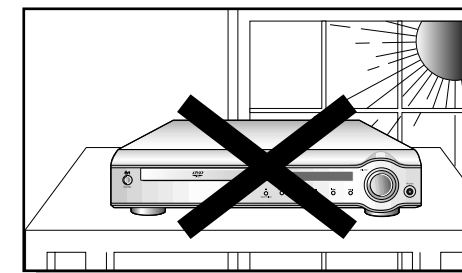

Do not expose the unit to direct sun radiation or other heat sources. This could lead to overheating and malfunction of the unit.

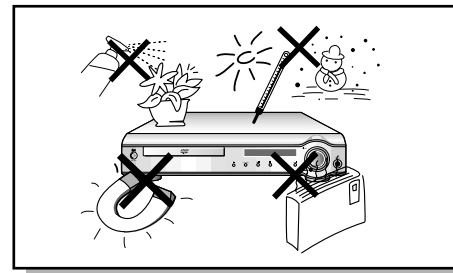

Protect the player from moisture (i.e. vases), and excess heat (e.g. fireplace) or equipment creating strong magnetic or electric fields (i.e. speakers...). Disconnect the power cable from the AC supply if the player malfunctions. Your player is not intended for industrial use.

Use of this product is for personal use only.

Condensation may occur if your player or disc have been stored in cold temperatures.

If transporting the player during the winter, wait approximately 2 hours until the unit has reached room temperature before using.

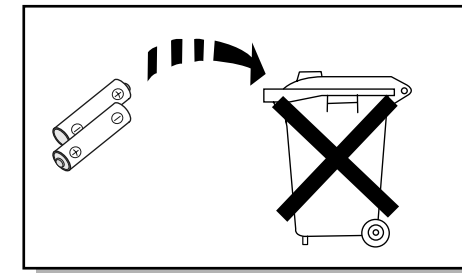

The battery used with this product contain chemicals that are harmful to the environment.

Do not dispose of batteries in the general household trash.

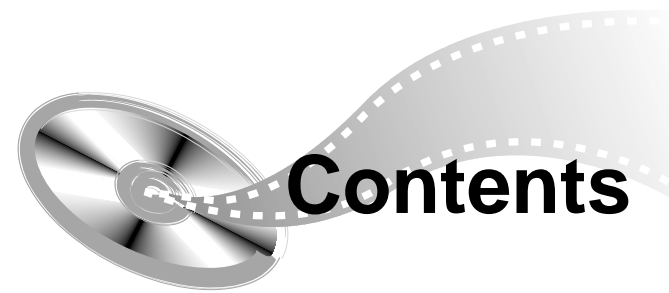

Contents



DVD (Digital Versatile Disc) offers fantastic audio and video, thanks to Dolby Digital surround sound and MPEG-2 video compression technology. Now you can enjoy these realistic effects in the home, as if you were in a movie theater or concert hall.



DVD players and the discs are coded by region. These regional codes must match in order for the disc to play. If the codes do not match, the disc will not play. The Region Number for this player is given on the rear panel of the player. (Your DVD player will only play DVDs that are labeled with identical region codes.)

Do not use the following types of disc!

- LD, CD-G, CD-I, CD-ROM and DVD-ROM cannot be played on this player. If such discs are played, a **"WRONG DISC FORMAT"** message appears on the TV screen.
- DVD discs purchased abroad may not play on this player. If such discs are played, a **"WRONG REGION CODE"** message appears on the TV screen.

Copy Protection

- Many DVD discs are encoded with copy protection. Because of this, you should only connect your DVD player directly to your TV, not to a VCR. Connecting to a VCR results in a distorted picture from copy-protected DVD discs.
- This product incorporates copyright protection technology that is protected by methods claims of certain U.S. patents and other intellectual property rights owned by Macrovision Corporation and other rights owners. Use of this copyright protection technology must be authorized by Macrovision Corporation, and is intended for home and other limited viewing uses only unless otherwise authorized by Macrovision Corporation. Reverse engineering or disassembly is prohibited.

CHAPTER 1. PREPARATION	CHAPTER 4. SETUP
<ul style="list-style-type: none"> Safety Warnings 1 Precautions 2 Description 5 Remote Control Unit 7 	<ul style="list-style-type: none"> Setting up the Language Features 30 System Setup 31 Speaker Setup 33 To set up Speaker Balance 35 Creating Realistic Sound Fields 36 Dolby Pro Logic II decoder 37 DSP(Digital Signal Processor) Modes 39 To increase Effect level 40 Adjusting DSP Sound Parameters 40
CHAPTER 2. CONNECTIONS	CHAPTER 5. RADIO OPERATION
<ul style="list-style-type: none"> Connecting the Speakers 9 Connect Video to TV 11 Connecting the FM and AM(MW) Antennas 12 AUX Connections 13 Before Using the DVD Player 14 Controlling a TV with the Remote 15 Connecting your System to the Power Supply 15 P.SCAN(Progressive Scan) Function 16 	<ul style="list-style-type: none"> Listening to the Radio 41 Presetting stations 42
CHAPTER 3. OPERATION	CHAPTER 6. MISCELLANENOUS
<ul style="list-style-type: none"> DVD Playback 17 MP3-CD Playback 19 Forward/Reverse Searching 21 Slow Playback/Checking the Remaining Time 22 Repeat Playback 23 Using Disc Menu/Title 24 Selecting the Audio Language/Subtitle Language 25 Zoom/Angle Functions 26 Program Playback 27 Sleep/D.R.C Function 29 Listening on headphones 29 	<ul style="list-style-type: none"> Troubleshooting 43 Cautions on Handling and Storing Discs 45 Disc Type and Protection 46 Specifications 47 Warranty 48

PREPARATION

CONNECTIONS

OPERATION

SETUP

RADIO OPERATION

MISCELLANENOUS

Description

Front Panel

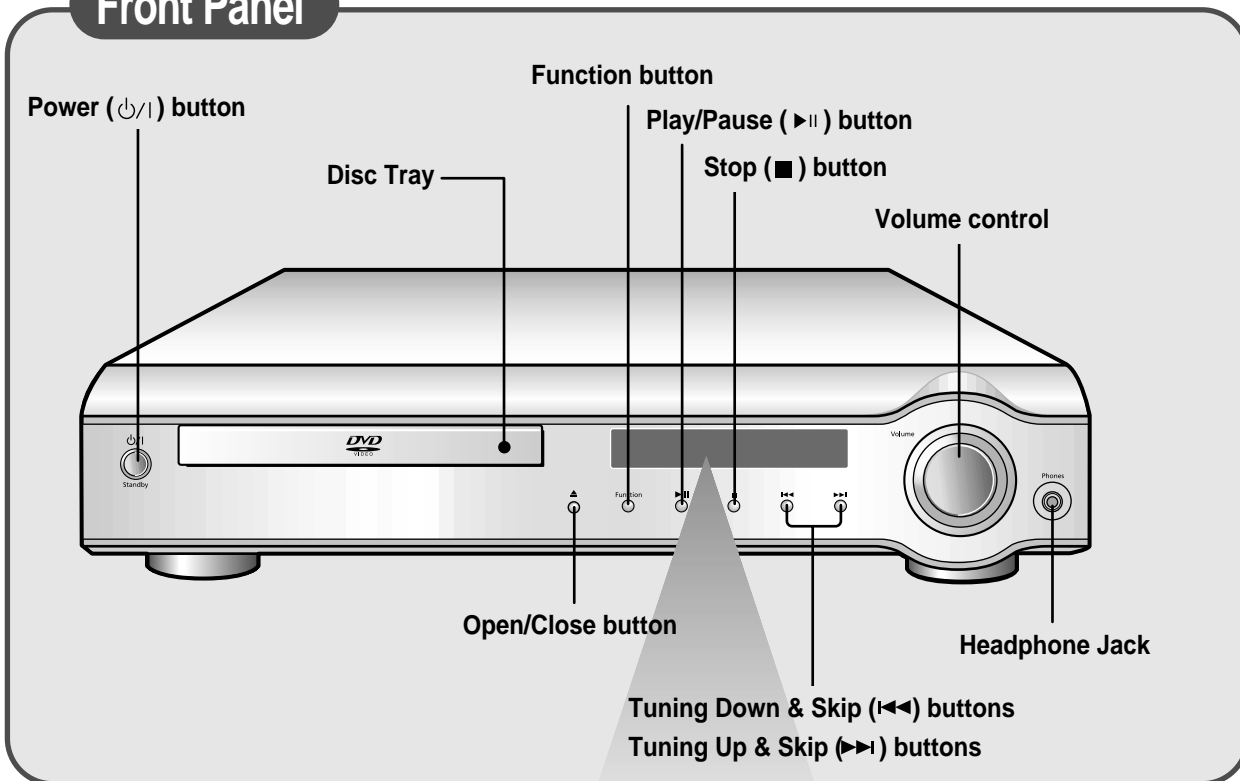

Display

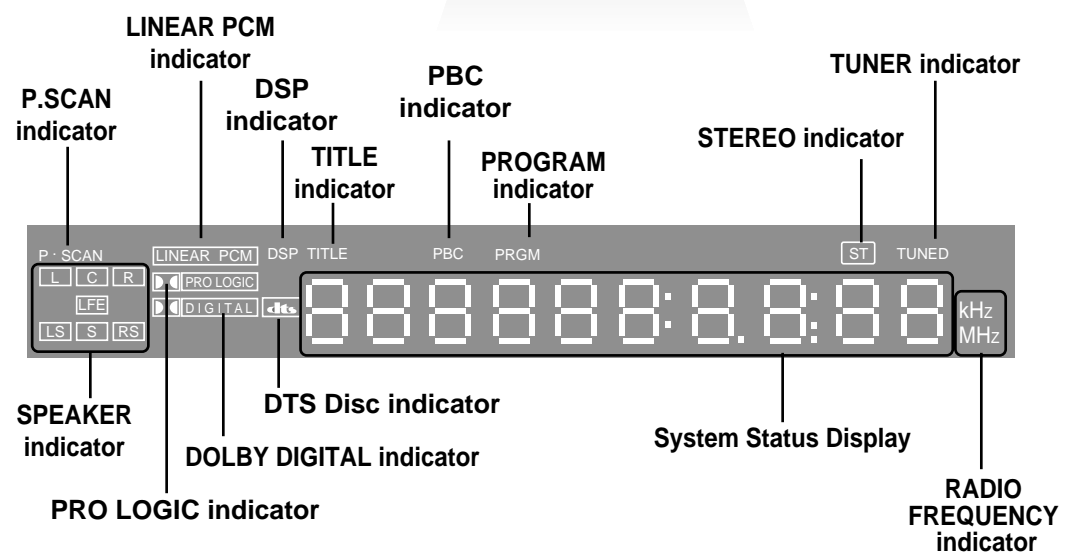

Rear Panel

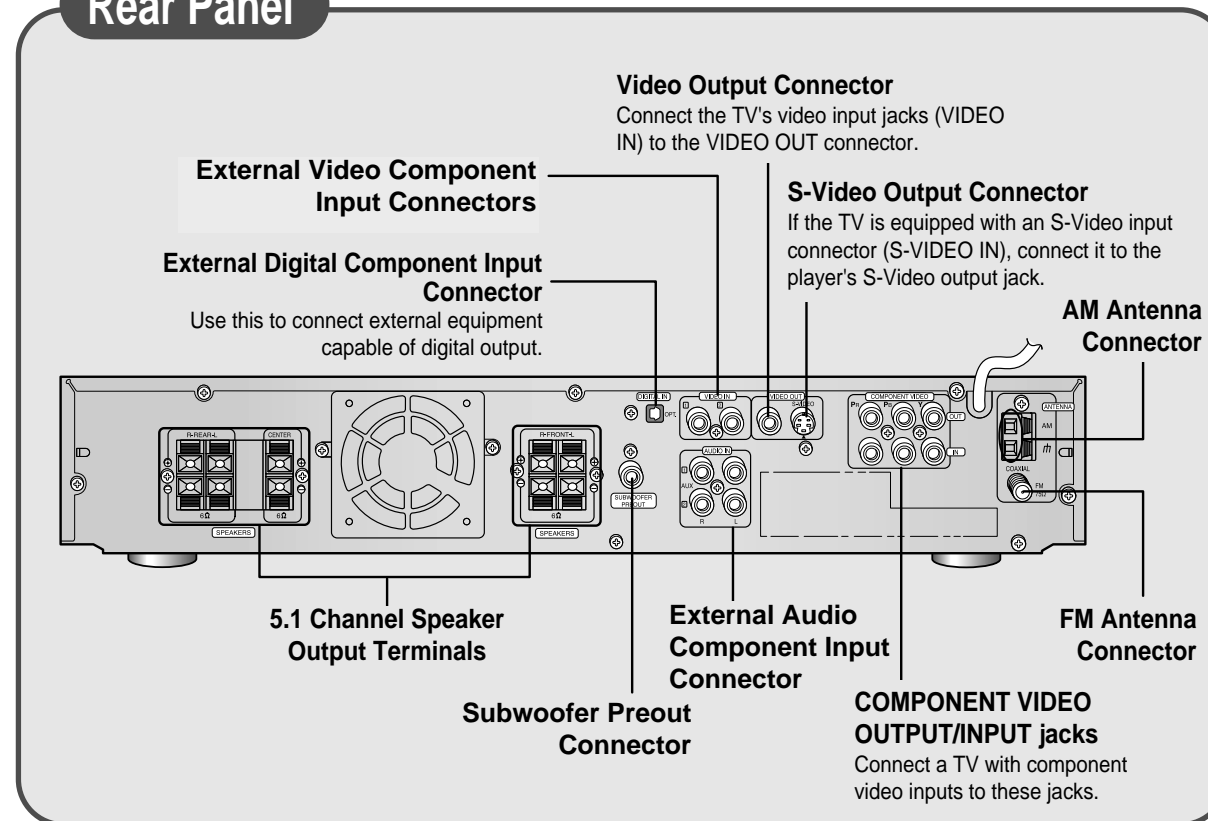

PREPARATION

Accessories

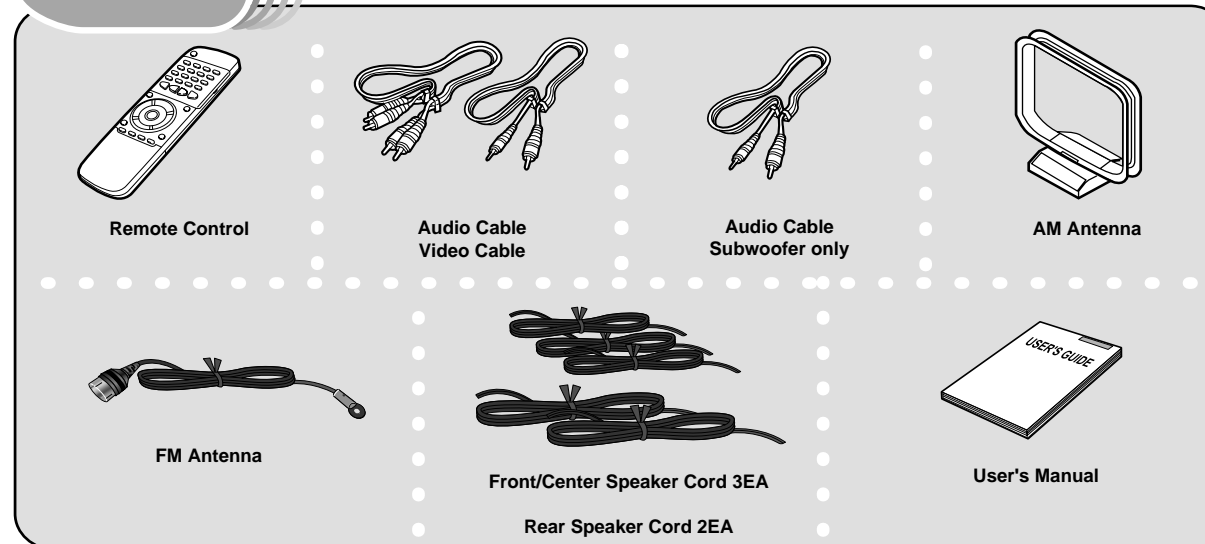

Remote Control Unit

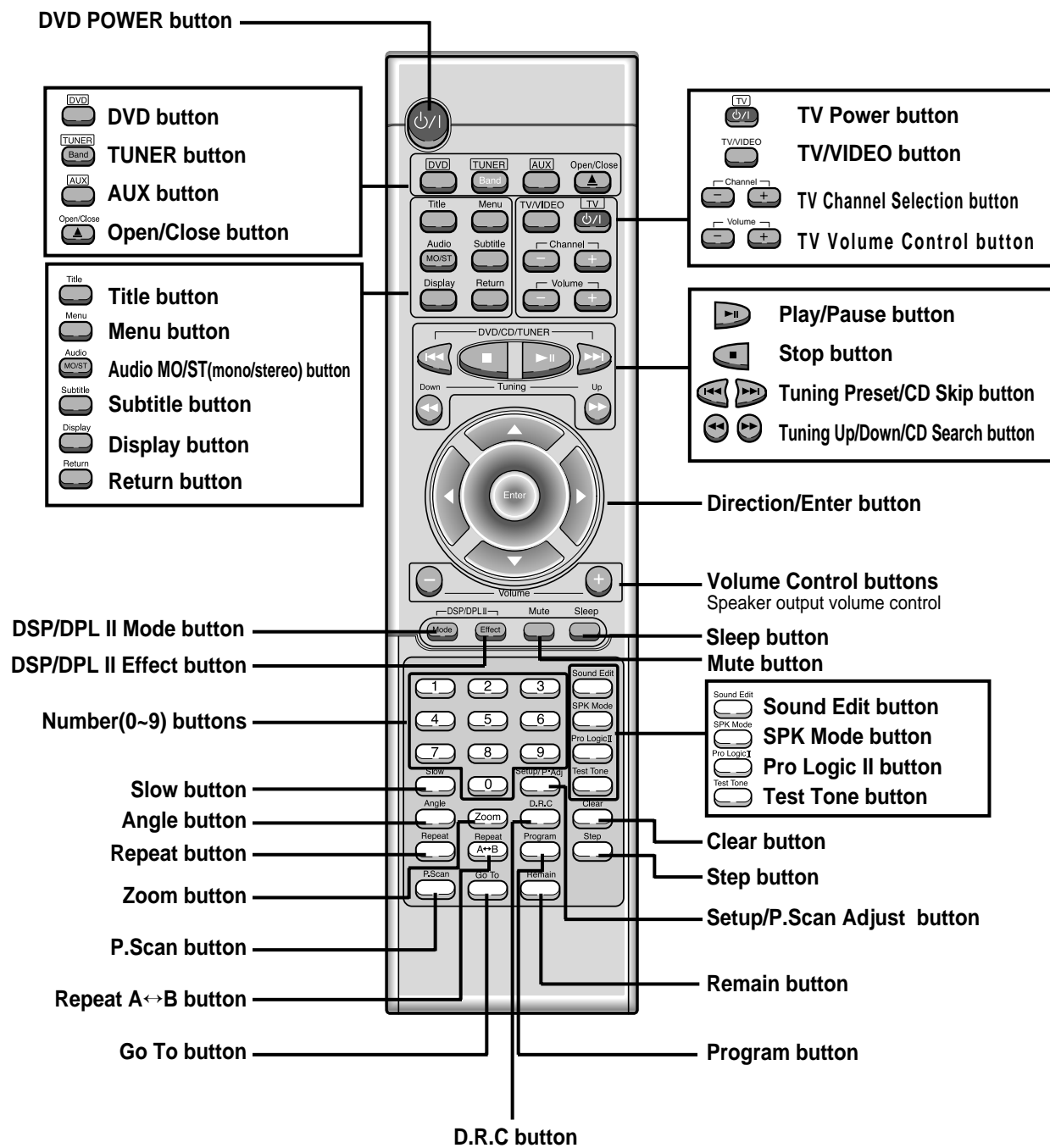

Insert Remote Batteries

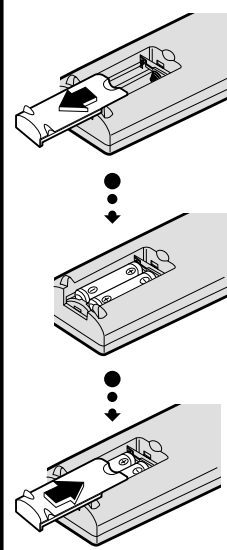

1 Remove the battery cover on the back of the remote by pressing down and sliding the cover in the direction of the arrow.

2 Insert two 1.5V AAA batteries, paying attention to the correct polarities (+ and -).

3 Replace the battery cover.



Follow these precautions to avoid leaking or cracking cells:

- Place batteries in the remote control so they match the polarity:(+) to (+)and (-)to (-).
- Use the correct type of batteries.Batteries that look similar may differ in voltage.
- Always replace both batteries at the same time.
- Do not expose batteries to heat or flame.

PREPARATION

Range of Operation of the Remote Control

The remote control can be used up to approximately 23 feet/7 meters in a straight line. It can also be operated at a horizontal angle of up to 30° from the remote control sensor.

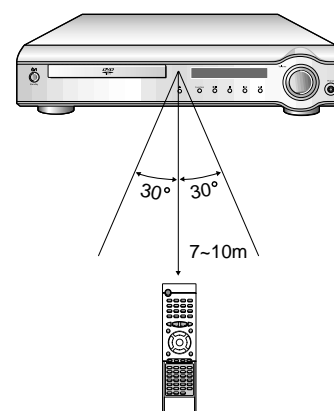

To open the remote control cover, push the top of the cover, then slide downward.

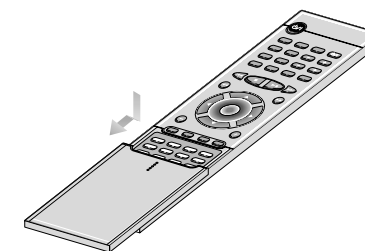

Connecting the Speakers

Connect the supplied speaker system using the supplied speaker cords.

- Make all connections with the power turned off to the unit to protect the speakers.

1 Check the location of the terminals on the main unit and on the rear of the speakers before connecting the Front, Rear, and Center Speakers.

- Connect the red cord to the red(+)terminal and the black cord to the black(-) terminal.

- Make sure the positive (+) and negative (-) speaker wires are not mixed.

2 Use the supplied audio cord to connect the SUBWOOFER PREOUT on the rear of the main unit to the LINE IN on the rear of the speaker.

Note • After installation is complete, tie up or taping down long, loose electrical cords.

Ideal Speaker Placement

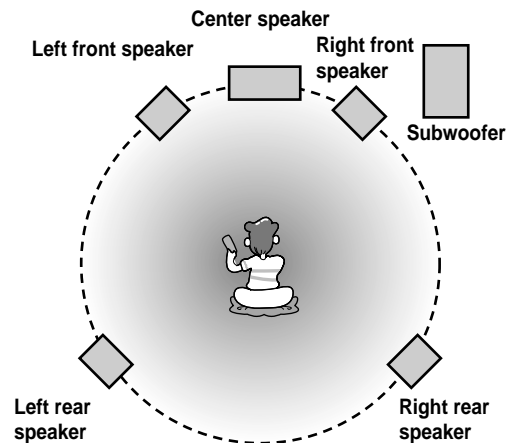

Front Speakers

Set the front speakers so that their tweeters (high-range) are aligned at about ear level and at a horizontal angle of 45° to the prime listening position.

Center Speaker

Ideally the center speaker should be positioned with its top surface flush with the front speakers. However, you may place the speaker either on top or near the bottom of your TV set. Vibration caused by the center speaker can disrupt the picture if it is placed directly on the television. Put the center speaker on a rack or shelf.

Rear Speakers

Set the rear speakers further back, parallel to the walls, at 60 to 90 centimeters (2 to 3 feet) above prime listening position ear level.

If the space behind the listening position is insufficient (i.e., too close to the wall), place the rear speakers facing each other on either side.

Subwoofer Speaker

Place the subwoofer on the floor near the TV or mount it on a rack, free from vibration and instability.

Note • Please refer to the KLIPSCH Operation Manual for details on using the speakers.

1 Loosen the speaker terminal by turning it counterclockwise.

2 Insert the speaker wire into the terminal.

3 Tighten the speaker terminal by turning it clockwise.

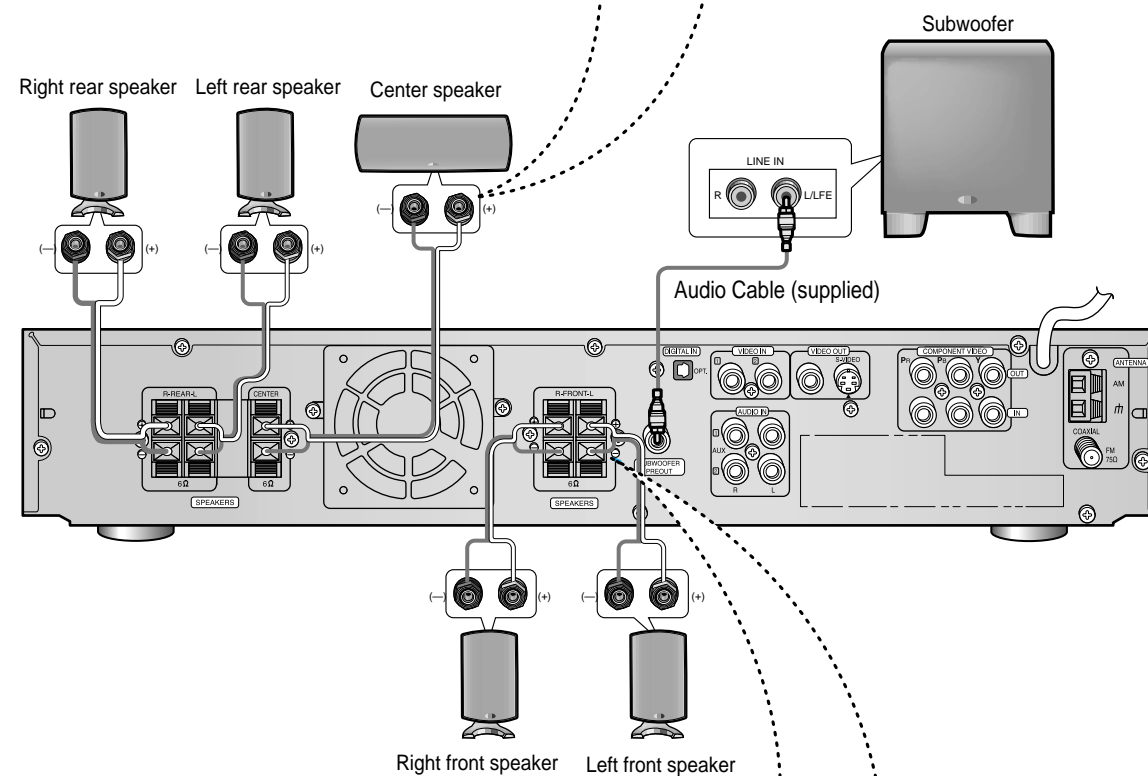
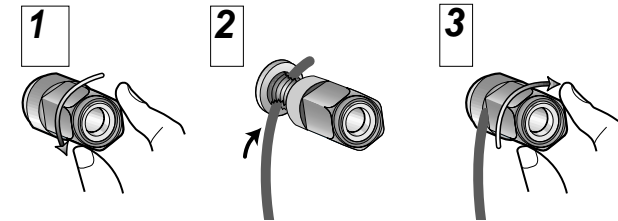

1 Press and hold the terminal tab.

2 Insert the speaker cord.

3 Release your finger.

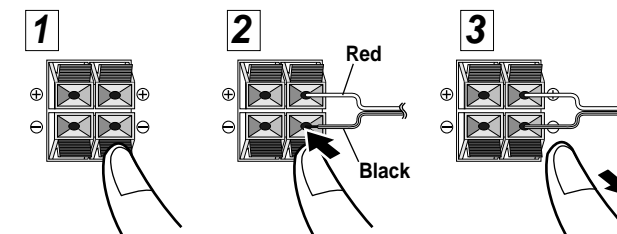

Connect Video to TV

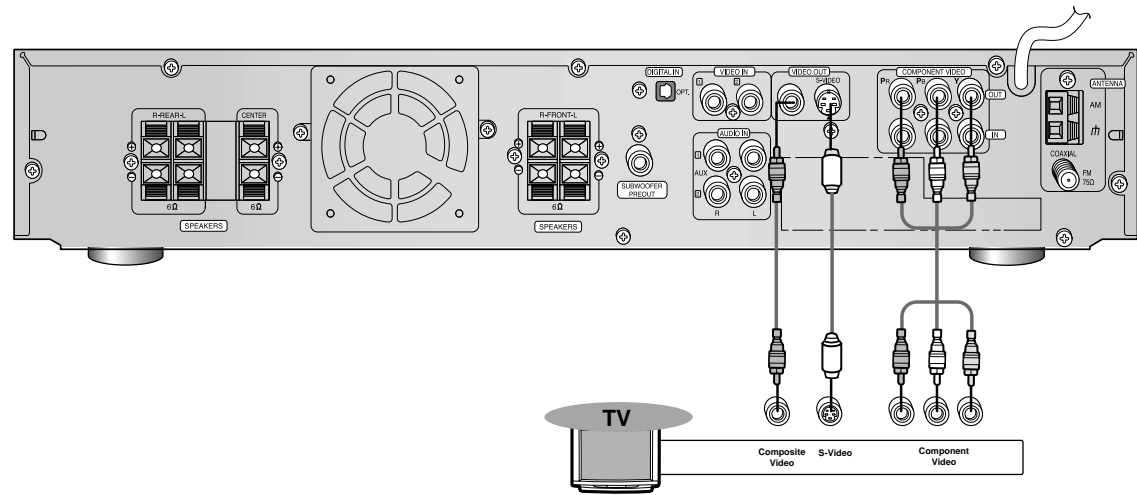

* Depending on your TV, Component Video input connectors may be marked as DVD Video input connectors.

Composite Video (Good Quality)

Connect the supplied video cable from the VIDEO OUT jack on the back panel of the system to the VIDEO IN jack on your television.

S-Video (Better Quality)

If your television is equipped with an S-Video input, connect an S-Video cable (not supplied) from the S-VIDEO OUT jack on the back panel of the system to the S-VIDEO IN jack on your television.

Component Video (Best Quality)

If your television is equipped with Component Video inputs, connect a component video cable (not supplied) from the Pr, Pb and Y jacks on the back panel of the system to the corresponding jacks on your television.

Note

- When the Progressive scan mode is selected, the VIDEO and S-VIDEO outputs do not feed any signals. See page 16 to select Progressive Scan.

Connecting the FM and AM(MW) Antennas

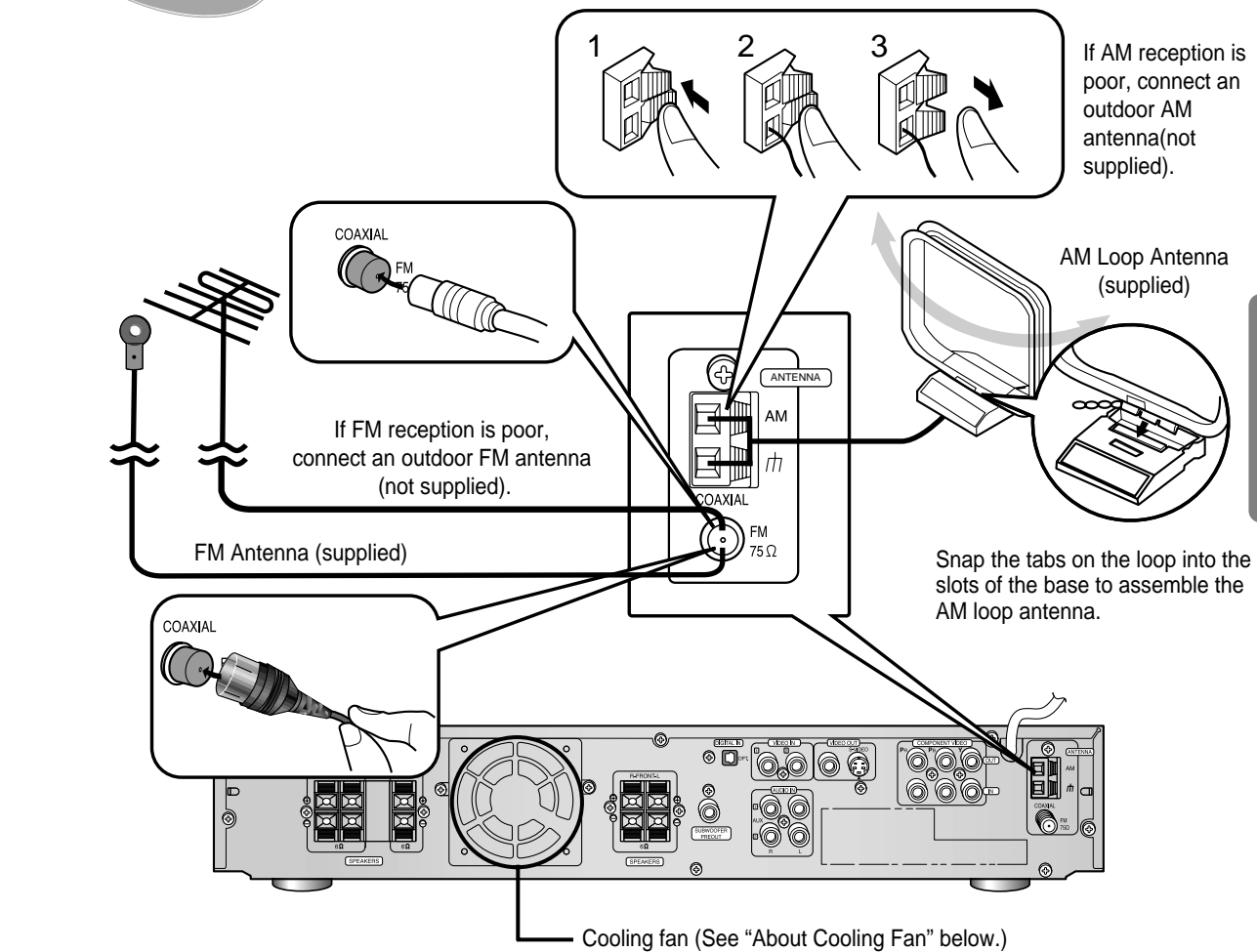

CONNECTIONS

FM antenna connection

1. Connect the FM antenna supplied to the FM 75Ω COAXIAL terminal as temporary measure.
2. Slowly move the antenna wire around until you find a location where reception is good, then fasten it to a wall or other rigid surface.

- If reception is poor, connect an outdoor antenna. Before attaching a 75Ω coaxial cable (with a standard type connector), disconnect the supplied FM antenna.

AM(MW) antenna connection

1. Connect the AM loop antenna supplied to the AM and 75Ω terminals.
2. If reception is poor, connect an outdoor single vinyl-covered wire to the AM terminal. (Keep the AM loop antenna connected).

(About the cooling fan)

A cooling fan is mounted on the rear panel of the center unit to prevent abnormal temperature inside the center unit, thus assuring normal operation. The cooling fan automatically starts rotating to supply external cool air to the inside of the center unit when the internal temperature exceeds the specified limit.

For safety, observe the following carefully.

- Make sure there is good ventilation around the center unit. Poor ventilation could overheat and cause damage.
- DO NOT block the cooling fan and the ventilation openings or holes. (If they are blocked by a newspaper or cloth, etc., the heat may not be able to escape.)

AUX Connections

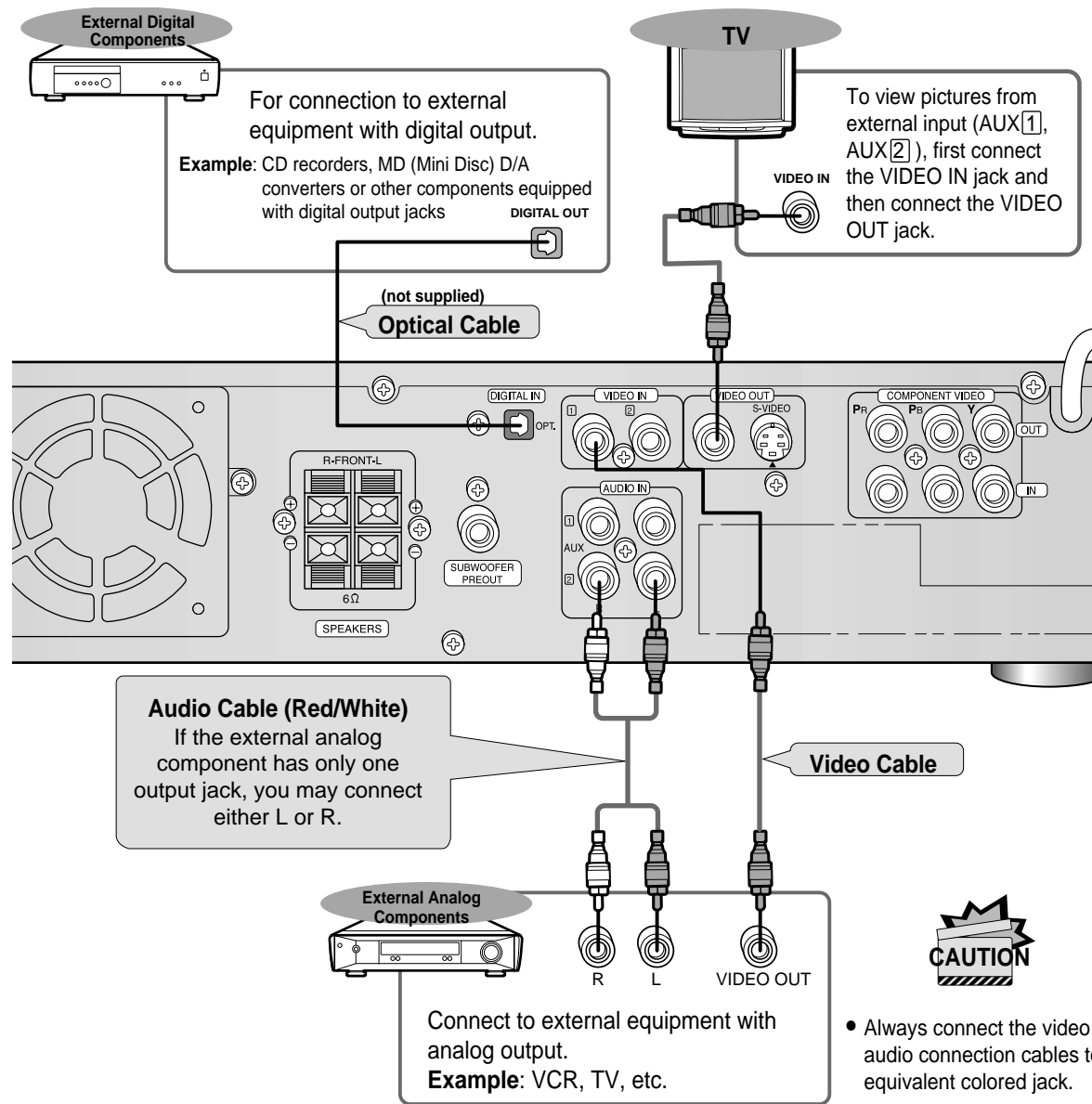

To Play External Digital/Analog Equipment

Press **AUX** on the remote control to select DIGITAL IN, AUX1, or AUX2.

Press **Function** on the main unit to select DIGITAL IN, AUX1, or AUX2.

- Each time the button is pressed the mode switches as follows: FM → AM → DVD → DIGITAL IN → AUX 1 → AUX 2.

Before Using the DVD Player

Your DVD player is capable of playing DVD, VCD, and CD discs. User instructions may vary depending on the type of disc. Read the instructions carefully before use.

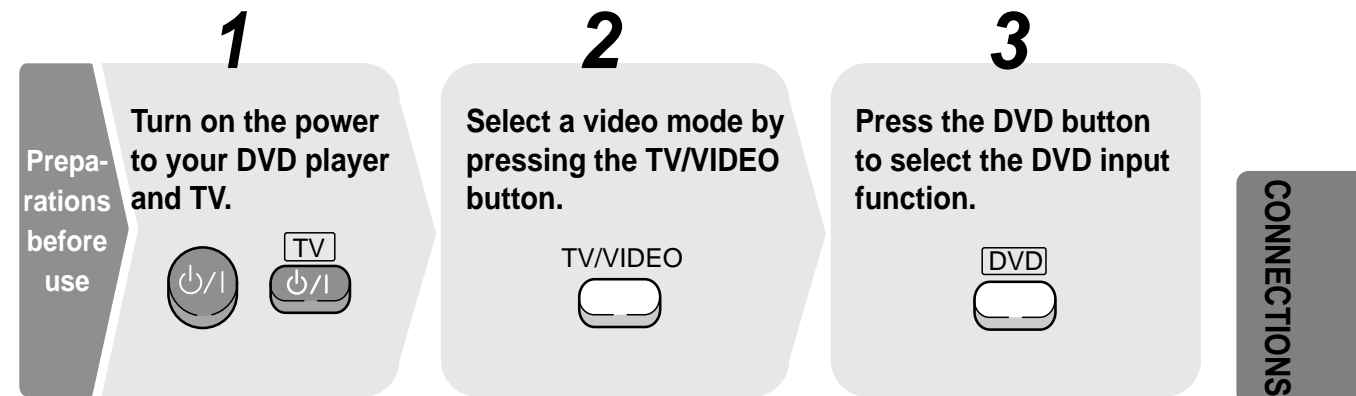

- Note**
- The "WAIT" message that appears on the display for about 4-5 seconds when turning on the power or selecting a DVD function indicates a stabilization period for optimizing the condition of your DVD player. While the message is being displayed, other buttons remain inactive.
 - When the power is not turned on, press down the Stop (■) button on the main unit for over 5 seconds. The product will be initialized to its optimum state.
 - Some operational features such as the Speaker mode, Test tone, Volume, etc. will not be displayed on the TV screen.



TV Broadcast System

- This device is designed to work with the NTSC video format.
- For normal playback, the video format a DVD disc is recorded in must coincide with your TV's video format.

Controlling a TV with the Remote

You can operate your TV by adjusting the DVD remote signal.

- 1** Turn on the TV.
- 2** Point the DVD's remote at the TV.
- 3** While holding the  button down, enter the code for your brand.
 - If there is more than one code listed in the table, enter one at a time to determine which code works.

example : For SAMSUNG 1TVs
While holding down the  button, enter  + .
- 4** If the TV turns off, setup is complete.

Code	Brand	Code	Brand
01	SAMSUNG 1	16	SHARP 1
02	SHARP 2	17	ZENITH
03	SONY	18	LG 3
04	MAGNAVOX	19	DAEWOO 8
05	SANYO 1	20	SANYO 2
06	LG 2	21	EMERSON
07	RCA	22	SHARP 3
08	LG 1	23	SAMSUNG 4
09	TOSHIBA	24	MATSUSHITA
10	HITACHI	25	NOBLEX
11	JVC	26	TELEFUNKEN
12	PANASONIC 1	27	NEWSAN
13	MITSUBISHI 2	28	LOEWE
14	SAMSUNG 2	29	RCA2
15			

Note • The remote may not be able to control every model TV of the brands listed.

Connecting your System to the Power Supply

- The AC Cord must be plugged into an appropriate socket.**
Before plugging your system into an AC outlet, you must check the voltage.
1. Plug the AC Cord on the rear of the system into an appropriate outlet.
 2. Press the On/Standby button to switch your DVD Player system on.

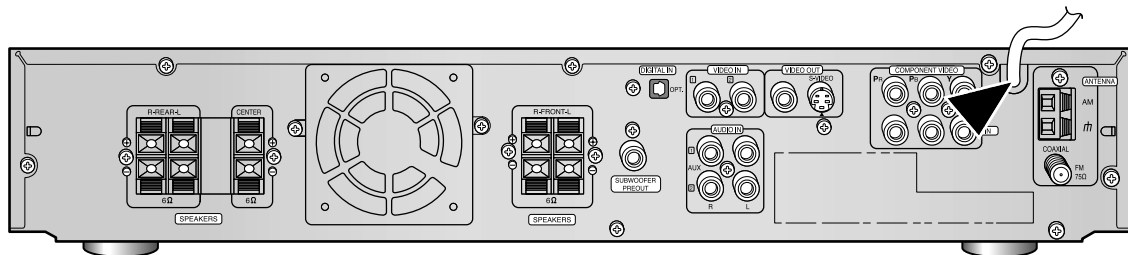

P.SCAN(Progressive Scan) Function

Unlike a regular Interlace Scan in which two fields of picture information are alternated to create the entire picture (odd scan lines, then even scan lines), Progressive Scan uses one field of information (all lines displayed in one pass) to create a clear and detailed picture without visible scan lines. To enjoy a progressive scan video, connect a TV or monitor that supports a progressive scan input to this device.

While the player is in the Stop mode, hold the P.SCAN button down for longer than 1 second.

- The selection switches back and forth between "P.SCAN" and "I.SCAN" each time the button is held down for a minimum of 1 second.
- The previous mode is indicated in the display first, followed by the selected mode in about a second.

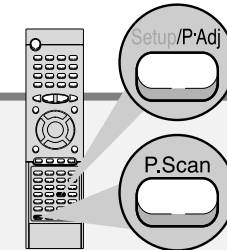

P.Scan Adj (Progressive Scan Adjusting)

This function allows you to optimize the picture quality when it becomes poor due to screen distortion or discs containing erroneous data.

Press the Setup/P Adj button. (Play mode only)

- Each time the Setup/P Adj button is pressed, the following appears on the TV screen:

→ FILM MODE → VIDEO MODE → AUTO MODE

What is Progressive (or Non-Interlaced) Scanning?

Interlaced Scan (1 FRAME = 2 FIELDS)

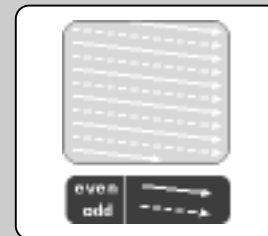

In interlaced-scan video, a frame consists of two interlaced fields (odd and even), where each field contains every other horizontal line in the frame. The odd field of alternating lines is displayed first, and then the even field is displayed to fill in the alternating gaps left by the odd field to form a single frame. One frame, displayed every 1/30th of a second, contains two interlaced fields, thus a total of 60 fields are displayed every 1/60th of a second each. The interlaced scanning method is intended for capturing a still object.

Progressive Scan (FULL FRAME)

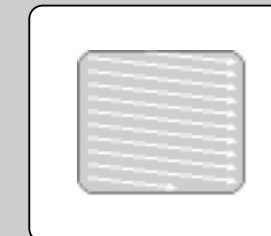

The progressive scanning method scans one full frame of video consecutively down the screen, line by line. As opposed to the interlaced scanning process by which a video image is drawn in a series of passes, you get an entire image drawn at one time. The progressive scanning method is desirable for dealing with moving objects. A camera that has the ability to capture moving objects is called a "full frame shutter camera".

- Note**
- This function works only on TVs equipped with component video inputs (Y, Pr, Pb) that support Progressive Video. (It does not work on TVs with conventional component inputs, i.e., non-progressive scan TVs.)
 - Depending on the brand and model of your TV, this function may not work.

DVD Playback

- 1**

Press the **Open/Close** (▲) button to open the disc tray.

 - The button is located on the Front Panel of the player (not on the remote).
- 2**

Insert a disc.

 - Place a disc gently into the tray with the disc's label facing up.
- 3**

Press the **Open/Close** (▲) button again to close the disc tray.

 - Playback starts automatically.

Using the On-Screen Display

Press the Display button on the remote.

The On-Screen Display (OSD) shows the following information:

- DVD indicator**: DVD VIDEO
- TITLE indicator**: T 1/2
- CHAPTER indicator**: C 1/8
- TITLE ELAPSED indicator**: 00:00:00
- SUBTITLE LANGUAGE indicator**: ENG
- AUDIO LANGUAGE indicator**: ENG 1/3
- DISC TYPE indicator**: dts OFF
- ANGLE indicator**: 1/1

The On-Screen Display disappears.

OPERATION

Pausing Playback

Press the **Play/Pause** (▶||) button during playback.

- To resume, press the Play/Pause (▶||) button again.

Note Depending on the disc, the initial disc information screen may look different from disc to disc.

Stopping Playback

Press the **Stop** (■) button during playback.

- During playback, when the Stop (■) button is pressed, the position is stored in the memory, and ▶■ STOP is shown on the display. When the Play/Pause (▶||) button or Return button is pressed subsequently, playback resumes from the position at which it was stopped.
- If the Stop (■) button is pressed a second time, the resume play memory function is canceled, and ■ STOP is shown on the display. When the Play/Pause (▶||) button is pressed, playback starts from the beginning.

What is a Title?
A movie contained in a DVD disc.

What is a Chapter?
Each Title on a DVD disc is divided into several smaller sections called "chapters".

Turning the sound off temporarily?

Press the **Mute** button during playback.

- This operation may be useful when you need to greet guests or answer the telephone.

Note If the player is left for more than 3 minutes in pause mode, it will stop.

MP3-CD Playback

This system has a built-in MP3 decoder.
You can play back MP3 tracks (files) recorded on CD-Rs, CD-RWs, and CD-ROMs.

What is MP3? MP3 is an abbreviation of Motion Picture Experts Group (or MPEG) Audio Layer 3. MP3 is simply a file format with a data compression ratio of 1:10 (128 Kbps*). That means, by using MP3 format, one CD-R or CD-RW can contain 10 times as much data volume as a regular CD.

Starting Playback

- It is recommended you turn on your TV when playing back an MP3-CD.

1

Press the **Open/Close** (▲) button to load a disc.

2

Press the **Play/Pause** (▶||) button.

- After detecting the disc, playback starts.
- The on-screen bar and the contents recorded on the MP3-CD will be shown on the TV if it is turned on.

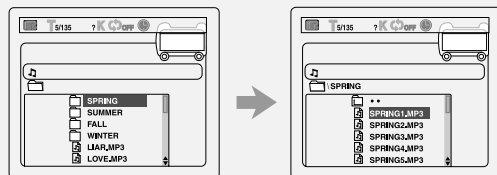

1 : Disc type
DVD VCD CD MP3

2 : Current track (file) and total number of the tracks on the disc
• Ex.: 1st track is playing out of 35 tracks recorded.

3 : Bit rate
• Ex.: Bit rate used for recording the loaded disc is 128 Kbps. (See below)

4 : Repeat mode indicator
• Ex.: When repeat mode is turned off.

5 : Elapsed playing time and the total playing time of the current track
00:22/03:48

6 : Sound indication
• Indicates sound input level. (Only appears during playback.)

To stop during playback Press the **Stop** (■) button.

CD-R MP3 DISC

- Only CD-R discs with MP3 files in ISO 9660 or Joliet format can be played.
- The file name of the MP3 file may not be longer than 8 characters and should contain no blank spaces or special characters.
- Use discs recorded with a compression/decompression data rate greater than 128Kbps.
- Only files with the ".mp3" and ".MP3" extensions can be played.
- Only a consecutively written Multisession disc can be played. If there is a blank segment in the Multisession disc, the disc can be played only up to the blank segment.
- If the disc is not closed, it will take longer to begin playback and not all of the recorded files may be played.
- For files encoded in Variable Bit Rate (VBR) format, i.e. files encoded in both low bit rate and high bit rate (e.g., 32Kbps ~ 320Kbps), the sound may skip during playback.

Note Depending on the recording mode, some MP3-CDs cannot be played.

Operations Using the On-Screen Display

Turn on your TV when playing back an MP3 disc.

When the loaded MP3 disc is recognized, the following on-screen display appears on the TV screen.
(The contents of this on-screen display vary according to the disc — the way MP3 tracks were recorded on the disc.)

Button	To do
ENTER, ▶	Start playback or go into a directory.
▲/▼	Select a track or directory.

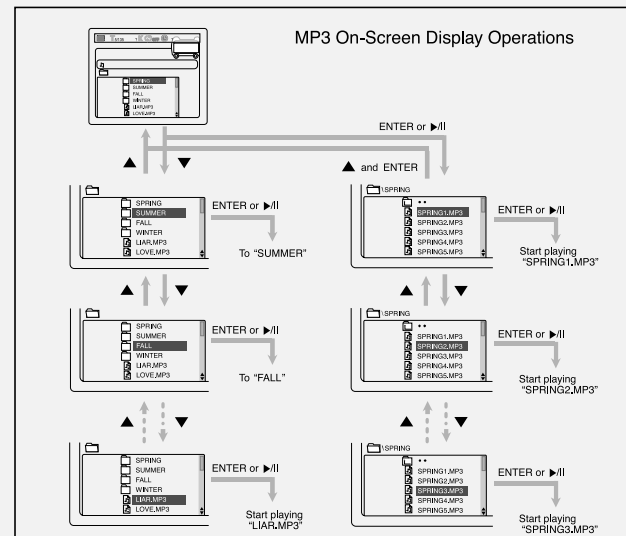

CD-R/RW playback compatibility

- Your DVD player can also play CD-R and CD-RW discs recorded in digital audio format. When recording your own CD-R or CD-RW discs, make sure that the recording session is properly terminated, or they will not be playable. (Depending on disc properties and recording quality, some CD-R/RW may not be playable.)
- CD-RW has a lower reflection rate than CD-R media and consequently it will take a longer to read CD-R discs.
- CD-RW discs recorded at high speed tend to be difficult for the DVD player to read. If the recording speed for the CD-RW disc is not predetermined, write it at low speed.

OPERATION

Repeating Playback

On an MP3 disc, Repeat A↔B cannot be used. You can enjoy only repeat play.

Press the REPEAT button.

The indication corresponding to the selected mode appears on the TV screen.

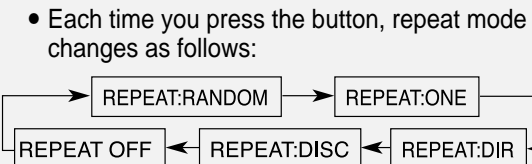

REPEAT:RANDOM

: All tracks recorded on the disc will be played once in random order.

REPEAT:ONE

: Current track will be repeated.

REPEAT:DIR

: Tracks in the current directory will be repeated.

REPEAT:DISC

: All tracks on the disc will be repeated.

REPEAT OFF

: Repeat play is canceled. (Normal play is resumed.)

Forward/Reverse Searching

During playback, you can search quickly through a chapter or track for a specific scene or tune.

Multi-Speed Playback 

Press the **◀▶** button.

Each time the **◀▶** button is pressed

- ◀▶ X 2
- ◀▶ X 4
- ◀▶ X 8
- ◀▶ PLAY

Each time the **▶▶** button is pressed

- ▶▶ X 2
- ▶▶ X 4
- ▶▶ X 8
- ▶▶ PLAY

Skipping through a Chapter 

Press the **◀◀▶▶** button.

- Each time the button is pressed during playback, it moves to the next or previous chapter and plays it.

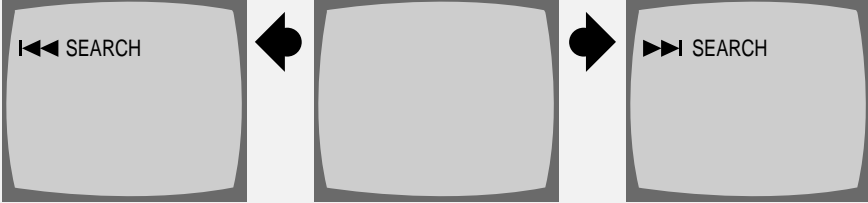

Playing Frame by Frame 

Press the Step button.

- The picture moves forward one frame each time the button is pressed.

Note No sound is heard during high-speed playback, slow playback, and step motion.

Slow Playback/Checking the Remaining Time

Playing Slowly 

Press the **Slow** button.

Each time the **Slow** button is pressed

- ▶ SLOW 1/2
- ▶ SLOW 1/4
- ▶ PLAY

VCD The slow playback speed changes and the selections (1/2X, 1/4X, 1/8X, 1/16X and normal play) are repeated.

Checking the Remaining Time 

Press the **Remain** button.

- For checking the total and remaining time of a title or chapter being played.

Each time the **Remain** button is pressed

- DVD**
 - TITLE TIME
 - REMAIN TIME : TITLE
 - CHAPTER TIME
 - REMAIN TIME : CHAPTER
- VCD CD**
 - TRACK TIME
 - REMAIN TIME : TRACK
 - DISC TIME
 - REMAIN TIME : DISC

OPERATION

Repeat Playback

Repeat playback allows you to repeat a chapter, title, or track.

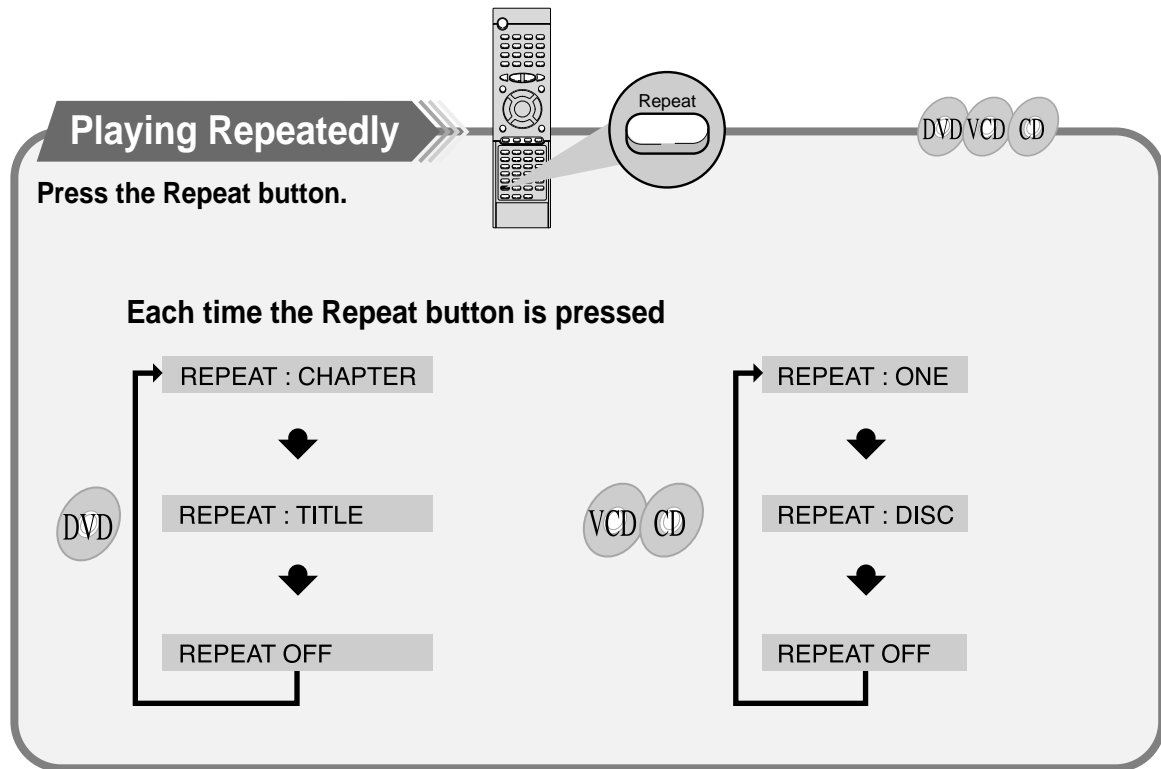

Note • Repeat playback operation is not possible with version 2.0 VCD discs if PBC is turned on. To operate this feature, press the MENU button, and then select "PBC OFF".

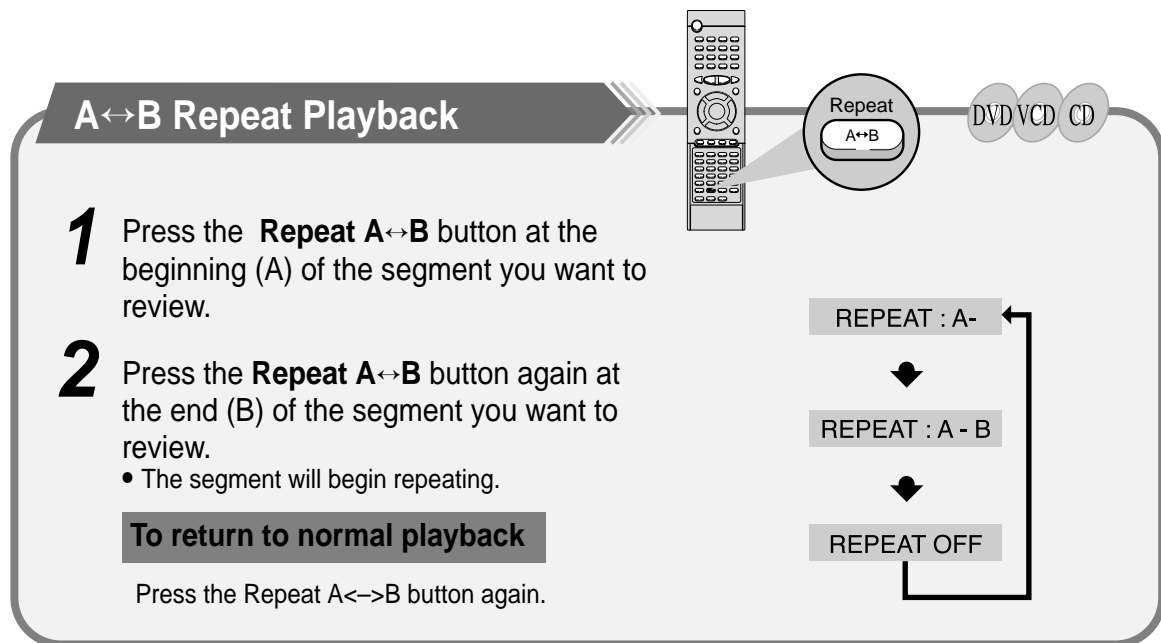

Using Disc Menu/Title

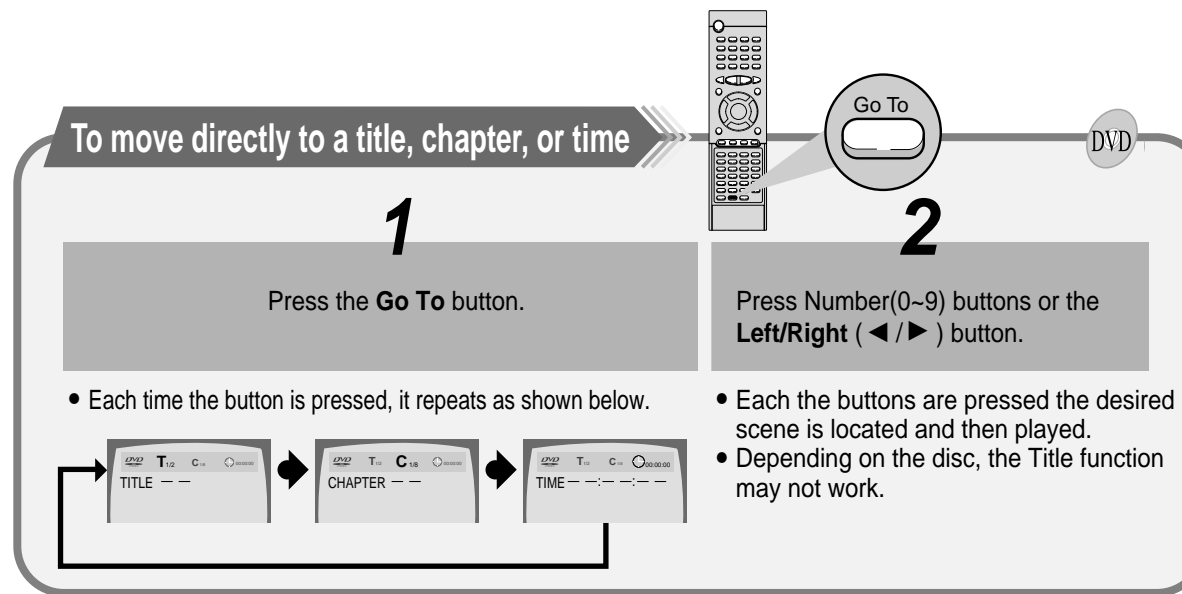
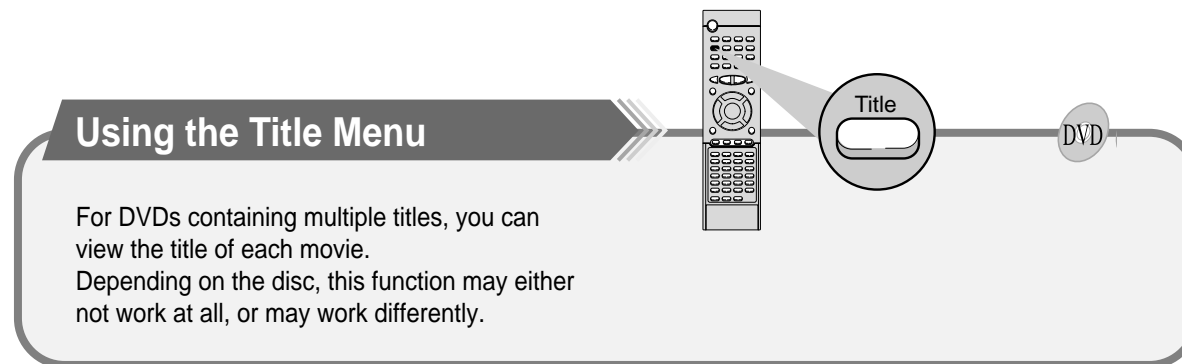
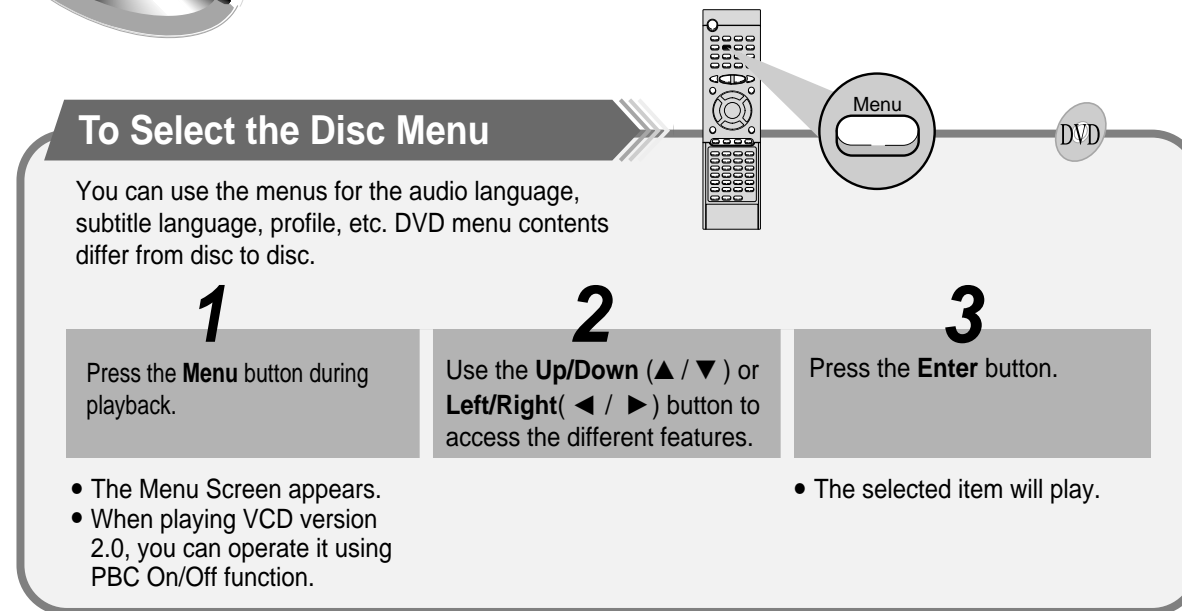

OPERATION

Selecting the Audio Language/Subtitle Language

Selecting the Audio Language

Press the Audio button.

- Depending on the number of languages recorded on a DVD disc, a different audio language (ENGLISH, SPANISH, FRENCH, etc.) is selected each time the button is pressed.

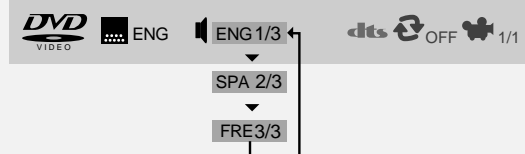

- Note**
- Depending on the disc, DTS or DIGITAL PRO LOGIC can be selected.

Selecting the Subtitle Language

Press the Subtitle button.

- Depending on the number of languages recorded on a DVD disc, a different subtitle language (ENGLISH, SPANISH, FRENCH etc.) is selected each time the button is pressed.
- To make the subtitles disappear, select "OFF".

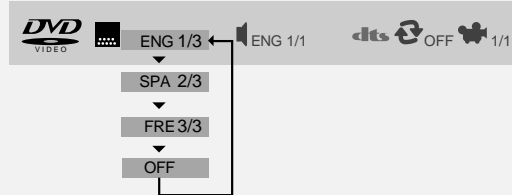

- Note**
- If the word INVALID appears on the TV screen while buttons are being operated, that operation is not possible with that particular disc.
 - Depending on the disc, the audio or subtitle language function may not work.

Zoom/Angle Functions

To enlarge an image

Press the Zoom button.

- Images can be enlarged 2x and 4x.
- During DVD playback, press the **Zoom** button to zoom in 2X/4X/normal, in that order.
- Press ◀ / ▶ / ▲ / ▼ to move the enlarged portion you want to watch.

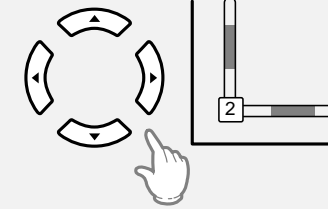

- Note**
- Only 2X zoom operation is possible during VCD playback.

Selecting the desired Screen Angle

Press the Angle button.

- This function only works with discs on which multiple angles have been recorded.
- During playback, press the **Angle** button to select the desired angle: 1/3, 2/3, 3/3, normal, in that order.

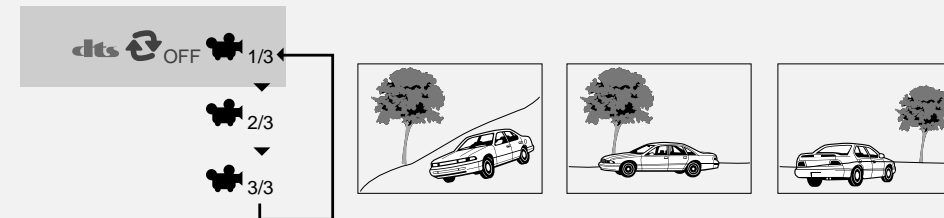

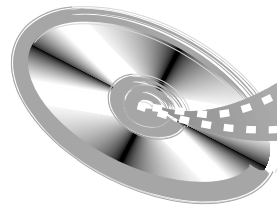

Program Playback

Use this function with video and music CDs to play the tracks in a particular order.

To Program Tracks in a particular order

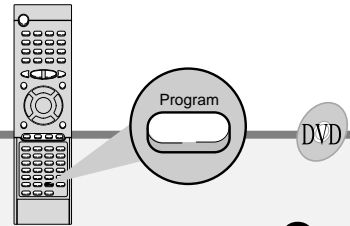

1

Press the **Program** button.

2

Press the **Enter** button, then use the Number buttons to select the desired title.

3

Press the **Enter** button, then use the Number buttons to select the desired chapter.

• You can also use the **Up/Down/Left/Right** (▲/▼/◀/▶) button.

• You can also use the **Up/Down/Left/Right** (▲/▼/◀/▶) button.

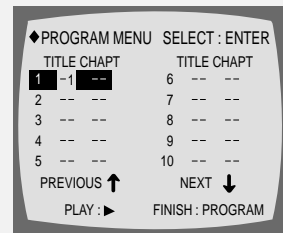
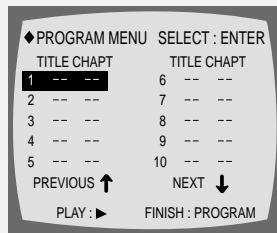

4

Press the **Enter** button.

5

At this time, you can continue programming if you want to.

• The selected track number is programmed and the cursor moves to the next number.

• When programming more than 10 tracks, select **NEXT** (↓) and then press the **Enter** button. The program selection screen where you can program up to 10 additional tracks appears.

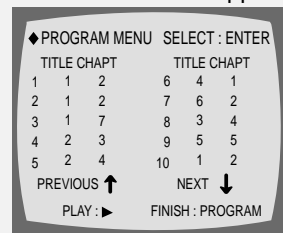
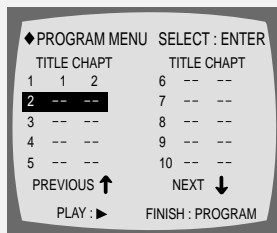

To Playback the Tracks in Programmed Order

Press the **Play/Pause** (▶||) button.

To Leave the Programming Mode

••• Press either the **Program** or **Stop** (■) button.

To Change the Program

DVD

1

Press the **Up/Down** (▲/▼) button to select the track number to be changed.

2

Press the **Enter** button to select the title or chapter to be changed.

3

Press the **Clear** button and then press the Number buttons.

• The cursor moves to the next number when the **Enter** button is pressed again.

• You can also use the **Left/Right** (◀/▶) button.

4

Press the **Enter** button.

5

Repeat steps 1-4 above to change the program.

• The cursor moves to the number below.

OPERATION

To delete the entire Program

- Press the **Stop** (■) button twice during playback.
- Press the **Stop** (■) button once when in the Stop mode.
- Press the **Open/Close** (▲) button on the main unit. The disc tray will open and then close. The program will then be deleted.

When you have entered a wrong number

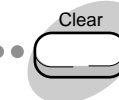

Press the **Clear** button.

- When you want to delete a selection during programming, select the track (or chapter, or title) to be deleted and then press the **Clear** button.



You can program or change particular tracks for VCD or CD discs in the same manner.

Sleep/D.R.C Function

To set up Sleep

Press the Sleep button.

- Each time the button is pressed the selection toggles as follows: SLEEP 10 → SLEEP 20 → SLEEP 30 → SLEEP 60 → SLEEP 90 → SLEEP 120 → SLEEP 150 → OFF.

To Review Sleep Setting

- Press the Sleep button. The remaining time for the selected Sleep time is displayed on the front panel.
- Pressing the button once again changes the Sleep time from the last setting.

What is the Sleep function?
You can set the sleep time so that the unit powers off automatically after a preset period of time.

Activating Dynamic Range Compression

You can enjoy a powerful sound even at a low volume level by compressing the dynamic range (difference between the maximum and minimum sounds).

From the remote control ONLY:

Press the D.R.C button.

- Each time you press the button, the dynamic range compression mode alternates between on and off. Select "D.R.C.ON" while watching the DVD at night. (You can obtain a powerful sound at a low volume.)
- This function takes effect only when Dolby Digital or DTS Digital Surround is activated.

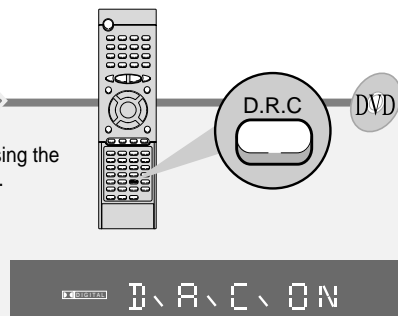

Note • When the Stop button is pressed, DRC is switched to Off.

Listening on headphones

Use headphones (not supplied) for private listening pleasure.

Connect the headphones to the HEADPHONE jack of the front panel.

- No sound is produced from the speakers.
- To prevent hearing damage, do not raise the volume level excessively when using headphones.

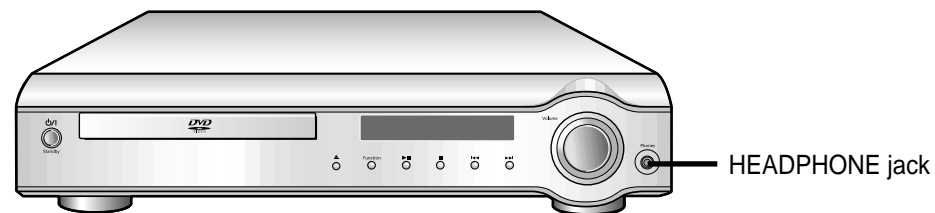

Setting up the Language Features

Using the DVD player's Setup function, you can customize the Menu Language, Subtitle Language, and Disc Menu Language.

To set up the language feature

1

Press the **Setup/P·Adj** button from the stop mode.

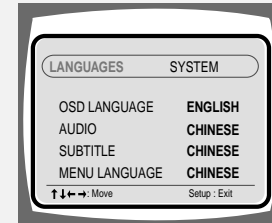

2

Press the **Up/Down** (▲/▼) button to select the desired item.



If the **Setup/P·Adj** button is pressed during the language setup, it returns to the stop mode again.

3

Press the **Enter** button or **Right** (▶) button.



4

Press the **Up/Down** (▲/▼) button to select the desired language and then press the **Enter** button.

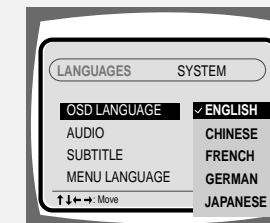

To End the Language Features Setup

- Press the **Setup/P·Adj** button again.

OPERATION

SETUP

System Setup

You can use the DVD player's Setup function to select the TV screen ratio, rating limit, or digital output mode.

To Set up the System

- From the stop mode, press the **Setup/P-Adj** button.
- Press the **Left/Right** (◀ / ▶) button to select the system.
- Press the **Up/Down** (▲ / ▼) button to select the desired item.
- Press the **Enter** button or **Right** (▶) button.
- Press the **Up/Down** (▲ / ▼) button to select the desired sub-item and then press the **Enter** button.

Adjusting the TV Aspect Ratio (Screen Size)

The horizontal to vertical screen size ratio of conventional TVs is 4:3, while that of wide screen and high definition TVs is 16:9. This ratio is called the aspect ratio. When playing DVDs recorded in different screen size, you should adjust the aspect ratio to fit your TV or monitor.

★ For a standard TV, select either "4:3LB" or "4:3PS" option according to personal preference. Select "16:9" if you have a wide screen TV.

- 4:3LB (4:3 Letterbox)** : Select this to play a 16:9 picture in the letter box mode on a conventional TV.
 - Black bars will appear at the top and bottom of the screen.
- 4:3PS (4:3 Pan&Scan)** : Select this to play a 16:9 picture in the pan & scan mode on a conventional TV.
 - You can see the central portion of the screen only (with the sides of the 16:9 picture cut off).
- 16:9** : Select this to view a 16:9 picture in the full-screen mode on your wide screen TV.
 - You can enjoy the wide screen aspect.



Note

- If a DVD is in the 4:3 ratio, you cannot view it in wide screen.
- Since DVD discs are recorded in various image formats, they will look different depending on the software, the type of TV, and the TV aspect ratio setting.

RATING LEVEL

The Rating Level function works in conjunction with DVDs which have been assigned a rating, to help control the types of DVDs that your family watches.

1. Select RATING LEVEL, then press the Enter button.

2. Use the number(0~9) buttons to input a 4-digit password.

- The player's password is set to "7890" by default.

3. Use the Up/Down (▲/▼) button to select either RATING LEVEL or NEW PASSWORD, and then press the Enter button.

- There are up to 8 rating levels on a disc.
- If LEVEL 6 is selected, a disc which contains rating LEVEL 7 and above cannot be played.
- If you select NEW PASSWORD, the screen changes and enables you to enter the new password.

When the rating level password has been forgotten

While the player is in the stop mode, hold the **Stop** (■) button down on the main unit for more than 5 seconds.

- "INITIAL" appears on the display and all default settings will return to Factory Preset.
- Press the **Power** button.

To End the System Setup

- Press the **Setup/P-Adj** button again.

Speaker Setup

Setting up Speaker Mode and Delay Time

1

Press the **SPK Mode** button.

2

Press the **Left/Right** (◀/▶) button to select the desired item.

- Each time the button is pressed, a different mode selection is displayed on the front panel display as shown below.

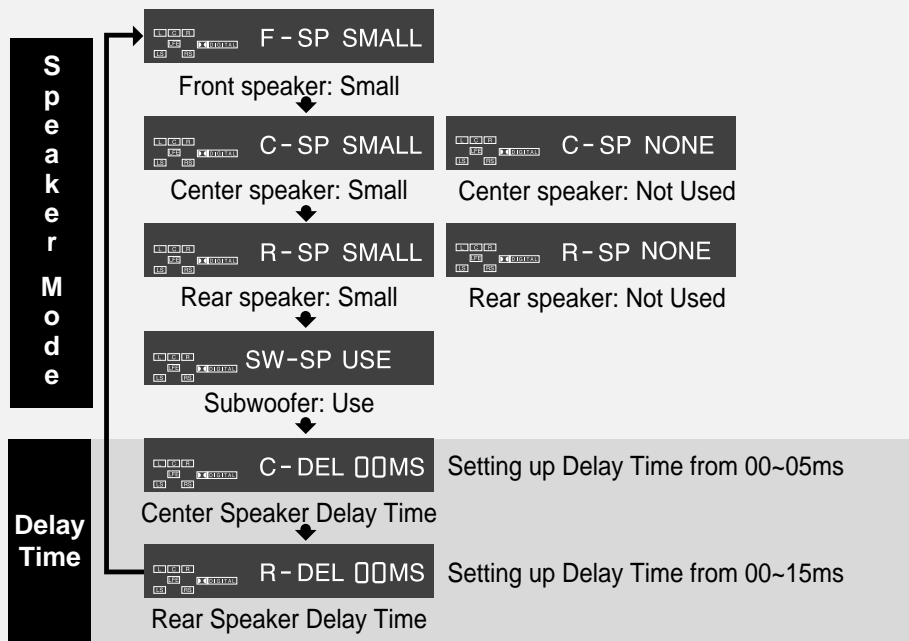

- SMALL:** When this setting is selected, low frequencies of below 200 Hz are assigned to the subwoofer only.
- USE:** Select when using speakers.
- NONE:** Select this when no speakers are installed.

Setting up the Speaker Delay Time

When 5.1CH Surround Sound is played, you can enjoy the best sound if the distance between you and each speaker is the same. Since the sounds arrive at the listening position at different times depending on the placement of speakers, you can adjust this difference by adding a delay effect to the sound of the Center Speaker and Surround Speakers.

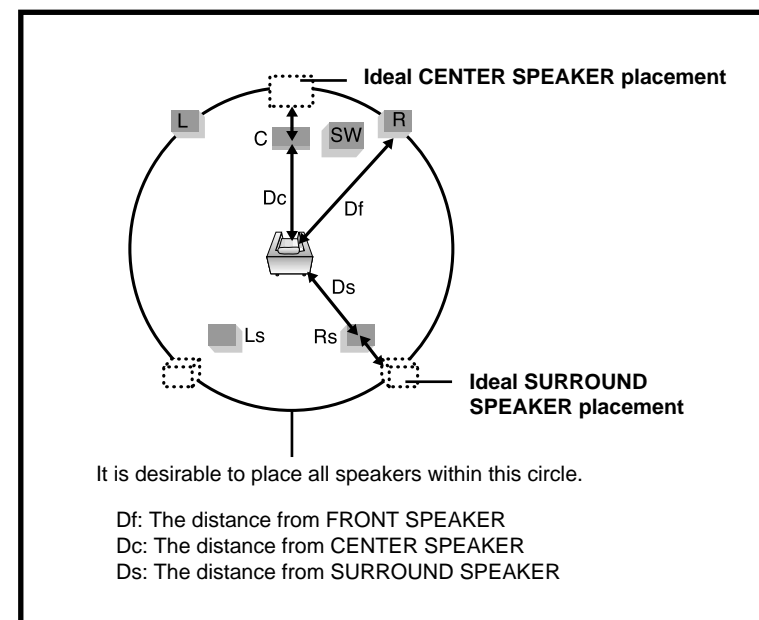

Setting CENTER SPEAKER

If the distance of Dc is equal to or longer than the distance of Df in the figure, set the mode as 0ms. Otherwise, change the setting according to the table.

Distance between Df and Dc	Delay Time
50	1.3 ms
100	2.6 ms
150	3.9 ms
200	5.3 ms

Setting REAR (SURROUND) SPEAKERS

If the distance of Df is equal to the distance of Ds in the figure, set the mode as 0ms. Otherwise, change the setting according to the table.

Distance between Ds and Dc	Delay Time
200	5.3 ms
400	10.6 ms
600	15.9 ms

Note The display changes depending on the current audio output mode (DSP, PRO LOGIC, 3-STEREO, STEREO, etc.).

Note Speaker delay time setting is a professional sound volume adjustment method for audio enthusiast. For home use, refer to "Setting up the Ideal Speaker Positions" on page 9 to install speakers in appropriate locations.

SETUP

To set up Speaker Balance

To set up Speaker Balance

1

Press the **Sound Edit** button. Each time the button is pressed, the selection switches as shown below.

2

Use the **Left/Right** (◀/▶) button to raise or lower the output level of the chosen speaker(s).

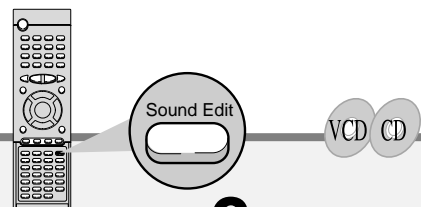

Example: 5.1CH Sound Setup

-00 F-00

OFF, range of -6 ~ 0

Front Speakers: L level, R level

-00 R-00

OFF, range of -6 ~ 0

Rear Speakers: L level, R level

CEN 00dB

range of -6 ~ -00 ~ +6

Center Speaker

REAR 00dB

range of -6 ~ -00 ~ +6

Rear Speakers

SW 00dB

range of -6 ~ -00 ~ +6

Subwoofer Speaker

Note The display changes depending on the current audio output mode (DSP, PRO LOGIC, 3-STEREO, STEREO, etc.).

Speaker Setting Methods

Press the **Test Tone** button.

- The test signal will be sent to the Left Front → Center → Right Front → Right Rear → Left Rear → Subwoofer in that order.

To End the Speaker Setup

Press the **Test Tone** button again.

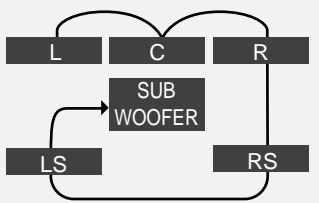

Note While in DSP or PRO LOGIC mode, TEST TONE may operate differently for VCDs or CDs.

Creating Realistic Sound Fields

You can use the following surround modes to reproduce a realistic sound field.

- Digital Multichannel Surround —Dolby Digital and DTS Digital Surround
- Dolby Pro Logic II

Dolby Digital and DTS Digital Surround

To enjoy surround effectively, all the speakers need to be connected and activated.

Dolby Digital

Used to reproduce multichannel sound tracks of the software encoded with Dolby Digital ().

Dolby Digital encoding method (discrete 5.1 channel digital audio format) records and digitally compresses the left front channel, right front channel, center channel, left rear channel, right rear channel, and Subwoofer channel signals (total 6 channels, but the Sub channel is counted as channel 0.1).

In addition, Dolby Digital enables stereo rear sounds, and sets the cutoff frequency of the rear treble at 20 kHz, compared to 7 kHz for Dolby Pro Logic. These facts result in better sound quality than Dolby Pro Logic.

When the system detects Dolby Digital signals, the DOLBY DIGITAL indicator lights up on the display.

DTS Digital Surround

Used to reproduce multichannel sound tracks of the software encoded with DTS Digital Surround ().

DTS Digital Surround is another discrete 5.1 channel digital audio format available on CD, LD, and DVD software.

Compared to Dolby Digital, audio compression rate is relatively low.

This fact allows DTS Digital Surround format to add breadth and depth to the reproduced sounds. As a result, DTS Digital Surround features natural, solid and clear sound.

When the system detects DTS Digital Surround signals, the DTS indicator lights up on the display.

Dolby Pro Logic II

Dolby Pro-Logic II is a new multi-channel playback format developed by Dolby Laboratories using feedback logic steering technology and offering improvements over conventional Dolby Pro Logic circuits.

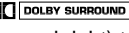
Dolby Pro Logic II can be used to decode not only sources recorded in Dolby Surround () but also regular stereo sources into five channels (front left, front right, center, surround left and surround right) to achieve surround sound.

Whereas with conventional Dolby Pro Logic the surround channel playback frequency band was limited, Dolby Pro Logic II offers a wider band range.

In addition, the surround channels were monaural (the surround left and right channels were the same) with previous Dolby Pro Logic, but with Dolby Pro Logic II they are stereo.

* Sources recorded in Dolby Surround

These are sources in which three or more channels of surround have been recorded as two channels of signals using Dolby Surround encoding technology.

Dolby Surround is used for the sound tracks of movies recorded on DVDs, LDs and video cassettes to be played on stereo VCRs, as well as for the stereo broadcast signals of FM radio, TV, satellite broadcasts and cable TV.

Decoding these signals with Dolby Pro Logic makes it possible to achieve multi-channel surround playback.

The signals can also be played on ordinary stereo equipment, in which case they provide normal stereo sound.

Manufactured under license from Dolby Laboratories. "Dolby," "Pro Logic," and the double-D symbol are trademarks of Dolby Laboratories. Confidential Unpublished Works. ©1992-1997 Dolby Laboratories, Inc. All rights reserved.

Manufactured under license from Digital Theater Systems, Inc. US Pat. No. 5,451,942 and other world-wide patents issued and pending. "DTS" and "DTS Digital Surround" are trademarks of Digital Theater Systems, Inc. ©1996 Digital Theater Systems, Inc. All rights reserved.

SETUP

Dolby Pro Logic II decoder

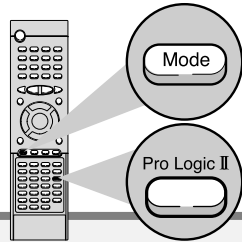

Dolby Pro Logic II

VCD CD

Dolby Pro Logic II is a new format for playing multichannel audio signals that offers improvements over conventional Dolby Pro Logic. It can be used to decode not only sources recorded in Dolby Surround, but also regular stereo sources into five channels (front left/right, center and surround left/right). In addition, various parameters can be set according to the type of source and the contents, so you can adjust the sound field with greater precision.

1

Press the **Function** button on the front panel to select the desired function.

- Select from FM → AM → DVD → DIGITAL IN → AUX 1 → AUX 2.

2

Press the **Pro Logic II** button.

- Each time the **Pro Logic II** button is pressed.

3

Press the DSP/DPL II **Mode** button.

- Each time the DSP/DPL II **Mode** button is pressed.

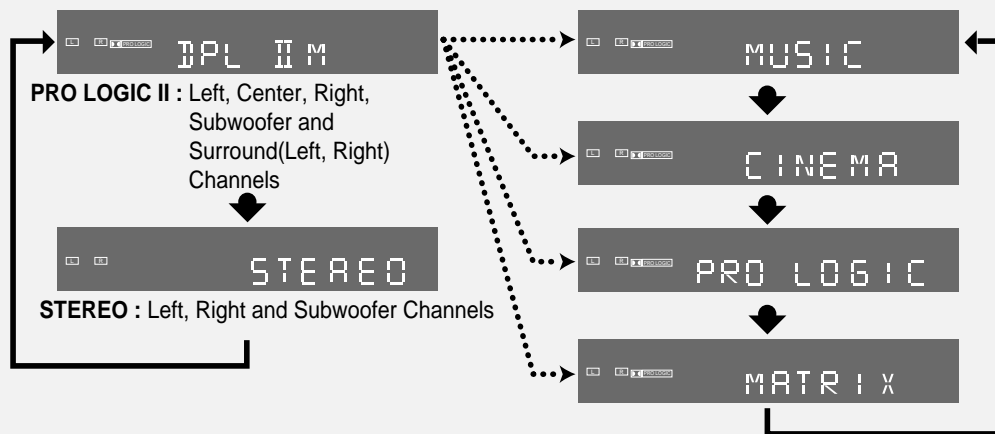

Pro Logic II Mode

Select one of the modes ("Music", "Cinema", "Pro Logic" or "MATRIX").

- The Music mode is recommended when listening to CDs or watching DVDs with mostly musical content.
- The Cinema mode is best when watching movies.
- The Pro Logic mode offers the same surround processing as original Pro Logic and is best used when the source contents are not of optimum quality.
- The Matrix mode is useful for when the audio is mono.

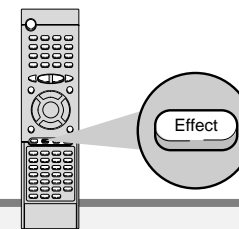

Dolby Pro Logic II Effect Function

This function works only in the DPL II M (Dolby Pro Logic II Music) Mode.

1

Press the DSP/DPL II **Effect** button.

2

Use the **Left/Right** (◀/▶) button to make adjustments.

- Each time the DSP/DPL II **Effect** button is pressed.

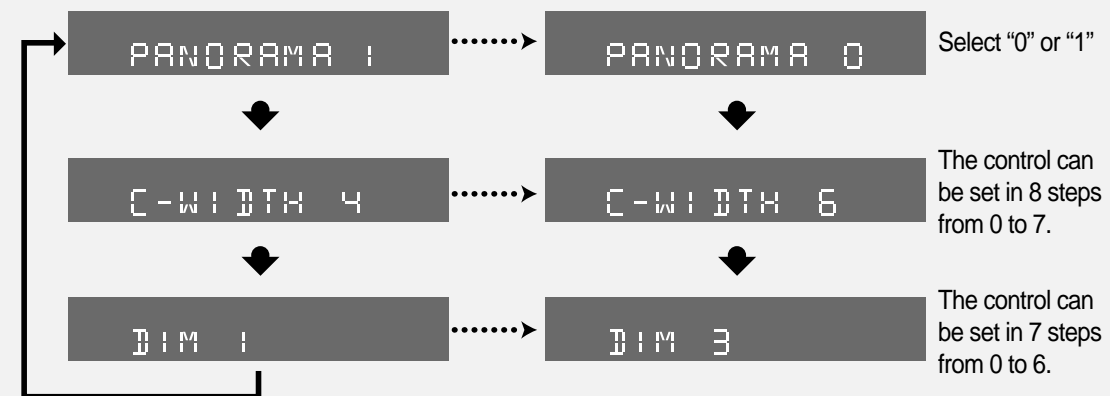

• Panorama Mode

This mode extends the front stereo image to include the surround speakers for an exciting "wraparound" effect with side wall imaging.

• Center Width Control

This control adjusts the center image so it may be heard only from the center speaker; only from the left/right speakers as a phantom image; or from all three front speakers to varying degrees.

• Dimension Control

This control gradually adjusts the soundfield either towards the front or towards the rear.



- When playing a DVD encoded in two or more channels, DOLBY PRO LOGIC II mode cannot be selected.

SETUP

DSP (Digital Signal Processor) Modes

DSP modes have been designed to simulate different acoustic environments. The sound heard in a hall, theater, pavilion, dance club, or live club consists of direct and indirect sound—early reflections and reflections from behind. Direct sounds reach the listener directly without any reflection. Indirect sounds are delayed by the distance of the ceiling and walls. These indirect sounds are an important element of the acoustic surround effect.

Press the DSP/DPL II Mode button.

- This function works only in the STEREO Mode.
- The following DSP modes are provided with this unit:

- ➔ **HALL** Provides a clear vocal and simulates the feeling of a concert hall.
- ➔ **THEATER** Simulates the feeling of a theater.
- ➔ **PAVILION** Simulates the spacious feeling of a pavilion with a high ceiling.
- ➔ **DANCE CLUB** Simulates the sound of a dance club with a throbbing bass beat.
- ➔ **LIVE CLUB** Simulates the feeling of a live music club with a low ceiling.

- These DSP modes can be used to add acoustic surround effects while reproducing stereo analog or linear PCM digital signals.
- When one of the DSP modes is selected, the DSP indicator lights up on the display.

DSP modes available according to the input signal format

O : Possible, X : Not possible

Surround	Multichannel Surround	DSP					(canceled)	
		HALL	THEATER	PAVILION	DANCE CLUB	LIVE CLUB	STEREO	
Input Signal format	Analog	X	O	O	O	O	O	O
	Linear PCM	X	O	O	O	O	O	O
	Dolby Digital	O	X	X	X	X	X	X
	DTS	O	X	X	X	X	X	X

To increase Effect level

To increase Effect level

Press the DSP/DPL II **Effect** button.

- The effect level can be set in steps from 1 to 4 EFFECT1 → EFFECT2 → EFFECT3 → OFF(DEFAULT). Each time the button is pressed the selection moves to the next effect.
- The higher the number, the stronger the DSP surround effect will be.

What is a Effect?
This sets the strength of the DSP mode.

Note • This function works only in the DSP Mode.

Adjusting DSP Sound Parameters

You can fine-adjust DSP modes more minutely by changing three parameters—room, liveness, and reverberation.

1 Press the DSP/DPL II **Mode** button.

2

Press the **Sound Edit** button.
• Each time you press the button, the indication on the display changes as follows:

3

Press the **Left/Right** (◀ / ▶) button to adjust the DSP sound parameter.

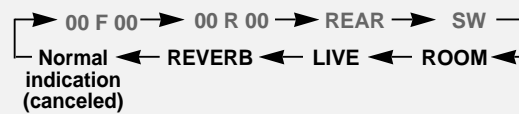

ROOM : To adjust the resonance based on the room size. The larger this value is, the more effective the resonance is (from 04 to 16 by 2 steps).

LIVE (Liveness) : To adjust the liveness. The larger this value is, the more liveness is obtained (from 04 to 16 by 2 steps).

REVERB (Reverberation) : To adjust the reverberation time of the sound (from 0.0 msec to 1.6 msec by 0.2 msec steps).

Note • This function works only in the DSP Mode.

Listening to the Radio

You can listen to the chosen band (FM, AM broadcast stations) by using either the automatic or manual tuning operation.

Remote Control Unit

1

Press the **Tuner(Band)** button.

- The selection toggles back and forth between "FM" and "AM" each time the **Tuner(Band)** button is pressed.

Main Unit

1

Press the **Function** button to select the desired band (FM, AM).

2

Select a broadcast station.

Auto Station 1 When the **I◀▶I** button is pressed, a preset broadcast station is selected.

Auto Station 2 Hold in the **◀▶** button. Automatic searching begins, and then stops when a station is tuned in.

Manual Station Press the **◀▶** button to tune to the chosen station. The frequency changes incrementally in either direction each time the corresponding button is pressed.

To Listen in Mono/Stereo



Press the **MO/ST** button. (FM only)

- The selection toggles back and forth between "STEREO" and "MONO" each time the **MO/ST** button is pressed.
- In a poor reception areas, select Mono mode for a clear, interference-free broadcast.

Presetting stations

You can store up to:

- ◆ 15 FM stations
- ◆ 15 AM stations
- **FM** Frequency Modulation
- **AM(MW)** Medium Wave

Example: Presetting FM 89.1 in the memory

1

Press the **Tuner(Band)** button and select the FM band.

2

Select **MANUAL** by pressing the **Stop (■)** button on the main unit.

3

Use the **◀▶** and **▶▶** button to tune to 89.1

• The selection toggles back and forth between "FM" and "AM" each time the **Tuner(Band)** button is pressed.

FM 101.21 MHz

MANUAL

FM 89.10 MHz

4

Press the **Program** button on the remote control, FM1 will flash. If you want to save 89.1 to FM1, press Program again.

5

If you want to save 89.1 to another preset location(FM2~FM15), press **◀▶** or **▶▶**, then press **Program** to save it to that location.

6

To preset other stations, follow steps 1~5 again.

FM1 89.10 MHz

FM2 89.10 MHz

FM 89.10 MHz

To tune in a preset station

See the previous page.

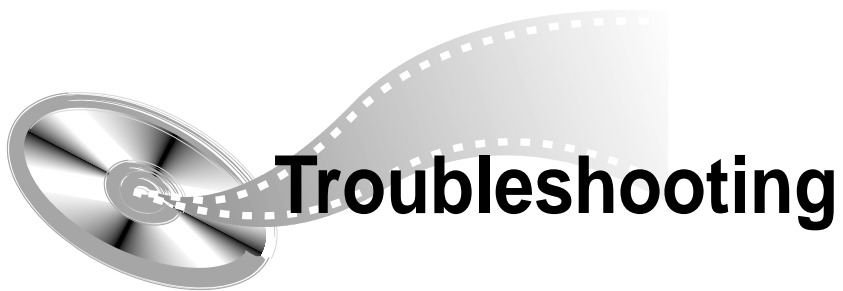

Troubleshooting

Problem	Check
The disc tray does not open.	<ul style="list-style-type: none"> • Is the disc installed with the label side facing up? • Is the power cord plugged securely into the power outlet? • Turn off the power to the unit by pressing the Power (⏻) button and turn it back on.
Disc does not play.	<ul style="list-style-type: none"> • Check the region number of the DVD. • DVD discs purchased abroad may not be playable. • This player cannot play CD-ROMs, DVD-ROMs, etc. • Check the rating level of the DVD.
Playback does not start immediately when the Play/Pause button is pressed.	<ul style="list-style-type: none"> • Check whether the disc has any scratch marks or is deformed.
No sound is produced.	<ul style="list-style-type: none"> • No sound is heard during high-speed playback, slow playback, and step motion playback modes. • Are the speakers properly connected? Is the speaker Setup correctly customized? • Is the disc severely damaged? The disc may be dirty. Wipe off fingerprints or dirt.
Sound can be heard only from a few speakers and not all six.	<ul style="list-style-type: none"> • When listening to a CD or radio, sound is output to the front speakers only (L/R). Select the "PRO LOGIC" option by pressing the Pro Logic button on the remote control unit to use all six speakers. • Check whether your DVD disc is 5.1 CH compatible.
Picture does not appear; sound is not produced; the disc tray opens 2-5 seconds later.	<ul style="list-style-type: none"> • Was the player moved suddenly from a cold place to a warm one? When condensation forms inside the player, remove the disc and let the player stand for 1 or 2 hours with the power on. (You can use the player after the condensation disappears.)
Sound quality is irregular.	<ul style="list-style-type: none"> • Are the speaker cables loose? • Is there any dirt or debris at the end of the speaker connector?
Dolby Digital 5.1 Channel Surround Sound is not being reproduced.	<ul style="list-style-type: none"> • Does the disc being played show the "Dolby Digital 5.1CH" mark ? 5.1-channel sound is reproduced only if the disc is recorded with 5.1 channel sound. • Is the DVD player connected to the proper speakers?

Problem	Check
<ul style="list-style-type: none"> • The disc revolves but no picture appears. • Picture shows interference and quality is poor. 	<ul style="list-style-type: none"> • Is the TV power turned on? • Are the video cables properly connected? • Is it the player in PAUSE mode? • Is there any dirt on the disc, or is the disc damaged? • It may not be possible to play some DVD discs due to poor manufacture. • When a dark scene changes to a bright scene during playback, the screen may flicker vertically. Some disturbance is normal.
Remote control unit does not operate.	<ul style="list-style-type: none"> • Is the remote control being used within the appropriate distance and angle of operation for the unit? • Are there any obstacles between the remote control unit and the remote control sensor? • Are the batteries dead? Is it time to replace the batteries with new ones?
Audio or subtitle language does not operate.	<ul style="list-style-type: none"> • The audio or subtitle language features does not operate with DVDs that do not include multiple audio or subtitle languages.
The Menu button is pressed but the Menu screen does not appear.	<ul style="list-style-type: none"> • Is the remote control being used within the appropriate distance and angle of operation for the unit? • Are the batteries dead? • Does the disc have a Menu?
The screen ratio cannot be changed.	<ul style="list-style-type: none"> • You can play 16:9 wide DVDs in 16:9 WIDE mode, 4:3 LETTER BOX mode or 4:3 PAN-SCAN mode; but 4:3 encoded DVDs only show in 4:3 ratio. Refer to the DVD disc jacket and then select the appropriate function.
The desired radio station cannot be tuned in.	<ul style="list-style-type: none"> • Is the antenna installed properly? • When the antenna's input signal is weak, install an external FM antenna in an area with good reception quality.
The system is malfunctioning (the system does not work or no sound).	<ul style="list-style-type: none"> • While the player is in the stop mode, hold the Stop (■) button down on the main unit for over 5 seconds."INITIAL" appears on the display and all settings will return to the Factory Preset condition. The RESET function erases all settings; do not use this function unless necessary.

Cautions on Handling and Storing Discs

Small scratches on the disc may reduce sound and picture quality or cause breaks in playback. Be especially careful not to scratch discs when handling them.

Handling and Storing Discs

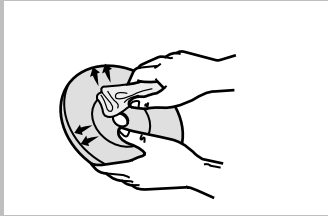

When you get fingerprints or dirt on the disc, clean it with a mild detergent diluted in water and wipe with a soft cloth.

- When cleaning, wipe gently from the inside to the outside of the disc.

Note

Condensation may form if warm air comes into contact with cold parts inside the player. When condensation forms inside the player, the player may not operate correctly. If this occurs, remove the disc and let the player stand for 1 or 2 hours with the power on.

Disc Storage

Do not keep in direct sunlight

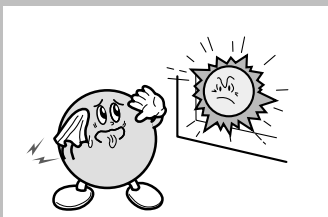

Keep in a cool ventilated area

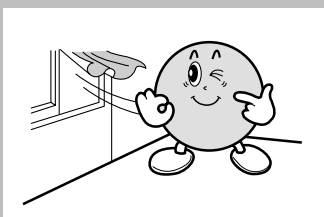

Keep in a clean Protection jacket. Store vertically.

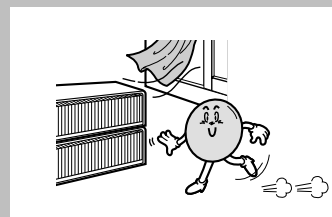

- Do not allow the discs to become contaminated with dirt.
- Do not load cracked discs or discs that are scratched.

Disc Type and Protection

Usable Discs

Disc Types	Marks	Recording Types	Disc Size	Max. Playing Time
DVD		Audio + Video	12cm	Approx. 240 min. (Single-sided) Approx. 480 min. (Double-sided)
			8cm	Approx. 80 min. (Single-sided) Approx. 160 min. (Double-sided)
VIDEO-CD		Audio + Video	12cm	74 min.
			8cm	20 min.
AUDIO-CD		Audio	12cm	74 min.
			8cm	20 min.

Dolby Digital disc	DTS Disc	Digital Audio disc	Stereo disc	NTSC broadcast system in USA, Canada, Japan, South Korea, etc..	MP3 disc

MISCELLANEOUS

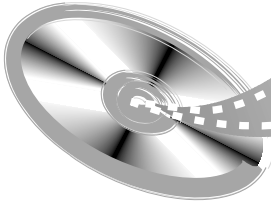

Specifications

GENERAL	Power Consumption	160W
	Weight	8.3Kg
	Dimensions (W x H x D)	430mm x 80mm x 365mm
	Operating Temperature Range	+5°C~+35°C
	Operating Humidity Range	10% ~ 75%
FM	Usable Sensitivity	10dB
	S/N Ratio	60dB
	Distortion	0.5%
AM	Usable Sensitivity	54dB
	S/N Ratio	40dB
	Distortion	2%
VIDEO INPUT	Component Video	Y:1.0Vp-p(75Ω load), Pr:0.70Vp-p(75Ω load)
		Pb:0.70Vp-p(75Ω load)
VIDEO OUTPUT	Composite Video	1.0Vp-p(75Ω load)
	Component Video	Y:1.0Vp-p(75Ω load)
		Pr:0.70Vp-p(75Ω load)
		Pb:0.70Vp-p(75Ω load)
	S-VIDEO	Luminance Signal: 1.0Vp-p(75Ω load)
Color Signal: 0.286Vp-p(75Ω load)		
AMPLIFIER	Front speaker output	100W x 2(4Ω) / 75W x 2(8Ω), Distortion 10%
	Center speaker output	100W (4Ω) / 75W (8Ω), Distortion 10%
	Rear speaker output	100W x 2(4Ω) / 75W x 2(8Ω), Distortion 10%
	Frequency range	20Hz~20KHz
	S/N Ratio	75dB
	Channel separation	50dB
	Input sensitivity	(AUX)500mV



ELECTRONICS

Samsung Limited Warranty

Samsung Electronics Canada Inc. (SECA), warrants that this product is free from defective material and workmanship.

SECA further warrants that if this product fails to operate properly within the specified warranty period and the failure is due to improper workmanship or defective material SECA will repair or replace the product at its option.

All warranty repairs must be performed by a SECA authorized service centre. (The name and address of the location nearest you can be obtained by calling toll free 1-800-726-7864 or visiting our web site at www.samsung.ca)

Labour	Parts
one (1) year (carry-in)	one (1) year

On carry-in models, transportation to and from the service centre is the customer's responsibility.

The original dated sales receipt must be retained by the customer and is the only acceptable proof of purchase. It must be presented to the authorized service centre at the time service is requested.

Exclusions

This warranty does not cover damage due to accident, fire flood and/or other acts of God; misuse, incorrect line voltage, improper installation, improper or unauthorized repairs, commercial use, or damage that occurs in shipping. Exterior and interior finish, lamps and glass are not covered under this warranty. Customer adjustments which are explained in the instruction manual are not covered under the terms of this warranty.

This warranty will automatically be voided for any unit found with a missing or altered serial number. This warranty is valid only on products purchased and used in Canada.

MISCELLANEOUS

Free Manuals Download Website

<http://myh66.com>

<http://usermanuals.us>

<http://www.somanuals.com>

<http://www.4manuals.cc>

<http://www.manual-lib.com>

<http://www.404manual.com>

<http://www.luxmanual.com>

<http://aubethermostatmanual.com>

Golf course search by state

<http://golfingnear.com>

Email search by domain

<http://emailbydomain.com>

Auto manuals search

<http://auto.somanuals.com>

TV manuals search

<http://tv.somanuals.com>