

HT-D550
HT-D553
HT-D555

Digital Home Entertainment System user manual

Imagine the possibilities

Thank you for purchasing this Samsung product.

To receive more complete service,
please register your product at

www.samsung.com/register



Safety Information

Safety Warnings

TO REDUCE THE RISK OF ELECTRIC SHOCK, DO NOT REMOVE THE COVER(OR BACK). NO USER-SERVICEABLE PARTS ARE INSIDE. REFER SERVICING TO QUALIFIED SERVICE PERSONNEL.

	CAUTION RISK OF ELECTRIC SHOCK DO NOT OPEN	
The lighting flash and Arrowhead within Triangle is warning sign alerting you of dangerous voltage Inside the product.	CAUTION : TO REDUCE THE RISK OF ELECTRIC SHOCK, DO NOT REMOVE COVER (OR BACK) NO USER SERVICEABLE PARTS INSIDE. REFER SERVICING TO QUALIFIED SERVICE PERSONNEL.	The explanation point within the triangle is a warning sign alerting you of important instructions accompanying the product.

WARNING

- To reduce the risk of fire or electric shock, do not expose this appliance to rain or moisture.
- To prevent injury, this apparatus must be securely attached to the floor/wall in accordance with the installation instructions.

CLASS 1 LASER PRODUCT
KLASSE 1 LASER PRODUKT
LUOKAN 1 LASER LAITE
KLASS 1 LASER APPARAT
PRODUCTO LÁSER CLASE 1

CLASS 1 LASER PRODUCT

- This product is classified as a CLASS 1 LASER product. Use of controls, adjustments or performance of procedures other than those specified herein may result in hazardous radiation exposure.
- Complies with 21CFR 1040.10 except for deviations pursuant to Laser Notice No. 50, dated 24, 2007

CAUTION

- Apparatus shall not be exposed to dripping or splashing and no objects filled with liquids, such as vases, shall be placed on the apparatus.
- The Mains plug is used as a disconnect device and shall stay readily operable at any time.

DANGER

VISIBLE AND INVISIBLE LASER RADIATION WHEN OPEN. AVOID DIRECT EXPOSURE TO BEAM. (FDA 21 CFR)

CAUTION

- CLASS 3B VISIBLE AND INVISIBLE LASER RADIATION WHEN OPEN. AVOID EXPOSURE TO THE BEAM (IEC 60825-1)
- THIS PRODUCT UTILIZES A LASER. USE OF CONTROLS OR ADJUSTMENTS OR PERFORMANCE OF PROCEDURES OTHER THAN THOSE SPECIFIED HEREIN MAY RESULT IN HAZARDOUS RADIATION EXPOSURE. DO NOT OPEN COVER AND DO NOT REPAIR YOURSELF. REFER SERVICING TO QUALIFIED PERSONNEL.

This product satisfies FCC regulations when shielded cables and connectors are used to connect the unit to other equipment. To prevent electromagnetic interference with electric appliances, such as radios and televisions, use shielded cables and connectors for connections.

FCC NOTE (for U.S.A)

This equipment has been tested and found to comply with the limits for a Class B digital device, pursuant to Part 15 of the FCC Rules. These limits are designed to provide reasonable protection against harmful interference in a residential installation.

This equipment generates, uses and can radiate radio frequency energy and, if not installed and used in accordance with the instructions, may cause harmful interference to radio communications. However, there is no guarantee that interference will not occur in a particular installation.

If this equipment does cause harmful interference to radio or television reception, which can be determined by turning the equipment off and on, the user is encouraged to try to correct the interference by one or more of the following measures:

- Reorient or relocate the receiving antenna.
- Increase the separation between the equipment and receiver.
- Connect the equipment into an outlet on a circuit different from that to which the receiver is connected.
- Consult the dealer or an experienced radio/TV technician for help.

CAUTION : FCC regulations state that any unauthorized changes or modifications to this equipment may void the user's authority to operate it.

Important Safety Instructions

Read these operating instructions carefully before using the unit. Follow all the safety instructions listed below. Keep these operating instructions handy for future reference.

- 1) Read these instructions.
- 2) Keep these Instructions.
- 3) Heed all warnings.
- 4) Follow all instructions.
- 5) Do not use this apparatus near water.
- 6) Clean only with dry cloth.
- 7) Do not block any ventilation openings. Install in accordance with the manufacturer's instructions.
- 8) Do not install near any heat sources such as radiators, heat registers, stoves, or other apparatus (including amplifiers) that produce heat.
- 9) Do not defeat the safety purpose of the polarized or grounding-type plug. A polarized plug has two blades with one wider than the other. A grounding type plug has two blades and a third grounding prong. The wide blade or the third prong are provided for your safety. If the provided plug does not fit into your outlet, consult an electrician for replacement of the obsolete outlet.
- 10) Protect the power cord from being walked on or pinched particularly at plugs, convenience receptacles, and the point where they exit from the apparatus.
- 11) Only use attachment/accessories specified by the manufacturer.
- 12) Use only with the cart, stand, tripod, bracket, or table specified by the manufacturer, or sold with the apparatus. When a cart is used, use caution when moving the cart/apparatus combination to avoid injury from tip-over.
- 13) Unplug this apparatus during lightning storms or when unused for long periods of time.
- 14) Refer all servicing to qualified service personnel. Servicing is required when the apparatus has been damaged in any way, such as power supply cord or plug is damaged, liquid has been spilled or objects have fallen into the apparatus, the apparatus has been exposed to rain or moisture, does not operate normally, or has been dropped.



Precautions

- Ensure that the AC power supply in your house complies with the identification sticker located on the back of your product.
- Install your product horizontally, on a suitable base (furniture), with enough space around it for ventilation (3~4 inches).
- Do not place the product on amplifiers or other equipment which may become hot. Make sure the ventilation slots are not covered.
- Do not stack anything on top of the product.
- Before moving the product, ensure the Disc Insert Hole is empty.
- In order to disconnect the product completely from the power supply, remove the AC plug from the wall outlet, especially when left unused for a long period of time.
- During thunderstorms, disconnect the AC plug from the wall outlet. Voltage peaks due to lightning could damage the product.
- Do not expose the product to direct sunlight or other heat sources. This could lead to overheating and malfunction of the product.
- Protect the product from moisture, and excess heat or equipment creating strong magnetic or electric fields (i. e. speakers.).
- Disconnect the power cable from the AC supply if the product malfunctions.
- Your product is not intended for industrial use. Use of this product is for personal use only.
- Condensation may occur if your product or disc has been stored in cold temperatures. If transporting the product during the winter, wait approximately 2 hours until the product has reached room temperature before using.
- The batteries used with this product contain chemicals that are harmful to the environment. Do not dispose of batteries in the general household trash.

Accessories

Check for the supplied accessories below.

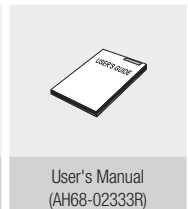
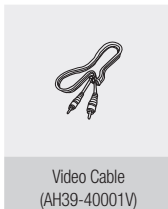

Safety Information

Cautions on Handling and Storing Discs

Small scratches on the disc may reduce sound and picture quality or cause skipping.

Be especially careful not to scratch discs when handling them.

Holding discs

- Do not touch the playback side of the disc.
- Hold the disc by the edges so that fingerprints will not get on the surface.
- Do not stick paper or tape on the disc.



Disc Storage

- Do not keep in direct sunlight
- Keep in a cool ventilated area
- Keep in a clean Protection jacket.
Store vertically.

NOTE

- Do not allow the discs to become contaminated with dirt.
- Do not load cracked or scratched discs.

Handling and Storing Discs

If you get fingerprints or dirt on the disc, clean it with a mild detergent diluted in water and wipe with a soft cloth.

- When cleaning, wipe gently from the inside to the outside of the disc

NOTE

- Condensation may form if warm air comes into contact with cold parts inside the product. When condensation forms inside the product, it may not operate correctly. If this occurs, remove the disc and let the product stand for 1 or 2 hours with the power on.

License

- **ABOUT DIVX VIDEO:** DivX® is a digital video format created by DivX, Inc. This is an official DivX Certified® device that plays DivX video. Visit www.divx.com for more information and software tools to convert your files into DivX video.



ABOUT DIVX VIDEO-ON-DEMAND: This DivX Certified® device must be registered in order to play purchased DivX Video-on-Demand (VOD) movies. To obtain your registration code, locate the DivX VOD section in your device setup menu. Go to vod.divx.com for more information on how to complete your registration.

DivX Certified® to play DivX® video, including premium content DivX®, DivX Certified® and associated logos are trademarks of DivX, Inc. and are used under license.

Covered by one or more of the following U.S. patents : 7,295,673; 7,460,668; 7,515,710; 7,519,274

- HDMI, the HDMI Logo, and High-Definition Multimedia Interface are trademarks or registered trademarks of HDMI Licensing LLC in the United States and other countries.
- This item incorporates copy protection technology that is protected by U. S. patents and other intellectual property rights of Rovi Corporation. Reverse engineering and disassembly are prohibited.
- **iPod is a trademark of Apple Inc., registered in the U.S. and other countries.**
iPhone is a trademark of Apple Inc.
- Dolby and the double-D symbol are registered trademarks of Dolby Laboratories.



Copyright

© 2011 Samsung Electronics Co., Ltd. All rights reserved.

Copy Protection

- Many DVD discs are encoded with copy protection. Because of this, you should only connect your product directly to your TV, not to a VCR. Connecting to a VCR results in a distorted picture from copy-protected DVD discs.

Contents

SAFETY INFORMATION

2

- 2 Safety Warnings
- 3 Important Safety Instructions
- 3 Precautions
- 3 Accessories
- 4 Cautions on Handling and Storing Discs
- 4 License
- 4 Copyright
- 4 Copy Protection

GETTING STARTED

7

- 7 Features
- 7 Icons that will be used in manual
- 8 Disc Types and Characteristics
- 11 Description
 - 11 Front Panel
 - 12 Rear Panel
- 13 Remote control

CONNECTIONS

15

- 15 Connecting the Speakers
- 19 Connecting the Optional Wireless Receiver Module
- 21 Connecting the Video Out to your TV
- 23 Connecting the FM Antenna
- 23 Connecting Audio from External Components

SETUP

25

- 25 Before Starting (Initial Setting)
- 25 Setting the Setup menu
- 26 Display
 - 26 TV Aspect
 - 26 BD Wise
 - 26 Resolution
 - 26 HDMI Format
- 27 Audio
 - 27 Speaker Setting
 - 28 ASC (Auto Sound Calibration) Setting
 - 29 DRC (Dynamic Range Compression)
 - 29 AUDIO SYNC
 - 30 HDMI AUDIO
 - 30 User EQ
 - 30 Audio Return Ch.
- 30 System
 - 30 Initial Setting
 - 30 DivX(R) Registration
 - 30 DivX(R) Deactivation
- 31 Language
- 31 Security
 - 31 Parental Rating
 - 31 Change Password
- 31 Support
 - 31 Product Information

Contents

BASIC FUNCTIONS

32

- 32 Disc Playback
- 32 Audio CD(CD-DA)/MP3/WMA Playback
- 33 JPEG File Playback
- 33 Using the Playback Function
- 37 Sound Mode
- 39 Listening to Radio

ADVANCED FUNCTIONS

40

- 40 USB Function
- 40 Using an iPod/iPhone
- 42 USB Recording

OTHER INFORMATION

43

- 43 Troubleshooting
- 44 Country code list
- 45 Index
- 46 Specifications

- Figures and illustrations in this User Manual are provided for reference only and may differ from actual product appearance.

Getting Started

Features

Playback of many disc types

This product allows you to play back various discs, including DVD-Video, DVD±R/±RW, CD-DA, CD-R/-RW, MP3-CD, WMA-CD and DivX.

USB Host support

You can enjoy media files such as pictures, movies and music saved on a MP3 player, digital camera or USB memory stick by connecting the storage device to the USB port of the product.

Dolby Pro Logic II

Dolby Pro Logic II is a form of multi-channel audio signal decoding technology that improves upon existing Dolby Pro Logic.

HDMI

HDMI transmits DVD video and audio signals simultaneously, and provides a clearer picture.

The 1080p(Full HD) resolution provides even clearer pictures.

iPod & iPhone support

If the system is connected to iPod player using the iPod/iPhone specific USB cable, you can play the music files in iPod/iPhone through the connected speakers.

BD Wise

BD Wise automatically adjusts BD Wise-compliant Samsung products to the optimal settings between them. This feature is enabled only if BD Wise-compliant Samsung products are connected to each other using an HDMI cable.









AUDIO SYNC Function

Video may lag behind the audio if the product is connected to a digital TV.

To compensate for this, you can adjust the audio delay time to sync up with the video.

Icons that will be used in manual

Make sure to check the following terms before reading the user manual.

Icon	Term	Definition
	DVD	This involves a function available with DVD-Video or DVD±R/±RW discs that have been recorded and finalized in Video Mode.
	CD	This involves a function available with a data CD (CD DA, CD-R/-RW).
	MP3	This involves a function available with CD-R/-RW discs.
	JPEG	This involves a function available with CD-R/-RW discs.
	DivX	This involves a function available with MPEG4 discs. (DVD±R/±RW, CD-R/-RW)
	CAUTION	This involves a case where a function does not operate or settings may be canceled.
	NOTE	This involves tips or instructions on the page that help each function operate.
	Shortcut Key	This function provides direct and easy access pressing the button on the remote control.

Getting Started



Disc Types and Characteristics

Region Code

The product and the discs are coded by region. These regional codes must match in order for the disc to play. If the codes do not match, the disc will not play.

Disc Type	Region Code	Area
DVD-VIDEO		The U.S., U.S. territories and Canada
		Europe, Japan, the Middle East, Egypt, South Africa, Greenland
		Taiwan, Korea, the Philippines, Indonesia, Hong Kong
		Mexico, South America, Central America, Australia, New Zealand, Pacific Islands, Caribbean
		Russia, Eastern Europe, India, most of Africa, North Korea, Mongolia
		China

Disc types that can be played

Disc Types & Mark (Logo)	Recorded Signals	Disc Size	Max. Playing Time
 DVD-VIDEO	AUDIO + VIDEO	5 inches	Approx. 240 min. (single-sided)
		3 1/2 inches	Approx. 480 min. (double-sided)
 AUDIO-CD	AUDIO	5 inches	Approx. 80 min. (single-sided)
		3 1/2 inches	Approx. 160 min. (double-sided)
 DivX	AUDIO + VIDEO	5 inches	74 min.
		3 1/2 inches	20 min.
		5 inches	—
		3 1/2 inches	—

Do not use the following type of discs!

- LD, CD-G, CD-I, CD-ROM, DVD-ROM and DVD-RAM discs cannot be played in this unit. If such discs are played, a <WRONG DISC FORMAT> message appears on the TV screen.
- DVD discs purchased abroad may not play on this product. If such discs are played, a <Wrong Region. Please check Disc.> message appears on the TV screen.

Disc Types And Disc Format

This product does not support Secure (DRM) Media files.

CD-R Discs

- Some CD-R discs may not be playable depending on the disc recording device (CD-Recorder or PC) and the condition of the disc.
- Use a 650MB/74 minute CD-R disc. Do not use CD-R discs over 700MB/80 minutes as they may not be played back.
- Some CD-RW (Rewritable) media, may not be playable.
- Only CD-Rs that are properly "closed" can be fully played. If the session is closed but the disc is left open, you may not be able to fully play the disc.

CD-R MP3 Discs

- Only CD-R discs with MP3 files in ISO 9660 or Joliet format can be played.
- MP3 file names should contain no blank spaces or special characters (. / = +).
- Use discs recorded with a compression/decompression data rate greater than 128Kbps.
- Only files with the ".mp3" and ".MP3" extensions can be played.
- Only a consecutively written multisession disc can be played. If there is a blank segment in the Multisession disc, the disc can be played only up to the blank segment.
- If the disc is not closed, it will take longer to begin playback and not all of the recorded files may be played.
- For files encoded in Variable Bit Rate (VBR) format, i.e. files encoded in both low bit rate and high bit rate (e.g., 32Kbps ~ 320Kbps), the sound may skip during playback.
- A maximum of 500 tracks can be played per CD.
- A maximum of 300 folders can be played per CD.

CD-R JPEG Discs

- Only files with the "jpg" extensions can be played.
- If the disc is not closed, it will take longer to start playing and not all of the recorded files may be played.
- Only CD-R discs with JPEG files in ISO 9660 or Joliet format can be played.
- JPEG file names should be 8 characters or less in length and contain no blank spaces or special characters (. / = +).
- Only a consecutively written multisession disc can be played. If there is a blank segment in the multisession disc, the disc can be played only up to the blank segment.
- A maximum of 999 images can be stored on a folder.
- When playing a Kodak/Fuji Picture CD, only the JPEG files in the picture folder can be played.
- Picture discs other than Kodak/Fuji Picture CDs may take longer to start playing or may not play at all.

DVD±R/±RW, CD-R/RW Discs

- Software updates for incompatible formats are not supported.
(Example : QPEL, GMC, resolutions higher than 800 x 600 pixels, etc.)

- If a DVD-R/-RW disc has not been recorded properly in DVD Video format, it will not be playable.

DivX (Digital internet video express)

DivX® is a video file format developed by DivX, Inc and is based on MPEG4 compression technology to provide audio and video data over the Internet in real-time.

MPEG4 is used for video encoding and MP3 for audio encoding, enabling to watch a movie at near DVD-quality video and audio.

Supported Formats (DivX)

This product only supports the following media formats. If both video and audio formats are not supported, the user may experience problems such as broken images or no sound.

Supported Video Formats

Format	Supported Versions
AVI	DivX3.11~DivX5.1, XviD
WMV	V1/V2/V3/V7

Supported Audio Formats

Format	Bit Rate	Sampling Frequency
MP3	80~320kbps	44.1khz
WMA	56~128kbps	
AC3	128~384kbps	44.1/48khz
DTS	1.5Mbps	44.1khz

- DivX files, including audio and video files, created in the DTS format can only support up to 6Mbps.
- Aspect Ratio : Although the default DivX resolution is 640x480 pixels, this product supports up to 720x480 pixels. TV screen resolutions higher than 800 will not be supported.
- When you play a disc whose sampling frequency is higher than 48khz or 320kbps, you may experience shaking on the screen during playback.
- Sections with a high frame rate might not be played while playing a DivX file.
- Since this product only provides encoding formats authorized by DivX Networks, Inc., a DivX file created by the user might not play.

Getting Started

Notes on USB connection

Supported devices: USB storage media, MP3 player, digital camera

- 1) If a folder or file name is longer than 10 characters, it may not properly display or operate.
- 2) A subtitle file bigger than 300KB may not be properly displayed.
- 3) A certain USB/digital camera device, USB card reader is not supported.
- 4) FAT16 and FAT32 file systems are supported.
- 5) Photo (JPEG), music (MP3, WMA) and video file should have their names in Korean or English. Otherwise, the file may not played.
- 6) Connect directly to the product's USB port. Connecting through another cable may raise problems with USB compatibility.
- 7) Inserting more than one memory device to a multi-card reader may not operate properly.
- 8) PTP protocol for digital camera is not supported.
- 9) Do not disconnect USB device during a "Reading" process.
- 10) Bigger the image resolution, the longer the delay to displaying.
- 11) DRM applied MP3/WMA or video files downloaded from a commercial site are not played back.
- 12) External HDD device is not supported.
- 13) Supported file formats

Format	Still Picture	Music		Movie			
		File name	File extension	Bit rate	Version	Pixel	Sampling Frequency
File name	JPG	MP3	WMA	WMV	DivX		
File extension	JPG .JPEG	.MP3	.WMA	.WMV	.AVI		
Bit rate	-	80~320 kbps	56~128 kbps	4Mbps	4Mbps		
Version	-	-	V8	V1,V2, V3,V7	DivX3.11~ DivX5.1, XviD		
Pixel	640x480	-	-	720x480			
Sampling Frequency	-	44.1kHz	44.1kHz	44.1kHz~ 48kHz			

Description

Front Panel

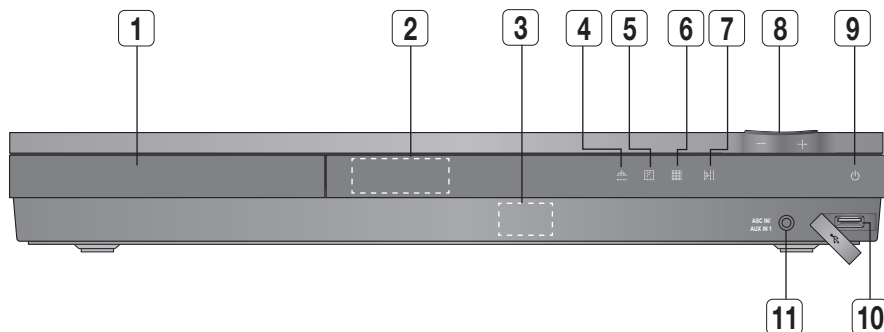

1	DISC TRAY	Insert disc here.
2	DISPLAY	Displays the playing status, time, etc.
3	REMOTE CONTROL SENSOR	Detects signals from the remote control.
4	OPEN/CLOSE BUTTON (⏏)	Opens and closes the disc tray.
5	FUNCTION BUTTON (⏏)	The mode switches as follows : DVD/CD → D.IN → AUX 1 → AUX 2 → USB → REMOTE IPOD → IPOD → FM
6	STOP BUTTON (⏏)	Stops disc playback.
7	PLAY / PAUSE BUTTON (⏏)	Plays a disc or pauses playback.
8	VOLUME CONTROL BUTTON (⏏, ⏏)	Volume adjustment.
9	POWER BUTTON (⏏)	Turns the product on and off.
10	USB PORT	Connect here and play files from external USB storage devices such as MP3 players, USB flash memory, etc.
11	ASC IN / AUX IN 1 CONNECTOR	Connect external components such as an MP3 player. Connect to use the ASC (Auto Sound Calibration) function.

Getting Started

Rear Panel

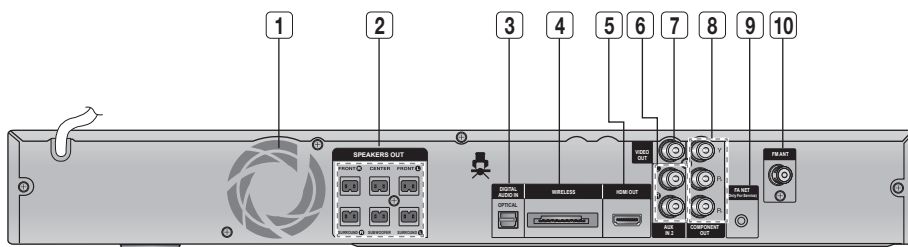

1	COOLING FAN	The fan always revolves when the power is on. Ensure a minimum of 10cm of clear space on all sides of the fan when installing the product.
2	SPEAKERS OUTPUT CONNECTORS	Connect the front, center, surround speakers and subwoofer.
3	EXTERNAL DIGITAL OPTICAL IN JACK (DIGITAL AUDIO IN)	Use this to connect external equipment capable of digital output.
4	TX CARD CONNECTION (WIRELESS)	The TX card enables communication between the product and the wireless receiver module.
5	HDMI OUT JACK	Using an HDMI cable, connect this HDMI output jack to the HDMI input jack on your TV for the best quality picture.
6	AUX IN 2 JACKS	Connect to the 2CH Analog output of an external device (such as a VCR).
7	VIDEO OUT JACK	Connect your TV's Video Input jack (VIDEO IN) to the VIDEO OUT jack.
8	COMPONENT VIDEO OUTPUT JACKS	Connect a TV with Component video inputs to these jacks.
9	FA NET (Only for Service)	Used for the service repair.
10	FM ANTENNA JACK	Connect the FM antenna.

Remote control

Tour of the Remote Control

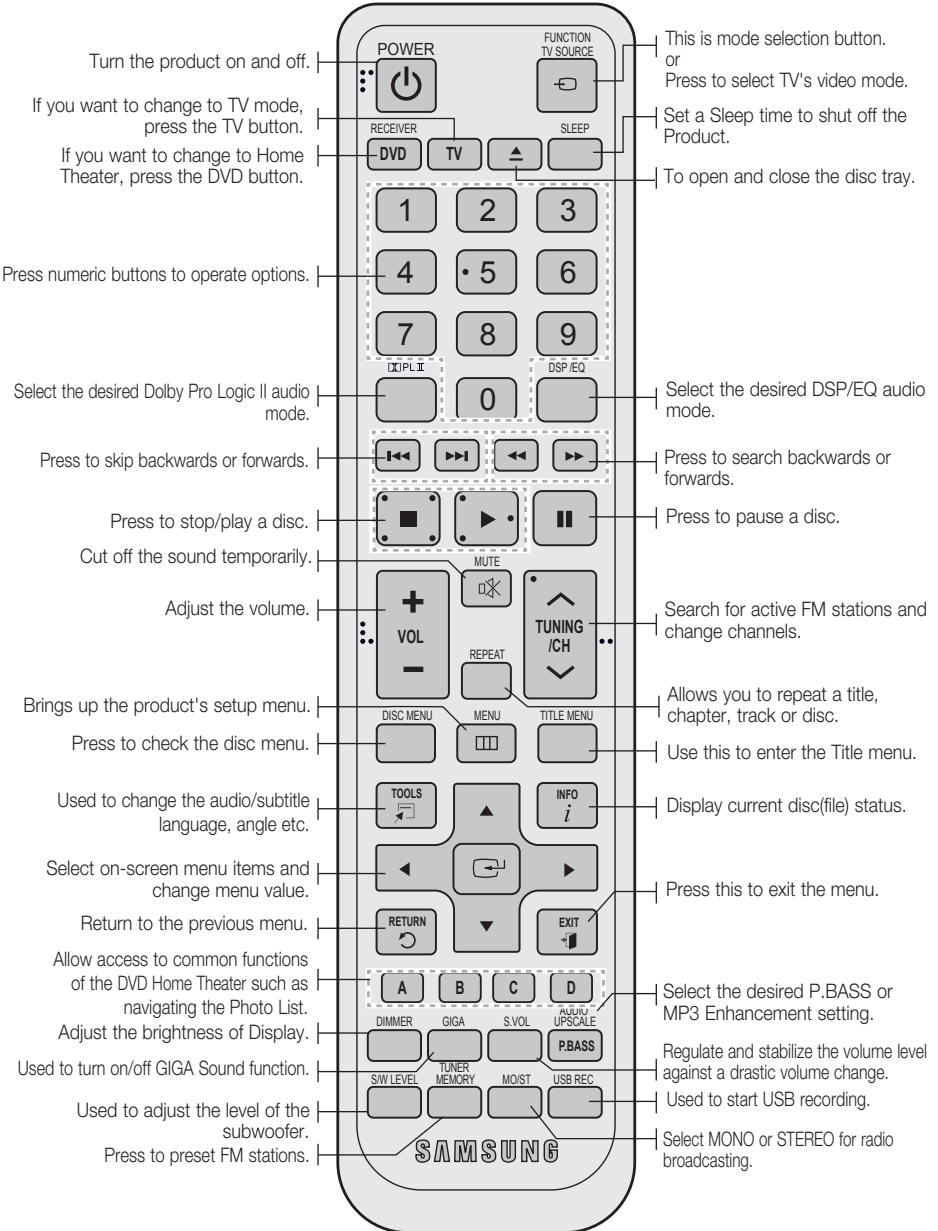

Getting Started

Installing batteries in the Remote Control

* Battery size: AAA

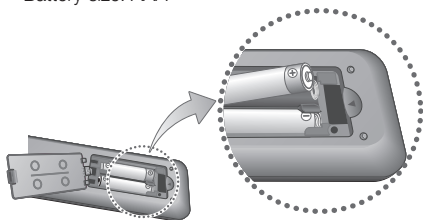

NOTE

- Place batteries in the remote control so they match the polarity : (+) to (+) and (-) to (-).
- Always replace both batteries at the same time.
- Do not expose the batteries to heat or flame.
- The remote control can be used up to approximately 23 feet (7 meters) in a straight line.

Setting the Remote Control

You can control certain functions of your TV with this remote control.

When operating a TV with the remote control

- Press the **TV** button to set the remote control to TV mode.
- Press the **POWER** button to turn on the TV.
- While holding down the **POWER** button, enter the code corresponding to your brand of TV.
 - If there is more than one code listed for your TV in the table, enter one at a time to determine which code works.
 - Example : For a Samsung TV**
While holding down the **POWER** button, use the number buttons to enter 00, 15, 16, 17 and 40.
- If the TV turns off, the setting is complete.
 - You can use the TV **POWER**, **VOLUME**, **CHANNEL**, and **Numeric** buttons (0~9).

NOTE

- The remote control may not work or some operations may not be possible with some brands of TVs.
- The remote control will work on a Samsung TV by default.

TV Brand Code List

Brand	Code	Brand	Code
Admiral (M.Wards)	56, 57, 58	MTC	18
A Mark	01, 15	NEC	18, 19, 20, 40, 59, 60
Anam	01, 02, 03, 04, 05, 06, 07, 08, 09, 10, 11, 12, 13, 14	Nikei	03
AOC	01, 18, 40, 48	Onking	03
Bell & Howell (M.Wards)	57, 58, 81	Onwa	03
Brocsonic	59, 60	Panasonic	06, 07, 08, 09, 54, 66, 67, 73, 74
Candle	18	Penney	18
Cetronic	03	Philco	03, 15, 17, 18, 48, 54, 59, 62, 69, 90
Citizen	03, 18, 25	Philips	15, 17, 18, 40, 48, 54, 62, 72
Cinema	97	Pioneer	63, 66, 80, 91
Classic	03	Portland	15, 18, 59
Concerto	18	Proton	40
Contec	46	Quasar	06, 66, 67
Coronado	15	Radio Shack	17, 48, 56, 60, 61, 75
Craig	03, 05, 61, 82, 83, 84	RCA/Proscan	18, 59, 67, 76, 77, 78, 92, 93, 94
Croslex	62	Realistic	03, 19
Crown	03	Sampo	40
Curtis Mates	59, 61, 63	Samsung	00, 15, 16, 17, 40, 43, 46, 47, 48, 49
CXC	03	Sanyo	19, 61, 65
Daewoo	02, 03, 04, 15, 16, 17, 18, 19, 20, 21, 22, 23, 24, 25, 26, 27, 28, 29, 30, 32, 34, 35, 36, 48, 59, 90	Scott	03, 40, 60, 61
Daytron	40	Sears	15, 18, 19
Dynasty	03	Sharp	15, 57, 64
Emerson	03, 15, 40, 46, 59, 61, 64, 82, 83, 84, 85	Signature 2000 (M.Wards)	57, 58
Fisher	19, 65	Sony	50, 51, 52, 53, 55
Funai	03	Soundesign	03, 40
Futuretech	03	Spectricon	01
General Electric (GE)	06, 40, 56, 59, 66, 67, 68	SSS	18
Hall Mark	40	Sylvania	18, 40, 48, 54, 59, 60, 62
Hitachi	15, 18, 50, 59, 69	Symphonic	61, 95, 96
Inkel	45	Tatung	06
JC Penny	56, 59, 67, 86	Techwood	18
JVC	70	Teknika	03, 15, 18, 25
KTV	59, 61, 87, 88	TMK	18, 40
KEC	03, 15, 40	Toshiba	19, 57, 63, 71
KMC	15	Vidtech	18
LG (Goldstar)	01, 15, 16, 17, 37, 38, 39, 40, 41, 42, 43, 44	Videch	59, 60, 69
Luxman	18	Wards	15, 17, 18, 40, 48, 54, 60, 64
LXI (Sears)	19, 54, 56, 59, 60, 62, 63, 65, 71	Yamaha	18
Magnavox	15, 17, 18, 48, 54, 59, 60, 62, 72, 89	York	40
Marantz	40, 54	Yupiteru	03
Matsui	54	Zenith	58, 79
MGA	18, 40	Zonda	01
Mitsubishi/MGA	18, 40, 59, 60, 75	Dongyang	03, 54

Connections

This section involves various methods of connecting the product to other external components. Before moving or installing the product, be sure to turn off the power and disconnect the power cord.

Connecting the Speakers

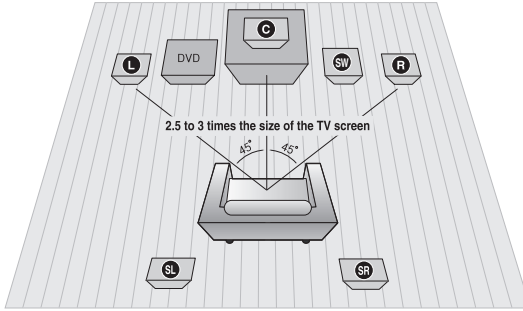

Position of the product

Place it on a stand or cabinet shelf, or under the TV stand.

Selecting the Listening Position

The listening position should be located about 2.5 to 3 times the distance of the TV's screen size away from the TV.

Example : For 32" TV's 6.56 ~ 7.87 feet(2~2.4m)
For 55" TV's 11.5 ~ 13.1 feet(3.5~4m)

Front Speakers L R	Place these speakers in front of your listening position, facing inwards (about 45°) toward you. Place the speakers so that their tweeters will be at the same height as your ear. Align the front face of the front tweeters with the front face of the center speaker or place them slightly in front of the center speakers.
Center Speaker C	It is best to install it at the same height as the front speakers. You can also install it directly over or under the TV.
Surround Speakers SL SR	Place these speakers to the side of your listening position. If there isn't enough room, place these speakers so they face each other. Place them about 2 to 3 feet (60 to 90cm) above your ear, facing slightly downward. * Unlike the front and center speakers, the surround speakers are used to handle mainly sound effects and sound will not come from them all the time.
Subwoofer SW	The position of the subwoofer is not so critical. Place it anywhere you like.

! CAUTION

- Do not let children play with or near the speakers. They could get hurt if the speaker falls.
- When connecting the speaker wires to the speakers, make sure that the polarity (+/-) is correct.
- Keep the subwoofer out of the reach of children so as to prevent them from inserting their hands or alien substances into the duct (hole) of the subwoofer.
- Do not hang the subwoofer on the wall through the duct (hole).

🔧 NOTE

- If you place a speaker near your TV set, screen color may be distorted because of the magnetic field generated by the speaker. If this occurs, place the speaker away from your TV set.

Connections

Speaker Components

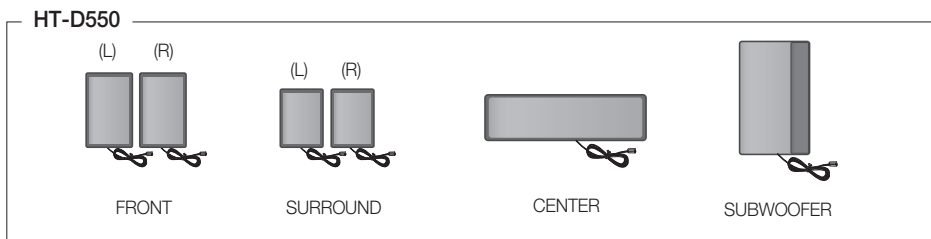

Speaker Components

Assembled Speakers

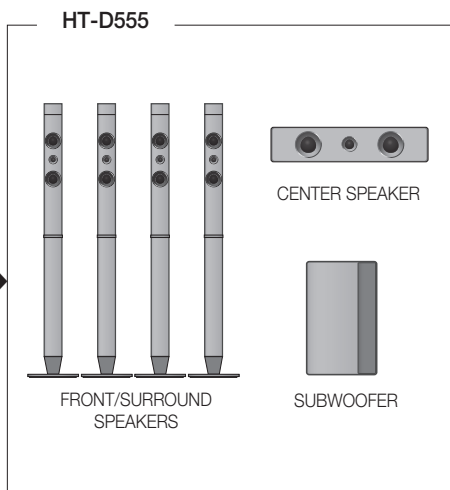
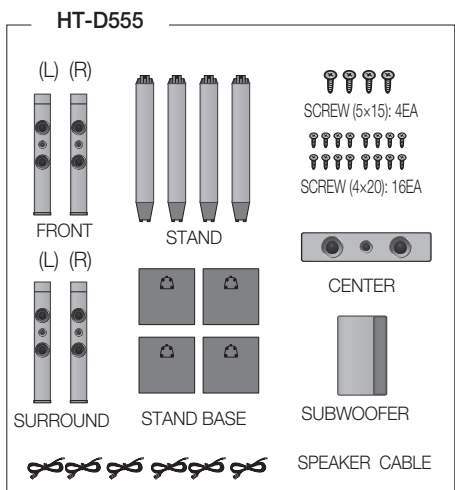
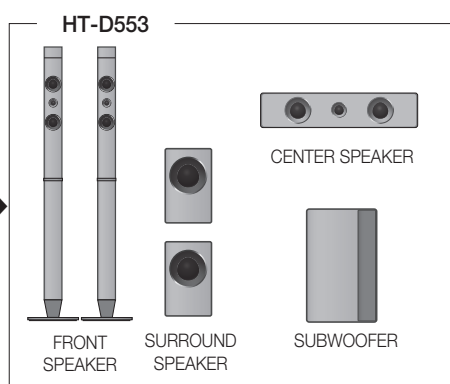
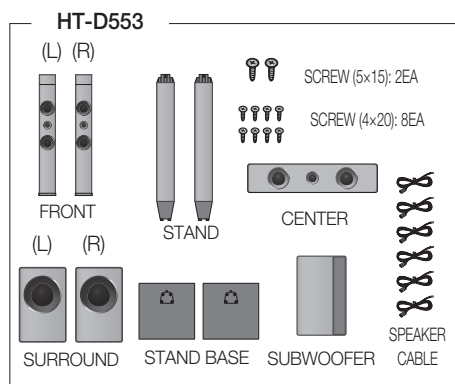

NOTE

- Refer to page 17 to install the Speakers on the Tallboy Stand.

Installing the Speakers on the Tallboy Stand

* HT-D553 only - Front Speakers

* HT-D555 only - Front/Surround Speakers

1. Turn the Stand Base upside-down and connect it to the Stand.

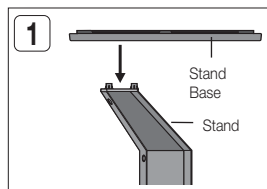

2. Insert small screws (4*20, For connecting Stand & Stand Base) clockwise into the four holes marked using a screwdriver as shown in the illustration.

! CAUTION : When you use a torque screwdriver, be careful not to put excessive force. Otherwise, it runs idle or can be damaged. (torque screwdriver- below 15 kg.f.cm)

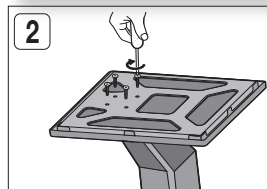

3. Connect the upper Speaker to the assembled Stand.

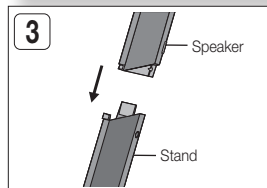

4. Insert another large screw (5*15, For connecting Speaker & Stand) clockwise into the hole on the rear of the speaker using a screwdriver.

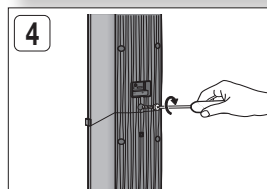

5. This is the appearance after the speaker is installed. Follow this steps to install other speaker.

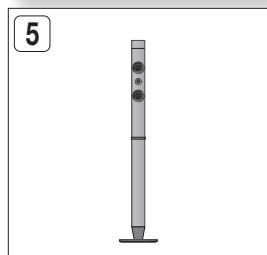

Connections

Connecting The Speakers

1. Press down the terminal tab on the back of the speaker.
(HT-D553/HT-D555 only)
2. Insert the black wire into the black terminal (-) and the red wire into the red terminal (+), and then release the tab. (HT-D553/HT-D555 only)
3. Connect the connecting plugs to the back of the product by matching the colors of the speaker plugs to the speaker jacks.

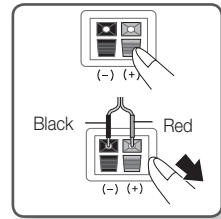

In case of HT-D550

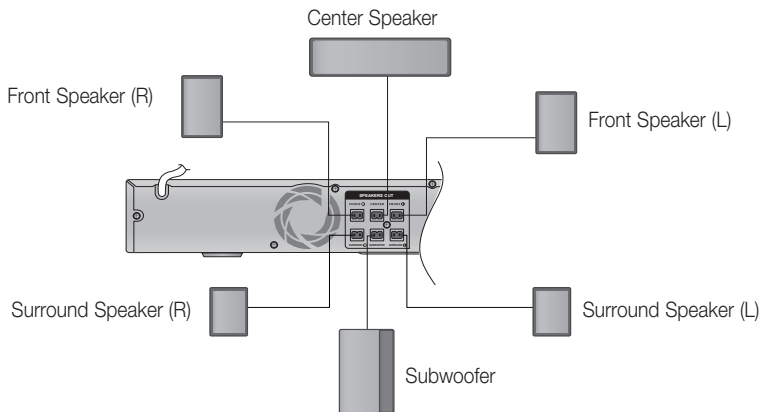

* Refer to page 16 for the HT-D553/D555 speakers.

Connecting the Optional Wireless Receiver Module

To connect the surround speakers wirelessly, you have to purchase the wireless receiver module and TX card from your Samsung retailer.

* This product should be connected with the SWA-5000 only.

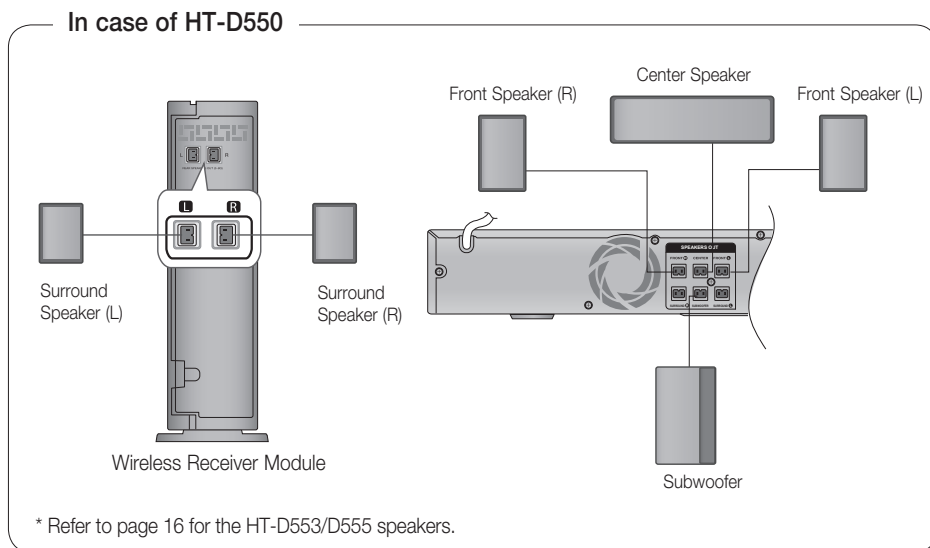

Wireless Receiver Module (SWA-5000)

1. Press down the terminal tab on the back of the speaker.
(HT-D553/HT-D555 only)
2. Insert the black wire into the black terminal (-) and the red wire into the red terminal (+), and then release the tab. (HT-D553/HT-D555 only)
3. Connect the connecting plugs to the back of the product by matching the colors of the speaker plugs to the speaker jacks.
4. With the product turned off, insert the TX card into the TX Card Connection (**WIRELESS**) on the back of the product.
 - Hold the TX card so that the label "WIRELESS" faces upward and insert the card into the port.
 - The TX card enables communication between the product and the wireless receiver module.
5. Connect the left and right surround speakers to the wireless Receiver module.
6. Plug the power cord of the wireless Receiver module in the wall outlet .

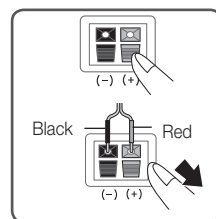

Connections

NOTE

- Place the wireless receiver module at the rear of the listening position. If the wireless receiver module is too close to the product, some sound interruption may be heard due to interference.
- If you use a device such as a microwave oven, wireless LAN Card, Bluetooth equipment, or any other device that uses the same frequency (2.4/5.8GHz) near the product, some sound interruption may be heard due to interference.
- The transmission distance from the product to the wireless receiver module is about 33 feet (10m), but may vary depending on your operating environment. If a steel-concrete wall or metallic wall is between the product and the wireless receiver module, the system may not operate at all, because the radio wave cannot penetrate metal.
- If the product doesn't make wireless connection, the product needs ID Setting between the product and wireless receiver module. Insert the TX card in the rear of the product before entering Standby mode. Press "0"→"1"→"3"→"5", and "5" using the numeric buttons on the remote control. You will see a message of "W INT" on the screen.
- With the wireless receiver module turned on, press "ID SET" button on the back of the wireless receiver module for 5 seconds.

! CAUTION

- Use the provided TX card only.
If a different TX card is used, the product may be damaged or the card may not be removed easily.
- Do not insert the TX card upside down or in the reverse direction.
- Insert the TX card when the product is turned off. Inserting the card when it is turned on may cause a problem.
- If the TX Card is inserted and wireless receiver module setting is complete, sound is not output from the surround Speaker connectors on the product.
- The wireless receiver antenna is built into the wireless receiver module. Keep it away from water and moisture.
- For optimal listening performance, make sure that the area around the wireless receiver module location is clear of any obstructions.
- **If no sound is heard from the wireless receiver module, switch the mode to DVD 5.1 channel or Dolby ProLogic II .**
- In 2-CH mode, no sound will be heard from the wireless receiver module.

Connecting the Video Out to your TV

Choose one of the three methods for connecting to a TV.

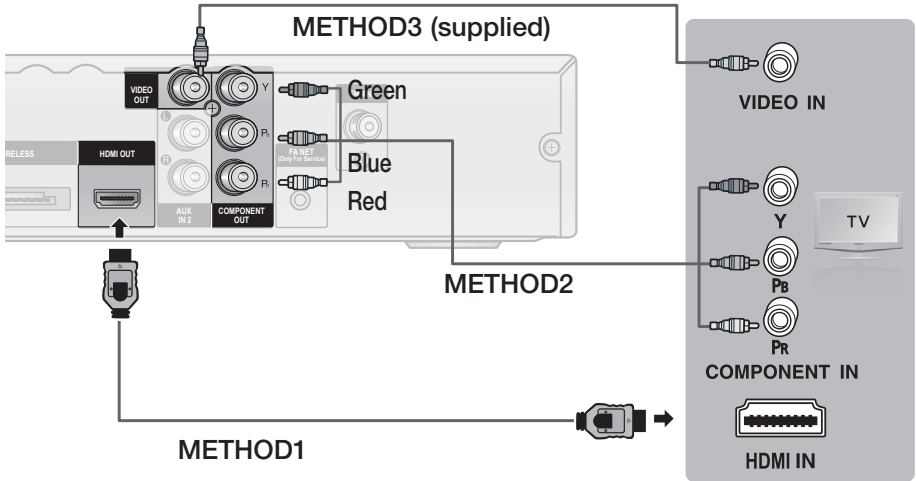

METHOD 1 : HDMI (BEST QUALITY)

Connect an HDMI cable (not supplied) from the **HDMI OUT** jack on the back of the product to the **HDMI IN** jack on your TV.

METHOD 2 : Component Video (BETTER QUALITY)

If your television is equipped with Component Video inputs, connect a Component video cable (not supplied) from the **COMPONENT OUT** (Y, Pb and Pr) Jacks on the back of the product to the Component Video Input Jacks on your TV.

METHOD 3 : Composite Video (GOOD QUALITY)

Connect the supplied Video cable from the **VIDEO OUT** jack on the back of the product to the **VIDEO IN** jack on your TV.

NOTE

- Resolutions available for the HDMI output are 480p, 720p, 1080i/1080p. See page 26 for the resolution setting.
- This product operates in Interlace scan mode 480i for component/composite output.
- After making the video connection, set the Video input source on your TV to match the corresponding Video output (HDMI, Component or Composite) on your product.
Turn this product on first before you set the video input source on your TV. See your TV owner's manual for more information on how to select the TV's Video Input source.

! CAUTION

- Do not connect the unit through a VCR. Video signals fed through VCRs may be affected by copyright protection systems and the picture will be distorted on the television.

Connections

HDMI FUNCTION

HDMI Auto Detection Function

If your TV is Samsung TV and it supports CEC function. The product's video output will automatically change to HDMI mode when connecting an HDMI cable while power is on.



- HDMI (High Definition Multimedia Interface)
- HDMI is an interface that enables the digital transmission of video and audio data with just a single connector. Using HDMI, the product transmits a digital video and audio signal and displays a vivid picture on a TV having an HDMI input jack.
- HDMI connection description
 - HDMI outputs only a pure digital signal to the TV.
 - If your TV does not support HDCP (High-bandwidth Digital Content Protection), random noise appears on the screen.
- What is the HDCP?
- HDCP (High-band width Digital Content Protection) is a system for protecting DVD content outputted via HDMI from being copied. It provides a secure digital link between a video source (PC, DVD, etc) and a display device (TV, projector, etc). Content is encrypted at the source device to prevent unauthorized copies from being made.

Using Anynet+(HDMI-CEC)

Anynet+ is a function that enables you to control other Samsung Devices with your Samsung TV's remote control. Anynet+ can be used by connecting this product to a SAMSUNG TV using a HDMI Cable. This is only available with SAMSUNG TV's that support Anynet+.

1. Connect the product to a Samsung TV with an HDMI cable. (See page 21)
2. Set the Anynet+ function on your TV. (See the TV instruction manual for more information.)

NOTE

- The Anynet+ function supports some buttons of the remote control.
- This function is not available if an HDMI cable does not support CEC.
- Depending on your TV, certain HDMI output resolutions may not work. Please refer to the user's manual of your TV.
- Please check the  logo (If your TV has an  logo, then it supports Anynet+ function.)

Connecting the FM Antenna

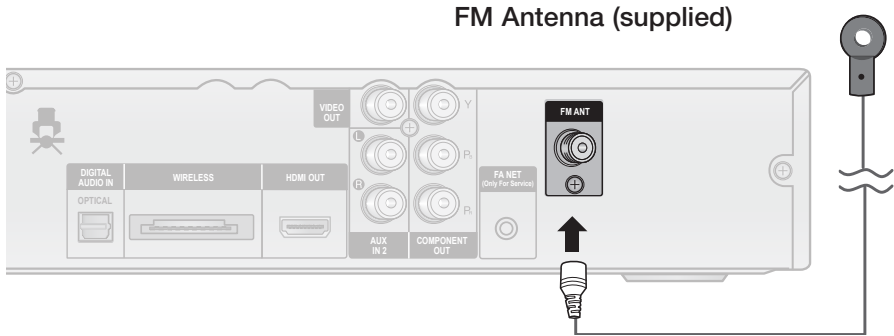

1. Connect the FM antenna supplied to the FM Antenna jack.
2. Slowly move the antenna wire around until you find a location where reception is good, then fasten it to a wall or other rigid surface.

NOTE

- This product does not receive AM broadcasts.

Connecting Audio from External Components

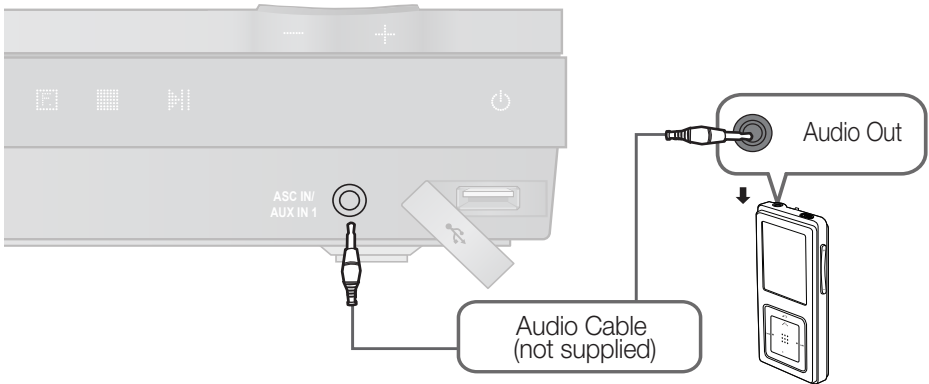

AUX1 : Connecting an External Component/MP3 player

Components such as an MP3 Player.

1. Connect **ASC IN / AUX IN1** (Audio) on the front of the product to the Audio Out of the external component/ MP3 player.
2. Press the **FUNCTION** button to select **AUX1** input.
 - The mode switches as follows :
DVD/CD → D.IN → AUX 1 → AUX 2 → USB → REMOTE IPOD → IPOD → FM

Connections

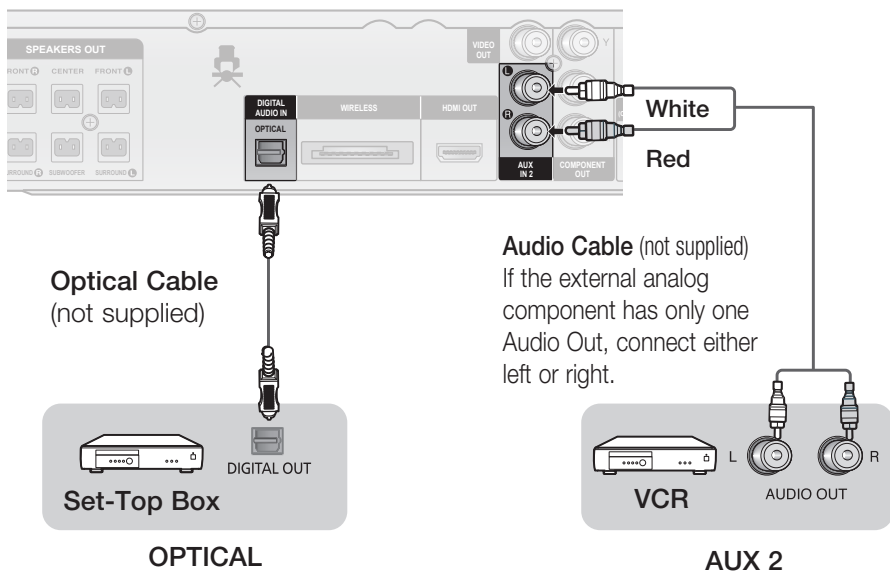

AUX2 : Connecting an External Analog Component

Analog signal components such as a VCR.

1. Connect **AUX IN 2** (Audio) on the back of the product to the Audio Out of the external Analog component.
 - Be sure to match the colors of the connecting jacks.
2. Press the **FUNCTION** button to select **AUX 2** input.
 - The mode switches as follows :
DVD/CD → D.IN → AUX 1 → AUX 2 → USB → REMOTE IPOD → IPOD → FM

NOTE

- You can connect the Video Output jack of your VCR to the TV, and connect the Audio Output jacks of the VCR to this product.

OPTICAL : Connecting an External Digital Component

Digital signal components such as a Cable Box/Satellite receiver (Set-Top Box).

1. Connect the **DIGITAL AUDIO IN (OPTICAL)** on the back of the product to the Digital Output of the external digital component.
2. Press the **FUNCTION** button to select **D.IN**.
 - The mode switches as follows :
DVD/CD → D.IN → AUX 1 → AUX 2 → USB → REMOTE IPOD → IPOD → FM

Before Starting (Initial Setting)

1. Press the **POWER** button when it is plugged in TV for the first time.
Initial Setting screen will be displayed.

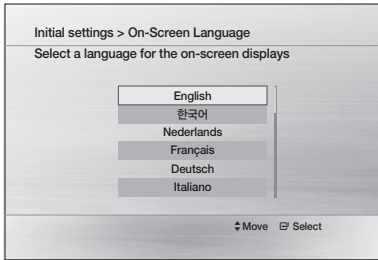

2. Press the **▲▼** buttons to select the desired language, then press the **ENTER** button.
3. Press the **ENTER** button to select Start button.
4. Press the **▲▼** buttons to select desired TV Aspect, then press the **ENTER** button.
 - If the HDMI cable is connected to the product, TV aspect does not appear.
5. Plug the ASC microphone into the ASC IN jack on the product.
- Auto Sound Calibration screen will be displayed.
6. Press the **ENTER** button to select Start button.

NOTE

- If you have not selected a preferred language in the initial settings, you will see a language selection window next time you turn on the product.
- Your language selection will apply to all menus: On-Screen Menu, Disc Menu, Audio, Subtitle.
- If you want to move to the previous screen, press the **RETURN** button.
- Once you select a menu language, you can change it by pressing the **STOP (■)** button on the remote control for more than 5 seconds with no disc inserted.
- When the Initial Setting screen does not appear, refer to the Initial Setting. (see page 30)

Setting the Setup menu

The access step may differ depending on the selected menu. The GUI (Graphical User Interface) in this manual may differ, depending on the firmware version.

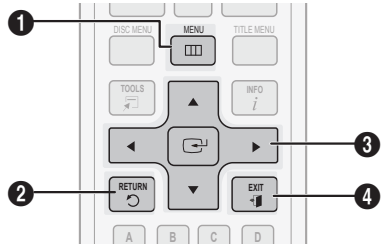

- | | |
|---------------------------------|--|
| 1 | MENU BUTTON : Display the home menu. |
| 2 | RETURN BUTTON : Return to the previous setup menu. |
| ENTER / DIRECTION BUTTON | |
| 3 | Move the cursor and select an item.
Select the currently selected item.
Confirm the setting. |
| 4 | EXIT BUTTON : Exit the setup menu. |

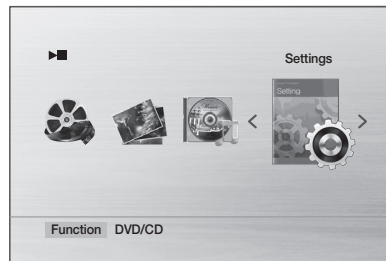

1. Press the **POWER** button.
2. Press the **◀▶** buttons to select **Settings**, then press the **ENTER** button.
3. Press the **▲▼** buttons to select the desired menu, then press the **ENTER** button.
4. Press the **▲▼** buttons to select the desired sub-menu, then press the **ENTER** button.
5. Press the **▲▼** buttons to select the desired item, then press the **ENTER** button.
6. Press the **EXIT** button to exit the setup menu.

Setup

Display

You can configure various display options such as the TV Aspect, Resolution, etc.

TV Aspect

Depending on the type of television you have, you may want to adjust the screen setting.

• 4:3 Pan-Scan



Select when you want to see the 16:9 video supplied by the DVD without the black bars on top and bottom, even though you have a TV with a 4:3 ratio screen (extreme left and right portion of the movie picture will be cut off).

• 4:3 Letter Box



Select when you want to see the total 16:9 ratio screen DVD supplies, even though you have a TV with a 4:3 ratio screen. Black bars will appear at the top and bottom of the screen.

• 16:9 Wide



You can view the full 16:9 picture on your widescreen TV.

NOTE

- When using HDMI, the screen is automatically converted to the 16:9 Wide mode and TV Aspect is deactivated.
- If a DVD is in the 4:3 ratio, you cannot view it in the wide screen.
- Since DVD discs are recorded in various image formats, they will look different depending on the software, the type of TV, and the TV aspect ratio setting.

BD Wise

(Samsung products only)

BD Wise is Samsung's latest inter-connectivity feature. When you connect Samsung products with BD-Wise to each other via HDMI, the optimum resolution will be set automatically.

- **On** : The original resolution of the DVD disc will be output to the TV direct.
- **Off** : The output resolution will be fixed according to the Resolution previously set, regardless of the resolution of the disc.

NOTE

- This will optimize the picture quality according to the content (In the DVD disc, etc) that you want to play and the product or your BD Wise-compliant Samsung TV.
- If you want to change the resolution in BD Wise mode, you must set BD mode to Off in advance.
- BD Wise will be disabled if the product is connected to a device that does not support BD Wise.

Resolution

Sets the output resolution of the HDMI video signal. The number in 480p, 720p, 1080i and 1080p indicates the number of lines of video.

The i and p indicate interlace and progressive scan, respectively.

- **480p** : Outputs 480 lines of progressive video.
- **720p** : Outputs 720 lines of progressive video.
- **1080i** : Outputs 1080 lines of interlaced video.
- **1080p** : Outputs 1080 lines of progressive video.
- **BD Wise** : Automatically sets the optimal resolution when connected via HDMI to a TV with the BD Wise feature. (The BD Wise menu item appears only if BD Wise is set to On.)

NOTE

- If Component or Composite is connected, the resolution supports only 480i.
- 1080P may not appear depending on TV.

HDMI Format

You can optimize the color setting from the HDMI output. Select a connected device Type.

- **Monitor** : Select if connected to a Monitor via HDMI.
- **TV** : Select if connected to a TV via HDMI.

Audio

Speaker Setting

Speaker Size

You can set the Speaker Size of the Center and Surround Speakers, as well as Test Tone in this mode.

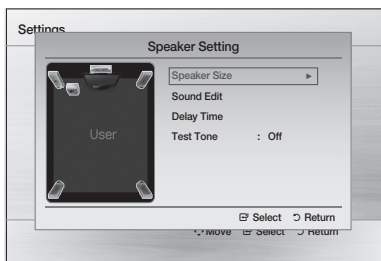

- For the Front, the mode is set to Small.
- For the Subwoofer, the mode is set to Present.
- For the Center and Surround, you can switch the mode to Small or None.
 - **Small** : Select this when using the speakers.
 - **None** : Select this when no speaker is connected.

NOTE

- The speaker mode may vary depending on the Dolby Pro Logic and Stereo settings.

Sound Edit

You can adjust the balance and level for each speaker.

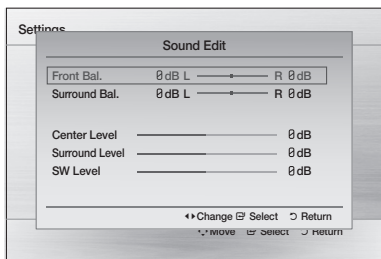

Press the ▲▼ buttons to select and adjust the desired speaker.

Press the ◀▶ buttons to adjust the settings.

Adjusting Front/Surround Bal.

- You can select between 0 and -6.
- The volume decreases as you move closer to -6.

Adjusting Center/Surround/Subwoofer Level

- The volume level can be adjusted in steps from +6dB to -6dB.
- The sound gets louder as you move closer to +6dB and quieter as you get closer to -6dB.

Delay Time

If the speakers cannot be placed at equal distances from the listening position, you can adjust the delay time of the audio signals from the Center and Surround speakers. You can also set the Test Tone in this mode.

Setting up the Speaker Delay Time

When 5.1CH Surround Sound is played, you can enjoy the best sound if the distance between you and each speaker is the same.

Since the sounds arrive at the listening position at different times depending on the placement of speakers, you can adjust this difference by adding a delay effect to the Center and Surround Speakers.

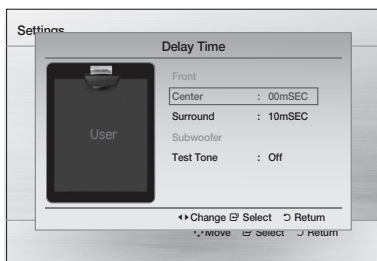

NOTE

- The Delay Time menu will be activated only when a 5.1 channel source is played.
- You can not set Center and Surround in this mode when their Speaker Size is set to NONE.

Setup

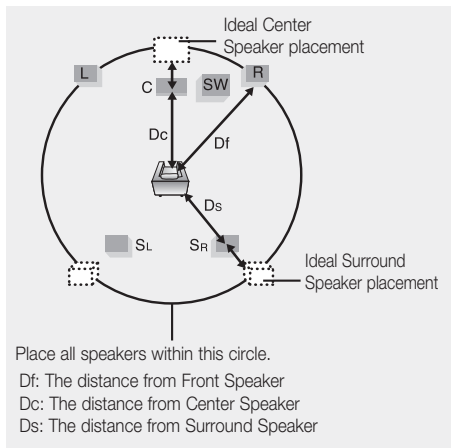

Setting the Center Speaker

If the distance of Dc is equal to or longer than the distance of Df in the figure, set the mode as 0ms. Otherwise, change the setting according to the table.

Distance between Df and Dc	0.00ft	1.12ft	2.23ft	3.48ft	4.59ft	5.77ft
Delay Time	00 ms	01 ms	02 ms	03 ms	04 ms	05 ms

Setting the Surround Speaker

If the distance of Dc is equal to or longer than the distance of Ds in the figure, set the mode as 0ms. Otherwise, change the setting according to the table.

Distance between Ds and Dc	0.00ft	3.48ft	6.92ft	10.37ft	11.88ft	17.36ft
Delay Time	00 ms	03 ms	06 ms	09 ms	12 ms	15 ms

NOTE

- With PL II (Dolby Pro Logic II), the delay time may be different for each mode.
- With AC-3 and DTS, the delay time can be set between 00 and 15mSEC.
- The Center channel is only adjustable on 5.1 channel discs.

Test Tone

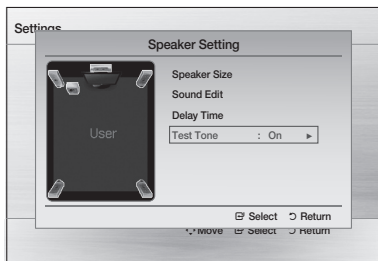

Use the Test Tone feature to check the speaker connections.

- Press the ◀▶ buttons to select **On**.
 - The test tone will be sent to **Front Left → Center → Front Right → Surround Right → Surround Left → Subwoofer** in order.
- To stop the test tone, press the **ENTER** button.

ASC (Auto Sound Calibration) Setting

By setting the Auto Sound Calibration(ASC) function just once when you relocate or install the product, you can have the product automatically recognize the distance between speakers, levels between channels, and frequency characteristics to create a 5.1-channel sound field optimized for your environment.

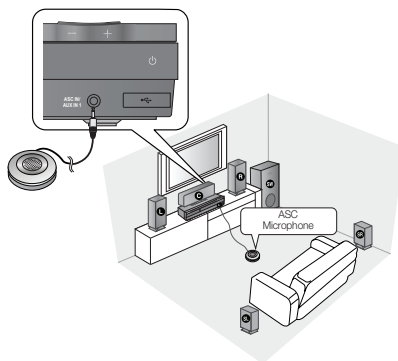

- L: Front Left
- R: Front Right
- C: Center
- SW: Subwoofer
- SL: Surround Left
- SR: Surround Right

NOTE

- ASC setup can be made when there is no disc in the product.
- You cannot adjust the volume during the ASC setup.
- If the auto sound microphone is disconnected during the ASC setup, the setup will be canceled.
- When ASC function is activated, the DSP/EQ, Dolby Pro Logic II and P. BASS sound effects will not work.
- If the product is connected to external devices or other components (such as an iPod, AUX, D.IN), the ASC Setup may not work exactly.
- Place the microphone on the main listening position.
- Nothing should get in the way between speakers and microphone.
- Note that the test tone of the speaker may be loud when conducting the test.
- Do not place the microphone behind the furniture or too close to the wall. Otherwise, it can produce an incorrect test result.

Auto Sound Calibration

You will hear either the **ASC** mode or the User Speaker Settings.

- **On** : You will hear sound in the Auto Sound Calibration(ASC) mode.
- **Off** : You will hear sound in the Speaker Setting value you set.

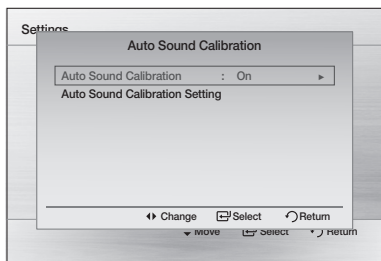
**Auto Sound Calibration Setting**

1. Plug the ASC microphone into the ASC input jack.
 2. Place the ASC microphone at the listening position.
- Auto Sound Calibration will be automatically set up in the following sequence:
Front Left → Center → Front Right → Surround Right → Surround Left → Subwoofer
 - Press the **RETURN** button to cancel the Auto Sound Calibration Setting.
 - When the message "**REMOVE MIC**" appears on the display, unplug the ASC microphone.

NOTE

- Setting the **Auto Sound Calibration** function takes about 3 minutes.

DRC (Dynamic Range Compression)

This feature balances the range between the loudest and quietest sounds. You can use this function to enjoy Dolby Digital sound when watching movies at low volume at night.

- You can select either Full, 6/8, 4/8, 2/8, off.

AUDIO SYNC

Video and audio sync may not match with digital TV. If this occurs, adjust the audio delay time to match the video

- You can set the audio delay time between 0 mSec and 300 mSec. Set it to the optimal status.

Setup

HDMI AUDIO

The audio signals transmitted over the HDMI Cable can be toggled On/Off.

- **Off** : Video is transmitted over the HDMI connection cable only, and audio is output through the product speakers only.
- **On** : Both video and audio signals are transmitted over the HDMI connection cable, and audio is output through your TV speakers only.

NOTE

- The default setting of this function is HDMI Audio Off.
- HDMI Audio is automatically down-mixed to 2ch for TV speakers.
- When HDMI Audio is set to On, PL II /DSP EQ /P.BASS doesn't work.
- In the iPod mode, this menu is not available.
- With HDMI AUDIO set to 'On', the volume can be adjusted only using the TV remote control.

User EQ

You can configure the equalizer settings manually to your preference.

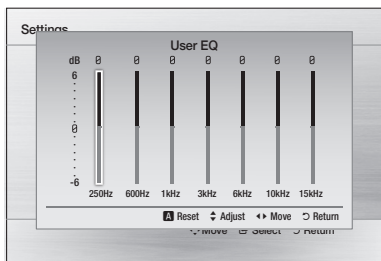

NOTE

- This can be also done using the DSP/EQ button. (see page 38)

Audio Return Ch.

You can enjoy TV sound from the Home Theater speakers by using just one HDMI cable.

- **Off** : Turn the Audio Return Channel function off.
- **Auto** : Listen to TV sound from the Home Theater speakers if your TV is compatible with the Audio Return Channel function.

NOTE

- When Anynet+ (HDMI-CEC) is Off, the Audio Return Channel function is not available.
- Using an ARC (Audio Return Channel)-uncertified HDMI cable may cause a problem in compatibility.
- ARC function is only available if an ARC-compliant TV is connected.

System

Initial Setting

By using the Initial Setting, you can set the language, TV aspect and ASC(Auto Sound Calibration) setting. Check if the ASC microphone is connected to the product.

NOTE

- If an HDMI cable is connected to the product, the TV aspect does not appear and it is set to 16:9 Wide automatically.

DivX(R) Registration

View DivX(R) VOD Registration Code to purchase and play DivX(R) VOD content.

NOTE

- This option is not activated if you select OK.To activate this option, please activate the DivX(R) Deactivation.
- Even after you reset the system, the settings of DivX Registration will not be reset.

DivX(R) Deactivation

Select this to get a new registration code.

Language

You can select the language you prefer for on-screen menu, disc menu, etc.

OSD Language	Select the language for the on-screen displays.
Disc Menu	Select the language for the disc menu displays.
Audio	Select the language for disc audio.
Subtitle	Select the language for disc subtitles.

- ※ To select a language that does not appear in the menu, select OTHERS in the Disc Menu, Audio and Subtitle, and enter the county code (see page 44).
- ※ You cannot select OTHERS in the OSD Language menu.



NOTE

- The selected language will only appear if it is supported on the disc.

Security

The Parental Lock function works in conjunction with DVDs that have been assigned a rating, which helps you control the types of DVDs that your family watches. There are up to 8 rating levels on a disc.

Parental Rating

Select the rating level you want to set.

A larger number indicates that the program is intended for adult use only. For example, if you select up to Level 6, discs that contain Level 7, 8 will not play.

Enter the password and then press the **ENTER** button.

- The password is set to "0000" by default.
- Once the setup is complete, you will be taken to the previous screen.

Change Password

Select **Change** and enter the 4-digit password to set the parental lock using the number buttons on the remote control.

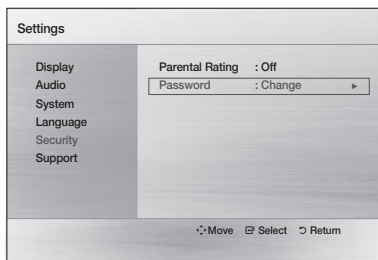

If you forgot your password

1. Remove the disc.
2. Press and hold the **STOP** (■) button on the remote control for 5 seconds or more. All settings will revert to the factory settings.

Support

Product Information

Product information such as Model code, Software Version, etc. is provided.

Basic Functions

Disc Playback

1. Press the **OPEN/CLOSE** (▲) button.
2. Place a disc gently into the tray with the disc's label facing up.
3. Press the **OPEN/CLOSE** (▲) button to close the disc tray.

NOTE

- Resume function: When you stop disc play, the product remembers where you stopped, so when you press **PLAY** button again, it will pick up where you left off. (This function works only with DVDs.)

Press the **STOP** button twice during playback to disable the Resume function.

- If no buttons are pressed on the product or remote control for more than 3 minutes when the product is in Pause mode, it will change to STOP mode.
- The initial screen may appear different, depending on the content of the disc.
- Pirated discs will not play in this unit because they violate the CSS(Content Scrambling System: a copy protection system) recommendations.

※ ○ will appear when an invalid button is pressed.

TV Screen Saver/Power Saving Function

- If no button input is made for more than 5 minutes in Stop or Play mode, the screen saver will get activated.
- If the product is left in the screen saver mode for more than 25 minutes, the power will automatically turn off.

Audio CD(CD-DA)/MP3/WMA Playback

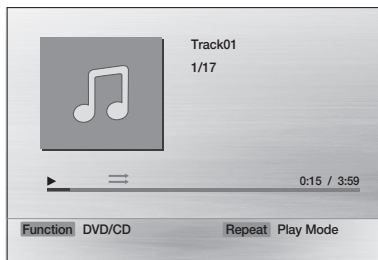

1. Insert an Audio CD(CD-DA) or an MP3 Disc into the disc tray.
 - For an Audio CD, the first track will be played automatically.
 - Press the ◀◀▶▶ buttons to move to the previous/next track.
 - For the MP3/WMA disc, press the ◀▶ buttons to select **Music**, then press the **ENTER** button.
 - Press the ▲▼◀▶ buttons to select a desired file and press the **ENTER** button.
 - Press the ◀◀▶▶ buttons to move to the previous/next pages.
2. Press the **STOP** (■) button to stop playback.

NOTE

- Some MP3/WMA-CDs may not play, depending on the recording mode.
- Table of contents of a MP3-CD varies depending on the MP3/WMA track format recorded on the disc.
- WMA-DRM files cannot be played.

JPEG File Playback

Images captured with a digital camera or camcorder, or JPEG files on a PC can be stored on a CD and then played back with this product.

1. Insert a JPEG disc on the disc tray.
2. Press the ◀▶ buttons to select **Photo**, and then press the **ENTER** button.
3. Press the ▲▼ buttons to select the folder you want to play, and then press the **ENTER** button.
4. Press the ▲▼ buttons to select the photo you want to play, and then press the **ENTER** button.
 - The selected file will play and slide show will start.
 - To stop slide show, press the **PAUSE (II)** button.
 - You can view the previous/next file by pressing the ◀, ▶ buttons during the slideshow mode.

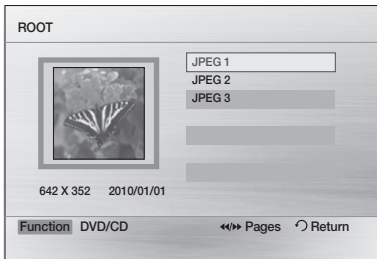

Rotate Function



Press the **GREEN(B)** or **YELLOW(C)** button during the **PAUSE** mode.

- **GREEN(B)** Button: Rotate 90° counterclockwise.
- **YELLOW(C)** Button: Rotate 90° clockwise.

NOTE

- The maximum resolutions supported by this product are 5120 x 3480 (or 19.0 MPixel) for standard JPEG files and 2048 x 1536 (or 3.0 MPixel) for progressive image files.

Using the Playback Function

Forward/Reverse Search



Press the ◀◀▶▶ buttons to use the Search Function.

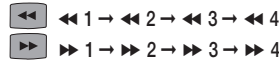

NOTE

- No sound is played in search mode.

Skipping Scenes/Songs



Press the ◀◀▶▶ buttons.

- Each time the button is pressed during playback, the previous or next chapter, track or directory (file) will be played.
- You cannot skip chapters consecutively.

Slow Motion Play



Press the **PAUSE (II)** button and then ▶▶ button for Slow Motion play.

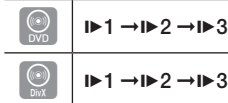

NOTE

- No sound is heard during slow playback.
- Reverse slow playback does not work.

Basic Functions

Step Motion Play



Press the **PAUSE** button repeatedly.

- The picture moves forward one frame each time the button is pressed during playback.

NOTE

- No sound is heard during step motion playback.

5 Minute Skip function



During playback, press the ◀, ▶ button.

- Playback skips 5 minutes forward whenever you press the ▶ button.
- Playback skips 5 minutes backward whenever you press the ◀ button.

NOTE

- You can operate this function only on the DivX.

Using the Disc Menu



You can view the menus for the audio language, subtitle language, profile, etc.

1. During playback, press the **DISC MENU** button on the remote control.
2. Press the ▲▼◀▶ buttons to make the desired selection, then press the **ENTER** button.



NOTE

- Depending on the disc, menu setup items may vary and this menu may not be available.

Using the Title Menu



For DVDs containing multiple titles, you can view the title of each movie.

1. During playback, press the **TITLE MENU** button on the remote control.
2. Press the ▲▼◀▶ buttons to make the desired selection, then press the **ENTER** button.



NOTE

- Depending on the disc, menu setup items may vary and this menu may not be available.

Repeat Playback



DVD/DivX Repeat

You can repeat the title, chapter or the section(A-B Repeat) of the DVD/DivX.

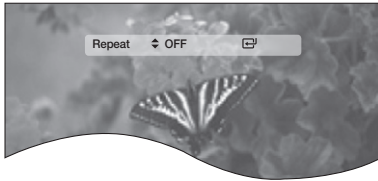

1. During DVD/DivX playback, press the **REPEAT** button on the remote control.
2. Press the **▲▼** buttons to select a desired repeat mode, then press the **ENTER** button.
3. Press the **▲▼** buttons to select **OFF** to return to normal play, then press the **ENTER** button.



A-B Repeat Playback



You can repeatedly play back a designated section of a DVD or CD.

1. During the DVD disc or CD playback, press the **REPEAT** button on the remote control.
2. For DVD, press the **▲▼** buttons to select **A-**. For CD press the **REPEAT** button repeatedly until **A-B** appears.
3. Press the **ENTER** button at the point where you want repeat play to start (A).
4. Press the **ENTER** button at the point where you want repeat play to stop (B).
5. To return to normal playback, For DVD, press the **▲▼** buttons to select to **OFF**. For CD, press the **REPEAT** button to select to **⇒**.

NOTE

- The A-B Repeat function does not operate with DivX, MP3 or JPEG discs.

	Title → Chapter → A - → Off
	Title → Folder → All → Off

CD/MP3 Repeat

1. During the CD/ MP3 playback, press the **REPEAT** button repeatedly to select the repeat mode you want.

	 (Normal → Repeat Track → Repeat All → Random → Repeat Section A-B)
	 (Normal → Repeat Track → Repeat Dir (Directory) → Repeat All → Random)

Basic Functions

Displaying Disc Information

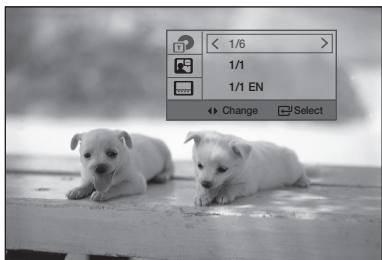
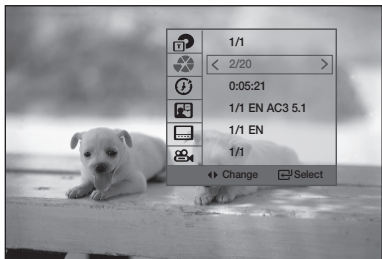

1. During playback, press the **TOOLS** button on the remote control.
2. Press the **▲▼** buttons to select the desired item.
3. Press the **◀▶** buttons to make the desired setup change and then press the **ENTER** button.
- You may use the number buttons of the remote control to control items.
4. To make Disc information disappear, press the **TOOLS** button again.



NOTE

- If you are playing contents from the tools menu, some functions may not be enabled depending on the disc.
- You can also select DTS, Dolby Digital or Pro Logic, depending on the disc.
- Some tools menus may differ depending on discs and files.

TOOLS menu

- **Title** (📀) : To access the desired title when there is more than one in the disc. For example, if there is more than one movie on a DVD, each movie will be identified as a Title.
- **Chapter** (📄) : Most DVD discs are recorded in chapters so that you can quickly find a specific chapter.
- **Playing time** (🕒) : Allows playback of the film from a desired time. You must enter the starting time as a reference. The time search function does not operate on some discs.
- **Audio** (🔊) : Refers to the film's soundtrack language. A DVD Disc can contain up to 8 audio languages.
- **Subtitle** (📄) : Refers to the subtitle languages available in the disc. You will be able to choose the subtitle languages or, if you prefer, turn them off from the screen. A DVD Disc can contain up to 32 subtitle languages.
- **Angle** (👁️) : When a DVD contains multiple angles of a particular scene, you can use the Angle function.

Selecting the Audio Language



1. Press the **TOOLS** button.
2. Press the **▲▼** buttons to select **AUDIO** (🔊).
3. Press the **◀▶** buttons to select the desired audio language.
 - Depending on the of languages on a DVD disc, a different audio language is selected each time the button is pressed.

Selecting the Subtitle Language



1. Press the **TOOLS** button.
2. Press the **▲▼** buttons to select **SUBTITLE** (📄).

- Press the ◀▶ buttons to select the desired subtitle language.
 - Depending on the languages on a DVD disc, a different subtitle language is selected each time the button is pressed.

NOTE

- Depending on the disc, the Subtitle and Audio Language functions may not be available.

Caption Function



- You must have some experience with video extraction and editing in order to use this feature properly.
- To use the caption function, save the caption file (*.smi) in the same file name as that of the DivX media file (*.avi) within the same folder.
Example. Root Samsung_007CD1.avi
 Samsung_007CD1.smi
- Up to 100 alphanumeric characters or 50 East Asian characters (2 byte characters such as Korean and Chinese) for the file name.
- The subtitle of DivX files are *.smi, *.sub, *.srt over 148 kbyte is not supported.

Angle Function



This function allows you to view the same scene in different angles.

- Press the **TOOLS** button.
- Press the ▲▼ buttons to select **ANGLE** ()
- Press the ◀▶ buttons to select the desired angle.

NOTE

- The Angle function works only with discs on which multiple angles have been recorded.

SLEEP

You can set the time that the Home Theater will shut itself off.



Press the **SLEEP** button.

- Each time the button is pressed, the selection changes as follows
SLP 10 → SLP 20 → SLP 30 → SLP 60 → SLP 90 → SLP 120 → SLP 150 → OFF.

DIMMER

You can adjust the brightness of the display on the main unit.



Press the **DIMMER** button.

Sound Mode

P.BASS

The P.BASS function provides a bass boost to reinforce the low frequencies.

The MP3 ENHANCE function provides better sound quality by upscaling the sampling frequency.

AUDIO
UPSCALE

Press the **P.BASS** button.

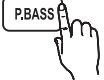

2 Channel LPCM source	POWER BASS ON →
	POWER BASS OFF
MP3 file	MP3 ENHANCE ON →
	POWER BASS ON →
	POWER BASS OFF

NOTE

- The P.BASS function is only available with 2 channel LPCM sources such as MP3, DivX, CD and WMA.
- The P.BASS function does not work with GIGA SOUND or Dolby Pro Logic II modes. If you press P.BASS in the DSP/EQ mode, the DSP/EQ mode is automatically shut off and the P. BASS function will be turned on.
- The MP3 Enhancement function is only available with MP3 files.

Basic Functions

GIGA

The GIGA Sound Function amplifies bass and improves bass twice as much for you to appreciate powerful real sound. The GIGA Sound feature will be applied only to the subwoofer.

Press the **GIGA** button.



NOTE

- If GIGA Sound is set to 'ON', other sound field effects will not be applied.
- If DOLBY PLII is set to 'ON', the GIGA Sound effect will not be applied.

S.VOL (SMART VOLUME)

This will regulate and stabilize the volume level against a drastic volume change when changing channels or during a scene transition.

Press the **S.VOL** button.



- Each time the button is pressed, the selection changes as follows :

SMART VOLUME ON → **SMART VOLUME OFF**

S/W LEVEL

You can also press the **S/W LEVEL** button on the remote control and use the ◀ or ▶ buttons to adjust the level of subwoofer.

Press the **S/W LEVEL** button.



DSP (Digital Signal Processor)/EQ

- DSP (Digital Signal Processor) : DSP modes have been designed to simulate different acoustic environments.
- EQ : You can select POPS, JAZZ , ROCK , or USER. to optimize the sound for the genre of music you are playing.



Press the **DSP/EQ** button.

POPS, JAZZ, ROCK	Select POPS, JAZZ, or ROCK, depending on the genre of music you're listening to.
USER	You can enjoy music as you set in "EQ:USER". If you press ENTER in the "EQ:USER" menu, you will see a window where you can change the EQ settings to your preference.
STUDIO	Provides a sense of presence as if in a studio.
CLUB	Simulates the sound of a dance club with a throbbing bass beat.
HALL	Provides a clear vocal as if listening in a concert hall.
MOVIE	Provides the feeling of a movie cinema.
CHURCH	Provides the feeling of being in a grand church.
OFF	Select this for normal listening.

Dolby Pro Logic II Mode

You can select the desired Dolby Pro Logic II audio mode.

Press the  PL II button.



MUSIC	When listening to music, you can experience sound effects as if you are listening to the actual performance.
MOVIE	Adds realism to the movie soundtrack.
PROLOG	You can listen to a 2CH sound source in 5.1CH surround sound with all speakers active. - A specific speaker(s) may not be output depending on the input signal.
MATRIX	You will hear multi-channel surround sound.
STEREO	Select this to listen to sound from the front left and right speakers and the subwoofer only.

NOTE

- When selecting Pro Logic II mode, connect your external device to the AUDIO INPUT jacks (L and R) on the product. If you connect to only one of the inputs (L or R), you cannot listen to surround sound.
- The Pro Logic II function is only available in Stereo mode.

Listening to Radio

Using buttons on the Remote Control

1. Press the **FUNCTION** button to select **FM**.
2. Tune in to the desired station.
- **Presets** : You can store up to 15 preset frequencies.
 1. Press the **FUNCTION** button to select **FM**.
 2. Tune in to the desired station.
 3. Press the **PRESET** button.
 4. Press the **TUNING/CH** ($\wedge \vee$) button to select the preset number.
- **Manual Tuning** : Press the **STOP** (\blacksquare) button to select **MANUAL** and then press the **TUNING/CH** ($\wedge \vee$) button to tune in to a lower or higher frequency.
- **Automatic Tuning** : Press the **STOP** (\blacksquare) button to select **MANUAL** and then press and hold the **TUNING/CH** ($\wedge \vee$) button to automatically search the band.

Setting Mono/Stereo

Press the **MO/ST** button.



- Each time the button is pressed, the sound switches between **STEREO** and **MONO**.
- In a poor reception area, select **MONO** for a clear, interference-free broadcast.

Presetting Stations

Example : Presetting FM 89.10 in the memory

1. Press the **FUNCTION** button to select **FM**.
2. Press the **TUNING/CH** ($\wedge \vee$) button to select <89.10>.
3. Press the **TUNER MEMORY** button.
 - Number flashes on the display.
4. Press the **TUNING/CH** ($\wedge \vee$) buttons to select preset number.
 - You can select between 1 and 15 presets.
5. Press the **TUNER MEMORY** button again.
 - Press the **TUNER MEMORY** button before number disappears from the display.
 - Number disappears from the display and the station is stored in memory.
6. To preset another station, repeat steps 2 to 5.
 - To tune in to a preset station, press the **TUNING/CH** ($\wedge \vee$) buttons on the remote control to select a channel.

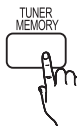

Advanced Functions

USB Function

Playing Media Files using the USB Host Feature

You can enjoy media files such as pictures, movies and music saved on an MP3 player, USB memory stick or digital camera in high quality video with 5.1 channel sound, by connecting the storage device to the USB port of the product.

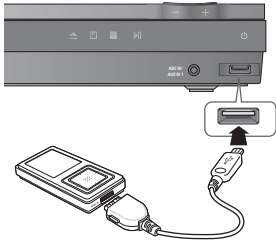

1. Connect the USB device to the USB port on the front panel of the product.
2. Press the **FUNCTION** button to select USB.
 - **USB** appears on the display screen and then disappears.
3. Press the **◀▶** buttons to select **Videos, Photos** or **Music**.
 - Select a file to play.

Safe USB Removal

To prevent damage to the memory stored in the USB device, perform safe removal before disconnecting the USB cable.

- Press the **YELLOW(C)** button.
 - **REMOVE** will appear on the display.
- Remove the USB cable.

NOTE

- To listen to your music files with 5.1 channel sound, you must set the Dolby Pro Logic II mode to Matrix. (See page 39)
- Remove the USB cable from the USB port slowly. Otherwise, it may cause damage.

Using an iPod/iPhone

If the system is connected to iPod/iPhone using the provided USB cable, you can play music in iPod/iPhone using the system.

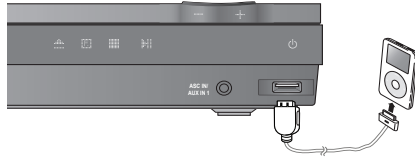

1. Connect iPod/iPhone using the USB cable to the front USB port.
 - Your iPod is automatically turned on.
2. You should press the **FUNCTION** button to switch to **REMOTE IPOD** or **IPOD** mode.

REMOTE IPOD	No video will be displayed on the TV. You can just adjust the volume using the remote control. Play and Search will be enabled only in your iPod player.
IPOD	Video playback and file selection will be enabled on the TV. The remote control can be used for adjusting the volume or playback settings.

Listening to Music (IPOD mode)

You can play music files stored in the iPod by connecting it to the product.

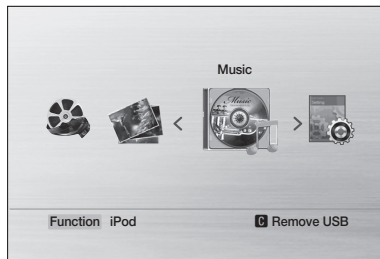

1. Press the **FUNCTION** button to select IPOD.
2. Press the **◀▶** buttons to select Music.

3. Select the music file to play.

- You can use the remote control or product to control simple playback functions such as the **PLAY, PAUSE, STOP, ⏮/ ⏭, ⏪/ ⏩** and **REPEAT** buttons. See page 13.

NOTE

- When you are on the phone and also the iPhone is connected with the product, don't press the **PLAY(▶)** button.
- Adjust the volume to a moderate level before you connect your iPod and product.
- When the product is powered on and you connect an iPod, the product will charge your iPod's battery.

iPod Music categories

File information including the artist name, album name, music title and genre will be displayed according to the ID3 Tag information on the appropriate music file.

Artist	To play by artist.
Generic	To play by genre.
Composers	To play by composer.
Playlist	To play by Playlist.
Album	To play by album.
Songs	To play in numeric or alphabetical order

NOTE

- The category list may differ, depending on the iPod model.
- What is an ID3 Tag?
This is what is attached to an MP3 to carry information relevant to the file such as the title, artist, album, year, genre and a comment field.

iPod/iPhone models that can be used with this product

- iPod touch (3rd generation)
- iPod touch (2nd generation)
- iPod touch (1st generation)
- iPod classic
- iPod with video
- iPod with dock connector
- iPod with Click Wheel
- iPod nano (5th generation)
- iPod nano (4th generation)
- iPod nano (3rd generation)
- iPod nano (2nd generation)
- iPod nano (1st generation)
- iPhone 3GS
- iPhone 3G
- iPhone

NOTE

- "Made for iPod" means that an electronic accessory has been designed to connect specifically to iPod and has been certified by the developer to meet Apple performance standards.
- "Made for iPhone" means that an electronic accessory has been designed to connect specifically to iPhone and has been certified by the developer to meet Apple performance standards.
- Apple is not responsible for the operation of this device or its compliance with safety and regulatory standards.
- The volume control may not operated normally with iPod and iPhone models not listed above. If you have a problem with any of the models listed above, please update the software of the iPod/iPhone to the latest version.
- Depending on the software version of the iPod, control problems may occur. This is not a malfunction of the Home Theater.
- Depending on the software version or the type of the iPod, some operations may differ. Install the latest iPod software. (recommended)
- Playback of applications' contents through the product may not be guaranteed. We recommend playing contents downloaded on the iPod.
- If you have a problem using iPod, please visit www.apple.com/support/ipod



Advanced Functions

USB Recording

While playing CDDA (Compact Disc Digital Audio) using the USB Recording function or listening to the FM radio or receiving audio source from an external device, you can record the audio source in the USB memory.

Ex) USB recording of CDDA audio contents

1. Connect the USB device to your product.
2. Insert the CDDA disc into the CD tray.
3. Press the **USB REC** button on the remote control.
 - To start ripping the current track, press the USB REC button on the remote control while the system is playing a track or stopped temporarily.
 - To record the entire CD, press and hold the USB REC button on the remote control.
 - "FULL CD RIPPING" appears on the display and recording starts.
4. Press the **STOP** (■) button to stop recording.
 - When USB recording of a CD is completed, you will find a new folder named "RECORDING" in the USB drive. The contents will be saved in the folder in the MP3 format.
 - When USB recording of FM radio or AUX source is completed, you will find a new folder named "TUNER RECORDING or AUX RECORDING" in the USB drive. The contents will be saved in the folder in the MP3 format.



- USB Recording works only if the USB device is formatted in the FAT file system. (The NTFS file system is not supported.)
- The audio signal will not be output during USB recording of the CD.
- When HDMI AUDIO is set to On, the USB Recording function is not supported.

NOTE

- Do not disconnect the USB connection or the power cable during the USB Recording. Otherwise, it may cause damage to the data. To stop USB Recording, press the **STOP** button and disconnect the USB device after the system stops playing the CD completely.
- If you disconnect the USB connection during the USB Recording, the system will turn off and you will not be able to delete the recorded file.
- If you connect the USB device to the system while it is playing a CD, the system stops temporarily and will play again.
- DTS-CDs cannot be recorded.
- If the recording duration is less than 5 seconds, a recording file may not be created.

Troubleshooting

Refer to the chart below when this product does not function properly. If the problem you are experiencing is not listed below or if the instruction below does not help, turn off the product, disconnect the power cord, and contact Samsung Electronics at 1-800-SAMSUNG.

Symptom	Check/Remedy
I cannot eject the disc.	<ul style="list-style-type: none"> • Is the power cord plugged securely into the outlet? • Turn off the power and then turn it back on.
The iPod fails to connect.	<ul style="list-style-type: none"> • Check the condition of the iPod connector. • Keep the iPod S/W version up to date.
Playback does not start.	<ul style="list-style-type: none"> • Check the region number of the DVD. DVD discs purchased from abroad may not be playable. • CD-ROMs and DVD-ROMs cannot be played on this product. • Make sure that the rating level is correct.
Playback does not start immediately when the Play/Pause button is pressed.	<ul style="list-style-type: none"> • Are you using a deformed disc or a disc with scratches on the surface? • Wipe the disc clean.
Sound is not produced.	<ul style="list-style-type: none"> • No sound is heard during fast playback, slow playback, and step motion playback. • Are the speakers connected properly? Is the speaker setup correctly customized? • Is the disc severely damaged?
Sound can be heard only from a few speakers and not all 6.	<ul style="list-style-type: none"> • On certain DVD discs, sound is output from the front speakers only. • Check if the speakers are connected properly. • Adjust the volume. • When listening to a CD, radio or TV, sound is output to the front speakers only. Select "PROLOG" by pressing  PL II (Dolby Pro Logic II) on the remote control to use all six speakers.
Dolby Digital 5.1 CH Surround Sound is not produced.	<ul style="list-style-type: none"> • Is there "Dolby Digital 5.1 CH" mark on the disc? Dolby Digital 5.1 CH Surround Sound is produced only if the disc is recorded with 5.1 channel sound. • Is the audio language correctly set to Dolby Digital 5.1-CH in the information display?
The remote control does not work.	<ul style="list-style-type: none"> • Is the remote control being operated within its operation range of angle and distance? • Are the batteries drained? • Have you selected the correct mode(RECEIVER DVD/TV)?
<ul style="list-style-type: none"> • Disc is rotating but no picture is produced. • Picture quality is poor and picture is shaking. 	<ul style="list-style-type: none"> • Is the TV power on? • Are the video cables connected properly? • Is the disc dirty or damaged? • A poorly manufactured disc may not be playable.
Audio language and subtitles do not work.	<ul style="list-style-type: none"> • Audio language and subtitles will not work if the disc does not contain them.
The Disc/Title menu screen does not appear even when the Disc/Title function is selected.	<ul style="list-style-type: none"> • Are you using a disc that does not contain menus?
Aspect ratio cannot be changed.	<ul style="list-style-type: none"> • You can play 16:9 DVDs in 16:9 WIDE mode, 4:3 LETTER BOX mode, or 4:3 PAN SCAN mode, but 4:3 DVDs can be seen in 4:3 ratio only. Refer to the DVD disc jacket and then select the appropriate function.

Other Information

Symptom	Check/Remedy
<ul style="list-style-type: none"> The product is not working. (Example: The power goes out or the front panel key doesn't work or a strange noise is heard.) The product is not working normally. 	<ul style="list-style-type: none"> Press and hold the STOP (■) button on the remote control for longer than 5 seconds with no disc (reset function). <p>Using the RESET function will erase all stored settings. Do not use this unless necessary.</p>
The rating level password has been forgotten.	<ul style="list-style-type: none"> While "NO DISC" message appears on the display of the product, press and hold the remote control's STOP (■) button for longer than 5 seconds. "INIT" appears on the display and all settings will return to the default values. <p>And then press the POWER button.</p> <p>Using the RESET function will erase all stored settings. Do not use this unless necessary.</p>
Can't receive radio broadcast.	<ul style="list-style-type: none"> Is the antenna connected properly? If the antenna's input signal is weak, install an external FM antenna in an area with good reception.

Country code list

Enter the appropriate code number for OTHERS in the Disc Menu, Audio and Subtitle. (See page 31).

Code	Language	Code	Language	Code	Language	Code	Language	Code	Language	Code	Language
1027	Afar	1142	Greek	1239	Interlingue	1345	Malagasy	1482	Kirundi	1527	Tajik
1028	Abkhazian	1144	English	1245	Inupiak	1347	Maori	1483	Romanian	1528	Thai
1032	Afrikaans	1145	Esperanto	1248	Indonesian	1349	Macedonian	1489	Russian	1529	Tigrinya
1039	Amharic	1149	Spanish	1253	Icelandic	1350	Malayalam	1491	Kinyarwanda	1531	Turkmen
1044	Arabic	1150	Estonian	1254	Italian	1352	Mongolian	1495	Sanskrit	1532	Tagalog
1045	Assamese	1151	Basque	1257	Hebrew	1353	Moldavian	1498	Sindhi	1534	Setswana
1051	Aymara	1157	Persian	1261	Japanese	1356	Marathi	1501	Sangro	1535	Tonga
1052	Azerbaijani	1165	Finnish	1269	Yiddish	1357	Malay	1502	Serbo-Croatian	1538	Turkish
1053	Bashkir	1166	Fiji	1283	Javanese	1358	Maltese	1503	Singhalese	1539	Tsonga
1057	Byelorussian	1171	Faeroese	1287	Georgian	1363	Burmese	1505	Slovak	1540	Tatar
1059	Bulgarian	1174	French	1297	Kazakh	1365	Nauru	1506	Slovenian	1543	Twí
1060	Bihari	1181	Frisian	1298	Greenlandic	1369	Nepali	1507	Samoan	1557	Ukrainian
1069	Bislama	1183	Irish	1299	Cambodian	1376	Dutch	1508	Shona	1564	Urdu
1066	Bengali; Bangla	1186	Scots Gaelic	1300	Canada	1379	Norwegian	1509	Somali	1572	Uzbek
1067	Tibetan	1194	Galician	1301	Korean	1393	Occitan	1511	Albanian	1581	Vietnamese
1070	Breton	1196	Guarani	1305	Kashmiri	1403	(Afar) Oromo	1512	Serbian	1587	Volapuk
1079	Catalan	1203	Gujarati	1307	Kurdish	1408	Oryya	1513	Siswati	1613	Wolof
1093	Corsican	1209	Hausa	1311	Kirghiz	1417	Punjabi	1514	Sesotho	1632	Xhosa
1097	Czech	1217	Hindi	1313	Latin	1428	Polish	1515	Sundanese	1665	Yoruba
1103	Welsh	1226	Croatian	1326	Lingala	1435	Pashto, Pushto	1516	Swedish	1684	Chinese
1105	Danish	1229	Hungarian	1327	Laotian	1436	Portuguese	1517	Swahili	1697	Zulu
1109	German	1233	Armenian	1332	Lithuanian	1463	Quechua	1521	Tamil		
1130	Bhutani	1235	Interlingua	1334	Latvian, Lettish	1481	Rhaeto-Romance	1525	Tegulu		

Index

A

Accessories	3
Angle	37
Anynet+(HDMI-CEC)	22
Audio Language	36
AUDIO SYNC	29

B

BD Wise	26
Before Starting (Initial Setting)	25

C

Change Password	31
Connections	15
Speaker	16
Wireless receiver module	19
TV	21
HDMI	21
Component	21
Composite	21
AUX	24
FM Antenna	23
Set-Top Box	24
VCR	24
OPTICAL	24

D

Delay Time	27
DIMMER	37
Disc Information	36
Disc menu	34
DivX(R) Registration	30
Dolby Pro Logic II Mode	39
DRC (Dynamic Range Compression)	29
DSP/EQ	38

G

GIGA	38
------	----

H

HDMI Audio	30
HDMI Format	26

I

Initial Setting	30
iPod/iPhone	40

L

Language	31
----------	----

M

Mono/Stereo	39
-------------	----

P

P. BASS	37
Parental Rating	31
Product Information	31
Power Saving	32

R

Region code	8
Remote Control	13
Remote control sensor	11
Repeat	35
Resolution	26

S

Search	33
Setting the Setup Menu	25
Setup	25
Skip	33
SLEEP(timer)	37
Slow motion	33
Sound Edit	27
Speaker Setting	27
Speaker Size	27
Step motion	34
Subtitle Language	36
S.VOL (SMART VOLUME)	38
S/W LEVEL	38

T

Test Tone	28
Title menu	34
TV Aspect	26
TV Screen Saver	32

U

User EQ	30
USB Storage	40
USB REC	42

Other Information

Specifications

General	Power Requirements	AC 120V, 60Hz
	Power Consumption	67W
	Weight	5.95 lbs
	Dimensions	16.9 (W) x 2.1 (H) x 9.8 (D) inches
	Operating Temperature Range	+41°F to +95°F
	Operating Humidity Range	10 % to 75 %
FM Tuner	Signal/noise ratio	70 dB
	Usable sensitivity	10 dB
	Total harmonic distortion	0.5 %
Disc	DVD (Digital Versatile Disc)	Reading Speed : 3.49 ~ 4.06 m/sec. Approx. Play Time (Single Sided, Single Layer Disc) : 135 min.
	CD : 5 inches (COMPACT DISC)	Reading Speed : 4.8 ~ 5.6 m/sec. Maximum Play Time : 74 min.
	CD : 3 1/2 inches (COMPACT DISC)	Reading Speed : 4.8 ~ 5.6 m/sec. Maximum Play Time : 20 min.
Video Output	Composite Video	480i 1 channel : 1.0 Vp-p (75 Ω load)
	Component Video	480i
		Y : 1.0 Vp-p (75 Ω load)
		Pr : 0.70 Vp-p (75 Ω load) Pb : 0.70 Vp-p (75 Ω load)
Video/Audio	HDMI	1080p, 1080i, 720p, 480p
Amplifier	Front speaker output	167W x 2(3Ω)
	Center speaker output	167W(3Ω)
	Surround speaker output	166W x 2(3Ω)
	Subwoofer output	167W(3Ω)
	Frequency range	20Hz~20KHz
	S/N Ratio	65dB
	Channel separation	60dB
	Input sensitivity	(AUX)800mV

*: Nominal specification

- Samsung Electronics Co., Ltd reserves the right to change the specifications without notice.
- Weight and dimensions are approximate.
- Design and specifications are subject to change without prior notice.

Specifications

HT-D550

Speaker	Speaker system	5.1 ch speaker system			
		Front	Surround	Center	Subwoofer
	Impedance	3 Ω	3 Ω	3 Ω	3 Ω
	Frequency range	140Hz~20KHz	140Hz~20KHz	140Hz~20KHz	40Hz~160Hz
	Output sound pressure level	86dB/W/M	86dB/W/M	86dB/W/M	88dB/W/M
	Rated input	167W	166W	167W	167W
	Maximum input	334W	332W	334W	334W
	Dimensions (W x H x D)	Front : 3.54 x 5.5 x 2.75 inches Surround : 3.03 x 4.25 x 2.75 inches Center : 8.97 x 3.03 x 2.75 inches Subwoofer : 6.61 x 13.78 x 11.22 inches			
	Weights	Front : 0.85 lbs, Surround : 0.82 lbs Center : 1.06 lbs, Subwoofer : 8.38 lbs			

HT-D553

Speaker	Speaker system	5.1 ch speaker system			
		Front	Surround	Center	Subwoofer
	Impedance	3 Ω	3 Ω	3 Ω	3 Ω
	Frequency range	140Hz~20KHz	140Hz~20KHz	140Hz~20KHz	40Hz~160Hz
	Output sound pressure level	86dB/W/M	86dB/W/M	86dB/W/M	88dB/W/M
	Rated input	167W	166W	167W	167W
	Maximum input	334W	332W	334W	334W
	Dimensions (W x H x D)	Front : 3.54 x 51.18 x 4.69 inches (stand base : 9.84 x 9.84) Surround : 3.54 x 5.57 x 2.7 inches Center : 14.17 x 2.93 x 2.7 inches Subwoofer : 6.61 x 13.78 x 11.22 inches			
	Weights	Front : 8.11 lbs, Surround : 1.28 lbs Center : 1.26 lbs, Subwoofer : 8.38 lbs			

HT-D555

Speaker	Speaker system	5.1 ch speaker system			
		Front	Surround	Center	Subwoofer
	Impedance	3 Ω	3 Ω	3 Ω	3 Ω
	Frequency range	140Hz~20KHz	140Hz~20KHz	140Hz~20KHz	40Hz~160Hz
	Output sound pressure level	86dB/W/M	86dB/W/M	86dB/W/M	88dB/W/M
	Rated input	167W	166W	167W	167W
	Maximum input	334W	332W	334W	334W
	Dimensions (W x H x D)	Front/Surround : 3.54 x 51.18 x 4.69 inches (stand base : 9.84 x 9.84) Center : 14.17 x 2.93 x 2.7 inches Subwoofer : 6.61 x 13.78 x 11.22 inches			
	Weights	Front/Surround : 8.11 lbs, Center : 1.26 lbs Subwoofer : 8.38 lbs			

LIMITED WARRANTY TO ORIGINAL PURCHASER

This SAMSUNG brand product, as supplied and distributed by SAMSUNG and delivered new, in the original carton to the original consumer purchaser, is warranted by SAMSUNG against manufacturing defects in materials and workmanship for a limited warranty period of:

One (1) Year Parts and Labor*

(*90 Days Parts and Labor for Commercial Use)

This limited warranty begins on the original date of purchase, and is valid only on products purchased and used in the United States. To receive warranty service, the purchaser must contact SAMSUNG for problem determination and service procedures. Warranty service can only be performed by a SAMSUNG authorized service center. The original dated bill of sale must be presented upon request as proof of purchase to SAMSUNG or SAMSUNG's authorized service center. Transportation of the product to and from the service center is the responsibility of the purchaser.

SAMSUNG will repair or replace this product, at our option and at no charge as stipulated herein, with new or reconditioned parts or products if found to be defective during the limited warranty period specified above. All replaced parts and products become the property of SAMSUNG and must be returned to SAMSUNG. Replacement parts and products assume the remaining original warranty, or ninety (90) days, whichever is longer.

SAMSUNG's obligations with respect to software products distributed by SAMSUNG under the SAMSUNG brand name are set forth in the applicable end user license agreement. Non-SAMSUNG hardware and software products, if provided, are on an "AS IS" basis. Non-SAMSUNG manufacturers, suppliers, publishers, and service providers may provide their own warranties.

This limited warranty covers manufacturing defects in materials and workmanship encountered in normal, and except to the extent otherwise expressly provided for in this statement, noncommercial use of this product, and shall not apply to the following, including, but not limited to: damage which occurs in shipment; delivery and installation; applications and uses for which this product was not intended; altered product or serial numbers; cosmetic damage or exterior finish; accidents, abuse, neglect, fire, water, lightning or other acts of nature; use of products, equipment, systems, utilities, services, parts, supplies, accessories, applications, installations, repairs, external wiring or connectors not supplied and authorized by SAMSUNG, or which damage this product or result in service problems; incorrect electrical line voltage, fluctuations and surges; customer adjustments and failure to follow operating instructions, cleaning, maintenance and environmental instructions that are covered and prescribed in the instruction book; product removal or reinstallation; reception problems and distortion related to noise, echo, interference or other signal transmission and delivery problems. SAMSUNG does not warrant uninterrupted or error-free operation of the product.

THERE ARE NO EXPRESS WARRANTIES OTHER THAN THOSE LISTED AND DESCRIBED ABOVE, AND NO WARRANTIES WHETHER EXPRESS OR IMPLIED, INCLUDING, BUT NOT LIMITED TO, ANY IMPLIED WARRANTIES OF MERCHANTABILITY OR FITNESS FOR A PARTICULAR PURPOSE, SHALL APPLY AFTER THE EXPRESS WARRANTY PERIODS STATED ABOVE, AND NO OTHER EXPRESS WARRANTY OR GUARANTY GIVEN BY ANY PERSON, FIRM OR CORPORATION WITH RESPECT TO THIS PRODUCT SHALL BE BINDING ON SAMSUNG. SAMSUNG SHALL NOT BE LIABLE FOR LOSS OF REVENUE OR PROFITS, FAILURE TO REALIZE SAVINGS OR OTHER BENEFITS, OR ANY OTHER SPECIAL, INCIDENTAL OR CONSEQUENTIAL DAMAGES CAUSED BY THE USE, MISUSE OR INABILITY TO USE THIS PRODUCT, REGARDLESS OF THE LEGAL THEORY ON WHICH THE CLAIM IS BASED, AND EVEN IF SAMSUNG HAS BEEN ADVISED OF THE POSSIBILITY OF SUCH DAMAGES. NOR SHALL RECOVERY OF ANY KIND AGAINST SAMSUNG BE GREATER IN AMOUNT THAN THE PURCHASE PRICE OF THE PRODUCT SOLD BY SAMSUNG AND CAUSING THE ALLEGED DAMAGE. WITHOUT LIMITING THE FOREGOING, PURCHASER ASSUMES ALL RISK AND LIABILITY FOR LOSS, DAMAGE OR INJURY TO PURCHASER AND PURCHASER'S PROPERTY AND TO OTHERS AND THEIR PROPERTY ARISING OUT OF THE USE, MISUSE OR INABILITY TO USE THIS PRODUCT SOLD BY SAMSUNG NOT CAUSED DIRECTLY BY THE NEGLIGENCE OF SAMSUNG. THIS LIMITED WARRANTY SHALL NOT EXTEND TO ANYONE OTHER THAN THE ORIGINAL PURCHASER OF THIS PRODUCT, IS NONTRANSFERABLE AND STATES YOUR EXCLUSIVE REMEDY.

Some states do not allow limitations on how long an implied warranty lasts, or the exclusion or limitation of incidental or consequential damages, so the above limitations or exclusions may not apply to you. This warranty gives you specific legal rights, and you may also have other rights which vary from state to state.

To obtain warranty service, please contact SAMSUNG customer care center.

Contact SAMSUNG WORLD WIDE

If you have any questions or comments relating to Samsung products, please contact the SAMSUNG customer care center.

Area	Contact Center ☎	Web Site
■ North America		
Canada	1-800-SAMSUNG (726-7864)	www.samsung.com
Mexico	01-800-SAMSUNG (726-7864)	www.samsung.com
U.S.A	1-800-SAMSUNG (726-7864)	www.samsung.com
■ Latin America		
Argentina	0800-333-3733	www.samsung.com
Brazil	0800-124-421 / 4004-0000	www.samsung.com
Chile	800-SAMSUNG (726-7864)	www.samsung.com
Colombia	01-8000112112	www.samsung.com
Costa Rica	0-800-507-7267	www.samsung.com
Dominica	1-800-751-2676	www.samsung.com
Ecuador	1-800-10-7267	www.samsung.com
El Salvador	800-6225	www.samsung.com
Guatemala	1-800-299-0013	www.samsung.com
Honduras	800-7919267	www.samsung.com
Jamaica	1-800-234-7267	www.samsung.com
Nicaragua	00-1800-5077267	www.samsung.com
Panama	800-7267	www.samsung.com
Peru	0-800-777-08	www.samsung.com
Puerto Rico	1-800-682-3180	www.samsung.com
Trinidad & Tobago	1-800-SAMSUNG (726-7864)	www.samsung.com
Venezuela	0-800-100-5303	www.samsung.com
■ Europe		
Albania	42 27 5755	-
Austria	0810 - SAMSUNG (7267864, € 0.07/min)	www.samsung.com
Belgium	02-201-24-18	www.samsung.com/ be (Dutch) www.samsung.com/ be_fr (French)
Bosnia	05 133 1999	-
Bulgaria	07001 33 11	www.samsung.com
Croatia	062 SAMSUNG (062 726 7864)	www.samsung.com
Czech	800-SAMSUNG (800-726786) Samsung Zrt., česká organizační složka, Oasis Florenc, Soko- lovská394/17, 180 00, Praha 8	www.samsung.com
Denmark	70 70 19 70	www.samsung.com
Finland	030 - 6227 515	www.samsung.com
France	01 48 63 00 00	www.samsung.com
Germany	01805 - SAMSUNG (726-7864 € 0,14/Min)	www.samsung.com
Hungary	06-80-SAMSUNG (726-7864)	www.samsung.com
Italia	800-SAMSUNG (726-7864)	www.samsung.com
Kosovo	+381 0113216899	-
Luxemburg	261 03 710	www.samsung.com
Macedonia	023 207 777	-
Montenegro	020 405 888	-
Netherlands	0900-SAMSUNG (0900-7267864) (€ 0,10/Min)	www.samsung.com
Norway	815-56 480	www.samsung.com
Poland	0 801 1SAMSUNG (172678) / 022-607-93-33	www.samsung.com
Portugal	80820-SAMSUNG (726-7864)	www.samsung.com
Rumania	1. 08010 SAMSUNG (72678) - doar din rețeaua Romtelecom, tarif local 2. 021.206.01.10 - din orice rețea, tarif normal	www.samsung.com

Area	Contact Center ☎	Web Site
Serbia	0700 Samsung (0700 726 7864)	www.samsung.com
Slovakia	0800-SAMSUNG (726-7864)	www.samsung.com
Spain	902-1-SAMSUNG (902 172 678)	www.samsung.com
Sweden	0771 726 7864 (SAMSUNG)	www.samsung.com
Switzerland	0848-SAMSUNG (7267864, CHF 0.08/min)	www.samsung.com/ch www.samsung.com/ ch_fr(French)
U.K	0330 SAMSUNG (7267864)	www.samsung.com
Eire	0818 717100	www.samsung.com
Lithuania	8-800-77777	www.samsung.com
Latvia	8000-7267	www.samsung.com
Estonia	800-7267	www.samsung.com
■ CIS		
Russia	8-800-555-55-55	www.samsung.com
Georgia	8-800-555-555	-
Armenia	0-800-05-555	-
Azerbaijan	088-55-55-555	-
Kazakhstan	8-10-800-500-55-500 (GSM: 7799)	www.samsung.com
Uzbekistan	8-10-800-500-55-500	www.samsung.com
Kyrgyzstan	00-800-500-55-500	www.samsung.com
Tadjikistan	8-10-800-500-55-500	www.samsung.com
Ukraine	0-800-502-000	www.samsung.ua www.samsung.com/ ua_ru
Belarus	810-800-500-55-500	-
Moldova	00-800-500-55-500	-
■ Asia Pacific		
Australia	1300 362 603	www.samsung.com
New Zealand	0800 SAMSUNG (0800 726 786)	www.samsung.com
China	400-810-5858 / 010-6475 1880	www.samsung.com
Hong Kong	(852) 3698 4698	www.samsung.com/hk www.samsung.com/ hk_en/
India	3030 8282 / 1800 110011 / 1800 3000 8282 / 1800 266 8282	www.samsung.com
Indonesia	0800-112-8888 / 021-5699-7777	www.samsung.com
Japan	0120-327-527	www.samsung.com
Malaysia	1800-88-9999	www.samsung.com
Philippines	1-800-10-SAMSUNG(726-7864) / 1-800-3-SAMSUNG(726-7864) / 1-800-8-SAMSUNG(726-7864) / 02-5805777	www.samsung.com
Singapore	1800-SAMSUNG (726-7864)	www.samsung.com
Thailand	1800-29-3232 / 02-689-3232	www.samsung.com
Taiwan	0800-329-999	www.samsung.com
Vietnam	1 800 588 889	www.samsung.com
■ Middle East		
Bahrain	8000-4726	www.samsung.com
Egypt	08000-726786	www.samsung.com
Jordan	800-22273	www.samsung.com
Morocco	080 100 2255	www.samsung.com
Oman	800-SAMSUNG (726-7864)	www.samsung.com
Saudi Arabia	9200-21230	www.samsung.com
Turkey	444 77 11	www.samsung.com
U.A.E	800-SAMSUNG (726-7864)	www.samsung.com
■ Africa		
Nigeria	0800-SAMSUNG (726-7864)	www.samsung.com
South Africa	0860-SAMSUNG (726-7864)	www.samsung.com



QUESTIONS OR COMMENTS?

COUNTRY	CALL	OR VISIT US ONLINE AT	WRITE
IN THE US	1-800-SAMSUNG (7267864)	www.samsung.com/us	Samsung Electronics America, Inc. 85 Challenger Road Ridgefield Park, NJ 07660-2112

Code No. AH68-02333R

Free Manuals Download Website

<http://myh66.com>

<http://usermanuals.us>

<http://www.somanuals.com>

<http://www.4manuals.cc>

<http://www.manual-lib.com>

<http://www.404manual.com>

<http://www.luxmanual.com>

<http://aubethermostatmanual.com>

Golf course search by state

<http://golfingnear.com>

Email search by domain

<http://emailbydomain.com>

Auto manuals search

<http://auto.somanuals.com>

TV manuals search

<http://tv.somanuals.com>