

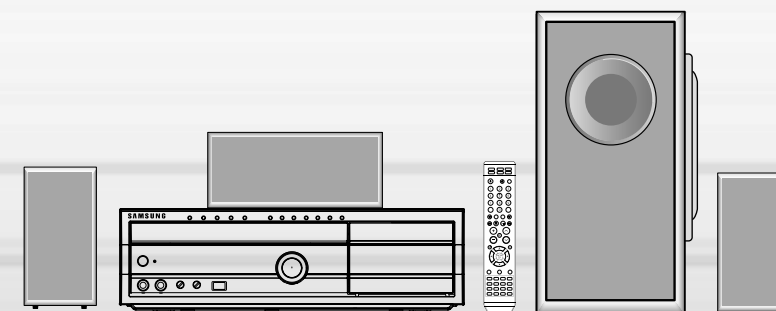

# 3.1CH COMPACT HOME CINEMA SYSTEM HT-DT79

THIS APPLIANCE IS MANUFACTURED BY:

## Instruction Manual



AH68-01839B



# Safety Warnings

CLASS 1 LASER PRODUCT  
KLASSE 1 LASER PRODUKT  
LUOKAN 1 LASER LAITE  
KLASS 1 LASER APPARAT  
PRODUCTO LASER CLASE 1



**CAUTION**  
RISK OF ELECTRIC SHOCK.  
DO NOT OPEN



**CAUTION:**  
TO REDUCE THE RISK OF ELECTRIC SHOCK, DO NOT REMOVE REAR COVER. NO USER SERVICEABLE PARTS INSIDE. REFER SERVICING TO QUALIFIED SERVICE PERSONNEL.

## CLASS 1 LASER PRODUCT

This Compact Disc player is classified as a CLASS 1 LASER product.

- This apparatus shall always be connected to a AC outlet with a protective grounding connection.
- To disconnect the apparatus from the mains, the plug must be pulled out from the mains socket, therefore the mains plug shall be readily operable.

Use of controls, adjustments or performance of procedures other than those specified herein may result in hazardous radiation exposure.

### CAUTION-INVISIBLE LASER RADIATION WHEN OPEN AND INTERLOCKS DEFEATED, AVOID EXPOSURE TO BEAM.



This symbol indicates that dangerous voltage which can cause electric shock is present inside this unit.



This symbol alerts you to important operating and maintenance instructions accompanying the unit.

**WARNING:** To reduce the risk of fire or electric shock, do not expose this appliance to rain or moisture.

**CAUTION:** TO PREVENT ELECTRIC SHOCK, MATCH WIDE BLADE OF PLUG TO WIDE SLOT, FULLY INSERT.

# Precautions

GB

PREPARATION

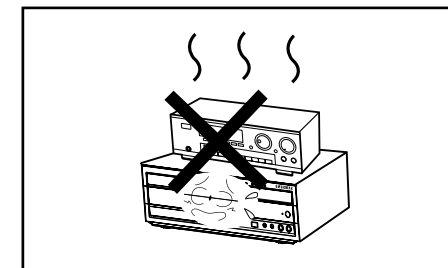
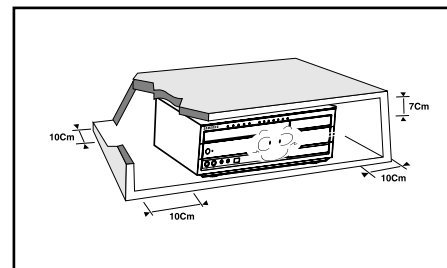

Ensure that the AC power supply in your house complies with the identification sticker located on the back of your player. Install your player horizontally, on a suitable base (furniture), with enough space around it for ventilation (7.5~10cm). Make sure the ventilation slots are not covered. Do not stack anything on top of the player. Do not place the player on amplifiers or other equipment which may become hot. Before moving the player, ensure the disc tray is empty. This player is designed for continuous use. Switching off the DVD player to the stand-by mode does not disconnect the electrical supply. In order to disconnect the player completely from the power supply, remove the main plug from the wall outlet, especially when left unused for a long period of time.

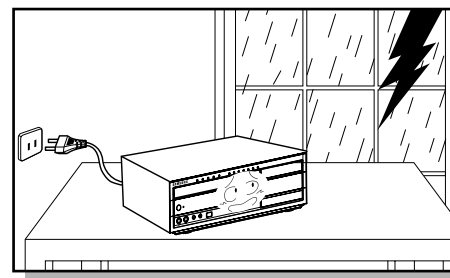

During thunderstorms, disconnect AC main plug from the wall outlet. Voltage peaks due to lightning could damage the unit.

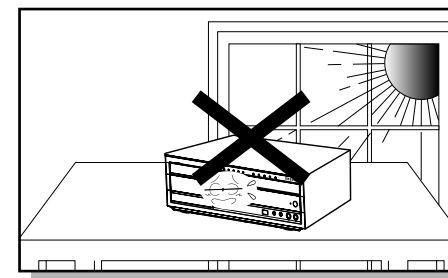

Do not expose the unit to direct sunlight or other heat sources. This could lead to overheating and malfunction of the unit.

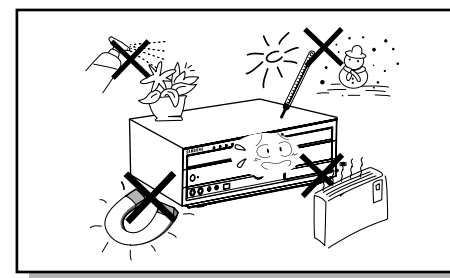

Protect the player from moisture (i.e. vases), and excess heat (e.g. fireplace) or equipment creating strong magnetic or electric fields (i.e. speakers...). Disconnect the power cable from the AC supply if the player malfunctions. Your player is not intended for industrial use. Use of this product is for personal use only. Condensation may occur if your player or disc has been stored in cold temperatures. If transporting the player during the winter, wait approximately 2 hours until the unit has reached room temperature before using.

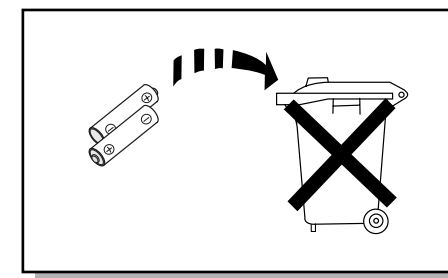

The batteries used with this product contain chemicals that are harmful to the environment. Do not dispose of batteries in the general household trash.

# Features

## ● Multi-Disc Playback & FM Tuner

The HT-DT79 combines the convenience of multi-disc playback capability, including DVD-VIDEO, VCD, CD, MP3-CD, WMA-CD, DivX, CD-R/RW, and DVD-R/RW, with a sophisticated FM tuner, all in a single player.

## ● USB HOST Function support

You can connect and play files from external USB storage devices such as MP3 players, USB flash memory, etc. using the Home Theater's USB HOST function.

## ● TV Screen Saver Function

The HT-DT79 automatically brightens and darkens your TV screen after 3 minutes in the stop mode.

The HT-DT79 automatically switches itself into the power saving mode after 20 minutes in the screen saver mode.

## ● Power Saving Function

The HT-DT79 automatically shuts itself off after 20 minutes in stop mode.

## ● Customized TV Screen Display

The HT-DT79 allows you to select your favorite image during JPEG, DVD or VCD playback and set it as your background wallpaper.

# Contents

## ● PREPARATION

Safety Warnings	1
Precautions	2
Features	3
Notes on Discs	5
Description	7

## ● CONNECTIONS

Connecting the Speakers	11
Connecting the Video Out to TV	13
P.SCAN(Progressive Scan) Function	14
Connecting External Components	15
Connecting the FM and AM Antenna	16

## ● OPERATION

Before Using Your Home Theater	17
Disc Playback	18
Selecting a Disc in the Disc changer	19
MP3/WMA-CD Playback	20
Displaying Disc Information	21
JPEG File Playback	22
DivX Playback	24
Checking the Remaining Time	26
Fast/Slow Playback	27
Repeat Playback	28
A-B Repeat Playback	29
Step Function	30
Angle Function	30
Zoom (Screen Enlarge) Function	31
EZ VIEW Function	31
Selecting Audio Language	32
Selecting Subtitle Language	33
Playing Media Files using the USB HOST feature	34
Moving Directly to a Scene/Song	36
Using Disc Menu	37
Using the Title Menu	38

## ● SETUP

Setting the Language	39
Setting TV Screen type	41
Setting Parental Controls (Rating Level)	43
Setting the Password	44
Setting the Wallpaper	45
DivX (R) registration	47
Setting the DRC (Dynamic Range Compression)	48
Setting the Audio	49
AV SYNC Setup	50
Sound Field (DSP)/EQ Function	51

## ● RADIO OPERATION

Listening to Radio	52
Presetting Stations	53

## ● TAPE DECK

Listening to a Cassette	54
Selecting the Cassette Playback Mode	55
Tape Counter	55
Recording a Compact Disc	56
Recording a Radio Program	57

## ● MISCELLANEOUS

Convenient Functions	59
Connecting Microphone	60
Operating a TV with the Remote Control	61
Before Calling for Service	63
Cautions on Handling and Storing Discs	65
Language Code List	66
USB Host Feature Supported Products	67
Specifications	68



**DVD (Digital Versatile Disc)** offers fantastic audio and video, thanks to Dolby Digital surround sound and MPEG-2 video compression technology. Now you can enjoy these realistic effects in the home, as if you were in a movie theater or concert hall.



DVD players and the discs are coded by region. These regional codes must match in order for the disc to play. If the codes do not match, the disc will not play.

The Region Number for this player is given on the rear panel of the player.  
(Your DVD player will only play DVDs that are labeled with identical region codes.)

## Playable Discs

Disc Type	Mark (Logo)	Recorded Signals	Disc Size	Max. Playing Time
DVD-VIDEO		Video	12cm	Approx. 240 min. (single-sided) Approx. 480 min. (double-sided)
			8cm	Approx. 80 min. (single-sided) Approx. 160 min. (double-sided)
AUDIO-CD VIDEO-CD		Audio Audio + Video	12cm 8cm	74 min. 20 min.
Divx		MPEG4 MP3	12cm	74 min.
			8cm	20 min.

## Do not use the following types of disc!

- LD, CD-G, CD-I, CD-ROM and DVD-ROM discs cannot be played on this player. If such discs are played, a "WRONG DISC FORMAT" message appears on the TV screen.
- DVD discs purchased abroad may not play on this player. If such discs are played, a "WRONG REGION CODE" message appears on the TV screen.

## Copy Protection

- Many DVD discs are encoded with copy protection. Because of this, you should only connect your DVD player directly to your TV, not to a VCR. Connecting to a VCR results in a distorted picture from copy-protected DVD discs.
- This product incorporates copyright protection technology that is protected by methods claims of certain U.S. patents and other intellectual property rights owned by Macrovision Corporation and other rights owners. Use of this copyright protection technology must be authorized by Macrovision Corporation, and is intended for home and other limited viewing uses only unless otherwise authorized by Macrovision Corporation. Reverse engineering or disassembly is prohibited.

## Disc Recording Format

**This product does not support Secure (DRM) Media files.**

### CD-R Discs

- Some CD-R discs may not be playable depending on the disc recording device (CD-Recorder or PC) and the condition of the disc.
- Use a 650MB/74 minute CD-R disc.  
Do not use CD-R discs over 700MB/80 minute as they may not be played back.
- Some CD-RW (Rewritable) media, may not be playable.
- Only CD-Rs that are properly "closed" can be fully played. If the session is closed but the disc is left open, you may not be able to fully play the disc.

### CD-R MP3 Discs

- Only CD-R discs with MP3 files in ISO 9660 or Joliet format can be played.
- MP3 file names should be 8 characters or less in length and contain no blank spaces or special characters (. / = +).
- Use discs recorded with a compression/decompression data rate greater than 128Kbps.
- Only files with the ".mp3" and ".MP3" extensions can be played.
- Only a consecutively written Multisession disc can be played. If there is a blank segment in the Multisession disc, the disc can be played only up to the blank segment.
- If the disc is not closed, it will take longer to begin playback and not all of the recorded files may be played.
- For files encoded in Variable Bit Rate (VBR) format, i.e. files encoded in both low bit rate and high bit rate (e.g., 32Kbps ~ 320Kbps), the sound may skip during playback.
- A maximum of 500 tracks can be played per CD.
- A maximum of 300 folders can be played per CD.

### CD-R JPEG Discs

- Only files with the ".jpeg" and ".JPEG" extensions can be played.
- If the disc is not closed, it will take longer to start playing and not all of the recorded files may be played.
- Only CD-R discs with JPEG files in ISO 9660 or Joliet format can be played.
- JPEG file names should be 8 characters or less in length and contain no blank spaces or special characters (. / = +).
- Only a consecutively written multisession disc can be played. If there is a blank segment in the multisession disc, the disc can be played only up to the blank segment.
- A maximum of 9,999 images can be stored on a single CD.
- When playing a Kodak/Fuji Picture CD, only the JPEG files in the picture folder can be played.
- Picture discs other than Kodak/Fuji Picture CDs may take longer to start playing or may not play at all.

### CD-R/RW DivX Discs

- Since this product only provides encoding formats authorized by DivX Networks, Inc., a DivX file created by the user might not be played.
- Software update for unsupported formats is not supported.  
(Example: QPEL, GMC, resolution higher than 720 x 480 pixels, etc.)
- Sections with high frame rate might not be played while playing a DivX file.
- For more information about the formats authorized by DivX Networks, Inc., visit "www.divxnetworks.net".



# Description

## —Front Panel—

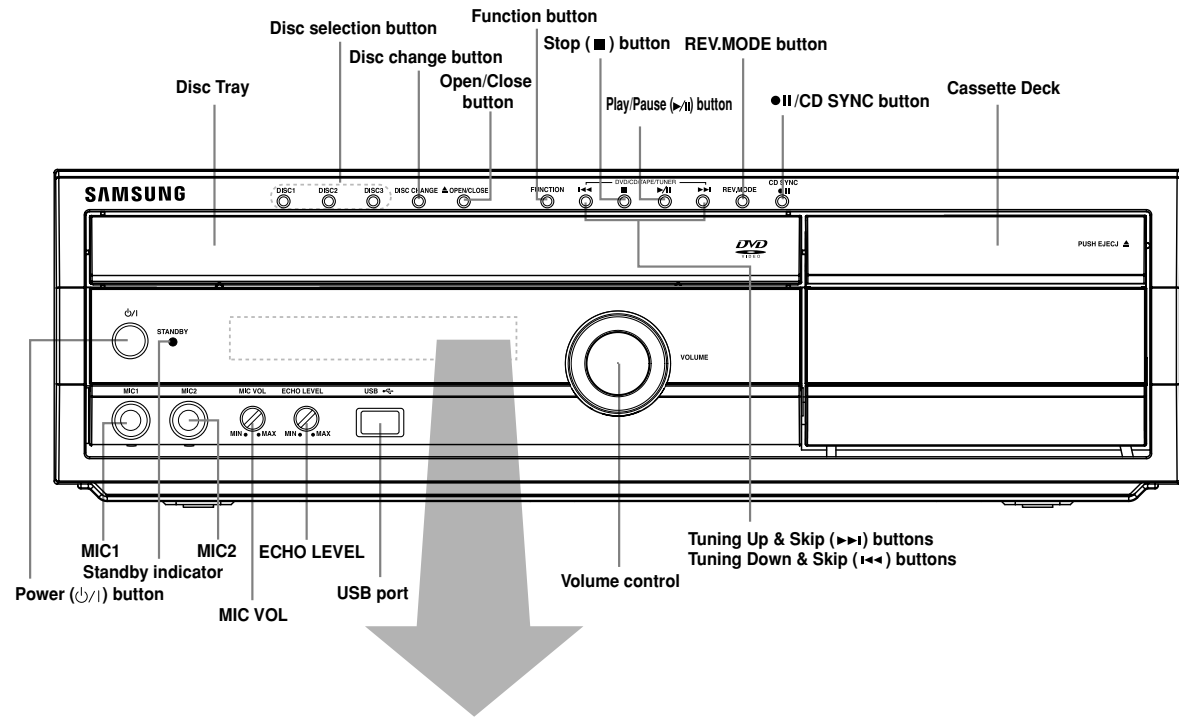

## —Rear Panel—

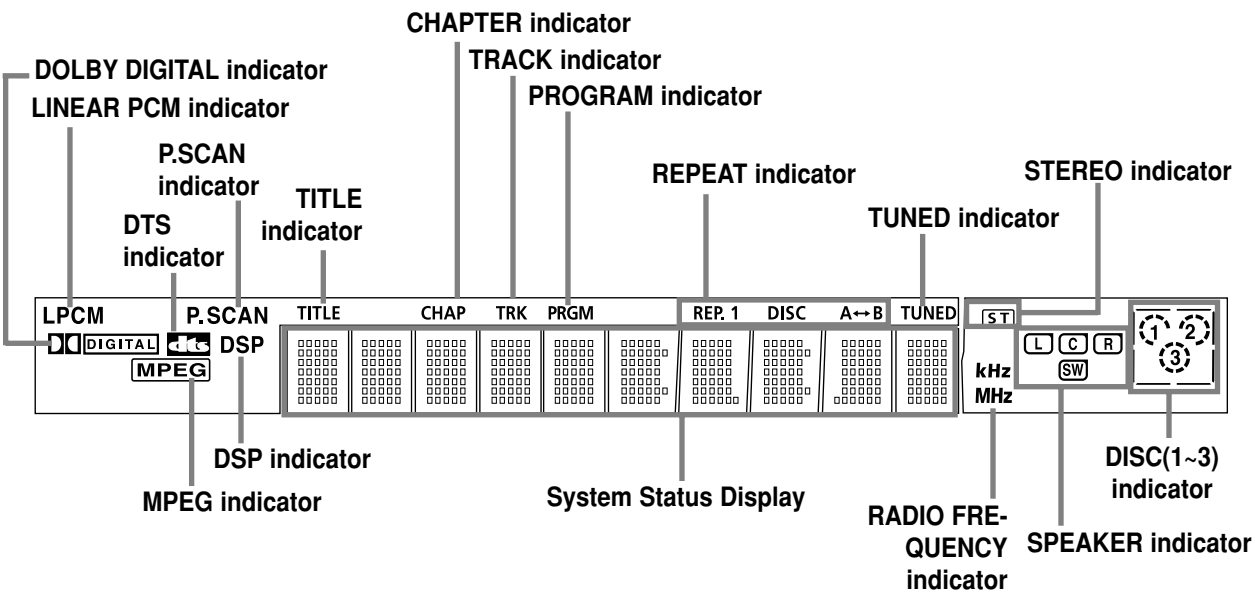
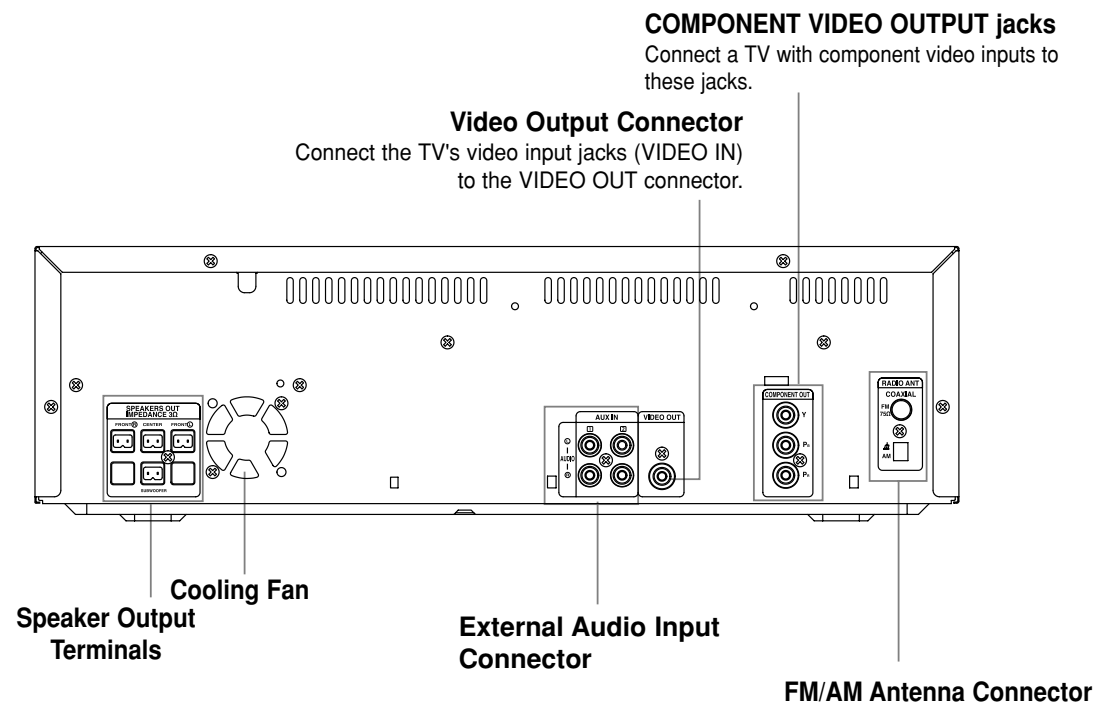

## Accessories

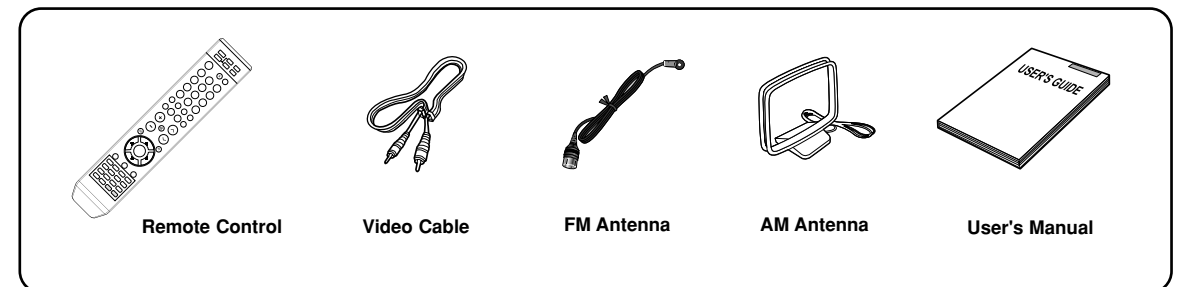

## —Remote Control—

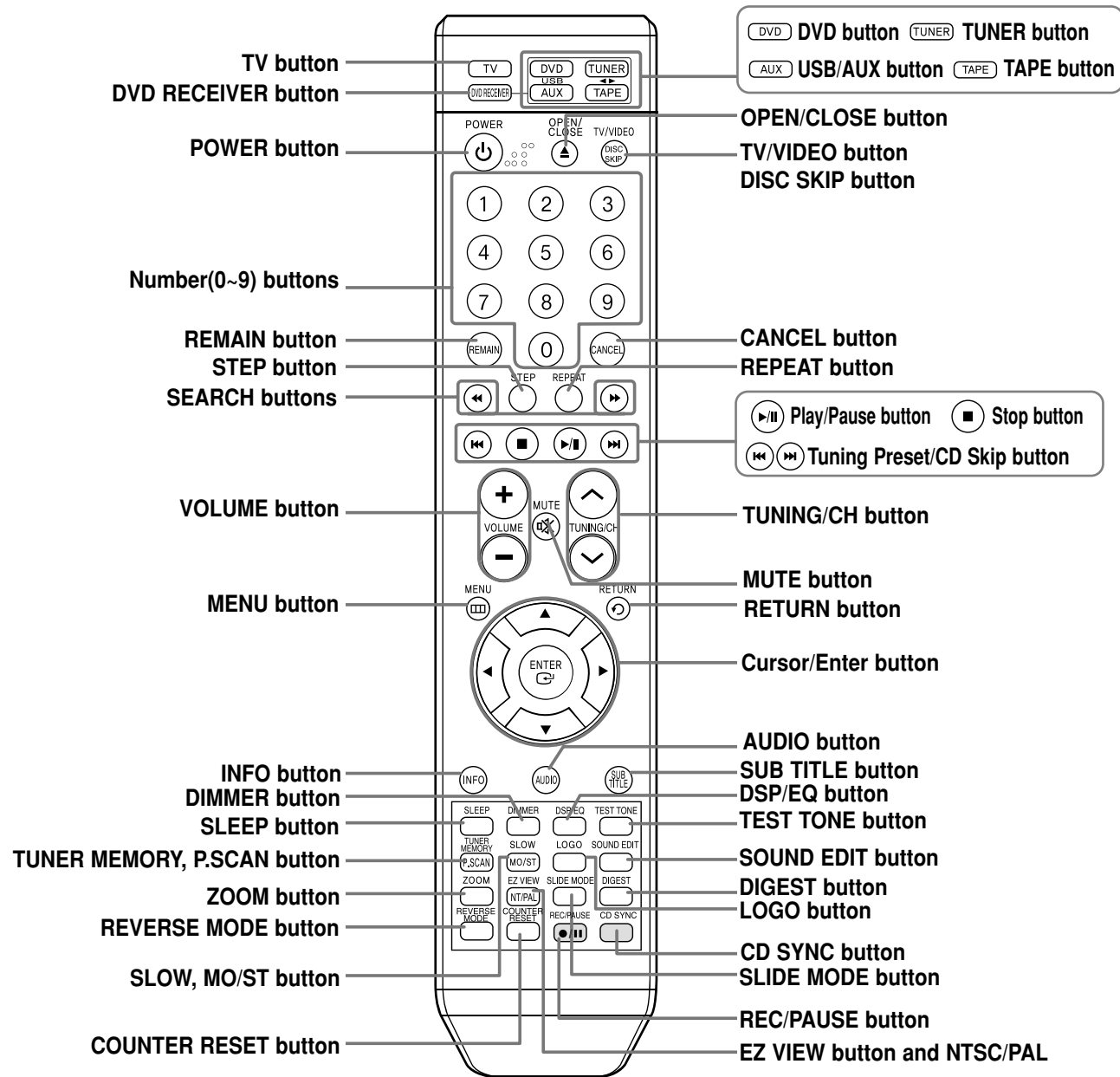

### Insert Remote Batteries

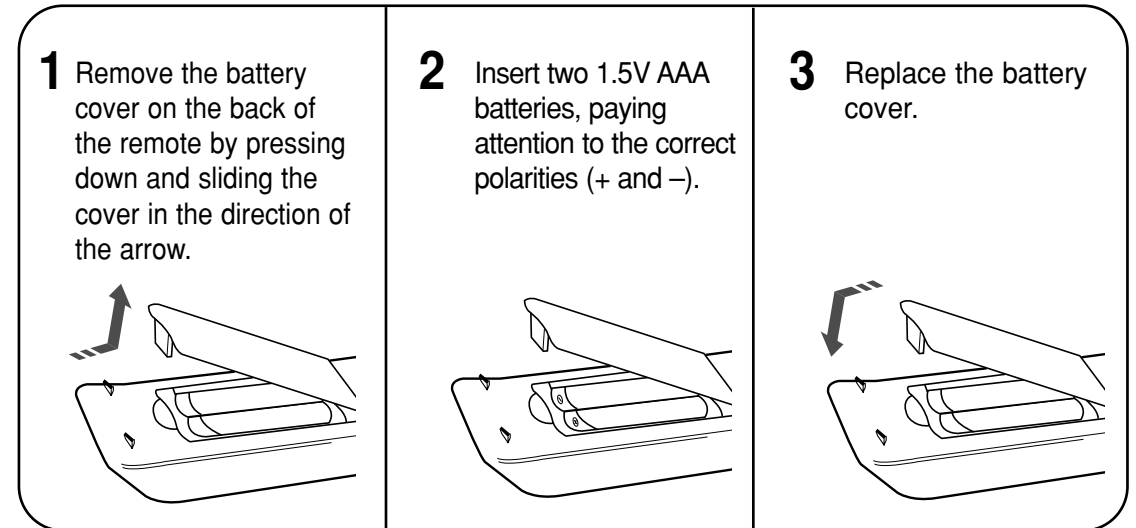

- Caution** Follow these precautions to avoid leaking or cracking cells:
- Place batteries in the remote control so they match the polarity:(+) to (+)and (-)to (-).
  - Use the correct type of batteries.Batteries that look similar may differ in voltage.
  - Always replace both batteries at the same time.
  - Do not expose batteries to heat or flame.

### Range of Operation of the Remote Control

The remote control can be used up to approximately 23 feet/7 meters in a straight line. It can also be operated at a horizontal angle of up to 30° from the remote control sensor.

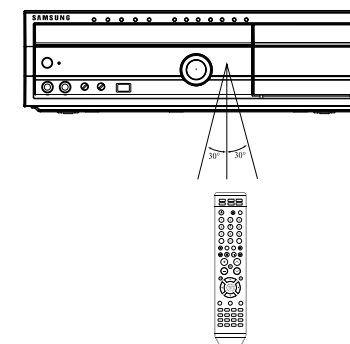

# Connecting the Speakers

Before moving or installing the product, be sure to turn off the power and disconnect the power cord.

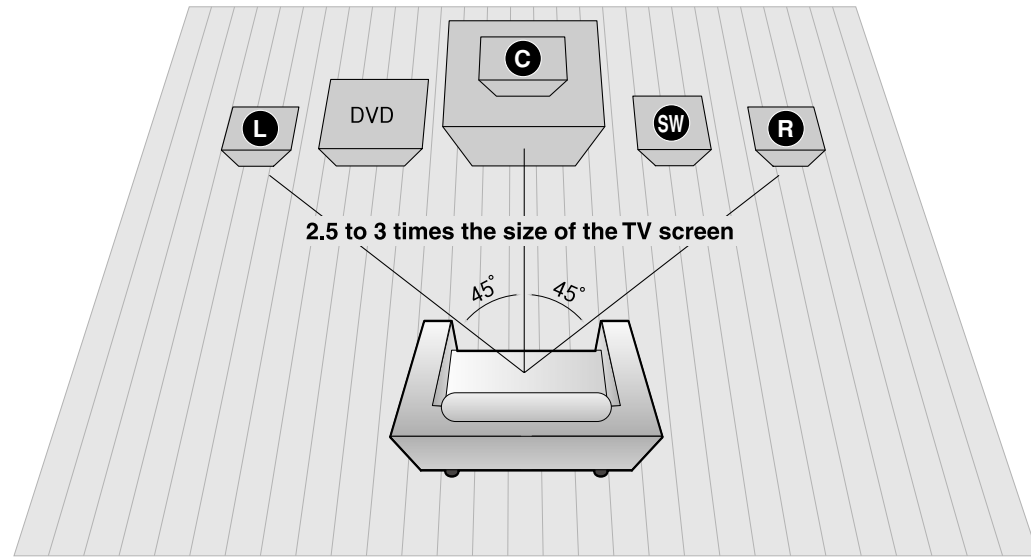

## Position of the DVD Player

- Place it on a stand or cabinet shelf, or under the TV stand.

## Front Speakers **L R**

- Place these speakers in front of your listening position, facing inwards (about 45°) toward you.
- Place the speakers so that their tweeters will be at the same height as your ear.
- Align the front face of the front speakers with the front face of the center speaker or place them slightly in front of the center speakers.

## Center Speaker **C**

- It is best to install it at the same height as the front speakers.
- You can also install it directly over or under the TV.

## Selecting the Listening Position

The listening position should be located about 2.5 to 3 times the distance of the TV's screen size away from the TV. Example: For 32" TVs 2~2.4m (6~8feet)  
For 55" TVs 3.5~4m (11~13feet)

## Subwoofer **SW**

- The position of the subwoofer is not so critical. Place it anywhere you like.

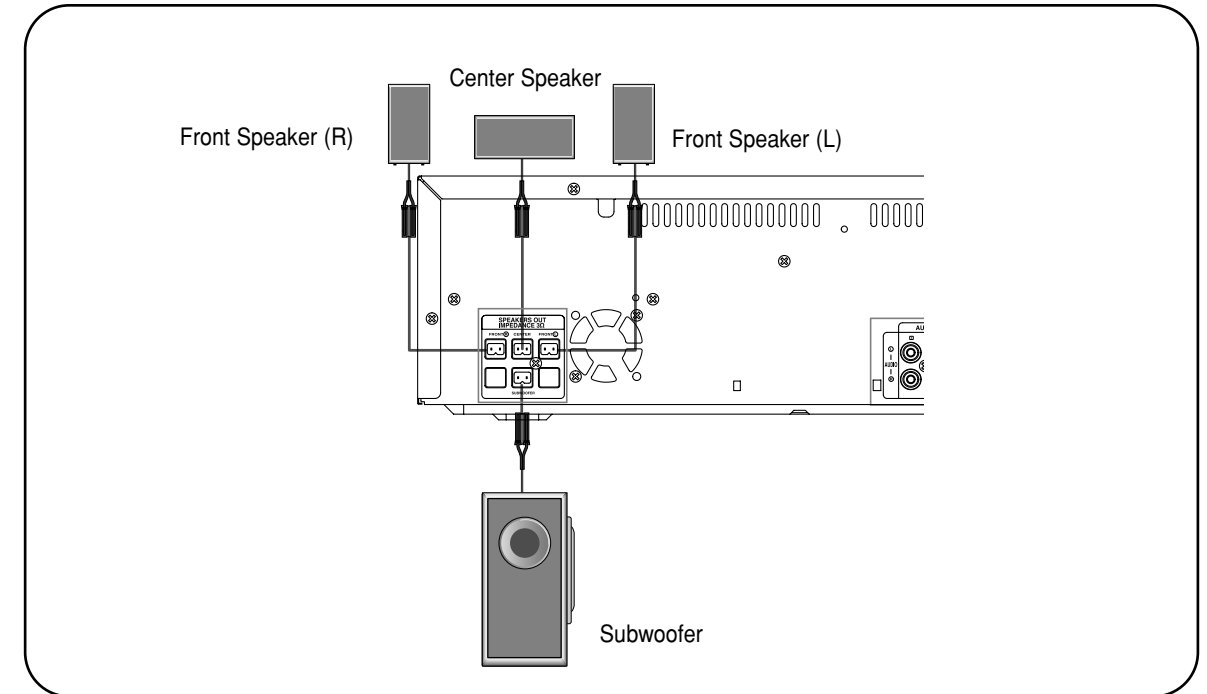

## Connecting the Speakers

- Press down the terminal tab on the back of the speaker.
- Insert the black wire into the black terminal (-) and the red wire into the red (+) terminal, and then release the tab.
- Connect the correct color speaker cable to the same color speaker output terminal on the rear of the subwoofer, according to the polarity markings (+/-).

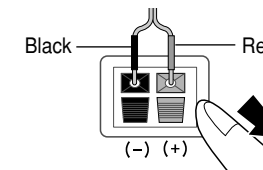
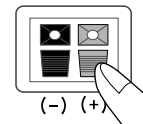

**Example:** Connect the green center speaker cable to the green center speaker output terminal on the rear of the subwoofer according to the polarity markings (+/-).

### Caution

- Do not let children play with or near the speakers. They could get hurt if a speaker falls.
- When connecting the speaker wires to the speakers, make sure that the polarity (+/-) is correct.

### Note

- If you place a speaker near your TV set, screen color may be distorted because of the magnetic field generated by the speaker. If this occurs, place the speaker away from your TV set.

# Connecting the Video Out to TV

Choose one of the two methods for connecting to a TV.

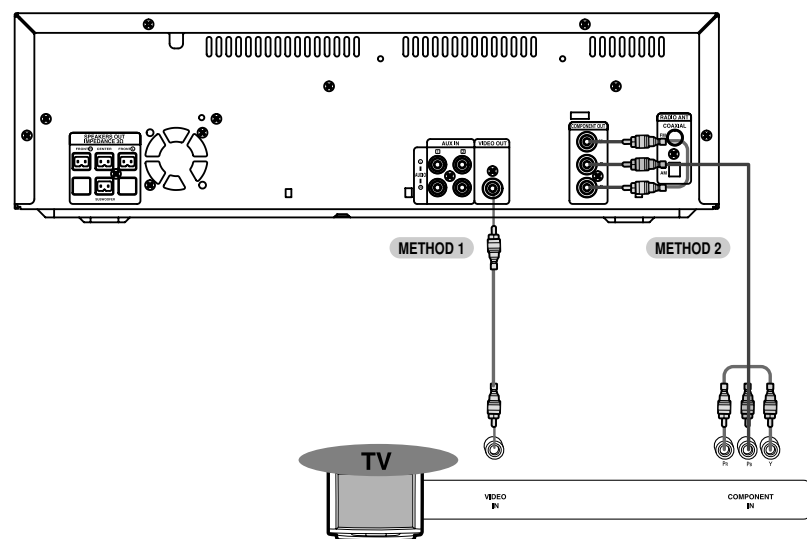

## METHOD 1 Composite Video ..... Good Quality

Connect the supplied video cable from the VIDEO OUT jack on the back panel of the system to the VIDEO IN jack on your television.

## METHOD 2 Component (Progressive Scan) Video ..... Best Quality

If your television is equipped with Component Video inputs, connect a component video cable (not supplied) from the Pr, Pb and Y jacks on the back panel of the system to the corresponding jacks on your television.

# P.SCAN(Progressive Scan) Function

GB

Unlike regular Interlace Scan, in which two fields of picture information alternate to create the entire picture (odd scan lines, then even scan lines), Progressive Scan uses one field of information (all lines displayed in one pass) to create a clear and detailed picture without visible scan lines.

## 1 Press STOP button.

- If playing a disc, press the **STOP** button twice so that "STOP", appears on the display.

## 2 Press and hold P.SCAN button on the remote control for over 5 seconds.

- Pressing and holding the button for over 5 seconds will select "Progressive Scan" and "Interlace Scan" alternately.
- When you select P.SCAN, "P.SCAN" will appear on the display.
- To set P.Scan mode for DivX discs, press the **P.SCAN** button on the remote control for more than 5 seconds with no disc in the unit ("NO DISC" on the display), then load the DivX disc and play.

### What is Progressive (or Non-Interlaced) Scanning?

Interlaced Scan (1 FRAME = 2 FIELDS)	Progressive Scan (FULL FRAME)
<p>In interlaced-scan video, a frame consists of two interlaced fields (odd and even), where each field contains every other horizontal line in the frame. The odd field of alternating lines is displayed first, and then the even field is displayed to fill in the alternating gaps left by the odd field to form a single frame. One frame, displayed every 1/30th of a second, contains two interlaced fields, thus a total of 60 fields are displayed every 1/60th of a second. The interlaced scanning method is intended for capturing a still object.</p>	<p>The progressive scanning method scans one full frame of video consecutively down the screen, line by line. An entire image is drawn at one time, as opposed to the interlaced scanning process by which a video image is drawn in a series of passes. The progressive scanning method is desirable for dealing with moving objects.</p>

### Note

- This function works only on TVs equipped with component video inputs (Y, Pr, Pb) that support Progressive Video. (It does not work on TVs with conventional component inputs, i.e., non-progressive scan TVs.)
- Depending on the capabilities of your TV, this function may not work.

# Connecting External Components

## Connecting an External Analog Component

Example: Analog signal components such as a VCR.

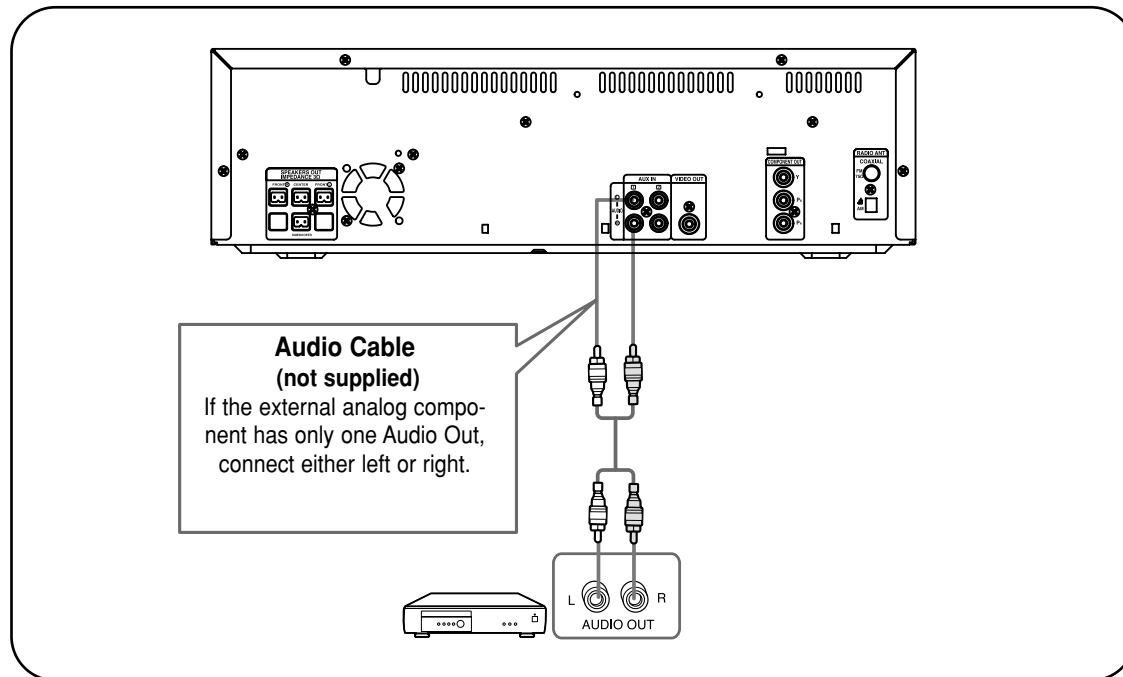

**1** Connect AUX (Audio) In on the Home Theater to Audio Out on the external analog component.

- Be sure to match connector colors.

**2** Press **AUX** button on the remote control to select 'AUX1', 'AUX2' or 'USB'.

- You can also use the **FUNCTION** button on the main unit.

The mode switches as follows: DVD/CD → TAPE → AUX1 → AUX2 → USB → FM → AM

**Note** • You can connect the Video Output jack on your VCR to the TV, and connect the Audio Output jacks on the VCR to this product.

# Connecting the FM and AM Antennas

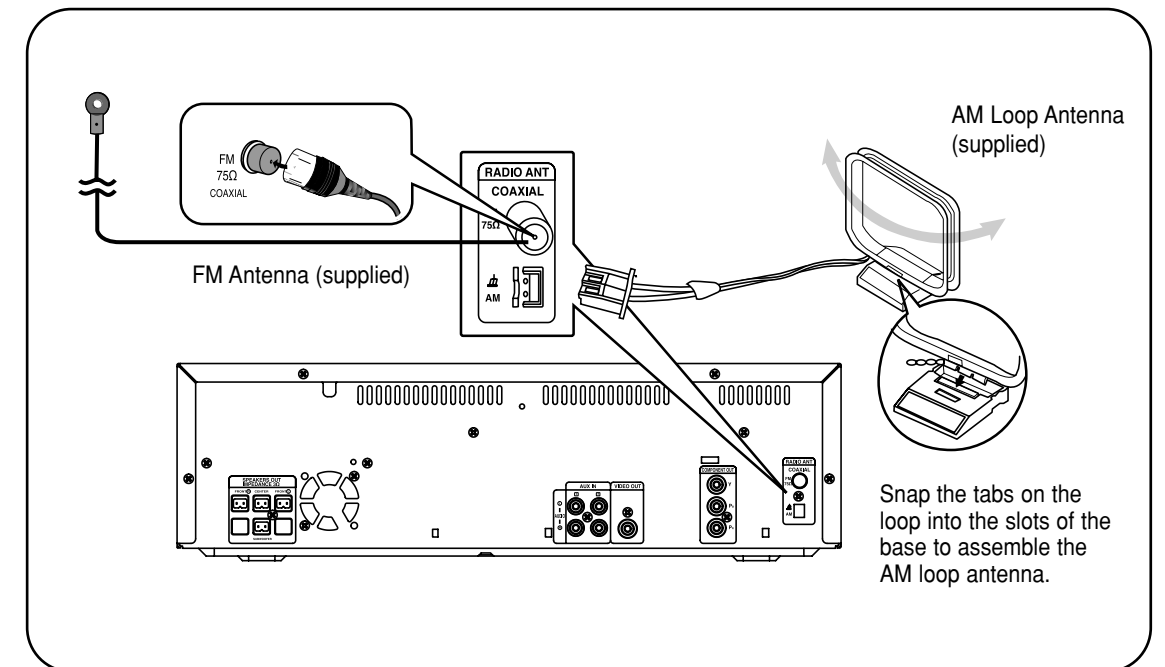

## FM antenna connection

1. Connect the FM antenna supplied to the FM 75Ω COAXIAL terminal.
2. Slowly move the antenna wire around until you find a location where reception is good, then fasten it to a wall or other rigid surface.

## AM antenna connection

1. Connect the AM loop antenna supplied to the AM and  $\perp$  terminals.
  - Insert the black wire into the black terminal and the white wire into the white terminal.
2. If reception is poor, connect an outdoor single vinyl-covered wire to the AM terminal. (Keep the AM loop antenna connected).

## Cooling Fan

The cooling fan supplies cool air to the unit to prevent overheating.

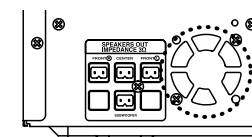

Please observe the following cautions for your safety.

- Make sure the unit is well-ventilated. If the unit has poor ventilation, the temperature inside the unit could rise and may damage it.
- Do not obstruct the cooling fan or ventilation holes. (If the cooling fan or ventilation holes are covered with a newspaper or cloth, heat may build up inside the unit and fire may result.)

**Note** • This unit does not receive AM broadcasts.

# Before Using Your Home Theater

Your Home Theater is capable of playing DVD, CD, MP3/WMA and JPEG discs. Depending on the disc you are using, these instructions may vary slightly. Read the instructions carefully before using.

## To Operate your Samsung TV and the Home Theater with the HT-DT79's Remote Control



**1** Plug the main unit's power cord into the AC power supply.

**2** Press **TV** button to set the remote to TV mode.

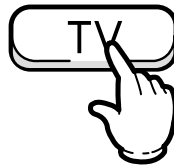

**3** Press the **POWER** button to turn on your Samsung TV with this remote.



**4** Press **TV/VIDEO** button to select VIDEO mode on your TV.



**5** Press **DVD RECEIVER** button to switch to DVD RECEIVER mode.



**6** Press **FUNCTION** button on the main unit or DVD button on the remote to enable DVD/CD playback.

# Disc Playback

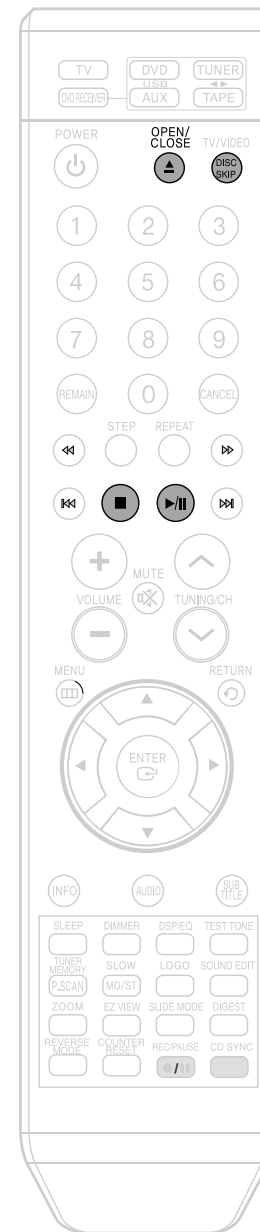

**1** Press **OPEN/CLOSE** button to open the disc tray.

**2** Load a disc.  
• Place a disc gently into the tray with the disc's label facing up.

**3** Press **DISC SKIP** button.  
• Rotate the carousel tray so you can load the first, the second, the third discs.

**4** Close the compartment by pressing the **OPEN/CLOSE** button again.



• Playback starts automatically.

**Note** • Depending on the content of the disc, the initial screen may appear different.

**Note** • Buttons Enabled for TV Operation: POWER, CHANNEL, VOLUME, TV/VIDEO, and Numeric (0-9) buttons.  
• By default, the remote control is set to work with Samsung TVs.  
See page 61 for more information about remote control operation with other manufacturer's TVs.

# Selecting a Disc in the Disc changer

The DVD/CD function is automatically selected when Disc Skip is pushed.

To select a specific disc, press the corresponding **DIRECT PLAY (1, 2, 3)** buttons on the front panel or **DISC SKIP** on the remote control, until the required disc indicator flashes.

- If the disc selected is not loaded, the next disc is played automatically.



To stop playback, press **STOP** during playback.

- If pressed once, "PRESS PLAY" is displayed and the stop position will be stored in memory. If **PLAY/PAUSE** (▶/||) button or **ENTER** button is pressed, playback resumes from the stop position. (This function works only with DVDs.)
- If pressed twice, "STOP" is displayed, and if **PLAY/PAUSE** (▶/||) button is pressed, playback starts from the beginning.

To temporarily pause playback, press **PLAY/PAUSE** during playback.

- To resume playback, press **PLAY/PAUSE** (▶/||) button again.

## Selecting the Video Format

Press and hold **NT/PAL** button on the remote controller for over 5 seconds while the power is turned off.

- By default, the video format is set to "PAL".
- "NTSC" or "PAL" will appear in the display. At this time, press the **NT/PAL** button shortly to select between "NTSC" and "PAL".
- Each country has a different video format standard.
- For normal playback, the video format of the disc must be the same as the video format of your TV.

# MP3/WMA-CD Playback

Data CDs (CD-ROM, CD-R, CD-RW) encoded in MP3/WMA format can be played.

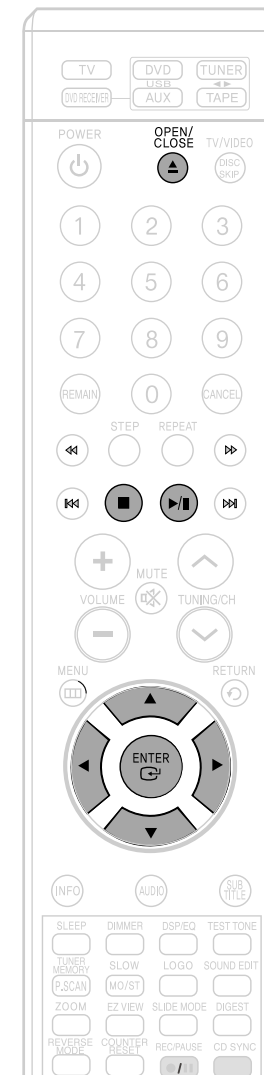

**1** Press the **OPEN/CLOSE** button to open the disc tray, and then load the MP3/WMA disc.

- The MP3/WMA menu screen will appear and playback will start.
- The appearance of the menu depends on the MP3/WMA disc.
- WMA-DRM files cannot be played.

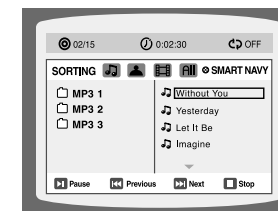

**2** In Stop mode, use ◀ ▶ ▲ ▼ to select the album, and then press the **ENTER** button.

- Use ▲ ▼ to select the track.

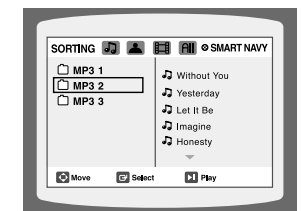

**3** To change the album, use ◀ ▶ ▲ ▼ to select another album in Stop mode, and then press the **ENTER** button.

- To select another album and track, repeat Steps 2 and 3 above.

### Note

- Depending on the recording mode, some MP3/WMA-CDs may not play.
- Table of contents of a MP3-CD varies depending on the MP3/WMA track format recorded on the disc.

**4** Press the **STOP** button to stop playback.

To play a file icon in the screen,

Press the ◀ ▶ ▲ ▼ button when it is in stop status and select a desired icon from the top part of the menu.

- To play music files only, select the icon.
- To view image files only, select the icon.
- To view movie files only, select the icon.
- To select all files select the icon.

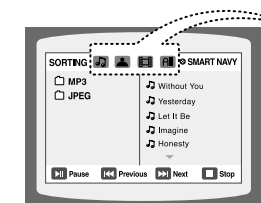

- Music File Icon
- Image File Icon
- Movie File Icon
- All File Icon



# Displaying Disc Information

You can view disc playback information on the TV screen.

Press **INFO** button.

- Each time the button is pressed, the display changes as follows:

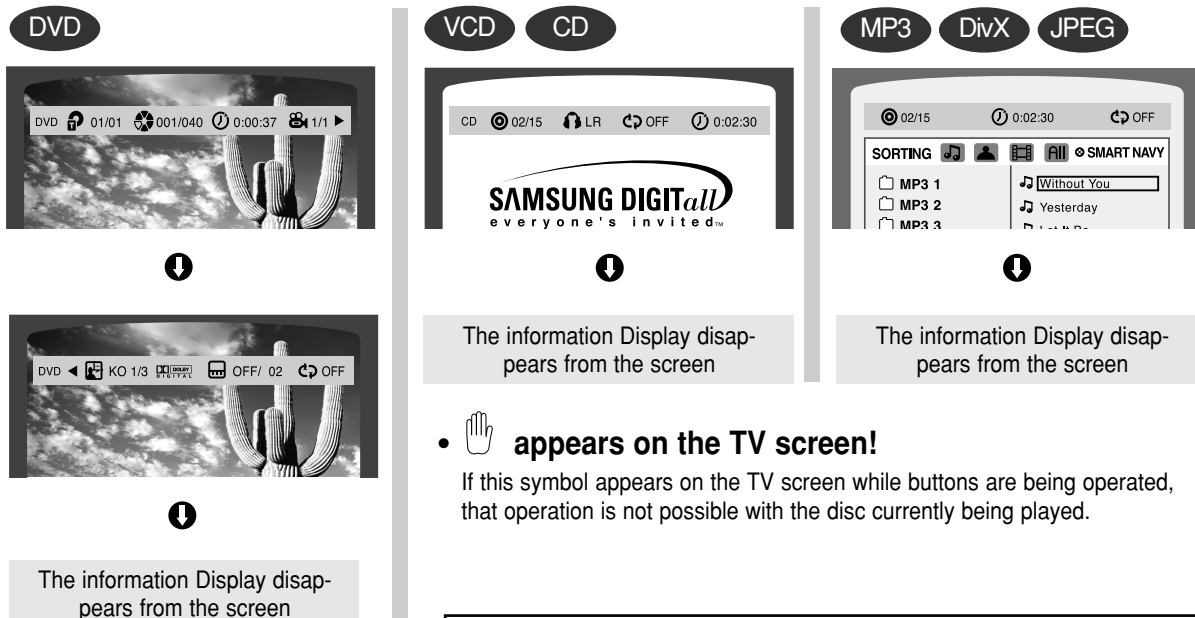

- appears on the TV screen!**

If this symbol appears on the TV screen while buttons are being operated, that operation is not possible with the disc currently being played.

The information Display disappears from the screen

## Note

- Depending on the disc, the disc information display may appear different.
- Depending on the disc, you can also select DTS, DOLBY DIGITAL, or PRO LOGIC.

- What is a Title?**  
A movie contained in a DVD-VIDEO disc.
- What is a Chapter?**  
Each title on a DVD disc is divided into several smaller sections called "chapters".
- What is a Track (File)?**  
A section of video or a music file recorded on a CD, or MP3-CD.

## Screen Display

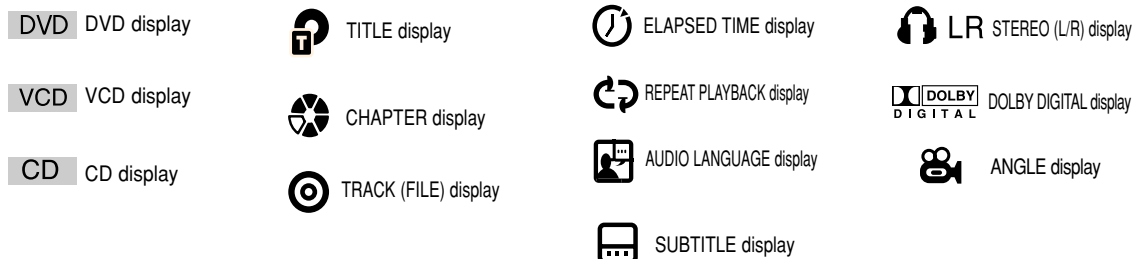

# JPEG File Playback JPEG

Images captured with a digital camera or camcorder, or JPEG files on a PC can be stored on a CD and then played back with this Home Theater.

## Slide Mode

**1** Place the JPEG disc on the disc tray.

**2** Press the **OPEN/CLOSE** button.

**3** Press **SLIDE MODE** button.

- Playback starts automatically.
- Each time the button is pressed, the image makes the transition as follows:

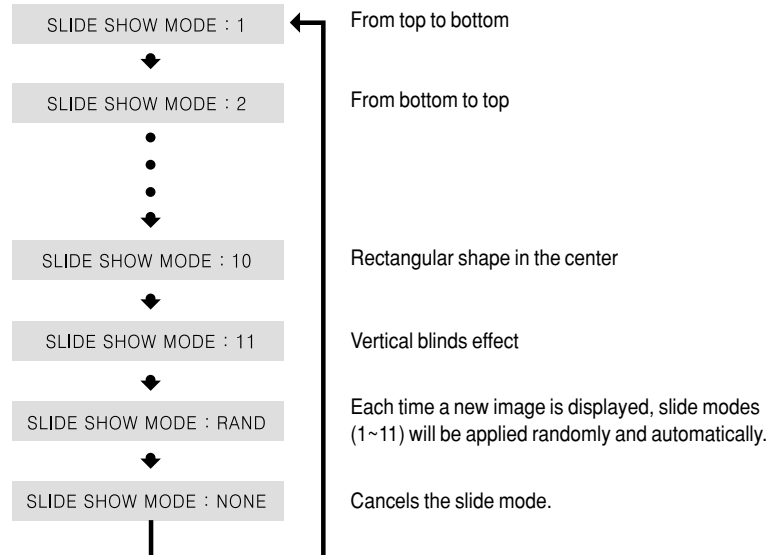

Press **◀▶** to skip to the next slide.

- Each time the button is pressed, the slide moves backward or forward.

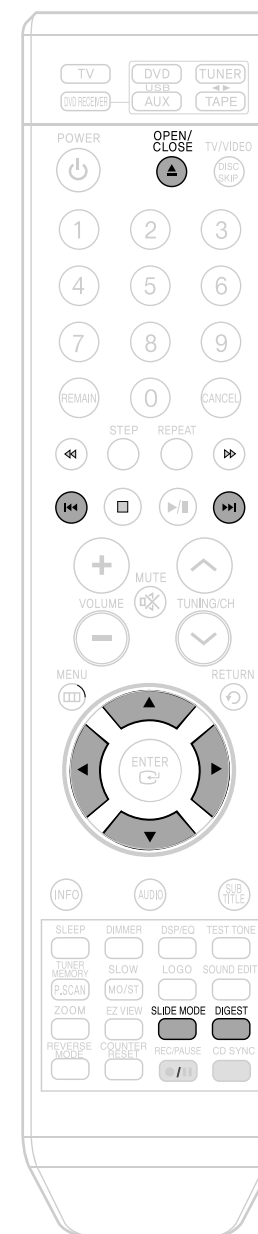



## || Digest Function

You can view 9 JPEG images on the TV screen.

**1** Press **DIGEST** button during playback.

- JPEG files will be shown in 9 windows.



**2** Press Cursor **▲, ▼, ◀, ▶** buttons to select the desired image and then press **ENTER** button.

- The selected image is played for 5 seconds before moving to the next image.

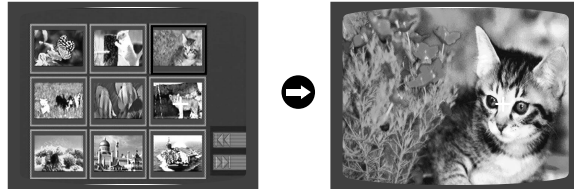

To view the previous or next image with 9 windows, press **◀◀▶▶**.

## || Rotate/Flip Function

Press Cursor **▲, ▼, ◀, ▶** buttons during playback.

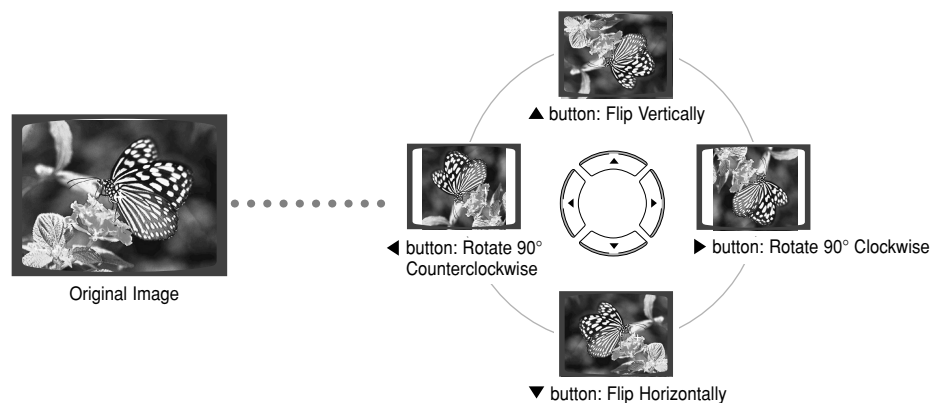

- Note**
- The maximum resolutions supported by this product are 5120 x 3480 (or 19.0 MPixel) for standard JPEG files and 2048 x 1536 (or 3.0 MPixel) for progressive image files.

## DivX Playback

The functions on this page apply to DIVX disc playback.

### || Skip Forward/Back

During playback, press the **◀◀▶▶** button.

- Goes to the next file whenever you press **▶▶** button, if there are over 2 files in the disk.
- Goes to the previous file whenever you press **◀◀** button, if there are over 2 files in the disk.

### || Fast playback

To play back the disc at a faster speed, press **◀◀** or **▶▶** during playback.

- Each time you press either button, the playback speed will change as follows:  
2x → 4x → 8x → 32x → Normal.

### || 5 Minute Skip function

During playback, press the **◀, ▶** button.

- Playback skips 5 minutes forward whenever you press **▶** button.
- Playback skips 5 minutes back whenever you press **◀** button.

### || Zoom Function

**1** Press **ZOOM** button.

- Each time you press the button, your selection will toggle between "ZOOM X2" and "ZOOM OFF".

**2** Press Cursor **▲, ▼, ◀, ▶** buttons to move to the area you want to enlarge.

- Note**
- DIVX file can be zoomed only in ZOOM X2 mode.
  - DivX files have .Avi file extensions, however, not all .Avi files are DivX and may not be playable in this unit.

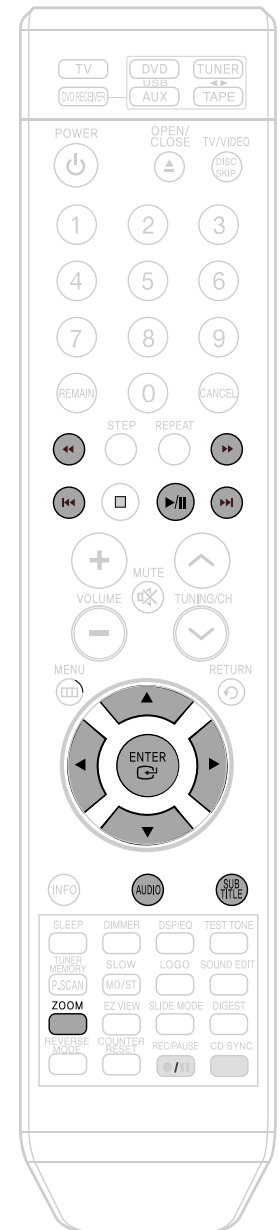

## Subtitle Display

Press the **SUBTITLE** button.

- Each time you press the button, your selection will toggle between "SUBTITLE (1/1, 1/2 ...)" and "SUBTITLE OFF".
- If the disc has only one subtitle file, it will be played automatically.
- See number 2 (Caption Function) below for more details concerning Subtitle usage with DIVX discs.

## Audio Display

Press the **AUDIO** button.

- If there are multiple audio tracks on a disc, you can toggle between them.
- Each time you press the button, your selection will toggle between "AUDIO(1/1, 1/2 ...)" and " " .

**Note** • " " is displayed when there is one supported language in the disc.

### DivX(Digital internet video eXpress)

DivX is a video file format developed by Microsoft and is based on MPEG4 compression technology to provide audio and video data over the Internet in real-time. MPEG4 is used for video encoding and MP3 for audio encoding so that the users can watch a movie at near DVD-quality video and audio.

#### 1. Supported Formats

- This product only supports the following media formats. If both video and audio formats are not supported, the user may experience problems such as broken images or no sound.

##### • Supported Video Formats

Format	AVI	WMV
Supported Versions	DivX3.11 ~ 5.1	V1/V2/V3/V7

##### • Supported Audio Formats

Format	MP3	WMA	AC3	DTS
Bit Rate	80~384kbps	56~128kbps	128~384kbps	1.5Mbps
Sampling Frequency	44.1khz		44.1/48khz	44.1khz

- DivX files, including audio and video files, created in the DTS format can only support up to 6Mbps.
- Aspect Ratio: Although default DivX resolution is 640\*480 pixels (4:3), this product supports up to 720\*480 pixels (16:9). TV screen resolutions higher than 800 will not be supported.
- When you play a disc whose sampling frequency is higher than 48khz or 320kbps, you may experience shaking on the screen during playback.

#### 2. Caption Function

- You must have some experience with video extraction and editing in order to use this feature properly.
- To use the caption function, save the caption file (\*.smi) in the same file name as that of the DivX media file (\*.avi) within the same folder.

Example. Root Samsung\_007CD1.avi  
Samsung\_007CD1.smi

- Up to 60 alphanumeric characters or 30 East Asian characters (2 byte characters such as Korean and Chinese) for the file name.

Press the **REMAIN** button.

- For checking the total and remaining time of a title or chapter being played.

Each time the **REMAIN** button is pressed

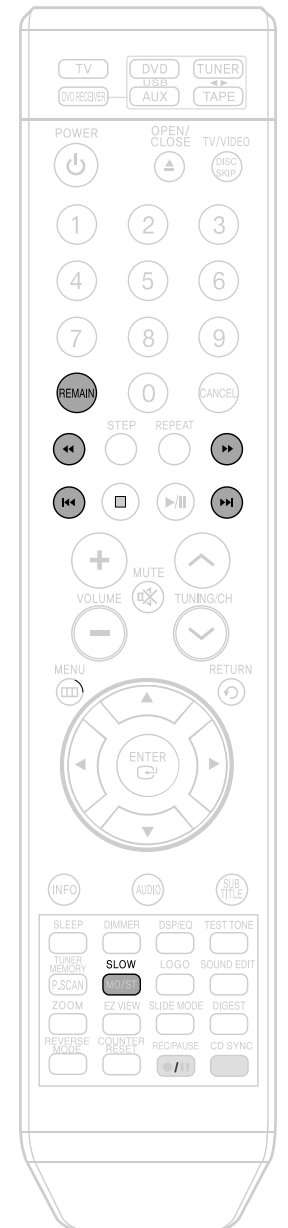
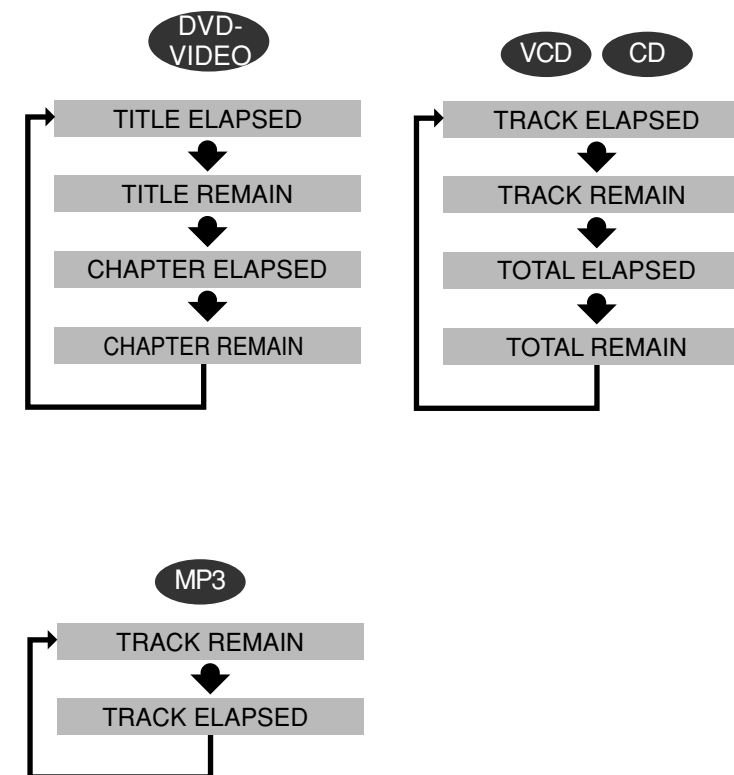

# Fast/Slow Playback

## Fast Playback

DVD VCD CD MP3

Press **⏮⏭**.

- Each time the button is pressed during playback, the playback speed changes as follows:

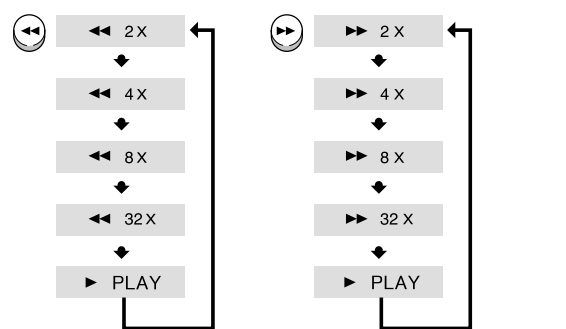

**Note**

- During fast playback of a CD or MP3-CD, sound is heard only at 2x speed, and not at 4x, 8x, and 32x speeds.

## Slow Playback

Press **SLOW** button.

- Each time the button is pressed during playback, the playback speed changes as follows:

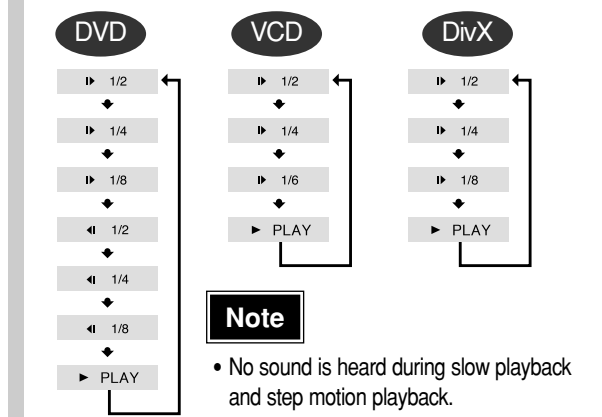

**Note**

- No sound is heard during slow playback and step motion playback.
- Reverse slow playback does not work with VCD and DivX.

# Skipping Scenes/Songs

Press **⏮⏭**.

- Each time the button is pressed during playback, the previous or next chapter, track, or directory (file) will be played.
- You cannot skip chapters consecutively.

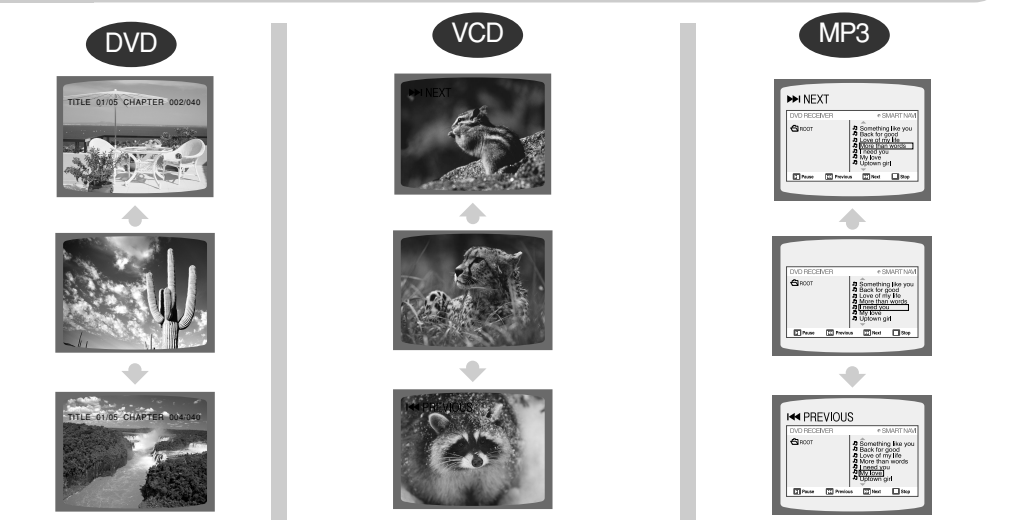

- When watching a VCD with a track longer than 15 minutes, each time **⏮⏭** is pressed, playback will skip back or forward 5 minutes.

# Repeat Playback

Repeat playback allows you to repeatedly play a chapter, title, track (song), or directory (MP3 file).

DVD VCD CD MP3 JPEG

Press **REPEAT** button.

- Each time the button is pressed during playback, the repeat playback mode changes as follows:

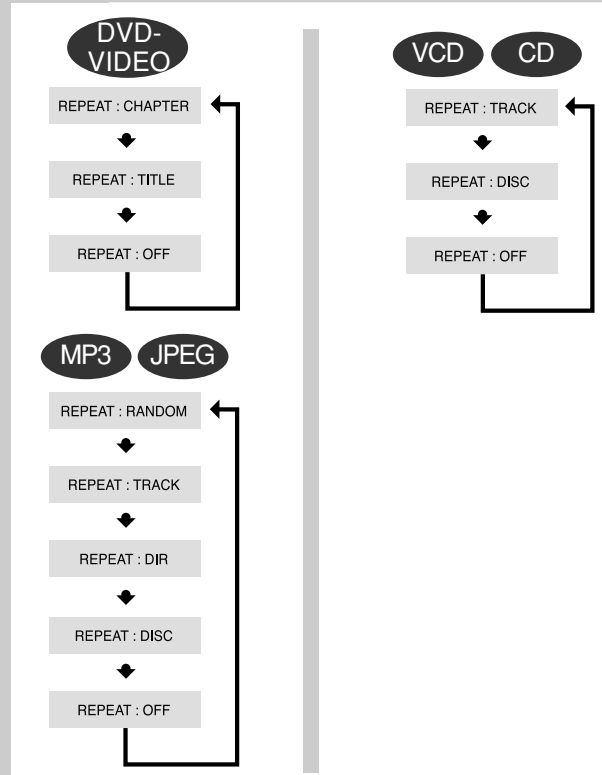

- ### Repeat Playback Options
- CHAPTER**  
Repeatedly plays the selected chapter.
  - TITLE**  
Repeatedly plays the selected title.
  - RANDOM**  
Plays tracks in random order. (A track that has already been played may be played again.)
  - TRACK**  
Repeatedly plays the selected track.
  - DIR**  
Repeatedly plays all tracks in the selected folder.
  - DISC**  
Repeatedly plays the entire disc.
  - OFF**  
Cancels Repeat Playback.

**To Select a Repeat Playback Mode in the Disc Information Screen**

- Press **INFO** button twice.
- Press Cursor **▶** button to move to REPEAT PLAYBACK (⏮) display.
- Press Cursor **▼** button to select the desired Repeat Playback mode.
- Press **ENTER** button.

\* For MP3 and JPEG discs, you cannot select Repeat Play from the information display screen.

**Note**

- Repeat playback operation is not possible with version 2.0 VCD discs if PBC is turned on. To use Repeat Playback on a VCD with PBC, you should set the PBC to OFF in the disc menu. (See page 37.)

# A-B Repeat Playback

You can repeatedly play back a designated section of a DVD.

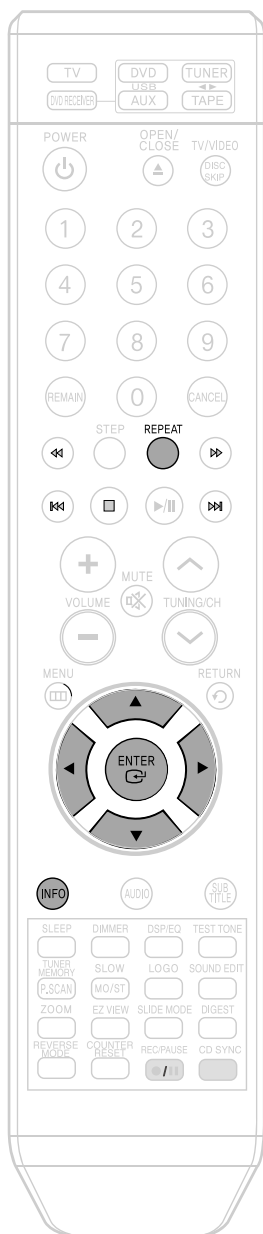

DVD VCD CD

**1** Press **INFO** button twice.

- For a VCD, press **INFO** button once.

DVD ◀ EN 1/3 00:00:37 OFF/ 02 ⏪ OFF

**2** Press Cursor ▶ button to move to REPEAT PLAYBACK (⏪) display.

DVD ◀ EN 1/3 00:00:37 OFF/ 02 ⏪ OFF

**3** Press Cursor ▲, ▼ buttons to select 'A-' and then press **ENTER** button at the beginning of the desired segment.

- When **ENTER** button is pressed, the selected position will be stored in memory.

DVD ◀ EN 1/3 00:00:37 OFF/ 02 ⏪ A-



DVD ◀ EN 1/3 00:00:37 OFF/ 02 ⏪ A-?

REPEAT : A—

**4** Press **ENTER** button at the end of the desired segment.

- The specified segment will be played repeatedly.

DVD ◀ EN 1/3 00:00:37 OFF/ 02 ⏪ A-B

REPEAT : A—B

To return to normal playback, press Cursor ▲, ▼ buttons to select ⏪ OFF.

## Note

- The A-B Repeat function does not operate with MP3 or JPEG discs.

# Step Function DVD VCD

Press **STEP** button.

- The picture moves forward one frame each time the button is pressed during playback.



# Angle Function DVD

This function allows you to view the same scene in different angles.

**1** Press **INFO** button.

DVD ◀ 01/01 001/040 0:00:37 1/3 ▶

**2** Press Cursor ▶ button to move to ANGLE (1/3) display.

DVD ◀ 01/01 001/040 0:00:37 1/3 ▶

**3** Press Cursor ▲, ▼ or numeric buttons to select the desired angle.

- Each time the button is pressed, the angle changes as follows:

DVD ◀ 01/01 001/040 0:00:37 1/3 ▶  
 2/3  
 3/3



## Note

- The Angle function works only with discs on which multiple angles have been recorded.

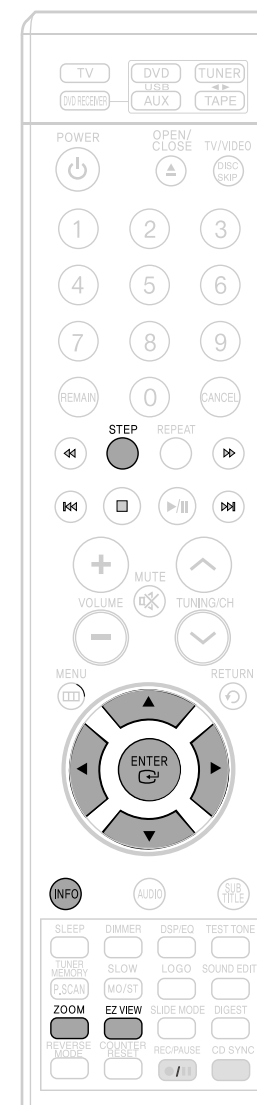

# Zoom (Screen Enlarge) Function

This function allows you to enlarge a particular area of the displayed image.

DVD VCD

**1** Press **ZOOM** button.



**2** Press Cursor **▲**, **▼**, **◀**, **▶** buttons to move to the area you want to enlarge.



**3** Press **ENTER** button.

- Each time the button is pressed, the zoom level changes as follows:

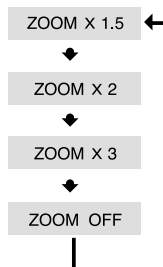

**Note**

- When a DivX disc is being played, only the 2:1 zoom-in is available.

# EZ VIEW Function

DVD

Press **EZ VIEW** button.

- Each time the button is pressed, the zoom function will switch between On and Off.
- When a movie is played in Widescreen format, black bars at the top and bottom of the TV screen can be removed by pressing the **EZ VIEW** button.



**Note**

- This function will not work if the DVD is recorded with multi-camera angle format.
- Black bars may not disappear because some DVD discs have a built-in horizontal to vertical ratio.
- This feature is not supported for DivX discs.

# Selecting Audio Language

## Audio Language Selection Function

DVD

**1** Press **INFO** button twice.



**2** Press Cursor **▲**, **▼** buttons or numeric buttons to select the desired audio language.

- Depending on the number of languages on a DVD disc, a different audio language (ENGLISH, SPANISH, FRENCH, etc.) is selected each time the button is pressed.

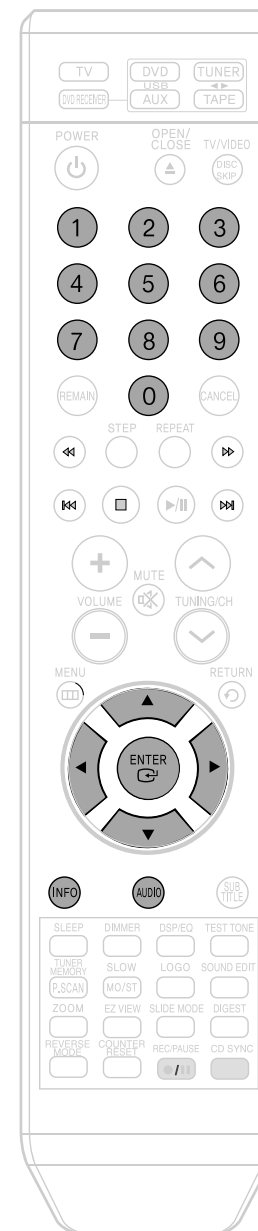
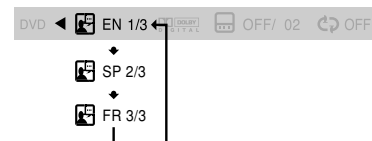



# Selecting Subtitle Language

## Subtitle Language Selection Function DVD

**1** Press **INFO** button twice.



**2** Press **Cursor** **▶** button to move to **SUBTITLE** ( ) display.



**3** Press **Cursor** **▼** button or numeric buttons to select the desired subtitle.

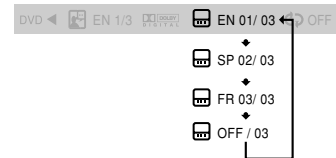

### Note

- To operate this function, you can also press the Select AUDIO or Select SUBTITLE buttons on the remote control.
- Depending on the disc, the Subtitle and Audio Language functions may not be available.



# Playing Media Files using the USB HOST feature

You can enjoy media files such as pictures, movies and music saved in an MP3 player, USB memory or digital camera in high quality video with 3.1 channel home theater sound by connecting the storage device to the USB port of the home theater.

**1** Connect the USB device to the USB port on the rear of the unit.

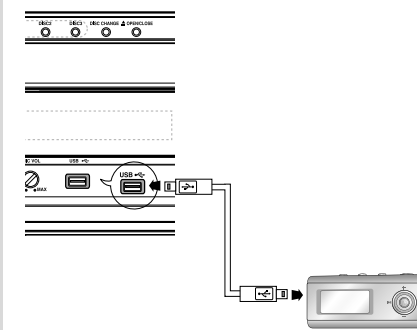

**2** Press the **FUNCTION** button on the main unit or the **USB** button on the remote control to select the USB mode.

- "USB" appears on the display screen and then disappears.
- USB MENU screen appears on the TV screen and the saved file is played.

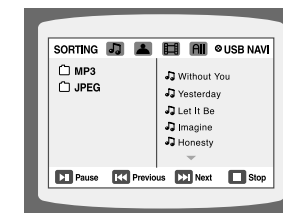

To stop playback, press the **STOP** ( ) button.

## Safe USB Removal

To prevent damage to the memory stored in the USB device, perform safe removal before disconnecting the USB cable.

- (1) Press the Stop button twice in a row.  
The display will show **REMOVE → USB**.
- (2) Remove the USB cable.

## Skip Forward/Back

During playback, press the **◀◀ ▶▶** button.

- When there is more than one file, when you press the **▶▶** button, the next file is selected.
- When there is more than one file, when you press the **◀◀** button, the previous file is selected.

## Fast playback

To play back the disc at a faster speed, press **◀◀** or **▶▶** during playback.

- Each time you press either button, the playback speed will change as follows: 2x → 4x → 8x → 32x → Normal.



## Compatible Devices

1. USB devices that support USB Mass Storage v1.0.  
(USB devices that operate as a removable disk in Windows (2000 or later) without additional driver installation.)
2. MP3 Player: HDD and flash type MP3 players.
3. Digital camera: Cameras that support USB Mass Storage v1.0.
  - Cameras that operate as a removable disk in Windows (2000 or later) without additional driver installation.
4. USB HDD and USB Flash Drive: Devices that support USB2.0 or USB1.1.
  - You may experience a difference in playback quality when you connect a USB1.1 device.
  - For a USB HDD, make sure to connect an auxiliary power cord to the USB HDD for proper operation.
5. USB card Reader: One slot USB card reader and Multi slot USB card reader
  - Depending on the manufacturer, the USB card reader may not be supported.
  - If you install multiple memory devices into a multi card reader, you may experience problems.
6. If you use a USB extension cable, the USB device might not be recognized.

### Supported Formats

	File name	File extension	Bit rate	Version	Pixel	Sampling Frequency
Still Picture	JPG	JPG .JPEG	-	-	640*480	-
Music	MP3	.MP3	80~384kbps	-	-	44.1kHz
	WMA	.WMA	56~128kbps	V8	-	44.1kHz
Movie	VCD	MPG.MPEG .DAT	1.5Mbps	VCD1.1,VCD2.0	320*480	44.1KHz
	WMV	.WMV	4Mbps	V1,V2,V3,V7	720*480	44.1KHz~48KHz
	DivX	.AVI,.ASF	4Mbps	DivX3.11~DivX5.1,Xvid	720*480	44.1KHz~48KHz

- CBI (Control/Bulk/Interrupt) is not supported.
- Digital Cameras that use PTP protocol or require additional program installation when connected to a PC are not supported.
- A device using NTFS file system is not supported.  
(Only FAT 16/32 (File Allocation Table 16/32) file system is supported.)
- Some MP3 players, when connected to this product, may not operate depending on the sector size of their file system.
- The USB HOST function is not supported if a product that transfers media files by its manufacturer-specific program is connected.
- Does not operate with Janus enabled MTP(Media Transfer Protocol) devices.
- **The USB host function of this product does not support all USB devices.**  
For information on the supported devices, see pages 66.

DVD VCD CD

**1** Press **INFO** button.



**Moving to a Title/Track**

**2** Press Cursor **▲**, **▼** buttons or numeric buttons to select the desired title/track and then press **ENTER** button.



**Moving to a Chapter**

**3** Press Cursor **◀**, **▶** buttons to move to Chapter ( ) display.

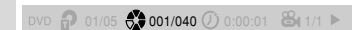

**Moving to a Chapter**

**4** Press Cursor **▲**, **▼** buttons or numeric buttons to select the desired chapter and then press **ENTER** button.

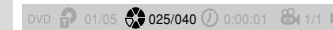

**Moving to a Specific Time**

**5** Press Cursor **◀**, **▶** buttons to move to time display.



**Moving to a Specific Time**

**6** Press the numeric buttons to select the desired time and then press **ENTER** button.



OPERATION

MP3 JPEG

Press the **numeric** buttons.

- The selected file will be played.
- When playing an MP3 or JPEG disc, you cannot use **▲**, **▼** to move to a folder. To move a folder, press **■** (Stop) and then press **▲**, **▼**.

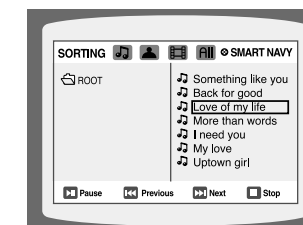

### Note

- You can press **◀◀▶▶** on the remote control to move directly to the desired title, chapter, or track.
- Depending on the disc, you may not be able to move to the selected title or time.

# Using Disc Menu DVD

You can use the menus for the audio language, subtitle language, profile, etc.  
DVD menu contents differ from disc to disc.

**1** In Stop mode, press **MENU** button.

- When playing a VCD (version 2.), this toggles between PBC ON and OFF.



**2** Press Cursor  $\blacktriangle$ ,  $\blacktriangledown$  buttons to move to 'DISC MENU' and then press **ENTER** button.

- When you select Disc Menu and it is not supported by the disc, the "This menu is not supported" message appears on the screen.



**3** Press Cursor  $\blacktriangle$ ,  $\blacktriangledown$ ,  $\blacktriangleleft$ ,  $\blacktriangleright$  buttons to select the desired item.

- Press **ENTER** button.



## Note

- Disc menu display may be different depending on the disc.

### PBC (Playback Control) Function

When playing a VCD (version 2.0), you can select and view various scenes according to the menu screen.

**PBC ON:** This VCD disc is version 2.0. The disc is played back according to the menu screen. Some functions may be disabled. When some functions are disabled, select "PBC OFF" to enable them.

**PBC OFF:** This VCD disc is version 1.1. The disc is played back in the same way as with a music CD.

# Using the Title Menu DVD

For DVDs containing multiple titles, you can view the title of each movie.  
Depending on the disc, the availability of this feature may vary.

**1** In Stop mode, press **MENU** button.



**2** Press Cursor  $\blacktriangle$ ,  $\blacktriangledown$  button to move to 'Title Menu'.



**3** Press **ENTER** button.

- The title menu appears.



Press **MENU** button to exit the setup screen.

## Note

- Title menu display may be different depending on the disc.



# Setting the Language

OSD (On-Screen Display) language is set to English by default.

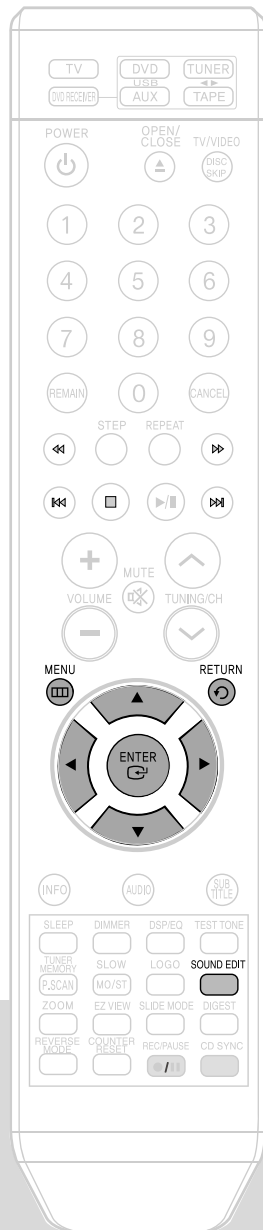

**1** In Stop mode, press **MENU** button.



**2** Press Cursor **▼** button to move to 'Setup' and then press **ENTER** button.



**3** Select 'Language' and then press **ENTER** button



**4** Press Cursor **▲, ▼** button to select 'OSD Language' and then press **ENTER** button.



**5** Press Cursor **▲, ▼** button to select the desired language and then press **ENTER** button.



- Once the setup is complete, the OSD will be English if English has been selected as language.

Press **RETURN** button to return to the previous level.

Press **MENU** button to exit the setup screen.

**Note**

- To select another language, select OTHER and enter the language code of your country. (See page 66 for language codes)  
AUDIO, SUB TITLE and DISC MENU language can be selected.



Selecting the OSD Language



Selecting the Audio Language (recorded on the disc)



Selecting the Subtitle Language (recorded on the disc)



Selecting the Disc Menu Language (recorded on the disc)

- \* If the language you selected is not recorded on the disc, menu language will not change even if you set it to your desired language.

SETUP

# Setting TV Screen type

Depending on your TV type (Wide Screen or conventional 4:3), you can select the TV's aspect ratio.



**1** In Stop mode, press **MENU** button.



**2** Press Cursor **▼** button to move to 'Setup' and then press **ENTER** button.



**3** Press Cursor **▼** button to move to 'TV DISPLAY' and then press **ENTER** button.

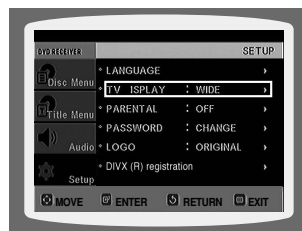

**4** Press Cursor **▲,▼** button to select the desired item and then press **ENTER** button.



• Once the setup is complete, you will be taken to the previous screen.

## Adjusting the TV Aspect Ratio (Screen Size)

The horizontal to vertical screen size ratio of conventional TVs is 4:3, while that of widescreen and high definition TVs is 16:9. This ratio is called the aspect ratio. When playing DVDs recorded in different screen sizes, you should adjust the aspect ratio to fit your TV or monitor.

• For a standard TV, select either "4:3LB" or "4:3PS" option according to personal preference. Select "16:9" if you have a widescreen TV.

**WIDE** : Select this to view a 16:9 picture in the full-screen mode on your widescreen TV.  
• You can enjoy the widescreen aspect.



**4:3LB (4:3 Letterbox)** : Select this to play a 16:9 picture in the letter box mode on a conventional TV.  
• Black bars will appear at the top and bottom of the screen.



**4:3PS (4:3 Pan&Scan)** : Select this to play a 16:9 picture in the pan & scan mode on a conventional TV.  
• You can see the central portion of the screen only (with the sides of the 16:9 picture cut off).



**Note** • If a DVD is in the 4:3 ratio, you cannot view it in widescreen.  
• Since DVD discs are recorded in various image formats, they will look different depending on the software, the type of TV, and the TV aspect ratio setting.

Press **RETURN** button to return to the previous level.

Press **MENU** button to exit the setup screen.

# Setting Parental Controls (Rating Level)

Use this to restrict playback of adult or violent DVDs you do not want children to view.

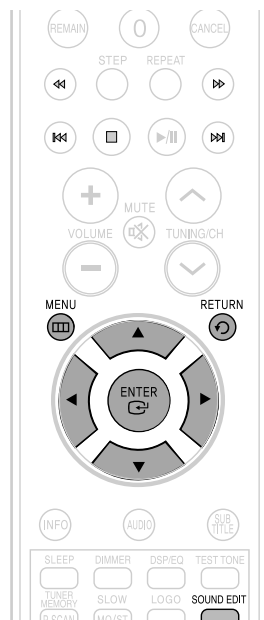

**1** In Stop mode, press **MENU** button.



**2** Press Cursor **▼** button to move to 'Setup' and then press **ENTER** button.



**3** Press Cursor **▼** button to move to 'PARENTAL' and then press **ENTER** button.

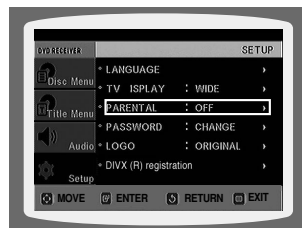

**4** Press Cursor **▲, ▼** button to select the desired rating level and then press **ENTER** button.

- If you have selected Level 6, you cannot view DVDs with Level 7 or higher.
- The higher the level, the closer the content is to violent or adult material.



**5** Enter the password and then press **ENTER** button.

- The password is set to "7890" by default.
- Once the setup is complete, you will be taken to the previous screen.

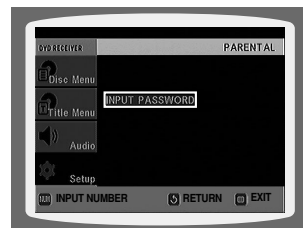

**Note** • This function works only if a DVD disc contains the rating level information.

Press **RETURN** button to return to the previous level.

Press **MENU** button to exit the setup screen.

# Setting the Password

You can set the password for the Parental (rating level) setting.

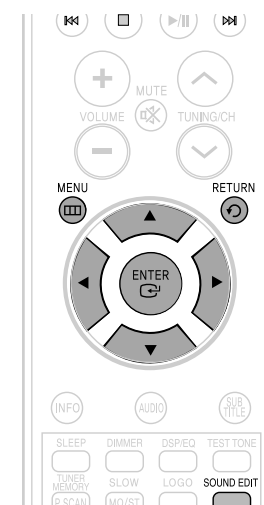

**1** Press **MENU** button.



**2** Press Cursor **▼** button to move to 'Setup' and then press **ENTER** button.

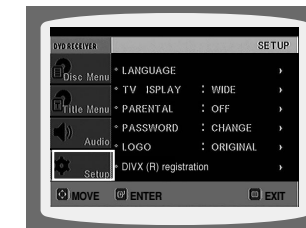

**3** Press Cursor **▼** button to move to 'PASSWORD' and then press **ENTER** button.

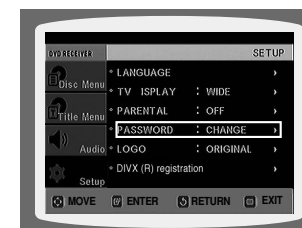

**4** Press **ENTER** button.



**5** Enter the password and then press **ENTER** button.

- Enter the old password, a new password, and confirm new password.
- The setting is complete.

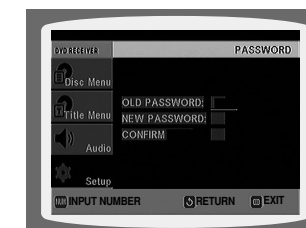

**Note** • The password is set to "7890" by default.

**If you have forgotten the rating level password, do the following:**

- While the player is in the no disc mode, hold the main unit's **RESET** button for longer than 5 seconds. "INITIALIZE" appears on the display and all settings will return to the default values.
- Press the POWER button.

Using the **RESET** function will erase all stored settings. Do not use this unless necessary.

# Setting the Wallpaper

JPEG DVD VCD

While watching a DVD, VCD or JPEG CD, you can set the image you like as background wallpaper.

## Setting the Wallpaper

**1** During playback, press **PLAY/PAUSE** button when an image you like appears.



**2** Press **LOGO** button.

- “COPY LOGO DATA” → “FLASH” → “COPY DONE” will be displayed on the TV screen.



**3** The power will turn off and then back on.

- The selected wallpaper will be displayed.
- You can select up to 3 wallpaper settings.

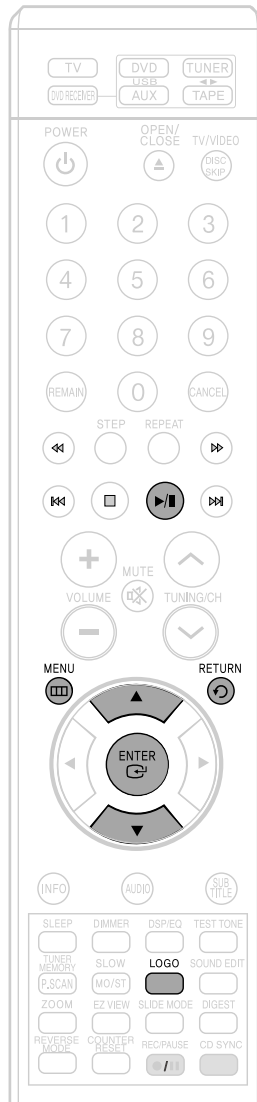

## To select one of the 3 wallpaper settings you've made

**1** In Stop mode, press **MENU** button.



**2** Press Cursor **▼** button to move to 'Setup' and then press **ENTER** button.



**3** Press Cursor **▼** button to move to 'LOGO' and then press **ENTER** button.

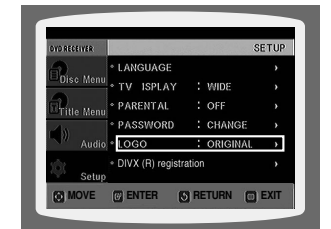

**4** Press **▼** to select the desired 'USER', and then press **ENTER**.

- This selects one of the 3 wallpaper screens

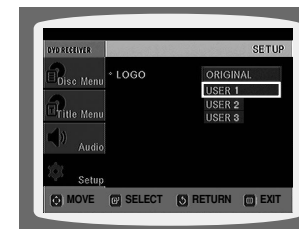

**5** Press **MENU** button to exit the setup screen.



Select this to set the Samsung Logo image as your wallpaper.



Select this to set the desired image as your wallpaper.

Press **RETURN** button to return to the previous level.

Press **MENU** button to exit the setup screen.

# DivX (R) registration

Please use the Registration code to register this player with the DivX (R) video on demand format. To learn more, go to [www.divx.com/vod](http://www.divx.com/vod).



**1** Press the **MENU** button while the disc tray is open.



**2** Press Cursor **▼** button to move to 'Setup' and then press **ENTER** button.



**3** Press Cursor **▼** button to move to 'DIVX(R) registration' and then press **ENTER** button.

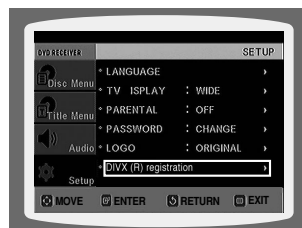

## TEST TONE FUNCTION

Press **TEST TONE** button on the remote.

- Test tone will be produced as follows:  
When playing a DVD or CD, this will work only in Stop mode.
- Use this function to check that each speaker is correctly connected and that there is no problem.

To end the test tone, press **TEST TONE** button again.

# Setting the DRC (Dynamic Range Compression)

This feature balances the range between the loudest and quietest sounds. You can use this function to enjoy Dolby Digital sound when watching movies at low volume at night.

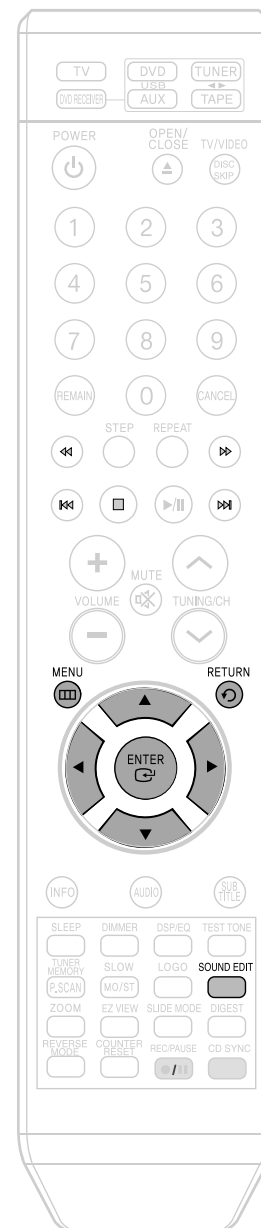

**1** In Stop or no disc mode, press **MENU** button.



**2** Press Cursor **▼** button to move to 'Audio' and then press **ENTER** button.

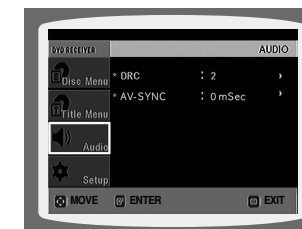

**3** Press Cursor **▼** button to move to 'DRC' and then press **ENTER** button.

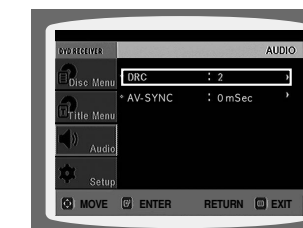

**4** Press Cursor **▲**, **▼** to adjust the 'DRC'.

- When the Cursor **▲** button is pressed, the effect is greater, and when the Cursor **▼** button is pressed, the effect is smaller.

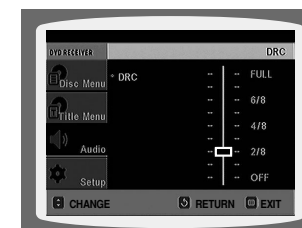

Press **RETURN** button to return to the previous level.

Press **MENU** button to exit the setup screen.

# Setting the Audio

You can adjust the balance and level for each speaker.

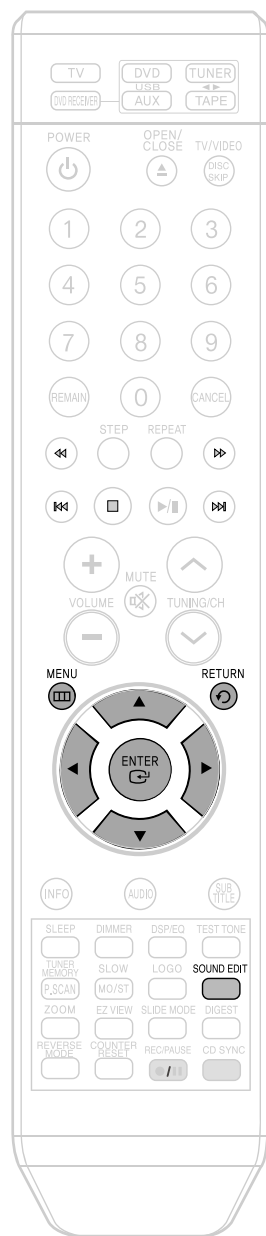

## Adjusting Front Speaker Balance

- 1 Press **SOUND EDIT** button and then press Cursor **◀, ▶**.



## Adjusting Rear Speaker Balance

- 2 Press **SOUND EDIT** button and then press Cursor **◀, ▶**.



## Adjusting Center Speaker Level

- 3 Press **SOUND EDIT** button and then press Cursor **◀, ▶**.



## Adjusting Subwoofer Speaker Level

- 4 Press **SOUND EDIT** button and then press Cursor **◀, ▶**.



### Note

#### Adjusting Front Speaker Balance

- You can select between 00 and -06 and OFF.
- The volume decreases as you move closer to -6.

#### Adjusting Center/Subwoofer Speaker Level

- The volume level can be adjusted in steps from +6dB to -6dB.
- The sound gets louder as you move closer to +6dB and quieter as you get closer to -6dB.

# AV SYNC Setup

Video may look slower than the audio if it is connected to a digital TV. If this occurs, adjust the audio delay time to match the video.

- 1 Press the **MENU** button.

- Setup menu appears.



- 2 Press Cursor **▲, ▼** buttons to move to 'Audio' and then press **ENTER** button.

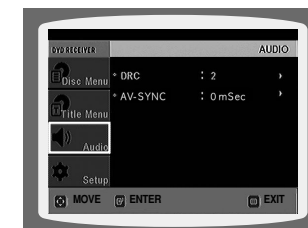

- 3 Press Cursor **▲, ▼** buttons to move to 'AV-SYNC' and then press **ENTER** button.

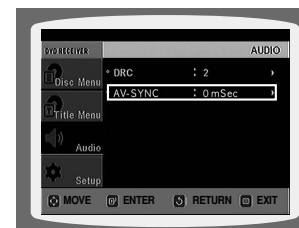

- 4 Press Cursor **▲, ▼** buttons to select the AV-SYNC Delay Time and then press the **ENTER** button.

- You can set the audio delay time between 0 ms and 300 ms. Set it to the optimal status.

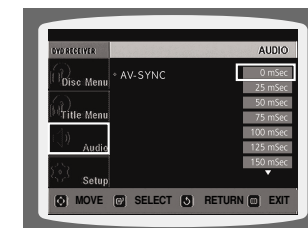

Press **RETURN** button to return to the previous level.

Press **MENU** button to exit the setup screen.



# Sound Field (DSP)/EQ Function

DSP(Digital Signal Processor) DSP modes have been designed to simulate different acoustic environments.  
EQ: You can select ROCK, POP, or CLASSIC to optimize the sound for the genre of music you are playing

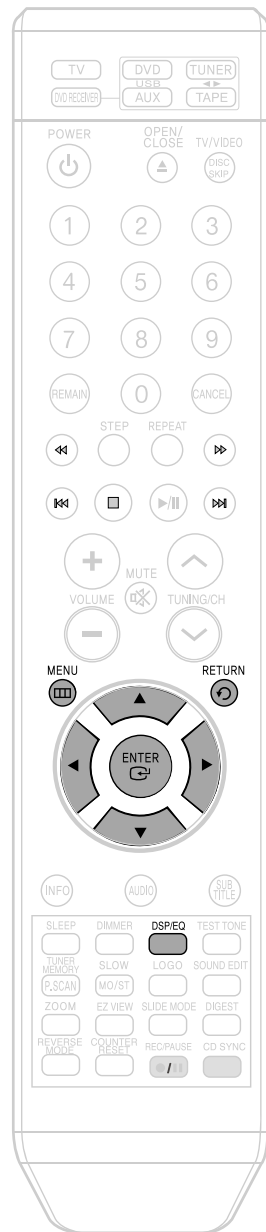

Press **DSP/EQ** button.

- "DSP" appears on the display panel.
- Each time the button is pressed, the selection changes as follows:

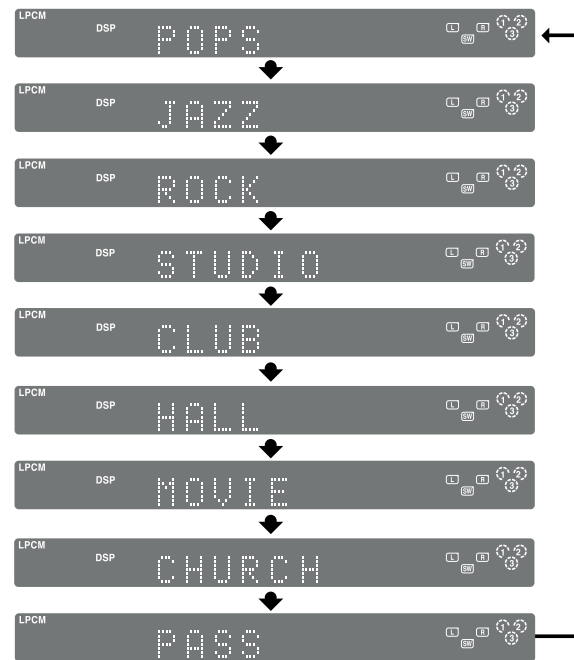

- Note**
- DSP/EQ function is only available in STEREO mode.
  - This feature works with CDs, MP3-CDs, 2 channel DivX and Dolby Digital discs.
  - When playing a DVD disc encoded with two or more channels, multi-channel mode will be selected automatically and DSP/EQ function does not work.

**POP, JAZZ, ROCK:** Depending on the genre of music, you can select POP, JAZZ, and ROCK.

**STUDIO :** Provides a sense of presence as if in a studio.

**CLUB :** Simulates the sound of a dance club with a throbbing bass beat.

**HALL :** Provides a clear vocal as if listening in a concert hall.

**MOVIE:** Provides the feeling of a movie theater.

**CHURCH:** Gives the feel of being in a grand church.

**PASS:** Select this for normal listening.

# Listening to Radio

## Remote Control Unit

- 1 Press the **TUNER** button and select the FM band.

- 2 Tune in to the desired station.

**Automatic Tuning 1** When **◀▶▶▶▶** is pressed, a preset broadcast station is selected.

**Automatic Tuning 2** Press and hold **TUNING/CH** to automatically search for active broadcasting stations.

**Manual Tuning** Briefly press **TUNING/CH** to increase or decrease the frequency incrementally.



## Main Unit

- 1 Press the **FUNCTION** button to select the FM band.

- 2 Select a broadcast station.

**Automatic Tuning 1** Press the **STOP** (■) button to select **PRESET** and then press **◀▶▶▶▶** button to select the preset station.

**Automatic Tuning 2** Press the **STOP** (■) button to select "MANUAL" and then press and hold **◀▶▶▶▶** button to automatically search the band.

**Manual Tuning** Press **STOP** (■) to select **MANUAL** and then briefly press **◀▶▶▶▶** to tune in to a lower or higher frequency.

Press **MO/ST** button to listen in Mono/Stereo.  
(This applies only when listening to an FM station.)

- Each time the button is pressed, the sound switches between "STEREO" and "MONO".
- In a poor reception area, select MONO for a clear, interference-free broadcast.

# Presetting Stations

• AM:15 , FM:15

Example: Presetting FM 89.1 in the memory

**1** Press the **TUNER** button and select the FM band.

FM 91.90 MHz

**2** Press **TUNING/CH** to select "89.10".

- Refer to Step 2 on page 61 to automatically or manually tune in to a station.

FM 89.10 MHz

**3** Press the **TUNER MEMORY** button.

- "PRGM" flashes in the display.

PRGM FM 89.10 MHz

**4** Press **◀▶▶▶** to select preset number.

- You can select between 1 and 15 presets.

PRGM 01 FM 89.10 MHz

**5** Press the **TUNER MEMORY** button again.

- Press the **TUNER MEMORY** button before 'PRGM' disappears from the display.
- 'PRGM' disappears from the display and the station is stored in memory.

FM 89.10 MHz

**6** To preset another station, repeat steps 2 to 5.

To tune in to a preset station, press **◀▶▶▶** on the remote control to select a channel.

# Listening to a Cassette

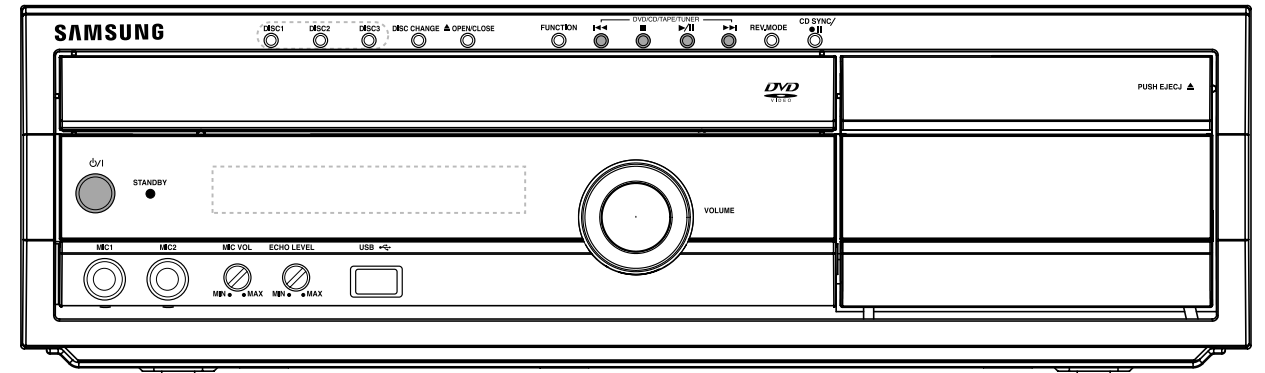

**1** Switch the system on by pressing **POWER**.

**2** Select the **TAPE** function by pressing **FUNCTION**.

**3** Press the **PUSH EJECT** (▲) of the cassette deck to open the cassette door and insert a cassette.

**4** Press the **PLAY (▶||)** button.

- The cassette starts playing.
- \* **Side A** : Play (▶||) button once.
- \* **Side B** : Play (▶||) button twice.

**5** Press the **◀▶▶▶** button if necessary.

- Rewind the cassette **◀◀** button.
- Fast-forward the cassette **▶▶▶▶** button.



**6** When you have finished playback, press **STOP** button.



# Selecting the Cassette Playback Mode

Your micro component system has three cassette playback modes which enable you to listen to both sides of a cassette automatically.

Press **REV.MODE** until the appropriate symbol is displayed.

-  : One side of the selected cassette and then stops.
-  : One side of the cassette.  
The other side of the cassette and then stops.
-  : Both sides of the cassette indefinitely until you press stop.

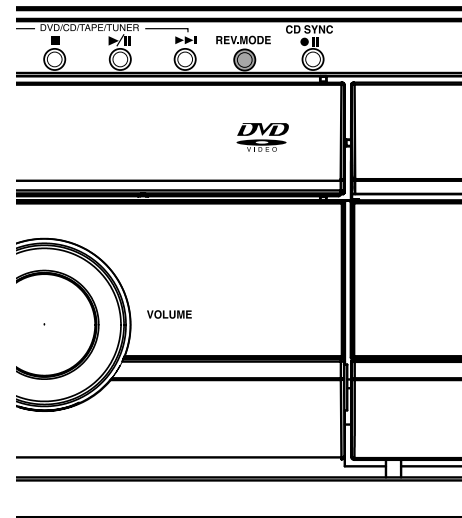

# Tape Counter

When playing a cassette, a counter is displayed to enable you to take note of the counter value at the start of each track and thus start playback at the beginning of the track to which you wish to listen.

Before starting to record a cassette for which you wish to take note of the counter values at the beginning of each track, reset the counter by pressing **COUNTER RESET**.

- The counter is only displayed when a cassette is being played.

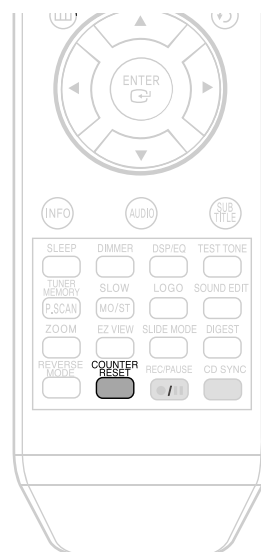

# Recording a Compact Disc

You can record a compact disc on a cassette in two different ways:

## Synchronised recording

This feature enables you to synchronize the start of the recording with the start of the disc or track of your choice.

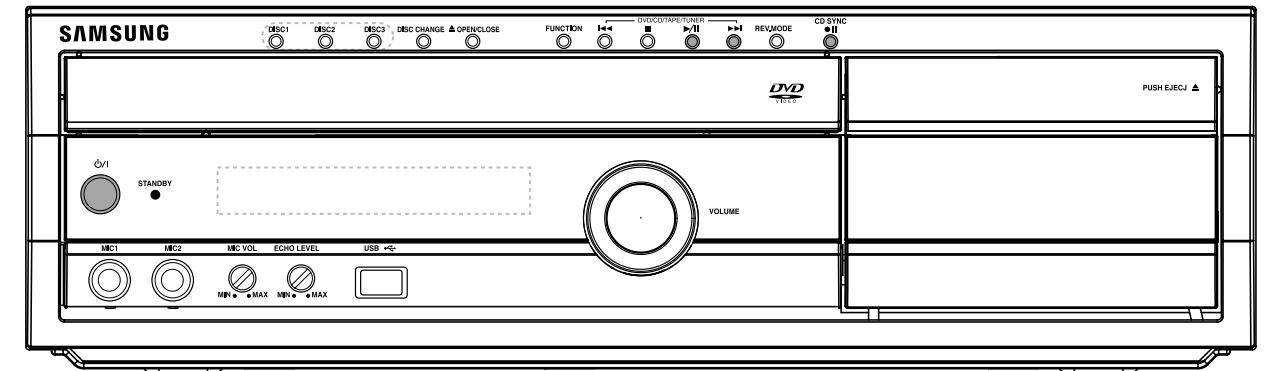



**1** Switch the system on by pressing **POWER**.



**2** Insert a blank cassette in Deck.

**3** Load a compact disc.

- Press the **PUSH/EJECT** button (  ) to open the cassette door, insert a cassette, and then close the cassette door.
- Insert the cassette with the safety tabs.

- Press the **OPEN/CLOSE** button (  ) to open the CD door.
- Insert a CD and press the **OPEN/CLOSE** button (  ) to close the CD door.

**4** Press the **PLAY** (  ) button.

- Use the CD selection (  ,  ) buttons to select the desired song.

**5** Press and hold **CD SYNC.** (  ) button.

- When stopped, Press and hold the button to start the recording from the first piece of music.
- Press and hold **CD SYNC.** (  ) button during the playback of CD to start the recording from the first part of the music being played.

**6** To stop recording, press **■** button.

# Recording a Radio Program

You can record a radio program of your choice.  
You do not need to adjust the volume, as it has no effect on the recording.

## Direct recording

The direct recording mode enables you to start recording with any track on the compact disc.

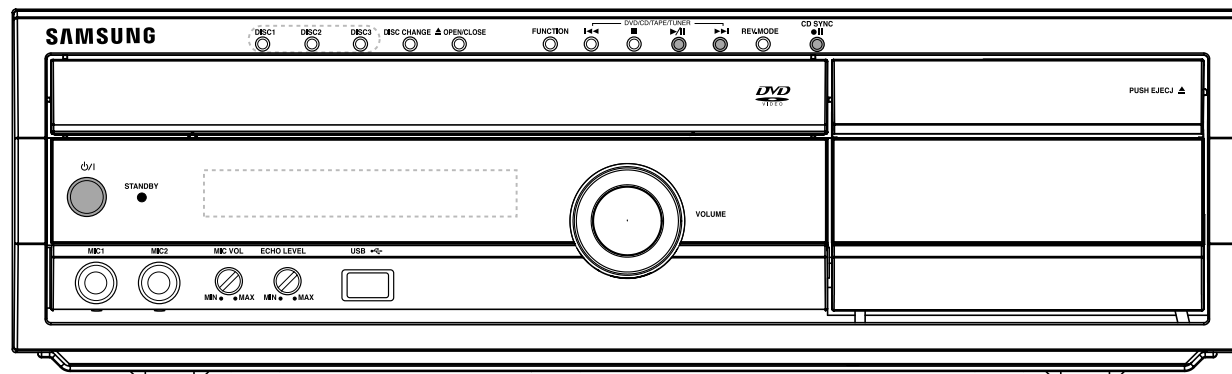

**1** Switch the system on by pressing **POWER**.

**2** Insert a blank cassette in Deck.

- Press the **PUSH/EJECT** button (▲) to open the cassette door, insert a cassette, and then close the cassette door.
- Insert the cassette with the safety tabs.

**3** Load a compact disc.

- Press the **OPEN/CLOSE** button (▲) to open the CD door.
- Insert a CD and press the **OPEN/CLOSE** button (▲) to close the CD door.

**4** Press the **PLAY** (▶||) button.

- Use the CD selection (|◀◀▶▶|) buttons to select the desired song.

**5** Press the **CD SYNC.** (●/||) button.

- Recording will begin.
- To stop recording, press ■ button.

### Note

- The cassette tape you want to record on must have the safety tabs intact.

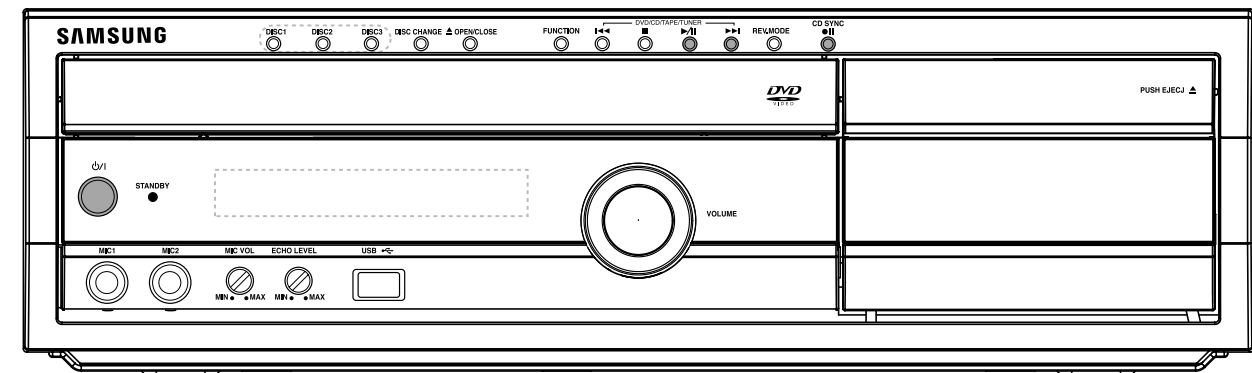

**1** Switch the system on by pressing **POWER**.

**2** Insert a blank cassette in Deck.

**3** Select the **TUNER** function by pressing **FUNCTION**.

**4** Select the radio station that you wish to record by pressing ◀◀ or ▶▶ button .

**5** Press the **CD SYNC.** (●/||) button.

- REC is displayed and recording starts.

**6** To stop recording, press ■ button.

# Convenient Functions

## Sleep Timer Function

You can set the time that the Home Theater will shut itself off.

Press **SLEEP** button.

- "SLEEP" will be displayed. Each time the button is pressed, the preset time changes as follows: 10 → 20 → 30 → 60 → 90 → 120 → 150 → OFF.

SLEEP 10

To confirm the sleep timer setting, press **SLEEP** button.

- The remaining time before the Home Theater will shut itself off is displayed.
- Pressing the button again changes the sleep time from what you have set earlier.

To cancel the sleep timer, press **SLEEP** button until OFF appears on the display.

## Adjusting Display Brightness

You can adjust the brightness of the display on the main unit so it won't interfere with your movie viewing.

Press **DIMMER** button.

- Each time the button is pressed, the brightness changes as follows: SLIGHTLY DARK → DARK → BRIGHT.

## Mute Function

This is useful when answering a doorbell or telephone call.

Press **MUTE** button.

- 'MUTE ON' appears in the display.
- To restore the sound, press the button again to select 'MUTE OFF'.

MUTE ON

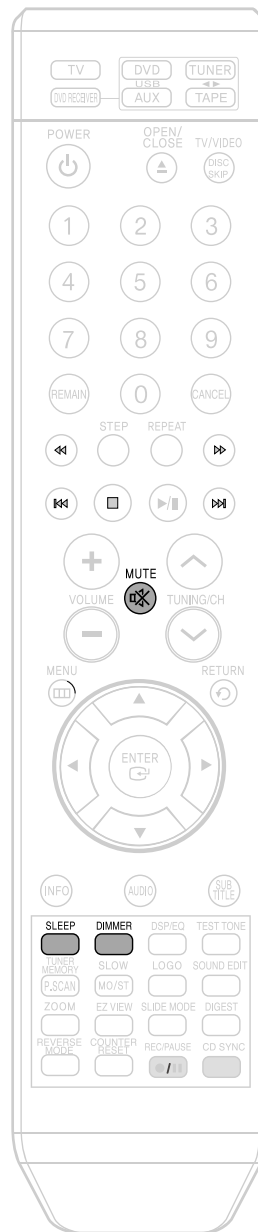

# Connecting Microphone

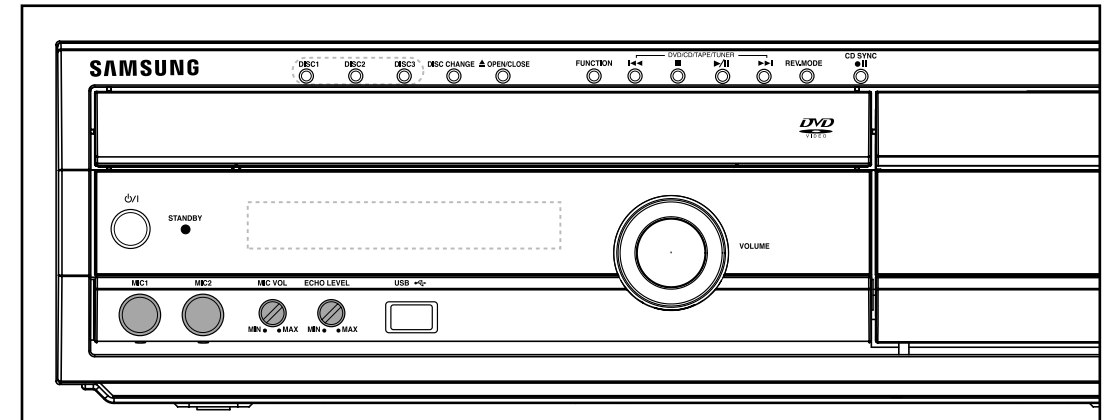

**1** Connect the microphone to the MIC jack on the front panel.

- You can connect up to two microphones.

**2** Turn the **MIC VOL** to adjust the voice volume of the microphone.

**3** Turn the **ECHO LEVEL** to adjust the echo level of the microphone.

# Operating a TV with the Remote Control

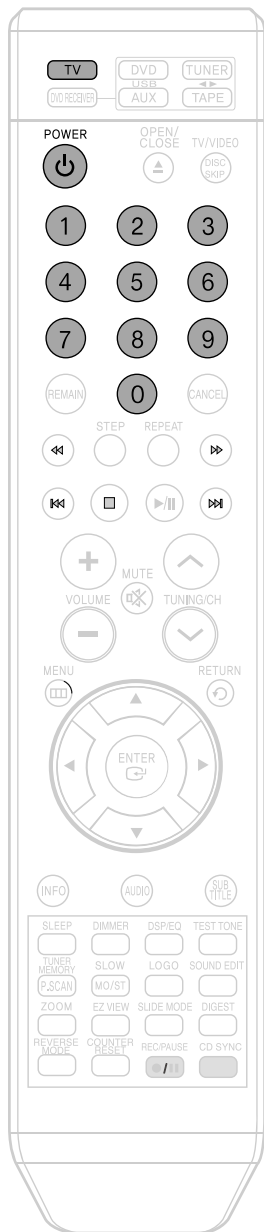

## When operating a TV with the remote control

**1** Press **TV** button to select TV mode.

**2** Press **POWER** button to turn on the TV.

**3** Point the remote control toward the TV.

**4** While holding down **POWER**, enter the code corresponding to your brand of TV.

- If the code matches the TV's code, the TV will be turned off.
- If there is more than one code listed for your TV in the table, enter one at a time to determine which code works.

**Example: For a Samsung TV**

While holding down **POWER**, use the number buttons to enter 00, 15, 16, 17 and 40.

**5** Point the remote control toward the TV and press **POWER**. If the TV turns off or on, the setting is complete.

- You can use the TV **POWER**, **VOLUME**, **CHANNEL**, and **Numeric** buttons (0~9).

**Note**

- The remote control may not work on some brands of TVs. Also, some operations may not be possible depending on your brand of TV.
- If you do not set the remote control with the code for your brand of TV, the remote control will work on a Samsung TV by default.



## TV Brand Code List

No.	Brand	Code	No.	Brand	Code
1	Admiral (M.Wards)	56, 57, 58	44	MTC	18
2	A Mark	01, 15	45	NEC	18, 19, 20, 40, 59, 60
3	Anam	01, 02, 03, 04, 05, 06, 07, 08, 09, 10, 11, 12, 13, 14	46	Nikei	03
4	AOC	01, 18, 40, 148	47	Onking	03
5	Bell & Howell (M.Wards)	57, 58, 81	48	Onwa	03
6	Brocsonic	59, 60	49	Panasonic	06, 07, 08, 09, 54, 66, 67, 73, 74
7	Candle	18	50	Penney	18
8	Cetronic	03	51	Philco	03, 15, 17, 18, 48, 54, 59, 62, 69, 90
9	Citizen	03, 18, 25	52	Philips	15, 17, 18, 40, 48, 54, 62, 72
10	Cinema	97	53	Pioneer	63, 66, 80, 91
11	Classic	03	54	Portland	15, 18, 59
12	Concerto	18	55	Proton	40
13	Contec	46	56	Quasar	06, 66, 67
14	Coronado	15	57	Radio Shack	17, 48, 56, 60, 61, 75
15	Craig	03, 05, 61, 82, 83, 84	58	RCA/Proscan	18, 59, 67, 76, 77, 78, 92, 93, 94
16	Croslex	62	59	Realistic	03, 19
17	Crown	03	60	Sampo	40
18	Curtis Mates	59, 61, 63	61	Samsung	00, 15, 16, 17, 40, 43, 46, 47, 48, 49, 59, 60, 98
19	CXC	03	62	Sanyo	19, 61, 65
20	Daewoo	02, 03, 04, 15, 16, 17, 18, 19, 20, 21, 22, 23, 24, 25, 26, 28, 29, 30, 32, 34, 35, 36, 48, 59, 90	63	Scott	03, 40, 60, 61
21	Daytron	40	64	Sears	15, 18, 19
22	Dynasty	03	65	Sharp	15, 57, 64
23	Emerson	03, 15, 40, 46, 59, 61, 64, 82, 83, 84, 85	66	Signature 2000 (M.Wards)	57, 58
24	Fisher	19, 65	67	Sony	50, 51, 52, 53, 55
25	Funai	03	68	Soundesign	03, 40
26	Futurtech	03	69	Spectricon	01
27	General Electric (GE)	06, 40, 56, 59, 66, 67, 68	70	SSS	18
28	Hall Mark	40	71	Sylvania	18, 40, 48, 54, 59, 60, 62
29	Hitachi	15, 18, 50, 59, 69	72	Symphonic	61, 95, 96
30	Inkel	45	73	Tatung	06
31	JC Penny	56, 59, 67, 86	74	Techwood	18
32	JVC	70	75	Teknika	03, 15, 18, 25
33	KTV	59, 61, 87, 88	76	TMK	18, 40
34	KEC	03, 15, 40	77	Toshiba	19, 57, 63, 71
35	KMC	15	78	Vidtech	18
36	LG (Goldstar)	01, 15, 16, 17, 37, 38, 39, 40, 41, 42, 43, 44	79	Videch	59, 60, 69
37	Luxman	18	80	Wards	15, 17, 18, 40, 48, 54, 60, 64
38	LXI (Sears)	19, 54, 56, 59, 60, 62, 63, 65, 71	81	Yamaha	18
39	Magnavox	15, 17, 18, 48, 54, 59, 60, 62, 72, 89	82	York	40
40	Marantz	40, 54	83	Yupiteru	03
41	Matsui	54	84	Zenith	58, 79
42	MGA	18, 40	85	Zonda	01
43	Mitsubishi/MGA	18, 40, 59, 60, 75	86	Dongyang	03, 54

# Before Calling for Service

Refer to the chart below when this unit does not function properly. If the problem you are experiencing is not listed below or if the instruction below does not help, turn off the unit, disconnect the power cord, and contact the nearest authorized dealer or Samsung Electronics Service Center.

Symptom	Check/Remedy
<b>Disc tray does not open.</b>	<ul style="list-style-type: none"> <li>Is the power cord plugged securely into the outlet?</li> <li>Turn off the power and then turn it back on.</li> </ul>
<b>Playback does not start.</b>	<ul style="list-style-type: none"> <li>Check the region number of the DVD. DVD discs purchased from abroad may not be playable.</li> <li>CD-ROMs and DVD-ROMs cannot be played on this Home Theater.</li> <li>Make sure that the rating level is correct.</li> </ul>
<b>Playback does not start immediately when the Play/Pause button is pressed.</b>	<ul style="list-style-type: none"> <li>Are you using a deformed disc or a disc with scratches on the surface?</li> <li>Wipe the disc clean.</li> </ul>
<b>Sound is not produced.</b>	<ul style="list-style-type: none"> <li>No sound is heard during fast playback, slow playback, and step motion playback.</li> <li>Are the speakers connected properly? Is the speaker setup correctly customized?</li> <li>Is the disc severely damaged?</li> </ul>
<b>Picture does not appear, sound is not produced, or the disc tray opens 2 to 5 seconds later.</b>	<ul style="list-style-type: none"> <li>Was the Home Theater suddenly moved from a cold place to a warm one? When condensation forms inside the player, remove the disc and let the player stand for 1 or 2 hours with the power on. (You can use the player again after condensation disappears.)</li> </ul>
<b>The tape does not start playing</b>	<ul style="list-style-type: none"> <li>The TAPE function has not been selected.</li> <li>The cassette has not been inserted correctly.</li> <li>The cassette player has not been closed.</li> <li>The tape is either slack or broken.</li> </ul>
<b>The volume falls off The cassette is not erased correctly There is excessive wow and flutter</b>	<ul style="list-style-type: none"> <li>The audio heads are dirty.</li> <li>The rollers or drive capstans are dirty.</li> <li>The tape is worn.</li> </ul>

Symptom	Check/Remedy
<ul style="list-style-type: none"> <li><b>Disc is rotating but no picture is produced.</b></li> <li><b>Picture quality is poor and picture is shaking.</b></li> </ul>	<ul style="list-style-type: none"> <li>Is the TV power on?</li> <li>Are the video cables connected properly?</li> <li>Is the disc dirty or damaged?</li> <li>A poorly manufactured disc may not be playable.</li> </ul>
<b>The remote control does not work.</b>	<ul style="list-style-type: none"> <li>Is the remote control being operated within its operation range of angle and distance?</li> <li>Are the batteries exhausted?</li> <li>Have you selected the mode(TV/DVD) functions of the remote control (TV or DVD) correctly?</li> </ul>
<b>Audio language and subtitles do not work.</b>	<ul style="list-style-type: none"> <li>Audio language and subtitles will not work for DVDs not containing them. And depending on the disc, they may work differently.</li> </ul>
<b>Menu screen does not appear even when the menu function is selected.</b>	<ul style="list-style-type: none"> <li>Are you using a disc that does not contain menus?</li> </ul>
<b>Aspect ratio cannot be changed.</b>	<ul style="list-style-type: none"> <li>You can play 16:9 DVDs in 16:9 WIDE mode, 4:3 LETTER BOX mode, or 4:3 PAN SCAN mode, but 4:3 DVDs can be seen in 4:3 ratio only. Refer to the DVD disc jacket and then select the appropriate function.</li> </ul>
<ul style="list-style-type: none"> <li><b>The main unit is not working.</b> (Example: The power goes out or strange noise is heard.)</li> <li><b>The Home Theater is not working normally.</b></li> </ul>	<ul style="list-style-type: none"> <li>Turn off the power and hold the  button on the main unit for longer than 5 seconds.</li> </ul> <p><b>Using the RESET function will erase all stored settings. Do not use this unless necessary.</b></p>
<b>The password for rating level has been forgotten.</b>	<ul style="list-style-type: none"> <li>While "NO DISC" message appears on the display of main unit, hold the main unit's  button for longer than 5 seconds. "INITIALIZE" appears on the display and all settings will return to the default values.</li> <li>Press the POWER button.</li> </ul> <p><b>Using the RESET function will erase all stored settings. Do not use this unless necessary.</b></p>
<b>Can't receive radio broadcast.</b>	<ul style="list-style-type: none"> <li>Is the antenna connected properly?</li> <li>If the antenna's input signal is weak, install an external FM antenna in an area with good reception.</li> </ul>

# Cautions on Handling and Storing Discs

Small scratches on the disc may reduce sound and picture quality or cause skipping. Be especially careful not to scratch discs when handling them.

## ● Handling discs

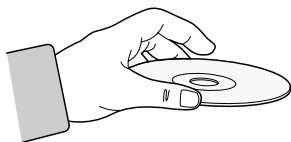

**Do not touch the playback side of the disc. Hold the disc by the edges so that fingerprints will not get on the surface. Do not stick paper or tape on the disc.**

## ● Disc Storage

**Do not keep in direct sunlight**

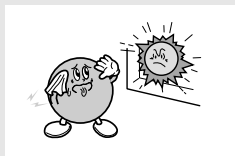

**Keep in a cool ventilated area**

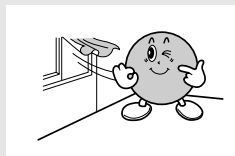

**Keep in a clean Protection jacket. Store vertically.**

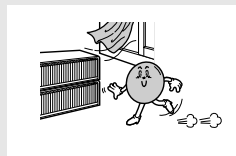

### Caution

- Do not allow the discs to become contaminated with dirt.
- Do not load cracked or scratched discs.

## ● Handling and Storing Discs



**When you get fingerprints or dirt on the disc, clean it with a mild detergent diluted in water and wipe with a soft cloth.**

- When cleaning, wipe gently from the inside to the outside of the disc.

### Note

- Condensation may form if warm air comes into contact with cold parts inside the player. When condensation forms inside the player, the player may not operate correctly. If this occurs, remove the disc and let the player stand for 1 or 2 hours with the power on.

# Language Code List

Enter the appropriate code number for the initial settings "Disc Audio", "Disc Subtitle" and/or "Disc Menu" (See page 39).

Code	Language	Code	Language	Code	Language	Code	Language
1027	Afar	1181	Frisian	1334	Latvian, Lettish	1506	Slovenian
1028	Abkhazian	1183	Irish	1345	Malagasy	1507	Samoan
1032	Afrikaans	1186	Scots Gaelic	1347	Maori	1508	Shona
1039	Amharic	1194	Galician	1349	Macedonian	1509	Somali
1044	Arabic	1196	Guarani	1350	Malayalam	1511	Albanian
1045	Assamese	1203	Gujarati	1352	Mongolian	1512	Serbian
1051	Aymara	1209	Hausa	1353	Moldavian	1513	Siswati
1052	Azerbaijani	1217	Hindi	1356	Marathi	1514	Sesotho
1053	Bashkir	1226	Croatian	1357	Malay	1515	Sundanese
1057	Byelorussian	1229	Hungarian	1358	Maltese	1516	Swedish
1059	Bulgarian	1233	Armenian	1363	Burmese	1517	Swahili
1060	Bihari	1235	Interlingua	1365	Nauru	1521	Tamil
1069	Bislama	1239	Interlingue	1369	Nepali	1525	Tegulu
1066	Bengali; Bangla	1245	Inupiak	1376	Dutch	1527	Tajik
1067	Tibetan	1248	Indonesian	1379	Norwegian	1528	Thai
1070	Breton	1253	Icelandic	1393	Occitan	1529	Tigrinya
1079	Catalan	1254	Italian	1403	(Afan) Oromo	1531	Turkmen
1093	Corsican	1257	Hebrew	1408	Oriya	1532	Tagalog
1097	Czech	1261	Japanese	1417	Punjabi	1534	Setswana
1103	Welsh	1269	Yiddish	1428	Polish	1535	Tonga
1105	Danish	1283	Javanese	1435	Pashto, Pushto	1538	Turkish
1109	German	1287	Georgian	1436	Portuguese	1539	Tsonga
1130	Bhutani	1297	Kazakh	1463	Quechua	1540	Tatar
1142	Greek	1298	Greenlandic	1481	Rhaeto-Romance	1543	Twi
1144	English	1299	Cambodian	1482	Kirundi	1557	Ukrainian
1145	Esperanto	1300	Kannada	1483	Romanian	1564	Urdu
1149	Spanish	1301	Korean	1489	Russian	1572	Uzbek
1150	Estonian	1305	Kashmiri	1491	Kinyarwanda	1581	Vietnamese
1151	Basque	1307	Kurdish	1495	Sanskrit	1587	Volapuk
1157	Persian	1311	Kirghiz	1498	Sindhi	1613	Wolof
1165	Finnish	1313	Latin	1501	Sangro	1632	Xhosa
1166	Fiji	1326	Lingala	1502	Serbo-Croatian	1665	Yoruba
1171	Faeroese	1327	Laothian	1503	Singhalese	1684	Chinese
1174	French	1332	Lithuanian	1505	Slovak	1697	Zulu

# USB Host Feature Supported Products

## Digital Camera

Product	Company	Type
Finepix-A340	Fuji	Digital Camera
Finepix-F810	Fuji	Digital Camera
Finepix-F610	Fuji	Digital Camera
Finepix-f450	Fuji	Digital Camera
Finepix S7000	Fuji	Digital Camera
Finepix A310	Fuji	Digital Camera
KD-310Z	Konica	Digital Camera
Finecam SL300R	Kyocera	Digital Camera
Finecam SL400R	Kyocera	Digital Camera
Finecam S5R	Kyocera	Digital Camera
Finecam Xt	Kyocera	Digital Camera
Dimage-Z1	Minolta	Digital Camera
Dimage Z1	Minolta	Digital Camera
Dimage X21	Minolta	Digital Camera
Coolpix4200	Nikon	Digital Camera
Coolpix4300	Nikon	Digital Camera
Coolpix 2200	Nikon	Digital Camera
Coolpix 3500	Nikon	Digital Camera
Coolpix 3700	Nikon	Digital Camera
Coolpix 4100	Nikon	Digital Camera
Coolpix 5200	Nikon	Digital Camera
Stylus 410 digital	Olympus	Digital Camera
300-digital	Olympus	Digital Camera
U300	Olympus	Digital Camera
X-350	Olympus	Digital Camera
C-760	Olympus	Digital Camera
C-5060	Olympus	Digital Camera
X1	Olympus	Digital Camera
U-mini	Olympus	Digital Camera
Lumix-FZ20	Panasonic	Digital Camera
DMC-FX7GD	Panasonic	Digital Camera
Lumix LC33	Panasonic	Digital Camera
LUMIX DMC-F1	Panasonic	Digital Camera
Optio-S40	Pentax	Digital Camera
Optio-S50	Pentax	Digital Camera
Optio 33LF	Pentax	Digital Camera
Optio MX	Pentax	Digital Camera
Digimax-420	Samsung	Digital Camera
Digimax-400	Samsung	Digital Camera
Sora PDR-T30	Toshiba	Digital Camera
Coolpix 5900	Nikon	Digital Camera
Coolpix S1	Nikon	Digital Camera
Coolpix 7600	Nikon	Digital Camera
DMC-FX7	Panasonic	Digital Camera
Dimage Xt	Minolta	Digital Camera
AZ-1	Olympus	Digital Camera

## USB Flash Disk

Product	Company	Type
Cruzer Micro	Sandisk	USB 2.0 USB Flash Drive 128M
Cruzer Mini	Sandisk	USB 2.0 128M
Cruzer Mini	Sandisk	USB 2.0 256M
SONY Micro Vault	Sony	USB 2.0 64MB
FLEX DRIVE	Serotech	USB 2.0 32MB
AnyDrive	A.L tech	USB 2.0 128MB
XTICK	LG	USB 2.0 128M
Micro Mini	lomega	USB 2.0 128M
iFlash	Imation	USB 2.0 64M
LG	XTICK(M)	USB 2.0 64M
RiDATA	EZDrive	USB 2.0 64M

## MP3 Player

Product	Company	Type
Creative MuVo NX128M	Creative	128 MB MP3 Player
Iriver H320	Iriver	20G HDD MP3 Player
YH-920	Samsung	20G HDD MP3 Player
YP-T7	Samsung	MP3 Player
YP-MT6	Samsung	MP3 Player
YP-T6	Samsung	MP3 Player
YP-53	Samsung	MP3 Player
YP-ST5	Samsung	MP3 Player
YP-T5	Samsung	MP3 Player
YP-60	Samsung	MP3 Player
YP-780	Samsung	MP3 Player
YP-35	Samsung	MP3 Player
YP-55	Samsung	MP3 Player
iAUDIO U2	Cowon	MP3 Player
iAUDIO G3	Cowon	MP3 Player
iAudio M3	Cowon	HDD MP3 Player
SI-M500L	Sharp	256MB MP3 Player
H10	Iriver	MP3 Player
YP-T5 VB	Samsung	MP3 Player
YP-53	Samsung	256MB MP3 Player

## Multi Card Reader

Product	Company	Type
UNICORN	Unicorn	USB 2.0 7 IN 1 CARD READER UC-601R
USB 2.0 Card Reader	Billinton(Taiwan)	USB 2.0 Card Reader for SD/MMC/RS-MMC(3-in-1)

## USB External HDD

Product	Company	Type
CUTIE	Serotech	POCKET HARD DISK DRIVE
MOMOBAY UX-2	Dvico	USB 2.0

# Specifications

GENERAL	Power Consumption	70W		
	Weight	5.2Kg		
	Dimensions (W x H x D)	430 x 128 x 360 mm		
	Operating Temperature Range	+5°C~+35°C		
	Operating Humidity Range	10% ~ 75%		
FUNCTION	Usable Sensitivity	10dB		
	S/N Ratio	60dB		
	Distortion	0.5%		
VIDEO OUTPUT	Composite Video	1.0Vp-p(75Ω load)		
	Component Video	Y:1.0Vp-p(75Ω load) Pr:0.70Vp-p(75Ω load) Pb:0.70Vp-p(75Ω load)		
AMPLIFIER	Front speaker output	70W x 2(3Ω)		
	Center speaker output	70W(3Ω)		
	Subwoofer speaker output	100W(3Ω)		
	Frequency range	20Hz~20KHz		
	S/N Ratio	75dB		
	Channel separation	60dB		
Input sensitivity	(AUX)400mV			
SPEAKER	Speaker system	3.1 ch speaker system		
		Front/Center speaker	Subwoofer speaker	
	Impedance	3Ω x 3	3Ω	
	Frequency range	145Hz~20KHz	35Hz~140Hz	
	Output sound pressure level	85dB/W/M	85dB/W/M	
	Rated input	70W	100W	
	Maximum input	140W	200W	
	Dimensions (W x H x D)	Front	175 x 372x 253 mm	220 x 372 x 358 mm
		Center	430 x 115 x 150 mm	
	Weights	Front	6.6 Kg	6.6 kg
Center		2.2 Kg		

## Free Manuals Download Website

<http://myh66.com>

<http://usermanuals.us>

<http://www.somanuals.com>

<http://www.4manuals.cc>

<http://www.manual-lib.com>

<http://www.404manual.com>

<http://www.luxmanual.com>

<http://aubethermostatmanual.com>

Golf course search by state

<http://golfingnear.com>

Email search by domain

<http://emailbydomain.com>

Auto manuals search

<http://auto.somanuals.com>

TV manuals search

<http://tv.somanuals.com>