

HT-E3500

5.1CH Blu-ray™  
Home Entertainment System  
user manual

imagine the possibilities



Thank you for purchasing this Samsung product.  
To receive more complete service,  
please register your product at  
[www.samsung.com/register](http://www.samsung.com/register)



# Safety Information

## Warning

TO REDUCE THE RISK OF ELECTRIC SHOCK, DO NOT REMOVE THE COVER(OR BACK). NO USER-SERVICEABLE PARTS ARE INSIDE. REFER SERVICING TO QUALIFIED SERVICE PERSONNEL.

	<b>CAUTION</b> RISK OF ELECTRIC SHOCK DO NOT OPEN	
This symbol indicates "dangerous voltage" inside the product that presents a risk of electric shock or personal injury.	<b>CAUTION:</b> TO PREVENT ELECTRIC SHOCK, MATCH WIDE BLADE OF PLUG TO WIDE SLOT, FULLY INSERT.	This symbol indicates important instructions accompanying the product.

## WARNING

- To reduce the risk of fire or electric shock, do not expose this appliance to rain or moisture.

## CAUTION

- Apparatus shall not be exposed to dripping or splashing and no objects filled with liquids, such as vases, shall be placed on the apparatus.
- The Mains plug is used as a disconnect device and shall stay readily operable at any time.
- This apparatus shall always be connected to an AC outlet with a protective grounding connection.
- To disconnect the apparatus from the mains, the plug must be pulled out from the mains socket, therefore the mains plug shall be readily operable.

**CLASS 1 LASER PRODUCT**  
**KLASSE 1 LASER PRODUKT**  
**LUOKAN 1 LASER LAITE**  
**KLASS 1 LASER APPARAT**  
**PRODUCTO LÁSER CLASE 1**

## CLASS 1 LASER PRODUCT

This Compact Disc player is classified as a CLASS 1 LASER product.

Use of controls, adjustments or performance of procedures other than those specified herein may result in hazardous radiation exposure.

## CAUTION

- INVISIBLE LASER RADIATION WHEN OPEN AND INTERLOCKS DEFEATED, AVOID EXPOSURE TO BEAM.

## Disc Storage & Management

- Holding Discs

- Fingerprints or scratches on a disc may reduce sound and picture quality or cause skipping.
- Avoid touching the surface of a disc where data has been recorded.
- Hold the disc by the edges so that fingerprints will not get on the surface.
- Do not stick paper or tape on the disc.



- Cleaning Discs

- If you get fingerprints or dirt on a disc, clean it with a mild detergent diluted in water and wipe with a soft cloth.
- When cleaning, wipe gently from the inside to the outside of the disc.
- Disc Storage
  - Do not keep in direct sunlight.
  - Keep in a cool ventilated area.
  - Keep in a clean protection jacket and store vertically.



## Handling Cautions

- Do not expose this apparatus to dripping or splashing. Do not put objects filled with liquids, such as vases, on the apparatus.
- To turn this apparatus off completely, you must pull the power plug out of the wall socket. Consequently, the power plug must be easily and readily accessible at all times.
- Do not touch the power plug with a wet hand. It can cause an electric shock.
- Do not plug multiple electric devices into the same wall socket. Overloading a socket can cause it to overheat, resulting in a fire.
- Maintenance of the Cabinet
  - Before connecting other components to this product, be sure to turn them off.
  - If you move your product suddenly from a cold place to a warm place, condensation may occur on the operating parts and lens and cause abnormal disc playback. If this occurs, unplug the product, wait for two hours, and then connect the plug to the power outlet. Then, insert the disc, and try to play back again.
- If the product makes an abnormal noise or produces a burning smell or smoke, turn off the power switch immediately and disconnect the power plug from the wall outlet. Then, contact the nearest customer service center for technical assistance. Do not use the product. Using the product as it is may cause a fire or an electric shock.
- To turn this apparatus off completely, you must pull the power plug out of the wall socket. Consequently, the power plug must be easily and readily accessible at all times.

# Safety Information

## Using the 3D Function

### IMPORTANT HEALTH AND SAFETY INFORMATION FOR 3D PICTURES.

Read and understand the following safety information before using the 3D function.

- Some viewers may experience discomfort while viewing 3D TV such as dizziness, nausea, and headaches.  
If you experience any such symptom, stop viewing 3D TV, remove the 3D Active Glasses, and rest.
- Watching 3D images for an extended period of time may cause eye strain. If you feel eye strain, stop viewing 3D TV, remove your 3D Active Glasses, and rest.
- A responsible adult should frequently check on children who are using the 3D function. If there are any reports of tired eyes, headaches, dizziness, or nausea, have the child stop viewing 3D TV and rest.
- Do not use the 3D Active Glasses for other purposes (such as general eyeglasses, sunglasses, protective goggles, etc.)
- Do not use the 3D function or 3D Active Glasses while walking or moving around. Using the 3D function or 3D Active Glasses while moving around may cause you to bump into objects, trip, and/or fall, and cause serious injury.
- If you want to enjoy 3D content, connect a 3D device (3D compliant AV receiver or TV) to the product's HDMI OUT port using a high-speed HDMI cable. Put on 3D glasses before playing the 3D content.
- The product outputs 3D signals only through HDMI cable connected to the HDMI OUT port.
- As the video resolution in 3D play mode is fixed according to the resolution of the original 3D video, you can not change the resolution to your preference.
- Some functions such as BD Wise, screen size adjustment, and resolution adjustment may not operate properly in 3D play mode.
- You must use a high-speed HDMI cable for proper output of the 3D signal.
- Stay at least three times the width of the screen from the TV when watching 3D images. For example, if you have a 46 inch screen, stay 3.5 meters from the screen.

- Place the 3D video screen at eye level for the best 3D picture.

- When the product is connected to some 3D devices, the 3D effect may not function properly.
- This product does not convert 2D content into 3D.
- “Blu-ray 3D” and “Blu-ray 3D” logo are trademarks of the Blu-ray Disc Association.

## Copyright

© 2012 Samsung Electronics Co.,Ltd.

All rights reserved; No part or whole of this user's manual may be reproduced or copied without the prior written permission of Samsung Electronics Co.,Ltd.

## License



- Dolby and the double-D symbol are registered trademarks of Dolby Laboratories.



- Manufactured under license under U.S. Patent Nos: 5,956,674; 5,974,380; 6,226,616; 6,487,535; 7,392,195; 7,272,567; 7,333,929; 7,212,872 & other U.S. and worldwide patents issued & pending. DTS-HD, the Symbol, & DTS-HD and the Symbol together are registered trademarks & DTS-HD Master Audio | Essential is a trademark of DTS, Inc. Product includes software. © DTS, Inc. All Rights Reserved.



- ABOUT DIVX VIDEO: DivX® is a digital video format created by DivX, LLC, a subsidiary of Rovi Corporation. This is an official DivX Certified® device that plays DivX video. Visit [divx.com](http://divx.com) for more information and software tools to convert your files into DivX videos.

ABOUT DIVX VIDEO-ON-DEMAND: This DivX Certified® device must be registered in order to play purchased DivX Video-on-Demand (VOD) movies. To obtain your registration code, locate the DivX VOD section in your device setup menu. Go to [vod.divx.com](http://vod.divx.com) for more information on how to complete your registration.

DivX Certified® to play DivX® video up to HD 1080p, including premium content.

DivX®, DivX Certified® and associated logos are trademarks of Rovi Corporation or its subsidiaries and are used under license.

Covered by one or more of the following U.S. patents : 7,295,673; 7,460,668; 7,515,710; 7,519,274

## HDMI

- The terms HDMI and HDMI High-Definition Multimedia Interface, and the HDMI Logo are trademarks or registered trademarks of HDMI Licensing LLC in the United States and other countries.



- Oracle and Java are registered trademarks of Oracle and/or its affiliates. Other names may be trademarks of their respective owners.
- This item incorporates copy protection technology that is protected by U.S. patents and other intellectual property rights of Rovi Corporation. Reverse engineering and disassembly are prohibited.
- Blu-ray Disc™, Blu-ray™, and the logos are trademarks of Blu-ray Disc Association.

- This product uses Cinavia technology to limit the use of unauthorized copies of some commercially-produced film and videos and their soundtracks. When a prohibited use of an unauthorized copy is detected, a message will be displayed and playback or copying will be interrupted.

More information about Cinavia technology is provided at the Cinavia Online Consumer Information Center at <http://www.cinavia.com>. To request additional information about Cinavia by mail, send a postcard with your mailing address to: Cinavia Consumer Information Center, P.O. Box 86851, San Diego, CA, 92138, USA."

This product incorporates proprietary technology under license from Verance Corporation and is protected by U.S. Patent 7,369,677 and other U.S. and worldwide patents issued and pending as well as copyright and trade secret protection for certain aspects of such technology. Cinavia is a trademark of Verance Corporation.

Copyright 2004-2010 Verance Corporation. All rights reserved by Verance. Reverse engineering or disassembly is prohibited.

# Contents

## SAFETY INFORMATION

- 2 Warning
- 3 Disc Storage & Management
- 3 Handling Cautions
- 4 Using the 3D Function
- 4 Copyright
- 5 License

## GETTING STARTED

- 7 Disk and Format Compatibility
- 8 Logos of Discs the product can play
- 11 Accessories
- 12 Front Panel
- 12 Rear Panel
- 13 Remote Control

## CONNECTIONS

- 14 **Connecting the Speakers**
  - 14 Speaker Components
  - 15 Connecting The Speakers
- 16 **Connecting to a TV**
  - 16 **Method 1** Connecting to a TV with an HDMI Cable - Best Quality (Recommended)
  - 16 **Method 2** Connecting to a TV with an Video Cable - Good Quality
- 17 **Connecting to External Devices**
  - 17 **Method 1** AUX IN : Connecting an External Analog Component
  - 17 **Method 2** OPTICAL : Connecting an External Digital Audio Component
- 18 **Connecting the FM Antenna**
- 18 **Connecting to a Network Router**

## SETTINGS

- 19 The Initial Settings Procedure
- 20 The Home Screen
- 20 Accessing the Settings Screen
- 21 Settings Menu Functions
- 24 Networks and the Internet
- 26 Upgrading Software
- 27 Setting Up AllShare

## MEDIA PLAY

- 28 Using the Streaming Media Services
- 28 Playing Files on a USB Device
- 29 Playing a Disc with User Recorded Content
- 29 Playing a Commercial Video Disc
- 29 Playing a Pre-Recorded Commercial Audio Disc
- 30 Controlling Video Playback
- 32 Controlling Music Playback
- 33 Controlling Photo Playback
- 33 Listening to Radio
- 34 Using the Special Effects Remote Control Buttons
- 34 Using BD-LIVE™
- 35 Using AllShare

## APPENDIX

- 36 Additional Information
- 41 Troubleshooting
- 44 Specifications

## Disk and Format Compatibility

### Disc types and contents your product can play

Media	Disc Type	Details
VIDEO	Blu-ray Disc 3D Blu-ray Disc	BD-ROM or BD-RE/-R disc recorded in the BD-RE format.
	DVD-VIDEO, DVD-RW, DVD-R, DVD+RW, DVD+R	DVD-VIDEO, recorded DVD+RW/DVD-RW(V)/DVDR/+R discs that have been recorded and finalized, or a USB storage media containing MKV, MP4 contents.
MUSIC	CD-RW/-R, DVD-RW/-R, BD-RE/-R	Music recorded on CD-RW/-R, DVD-RW/-R, BD-RE/-R discs or a USB storage media containing MP3 or WMA contents.
PHOTO	CD-RW/-R, DVD-RW/-R, BD-RE/-R	Photos recorded on CD-RW/-R, DVD-RW/-R, BD-RE/-R discs or a USB storage media containing JPEG contents.

#### | NOTE |

- ▶ The product may not play certain CD-RW/-R and DVD-R because of the disc type or recording conditions.
- ▶ If a DVD-RW/-R disc has not been recorded properly in DVD video format, it will not be playable.
- ▶ Your product will not play content that has been recorded on a DVD-R at a bitrate that exceeds 10 Mbps.
- ▶ Your product will not play content that has been recorded on a BD-R or USB device at a bitrate that exceeds 30 Mbps.
- ▶ Playback may not work for some types of discs, or when you use specific operations, such as angle change and aspect ratio adjustment. Information about the discs is written in detail on the disc box. Please refer to this if necessary.
- ▶ When you play a BD-J title, loading may take longer than a normal title or some functions may perform slowly.

### Disc types your product cannot play

- HD DVD
- DVD-ROM/PD/MV-Disc, etc
- DVD-RAM
- Super Audio CD (except CD layer)
- DVD-RW(VR mode)
- CVD/CD-ROM/CDV/CD-G/CD-I/LD (CD-Gs play audio only, not graphics.)
- 3.9 GB DVD-R Disc for Authoring.

#### | NOTE |

- ▶ This product may not respond to all operating commands because some Blu-ray Disc, DVD, and CD discs allow specific or limited operation and provide only certain features during playback. Please note that this is not a defect in the product.
- ▶ Samsung cannot guarantee that this product will play every disc bearing the Blu-ray Disc, DVD or CD logo because disc formats evolve, and problems and errors may occur during the creation of Blu-ray Disc, DVD, and CD software and/or the manufacture of discs.
- ▶ Please contact the SAMSUNG Customer Care Center, if you have questions or encounter difficulty when playing Blu-ray Disc, DVD, or CD discs in this product. Also, refer to rest of this user manual for additional information on playback restrictions.
- ▶ Some commercial discs and DVD discs purchased outside your region may not play on this product.

# Getting Started

## Region Code

Blu-ray players and discs are coded by region. These regional codes must match for a disc to play. If the codes do not match, the disc will not play.







The Region Number for this product is displayed on the rear panel of the product.

Disc Type	Region Code	Area
Blu-ray Disc		North America, Central America, South America, Korea, Japan, Taiwan, Hong Kong and South East Asia.
		Europe, Greenland, French territories, Middle East, Africa, Australia and New Zealand.
		India, China, Russia, Central and South Asia.
DVD-VIDEO		The U.S., U.S. territories and Canada
		Europe, Japan, the Middle East, Egypt, South Africa, Greenland
		Taiwan, Korea, the Philippines, Indonesia, Hong Kong
		Mexico, South America, Central America, Australia, New Zealand, Pacific Islands, Caribbean
		Russia, Eastern Europe, India, most of Africa, North Korea, Mongolia
		China

### | NOTE |

- ▶ If the Region number of a Blu-ray Disc/DVDs does not correspond to the Region number of this product, the product cannot play the disc.

## Logos of Discs the product can play

	
Blu-ray Disc	3D Blu-ray Disc
	
BD-LIVE	Dolby
	
DTS	PAL broadcast system in U.K, France, Germany, etc.
	
Java	

## Supported File Formats

### Notes on the USB connection

- Your player supports USB storage media, MP3 players, digital cameras, and USB card readers.
- The player does not support folder or file names longer than 128 characters.
- Some USB/External HDD/digital camera devices may not be compatible with the player.
- Your player supports the FAT16, FAT32, and NTFS file systems.
- Connect USB devices directly to the player's USB port. Connecting through a USB cable may cause compatibility problems.
- Inserting more than one memory device into a multi-card reader may cause the reader to operate improperly.
- The player does not support the PTP protocol.
- Do not disconnect a USB device during a "loading" process.



- The bigger the image resolution, the longer the image takes to display.
- This player cannot play MP3 files with DRM (Digital Rights Management) downloaded from commercial sites.
- Your player only supports the video that is under 30fps (frame rate).
- You must remove the USB storage device safely (by performing the “**Safely Remove USB**” function) to prevent possible damage to the USB memory.  
Press the **HOME** button to move to the home menu, press the **YELLOW (C)** button, and then press the **⏏** button.
- SAMSUNG is not responsible for any data file damage or data loss.

### Video File Support

File Extension	Container	Video Codec	Audio Codec	Resolution
*.avi	AVI	DivX 3.11/4.x/5.1/6.0	MP3 AC3 DTS WMA PCM	1920x1080
		MP4v3		1920x1080
		H.264 BP/MP/HP		1920x1080
*.mkv	MKV	VC-1 AP	MP3 AC3 DTS	1920x1080
		DivX 5.1/6.0		1920x1080
		H.264 BP/MP/HP		1920x1080
*.wmv	WMV (wmv9)	VC-1 AP	WMA	1920x1080
		VC-1 SM		1920x1080
*.mp4	MP4	MP4 (mp4v)	AAC	1920x1080
		H.264 BP/MP/HP		1920x1080
*.mpg *.mpeg	PS	MPEG1	MP1, 2 Dolby Digital DTS	1920x1080
		MPEG2		1920x1080
		H.264 BP/MP/HP		1920x1080

#### ■ Limitations

- Even when the file is encoded by a supported codec mentioned above, a file might not be played if its content has a problem.
- Normal playback is not guaranteed if the file's container information is wrong or the file itself is corrupted.
- Files having a higher Bitrate or frame rate than standard may stutter during sound/video playback.
- The Seek (skip) function is not available if the file's index table is damaged.

#### ■ Video decoder

- Supports up to H.264 Level 4.1 and AVCHD
- Does not support H.264 FMO/ASO/RS and VC1 SP/MP/AP L4
- MPEG4 SP, ASP :  
Below 1280 x 720 : 60 frames max

# Getting Started

- Above 1280 x 720 : 30 frames max
- Does not support GMC 2 or higher
- **Audio decoder**
- Supports WMA 7, 8, 9 and STD
- Does not support WMA sampling rate of 22050Hz mono.

## Music File Support

File Extension	Container	Audio Codec	Support Range
*.mp3	MP3	MP3	-
*.wma	WMA	WMA	<ul style="list-style-type: none"><li>▪ Sampling rates (in kHz) - 8, 11, 16, 22, 32, 44.1, 48</li><li>▪ Bitrates - All bit-rates from 5kbps to 384kbps</li></ul>

## AVCHD (Advanced Video Codec High Definition)



- This product can play back AVCHD format discs. These discs are normally recorded and used in camcorders.
- The AVCHD format is a high definition digital video camera format.
- The MPEG-4 AVC/H.264 format compresses images with greater efficiency than the conventional image compressing format.
- Some AVCHD discs use the "x.v.Color" format. This product can play back AVCHD discs that use "x.v.Color" format.
- "x.v.Color" is a trademark of Sony Corporation.
- "AVCHD" and the AVCHD logo are trademarks of Matsushita Electronic Industrial Co., Ltd. and Sony Corporation.

### | NOTE |

- ▶ Some AVCHD format discs may not play, depending on the recording conditions.
- ▶ AVCHD format discs need to be finalized.
- ▶ "x.v.Color" offers a wider color range than normal DVD camcorder discs.
- ▶ Some MKV and MP4 format discs may not play, depending on their video resolution and frame rate.

## Accessories

Check for the supplied accessories below.

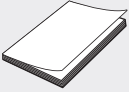
		
Video Cable	FM Antenna	
		
User Manual		Remote Control/ Batteries (AAA size)



- Figures and illustrations in this User Manual are provided for reference only and may differ from actual product appearance.

# Getting Started

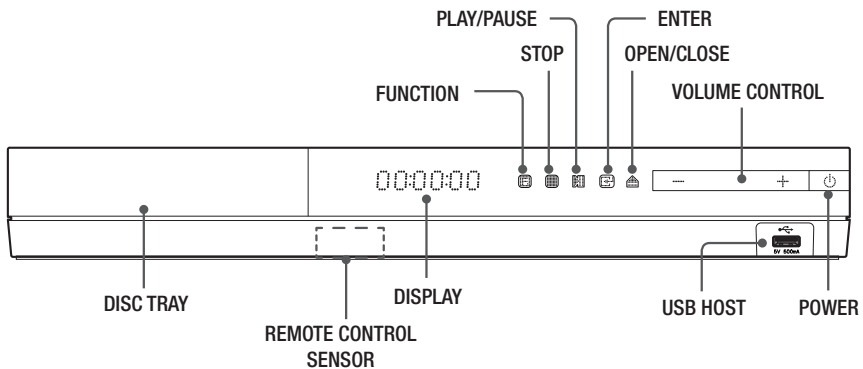
## Front Panel



### | NOTE |

- ▶ To upgrade the product's software through the USB Host jack, you must use a USB memory stick.
- ▶ When the product displays the Blu-ray Disc menu, you cannot start the movie by pressing the  button on the product or the remote. To play the movie, you must select Play Movie or Start in the disc menu, and then press the  button.

## Rear Panel

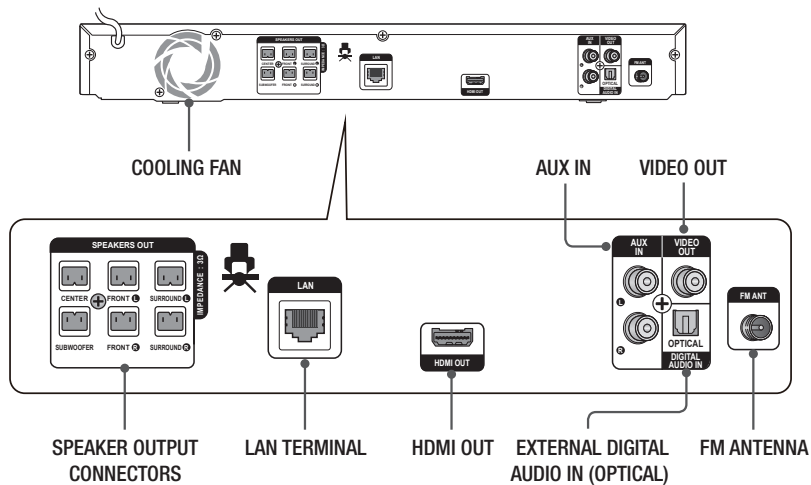

### | NOTE |

- ▶ Ensure a minimum of 10 cm of clear space on all sides of the home theater to ensure adequate ventilation. Do not obstruct the cooling fan or ventilation holes.

## Remote Control

### Tour of the Remote Control

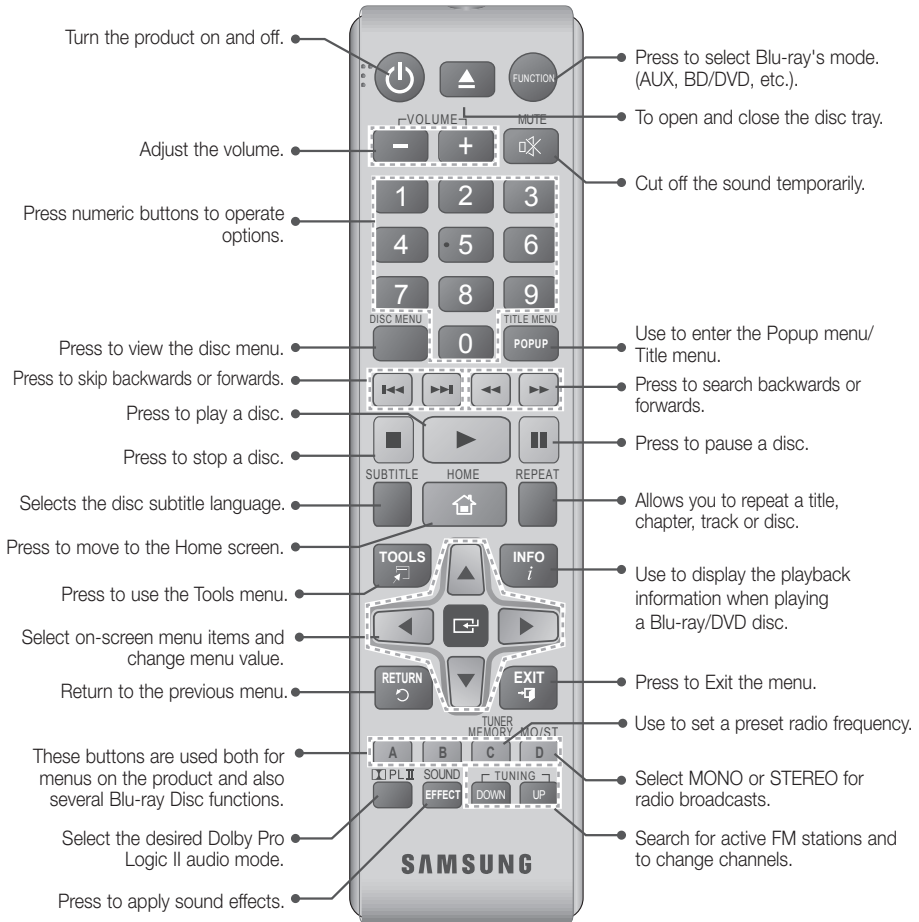

### Installing batteries in the Remote Control

Battery size: AAA

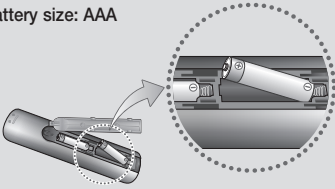

#### NOTE

- ▶ Make sure to match the "+" and "-" ends of the batteries with the diagram inside the compartment.
- ▶ Assuming typical TV usage, the batteries last for about one year.
- ▶ The remote control can be used up to approximately 23 feet (7 meters) from the product in a straight line.

# Connections

This section describes various methods of connecting the product to other external components. Before moving or installing the product, be sure to turn off the power and disconnect the power cord.

## Connecting the Speakers

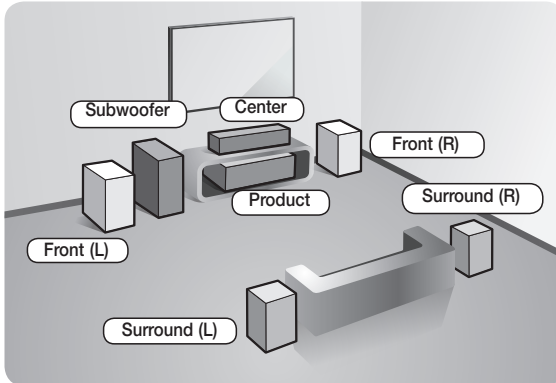

### Position of the product

Place it on a stand or cabinet shelf, or under the TV stand.

### Selecting the Listening Position

The listening position should be located about 2.5 to 3 times the size of the TV's screen from the TV. For example, if you have a 46 inch screen, locate the listening position 2.92 to 3.50 meters from the screen.

<b>Front Speakers</b>	Place these speakers in front of your listening position, facing inwards (about 45°) toward you. Place the front speakers so that their tweeters will be at the same height as your ear. Align the front face of the front speakers with the front face of the center speaker or place them slightly in front of the center speakers.
<b>Center Speaker</b>	It is best to install the Center Speaker at the same height as the front speakers. You can also install it directly over or under the TV.
<b>Surround Speakers</b>	Place these speakers to the side of your listening position. If there isn't enough room, place these speakers so they face each other. Position them about 2 to 3 feet (60 to 90cm) above your ear, facing slightly downward. * Unlike the front and center speakers, the surround speakers are used mainly for sound effects. Sound will not come from them all the time.
<b>Subwoofer</b>	The position of the subwoofer is not so critical. Place it anywhere you like.

## Speaker Components

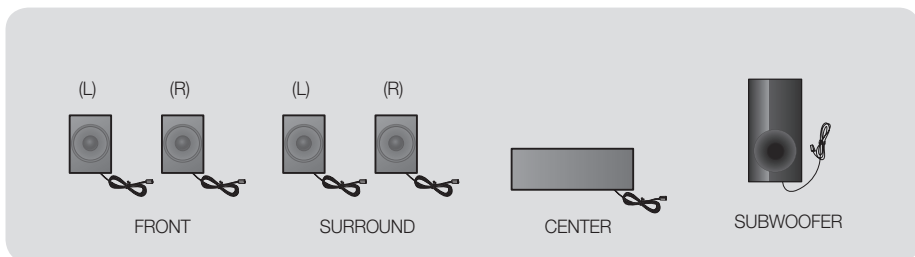

## Connecting The Speakers

- Match the subwoofer cable bundle to the subwoofer by matching the color coded plug on bundle to the colored sticker on the bottom of the subwoofer.
- To attach speaker wire to the subwoofer:
  - Press down the red tab on the back of the subwoofer, insert the red wire, and then release the tab.
  - Press down the black tab on the back of the subwoofer, insert the black wire, and then release the tab.
- Connect the speaker wire plugs from each speaker to the back of the product by matching the colors of the speaker plugs to the colors of the speaker jacks.

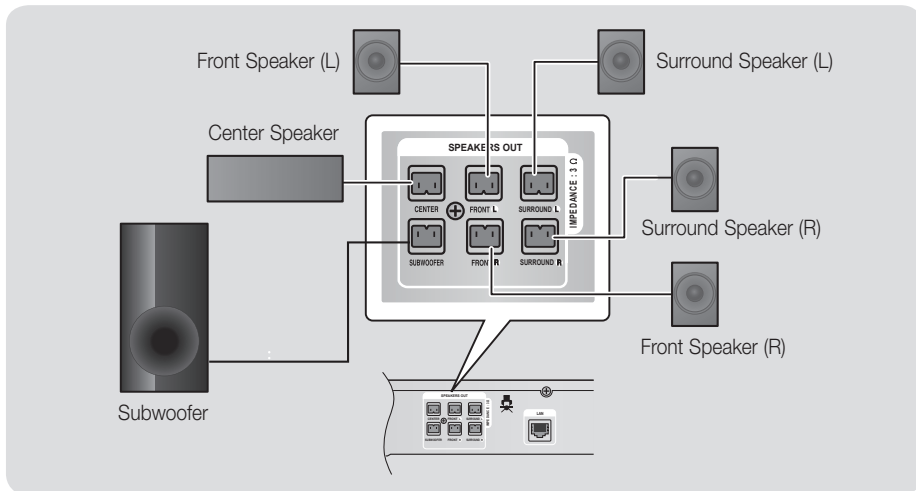
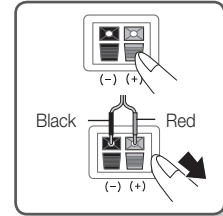

### | CAUTION |

- ▶ To mount your speakers on a wall, fix screws or nails on the desired wall securely and install the speaker using the stud hole on the rear side. Note that screws or nails for wall-mounted installation is not provided with the product.
- ▶ Do not let children play with or near the speakers. They could get hurt if a speaker falls.
- ▶ When connecting the speaker wires to the speakers, make sure that the polarity (+/-) is correct.
- ▶ Keep the subwoofer speaker out of reach of children to prevent children from inserting their hands or alien substances into the duct (hole) of the subwoofer speaker.
- ▶ Do not hang the subwoofer on the wall through the duct (hole).

### | NOTE |

- ▶ If you place a speaker near your TV set, the screen color may be distorted because of the magnetic field.

# Connections

## Connecting to a TV

Select either Method 1 or Method 2.

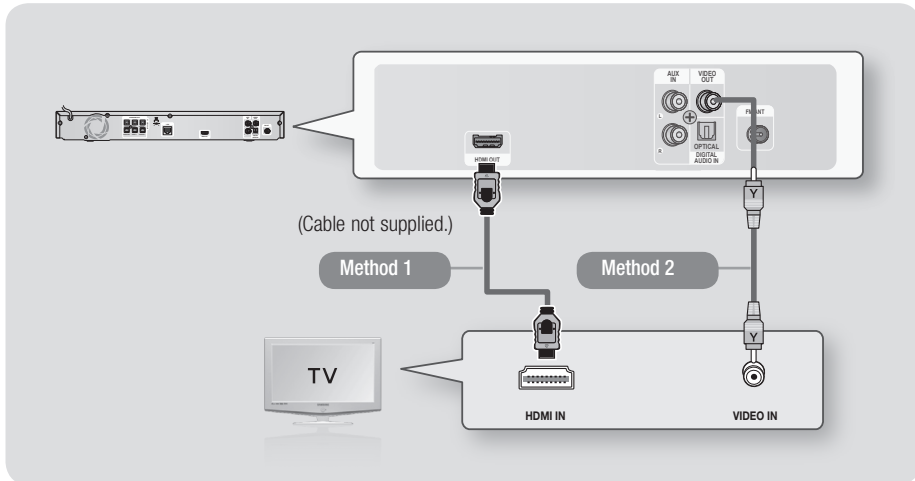

### Method 1 Connecting to a TV with an HDMI Cable - Best Quality (Recommended)

Connect an HDMI cable (not supplied) from the HDMI OUT jack on the back of the product to the HDMI IN jack on your TV.

If the TV supports ARC, you can hear TV sound from home theater with only connect this cable.

### Method 2 Connecting to a TV with an Video Cable - Good Quality

Connect the supplied Video cable from the VIDEO OUT jack on the back of the product to the VIDEO IN jack on your TV.

#### | NOTE |

- ▶ The VIDEO Out jack always outputs in the 576i/480i resolution regardless of the resolution set in the Setup menu.
- ▶ Do not connect the unit through a VCR. Video signals fed through VCRs may be affected by copyright protection systems and the picture will be distorted on the television.



## Connecting to External Devices

To select the correct mode for an external device, press the **FUNCTION** button. Each time you press the button, the mode changes in this order : **BD/DVD** → **D. IN** → **AUX** → **FM**

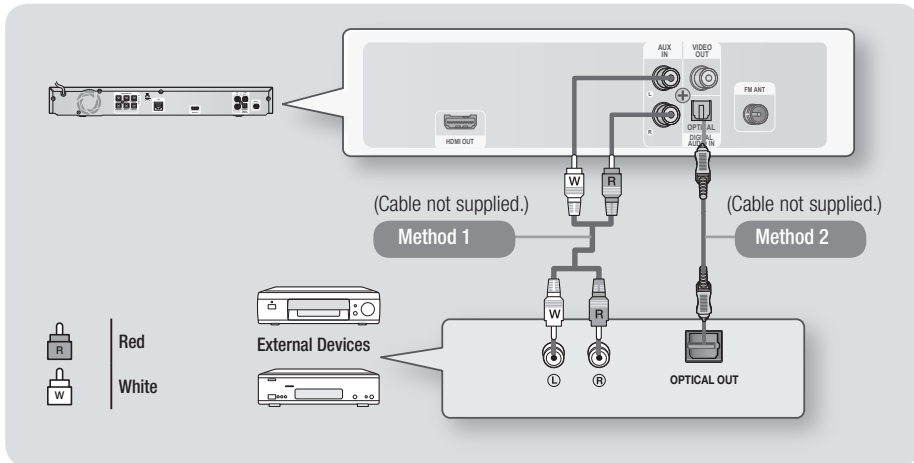

### Method 1 AUX IN : Connecting an External Analog Component

Using an RCA audio cable (not supplied), connect the AUDIO In jack on the product to the AUDIO Out jack on the external analog component. ⇒ Select the **AUX** mode.

- Be sure to match the colors on the cable plugs to the colors on the input and output jacks.

### Method 2 OPTICAL : Connecting an External Digital Audio Component

To connect the digital audio output of digital signal components such as Cable Boxes and Satellite Receivers (Set-Top-Boxes).

Using a digital optical cable (not supplied), connect the Optical Digital Audio In jack on the product to the Digital Optical Out jack of the external digital device using a digital optical cable.

⇒ Select the **D. IN** mode.

#### | NOTE |

- ▶ To see video from your Cable Box/Satellite receiver, you must connect its video output directly to your TV.
- ▶ This system supports Digital sampling frequencies of 32 kHz or higher from external digital components.
- ▶ This system supports only DTS and Dolby Digital audio. MPEG audio, a bitstream format, is not supported.

# Connections

## Connecting the FM Antenna

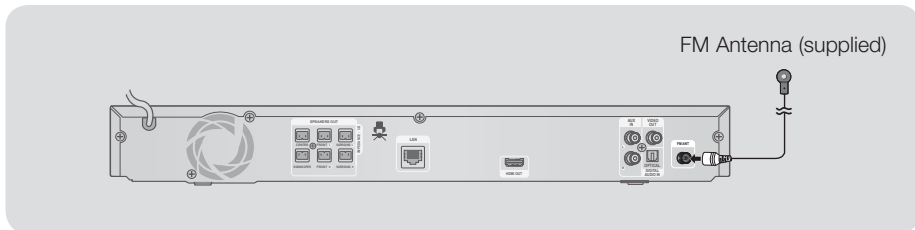

1. Connect the FM antenna supplied to the FM ANTENNA Jack.
2. Slowly move the antenna wire around until you find a location where reception is good, then fasten it to a wall or other rigid surface.

### | NOTE |

- ▶ This product does not receive AM broadcasts.

## Connecting to a Network Router

You can connect your product to your network router using one of the methods illustrated below.

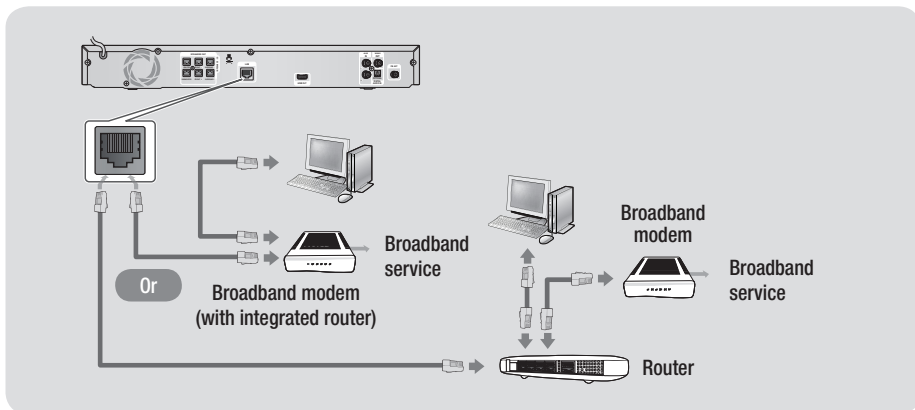

### | NOTE |

- ▶ Internet access to Samsung's software update server may not be allowed, depending on the router you use or your ISP's policy. For more information, contact your ISP (Internet Service Provider).
- ▶ DSL users, please use a router to make a network connection.
- ▶ For the AllShare function, a PC must be connected in the network as shown in the figure.



# Settings

## The Initial Settings Procedure

- The Home menu will not appear if you do not configure the initial settings.
- The OSD (On Screen Display) may change in this product after you upgrade the software version.
- The access steps may differ depending on the menu you selected.

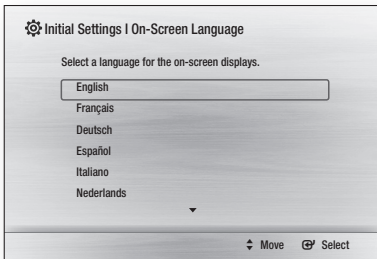
1. Turn on your TV after connecting the product, and then turn on the product. When you turn on the product for the first time, the product automatically displays the Initial Settings Language screen.



2. Press the ▲▼ buttons to select the desired language, and then press the  button.
3. Press the  button to start function setup.

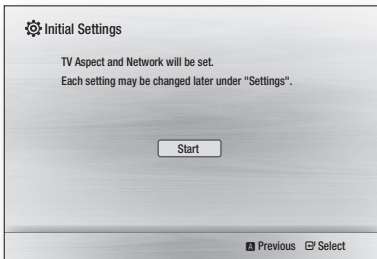

4. The TV Aspect screen appears. Press the ▲▼ buttons to select desired a TV Aspect ratio, and then press the  button.  
You have four choices:

**16:9 Original** - For widescreen TVs. Displays widescreen pictures in their original 16:9 format and 4:3 pictures (the old, standard format) in 4:3 pillar box format with black bars on the left and right.

**16:9 Full** - For widescreen TVs. Displays widescreen pictures in their original 16:9

format and expands 4:3 pictures to fill the 16:9 screen.

**4:3 Letter Box** - For older, standard screen analog TVs. Displays 4:3 pictures in full screen and 16:9 pictures in letter box format that retains the 16:9 aspect ratio but puts black bars above and below the picture.

**4:3 Pan-Scan** - For older, standard screen analog TVs. Displays 4:3 pictures in full screen and 16:9 pictures in Pan-Scan format that fills the screen, but cuts off the left and right sides of the picture and enlarges the middle vertically.

5. The **Network - Wired** screen appears.
  - If you have a network with dynamic IP addresses - and most people do - select **Auto**, press the Enter button, and then go to Step 6.
  - If you have a network with static IP addresses, we suggest you select **Skip** by pressing the **BLUE (D)** button, and then go to "Configuring Your Network Connection" on page 24 after you have completed the initial setup. "Configuring Your Network Connection" provides a full explanation of how to configure your network connection manually.
  - If you have no network, select **Skip** by pressing the **BLUE (D)** button. The Initial Settings Complete screen appears, and then the Home screen appears.

### | NOTE |

- ▶ If you skip network setup here or the setup does not work correctly, you can go to "Configuring Your Network Connection" on page 24 to set up the product's network connection later.

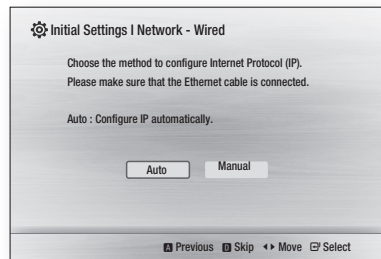

6. The product verifies the network connection and then connects to the network. When it is done, press the Enter button. The Initial Settings Complete screen appears, and then the Home screen appears.

# Settings

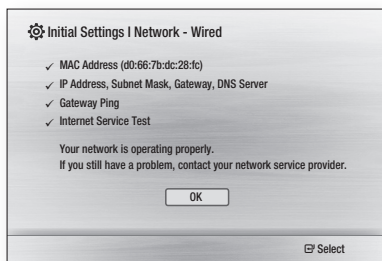

## | NOTE |

- ▶ If you want to display the Initial Setting screen again and make changes, select the Reset option. (See page 24)
- ▶ If you use an HDMI cable to connect the product to an Anynet+(HDMI-CEC)-compliant Samsung TV and 1.) You have set the Anynet+(HDMI-CEC) feature to ON in both the TV and the product and 2.) You have set the TV to a language supported by the product, the product will select that language as the preferred language automatically.

## The Home Screen

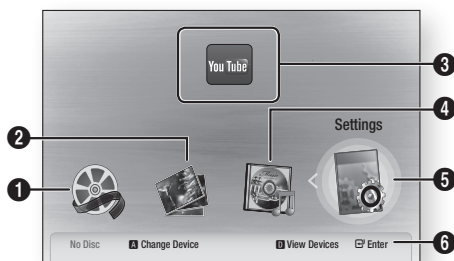

- |   |                                                                                                |
|---|------------------------------------------------------------------------------------------------|
| 1 | <b>Videos.</b> Play videos located on discs, USB devices, or your PC.                          |
| 2 | <b>Photos.</b> View photos located on discs, USB devices, or your PC.                          |
| 3 | <b>Network Services.</b> Select a network service: Vudu, CinemaNow or YouTube.                 |
| 4 | <b>Music.</b> Play music located on discs, USB devices, or your PC.                            |
| 5 | <b>Settings.</b> Set various functions to suit your personal preferences.                      |
| 6 | Displays the colored buttons on your remote that you can press to access or perform functions. |

- Selecting an Option on the Home Screen

| 20 English

1. To select an option on the Home screen, move the cursor using the ◀▶ buttons until it highlights the option of your choice, and then press the [Enter] button.

## | NOTE |

- ▶ To play or view video, music, or photo files located on your PC, you must connect your home theater and PC to a home network and you must download, install, and configure the AllShare software on your PC. (See page 27.)

## Accessing the Settings Screen

1. Select **Settings** on the Home screen, and then press [Enter]. The Settings screen appears.

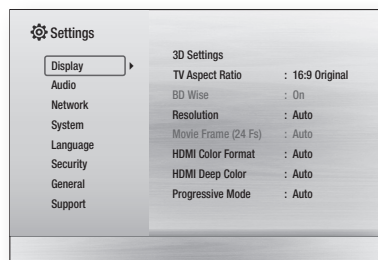

2. To access the menus, sub-menus, and options on the Settings screen, please refer to the remote control illustration below.

## | NOTE |

- ▶ If you leave the product in the stop mode for more than 5 minutes without using it, a screen saver will appear on your TV. If the product is left in the screen saver mode for more than 20 minutes, the power will automatically turn off.

## Buttons on the Remote Control Used for the Settings Menu

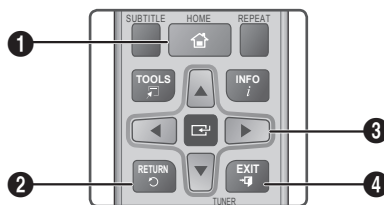

- |   |                                                         |
|---|---------------------------------------------------------|
| 1 | <b>HOME</b> Button : Press to move to the Home screen.  |
| 2 | <b>RETURN</b> (↶) Button : Return to the previous menu. |

<b>3</b>	<p> (Enter) / <b>DIRECTION</b> Button :</p> <ul style="list-style-type: none"> <li>• Press <b>▲▼◀▶</b> to move the cursor or select an item.</li> <li>• Press the  button to activate the currently selected item or confirm a setting.</li> </ul>
<b>4</b>	<p><b>EXIT</b> Button : Press to exit the current menu.</p>

## | NOTE |

- ▶ The  button on the product's front panel can be used for same purpose as the  button on the remote control.

**Detailed Function Information**

Each Settings function, menu item, and individual option is explained in detail on-screen. To view an explanation, use the **▲▼◀▶** buttons to select the function, menu item, or option.

The explanation will usually appear the bottom of the screen. A short description of each Settings function starts on this page. Additional informaton on some of the functions is also in the Appendix of this manual.

**Settings Menu Functions**

<b>Display</b>	<b>3D Settings</b>	<p>Set up the 3D related functions.</p> <ul style="list-style-type: none"> <li>✓ <b>3D Blu-ray Playback Mode:</b> Select whether to play a Blu-ray Disc with 3D contents in 3D Mode. If you move to the Home or Smart Hub Home menu while in 3D mode, the product will switch to 2D automatically.</li> <li>✓ <b>Screen Size:</b> Enter the size of the TV attached to the product. The product will automatically adjust the 3D output to the screen size of the TV.</li> </ul>
	<b>TV Aspect Ratio</b>	Lets you adjust the output of the product to the screen size of your TV. See page 19, Step 4 for a description of the screen size options.
	<b>BD Wise</b>	BD Wise is Samsung's latest inter-connectivity feature. When you connect a Samsung product and a Samsung TV with BD Wise to each other via HDMI, and BD Wise is on in both the product and TV, the product outputs video at the video resolution and frame rate of the Blu-ray/DVD Disc.
	<b>Resolution</b>	Lets you set the output resolution of the HDMI video signal to <b>Auto, 1080p, 1080i, 720p, 576p/480p</b> . If Composite is connected, the resolution supports only <b>576i/480i</b> . The number indicates the number of lines of video per frame. The i and p indicate interlaced and progressive scan, respectively. The more lines, the higher quality.
	<b>Movie Frame (24 Fs)</b>	<p>Setting the Movie Frame (24 Fs) feature to Auto lets the product adjust its HDMI output to 24 frames per second automatically for improved picture quality if attached to a 24Fs compatible TV.</p> <ul style="list-style-type: none"> <li>• You can enjoy the Movie Frame (24 Fs) feature only on a TV supporting this frame rate.</li> <li>• Movie Frame is only available when the product is in the HDMI 1080i or 1080p output resolution modes.</li> </ul>

# Settings

	<b>HDMI Color Format</b>	Lets you set the color space format for the HDMI output to match the capabilities of the connected device (TV, monitor, etc).
	<b>HDMI Deep Color</b>	Lets you set the product to output video from the HDMI OUT jack with Deep Color. Deep Color provides more accurate color reproduction with greater color depth.
	<b>Progressive Mode</b>	Lets you improve picture quality when viewing DVDs.
<b>Audio</b>	<b>Speaker Setting</b>	You can set the speaker options.
	<b>Speaker Selection</b>	Lets you select which speakers you want active, either the TV's speakers or the Home theatre's speakers.
	<b>Audio Return Channel</b>	<p>Lets you direct the sound from the TV to the Home Theater speakers. Requires an HDMI connection and an Audio Return Channel (ARC) compatible TV.</p> <ul style="list-style-type: none"> <li>When Audio Return Channel is set to Auto, the home theater automatically selects either ARC or optical input as the audio source, depending on your connections. If Audio Return Channel is active, optical input does not work.</li> </ul>
	<b>Digital Output</b>	Lets you set the Digital Output to match the capabilities of the AV receiver you've connected to the product. For more details, please refer to the digital output selection table. (See page 40)
	<b>Dynamic Range Control</b>	<p>Lets you apply dynamic range control to Dolby Digital, Dolby Digital Plus, and Dolby True HD audio.</p> <p>✓ <b>Auto:</b> Automatically controls the dynamic range of Dolby TrueHD audio, based on information in the Dolby TrueHD soundtrack. Also turns dynamic range control on for Dolby Digital and Dolby Digital Plus.</p> <p>✓ <b>Off:</b> Leaves the dynamic range uncompressed, letting you hear the original sound.</p> <p>✓ <b>On:</b> Turns dynamic range control on for all three Dolby formats. Quieter sounds are made louder and the volume of loud sounds is reduced.</p>
	<b>Audio Sync</b>	When the product is attached to a digital TV, lets you adjust the audio delay so that the audio syncs with the video. You can set the delay between 0 and 300 milliseconds.

<b>Network</b>	<b>Wired Network Settings</b>	For more information about Network Settings and network functions, see "Networks and the Internet" starting on page 24.
	<b>Network Test</b>	Lets you test the Internet Protocol setup to see if it is working correctly.
	<b>Network Status</b>	Lets you check whether a connection to the network and the Internet have been established.
	<b>BD-Live Internet Connection</b>	Lets you allow or prohibit an Internet connection for the BD-Live service.
<b>System</b>	<b>Initial Settings</b>	Lets you re-run the Initial Settings procedure. See page 19 for details.
	<b>Anynet+ (HDMI-CEC)</b>	Anynet+ is a convenient function that offers linked operations with other Samsung products that have the Anynet+ feature and lets you control those products with one Samsung TV remote. To operate this function, you must connect this product to an Anynet+ Samsung TV using an HDMI cable.
	<b>BD Data Management</b>	Lets you manage the contents you downloaded through a Blu-ray disc that supports the BD-Live service. You can view the information about the USB device you are using for BD Live data storage including the storage space. You can also delete BD Live data and change the device.
	<b>DivX® Video On Demand</b>	View DivX® VOD Registration Codes to purchase and play DivX® VOD contents.
<b>Language</b>	You can select the language you prefer for the On-Screen Menu, disc menu, etc. <ul style="list-style-type: none"> <li>The selected language will only appear if it is supported on the disc.</li> </ul>	
<b>Security</b>	The default PIN is 0000. Enter the default PIN to access the security function if you haven't created your own PIN.	
	<b>BD Parental Rating</b>	Prevents playback of Blu-ray Discs with a rating equal to or above a specific age ratings unless the PIN is entered.
	<b>DVD Parental Rating</b>	Prevents playback of DVDs with a rating above a specific numerical ratings unless the PIN is entered.
	<b>YouTube Lock</b>	If the lock set to On, you must enter the PIN to use the service.
	<b>Change PIN</b>	Change the 4-digit PIN used to access security functions.
<b>General</b>	<b>Time Zone</b>	You can specify the time zone that is applicable to your area.

# Settings

<b>Support</b>	<b>Software Upgrade</b>	For more information about the Software Update function, see "Upgrading Software" on page 26.
	<b>Contact Samsung</b>	Provides contact information for assistance with your product.
	<b>Terms of Service Agreement</b>	View the general disclaimer regarding third party contents and services.
	<b>Reset</b>	All settings will revert to the default except for the network settings. The default security password is 0000.

## Networks and the Internet

When you connect this product to a network, you can use network based applications and functions such as BD-LIVE and upgrade the product's software through the network connection.

### Configuring Your Network Connection

Before you begin, contact your ISP to find out if your IP address is static or dynamic. If it is dynamic, we recommend you use the Automatic procedure below. If it is static, you must use the Manual procedure that follows.

- Before you begin, confirm that the product is connected to your router with a network cable.

#### □ Automatic

To start the configuration process, follow these steps:

1. In the Home menu, select **Settings**, and then press the **[Enter]** button.
2. Select **Network**, and then press the **[Enter]** button.
3. Select **Wired Network Settings**, and then press the **[Enter]** button.  
The Wired Network Settings screen appears.
4. Press the **[Right]** button on the Internet Protocol Setup menu.  
Use **[Up]**/**[Down]** button to select **Auto** and then press the **[Enter]** button.

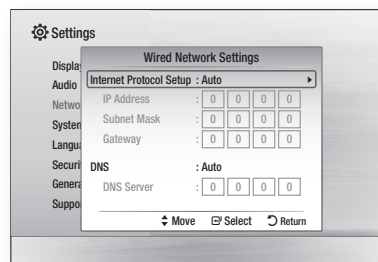

5. The Network function acquires and fills in the values for IP Address, Subnet Mask, etc., automatically.
6. After the Network function has acquired the network values, press the **RETURN (↵)** button.
7. Select Network Test, and then press **[Enter]**.  
The home theater validates the network connection. When it is done, press the **RETURN (↵)** button.



## □ Manual

If you have a static IP address or the Automatic procedure does not work, you'll need to set the Network Settings values manually.

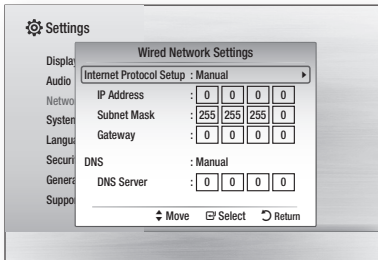

1. Follow the first four steps in the Automatic procedure, but select **Manual** instead of Auto in Step 4.
2. Press the ▼ arrow button to go to the first entry field (IP Address).
3. Use the number buttons on your remote to enter numbers.
4. When done with each field, use the ► button to move successively to the next field. You can also use the other arrow buttons to move up, down, and back.
5. Enter the **IP Address**, **Subnet Mask**, and **Gateway** values.
6. Press the ▼ button to go to **DNS**.
7. Press the ▼ button to go to the first DNS entry field. Enter the numbers as above.
8. Press the **RETURN** (↵) button on your remote.
9. Select **Network Status**, and then press **OK**.
10. The Network Status screen appears. The product verifies the network connection and then connects to the network. When it is done, highlight **OK**, and then press **OK**.

### | NOTE |

- ▶ You can get the Network values from your Internet provider. You can also view these values on most Windows computers. For instructions, see "Getting the Network Setting Values" on this page.

## < Getting the Network Settings Values >

You can view your Network Settings values on most Windows computers. To view the Network Settings values, follow these steps:

- Windows XP
  1. Right click the Network icon on the bottom right of the Windows desktop.
  2. In the pop-up menu, click Status.
  3. On the dialog that appears, click the Support tab.
  4. On the Support tab, click the Details button. The Network settings are displayed.

- Windows 7

1. Click the Network icon on the bottom right of the Windows desktop.
2. In the pop-up menu, click Network and Sharing Center.
3. On the dialog that appears, click the Local Area Connection.
4. On the Support tab, click the Details button. The Network settings are displayed.

### | NOTE |





- ▶ Depending on your Windows version, the information may differ.

# Settings

## Upgrading Software

The Software Upgrade menu allows you to upgrade the product's software for performance improvements or additional services.

- Never turn the product off or back on manually during the update process.

- 1 · In the Home menu, select **Settings**, and then press the  button.
- 2 · Select **Support**, and then press the  button.
- 3 · Select **Software Upgrade**, and then press the  button.
- 4 · Select one of the following methods:
  - **By Online**
  - **By USB**
  - **Auto Upgrade Notification**
- 5 · Press the  button.  
Directions for each method begin below.

### | NOTE |

- ▶ The update is complete when the product turns off after restarting. Press the **POWER** button to turn on the updated product for your use. Never turn the product on or off manually during the update process.
- ▶ Samsung Electronics takes no legal responsibility for product malfunction caused by an unstable Internet connection or consumer negligence during a Software Update.
- ▶ If you want to cancel the upgrade while the upgrade software is downloading, press the  button.

## By Online

Your product must be connected to the Internet to use the By Online function. Remove all discs before you begin.

- 1 · Select **By Online**, and then press the  button. The Connecting to Server message appears.
- 2 · If an update is available, a popup message appears asking if you want to upgrade. If you select Yes, the product turns off automatically, turns on, and then begins the upgrade.

### | IMPORTANT |

- ▶ Never turn the home theater on or off manually during a software upgrade.

## | 26 English

- 3 · The update progress popup appears. When the update is completed, the product turns off automatically again.
- 4 · Press the **POWER** button to turn on the product.

### | NOTE |

- ▶ The update is complete when the product turns off after restarting. Press the **POWER** button to turn on the updated product for your use.
- ▶ Never turn the product off or on manually during the update process.
- ▶ Samsung Electronics takes no legal responsibility for a product malfunction caused by an unstable internet connection or consumer negligence during software upgrade.

## By USB

- 1 · Visit [www.samsung.com](http://www.samsung.com).
- 2 · Click **SUPPORT** on the top right of the page.
- 3 · Enter the product's model number into the search field, and then click **Find Product**.
- 4 · Click **Get downloads** in the center of the page below the Downloads header.
- 5 · Click **Firmware** in the center of the page.
- 6 · Click the **ZIP** icon in the File column on the right side of the page.
- 7 · Click **OK** in the pop-up that appears to download and save the firmware file to your PC.
- 8 · Unzip the zip archive to your computer. You should have a single folder with the same name as the zip file.
- 9 · Copy the folder to a USB flash drive.
- 10 · Make sure no disc is inserted in the product, and then insert the USB flash drive into the USB port of the product.
- 11 · In the product's menu, go to **Settings > Support > Software Upgrade**.
- 12 · Select **By USB**.

### | NOTE |

- ▶ There should be no disc in the product when you upgrade the software using the USB Host jack.
- ▶ Never turn the product off or on manually during the update process.
- ▶ When the Software Update is done, check the software details in the **Software Upgrade** menu.

## Auto Upgrade Notification

If your product is connected to the network and you set Auto Upgrade Notification on, the product will notify you if a new software version is available with a pop-up message.

- 1 · Turn on the product.
- 2 · In the Software Update menu, set **Auto Upgrade Notification** to **On**.  
If there is a new software version available, the product will notify you with a pop-up message.
- 3 · To upgrade the firmware, select **Yes**. The product turns off automatically, turns on, and then begins the upgrade.
- 4 · The update progress popup will appear. When the update is complete, the product will turn off automatically again.
- 5 · Press the **POWER** button to turn on the product.

### | NOTE |

- ▶ The update is complete when the product turns off after restarting. Press the **POWER** button to turn on the updated product for your use. Never turn the product on or off manually during the update process.
- ▶ Samsung Electronics shall take no legal responsibility for product malfunction caused by unstable of internet connection or consumer negligence during Software Update.

## Setting Up AllShare

AllShare enables you to play music, video and photo files in your PC using the product. To use AllShare, you must connect the product to your PC via the network (See page 18) and install the SAMSUNG PC Share Manager on the PC.

### To Download the AllShare Software

To use AllShare with your PC, you must install AllShare software on your PC. You can download the PC software and get detailed instructions for using AllShare from the Samsung.com website.

- 1 · Go to [www.samsung.com](http://www.samsung.com).
- 2 · Click **SUPPORT** at the top of the page.
- 3 · On the Support page, enter the model number of your player into the **Model Number** field, and then press the  button.
- 4 · On the page that appears, click **Get downloads** on the left side under **Downloads**. The **Download Center** appears.
- 5 · On the **Download Center** page, click the **Software** tab.
- 6 · On the software tab, click the **File icon** on the right side of the AllShare line.
- 7 · In the pop-up that appears, click **Save File**.
- 8 · Find the AllShare install file on your disk, and then double click the file.
- 9 · In the pop-up that appears, click **Run**, and then follow the directions that appear on your screen.

Download the AllShare Installation/Instruction manual from the same Software Tab by clicking the corresponding PDF file symbol in the File column on the right. The file, in PDF format, will download and open. Follow the directions to install and setup AllShare. You can view and/or save the file.

### | NOTE |

- ▶ To use allshare with your smartphone, you need to connect your set & smartphone to the same router.

# Media Play

## Using the Streaming Media Services

- To use the Streaming Media Services, your home theater must be connected to the Internet. You also may need a vendor account for some services.

Use the ▲▼◀▶ buttons in the Home menu to move to the desired service, and then press the  button.





**YouTube.** You can view video streamed by YouTube.

## Playing Files on a USB Device

You can play multimedia files located on a connected USB device.

- 1 · Move to the Home menu.
- 2 · In Stop mode, connect the USB storage device to the USB port on the front panel of the product. The message “**Do you want to access the device?**” will be displayed.
- 3 · Press the ◀▶ button to select **Yes**, then press the  button.
- 4 · Press the **RED (A)** button.







- 5 · Press the ▲▼ buttons to select the USB Flash Mem or Disk then press the  button.
- 6 · Press the ◀▶ buttons to select **Videos**, **Music** or **Photos**, then press the  button.
- 7 · If files appear on the screen go to Step 8. If file folders appear on the screen, use the ▲▼ buttons to select a folder, press , and then go to Step 8.

- 8 · Use the ▲▼ buttons to select a file to play or view, and then press the  button.

OR

- 4<sup>-1</sup> · Press the **BLUE (D)** button.



- 5<sup>-1</sup> · Press the ◀▶ buttons to select the **USB** Flash Mem or Disk then press the  button.
- 6<sup>-1</sup> · Press the ▲▼ buttons to select **Videos**, **Music** or **Photos**, then press the  button.
- 7<sup>-1</sup> · If files appear on the screen go to Step 8<sup>-1</sup>. If file folders appear on the screen, use the ▲▼ buttons to select a folder, press , and then go to Step 8<sup>-1</sup>.
- 8<sup>-1</sup> · Use the ▲▼ buttons to select a file to play or view, and then press the  button.

| NOTE |

- ▶ To prevent possible damage to the USB memory, you must remove the USB storage device safely using the “**Safely Remove USB**” function. Press the **HOME** button to move to the Home menu, select the **YELLOW (C)** button, and then press the  button.
- ▶ To listen to your music files with 5.1 channel sound, you must set the Dolby Pro Logic II mode to **MATRIX**. (See page 34)

## Playing a Disc with User Recorded Content

You can play multimedia files you have recorded on DVD or CD discs.

- 1 · Turn on the home theater.
- 2 · Open the disc tray, place a user recorded disc into the disc tray with the disc's label facing up, and then close the tray.
- 3 · After the disc loads, press the **RED (A)** button.
- 4 · Press the **▲▼** buttons to select CD or DVD, and then press the **⏮** button.
- 5 · Press the **◀▶** buttons to select **Videos**, **Music**, or **Photos**, then press the **⏮** button.
- 6 · If files appear on the screen, go to Step 7. If file folders appear on the screen, use the **▲▼** **◀▶** buttons to select a folder, press **⏮**, and then go to Step 7.
- 7 · Use the **▲▼** **◀▶** buttons to select a file to play or view, and then press the **⏮** button.

### OR

- 3<sup>-1</sup>. After the disc loads, press the **BLUE (D)** button.
- 4<sup>-1</sup>. Press the **◀▶** buttons to select **CD** or **DVD**, and then press the **⏮** button.
- 5<sup>-1</sup>. Press the **▲▼** buttons to select **Videos**, **Music** or **Photos**, and then press the **⏮** button.
- 6<sup>-1</sup>. If files appear on the screen go to Step 7<sup>-1</sup>. If file folders appear on the screen, use the **▲▼** **▲▼** buttons to select a folder, press **⏮**, and then go to Step 7<sup>-1</sup>.
- 7<sup>-1</sup>. Use the **▲▼** **▲▼** buttons to select a file to play or view, and then press the **⏮** button.

## Playing a Commercial Video Disc

Place a disc into the disc tray with the disc's label facing up and then close the disc tray. Playback starts automatically. If it does not playback automatically, move to **Videos** in the Home menu and press the **⏮** button.

In most cases, commercial videos will display a disc menu. To play the movie on the disc, select **Play** on the disc menu, and then press **⏮**.

### | NOTE |

- ▶ For more information about playing videos, go to "Controlling Video Playback" on page 30.

## Playing a Pre-Recorded Commercial Audio Disc

- 1 · Insert an Audio CD (CD-DA) or an MP3 Disc into the disc tray.
  - For an Audio CD (CD-DA), the first track will be played automatically. Tracks on a disc are played in the order in which they were recorded on the disc.
  - For an MP3 disc, press the **◀▶** buttons to select **Music**, then press the **⏮** button.

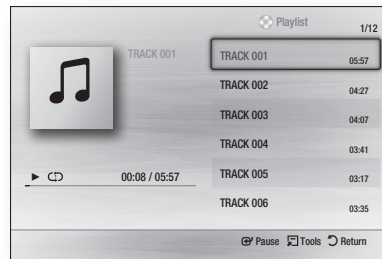

- 2 · To play a particular track, use the **▲▼** buttons on the remote to select the track, and then press the **⏮** button.

### | NOTE |

- ▶ For more information about playing music, go to "Controlling Music Playback" on page 32.

# Media Play

## Controlling Video Playback

You can control the playback of video files located on Blu-ray, DVD, and CD discs, and on USB storage devices. Depending on the media, some of the functions described in this manual may not be available.

### Buttons on the Remote Control used for Video Playback

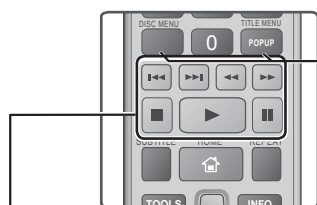

#### Using the disc menu, title menu, popup menu and title list

#### Playback related buttons

The product does not play sound in Search, Slow, or Step mode.

	Starts playback.
	Stops playback.
	Pauses playback.
<b>Fast Motion Play</b>	During playback, press the  or  button. Each time you press the  or  button, the playback speed will change.
<b>Slow Motion Play</b>	In pause mode, press the  button. Each time you press the  button, the playback speed will change.
<b>Step Motion Play</b>	In pause mode, press the  button. Each time you press the  button, a new frame appears.
<b>Skip Motion Play</b>	During playback, press the  or  button. Each time you press  or  button, the disc moves to the previous or next chapter or file.

<b>DISC MENU</b>	During playback, press this button to display the Disc menu.
<b>TITLE MENU</b>	During playback, press this button to display the Title menu. <ul style="list-style-type: none"> <li>If your disc has a playlist, press the <b>GREEN (B)</b> button to go to the playlist.</li> </ul>
<b>POPUP MENU</b>	During playback, press this button to display the Pop-up menu.
<b>DISC MENU or TITLE MENU</b>	During playback, press this button to display the title list.

## Using the TOOLS Menu

During playback, press the **TOOLS** button.

<b>Title</b>	If the movie or video have more than one title, move to or select a desired title.
<b>Playing Time</b>	Select to move to the specific playback point. Use the numeric buttons to input the playback point.
<b>Full Screen</b>	Select to set the desired full screen size. You can select Original, Mode1 (larger), and Mode2 (largest).
<b>Picture Setting</b>	Select to set the picture mode. <ul style="list-style-type: none"> <li>- <b>Picture Mode</b> <ul style="list-style-type: none"> <li>▪ <b>Normal</b> : Choose this setting for most viewing applications.</li> <li>▪ <b>Movie</b> : This is the best setting for watching movies.</li> <li>▪ <b>User</b> : Lets you adjust the sharpness and noise reduction function respectively.</li> <li>▪ <b>Dynamic</b> : Choose this setting to increase Sharpness.</li> </ul> </li> </ul>

## Menu that appears only when a BD/DVD disc plays

<b>Chapter</b>	Select to move to a chapter that you desire to watch.
<b>Repeat</b>	Select to repeat a specific title, chapter (BD/DVD discs only) or marked section.
<b>Audio</b>	Select to set the desired audio language. <ul style="list-style-type: none"> <li>- You can also operate this function by pressing the <b>AUDIO</b> button on the remote control.</li> </ul>
<b>Subtitle</b>	Select to set the desired subtitle language. <ul style="list-style-type: none"> <li>- You can also operate this function by pressing the <b>SUBTITLE</b> button on the remote control.</li> </ul>
<b>Angle</b>	To view a scene from another angle. The Angle option displays the number of angles available to view (1/1, 1/2, 1/3, etc.).
<b>BONUSVIEW Video / BONUSVIEW Audio (BD discs only)</b>	Select to set the desired bonusview option.

### | NOTE |

- ▶ Depending on the disc or storage device, the Tools menu may differ. All options may not be displayed.

## Creating a Video Playlist

You can create a playlist of video files in a way that is nearly identical to the way you create a playlist of music files. For instructions, see "Creating a Music Playlist" on page 32.

# Media Play

## Controlling Music Playback

You can control the playback of music content located on DVDs, CDs, and USB storage devices.

### Buttons on the Remote Control used for Music Playback

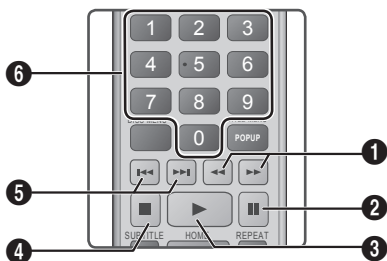

<b>1</b>	<b>Fast Play (Audio CD (CD-DA) only)</b> During playback, press the <b>◀▶</b> or <b>▶▶</b> button. Each time you press the <b>◀▶</b> or <b>▶▶</b> button, the playback speed will change.
<b>2</b>	<b>⏸</b> button : Pause a track.
<b>3</b>	<b>▶</b> button : Plays the currently selected track.
<b>4</b>	<b>⏹</b> button : Stops a track.
<b>5</b>	<b>Skip</b> : During playback, press the <b>◀▶</b> or <b>▶▶</b> button to move to the previous or next music of listed.
<b>6</b>	<b>NUMBER</b> buttons : During Playlist playback, press the desired track number. The selected track is played.

## Repeating Tracks

You can set the product to repeat tracks.

- During the music playback, press the **TOOLS** button.
- Use **◀▶** button to select **Off**, **Track** or **One**, **All** or **Shuffle** in **Repeat Mode**, and then press the **⏹** button.

## Creating a Music Playlist

- If playing music from a commercial CD or DVD, press the **⏹** or **RETURN (↵)** button. The Music List Screen appears. If you are creating a playlist from music on a user created disk or USB device, access the Music list as described in "Playing Files on a USB Device" on page 28 or "Playing a Disc with User Recorded Content" on page 29.
- Press the **▲▼◀▶** buttons to move to the desired file, and then press the **YELLOW (C)** button to select it. Repeat this procedure to select additional files.



- To remove a file from the Playlist, move to the file, and then press the **YELLOW(C)** Button.
- Press the **⏹** button to play the selected files. The Playlist screen appears.
- To go to the Music List, press the **⏹** or **RETURN (↵)** button.
- To go back to the Playlist, press the **⏹** button.

### | NOTE |

- You can create a playlist with up to 99 tracks on Audio CDs (CD-DA).
- If you go to the Music List from the Playlist, and then return to the Playlist, the Playlist will start playing again from the beginning.



## Controlling Photo Playback

You can control the playback of photos located on DVDs, CDs, and USB storage devices.

### Using the Tools Menu

During playback, press the **TOOLS** button.

<b>Start Slide Show</b>	Select to start a slide show.
<b>Slide Show Speed</b>	Select to adjust the slide show speed.
<b>Background Music</b>	Select to listen to music while viewing a slide show.
<b>Zoom</b>	Select to enlarge the current picture. (Enlarge up to 4 times)
<b>Rotate</b>	Select to rotate a picture. (This will rotate the picture either clockwise or counter clockwise.)
<b>Information</b>	Shows the picture information including the name and size, etc.

#### | NOTE |

- ▶ Depending on the disc or storage device, the Tools menu may differ. All options may not be displayed.
- ▶ To enable the background music function, the photo file must be in the same storage media as the music file. However, the sound quality can be affected by the bitrate of the MP3 file, the size of the photo, and the encoding method.

### Creating a Photo Playlist

You can create a playlist of photos in a way that is nearly identical to the way you create a playlist of music files. For instructions, see "Creating a Music Playlist" on page 32.

## Listening to Radio

### Using Buttons on the Remote Control

- 1 · Press the **FUNCTION** button to select **FM**.
- 2 · Tune in to the desired station.
  - Preset Tuning 1 : Press the **□** button to select **PRESET** and then press the **TUNING (UP, DOWN)** button to select the preset station.
    - Before you can tune to preset stations, you must add preset stations to the product's memory.
  - Manual Tuning : Press the **□** button to select **MANUAL** and then press the **TUNING (UP, DOWN)** button to tune in to a lower or higher frequency.
  - Automatic Tuning : Press the **□** button to select **MANUAL** and then press and hold the **TUNING (UP, DOWN)** button to automatically search the band.

### Setting Mono/Stereo

Press the **MO/ST** button.

- Each time the button is pressed, the sound switches between **STEREO** and **MONO**.
- In a poor reception area, select **MONO** for a clear, interference-free broadcast.

### Presetting Stations

Example : Presetting FM 89.10 into memory.

- 1 · Press the **FUNCTION** button to select **FM**.
- 2 · Press the **TUNING (UP, DOWN)** button to select <89.10>.
- 3 · Press the **TUNER MEMORY** button.
  - NUMBER flashes on the display.
- 4 · Press the **TUNER MEMORY** button again.
  - Press the **TUNER MEMORY** button before NUMBER disappears from the display on its own.
  - After you press the **TUNER MEMORY** button, NUMBER disappears from the display and the station is stored in memory.
- 5 · To preset another station, repeat steps 2 to 4.
  - To tune in to a preset station, press the **TUNING (UP, DOWN)** button.

# Media Play

## Using the Special Effects Remote Control Buttons



Lets you select a mode that optimizes the sound.

### MP3 ENHANCER → SMART VOLUME → POWER BASS → OFF

- **MP3 ENHANCER** : Helps enhance your sound experience (ex. mp3 music). You can upscale your MP3 level sound (24 kHz, 8bit) to CD level sound (44.1 kHz, 16bit).
- **SMART VOLUME** : Regulates and stabilizes the volume level, preventing drastic volume changes when you change channels or during scene transitions.
- **POWER BASS** : Increases the volume level of bass tones and provides thudding sound effects.
- **OFF** : Select this for normal listening.







You can select the desired Dolby Pro Logic II audio mode.

- **MOVIE** : Adds realism to a movie soundtrack.
- **MUSIC** : When listening to music, you can experience sound effects as if you are listening to the actual performance.
- **MATRIX** : Select to hear multi channel surround sound.
- **PROLOG** : Select to listen to a 2CH sound source in 5.1CH surround sound with all speakers active.
  - A specific speaker(s) may not output depending on the input signal.

## Using BD-LIVE™

- 1 • Connect the product to the network.  
(See page 18)
- 2 • Configure the network settings.  
(See pages 24~25)

Once the product is connected to your network, you can enjoy various movie-related service contents available on BD-LIVE compliant discs.

- 1 • Attach a USB memory stick to the USB jack on the front of the product, and then use BD Data Management to check its remaining memory. The memory device must have at least 1GB of free space to accommodate the BD-LIVE services.
- 2 • Select **Settings** on the Home screen, and then press the  button.
- 3 • Select **System**, and then press the  button.
- 4 • Select **BD Data management**, and then press the  button.
- 5 • Select **Change Device**, and then press the  button.
- 6 • Select **USB DISK**, and then press the  button.
- 7 • Insert a Blu-ray Disc that supports BD-LIVE.
- 8 • Select an item from the list of BD-LIVE service contents provided by the disc manufacturer.

### | NOTE |



- ▶ The way you use BD-LIVE and the provided contents may differ, depending on the disc manufacturer.

## Using AllShare

AllShare lets you access and play files located on your PC through your home theater.

Follow the directions in the AllShare user's guide to setup AllShare on your PC and to tag folders and files you want to share with the home theater.

To access and play files located on your PC after you have setup AllShare, follow these steps:

- 1 · Turn on your PC, your TV, and the home theater.
- 2 · Make sure the AllShare Shared server is running on your PC.
- 3 · On your home theater, press the **BLUE (D)** button (View Devices).
- 4 · Use the left or right arrow button to select your PC in the Device List.
- 5 · Select the kind of file you want to view or play, Videos, Photos, or Music, and then press .
- 6 · Use the ◀▶ button to select the folder with the kind of files you selected, and then press . The File List is displayed.
- 7 · Select the file you want to view or play, and then press .

### | NOTE |

- ▶ You can create Playlists from files on your PC in the same way you create playlists from files on USB devices and discs.
- ▶ With a few exceptions, you can control the playback of files on your PC in the same fashion you control the playback of files on USB devices and discs.
- ▶ You can also access files on you PC by first selecting Videos, Photos, or Music on the Home screen, and then selecting your PC from the device list that appears.

# Appendix

## Additional Information

### Note

<b>Connections</b>	<b>HDMI OUT</b>
	<ul style="list-style-type: none"> <li>• Certain HDMI output resolutions may not work, depending on your TV.</li> <li>• You must have an HDMI connection to enjoy videos with 3D technology.</li> <li>• A long HDMI cable may cause screen noise. If this occurs, set <b>HDMI Deep Color</b> to <b>Off</b> in the menu.</li> </ul>
<b>Settings</b>	<b>3D Settings</b>
	<ul style="list-style-type: none"> <li>• For some 3D discs, to stop a movie during 3D playback, press the <b>[ ]</b> button once. The movie stops and the 3D mode option is de-activated. To change a 3D option selection when you are playing a 3D movie, press the <b>[ ]</b> button once. The Blu-ray menu appears. Press the <b>[ ]</b> button again, then select 3D Settings in the Blu-ray menu.</li> <li>• Depending on the content and the position of the picture on your TV screen, you may see vertical black bars on the left side, right side, or both sides.</li> </ul>
	<b>TV Aspect</b>
	<ul style="list-style-type: none"> <li>• Depending on the disc type, some aspect ratios may not be available.</li> <li>• If you select an aspect ratio and option which is different than the aspect ratio of your TV screen, then the picture might appear to be distorted.</li> <li>• If you select the <b>16:9 Original</b>, your TV may display <b>4:3 Pillarbox</b> (black bars on sides of picture).</li> </ul>
	<b>BD Wise (Samsung Products only)</b>
	<ul style="list-style-type: none"> <li>• When BD Wise is on, the Resolution setting automatically defaults to BD Wise and BD Wise appears in the Resolution menu.</li> <li>• If the product is connected to a device that does not support BD Wise, you can not use the BD Wise function.</li> <li>• For proper operation of BD Wise, set the BD Wise option in both the product and the TV to On.</li> </ul>
	<b>Digital Output</b>
<ul style="list-style-type: none"> <li>• Be sure to select the correct Digital Output or you will hear no sound or just loud noise.</li> <li>• If the HDMI device (AV receiver, TV) is not compatible with compressed formats (Dolby digital, DTS), the audio signal outputs as PCM.</li> <li>• Regular DVDs do not have BONUSVIEW audio and Navigation Sound Effects.</li> <li>• Some Blu-ray Discs do not have BONUSVIEW audio and Navigation Sound Effects.</li> <li>• This Digital Output setup does not affect the analog (L/R) audio or HDMI audio output to your TV. It affects the optical and HDMI audio output when your product is connected to an AV receiver.</li> <li>• If you play MPEG audio soundtracks, the audio signal outputs as PCM regardless of your Digital Output selections (PCM or Bitstream).</li> </ul>	
<b>BD-LIVE Internet Connection</b>	
<ul style="list-style-type: none"> <li>• The Internet connection may be restricted while you are using BD-LIVE contents.</li> </ul>	

Settings	Anynet+(HDMI-CEC)
	<ul style="list-style-type: none"> <li>Depending on your TV, certain HDMI output resolutions may not work. Please refer to the user manual of your TV.</li> <li>This function is not available if the HDMI cable does not support CEC.</li> <li>If your Samsung TV has an Anynet+ logo, then it supports the Anynet+ function.</li> </ul>
	BD Data Management
	<ul style="list-style-type: none"> <li>In the external memory mode, disc playback may be stopped if you disconnect the USB device in the middle of playback.</li> <li>Only those USB devices formatted in the FAT file system (DOS 8.3 volume label) are supported. We recommend you use USB devices that support USB 2.0 protocol with 4 MB/sec or faster read/write speed.</li> <li>The Resume Play function may not work after you format the storage device.</li> <li>The total memory available to BD Data Management may differ, depending on the conditions.</li> </ul>
	Speaker Settings
	<ul style="list-style-type: none"> <li>When <b>Speaker Selection</b> is set to <b>TV Speaker</b>, audio is produced through the TV speakers.</li> </ul>
	HDMI audio
	<ul style="list-style-type: none"> <li>When HDMI audio is outputted to the TV speaker, it is automatically down-mixed to 2 channels.</li> </ul>
	Audio Return Channel
	<ul style="list-style-type: none"> <li>When Anynet+ (HDMI-CEC) is Off, the Audio Return Channel function is not available.</li> <li>Using an HDMI cable not certified for ARC (Audio Return Channel) may cause a compatibility problem.</li> <li>The ARC function is only available if an ARC-compliant TV is connected.</li> </ul>
Digital Output	
<ul style="list-style-type: none"> <li>Digital Output can be activated when <b>Speaker Selection</b> is selected to <b>TV Speaker</b>.</li> </ul>	
Playback	Playing a Video files
	<ul style="list-style-type: none"> <li>Video files with high bitrates of 20Mbps or more strain the product's capabilities and may stop playing during playback.</li> </ul>
	Selecting the Audio Language
<ul style="list-style-type: none"> <li>The ◀▶ indicator will not appear on the screen if the BONUSVIEW section does not contain any BONUSVIEW audio settings.</li> <li>The languages available through the Audio Language function depend on the languages that are encoded on the disc. This function or certain languages may not be available.</li> <li>Some Blu-ray Discs may allow you to select either the PCM or Dolby digital audio soundtrack in English.</li> </ul>	

# Appendix

<b>Playback</b>	<b>Selecting the Subtitle Language</b>
	<ul style="list-style-type: none"> <li>Depending on the Blu-ray Disc / DVD, you may be able to change the subtitle language in the Disc Menu. Press the <b>DISC MENU</b> button.</li> <li>This function depends on the selection of subtitles that are encoded on the disc and may not be available on all Blu-ray Discs/DVDs.</li> <li>Information about the main feature BONUSVIEW mode will also appear if the Blu-ray Disc has a BONUSVIEW section.</li> <li>This function changes both the primary and secondary subtitles at the same time.</li> <li>The total number of primary and secondary subtitles are displayed respectively.</li> </ul>
	<b>Playing a JPEG files</b>
	<ul style="list-style-type: none"> <li>You can't enlarge the subtitle and PG graphic in the full screen mode.</li> </ul>
<b>Allshare Play</b>	<b>Dolby Pro Logic II Mode</b>
	<ul style="list-style-type: none"> <li>Before selecting Dolby Pro Logic II mode, connect your external device to the AUDIO INPUT jacks (L and R) on the product. If you connect to only one of the inputs (L or R), you cannot listen to surround sound.</li> </ul>
	<b>Using the TOOLS button while playing pictures</b>
	<ul style="list-style-type: none"> <li>If the system is connected to a BD Wise compliant TV that has set BD Wise to On, the Picture Settings menu will not appear.</li> <li>The Background Music function will not work unless the music file and the photo file are located on the same storage media. Also, sound quality can be impacted by the bitrate of the MP3 music file, the size of the photos, and the encoding method.</li> </ul>
	<b>Playing back a USB Storage Device</b>
	<ul style="list-style-type: none"> <li>You must remove the USB storage device safely (by performing the "<b>Safely Remove USB</b>" function) to prevent possible damage to the USB memory. Press the <b>HOME</b> button to move to the Home menu, select the <b>YELLOW (C)</b> button, and then press the  button.</li> <li>If you insert a disc when playing a USB storage device, the Function mode is changed to "BD/DVD" automatically.</li> </ul>

## Resolution according to the output mode

### □ Blu-ray Disc/E-contents/Digital Contents playback

Setup \ Output	HDMI/connected			HDMI/not connected
	HDMI Mode		VIDEO Mode	VIDEO Mode
	Blu-ray Disc	E-contents/ Digital contents		
BD Wise	Resolution of Blu-ray Disc	1080p@60F	576i/480i	-
Auto	Max. Resolution of TV input	Max. Resolution of TV input	576i/480i	-
1080p@60F	1080p@60F	1080p@60F	576i/480i	-
Movie Frame : Auto (24Fs)	1080p@24F	1080p@24F	576i/480i	-
1080i	1080i	1080i	576i/480i	576i/480i
720p	720p	720p	576i/480i	576i/480i
576p/480p	576p/480p	576p/480p	576i/480i	576i/480i
576i/480i	-	-	-	576i/480i

### □ DVD playback

Setup \ Output	HDMI/connected		HDMI/not connected
	HDMI Mode	VIDEO Mode	VIDEO Mode
BD Wise	576i/480i	576i/480i	-
Auto	Max. Resolution of TV input	576i/480i	-
1080p@60F	1080p@60F	576i/480i	-
1080i	1080i	576i/480i	576i/480i
720p	720p	576i/480i	576i/480i
576p/480p	576p/480p	576i/480i	576i/480i
576i/480i	-	-	576i/480i

# Appendix

## Digital Output Selection

Setup		PCM	Bitstream (Unprocessed)	Bitstream (Re-encoded DTS)	Bitstream (Re-encoded Dolby D)
Connection		HDMI supported AV receiver	HDMI supported AV receiver	HDMI supported AV receiver	HDMI supported AV receiver
Audio Stream on Blu-ray Disc	PCM	Up to PCM 7.1ch	PCM	DTS re-encoded	Re-encoded Dolby Digital *
	Dolby Digital	Up to PCM 7.1ch	Dolby Digital	DTS re-encoded	Re-encoded Dolby Digital *
	Dolby Digital Plus	Up to PCM 7.1ch	Dolby Digital Plus	DTS re-encoded	Re-encoded Dolby Digital *
	Dolby TrueHD	Up to PCM 7.1ch	Dolby TrueHD	DTS re-encoded	Re-encoded Dolby Digital *
	DTS	Up to PCM 6.1ch	DTS	DTS re-encoded	Re-encoded Dolby Digital *
	DTS-HD High Resolution Audio	Up to PCM 7.1ch	DTS-HD High Resolution Audio	DTS re-encoded	Re-encoded Dolby Digital *
	DTS-HD Master Audio	Up to PCM 7.1ch	DTS-HD Master Audio	DTS re-encoded	Re-encoded Dolby Digital *
Audio Stream on DVD	PCM	PCM 2ch	PCM 2ch	PCM 2ch	PCM 2ch
	Dolby Digital	Up to PCM 5.1ch	Dolby Digital	Dolby Digital	Dolby Digital
	DTS	Up to PCM 6.1ch	DTS	DTS	DTS
Definition for Blu-ray Disc	Any	Decodes the main feature audio and BONUSVIEW audio stream together into PCM audio and adds Navigation Sound Effects.	Outputs only the main feature audio stream so that your AV receiver can decode the audio bitstream. You will not hear BONUSVIEW audio or Navigation Sound Effects.	Decodes the main feature audio and BONUSVIEW audio stream together into PCM audio and adds Navigation Sound Effects, then re-encodes the PCM audio into DTS bitstream.	Decodes the main feature audio and BONUSVIEW audio stream together into PCM audio and adds Navigation Sound Effects, then re-encodes the PCM audio into Dolby digital bitstream or PCM.

\* If the Source Stream is 2ch or mono, "Re-encoded Dolby D" Setting are not applied. Output will be PCM 2ch.

Blu-ray Discs may include three audio streams :

- Main Feature Audio : The audio soundtrack of the main feature.
- BONUSVIEW audio : An additional soundtrack such as the director or actor's commentary.
- Navigation Sound Effects: Sound effects that occur when you navigate the disc's or movie's menu. Navigation Sound Effects are different on each Blu-ray disc.



## Troubleshooting

Refer to the table below when this product does not function properly. If the problem you are experiencing is not listed below or if the instructions below do not help, turn off the product, disconnect the power cord and contact the nearest authorized dealer or Samsung Electronics Service Centre.

Symptom	Check/Remedy
I cannot eject the disc.	<ul style="list-style-type: none"> <li>• Is the power cord plugged securely into the outlet?</li> <li>• Turn off the power and then turn it back on.</li> </ul>
Playback does not start.	<ul style="list-style-type: none"> <li>• Check the region number of the Blu-ray/DVD disc. A Blu-ray/DVD disc purchased from abroad may not be playable.</li> <li>• CD-ROMs and DVD-ROMs cannot be played on this product.</li> <li>• Make sure that the rating level is correct.</li> </ul>
Playback does not start immediately when the Play/Pause button is pressed.	<ul style="list-style-type: none"> <li>• Are you using a deformed disc or a disc with scratches on the surface?</li> <li>• Wipe the disc clean.</li> </ul>
Sound is not produced.	<ul style="list-style-type: none"> <li>• The home theater does not play sound during fast playback, slow playback, and step motion playback.</li> <li>• Are the speakers connected properly? Is the speaker setup correctly customized?</li> <li>• Is the disc severely damaged?</li> </ul>
Sound can be heard only from a few speakers and not all 6.	<ul style="list-style-type: none"> <li>• On certain Blu-ray/DVD discs, sound is output from the front speakers only.</li> <li>• Check if the speakers are connected properly.</li> <li>• Adjust the volume.</li> <li>• When listening to a CD, radio or TV, sound is output to the front speakers only.</li> </ul>
Dolby Digital 5.1 CH Surround Sound is not produced.	<ul style="list-style-type: none"> <li>• Is there "Dolby Digital 5.1 CH" mark on the disc? Dolby Digital 5.1 CH Surround Sound is produced only if the disc is recorded with 5.1 channel sound.</li> <li>• Is the audio language correctly set to Dolby Digital 5.1-CH in the information display?</li> </ul>
The remote control does not work.	<ul style="list-style-type: none"> <li>• Are you operating the remote within its operational range and within the proper angle relative to the sensor?</li> <li>• Are the batteries drained?</li> </ul>
<ul style="list-style-type: none"> <li>• The disc is rotating but no picture is produced.</li> <li>• Picture quality is poor and picture is shaking.</li> </ul>	<ul style="list-style-type: none"> <li>• Is the TV power on?</li> <li>• Are the video cables connected properly?</li> <li>• Is the disc dirty or damaged?</li> <li>• A poorly manufactured disc may not be playable.</li> </ul>
Audio language and subtitles do not work.	<ul style="list-style-type: none"> <li>• Audio language and subtitles will not work if the disc does not contain them.</li> </ul>
The menu screen does not appear even when the menu function is selected.	<ul style="list-style-type: none"> <li>• Are you using a disc that does not contain menus?</li> </ul>

# Appendix

Symptom	Check/Remedy
The aspect ratio cannot be changed.	<ul style="list-style-type: none"> <li>You can play 16:9 Blu-ray/DVD discs in 16:9 Full mode, 4:3 Letter Box mode, or 4:3 Pan-Scan mode, but 4:3 Blu-ray/DVD discs are played in 4:3 ratio only. Refer to the Blu-ray Disc jacket and then select the appropriate function.</li> </ul>
<ul style="list-style-type: none"> <li>The product is not working.</li> </ul>	<ul style="list-style-type: none"> <li>Press and hold the remote control's <b>■</b> button for 5 seconds in NO DISC mode.               <ul style="list-style-type: none"> <li>Using the RESET function will erase all stored settings.</li> <li>Do not use this unless necessary.</li> </ul> </li> </ul>
You have forgotten the rating level password.	<ul style="list-style-type: none"> <li>With no disc in the product, press and hold the product's <b>■</b> button for longer than 5 seconds. <b>INIT</b> appears on the display and all settings will return to the default values. Then, press the <b>POWER</b> button.               <ul style="list-style-type: none"> <li>Using the RESET function will erase all stored settings.</li> <li>Do not use this unless necessary.</li> </ul> </li> </ul>
Can't receive radio broadcasts.	<ul style="list-style-type: none"> <li>Is the antenna connected properly?</li> <li>If the antenna's input signal is weak, install an external FM antenna in an area with good reception.</li> </ul>
While listening to TV audio through the Product, no sound is heard.	<ul style="list-style-type: none"> <li>If the <b>OPEN/CLOSE ▲</b> button is pressed while listening to TV audio using the D. IN or AUX functions, the Blu-ray/DVD disc functions are turned on and the TV audio is muted.</li> </ul>
"Not Available" appears on screen.	<ul style="list-style-type: none"> <li>The features or action cannot be completed at this time because:               <ol style="list-style-type: none"> <li>The Blu-ray/DVD disc's software restricts it.</li> <li>The Blu-ray/DVD disc's software doesn't support the feature (e.g., angles)</li> <li>The feature is not available at the moment.</li> <li>You've requested a title or chapter number or search time that is out of range.</li> </ol> </li> </ul>
If the HDMI output is set to a resolution your TV cannot support (for example, 1080p), you may not see a picture on your TV.	<ul style="list-style-type: none"> <li>Press and hold the <b>■</b> button on front panel for more than 5 seconds with no disc in the product. All settings will revert to the factory settings.</li> </ul>
No HDMI output.	<ul style="list-style-type: none"> <li>Check the connection between the TV and the HDMI jack of the product.</li> <li>Check if your TV supports 576p/480p/720p/1080i/1080p HDMI input resolution.</li> </ul>
Abnormal HDMI output screen.	<ul style="list-style-type: none"> <li>If random noise appears on the screen, it means that TV does not support HDCP (High-bandwidth Digital Content Protection).</li> </ul>
<b>AllShare Play function</b>	
I can see folders shared through AllShare Play, but I cannot see the files.	<ul style="list-style-type: none"> <li>AllShare Play shows only files corresponding to the Photo, Music, and Movie categories. Files that do not correspond to these categories may not be displayed.</li> </ul>
Video is played intermittently.	<ul style="list-style-type: none"> <li>Check if the network is stable.</li> <li>Check if the network cable is properly connected and if the network is not overloaded.</li> </ul>

Symptom	Check/Remedy
The AllShare Play connection between the TV and PC is unstable.	<ul style="list-style-type: none"> <li>IP addresses under the same subnetwork should be unique, otherwise IP collision can results in such a phenomenon.</li> <li>Check if you have a firewall enabled. If so, disable the firewall function.</li> </ul>
<b>BD-LIVE</b>	
I cannot connect to the BD-LIVE server.	<ul style="list-style-type: none"> <li>Test whether the network connection is active by using the Network Status function.</li> <li>Check whether a USB memory device is connected to the product.</li> <li>The memory device must have at least 1GB of free space to accommodate the BD-LIVE service. You can check the available size in BD Data Management. (See page 37)</li> <li>See if the BD-LIVE Internet Connection option is set to Allow(All).</li> <li>If all above fails, contact the contents provider or update to the latest firmware.</li> </ul>
When using the BD-LIVE service, an error occurs.	<ul style="list-style-type: none"> <li>The memory device must have at least 1GB of free space to accommodate the BD-LIVE service. You can check the available size in BD Data Management. (See page 37)</li> </ul>

## | NOTE |

- ▶ When the factory default settings are restored, all stored user BD data will be deleted.



Speaker	Speaker system	5.1ch speaker system			
		Front	Surround	Center	Subwoofer
	Impedance	3 Ω	3 Ω	3 Ω	3 Ω
	Frequency range	140Hz~20kHz	140Hz~20kHz	140Hz~20kHz	40Hz ~ 160Hz
	Output sound pressure level	87dB/W/M	87dB/W/M	87dB/W/M	88dB/W/M
	Rated input	80W	80W	80W	100W
	Maximum input	160W	160W	160W	200W
	Dimensions (W x H x D)	Front/ Surround : 77 x 107 x 68 mm Center : 228 x 77 x 70 mm Subwoofer : 155 x 300 x 285 mm			
	Weights	Front/ Surround :0.4 kg Center : 0.5 kg, Subwoofer : 2.9 kg			

- Samsung Electronics Co., Ltd reserves the right to change the specifications without notice.
- Weight and dimensions are approximate.
- Design and specifications are subject to change without prior notice.
- Network speeds equal to or below 10Mbps are not supported.
- For the power supply and Power Consumption, refer to the label attached to the product.



## Contact SAMSUNG WORLD WIDE

If you have any questions or comments relating to Samsung products, please contact the SAMSUNG customer care center.

Area	Contact Center ☎	Web Site
<b>■ Asia Pacific</b>		
AUSTRALIA	1300 362 603	www.samsung.com
NEW ZEALAND	0800 SAMSUNG (0800 726 786)	www.samsung.com
CHINA	400-810-5858	www.samsung.com
HONG KONG	(852) 3698 4698	www.samsung.com/hk www.samsung.com/hk_en/
INDIA	1800 1100 11 3030 8282 1800 3000 8282 1800 266 8282	www.samsung.com
INDONESIA	0800-112-8888 021-5699-7777	www.samsung.com
MALAYSIA	1800-88-9999	www.samsung.com
PHILIPPINES	1-800-10-SAMSUNG(726-7864) for PLDT 1-800-3-SAMSUNG(726-7864) for Digitel 1-800-8-SAMSUNG(726-7864) for Globe 02-5805777	www.samsung.com
SINGAPORE	1800-SAMSUNG(726-7864)	www.samsung.com
THAILAND	1800-29-3232 02-689-3232	www.samsung.com
TAIWAN	0800-329-999 0266-026-066	www.samsung.com
VIETNAM	1 800 588 889	www.samsung.com
<b>■ Middle East</b>		
U.A.E	800-SAMSUNG (726-7864)	www.samsung.com
OMAN	800-SAMSUNG(726-7864)	www.samsung.com
KUWAIT	183-2255	www.samsung.com
BAHRAIN	8000-4726	www.samsung.com
Egypt	08000-726786	www.samsung.com
JORDAN	800-22273	www.samsung.com
IRAN	021-8255	www.samsung.com
Morocco	080 100 2255	www.samsung.com
Saudi Arabia	9200-21230	www.samsung.com
<b>■ Africa</b>		
NIGERIA	0800-726-7864	www.samsung.com
Ghana	0800-10077 0302-200077	www.samsung.com
Cote D' Ivoire	8000 0077	www.samsung.com
Senegal	800-00-0077	www.samsung.com
CAMEROON	7095- 0077	www.samsung.com
KENYA	0800 724 000	www.samsung.com
UGANDA	0800 300 300	www.samsung.com
TANZANIA	0685 88 99 00	www.samsung.com
SOUTH AFRICA	0860-SAMSUNG(726-7864 )	www.samsung.com



AH68-02442S-00

## Free Manuals Download Website

<http://myh66.com>

<http://usermanuals.us>

<http://www.somanuals.com>

<http://www.4manuals.cc>

<http://www.manual-lib.com>

<http://www.404manual.com>

<http://www.luxmanual.com>

<http://aubethermostatmanual.com>

Golf course search by state

<http://golfingnear.com>

Email search by domain

<http://emailbydomain.com>

Auto manuals search

<http://auto.somanuals.com>

TV manuals search

<http://tv.somanuals.com>