

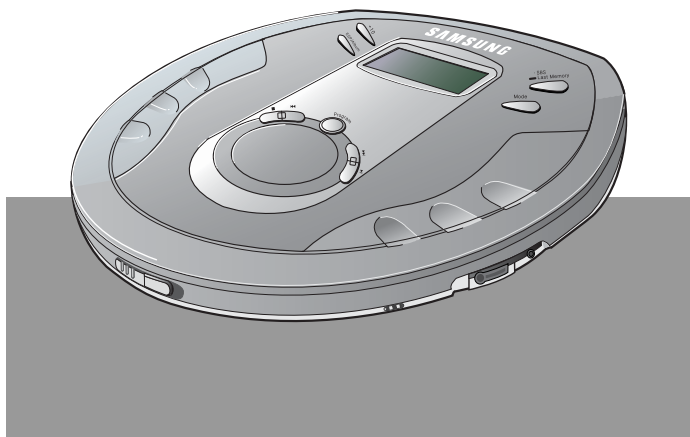

Portable MP3-CD Player
CD-MP3 Portatile
Reproductor Portátil de MP3-CD
MCD-SM45

Instruction Manual
Reproductor Portátil de MP3-CD
Manual de Instrucciones

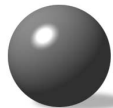



Main Features

SBS function

The SBS function produces rich, deep bass tones for a more powerful overall sound.

Random function

The Random function allows you to play tracks in random order.

Album function

The Album function allows easy browsing and searching of your favorite tunes by album name, song title and artist.

ESP function

The ESP function ensures high resistance to shock or vibration so that the sound signal remains undisturbed (up to 120 seconds for MP3 and 45 seconds for a CD).

Last Memory function

The Last Memory function allows you to listen to a song part way through, and then resume listening again at the point just before where you left off - handy for when you have to answer the phone or door.

What is MP3?

MP3 means MPEG1 Layer 3, the global standard for audio signal compression technology. It uses digital compression technology to compress original sound data by up to 12 times without sound quality degradation.

File Compatibility

- The unit will playback files created in MP3 format (Mpeg1.Layer 3) with *.mp3 as their extension.
- Files created in MP2 format (Mpeg1.Layer2) with *.mp2 as their extension can also be played back.

How many MP3 files can a CD-R or CD-RW disc record?

- The maximum capacity of one CD-R or CD-RW disc is 680MB. Normally, one MP3 file has a capacity of 4MB, therefore approximately 170 files can be recorded on a single disc.

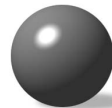

Contents

Safety Warning	3
Buttons and Controls	5
Preparation before using your unit	8
• How to Connect	8
• Using the rechargeable battery (not supplied)	9
• Using standard batteries	10
CD Playback	11
MP3-CD Playback	12
Skip/Search function	13
Mode function	14
SBS/Last Memory function	15
ESP/Album function	16
+10 button	16
Program function	18
• To confirm the program	19
• To change the program	19
• To cancel the program mode	19
Features	20
Maintaining and looking after your unit	21
Troubleshooting Guide	22
Specification	23



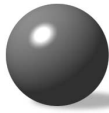

Safety Warning

Take care not to allow dust or other contaminants to come into contact with your CD player.



Do not use your CD player on uneven or unstable surfaces.

- Your CD player may not operate properly in this case.



Do not leave your CD player in direct sunlight or near a heat source.

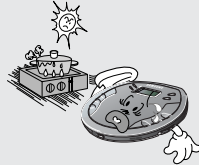

Do not put anything other than a CD (CD-R or CD-RW) inside your CD player.

- Such actions will damage your CD player.



Do not use broken or scratched MP3 CDs.

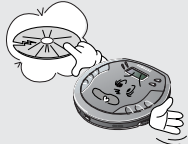

Do not apply heavy pressure to the main unit or remote control unit.



Do not touch the lens with your finger or scratch it.

- Your CD player may not operate properly in this case.



Do not place your CD player in a dusty or humid location.



Do not attempt to take apart, repair or modify your CD player.

- Such actions will damage your CD player.



Earphones

Road safety

- Do not use the earphones while riding a bicycle, driving any kind of motor vehicle or motorcycle.

This is very dangerous and is illegal in certain regions.

It is dangerous to wear earphones at high volume while crossing roads.

In order to protect your hearing

- Do not wear the earphones with the volume set too high. Doctors state that listening to music at high volume for prolonged periods is harmful to hearing.
- If you experience a ringing in your ears, reduce the volume or stop listening.

Warning : Please do not use earphones of other companies besides those of this company.

Environmental information

- All redundant packing material has been omitted, We have done our utmost to make the packaging easily separable into three materials: cardboard(box), polystyrene foam(buffer) and polyethylene(bags, protective foam sheet).
- Your set consists of materials which can be recycled if disassembled by a specialized company. Please observe the local regulations regarding the disposal of packing materials, exhausted batteries and old equipment.



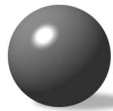

Buttons and Controls

Main Unit

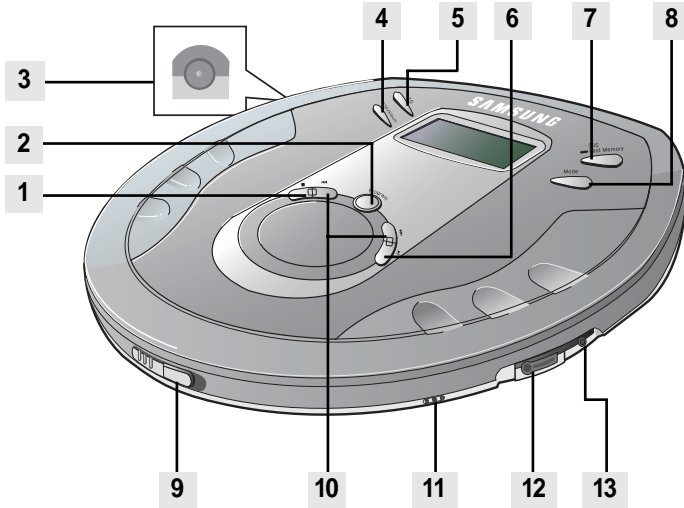

1. STOP button (■)

2. Program button
(Refer to pages 18, 19)

3. Power Input Jack
(Refer to page 8)

4. ESP/Album button
(Refer to pages 16, 17)

5. +10 button
(Refer to page 16)

6. Play/Pause button (▶)

7. SBS / Last Memory button
(Refer to page 15)

8. Mode button
(Refer to page 14)

9. Open switch

10. Skip/Search buttons (⏮ ⏭)
(Refer to page 13)

11. Volume

12. Earphone Connection jack
(Refer to page 8)

13. Line Out output jack
(Refer to page 8)



Bottom of the Main Unit

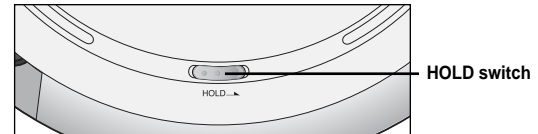

Accessories

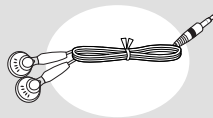

Earphone

Preparation before using your unit

Display

The picture of the display panel below is based on MP3-CD playback.

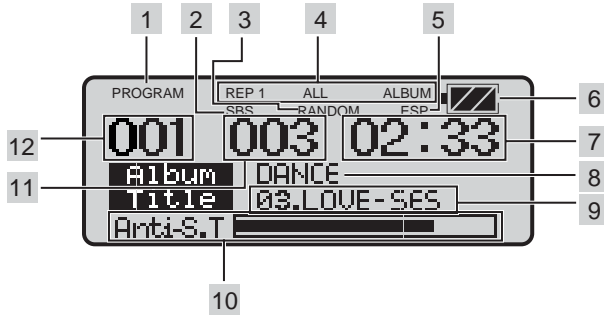

1. PROGRAM indicator

2. SBS Indicator

3. RANDOM indicator

4. REPEAT indicator

5. ESP Indicator

6. Remaining Battery Power indicator

7. Playtime indicator

8. Album Name indicator

9. Title (track title & artist) indicator

10. Anti-S.T (Anti-shock Time)
Buffer Level meter

11. Track Number indicator

12. Album Number indicator

How to Connect

1 Connect the AC adaptor (not supplied) to the power input jack. Then, connect the AC plug of the adaptor to the AC outlet.

- Only use $\ominus \oplus$ 4.5V \approx 500mA (buy it by yourself) with your product.

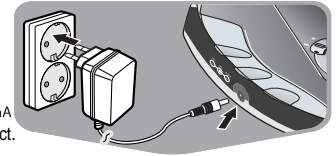

➤ When you are not using this product, disconnect the AC adaptor from the AC outlet.

2 Connect the earphone to the main unit.

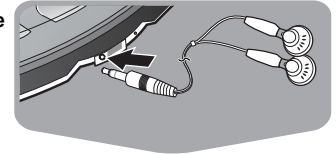

Connection to External Device (if necessary)

* Your CD Player may be connected to the AUX IN jack of an external device.

1. Reduce the volume of the external device.

2. Connect the Line Out jack to the Input jack of the device.

- An external device connection cable (not supplied) may be available. Contact the nearest Samsung Electronics Customer Services.

Preparation before using your unit

GB

Using the rechargeable battery (not supplied)

1 Strip the sheath covering the terminals of the rechargeable battery before charging it.

- As shown in the illustration, with a knife carefully strip the sheath of the negative (-) terminal by 6 mm.

➤ If the sheath is not stripped, charging will not function.

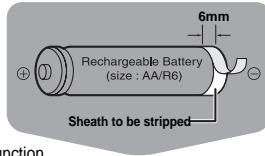

2 Insert the battery into the battery compartment.

- Insert the battery into the battery compartment.

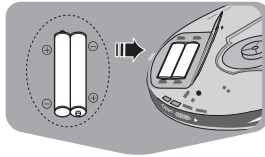

3 Connect the AC adapter (not supplied) to the AC outlet and power input jack.

- Charging of the rechargeable batteries will commence.

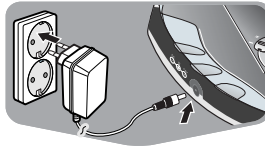

Note

— Ni-MH rechargeable battery (1600mAh)

- Time taken to fully charge the battery : 10 hours
- Battery life of fully charged battery
 - MP3-CD : 10 hours 30 minutes max.
 - CD : 12 hours max.

* Actual charging time may vary according to the type and capacity of the rechargeable batteries.

9

Using standard batteries

1 Open the cover of the battery compartment.

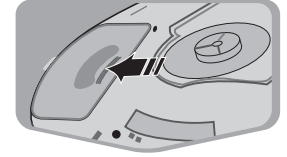

2 Carefully check the correct orientation of the positive and negative terminals of the batteries.

- Use two AA/R6 type 1.5 V batteries.

➤ Use two AA/R6 alkaline batteries. Manganese batteries have a shorter battery life.

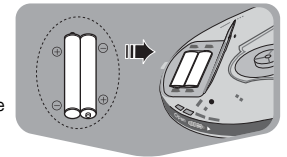

Battery Life (Using alkaline batteries)

- MP3-CD : 13 hours max.
- CD (When ESP is Off) : 16 hours max.
- CD (When ESP is On) : 14 hours 30 minutes max.

Time for Battery Replacement

- Replace the batteries if the remaining battery power indicator " [] " flashes.
- Even though the remaining battery power indicator " [] " may be flashing, if the batteries have already expired, the LCD remote control will not be lit.
- Should " [] " flash, the player will automatically turn off the CD ESP ON mode to conserve battery power consumption.

Warning

- Do not mix old and new batteries.
- Remove the batteries if they will not be used for a long time.
- Remove the standard batteries when you use an AC adapter.

10

CD Playback

- 1 Slide the **OPEN** button to open the door.
Insert a CD.

•Push the door to close it.

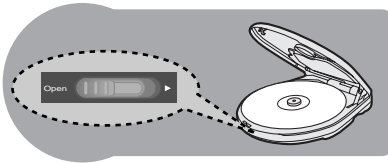

- 2 Press the **Play/Pause** (▶||) button.

•Once the CD is recognized, playback commences.

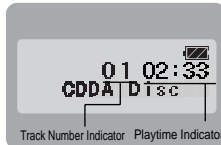
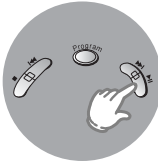

- 3 To stop playback, press the **Stop** (■) button.

•Press Stop (■) button again to switch off the unit.

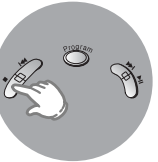

To temporarily pause playback

Press the **Play/Pause** (▶||) button.

- Playback will be temporarily suspended.
- Press the Play/Pause (▶||) button again to resume playback.

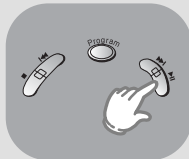

MP3-CD Playback

- 1 Slide the **OPEN** button to open the door, and insert an **MP3-CD**.

• Push the door to close it.

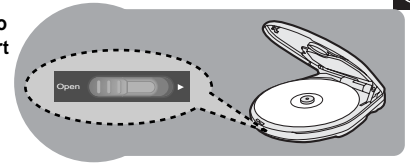

- 2 Press the **Play/Pause** (▶||) button.

•The inserted MP3-CD will be scanned for about 30-90 seconds. Playback will then commence.

➤ Your CD Player will take a few moments to scan through all the tracks recorded on a particular MP3 CD.

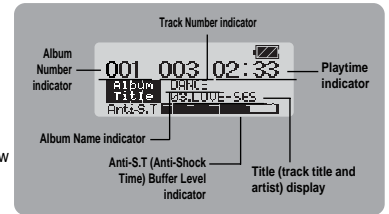

- 3 To stop playback, press the **Stop** (■) button.

•Press Stop (■) button again to switch off the unit.

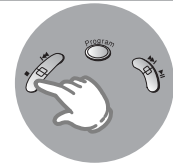

Note •When the OPEN switch is slid to open the door, playback will stop.

Skip/Search function

Skip

Press and release the **◀◀** or **▶▶** button during playback of a CD.

- Press the **▶▶** button to play the next track. Press the **◀◀** button to go back to the beginning of the current track. (Briefly press the **◀◀** button twice to repeat the previous track.)
- Press the **▶▶** button while the unit is in "Stop" (no playback) mode. Track 2 will be played back. Press the **◀◀** button to play back the previous song.

Main Unit

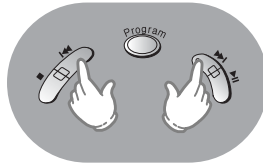

Search

Press and hold the **◀◀** or **▶▶** button during playback of a CD.

- Press and hold the **◀◀** or **▶▶** button. The CD will playback in fast forward or fast reverse mode.
- Release the button to return to normal playback mode.

Hold function

- Any other button pressed during CD playback will not function. (On the display, the "HOLD" indicator will flash.)
- Use the HOLD function when carrying your CD Player around with you. Use of this function will allow you to conserve battery life as it prevents the CD Player from being turned on unintentionally if a button is pressed.

Bottom of the Main Unit



Mode function

Briefly press the Mode button to activate the Repeat function or hold it down for longer to activate the Random function.

Repeat function

Press the Mode button.

- Each time the button is pressed, **REP1**, **REP ALBUM** and **REP ALL** are selected. (REP ALBUM mode only works for MP3-CD disks which contain albums.)

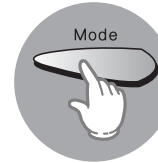

REP1	allows you to repeat the current track.
REP ALBUM (MP3-CD only)	allows you to repeat all tracks in the current album.
REP ALL	allows you to replay the entire CD once it has finished playing.

Random function

Press and hold the Mode button.

- All tracks will be played back in random order.
- To cancel this function, press and hold the button again, or press the STOP (■) button.

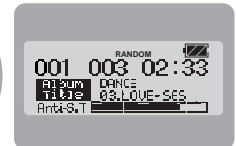
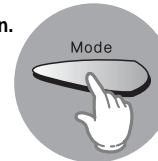

SBS/Last Memory function

Briefly press the **Last Memory/SBS** button to activate the SBS function or hold it longer to activate the Last Memory function.

SBS (Super Bass Sound) function

This function allows you to maximise your listening enjoyment with dynamic reproduction of low-pitched sounds such as beating drums or galloping horses.

Press the SBS button.

- Each time the SBS button is pressed, SBS will be turned on and off alternately.

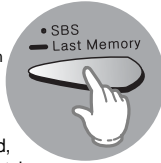

Last Memory function

*This function is only available during playback of an MP3-CD.

When MP3-CD playback is selected again after your CD player has been stopped or turned off, this function allows playback from the start of the track that you last listened to.

- Press and hold the Last Memory button. Each time the button is pressed and held, the selection switches between "On Last.M" and "Off Last.M".



ESP/Album function

ESP (Electronic Skip Protection) function

ESP prevents the music being interrupted by vibration and shock.

Press the ESP/Album button.

- **CD Playback:** Press the ESP/Album button to turn this function on and off. (During playback of an MP3-CD, ESP will always be active whether or not the ESP/Album button is pressed.)

- The player buffers up to 120 seconds of MP3 and 45 seconds of audio CD data; hence even if the data flow is interrupted, data is read from memory so that the sound signal remains undisturbed.
- While listening to music, the Anti-S.T (Anti-Shock Time) Buffer Level is automatically saved.



+10 button

Main Unit Press the +10 button.

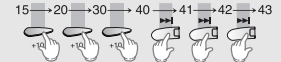

- Press the +10 button briefly while playing back a CD. Playback will skip 10 tracks.

Example : If you want to select track 43 during playback of track 15, press the +10 button three times, and then press the ►►I button three times.

- **MP3-CD playback :** Press and hold the ESP/Albm button longer to select "Album Off". The button is now enabled as the +10 button.

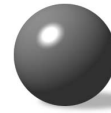

Program function

You can store up to 30 tracks of your favorite tunes.

Album Function

Main Unit

Press the ESP/Album button.

•It moves to the next album.

Example) Pressing the ESP/Album button during playback of the first album will take you to the start of the first track of the second album.



- This player is equipped with a graphic LCD that supports the English language.
- Tag information is displayed for those files containing them. Otherwise, the file name is displayed.
- When writing your own MP3-CDs, we recommend using English for tag information as well as file names.
- Languages other than English will be marked with an asterisk "**".

Press and hold the ESP/Album button for a while.



•Each time the button is pressed, the selection toggles between "On Album" and "Off Album".

•If "Off Album" is selected, the by album playlist changes to the by title playlist.

Note

- This function does not apply to MP3-CDs that have not been created with albums.
- If a file is defective and cannot be recognized, the player skips to the next one, and similarly for all unrecognizable files.

Example: When storing track number 15 to program number 1

1 From Stop mode, press the Program button on the main unit.

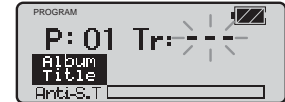

2 Using <<< or >>> or +10 button, select the desired track.



3 Press the Program button.

- Track number 15 is stored under program number 1 and you will be taken to program number 2.
- Continue to program the desired tracks.

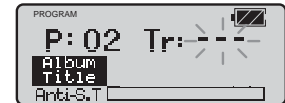

4 Press >>|| (Play/Pause) button when programming is complete.



To stop program playback

- Press the Stop (■) button.
- The total number of programmed tracks as well as the total number of tracks in a given disk will be shown on the display.

Search > Add (Play/Pause) button to resume program playback.

Features

To confirm the program

- From Stop mode, press the Program button.
- Each time the button is pressed, track numbers will be shown on the display according to their program sequence.



To change the program

- To change the programmed tracks during program confirmation, use |◀◀ or ▶▶| to select the track to change.
- Press the Program button to add new tracks.

To cancel the program mode

- Press the Stop (■) button twice. The Program mode will also be canceled if the lid opens during programming.

Warning

- During programming, if no action is performed for about 15 seconds, the player will automatically turn itself off to conserve battery power consumption.

Playback sequence of albums and tracks



- When using Windows Explorer.
- The arrows indicate playback sequence of albums and tracks.
- Albums with .jpg, .wav or .doc are not audio files and therefore will be skipped.

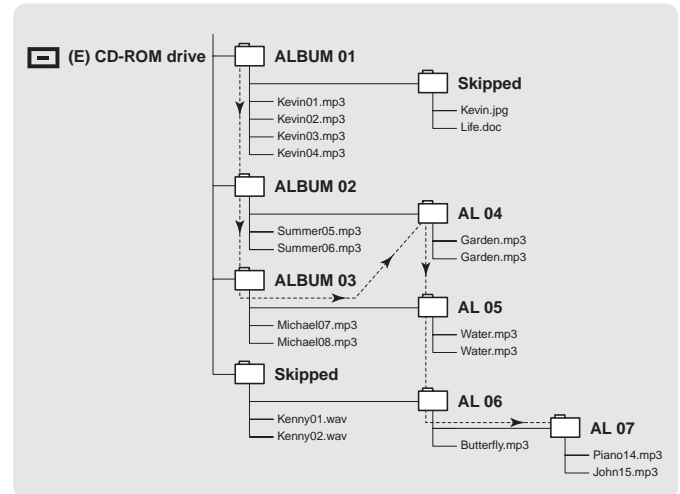

Maintaining and looking after your unit

Looking after your CDs

Wash the disc with a neutral detergent diluted in water, and then wipe gently with a soft dry cloth from the center of the disc to the outside.

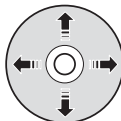

Handling your CDs

Carefully pick up the disc by its edge without touching the disc's surface.



Do not attach stickers to the signal surface (the side with shiny, rainbow colors).

Do not write on the labeled (printed) side with a ballpoint pen or a pencil.



Do not clean this player with record spray or antistatic. Also do not use volatile chemicals such as benzene or thinners.



Troubleshooting Guide

Problem	Check
Unit has no power.	<ul style="list-style-type: none"> ● Did you insert the battery with the correct polarity? ● Is the battery exhausted? ● Is the AC adaptor connected correctly? ● Is the door open?
Playback does not function.	<ul style="list-style-type: none"> ● Is the disc inserted correctly? ● Is the disc damaged or deformed? ● Has the unit been locked with the HOLD switch? ● Has the unit been moved from a cold place to a hot place? Abrupt change of temperature may cause condensation to form on the lens. Keep your CD Player in a warm place until the condensation on the lens has disappeared.
Earphones don't work.	<ul style="list-style-type: none"> ● Is the volume control on the main unit or on the earphones at the minimum setting? ● Are the earphones and the main unit connected correctly?
A sound or track is skipped.	<ul style="list-style-type: none"> ● Was the unit jolted or knocked? ● Are there dust, fingerprints or scratches on the disc?
Some of the MP3 files on a CD are not recognised.	<ul style="list-style-type: none"> ● Check if the unreadable files have .mp3 as their extension on your PC.



Specification

Frequency range	20Hz ~ 20KHz
Signal/noise ratio	85dB
Channel Separation	75dB, 1kHz, 0dB
Total harmonic distortion	0.08%
D/A conversion	1bit 4 OVER SAMPLING
Earphones output	300mV(RMS), 5.5mW/CH
Line out output	290mV(RMS)
Scope of playback supported	Bit Rate : 32~322kbps Sampling frequency : 44.1KHz
DISC Sizes Diameter	120mm, 80mm
Dimensions	130(W) X 29.8(H) X 141.5(D)



File Compatibility

- The unit will playback files created in MP3 format (Mpeg1.Layer 3) with *.mp3 as their extension.
- Files created in MP2 format (Mpeg1.Layer2) with *.mp2 as their extension can also be played back.

How many MP3 files can a CD-R or CD-RW disc record?

- The maximum capacity of one CD-R or CD-RW disc is 650MB.
Normally, one MP3 file has a capacity of 4 MB, therefore approximately 170 files can be recorded on a single disc.

Free Manuals Download Website

<http://myh66.com>

<http://usermanuals.us>

<http://www.somanuals.com>

<http://www.4manuals.cc>

<http://www.manual-lib.com>

<http://www.404manual.com>

<http://www.luxmanual.com>

<http://aubethermostatmanual.com>

Golf course search by state

<http://golfingnear.com>

Email search by domain

<http://emailbydomain.com>

Auto manuals search

<http://auto.somanuals.com>

TV manuals search

<http://tv.somanuals.com>